

Helping Customers Innovate, Improve & Grow



Description

Vectron's VT-803 Temperature Compensated Crystal Oscillator (TCXO) is a quartz stabilized, clipped sine wave or CMOS output, 5th order analog temperature compensated oscillator, operating off a 2.8 to 5.0 volt supply in a hermetically sealed 3.2x5 mm ceramic package.

Features

- Clipped Sine Wave or CMOS Output
- 10.000-52.000 MHz Output
- ± 100 ppb Temperature Stability
- Optional Enable/Disable Function
- Optional VCXO
- Fundamental Crystal Design
- Gold over nickel contact pads
- Hermetically Sealed Ceramic SMD package
- Product is compliant to RoHS directive  and fully compatible with lead free assembly

Applications

- Stratum 3
- SyncE
- 1588
- Femto Cells
- Base Stations
- IP Networking
- GPS
- Point to Point Radio
- Manpack Radio
- Test and Measurement

Block Diagram

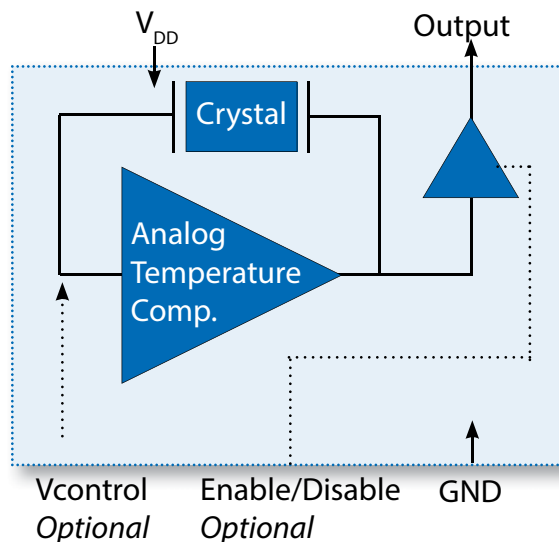

Specifications

Table 1. Electrical Performance, Clipped Sine Wave Option

Parameter	Symbol	Min	Typ	Max	Units
Output Frequency, ¹ <i>Ordering Option</i>	f_o	10		52	MHz
Supply Voltage ² , <i>Ordering Option</i>	V_{DD}	+2.8, +3.0, +3.3, +5.0			V
Supply Current, 10-20.000MHz 20.001-52.000MHz	I_{DD}			2.0 3.4	mA
Operating Temperature, <i>Ordering Option</i>	T_{OP}	-20/70, -40/85			°C
Stability Over Operating Temperature ³ , <i>Ordering Option</i>		$\pm 0.100, \pm 0.200, \pm 0.280, \pm 1.0$			ppm
Initial Accuracy, "No Adjust" Option ⁴				± 1.5	ppm
Power Supply Stability, $\pm 5\%$ change				± 0.05	ppm
Load Stability, $\pm 10\%$ change				± 0.05	ppm
Aging				± 0.5	ppm 1st yr
Stability, temperature and 24 hours ⁵				± 0.37	ppm
Total Stability ⁵				± 4.6	ppm
Pull Range, <i>Ordering Option</i>	PR	$\pm 5, \pm 10$			ppm
Control Voltage to reach Pull Range		0.5		2.5	V
Control Voltage Impedance		100			Kohm
Output Enable/Disable ⁶ , <i>Ordering Option</i>				$0.8 * V_{DD}$	V
Output Enabled	V_{IH}				V
Output Disabled (high impedance output)	V_{IL}	$0.2 * V_{DD}$			V
Output Level	V_o p/p	0.8			V
Output Load				10K 10pF	
Phase Noise, 26.000MHz	ϕ_N				dBc/Hz
10Hz			-91		
100Hz			-117		
1kHz			-136		
10kHz			-150		
100kHz			-158		
Start Up Time	t_{SU}			2	ms

1. The Output is DC coupled.
2. The VT-803 power supply pin should be filtered, eg, a 10uF, 0.1uF and 0.01uf capacitor.
3. Not all stabilities are available over all temperature ranges. Measured at mid Vc for parts with frequency tuning.
4. After 2 IR reflows and 24 hours.
5. $\pm 100, \pm 200$ and ± 280 ppb temp stability parts, all inclusive with 10 years aging.
6. Output is Enabled if E/D is left open.

Outline Drawing

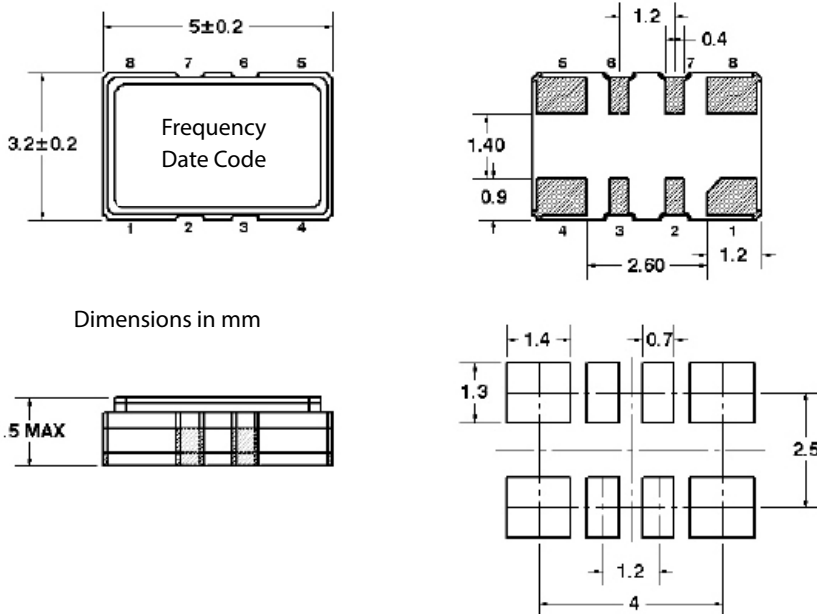

Table 2. Pinout

Pin #	Symbol	Function
1	NC or V_C	No Connection or TCXO Control Voltage
2	NC	Make No Connection
3	NC	Make No Connection
4	GND	Ground
5	OUT	Output
6	NC or E/D	No Connection or Enable/Disable
7	NC	Make No Connection
8	V_{DD}	Supply Voltage

Table 3. Enable Disable Function (optional)

Pin 6	Pin 5 Output
High	Clock Output
Open	Clock Output
Low	High Impedance

Specifications

Table 4. Electrical Performance, CMOS Option					
Parameter		Min	Typ	Max	Units
Output Frequency ¹ , <i>Ordering Option</i>	f_o	10		52	MHz
Supply Voltage ² , <i>Ordering Option</i>	V_{DD}	+2.8, +3.0, +3.3, +5.0			V
Supply Current, 10-24.999MHz 25.000-39.000MHz 40.000- 49.999MHz 50.000- 52.000MHz	I_{DD}			3.0 3.5 5.0 6.0	mA
Operating Temperature, <i>Ordering Option</i>	T_{OP}	-20/70, -40/85			°C
Stability Over Operating Temperature ³ , <i>Ordering Option</i>		±0.100, ±0.200, ±0.280, ±1.0			ppm
Initial Accuracy, "No Adjust" Option ⁴				±1.5	ppm
Power Supply Stability, ±5% change 10MHz-27MHz, 2.8V, 3.0V, and 3.3V >27MHz-52MHz, 2.8V, 3.0V, and 3.3V 10MHz-27MHz, 5V >27MHz-52MHz, 5V		1		±0.10 ±0.20 ±0.20 ±0.30	ppm
Load Stability, ±10% change				±0.10	ppm
Aging				±0.5	ppm 1st yr
Stability, temperature and 24 hours ⁵				±0.37	ppm
Total Stability ⁵				±4.6	ppm
Pull Range, <i>Ordering Option</i>		±5, ±10			ppm
Control Voltage to reach Pull Range		0.5		2.5	V
Control Voltage Impedance		100			Kohm
Output Enable/Disable ⁶ , <i>Ordering Option</i> Output Enabled Output Disabled (high impedance output)	V_{IH} V_{IL}		$0.2 \cdot V_{DD}$	$0.8 \cdot V_{DD}$	V V
Output Level Output Logic High Output Logic Low Output Logic High Drive Output Logic Low Drive	V_{OH} V_{OL}	$0.9 \cdot V_{DD}$ 4		$0.1 \cdot V_{DD}$ -4	V V mA mA
Output Load				15	pF
Phase Noise, 26.000MHz 10Hz 100Hz 1kHz 10kHz 100kHz			-91 -117 -139 -153 -157		dBc/Hz
Period Jitter ⁷ rms peak-peak			2.5 21.0		ps ps
Start Up Time	t_{SU}			2	ms

1. The Output is DC coupled.
2. The VT-803 power supply pin should be filtered, eg, a 10uF, 0.1uF and 0.01uF capacitor.
3. Not all stabilities are available over all temperatures. Measured at mid Vc for parts with frequency tuning
4. After 2 IR reflows and 24 hours.
5. ±100, ±200 and ±280 ppb temp stability parts, all inclusive with 10 years aging.
6. Output is Enabled if E/D is left open.
7. Measured using a Wavecrest SIA3300C, 90K samples.

Warm Up Time

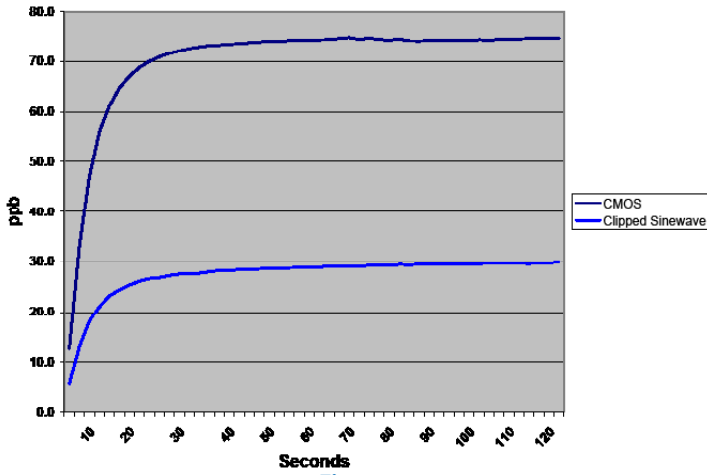

Figure 1

The VT-803 start up time is rated at 2ms. Figure 1 shows the Output Frequency versus time in seconds which shows the output reaching a steady state frequency within 60 seconds.

Frequency versus Vc Over Temperature

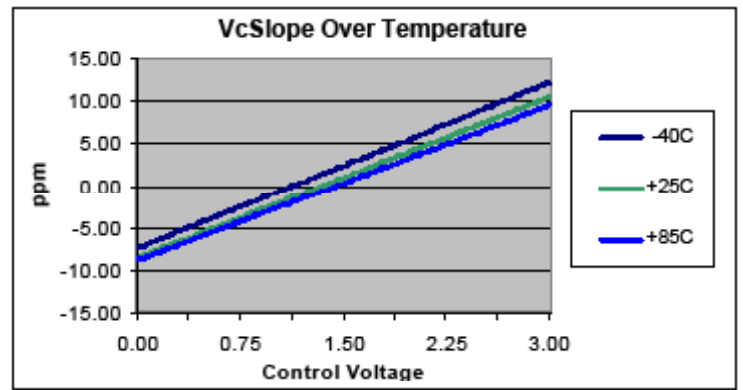

Figure 2

The VT-803 output frequency change versus control voltage is very linear and Figure 2 show the typical performance over temperature.

Allan Deviation, Clipped Sine Wave Output

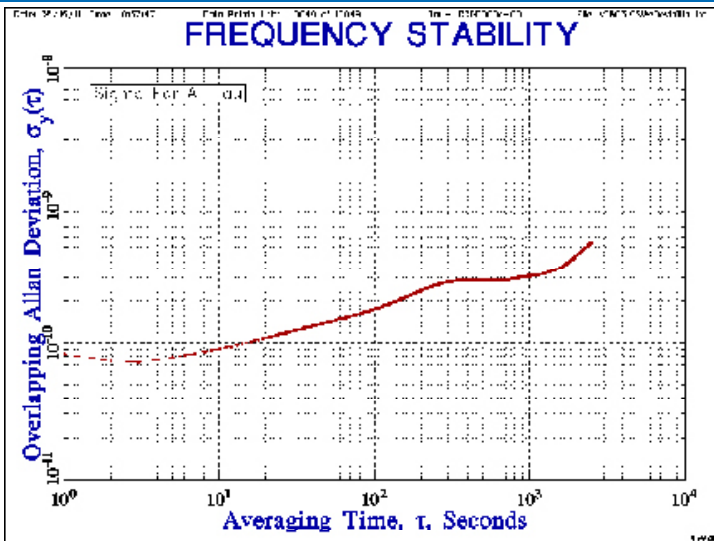

Figure 3

Test Conditions are under room ambient air flow (non insulated conditions).

Allan Deviation, CMOS Output

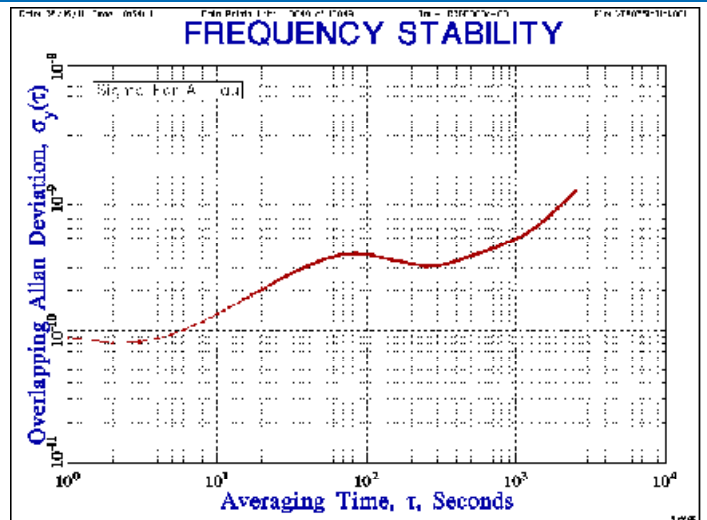

Figure 4

Test Conditions are under room ambient air flow (non insulated conditions).

Aging

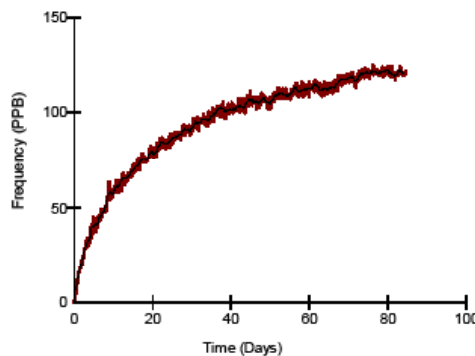
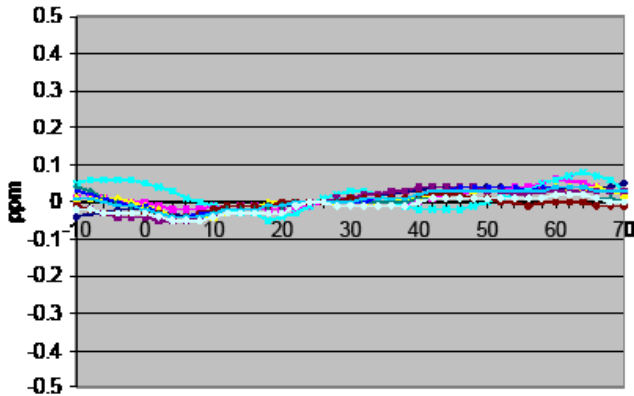

Figure 5

Figure 5 shows an output frequency change of 125ppb typical over 85 days at 85°C which would be equivalent to 125ppb over 2.25 years at 40°C.

Temperature Stability Graph



Temperature °C
Figure 6

Delta Frequency vs. Temperature

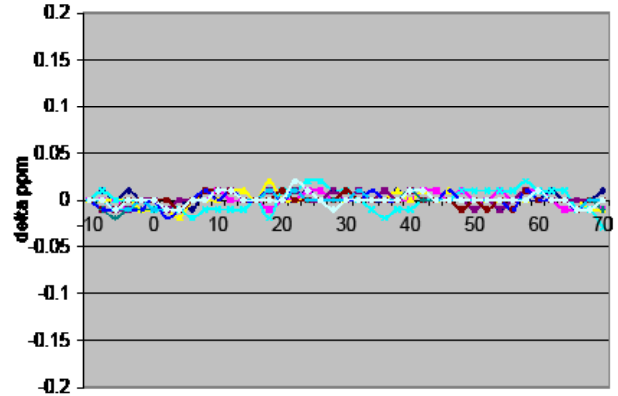

Temperature °C
Figure 7

Figure 7 shows the change in frequency reading between every adjacent 2°C readings.

Phase Noise Performance, Clipped Sine Wave

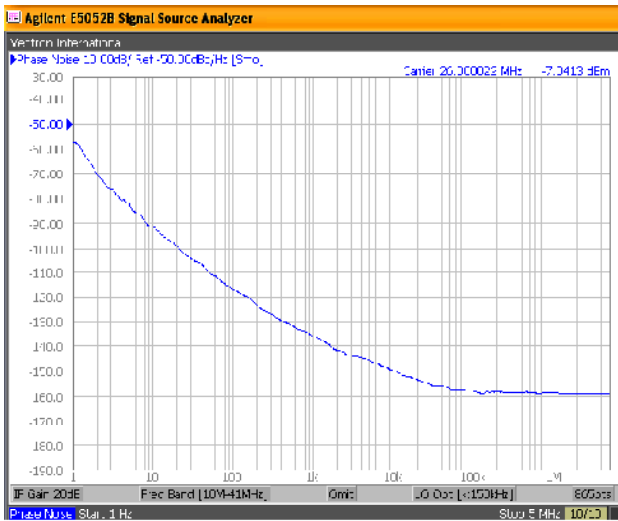

Figure 8

Phase Noise Performance, CMOS

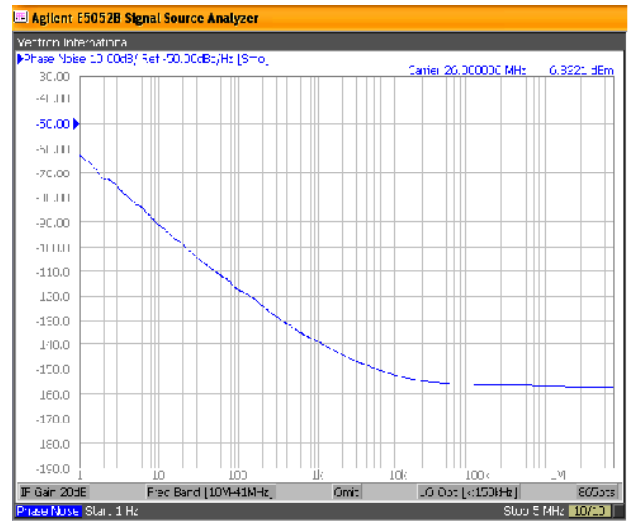

Figure 9

Phase Noise Over Temperature

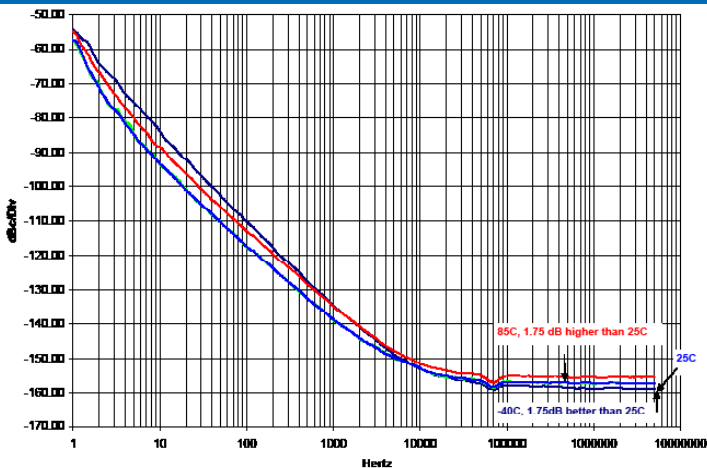

Figure 10

Figure 10 shows the difference in the phase noise at 85°C, 25°C and -40°C.

Phase Noise Over Power Supply Variation

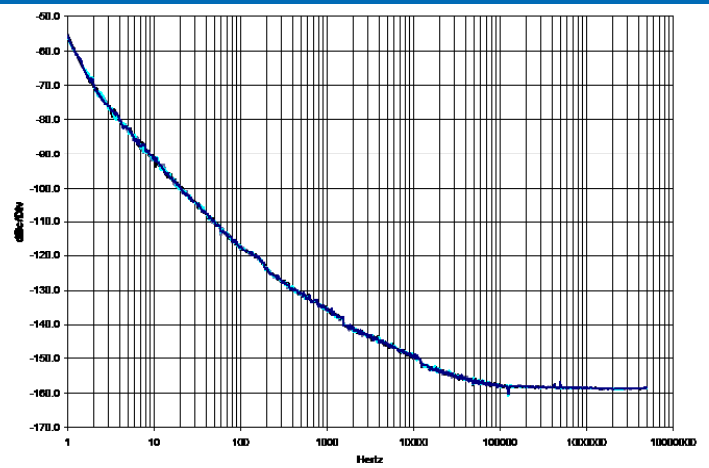

Figure 11

Figure 11 is a phase noise plot at a 2.8, 3.0, 3.3 and 3.6 volt power supply which demonstrates there is no significant change in performance.

VCXO Function

VCXO Feature: The VT-803 is supplied with a VCXO function for applications where it will be used in a PLL, or the output frequency needs fine tune or calibration adjustments. This is a high impedance input, 100 Kohm, and can be driven with an op-amp or terminated with adjustable resistors etc. **Pin 1 should not be left floating on the VCXO optional device.**

Maximum Ratings

Absolute Maximum Ratings and Handling Precautions

Stresses in excess of the absolute maximum ratings can permanently damage the device. Functional operation is not implied or any other excess of conditions represented in the operational sections of this data sheet. Exposure to absolute maximum ratings for extended periods may adversely affect device reliability.

Although ESD protection circuitry has been designed into the VT-803, proper precautions should be taken when handling and mounting, Vectron employs a Human Body Model and Charged Device Model for ESD susceptibility testing and design evaluation. ESD thresholds are dependent on the circuit parameters used to define the model. Although no industry standard has been adopted for the CDM a standard resistance of 1.5kOhms and capacitance of 100pF is widely used and therefore can be used for comparison purposes.

Parameter	Symbol	Rating	Unit
Storage Temperature	T_{STORE}	-55/125	°C
Supply Voltage	V_{DD}	-0.6/6	V
Control Voltage	V_C	-0.6/ V_{DD} +0.6	V
Enable/Disable Voltage	E/D	-0.6/ V_{DD} +0.6	V
ESD, Human Body Model		1500	V
ESD, Charged Device Model		1000	V

Reliability

Parameter	Condition
Mechanical Shock	MIL-STD-883 Method 2002 (1500 G, 0.5 msec)
Mechanical Vibration	MIL-STD-883 Method 2007 (20 G Peak Acceleration)
Temperature Cycle	MIL-STD-883 Method 1010 (-55/85°C)
Solderability	MIL-STD-883 Method 2003 (Lead free solder)
Fine and Gross Leak	MIL-STD-883 Method 1014 (Crystal)
Resistance to Solvents	MIL-STD-883 Method 2015 (IPA solvent)
Moisture Sensitivity Level	MSL1
Termination Finish	Gold (0.3-1.0um) over Nickel
Weight	70 mg
ThetaJC	6 °C/W

Test conditions: ±2.0 ppm change limit.

IR Reflow

Suggested IR Profile

Devices are built using lead free epoxy and can be subjected to standard lead free IR reflow conditions shown in Table 7. Contact pads are gold over nickel and lower maximum temperatures can also be used, such as 220°C.

Table 7 Reflow Profile		
Parameter	Symbol	Value
PreHeat Time Ts-min Ts-max	t_s	200 sec Max 150°C 200°C
Ramp Up	R_{UP}	3°C/sec Max
Time above 217C	t_L	150 sec Max
Time to Peak Temperature	$t_{25C \text{ to peak}}$	480 sec Max
Time at 260C	t_p	30 sec Max
Time at 240C	t_{p2}	60 sec Max
Ramp down	R_{DN}	6°C/sec Max

Solderprofile:

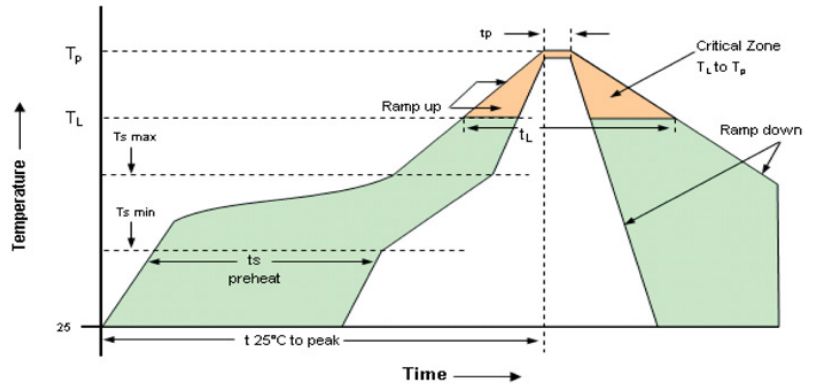

Tape & Reel

Table 8. Tape and Reel Information

Tape Dimensions (mm)						Reel Dimensions (mm)						
W	F	Do	Po	P1	A	B	C	D	N	W1	W2	#/Reel
12	5.5	1.5	4	8	254	2.5	13	21	100	13.5	17.5	2000

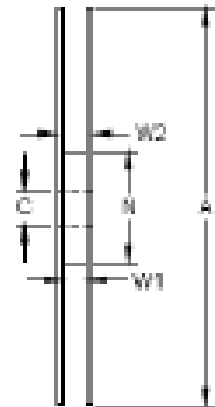
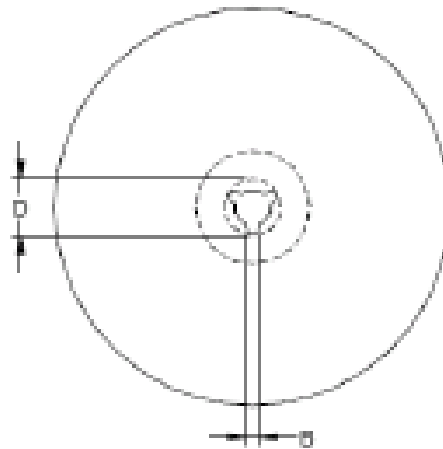
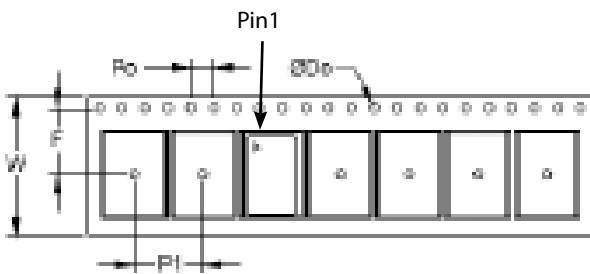

Ordering Information

Table 9. Standard Frequencies (MHz)

10.000	12.800	16.000	16.384	16.800	19.200	19.440	20.000	20.480	24.000
24.576	25.000	26.000	27.000	28.800	29.792	30.000	30.720	31.250	32.000
33.333	36.000	38.400	38.880	39.000	40.000	48.000	49.152	50.000	52.000

VT-803- E A H - 507A- xxMxxxxxxx *

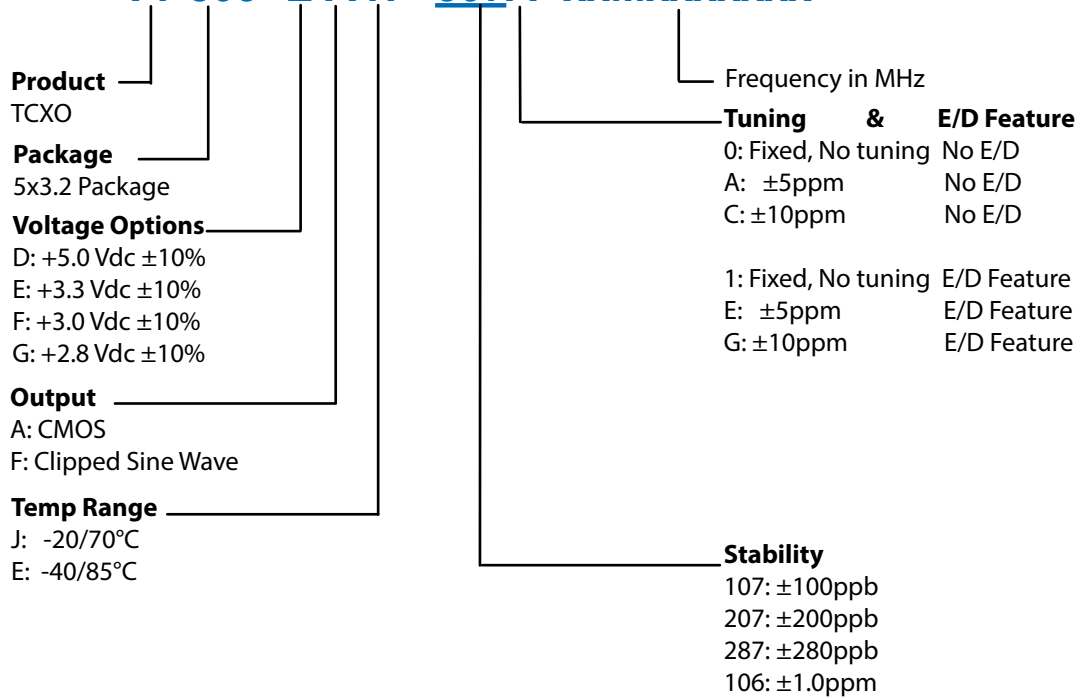

* Add **_SNPB** for tin lead solder dip
Example: VT-803-EAE-2870-40M0000000_**_SNPB**

Revision Date	Description
Nov 4, 2013	Updated product capability chart (Table 9 & 10). Changed VI Asia contact information.
Jan 7, 2014	Added "temperature stability measurement at Mid Vc for parts with frequency tuning option". Removed Delta 1s Frequency Plot.
Feb 18, 2014	Added temp stability measurement condition on parts with Vc feature. Changed Vectron logo and Hudson contact information.
Sep 3, 2014	Modified Package Drawing Orientation, added tuningI slope (positive), red bullet in Capability Chart
June 28, 2018	Add: E/D function, E/D specifications, E/D Table. New Frequencies, Stratum3/SyncE, ±4.6ppm overall stability, ±0.37ppm temperature plus 24 hours (for stabilities ≤ ±280ppb), weight and thetaJC. Updated CMOS load and power supply stability. Update test conditions and clipped sine wave current limit >26MHz to 52MHz. Add new Table 3; Enable/Disable Table. Deleted Capabilities Tables 9 and 10. Add _SNPB DIP ordering option and example. Change Vectron logo to Microsemi/Microchip.
May 24, 2019	Update logo, contact information and ordering options.

Contact Information

USA:

100 Watts Street
Mt Holly Springs, PA 17065
Tel: 1.717.486.3411
Fax: 1.717.486.5920

Europe:

Landstrasse
74924 Neckarbischofsheim
Germany
Tel: +49 (0) 7268.801.0
Fax: +49 (0) 7268.801.281



Information contained in this publication regarding device applications and the like is provided only for your convenience and may be superseded by updates. It is your responsibility to ensure that your application meets with your specifications. MICROCHIP MAKES NO REPRESENTATION OR WARRANTIES OF ANY KIND WHETHER EXPRESS OR IMPLIED, WRITTEN OR ORAL, STATUTORY OR OTHERWISE, RELATED TO THE INFORMATION INCLUDING, BUT NOT LIMITED TO ITS CONDITION, QUALITY, PERFORMANCE, MERCHANTABILITY OR FITNESS FOR PURPOSE. Microchip disclaims all liability arising from this information and its use. Use of Microchip devices in life support and/or safety applications is entirely at the buyer's risk, and the buyer agrees to defend, indemnify and hold harmless Microchip from any and all damages, claims, suits, or expenses resulting from such use. No licenses are conveyed, implicitly, or otherwise, under any Microchip intellectual property rights unless otherwise stated.

Trademarks

The Microchip and Vectron names and logos are registered trademarks of Microchip Technology Incorporated in the U.S.A. and other countries.

Данный компонент на территории Российской Федерации

Вы можете приобрести в компании MosChip.

Для оперативного оформления запроса Вам необходимо перейти по данной ссылке:

<http://moschip.ru/get-element>

Вы можете разместить у нас заказ для любого Вашего проекта, будь то серийное производство или разработка единичного прибора.

В нашем ассортименте представлены ведущие мировые производители активных и пассивных электронных компонентов.

Нашей специализацией является поставка электронной компонентной базы двойного назначения, продукции таких производителей как XILINX, Intel (ex.ALTERA), Vicor, Microchip, Texas Instruments, Analog Devices, Mini-Circuits, Amphenol, Glenair.

Сотрудничество с глобальными дистрибьюторами электронных компонентов, предоставляет возможность заказывать и получать с международных складов практически любой перечень компонентов в оптимальные для Вас сроки.

На всех этапах разработки и производства наши партнеры могут получить квалифицированную поддержку опытных инженеров.

Система менеджмента качества компании отвечает требованиям в соответствии с ГОСТ Р ИСО 9001, ГОСТ РВ 0015-002 и ЭС РД 009

Офис по работе с юридическими лицами:

105318, г.Москва, ул.Щербаковская д.3, офис 1107, 1118, ДЦ «Щербаковский»

Телефон: +7 495 668-12-70 (многоканальный)

Факс: +7 495 668-12-70 (доб.304)

E-mail: info@moschip.ru

Skype отдела продаж:

moschip.ru

moschip.ru_4

moschip.ru_6

moschip.ru_9