



Micro Commercial Components

Micro Commercial Components
20736 Marilla Street Chatsworth
CA 91311
Phone: (818) 701-4933
Fax: (818) 701-4939

2N7002

N-Channel MOSFET

Features

- Halogen free available upon request by adding suffix "-HF"
- Epoxy meets UL 94 V-0 flammability rating
- Moisture Sensitivity Level 1
- Advanced Trench Process Technology
- High Input Impedance
- High Speed Switching
- CMOS Logic Compatible Input
- Marking : 7002/S72

Maximum Ratings @ 25°C Unless Otherwise Specified

Symbol	Rating	Rating	Unit
V _{DS}	Drain-source Voltage	60	V
I _D	Drain Current	115	mA
P _D	Total Power Dissipation	200	mW
R _{θJA}	Thermal Resistance Junction to Ambient	625	°C/W
T _J	Operating Junction Temperature	-55 to +150	°C
T _{STG}	Storage Temperature	-55 to +150	°C

Electrical Characteristics @ 25°C Unless Otherwise Specified

Symbol	Parameter	Min	Typ	Max	Units
V _{(BR)DSS}	Drain-Source Breakdown Voltage (V _{GS} =0Vdc, I _D =10μAdc)	60	---	---	Vdc
V _{th(GS)}	Gate-Threshold Voltage (V _{DS} =V _{GS} , I _D =250μAdc)	1.0	---	2.5	Vdc
I _{GSS}	Gate-body Leakage (V _{DS} =0Vdc, V _{GS} =±20Vdc)	---	---	±100	nAdc
I _{DSS}	Zero Gate Voltage Drain Current (V _{DS} =60Vdc, V _{GS} =0Vdc) (V _{DS} =60Vdc, V _{GS} =0Vdc, T _J =125°C)	---	---	1 500	μAdc
I _{D(ON)}	On-state Drain Current (V _{DS} =7.5Vdc, V _{GS} =10Vdc)	500	2700	---	mAdc
r _{DS(on)}	Drain-Source On-Resistance (V _{GS} =10Vdc, I _D =500mAdc) (V _{GS} =5Vdc, I _D =50mAdc)	---	1.2 1.7	7.5 7.5	Ω
V _{DS(on)}	Drain-Source On-Voltage (V _{GS} =10Vdc, I _D =500mAdc) (V _{GS} =5Vdc, I _D =50mAdc)	---	---	3.75 1.5	Vdc
G _{FS}	Forward Transconductance (V _{DS} =10Vdc, I _D =200mAdc)	80	---	---	ms
V _{SD}	Diode Forward Voltage (V _{GS} =0Vdc, I _S =115mAdc)	---	---	1.5	Vdc
I _S	Maximum Continuous Drain-Source Diode Forward Current	-	---	115	mA
C _{iss}	Input Capacitance	---	---	50	pF
C _{oss}	Output Capacitance	---	---	25	
C _{rss}	Reverse Transfer Capacitance	---	---	5	

Switching

t _{d(on)}	Turn-on Time	V _{DD} =30Vdc, V _{GEN} =10Vdc	---	---	20	ns
t _{d(off)}	Turn-off Time	R _L =150Ω, I _D =200mA, R _{GEN} =25Ω	---	---	20	

SOT-23

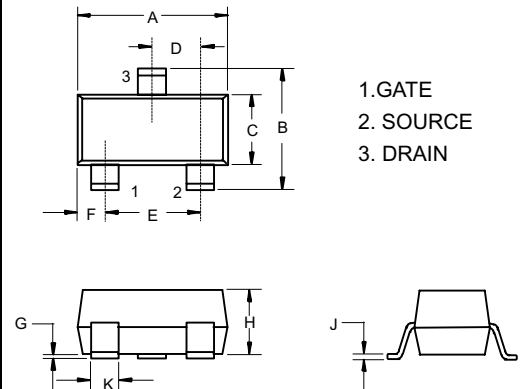

DIM	INCHES		MM		NOTE
	MIN	MAX	MIN	MAX	
A	.110	.120	2.80	3.04	
B	.083	.104	2.10	2.64	
C	.047	.055	1.20	1.40	
D	.035	.041	.89	1.03	
E	.070	.081	1.78	2.05	
F	.018	.024	.45	.60	
G	.0005	.0039	.013	.100	
H	.035	.044	.89	1.12	
J	.003	.007	.085	.180	
K	.015	.020	.37	.51	

Suggested Solder Pad Layout

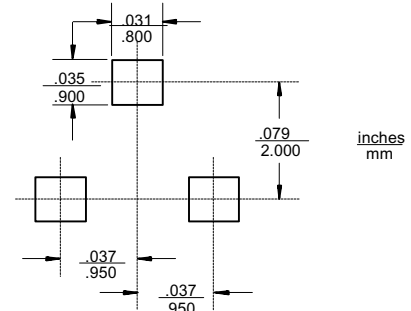

Fig. 1 – On-Resistance vs. Gate-to-Source Voltage

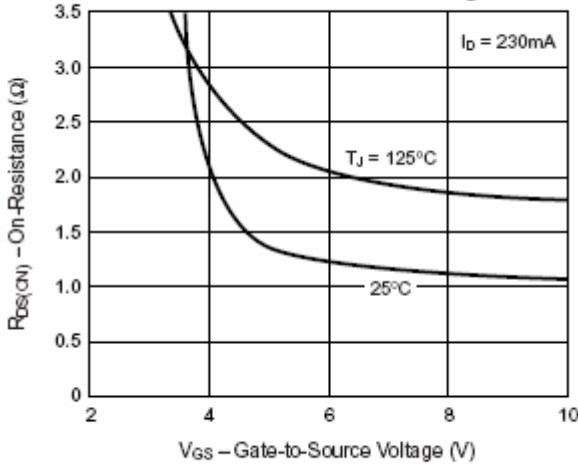

Fig. 2 – Source-Drain Diode Forward Voltage

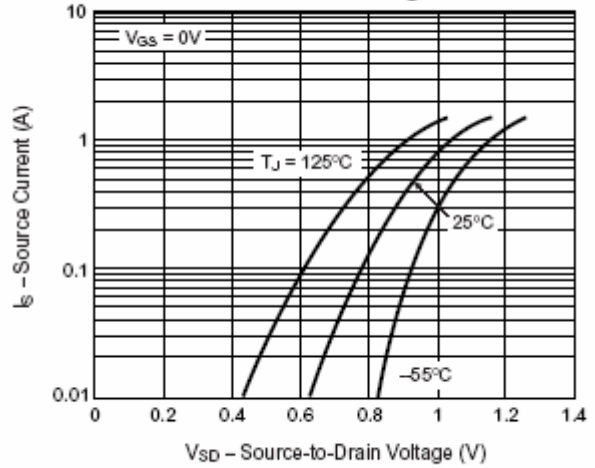

Fig. 3 – Output Characteristics

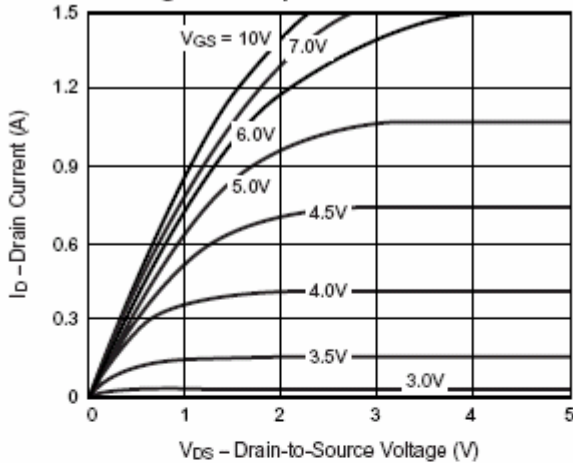

Fig. 4 – Transfer Characteristics

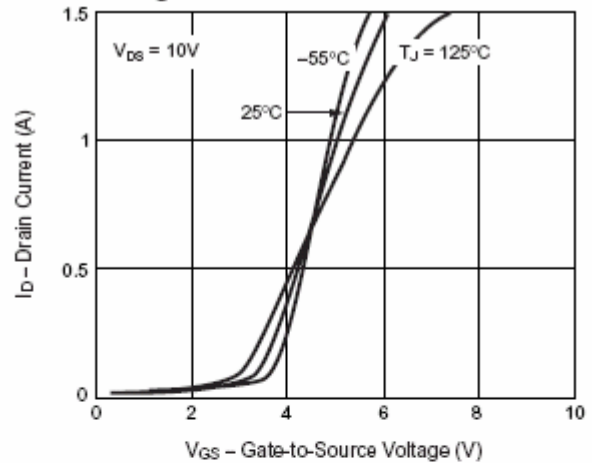

Fig. 5 – Capacitance

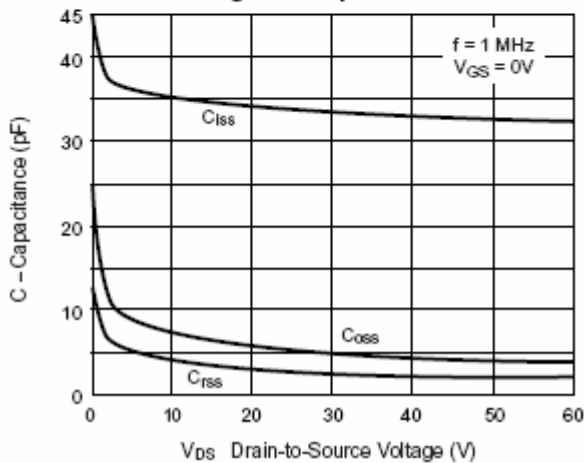
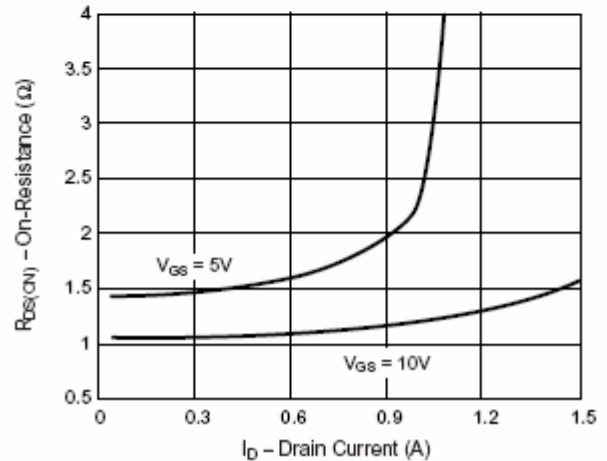

Fig. 6 – On-Resistance vs. Drain Current



2N7002

Fig. 7 – Gate Charge

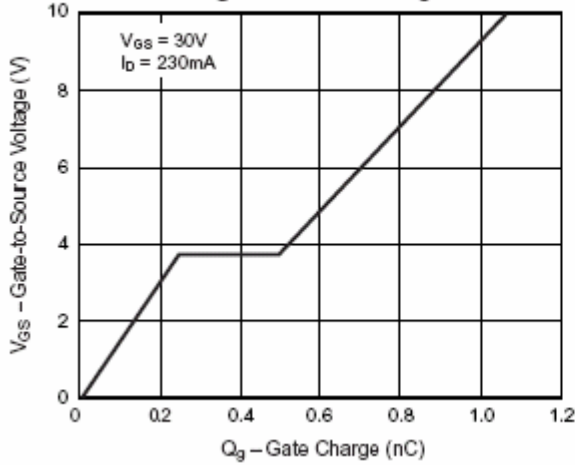

Fig. 8 – Breakdown Voltage vs. Junction Temperature

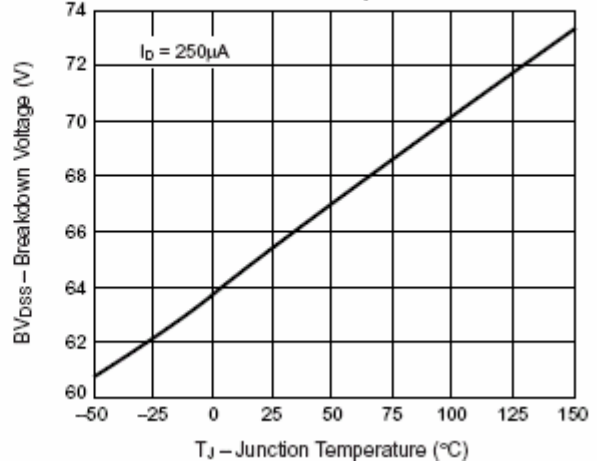

Fig. 9 – Threshold Voltage

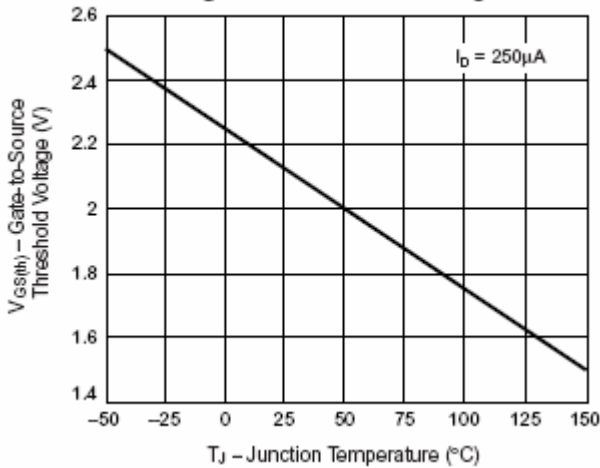

Fig. 10 – On-Resistance vs. Junction Temperature

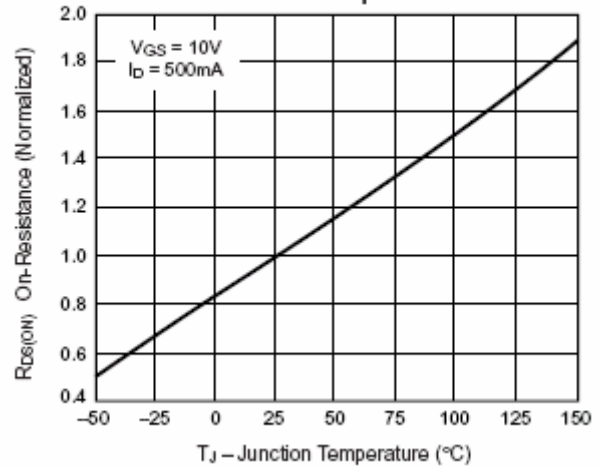

Fig. 11 – Thermal Impedance

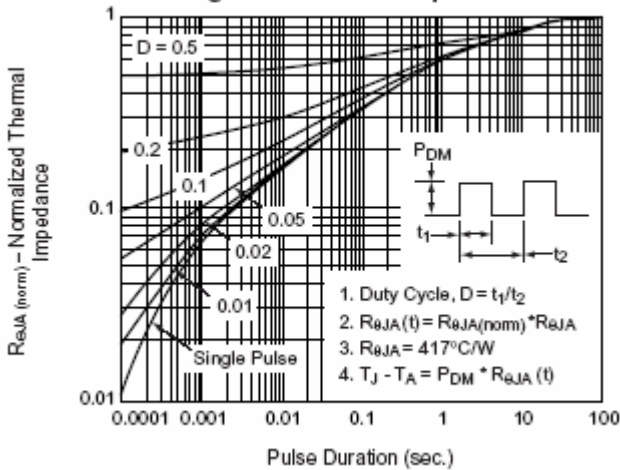
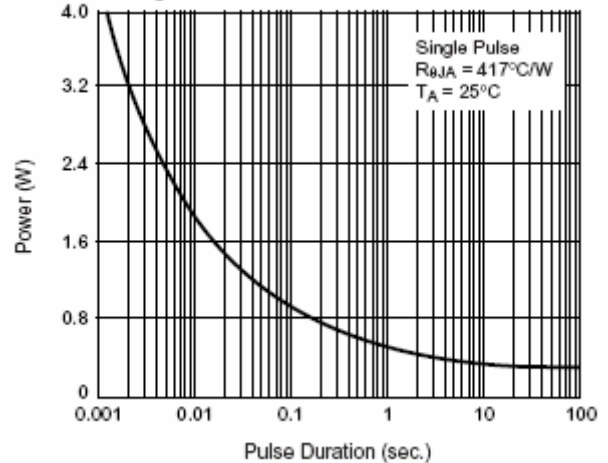
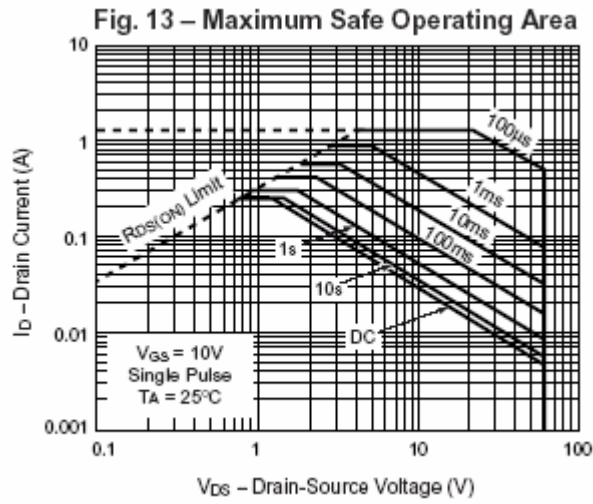

Fig. 12 – Power vs. Pulse Duration







Micro Commercial Components

Ordering Information :

Device	Packing
Part Number-TP	Tape&Reel: 3Kpcs/Reel

Note : Adding "-HF" suffix for halogen free, eg. Part Number-TP-HF

IMPORTANT NOTICE

Micro Commercial Components Corp. reserves the right to make changes without further notice to any product herein to make corrections, modifications , enhancements , improvements , or other changes . **Micro Commercial Components Corp .** does not assume any liability arising out of the application or use of any product described herein; neither does it convey any license under its patent rights ,nor the rights of others . The user of products in such applications shall assume all risks of such use and will agree to hold **Micro Commercial Components Corp .** and all the companies whose products are represented on our website, harmless against all damages.

LIFE SUPPORT

MCC's products are not authorized for use as critical components in life support devices or systems without the express written approval of Micro Commercial Components Corporation.

CUSTOMER AWARENESS

Counterfeiting of semiconductor parts is a growing problem in the industry. Micro Commercial Components (MCC) is taking strong measures to protect ourselves and our customers from the proliferation of counterfeit parts. MCC strongly encourages customers to purchase MCC parts either directly from MCC or from Authorized MCC Distributors who are listed by country on our web page cited below. Products customers buy either from MCC directly or from Authorized MCC Distributors are genuine parts, have full traceability, meet MCC's quality standards for handling and storage. **MCC will not provide any warranty coverage or other assistance for parts bought from Unauthorized Sources.** MCC is committed to combat this global problem and encourage our customers to do their part in stopping this practice by buying direct or from authorized distributors.

Данный компонент на территории Российской Федерации

Вы можете приобрести в компании MosChip.

Для оперативного оформления запроса Вам необходимо перейти по данной ссылке:

<http://moschip.ru/get-element>

Вы можете разместить у нас заказ для любого Вашего проекта, будь то серийное производство или разработка единичного прибора.

В нашем ассортименте представлены ведущие мировые производители активных и пассивных электронных компонентов.

Нашей специализацией является поставка электронной компонентной базы двойного назначения, продукции таких производителей как XILINX, Intel (ex.ALTERA), Vicor, Microchip, Texas Instruments, Analog Devices, Mini-Circuits, Amphenol, Glenair.

Сотрудничество с глобальными дистрибьюторами электронных компонентов, предоставляет возможность заказывать и получать с международных складов практически любой перечень компонентов в оптимальные для Вас сроки.

На всех этапах разработки и производства наши партнеры могут получить квалифицированную поддержку опытных инженеров.

Система менеджмента качества компании отвечает требованиям в соответствии с ГОСТ Р ИСО 9001, ГОСТ РВ 0015-002 и ЭС РД 009

Офис по работе с юридическими лицами:

105318, г.Москва, ул.Щербаковская д.3, офис 1107, 1118, ДЦ «Щербаковский»

Телефон: +7 495 668-12-70 (многоканальный)

Факс: +7 495 668-12-70 (доб.304)

E-mail: info@moschip.ru

Skype отдела продаж:

moschip.ru

moschip.ru_4

moschip.ru_6

moschip.ru_9