

DESCRIPTION

UM2100 Series PIN diodes are designed for transmit/receive switch and attenuator applications in HF band (2-30MHz) and below. As series configured switches, these long lifetime (25µs typical) diodes can control up to 2.5 kW, CW in a 50 ohm system. In HF band, insertion loss is less than 0.25dB and isolation is greater than 32dB (off-state).

The UM2100 series offers the lowest distortion performance in both transmit and receive modes. Less than 50 mA forward bias is required to obtain an IP3 of 60 dBm at 300 kHz with 1 watt per tone. The forward biased resistance/reactance vs. frequency characteristics are flat down to 10 kHz. The capacitance vs. reverse bias voltage characteristic is flat down to 2 MHz. In attenuator configuration, the UM2100 produces extremely low distortion at low values of attenuator control current, and very low insertion loss (0.2dB) in the "0dB" attenuator state.

IMPORTANT: For the most current data, consult our website: www.MICROSEMI.com

KEY FEATURES

- HF band (2-30 MHz) PIN
- Long Lifetime (25µs typical)
- High Power (1kW, CW)
- High Isolation (32dB)
- Low Loss (0.25dB)
- Very Low Distortion (IP3=60dBm)
- Voltage ratings to 1000 V
- RoHS compliant packaging Available¹ (use UMX2101B, etc.)

ABSOLUTE MAXIMUM RATINGS AT 25° C
(UNLESS OTHERWISE SPECIFIED)

Package	Conditions	(P _D) Power Dissipation (W)	(Θ) Thermal Resistance (°C/W)
A	25 °C Pin Temperature	25	50V
B	½ in. total length to 25 °C Contact Free Air	12	12.5
E		2.5	
C	25 °C Stud Temperature	25	6
D	25 °C Stud Temperature	18.75	8
SM	25 °C End Cap Temperature	15	10
ALL	1 us pulse (Single)	100KW	
ALL	Storage Temperature (T _{OP})	-65 °C to + 175 °C	
ALL	Operating Temperature (T _{OP})	-65 °C to + 175 °C	

¹ The UM2100 series of products can be supplied with a RoHS compliant finish (UMX2100) or with a 90/10 Sn/Pb finish. Consult factory for details.

APPLICATIONS/BENEFITS

- Isolated stud package available
- Surface mount package available
- Soldering temperature: 260 °C for 10 seconds maximum

VOLTAGE RATINGS

@ 25°C (unless otherwise specified)

Part Number	Reverse Voltage @ 10uA (V)
UM2101	100
UM2102	200
UM2104	400
UM2106	600
UM2108	800
UM2110	1000

ELECTRICAL PARAMETERS @ 25°C (unless otherwise specified)

Parameter	Symbol	Conditions	MIN.	TYPICAL	MAX.	Units
Total Capacitance	C_T	$V_R=100V, F=1\text{ MHz}$		1.9	2.5	pF
Series Resistance	R_S	$I_F = 100\text{ mA}, F=2\text{ MHz}$		1.0	2.0	Ohms
Carrier Lifetime	T_L	$I_F = 10\text{ mA}/100\text{ V}$	20	25		μs
Reverse Current	I_R	$V_R = \text{Voltage rating}$			10	μA
Intermodulation Distortion	IP3	$P=2W\text{ total}, I_F=25\text{ mA}$ $F1 = 1.999\text{ MHz}$ $F2 = 2.001\text{ MHz}$ 1.0 W/tone	50	60		dBm

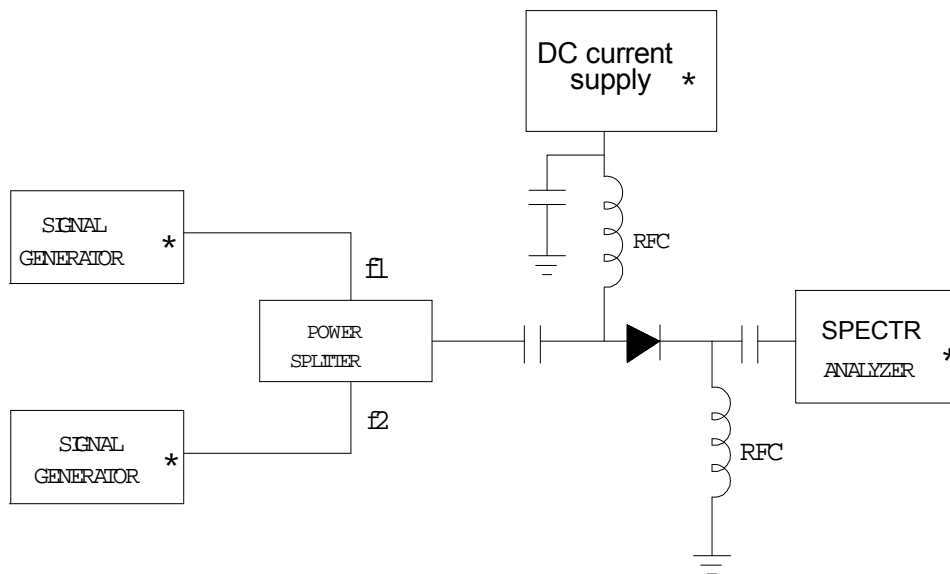
Intermodulation Distortion Test Circuit

* May be controlled with the IEEE-488 bus circuit.

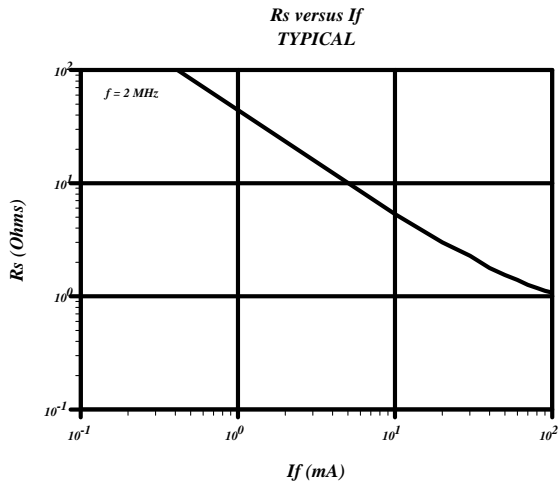
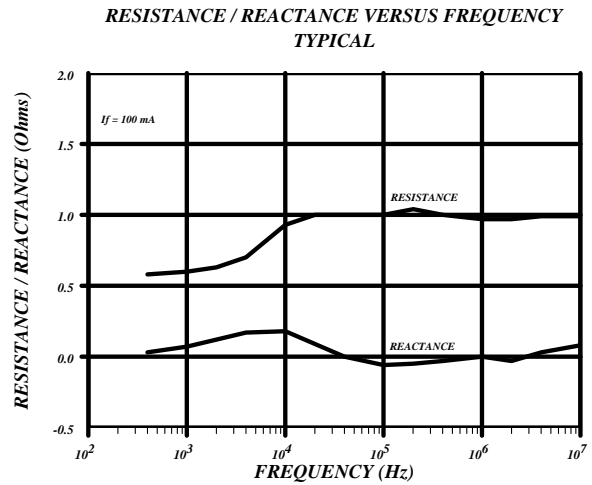
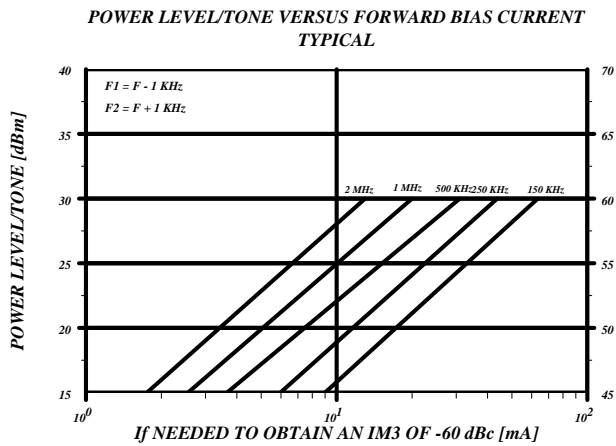
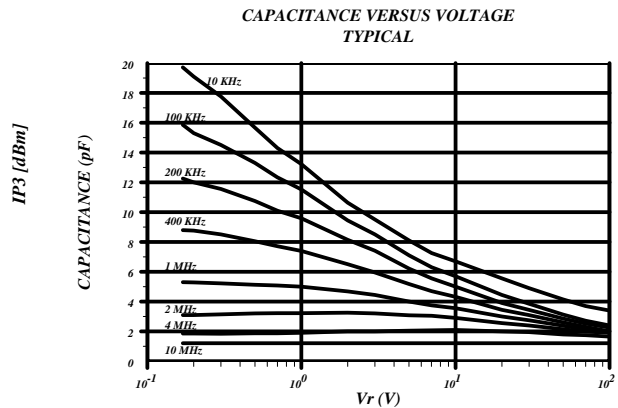
TYPICAL RS VS IF

TYPICAL RS / REACTANCE VS FREQ

POWER/TONE VS IF

CAPACITANCE VS VOLTAGE

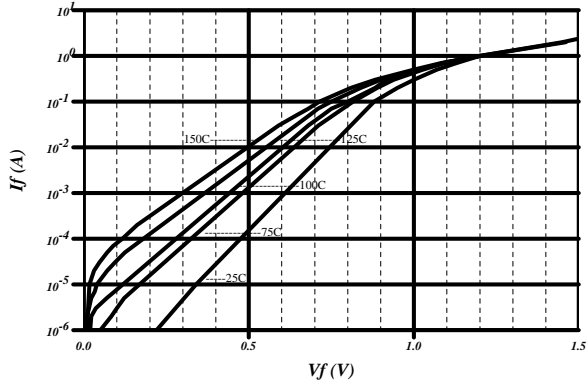

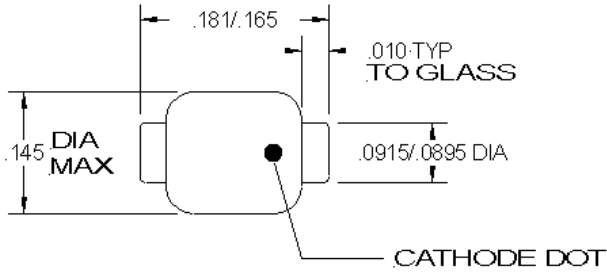
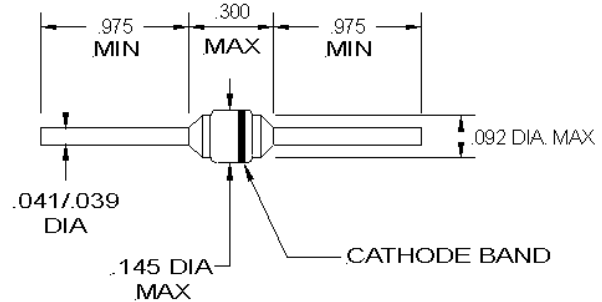
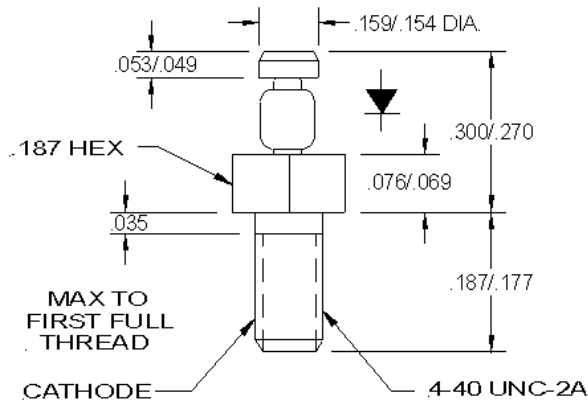
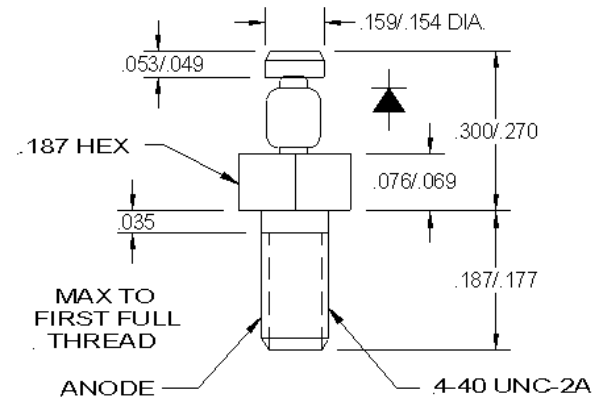
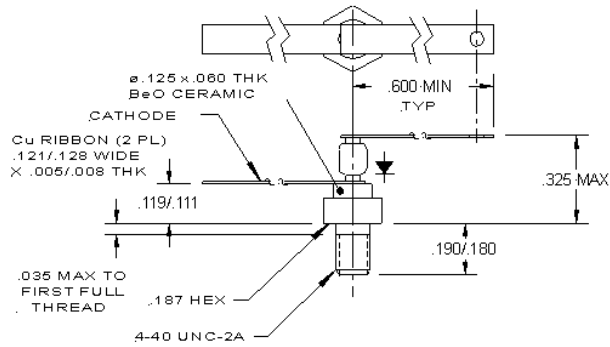
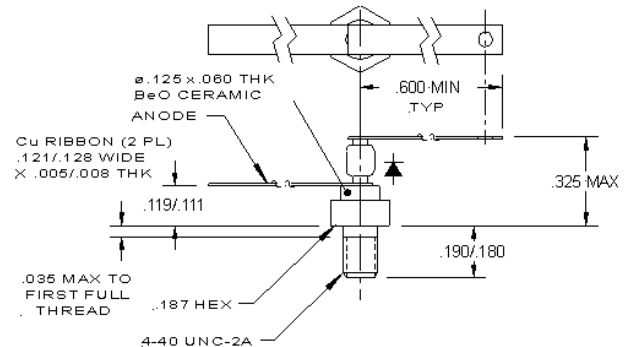
I/V VS TEMP

MEAN I_f VERSUS V_f CURVE VERSUS TEMPERATURE
TYPICAL

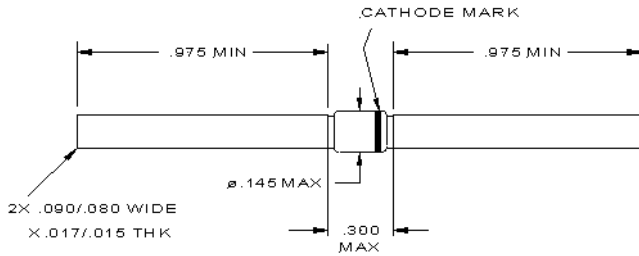
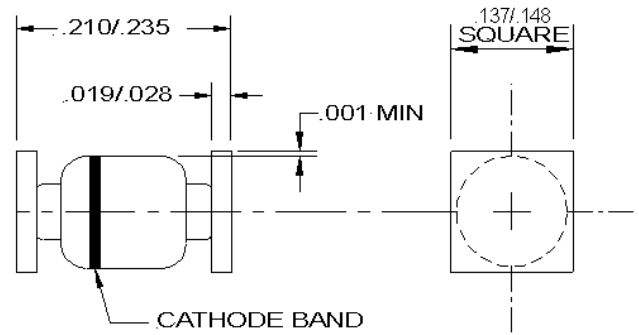
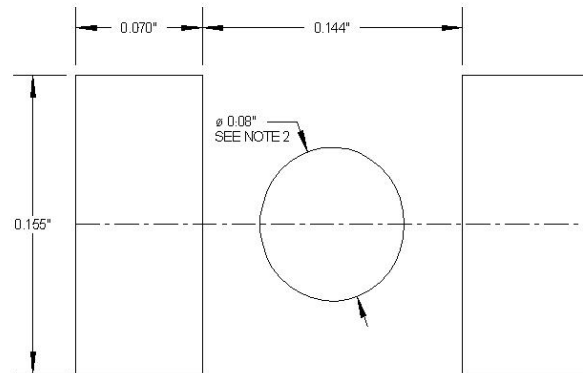

PACKAGE STYLE 'A'

PACKAGE STYLE 'B'

PACKAGE STYLE 'C'

PACKAGE STYLE 'CR'

PACKAGE STYLE 'D'

PACKAGE STYLE 'DR'

PACKAGE STYLE 'E'

PACKAGE STYLE 'SM'

STYLE 'SM' FOOTPRINT

B SIZE
(STANDARD LARGE
SQUARE END CAP OUTLINE)

NOTES:

- 1: THESE DIMENSIONS WILL MATCH THE TERMINALS AND PROVIDE FOR ADDITIONAL SOLDER FILLETS AT THE OUTBOARD ENDS AT LEAST AS WIDE AS THE TERMINALS THEMSELVES, ASSUMING ACCURACY OF DEVICE PLACEMENT WITHIN 0.005".
- 2: IF THE MOUNTING METHOD CHOSEN REQUIRES USE OF AN ADHESIVE SEPARATE FROM THE SOLDER COMPOUND, A ROUND (OR SQUARE) SPOT OF CEMENT AS SHOWN SHOULD BE CENTRALLY LOCATED.

NOTES:

- 1 These dimensions will match the terminals and provide for additional solder fillets at the outboard ends at least as wide as the terminals themselves, assuming accuracy of placement within 0.005"
- 2 If the mounting method chosen requires use of an adhesive separate from the solder compound, a round (or square) spot of cement as shown should be centrally located.

Mouser Electronics

Authorized Distributor

Click to View Pricing, Inventory, Delivery & Lifecycle Information:

[Microchip:](#)

[UM2101SM](#) [UM2102A](#) [UM2102D](#) [UM2106A](#) [UM2106SM](#) [UM2104A](#) [UM2106B](#) [UM2106D](#)

Данный компонент на территории Российской Федерации

Вы можете приобрести в компании MosChip.

Для оперативного оформления запроса Вам необходимо перейти по данной ссылке:

<http://moschip.ru/get-element>

Вы можете разместить у нас заказ для любого Вашего проекта, будь то серийное производство или разработка единичного прибора.

В нашем ассортименте представлены ведущие мировые производители активных и пассивных электронных компонентов.

Нашей специализацией является поставка электронной компонентной базы двойного назначения, продукции таких производителей как XILINX, Intel (ex.ALTERA), Vicor, Microchip, Texas Instruments, Analog Devices, Mini-Circuits, Amphenol, Glenair.

Сотрудничество с глобальными дистрибьюторами электронных компонентов, предоставляет возможность заказывать и получать с международных складов практически любой перечень компонентов в оптимальные для Вас сроки.

На всех этапах разработки и производства наши партнеры могут получить квалифицированную поддержку опытных инженеров.

Система менеджмента качества компании отвечает требованиям в соответствии с ГОСТ Р ИСО 9001, ГОСТ РВ 0015-002 и ЭС РД 009

Офис по работе с юридическими лицами:

105318, г.Москва, ул.Щербаковская д.3, офис 1107, 1118, ДЦ «Щербаковский»

Телефон: +7 495 668-12-70 (многоканальный)

Факс: +7 495 668-12-70 (доб.304)

E-mail: info@moschip.ru

Skype отдела продаж:

moschip.ru

moschip.ru_4

moschip.ru_6

moschip.ru_9