

### Product Overview

The QPB8888 is a video receiver integrated circuit (IC) which provides a low noise analog interface to optical access triplexer modules used in single family ONTs in fiber to the premise (FTTP) applications. The QPB8888 exhibits low input noise and distortion to meet critical FTTP link requirements. QPB8888, with recommended external control circuitry, provides automatic gain control to maintain a constant +19 to +23 dBmV/channel output to insure consistent video quality. It runs on a single +12 V supply eliminating the need for an extra ONT supply.

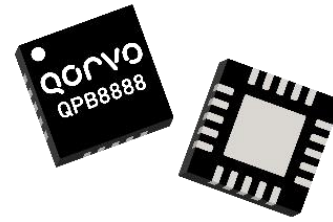

20 Pad 4.0 x 4.0 x 0.85 mm QFN Package

### Functional Block Diagram

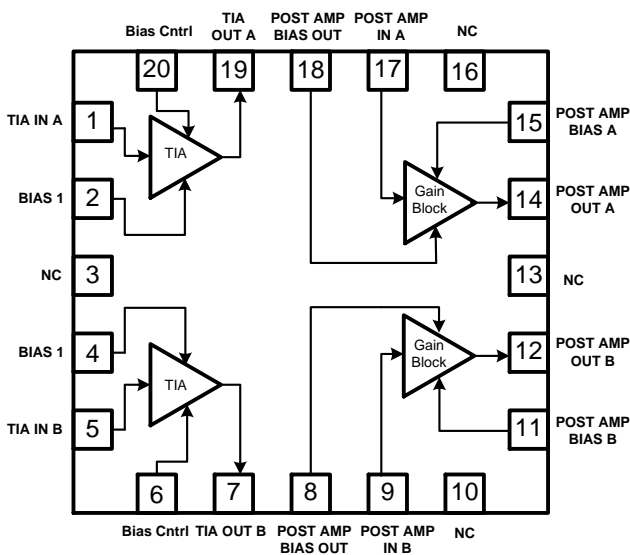

Top View

### Key Features

- +12 V Single Supply Operation
- +5 V Configuration Optional
- Efficient Power Consumption: 1.5 W for +12 V
- Low Noise: 3.5 pA /  $\sqrt{\text{Hz}}$  Equivalent Input Noise Current (EINC)
- Linearity: -65 dBc CSO and -66 dBc CTB at +22 dBmV RF Output per Channel (79-NTSC Equivalent Channels)
- 45 – 1218 MHz Operational Bandwidth
- 27 dB AGC Range with Recommended External Control Circuitry
- Best-in-Class +22 dBmV per Channel RF Output Capability

### Applications

- xPON RF Overlay Video Receiver for FTTP Triplexer-Equipped Optical Network Termination (ONT) and RFoG Network Interface Unit (NIU)

### Ordering Information

Part No.	Description
QPB8888SQ	Sample Bag with 25 Pieces
QPB8888SR	7" Reel with 100 Pieces
QPB8888TR13	13" Reel with 2500 Pieces
QPB8888PCK-2	12V Transformer Coupled EVB Output with 5 Piece Sample Bag
QPB8888PCK-4	5V Transformer Coupled EVB Output with 5 Piece Sample Bag

## Absolute Maximum Ratings

Parameter	Rating
Supply Voltage (V <sub>DD</sub> )	+15 V
Storage Temperature Range	-40 to +150 °C

Exceeding any one or a combination of the Absolute Maximum Rating conditions may cause permanent damage to the device. Extended application of Absolute Maximum Rating conditions to the device may reduce device reliability.

## Recommended Operating Conditions

Parameter	Min	Typ	Max	Units
Operating Temperature	-40		+85	°C
Junction Temperature			+160	°C
RF Power Supply Voltage	+11.4	+12	+12.6	V

Electrical specifications are measured at specified test conditions. Specifications are not guaranteed over all recommended operating conditions.

## Electrical Specifications

Parameter	Condition <sup>(1)</sup>	Min	Typ	Max	Unit
Supply Current (I <sub>SS</sub> )	Steady state operation, current draw during attenuation state transitions is higher.		130		mA
Frequency Range		45		1218	MHz
Gain			37.5		dB
Gain Flatness			1.5		dB
Tilt	Linear tilt from 45 – 1218 MHz; higher tilt can be achieved by changing components		3		dB
Equivalent Input Noise			3.5		pA / √Hz
RF Output Level at 547.25 MHz	RF Output Level at 547.25 MHz		22		dBmV/ch
	At 45 MHz		-17		dB
Output Return Loss	At 600 MHz		-18		dB
	At 1218 MHz		-15		dB
CSO	79-NTSC Equivalent analog channels, +2 dBm optical input OMI = 2.82%/ch; RF <sub>OUT</sub> = +22 dBmV per channel at 547.25 MHz (measured with complete evaluation board circuit in operation including PD and external AGC circuit)		-65		dBc
CTB			-66		dBc
Gain Control Range	Using suggested application circuit		27		dB
Thermal Resistance	T <sub>REF</sub> taken at +85 °C from backside of PCB under the QPB8888		45.4		°C / W

Notes:

1. Typical performance at these conditions: Temp. = +25 °C, V<sub>DD</sub> = +12 V, 75Ω system

## Optical Input Requirements

Parameter	Unit	Min	Typical	Max
Optical Input Power	dBm	-10		2
Optical Modulation Index (OMI)	%/ch (79ch)		3	
Triplexer 1550 nm PIN Responsivity	mA/mW		0.95	
Triplexer 1550 nm PIN Capacitance	pF		0.5	

Typical Application Schematic – 4001

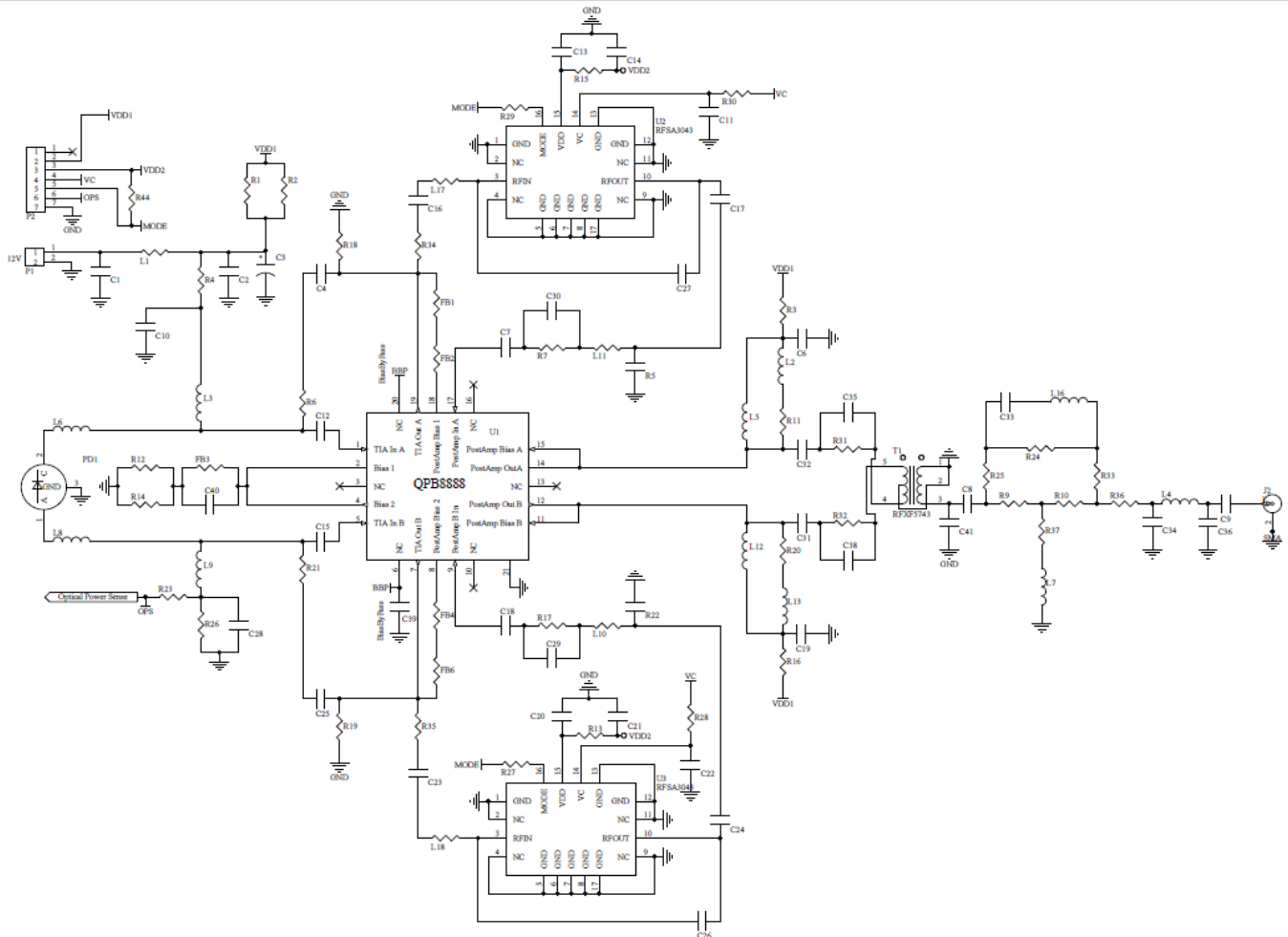



**QPB8888**  
**xPON Video Receiver**

Reference Designator	Description	Manufacturer	Manufacturer Part #
U1	Optical TIA		QPB8888
U2, U3	CATV Voltage Controlled Attenuator	Qorvo	RFSA3043
PCB	PCB, QPB8888	Viasystems Technologies Corp	QPB8888-4001(A)
PD1	InGaAs Photodiode	Beijing SWT Optical Comm. Technology Company, LTD	1096964
C34	CAP, 0.5 pF ROHS, 0402	Johanson Technology	500R07S0R5AV4T
C41	Cap0402 1pF ROHS	Johanson Technology	500R07S1R0AV4T
C36	CAP, 1.3pF, +/-0.1pF, 50V, C0G, 0402	Murata Electronics, Singapore	GRM1555C1H1R3BA01D
C29, C30	CAP, 6.8pF, +/-0.1 pF, 50 V, C0G, 0402	Murata Electronics, Singapore	GRM1555C1H6R8BA01D
C40	CAP, 5.6 pF, +/-0.25 pF, 50 V, HI-Q, 0402	Murata Electronics, Singapore	GJM1555C1H5R6CB01D
C7, C18	CAP, 82 pF, 5%, 50 V, C0G, 0402	Murata Electronics, Singapore	GRM1555C1H820JA01D
C9, C13, C16, C17, C20, C23, C24	CAP, 1000 pF, 10%, 50 V, X7R, 0402	Murata Electronics, Singapore	GRM155R71H102KA01D
C4, C6, C10, C19, C25, C28, C39	CAP, 10000 pF, 10%, 25 V, X7R, 0402	Murata Electronics, Singapore	GRM155R71E103KA01D
C35, C38	CAP, 10 pF, 2.5%, 50 V, C0G, 0402	Murata Electronics, Singapore	GRM1555C1H100RA01D
C1, C2	CAP, 0.1 uF, 10%, 16 V, X7R, 0603	Murata Electronics, Singapore	GRM188R71C104KA01D
C12, C15	CAP, 120 pF, 5%, 50 V, C0G, 0402	Murata Electronics, Singapore	GRM1555C1H121JA01D
C8	CAP, 180 pF, 5%, 50 V, C0G, 0402	Murata Electronics, Singapore	GRM1555C1H181JA01D
C3	CAP, 10 uF, 10%, 16 V, TANT-B	AVX/Kyocera Asia LTD	TAJB106K016RNJ
C14, C21	CAP, 1 uF, 10%, 10 V, X5R, 0402	Murata Electronics, Singapore	GRM155R61A105KE15D
C31, C32	CAP, 470 pF, 5%, 50 V, C0G, 0402	Murata Electronics, Singapore	GRM1555C1H471JA01D
C26, C27	CAP, 0.1 pF, +/-0.05 pF, 50 V, HI-Q, 0402	Murata Electronics, Singapore	GJM1555C1HR10WB01D
C33	CAP, 3.3 pF, +/-0.1 pF, 50 V, NPO, 0402	Murata Electronics, Singapore	GRM1555C1H3R3BA01D
R13, R15	RES, 100 Ω ROHS, 0402	Kamaya, Inc	RMC1/16SK1000FTH
R4, R11, R20	RES, 200 Ω ROHS, 0402	Kamaya, Inc	RMC1/16SK2000FTH
R24	RES, 75 Ω ROHS, 0402	Kamaya, Inc	RMC1/16SK75R0FTH
L10, L11, L17, L18, R25, R33, R34, R35, R36, R44	RES, 0 Ω, 5%, 1/10W, 0402	Kamaya, Inc	RMC1/16SJPTH
R9, R10	RES, 22 Ω, 5%, 1/16W, 0402	Kamaya, Inc	RMC1/16S-220JTH
R23	RES, 10K Ω, 1%, 1/16W, 0402	Panasonic Industrial Devices	ERJ-2RKF1002X
R1, R2	RES, 39 Ω, 1%, 1/4W, 1206	Panasonic Industrial Devices	ERJ-8ENF39R0V
R12, R14	RES, 4.99 Ω, 1%, 1/2W, 1206	Vishay Dale Electronics	CRCW12064R99FKEAHP
R37	RES, 360 Ω, 1%, 1/10W, 0402	Kamaya, Inc	RMC1/16SK3600FTH
R31, R32	RES, 44.2 Ω, 1%, 1/10W, 0402	Kamaya, Inc	RMC1/16SK44R2FTH
R3, R16	RES, 2.49 Ω, 1%, 1/10W, 0402	Kamaya, Inc	RMC1/16SK2R49FTH
R6, R21	RES, 1.6K Ω, 1%, 1/10W, 0402	Kamaya, Inc	RMC1/16SK1601FTH
R26, R27, R28, R29, R30	RES, 1K Ω, 1%, 1/10W, 0402	Kamaya, Inc	RMC1/16SK1001FTH
R7, R17	RES, 36 Ω, 1%, 1/10W, 0402	KOA Speer Electronics	RK73B1ETTP360J
L5, L12	IND, 390 nH, W/W, 0603	Coilcraft, Inc	0603CS-R39XJRW
L4	IND, 9.1 nH, T/F, 0402	Murata Electronics, Singapore	LQP15MN9N1B02D
L2, L13	IND, 68 nH, 5%, M/L, 0402	Murata Electronics, Singapore	LQG15HN68NJ02D
L16	IND, 8.2 nH, +/-0.1 nH, T/F, 0402	Murata Electronics, Singapore	LQP15MN8N2B02D
L7	IND, 68 nH, 5%, W/W, 0402	Coilcraft, Inc	0402CS-68NXJRW
L3, L9	IND, 880 nH, 5%, W/W, 0805	Gowanda Electronics	CC0805-880J-2
L6, L8	IND, 9 nH, 5%, 1.4A, W/W, 0402	Coilcraft, Inc.	0402HP-9N0XJLW
FB1, FB2, FB3, FB4, FB6, L1	FER, BEAD, 1K Ω, 50mA, 0402	Murata Electronics, Singapore	BLM15AG102SN1D
T1	XFMR, 1:3, 5-1200 MHz, 75 Ω, 2W, S20	MiniRF, Inc	RFXF5743
J2	CONN, F FEM EDGE MOUNT, 75 Ω	Millimeter Wave Technologies	MW-846-C-DD-75
P1	CONN, HDR, ST, PLRZD, 2-PIN, 0.100"	ITW Pancon	MPSS100-2-C
P2	CONN, HDR, ST, PLRZD, 7-PIN	ITW Pancon	MPSS100-7-C
R5, R18, R19, R22, C11, C22	NOT POPULATED ITEM-1		

Evaluation Board Assembly Drawing

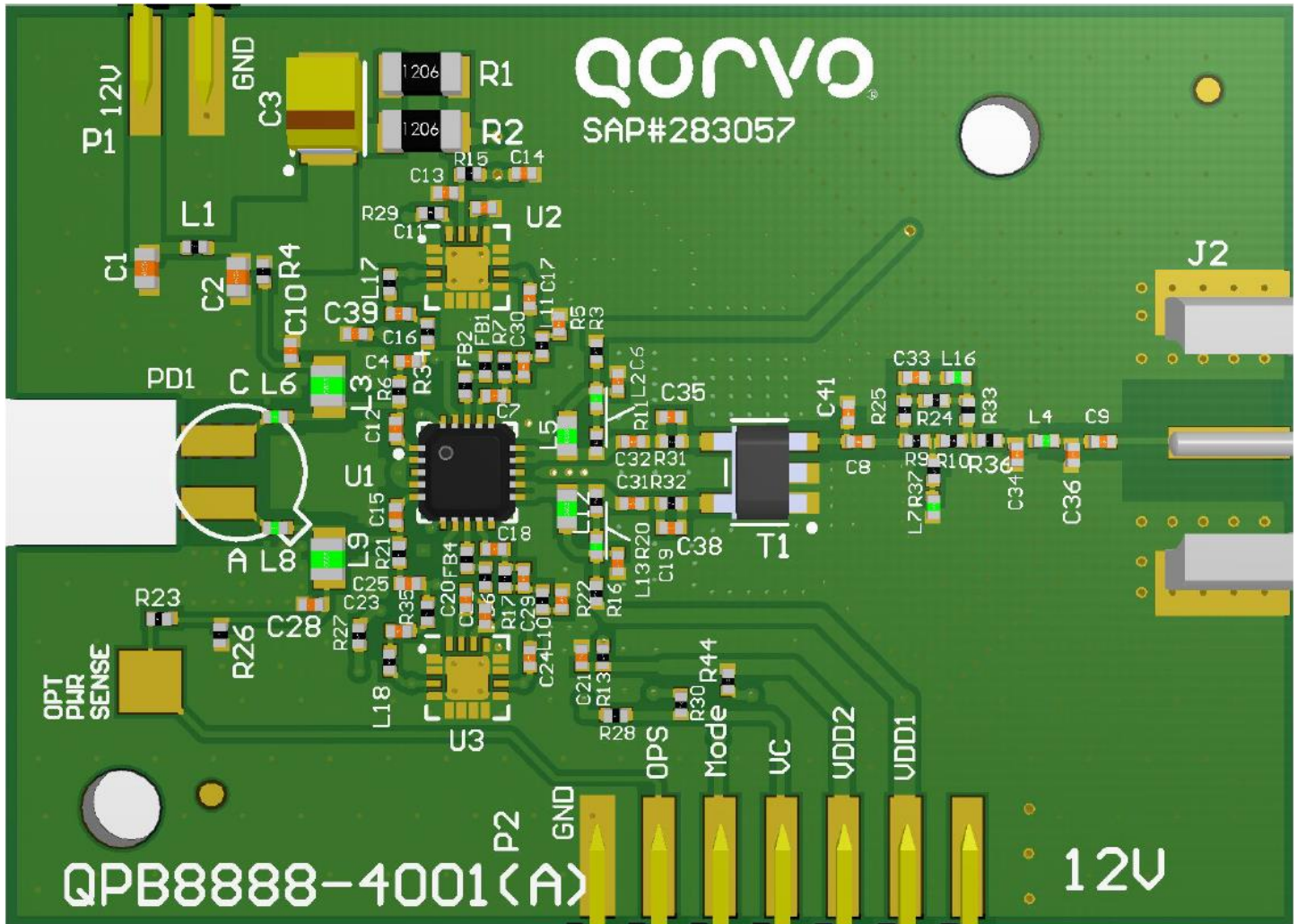

Typical Performance

Test conditions unless otherwise stated: Temp. = +25 °C, V<sub>DD</sub> = +12 V

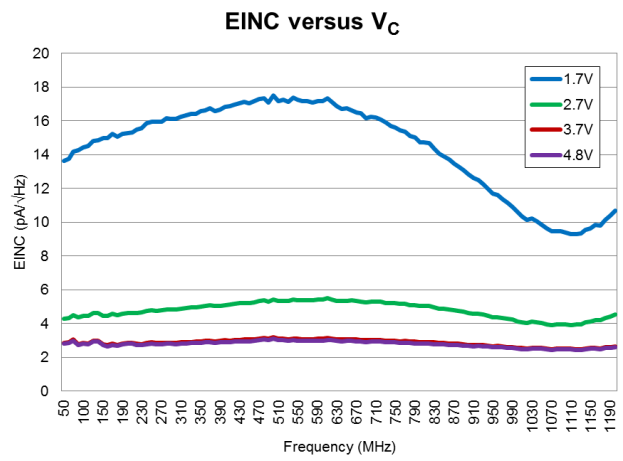
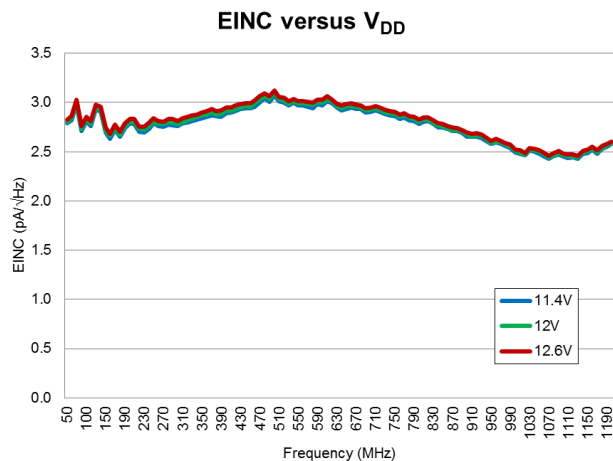
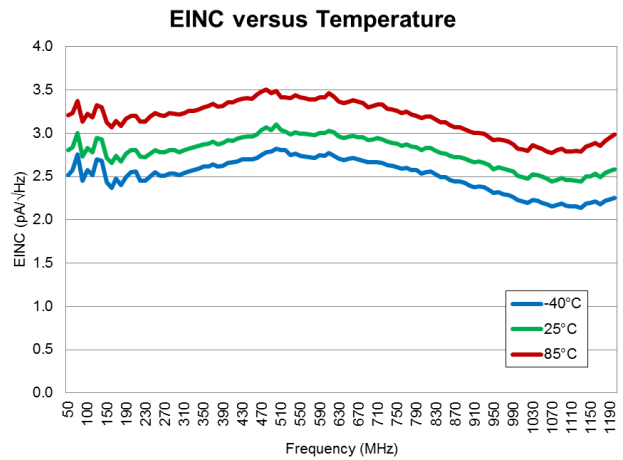
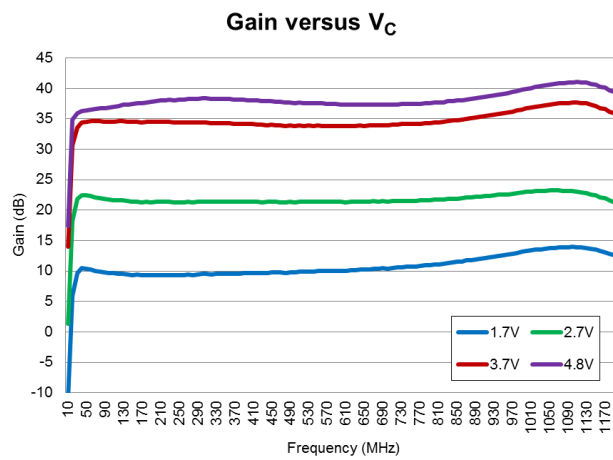
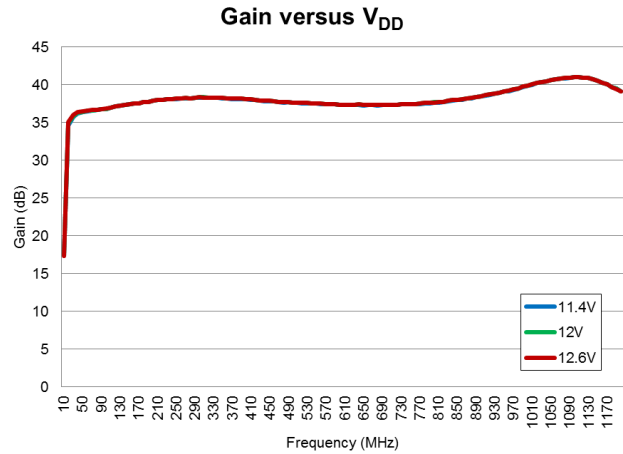
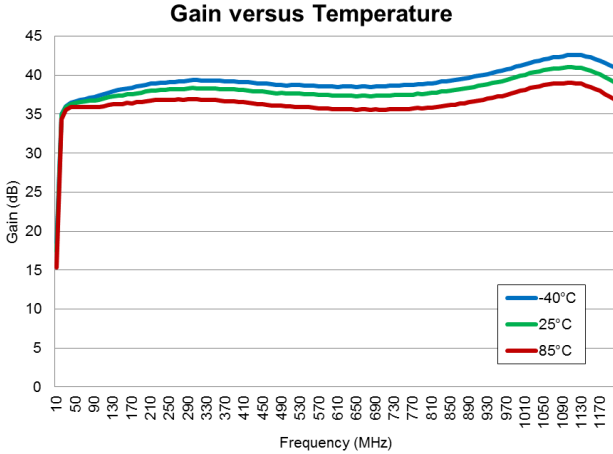

Typical Performance

Test conditions unless otherwise stated: T = +25 °C, V<sub>DD</sub> = +12 V

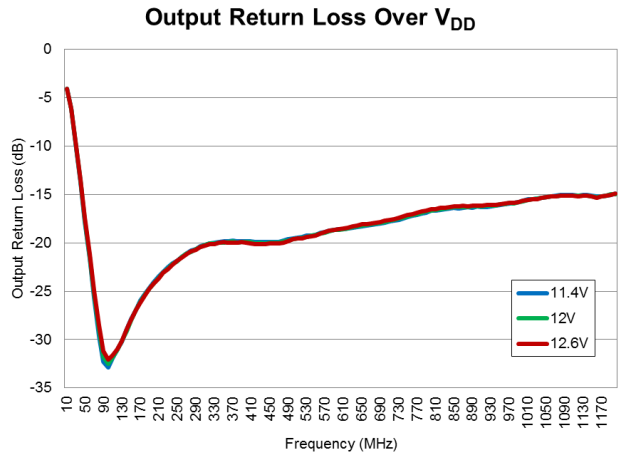
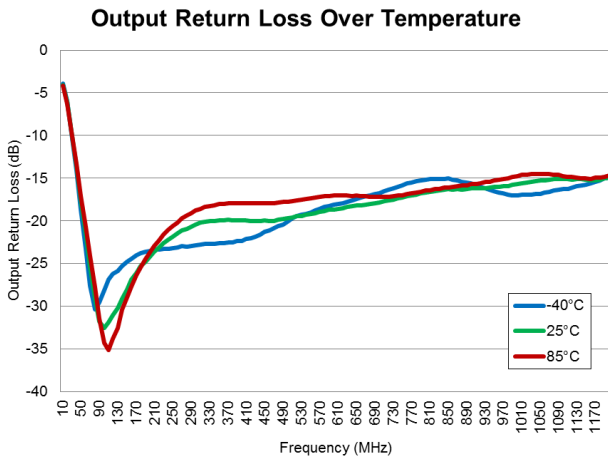
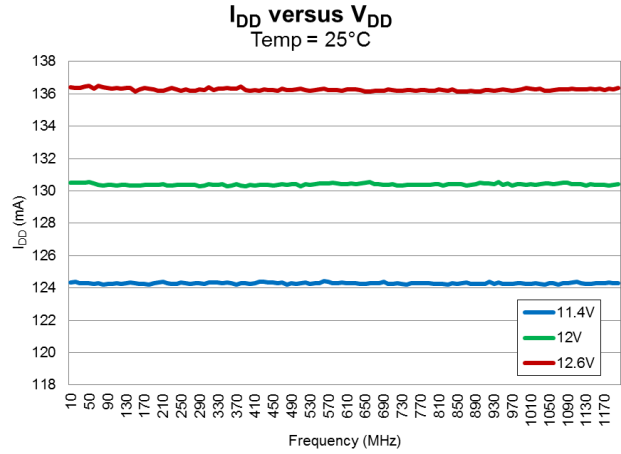
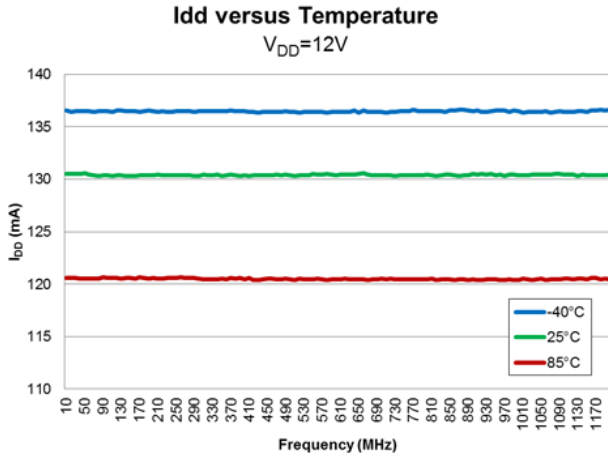



Typical Performance

Test conditions unless otherwise stated: T = +25 °C, V<sub>DD</sub> = +12 V

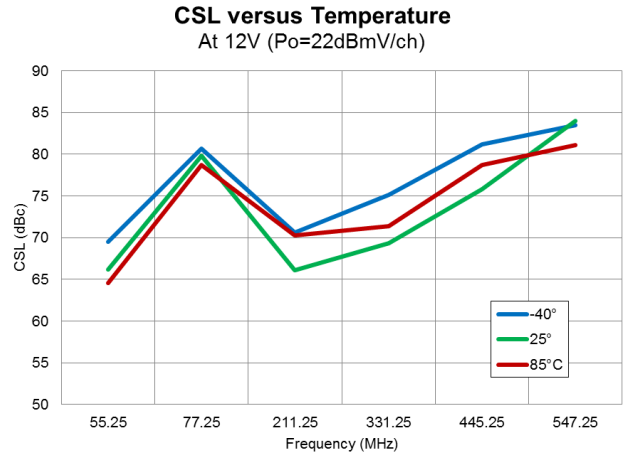
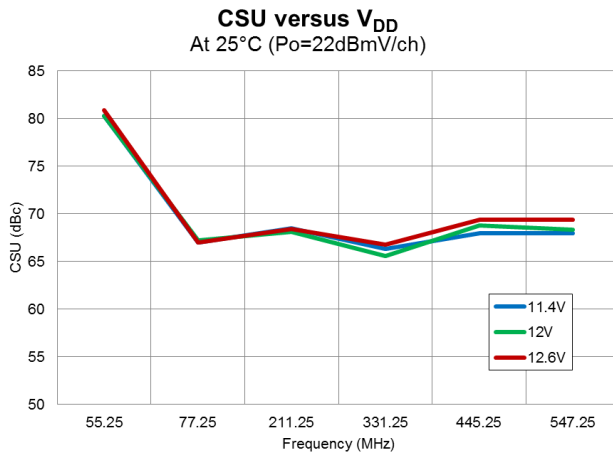
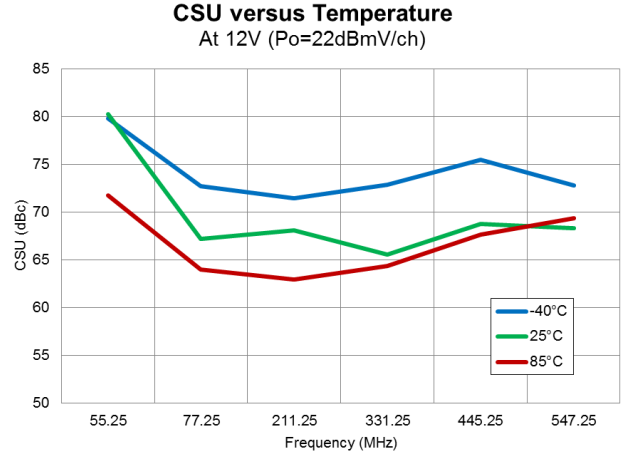
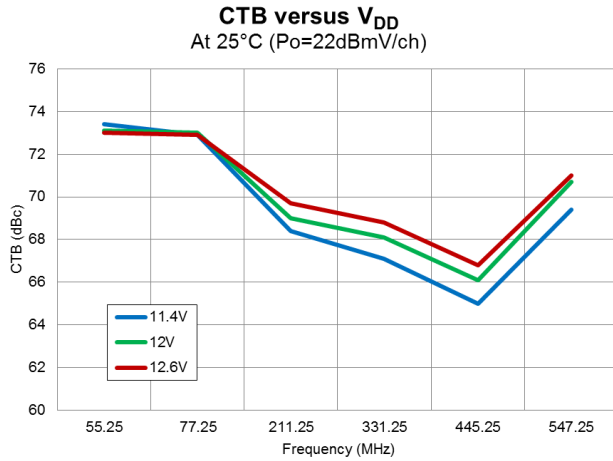



**Package Dimensions**

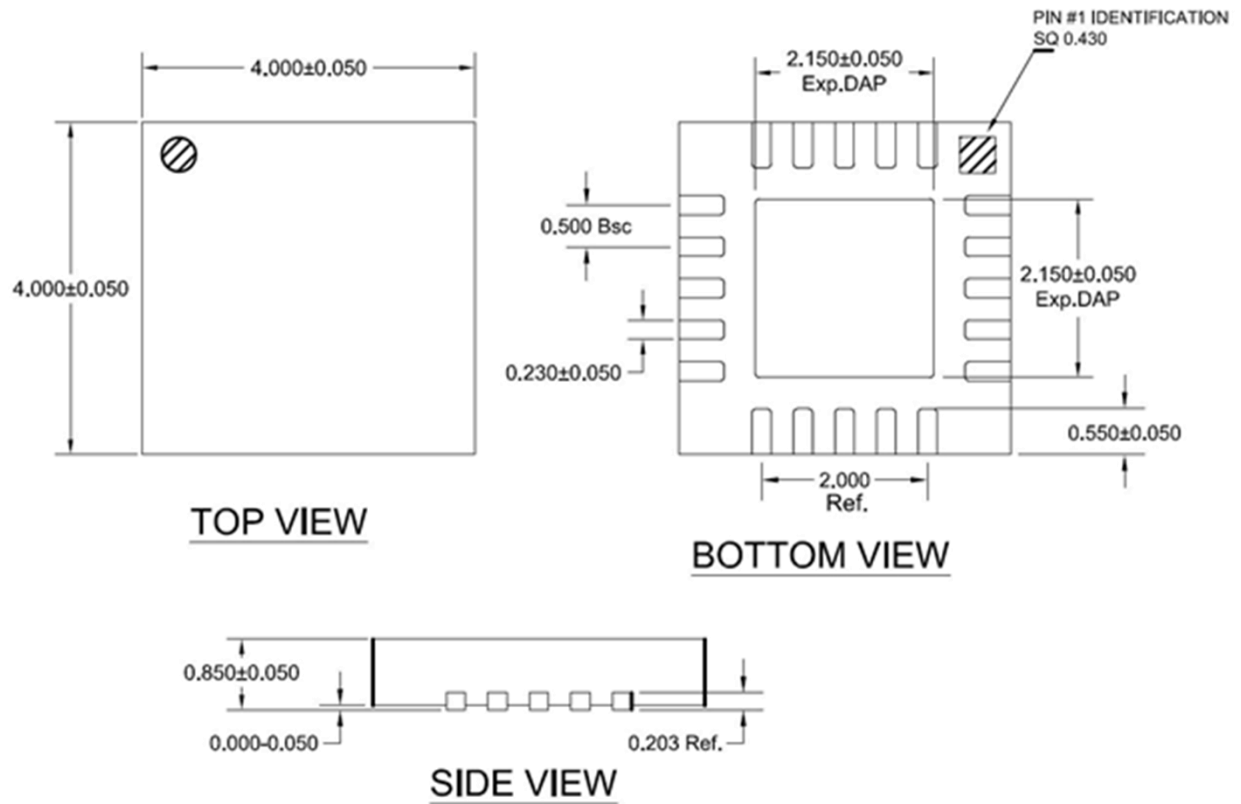

Notes:  
1. Dimensions in millimeters

Package Marking

---

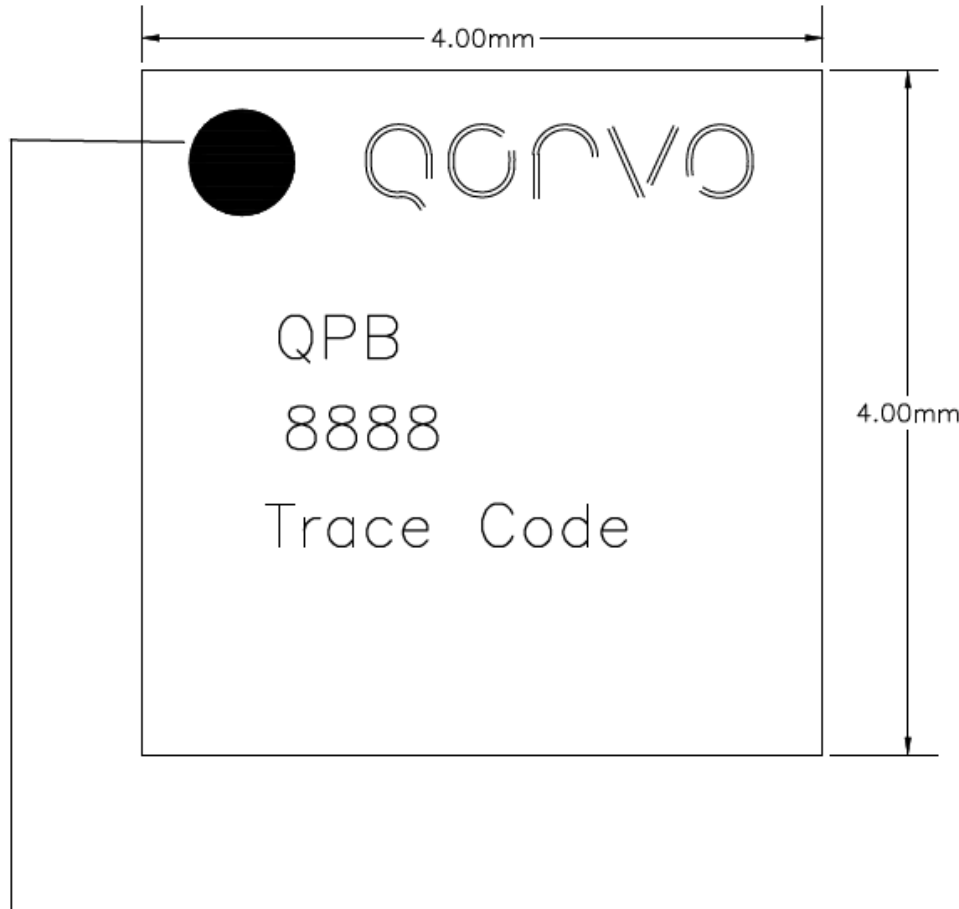

Pin 1 Indicator

Trace Code to be assigned by SubCon

## Pin Configuration and Description

Pin	Name	Description
1	TIA INPUT A	Input to the TIA stage of the receiver
2	BIAS1	Biassing for the first stage. The current flowing through this pin is used to control the biasing for the first stage amplifier
3	NC	Not Connected
4	BIAS1	Biassing for the first stage. The current flowing through this pin is used to control the biasing for the first stage amplifier
5	TIA INPUT B	Input to the TIA stage of the receiver
6	BIAS CONTRL	Bias Control pin not used for normal operation. A 0.1 $\mu$ F capacitor is connected to these pins for filtering
7	TIA OUT B	Output of the first stage TIA
8	Post AMP BIAS	Bias input for the second stage amplifier (post amp)
9	Post AMP IN B	Input for the second stage amplifier (post amp)
10	NC	Not Connected
11	Post AMP BIAS B	Biassing for the second stage amplifier (post amp)
12	Post AMP OUT B	Output of the second stage amplifier (post amp)
13	NC	Not Connected
14	Post AMP OUT A	Output of the second stage amplifier (post amp)
15	Post AMP BIAS A	Biassing for the second stage amplifier (post amp)
16	NC	Not Connected
17	Post AMP IN A	Input for the second stage amplifier (post amp)
18	Post AMP BIAS	Bias input for the second stage amplifier (post amp)
19	TIA OUT A	Output of the first stage TIA
20	BIAS CONTRL	Bias Control pin not used for normal operation. A 0.1 $\mu$ F capacitor is connected to these pins for filtering

## Handling Precautions

Parameter	Rating	Standard
ESD – Human Body Model (HBM)	Class 1A	ESDA / JEDEC JS-001-2012
ESD – Charged Device Model (CDM)	Class C3	JEDEC JESD22-C101F
MSL – Moisture Sensitivity Level	Level 2	IPC/JEDEC J-STD-020



Caution!  
 ESD-Sensitive Device

## Solderability

Compatible with both lead-free (260°C max. reflow temp.) and tin/lead (245°C max. reflow temp.) soldering processes. Solder profiles available upon request.

Contact plating: NiPdAu

## RoHS Compliance

This part is compliant with 2011/65/EU RoHS directive (Restrictions on the Use of Certain Hazardous Substances in Electrical and Electronic Equipment) as amended by Directive.

This product also has the following attributes:

- Lead Free
- Halogen Free (Chlorine, Bromine)
- Antimony Free
- TBBP-A (C<sub>15</sub>H<sub>12</sub>Br<sub>4</sub>O<sub>2</sub>) Free
- PFOS Free
- SVHC Free



## Contact Information

For the latest specifications, additional product information, worldwide sales and distribution locations:

**Web:** [www.qorvo.com](http://www.qorvo.com)

**Tel:** 1-844-890-8163

**Email:** [customer.support@qorvo.com](mailto:customer.support@qorvo.com)

## Important Notice

The information contained herein is believed to be reliable; however, Qorvo makes no warranties regarding the information contained herein and assumes no responsibility or liability whatsoever for the use of the information contained herein. All information contained herein is subject to change without notice. Customers should obtain and verify the latest relevant information before placing orders for Qorvo products. The information contained herein or any use of such information does not grant, explicitly or implicitly, to any party any patent rights, licenses, or any other intellectual property rights, whether with regard to such information itself or anything described by such information. **THIS INFORMATION DOES NOT CONSTITUTE A WARRANTY WITH RESPECT TO THE PRODUCTS DESCRIBED HEREIN, AND QORVO HEREBY DISCLAIMS ANY AND ALL WARRANTIES WITH RESPECT TO SUCH PRODUCTS WHETHER EXPRESS OR IMPLIED BY LAW, COURSE OF DEALING, COURSE OF PERFORMANCE, USAGE OF TRADE OR OTHERWISE, INCLUDING THE IMPLIED WARRANTIES OF MERCHANTABILITY AND FITNESS FOR A PARTICULAR PURPOSE.**

Without limiting the generality of the foregoing, Qorvo products are not warranted or authorized for use as critical components in medical, life-saving, or life-sustaining applications, or other applications where a failure would reasonably be expected to cause severe personal injury or death.

Copyright 2019 © Qorvo, Inc. | Qorvo is a registered trademark of Qorvo, Inc.

## Данный компонент на территории Российской Федерации

### Вы можете приобрести в компании MosChip.

Для оперативного оформления запроса Вам необходимо перейти по данной ссылке:

<http://moschip.ru/get-element>

Вы можете разместить у нас заказ для любого Вашего проекта, будь то серийное производство или разработка единичного прибора.

В нашем ассортименте представлены ведущие мировые производители активных и пассивных электронных компонентов.

Нашей специализацией является поставка электронной компонентной базы двойного назначения, продукции таких производителей как XILINX, Intel (ex.ALTERA), Vicor, Microchip, Texas Instruments, Analog Devices, Mini-Circuits, Amphenol, Glenair.

Сотрудничество с глобальными дистрибьюторами электронных компонентов, предоставляет возможность заказывать и получать с международных складов практически любой перечень компонентов в оптимальные для Вас сроки.

На всех этапах разработки и производства наши партнеры могут получить квалифицированную поддержку опытных инженеров.

Система менеджмента качества компании отвечает требованиям в соответствии с ГОСТ Р ИСО 9001, ГОСТ РВ 0015-002 и ЭС РД 009

### Офис по работе с юридическими лицами:

105318, г.Москва, ул.Щербаковская д.3, офис 1107, 1118, ДЦ «Щербаковский»

Телефон: +7 495 668-12-70 (многоканальный)

Факс: +7 495 668-12-70 (доб.304)

E-mail: [info@moschip.ru](mailto:info@moschip.ru)

Skype отдела продаж:

moschip.ru

moschip.ru\_4

moschip.ru\_6

moschip.ru\_9