

SURFACE MOUNT LED RED/GREEN, 0605 PACKAGE

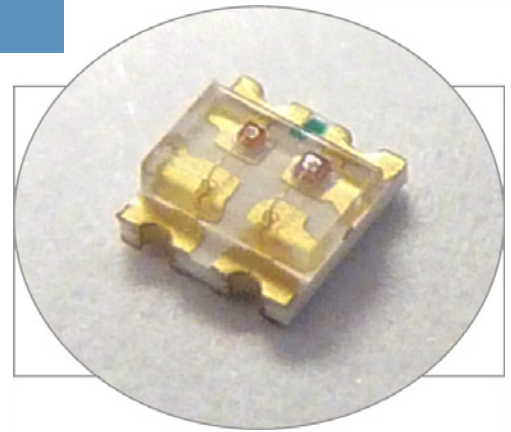

SM0605BC

- ◆ Industry Standard 0605 Package
- ◆ RoHS Compliant
- ◆ 2 Chips in One Small Package and Footprint
- ◆ Water Clear Lens
- ◆ Wide Viewing Angle
- ◆ Ideal for Status Indication, Display, and Backlighting

Bivar now offers its smallest Bi-Color Surface Mount LED to date which gives designers the edge they need for smaller board designs that require multiple color outputs. Its miniature size makes it ideal for almost any application where board space is a priority without compromise to quality, and it's long life and low power consumption are more than suitable for battery powered hand held devices and other portable products. This SM0605 LED is packaged in standard tape and reels for auto pick and place assemblies.

Part Number	Material	Emitted Color	Peak Wavelength λ_p (nm) TYP.	Lens Appearance	Luminous Intensity (mcd) TYP.	Viewing Angle
SM0605BC	AlGaInP	RED	630	Water Clear	120	120°
	AlGaInP	GREEN	575		60	

Outline Dimensions

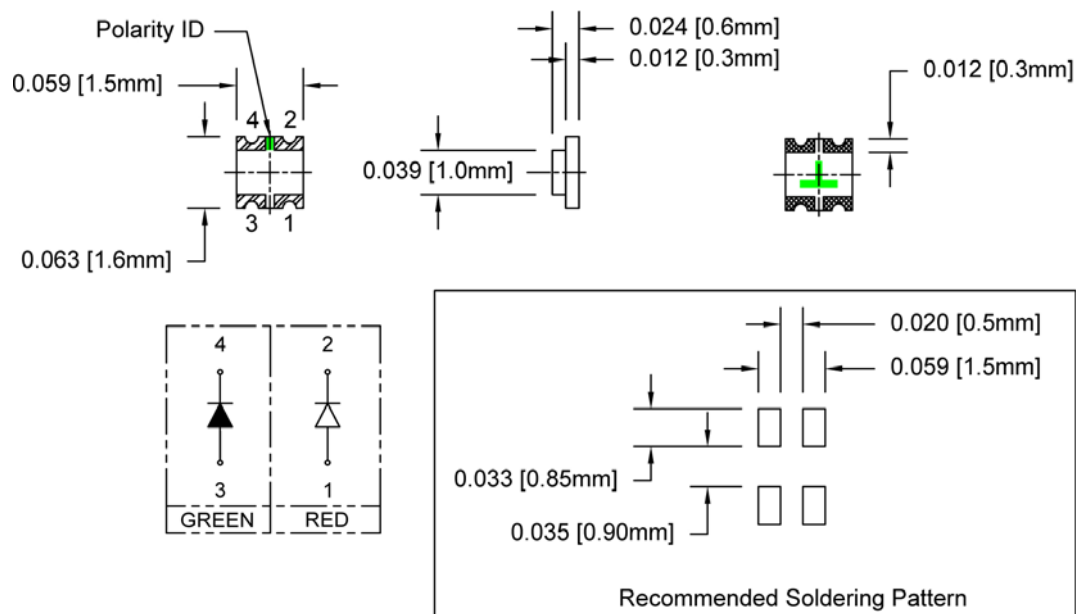

Outline Drawings Notes:

1. All dimensions are in inches [millimeters].
2. Standard tolerance: $\pm 0.10^\circ$ unless otherwise noted.



Bivar reserves the right to make changes at any time without notice.

Absolute Maximum Ratings

$T_A = 25^\circ\text{C}$ unless otherwise noted

Power Dissipation	Red - 72 mW Green - 72 mW
Continuous Forward Current	Red - 30 mA Green - 30 mA
Peak Forward Current ¹	100 mA
Reverse Voltage	5 V
Derating Linear From 25°C	0.4 mA/°C
Electrostatic Discharge (HBM)	2000 V
Operating Temperature Range	-30 ~ +80°C
Storage Temperature Range	-40 ~ +85°C
Lead Soldering Temperature ²	260°C

Notes: 1. $\leq 10\%$ Duty Cycle, Pulse Width ≤ 0.1 msec. 2. Solder time less than 5 seconds at temperature extreme.

Electrical / Optical Characteristics

$T_A = 25^\circ\text{C}$ & $I_F = 20$ mA unless otherwise noted

Part Number	Emitted Color	Forward Voltage (V)			Recommend Forward Current (mA)			Dominant Wavelength (nm)			Luminous Intensity I_v (mcd)			Viewing Angle $2\theta_{1/2}$ (deg)
		MIN	TYP	MAX	MIN	TYP	MAX	MIN	TYP	MAX	MIN	TYP	MAX	TYP
SM0605BC	Red	/	1.9	2.4	/	20	/	/	625	/	72	120	/	120
	Green	/	1.9	2.4	/	20	/	/	574	/	36	60	/	

Typical Electrical / Optical Characteristics

$T_A = 25^\circ\text{C}$ & $I_F = 20$ mA unless otherwise noted

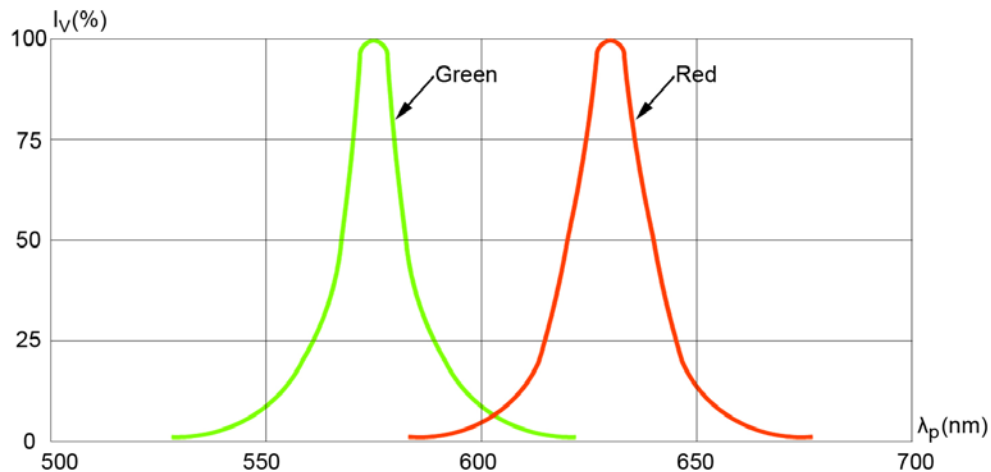

Fig. 1 Relative Luminous Intensity vs. Peak Wavelength

Bivar reserves the right to make changes at any time without notice.

Typical Electrical / Optical Characteristics (Continued)

$T_A = 25^\circ\text{C}$ unless otherwise noted

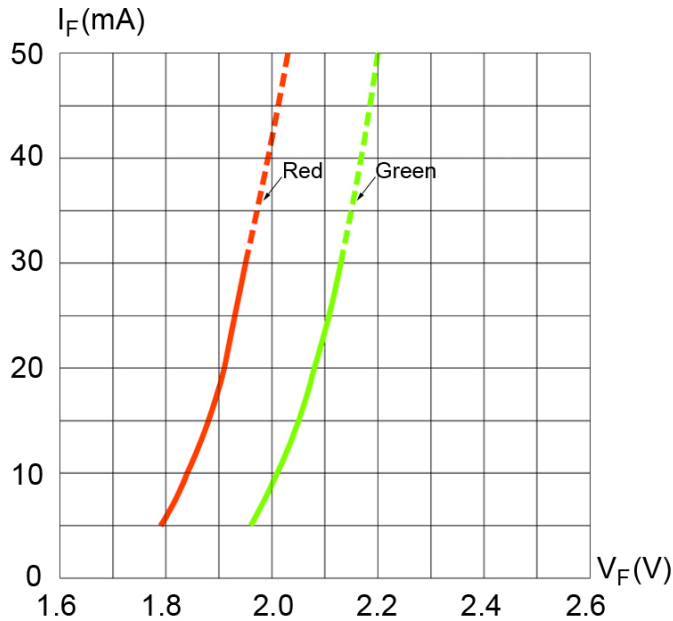

Fig. 2 Forward Current vs. Forward Voltage

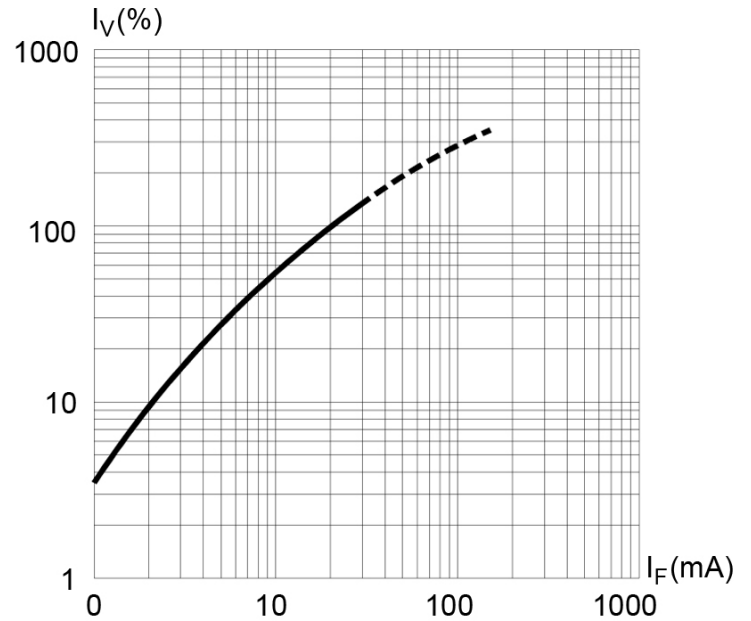

Fig. 3 Relative Luminous Intensity vs. Forward Current

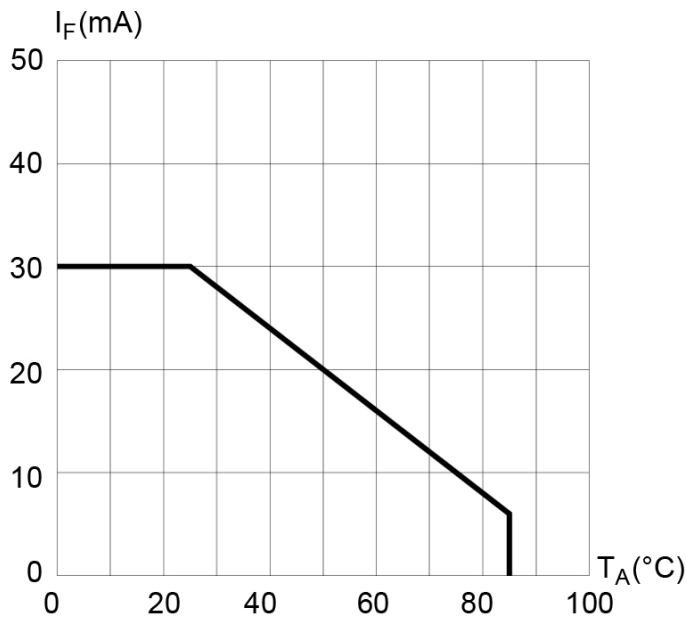

Fig. 4 Forward Current vs. Ambient Temperature

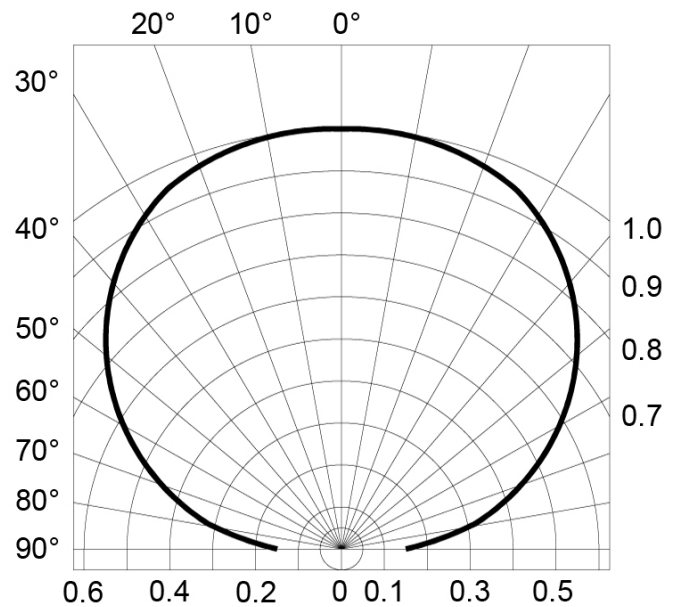

Fig. 5 Directivity Radiation Diagram

Bivar reserves the right to make changes at any time without notice.

SURFACE MOUNT LED RED/GREEN, 0605 PACKAGE



Tape and Reel Dimensions

Note: 4000 pcs / Reel

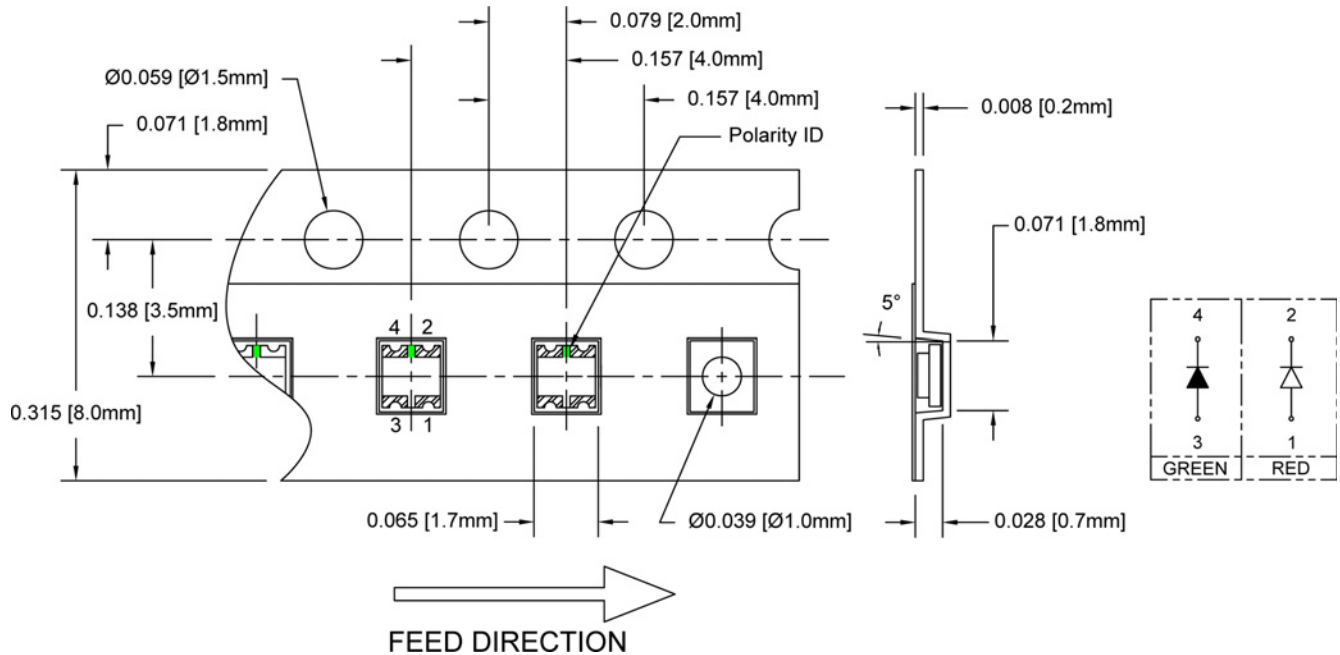

Outline Drawings Notes:

1. All dimensions are in inches [millimeters].
2. Standard tolerance: $\pm 0.10^\circ$ unless otherwise noted.

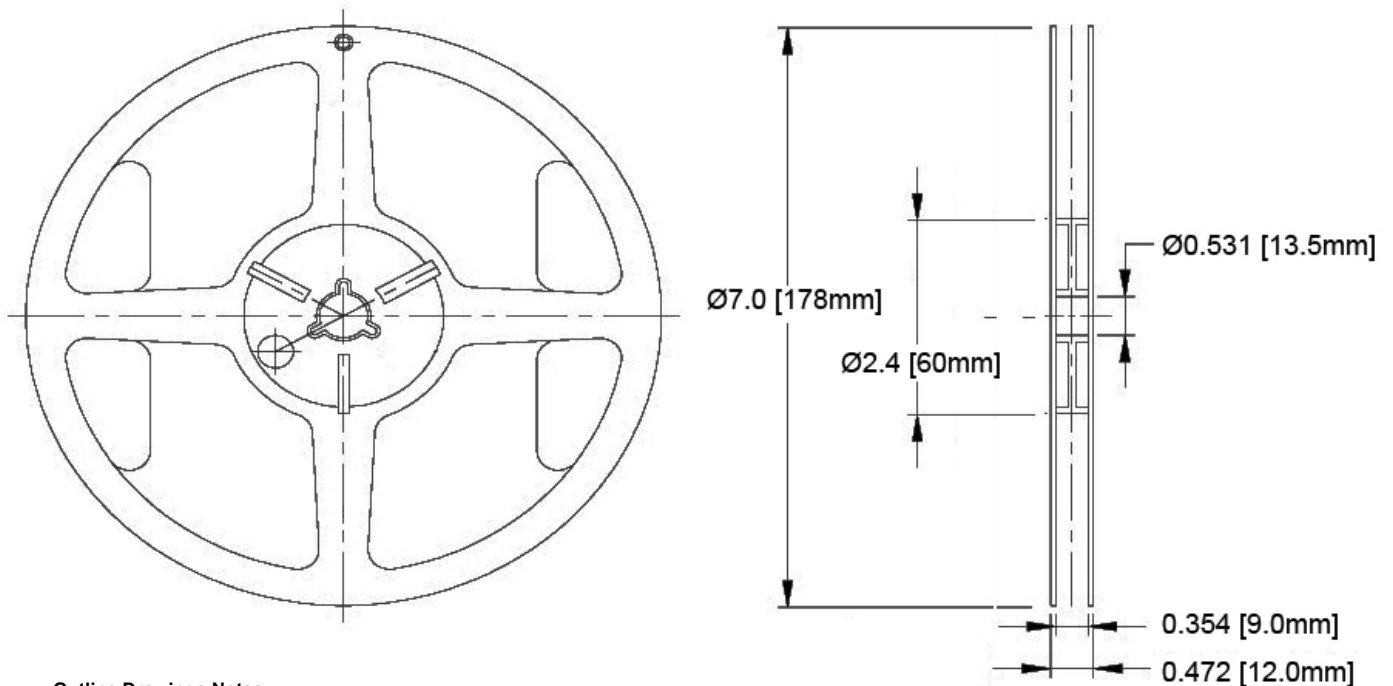

Outline Drawings Notes:

1. All dimensions are in inches [millimeters].
2. Standard tolerance: $.xxx \pm 0.10^\circ$, $.x \pm 1^\circ$ unless otherwise noted.

Bivar reserves the right to make changes at any time without notice.

SURFACE MOUNT LED RED/GREEN, 0605 PACKAGE



Packaging and Labeling Plan

Note: 1 Reel / Bag

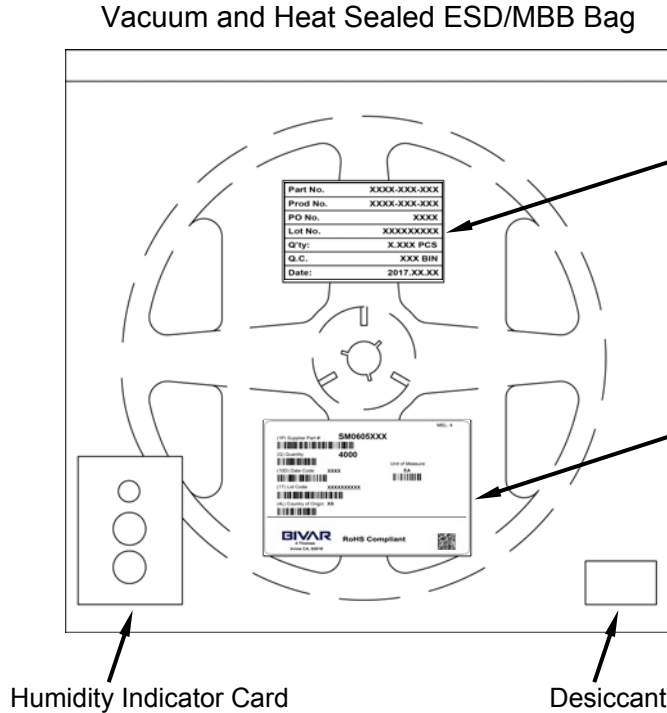

Part No.	XXXX-XXX-XXX
Prod No.	XXXX-XXX-XXX
PO No.	XXXX
Lot No.	XXXXXXXXXX
Q'ty:	X.XXX PCS
Q.C.	XXX BIN
Date:	2017.XX.XX

Internal Quality Control Label

MSL: 4

(1P) Supplier Part #: **SM0605XXX**

(Q) Quantity: **4000**

(10D) Date Code: **XXXX**

(1T) Lot Code: **XXXXXXXXXX**

(4L) Country of Origin: **XX**

Unit of Measure: **EA**

BIVAR RoHS Compliant

4 Thomas
Irvine CA, 92618

Bivar Standard Packaging Label

Recommended Soldering Conditions

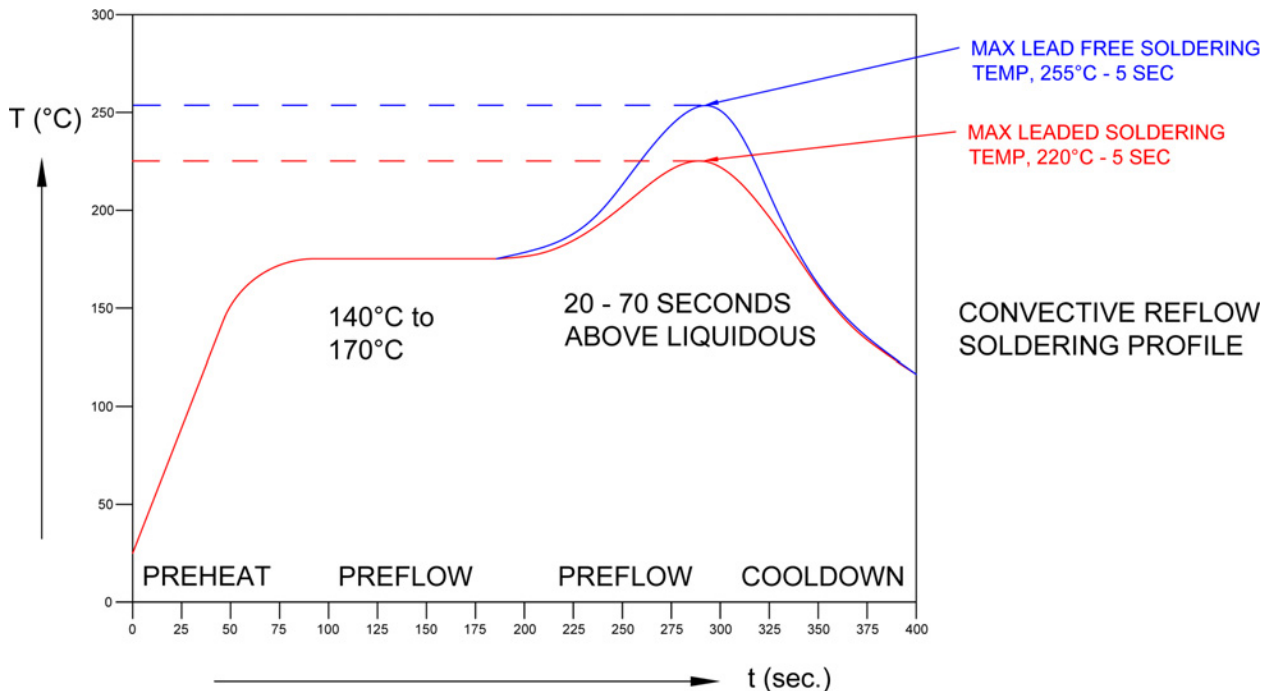

Bivar reserves the right to make changes at any time without notice.

Данный компонент на территории Российской Федерации

Вы можете приобрести в компании MosChip.

Для оперативного оформления запроса Вам необходимо перейти по данной ссылке:

<http://moschip.ru/get-element>

Вы можете разместить у нас заказ для любого Вашего проекта, будь то серийное производство или разработка единичного прибора.

В нашем ассортименте представлены ведущие мировые производители активных и пассивных электронных компонентов.

Нашей специализацией является поставка электронной компонентной базы двойного назначения, продукции таких производителей как XILINX, Intel (ex.ALTERA), Vicor, Microchip, Texas Instruments, Analog Devices, Mini-Circuits, Amphenol, Glenair.

Сотрудничество с глобальными дистрибьюторами электронных компонентов, предоставляет возможность заказывать и получать с международных складов практически любой перечень компонентов в оптимальные для Вас сроки.

На всех этапах разработки и производства наши партнеры могут получить квалифицированную поддержку опытных инженеров.

Система менеджмента качества компании отвечает требованиям в соответствии с ГОСТ Р ИСО 9001, ГОСТ РВ 0015-002 и ЭС РД 009

Офис по работе с юридическими лицами:

105318, г.Москва, ул.Щербаковская д.3, офис 1107, 1118, ДЦ «Щербаковский»

Телефон: +7 495 668-12-70 (многоканальный)

Факс: +7 495 668-12-70 (доб.304)

E-mail: info@moschip.ru

Skype отдела продаж:

moschip.ru

moschip.ru_4

moschip.ru_6

moschip.ru_9