

## Headphone Amplifier for Portable Audio

### ■ GENERAL DESCRIPTION

The **NJM2776** is a low voltage headphone amplifier for portable audio applications.

The **NJM2776** operates directly for one battery supply with independent power supply terminals ( $V^{+1}$  and  $V^{+2}$ ).

Also it provides shock-noise less standby mode.

The **NJM2776** is suitable for portable MD, portable CD and others.

### ■ PACKAGE OUTLINE



**NJM2776RB2**  
**MSOP10 (TVSP10)**

### ■ FEATURES

- Operating Voltage  $V^{+1}$ (from step-up converter) =1.8 to 4.5V (however,  $V^{+1} > V^{+2}$ )
- Low Operating Current  $V^{+2}$ (from battery) =0.9 to 4.5V (however,  $V^{+1} > V^{+2}$ )
- Supply Current in Standby mode  $I_{CC4}(V^{+1} \text{ side})=200\mu\text{A typ.}$  ( $V^{+1}=2.3\text{V}$ ,  $V^{+2}=1.2\text{V}$ , No signal)
- Output Power Exceeds  $I_{CC3}(V^{+2} \text{ side})=350\mu\text{A typ.}$  ( $V^{+1}=2.3\text{V}$ ,  $V^{+2}=1.2\text{V}$ , No signal)
- Shock-noise less Standby mode  $I_{CC2}(V^{+1} \text{ side})=25\mu\text{A typ.}$  ( $V^{+1}=2.3\text{V}$ ,  $V^{+2}=1.2\text{V}$ )
- Bipolar Technology  $I_{CC1}(V^{+2} \text{ side})=6\mu\text{A typ.}$  ( $V^{+1}=2.3\text{V}$ ,  $V^{+2}=1.2\text{V}$ )
- Package Outline  $P_O=8.5\text{mW typ.}$  ( $R_L=16\Omega$ , THD=10%)

MSOP10 (TVSP10)\*

\*MEET JEDEC MO-187-DA / THIN TYPE

### ■ PIN CONFIGURATION AND BLOCK DIAGRAM

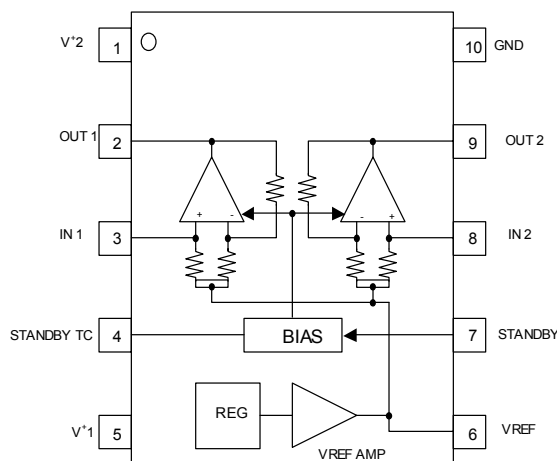

1.  $V^{+2}$
2. OUT1
3. IN1
4. STADBY\_TC
5.  $V^{+1}$
6. VREF
7. STANDBY
8. IN2
9. OUT2
10. GND

# NJM2776

## ■ ABSOLUTE MAXIMUM RATINGS (Ta=25°C)

PARAMETER	SYMBOL	RATINGS	UNIT
Supply Voltage	V <sup>+</sup>	5	V
Power Dissipation	P <sub>D</sub>	320 <sup>(note)</sup>	mW
Operating Temperature range	T <sub>opr</sub>	-20 to +75	°C
Storage Temperature Range	T <sub>stg</sub>	-40 to +125	°C

## ■ RECOMMENDED OPERATING CONDITIONS

PARAMETER	SYMBOL	TEST CONDITION	MIN.	TYP.	MAX.	UNIT
Operating Voltage Range	V <sup>+1</sup>	-	1.8	2.3	4.5	V
	V <sup>+2</sup>	-	0.9	1.2	4.5	

## ■ ELECTRICAL CHARACTERISTICS (Ta=25°C, V<sup>+1</sup>=2.3V, V<sup>+2</sup>=1.2V, V<sub>IN</sub>=-30dBV (31.6mVrms), f=1kHz, R<sub>L</sub>=16Ω, Active mode, unless otherwise specified)

### ● Power Supply

PARAMETER	SYMBOL	TEST CONDITION	pin	MIN.	TYP.	MAX.	UNIT
Operating Current	I <sub>CC0</sub>	V <sup>+1</sup> =0V	V <sup>+2</sup>	-	-	1.0	μA
	I <sub>CC1</sub>	Standby mode	V <sup>+2</sup>	-	6.0	10.0	
	I <sub>CC2</sub>		V <sup>+1</sup>	-	25	35	
	I <sub>CC3</sub>	No signal	V <sup>+2</sup>	-	350	750	mA
	I <sub>CC4</sub>		V <sup>+1</sup>	-	200	400	
		I <sub>CC5</sub>	P <sub>O</sub> =0.1mW+0.1mW	V <sup>+2</sup>	-	2.5	-
	I <sub>CC6</sub>	V <sup>+1</sup>		-	200	-	
Reference Voltage	V <sub>REF</sub>	No signal		0.50	0.60	0.65	V

### ● Amplifier

PARAMETER	SYMBOL	TEST CONDITION	MIN.	TYP.	MAX.	UNIT
Closed loop Gain	G <sub>V</sub>		10.0	11.5	12.5	dB
Output Power	P <sub>O</sub>	THD=10%	5.0	8.5	-	mW
Total Harmonic Distortion	THD	P <sub>O</sub> =1mW	-	0.20	0.50	%
Output Noise Voltage	V <sub>NO</sub>	A-Weighted	-	-100 (10.0)	-96 (15.8)	dBV (μV)
Channel Separation	CS		44	55	-	dB
Mute Level	MUTE	Standby mode 1kHz Band Pass	-	-100	-80	dB
Supply Voltage Rejection Ratio	PSRR1	V <sup>+1</sup> =1.8V + 0.1Vrms V <sup>+2</sup> =0.9V	46	52	-	dB
	PSRR2	V <sup>+1</sup> =1.8V V <sup>+2</sup> =0.9V + 0.1Vrms	70	77	-	

### ● Mode Control

PARAMETER	SYMBOL	TEST CONDITION	MIN.	TYP.	MAX.	UNIT
High Level Input Voltage	V <sub>IH</sub>	V <sub>IN</sub> =High Level	1.2	-	V <sup>+1</sup>	V
Low Level Input Voltage	V <sub>IL</sub>	V <sub>IN</sub> =Low Level	0.0	-	0.3	

## ■ MODE SWITCH FUNCTION

### ● STANDBY (7PIN)

PARAMETER	CONTROL SIGNAL	STATUS
Standby	L, open	IC is non-active.
Active	H	IC is active.

## ■ TERMINAL DESCRIPTION

PIN No.	SYMBOL	EQUIVALENT CIRCUIT	VOLTAGE	NOTE
2,9	OUT1, OUT2		0.6V	
3,8	IN1, IN2		0.6V	
4	STANDBY_TC		1.2V	
6	VREF		0.6V	

# NJM2776

PIN No.	SYMBOL	EQUIVALENT CIRCUIT	VOLTAGE	NOTE
7	STANDBY		-	

## ■ APPLICATION CIRCUIT

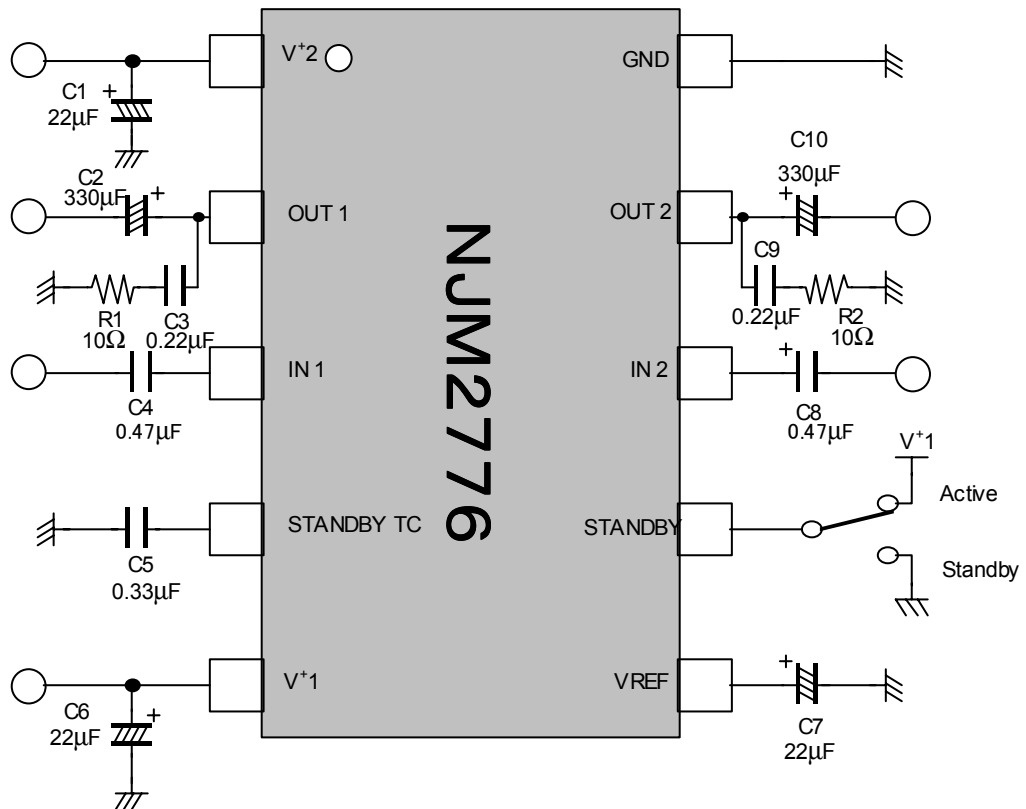

Note) Recommended the capacitors — C1, C3, C6 and C9 — are featuring higher frequency efficiency to prevent the oscillation.

## ■ APPLICATION NOTE

### 1. Procedure for Supplying Power

Supply the power to first  $V^{+2}$ (Battery side) and then  $V^{+1}$ (Step-up Converter side).

### 2. Input Dynamic Voltage Range

The reference voltage is fixed at 0.6V. Therefore input dynamic voltage range is not proportion to the power supply voltage.

The input signal over dynamic range makes distortion. For prevent the distortion, adjust the maximum input signal level.

### 3. Charge Sequence

Pop noise may not be happened with mode switch operation once output voltage becomes reference voltage. The "Charge Sequence" may shorter the time for power up initialization.

Charge Sequence: To set mode switch from standby to active during power up initialization, activate rapid charge circuit for stabilizing the output voltage.

## ■ TYPICAL CHARACTERISTICS

### Operating Current vs. Operating Voltage

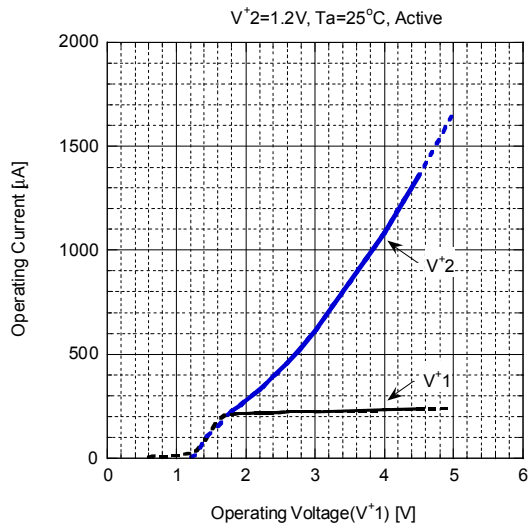

### Operating Current vs. Operating Voltage

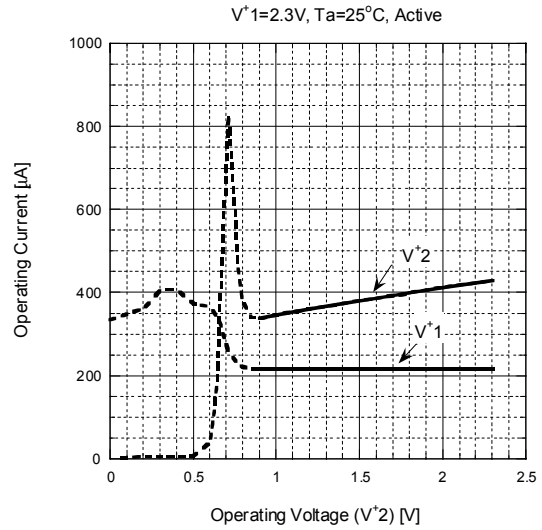

### Operating Current vs. Operating Voltage

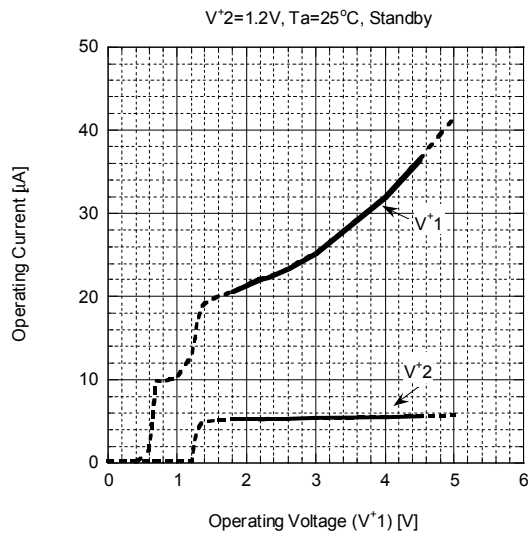

### Operating Current vs. Operating Voltage

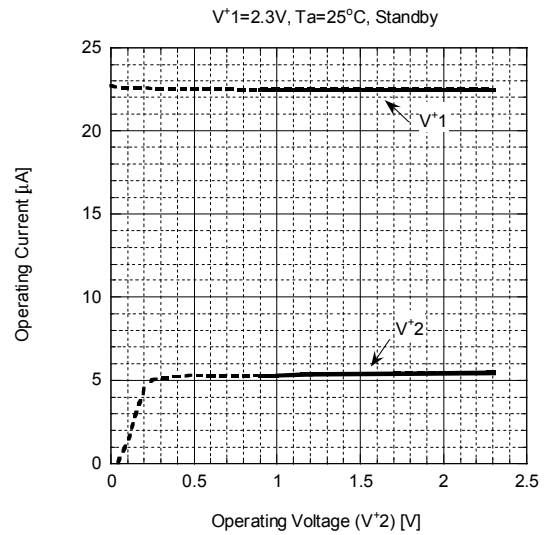

### Operating Current vs. Temperature

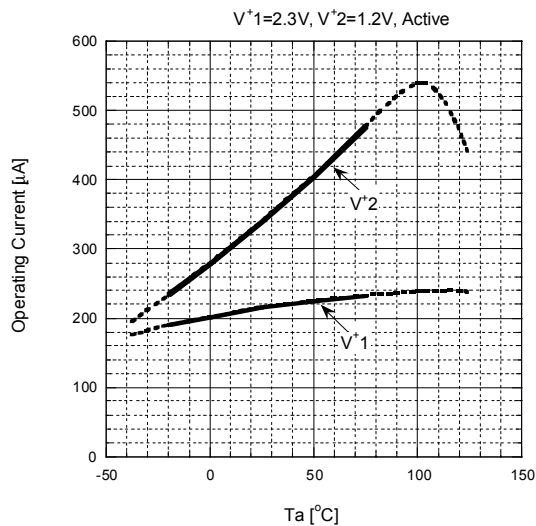

### Operating Current vs. Temperature

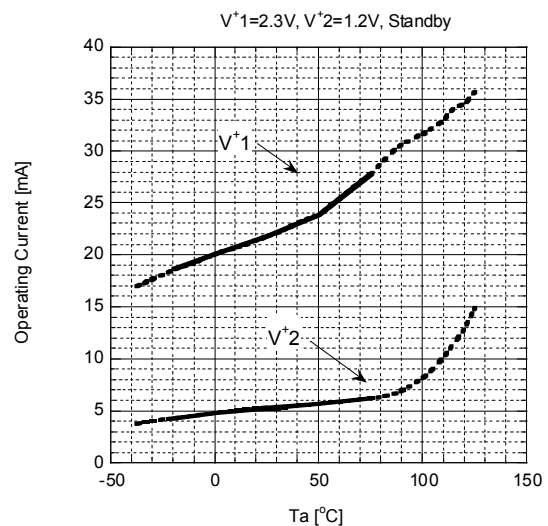

## ■ TYPICAL CHARACTERISTICS

### Reference Voltage vs. Operating Voltage

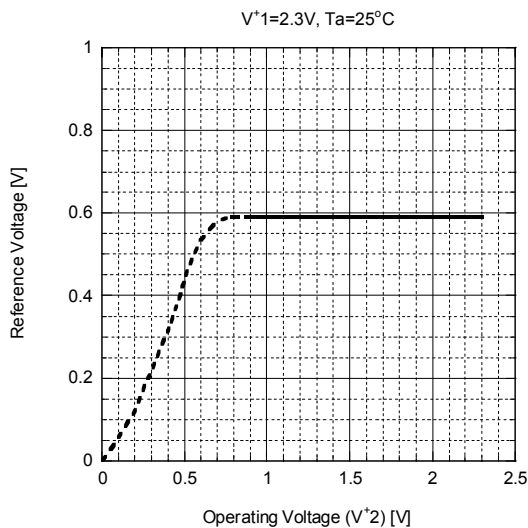

### Reference Voltage vs. Temperature

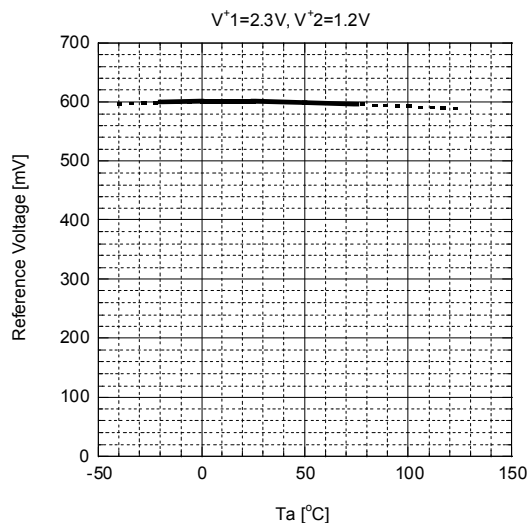

### Total Harmonic Distortion vs. Output Power

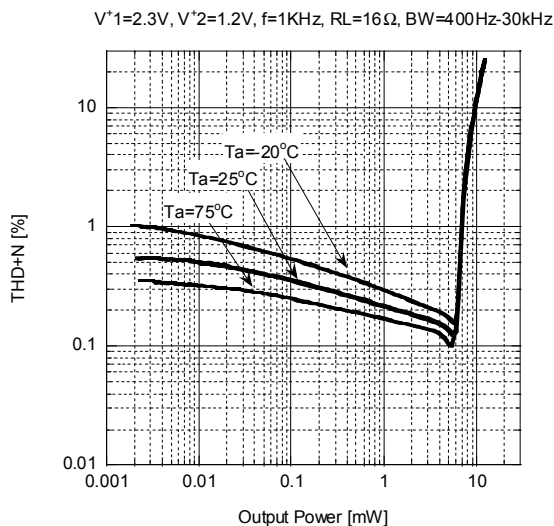

### Total Harmonic Distortion vs. Output Power

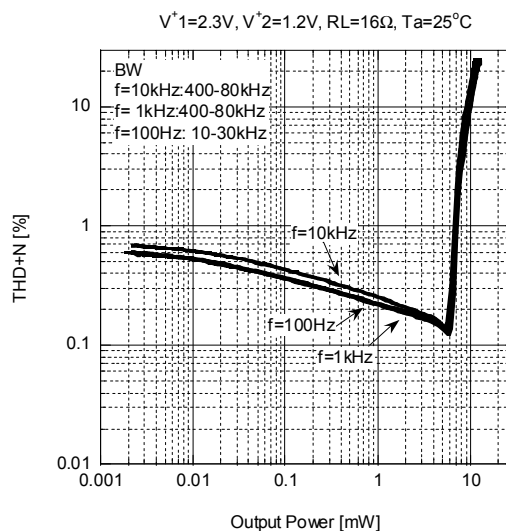

### Output Power vs. Operating Voltage

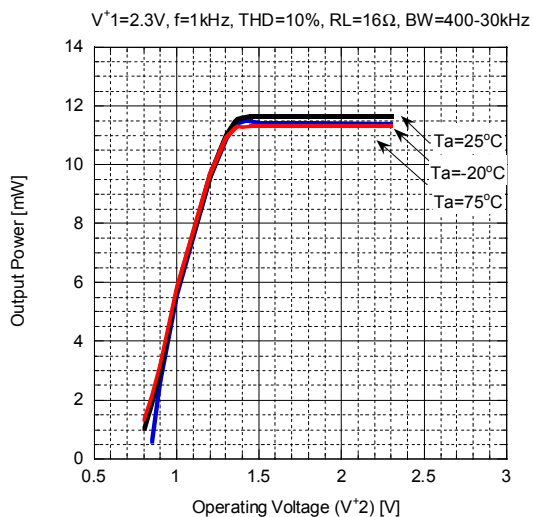

### Power Dissipation vs. Output Power

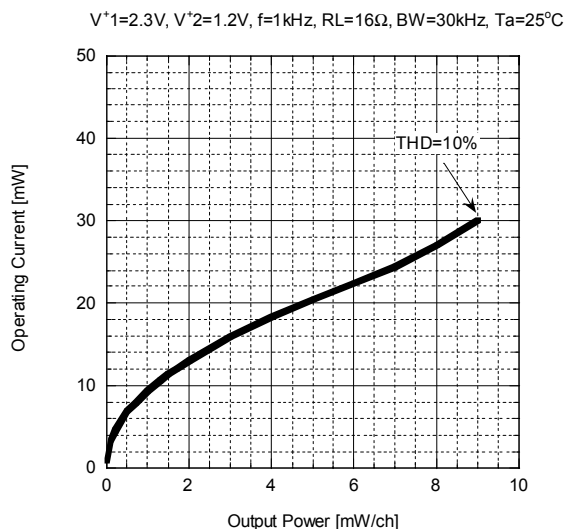



## ■ TYPICAL CHARACTERISTICS

### Output Noise Voltage vs. Temperature

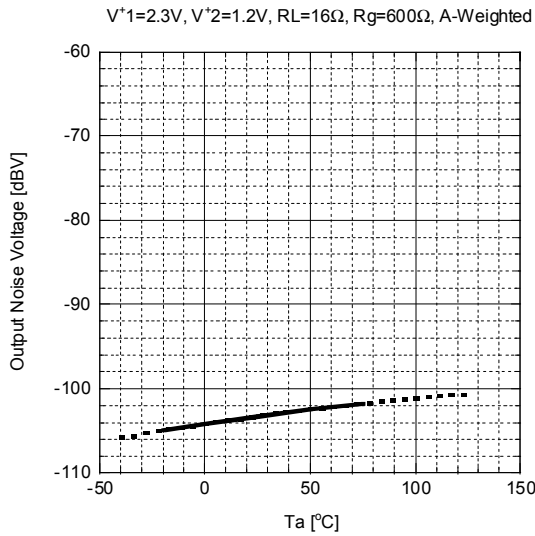

### Channel Separation vs. Frequency

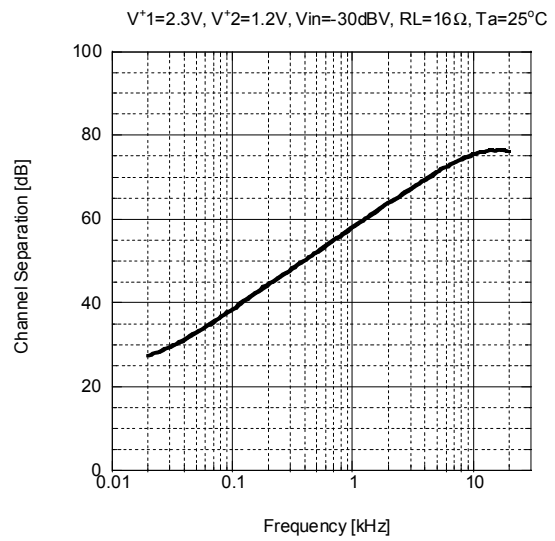

### Mute Level vs. Frequency

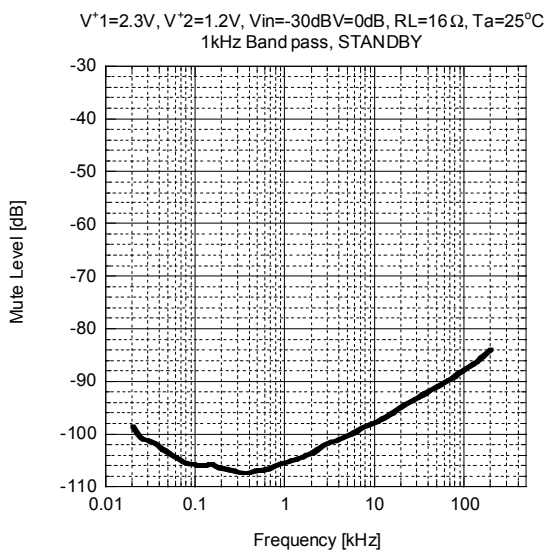

### Mute Level vs. Temperature

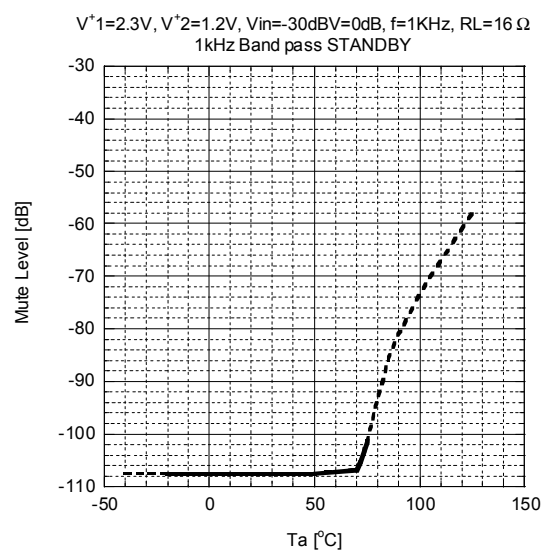

### PSRR vs. frequency ( $V^+1$ )

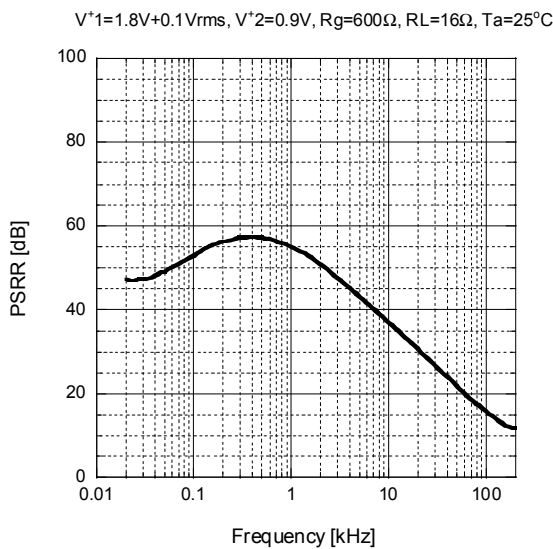

### PSRR vs. frequency ( $V^+2$ )

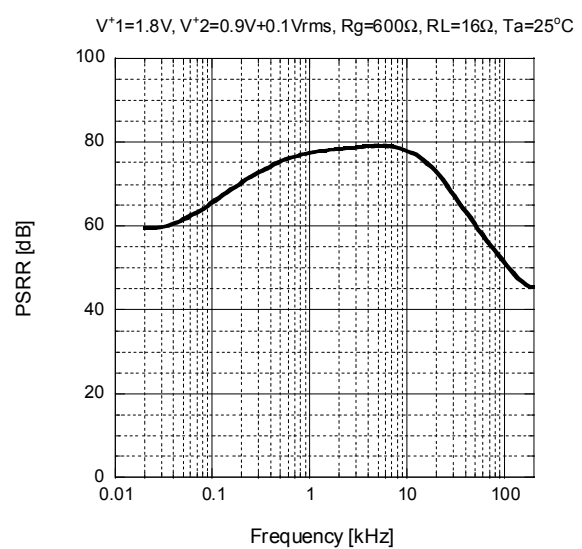

# NJM2776

## ■ TYPICAL CHARACTERISTICS

### Gain vs. STANDBY Control Voltage

$V^*1=2.3V$ ,  $V^*2=1.2V$ ,  $V_{in}=30dBV$ ,  $f=1kHz$ ,  $R_L=16\Omega$

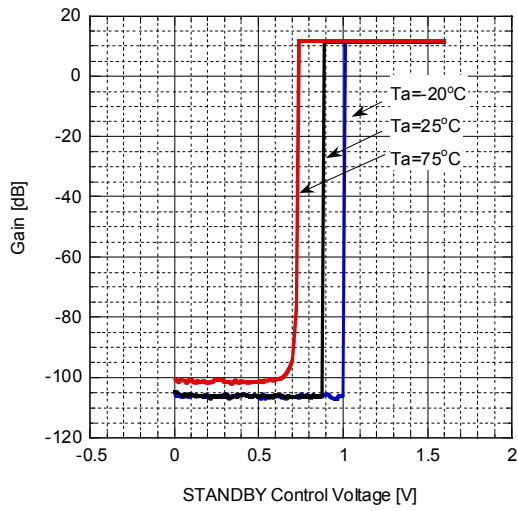

#### [CAUTION]

The specifications on this databook are only given for information, without any guarantee as regards either mistakes or omissions. The application circuits in this databook are described only to show representative usages of the product and not intended for the guarantee or permission of any right including the industrial rights.

# Mouser Electronics

Authorized Distributor

Click to View Pricing, Inventory, Delivery & Lifecycle Information:

[NJR:](#)

[NJM2776RB2-TE2](#) [NJM2776RB2-TE1](#)

## Данный компонент на территории Российской Федерации

### Вы можете приобрести в компании MosChip.

Для оперативного оформления запроса Вам необходимо перейти по данной ссылке:

<http://moschip.ru/get-element>

Вы можете разместить у нас заказ для любого Вашего проекта, будь то серийное производство или разработка единичного прибора.

В нашем ассортименте представлены ведущие мировые производители активных и пассивных электронных компонентов.

Нашей специализацией является поставка электронной компонентной базы двойного назначения, продукции таких производителей как XILINX, Intel (ex.ALTERA), Vicor, Microchip, Texas Instruments, Analog Devices, Mini-Circuits, Amphenol, Glenair.

Сотрудничество с глобальными дистрибьюторами электронных компонентов, предоставляет возможность заказывать и получать с международных складов практически любой перечень компонентов в оптимальные для Вас сроки.

На всех этапах разработки и производства наши партнеры могут получить квалифицированную поддержку опытных инженеров.

Система менеджмента качества компании отвечает требованиям в соответствии с ГОСТ Р ИСО 9001, ГОСТ РВ 0015-002 и ЭС РД 009

### Офис по работе с юридическими лицами:

105318, г.Москва, ул.Щербаковская д.3, офис 1107, 1118, ДЦ «Щербаковский»

Телефон: +7 495 668-12-70 (многоканальный)

Факс: +7 495 668-12-70 (доб.304)

E-mail: [info@moschip.ru](mailto:info@moschip.ru)

Skype отдела продаж:

moschip.ru

moschip.ru\_4

moschip.ru\_6

moschip.ru\_9