

NECTOR M POWER SYSTEM

INDOOR & OUTDOOR
BUILDING AND LUMINAIRE POWER

NECTOR M Power System

Specifications

Free Hanging Socket & Pin Connectors

Panel Mount Socket & Pin Connectors

PCB Mounted Socket & Pin Headers

NECTOR M Sealed Power System

Specifications

Free Hanging Socket & Pin Connectors

Panel Mount Socket & Pin Connectors

NECTOR M Cable Assemblies

Specifications

WHAT'S INSIDE

Buildings are alive. They have the intelligence to sense and react, anticipate and illuminate. They talk – they breathe and with increased urbanization and a rise in environmental concerns, there is a growing demand for state-of-the-art buildings that provide total comfort, convenience and control. The NECTOR M power system will help enhance how buildings are powered within the walls and expand to the many devices that it powers. Additionally, NECTOR M Sealed system is designed to provide a pluggable connectivity solution for outdoor and harsh environments.



TE Connectivity (TE)'s NECTOR M power system is a flexible, fully pluggable, modular wiring connectors and cabling solution for the permanent & temporary power and control electrical installations. NECTOR M power system offers an ideal solution for both indoor and a sealed version for outdoor. High humidity installations also enabling a reconfigurable, easy-to-install and time saving alternative to the traditional hard-wired electrical connections.



Target Markets

- Electrical Installation
- Lighting Installation

Applications

- **Lighting**
 - Architectural
 - Commercial
 - Greenhouse Lighting
 - Street Lighting
 - Industrial
 - Residential
 - Retail Display
 - Emergency
 - Entertainment and Off-Grid
 - Factory-built Construction
- **Power Distribution**
 - Commercial Office/Retail Buildings
 - Residential
 - Pre-fabricated Building
 - Hotels
 - Schools
 - Hospitals
 - Shipbuilding

Key Benefits

- Improve installation efficiency with one connector solution that addresses power, data and control requirements
- Enable design consistency with the same size knock out diameter for a multi-position 5,6 and 7 pole connector system
- Reduce installation time, on-site labor cost and waste with a multi-functional modular system
- Support easy field installation (with NECTOR M sealed) and simplify routing during installation with a circular form factor that requires less real estate
- Reduce Health at safety risk at the construction site

NECTOR M Power System



NECTOR M Sealed Power System





NECTOR M Power System

The NECTOR M product portfolio offers a complete range of 3, 5, 6 and 7 pole pluggable electrical installation components for indoor applications with free hanging, panel/chassis mount, PCB mount and power splitter solution. For example, a 3 pole NECTOR M system could be an ideal solution for ceiling, wall, pendant and furniture lighting fixtures that require a ground connection in residential or commercial spaces. The multi-phase, 5 pole NECTOR M system provides the power and signal connections required for lighting control (e.g. DALI) applications. The multi-phase, 7 pole systems provide additional power and signal connections to be used for emergency lighting systems and for color control lighting capability.

NECTOR M

Electrical

- **Operating Voltage:** 400 VAC IEC rating
600 VAC UL rating
- **Operating current:**

Contact Part Number	Wire Conductor Size	Single Phase Circuit Max Current	Multi-phase Circuit Max Current
293476-2 pin	1.5 mm ²	11 A	10 A
293475-2 socket			
2213657-2 pin	1.5 mm ²	16 A	10 A
2213656-2 socket			
1-293476-2 pin	2.5 mm ²	14 A	14 A
1-293475-2 socket			
1-2213657-2 pin	2.5 mm ²	20 A	16 A
1-2213656-2 socket			
1-2213266-2 pin	18 AWG	7 A	7 A
1-2213265-2 socket			
1-2213266-2 pin	16 AWG	10 A	10 A
1-2213265-2 socket			
2213266-2 pin	14 AWG	15 A	15 A
2213265-2 socket			

Mechanical

- **Operating temperature:** -40°C to 85°C
- **IP Seal Rating:** IP20
- **UV Resistant:** Black connectors only
- **Wire Termination:** Closed barrel pin & socket crimped terminals

Standards

- IEC 61535
- UL 1977

Product Specifications

3, 5, 6 & 7 position connector:

Application Specification: **108-20304**
Product Specification: **108-20324**

Pole configurations



3 Pole (L, N, ground)
5 Pole (L1, S1, S2, N, ground)
6 Pole (L1, L2, S1, S2, N, ground)
7 Pole (L1, L2, L3, S1, S2, N, ground)

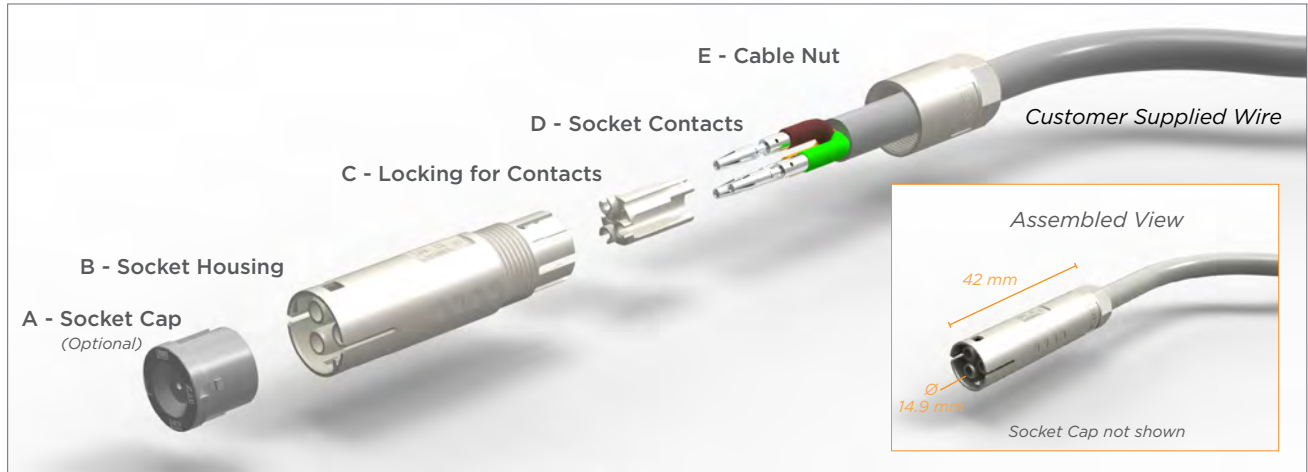

3 Pole Socket Connector, Free Hanging



Measurements are maximum dimensions. For more accurate dimensions, refer to the customer drawings.

A - Socket Cap	Color	TE Part Number
 293596*		293596-1*

C - Locking for Contacts	Color	TE Part Number
 293470*		293470-1*

B - Socket Housing	Color	TE Part Number	Keying Code
 293468		293468-1*	A***
		293468-2	B***
		293468-3	C***
		293468-4**	D***
		293468-5**	E***
		293468-6**	F***
		1-293468-1	A***
		1-293468-2	B***
		1-293468-3	C***
		1-293468-4**	D***
		1-293468-5**	E***
		1-293468-6**	F***

D - Socket Contacts	TE Part Number	Conductor Gauge
 293475 - metric 2213265 - AWG	293475-2*	1.5 mm ²
	1-293475-2*	2.5 mm ²
	2213265-5*	14 AWG
	1-2213265-2*	16-18 AWG

E - Cable Nut	Color	TE Part Number	Cable Dia. Range (mm ²)
 293607		293607-1*	7.50 - 8.40
		293607-2*	9.00 - 9.90
		293607-3	8.50 - 9.40
		293607-4	9.50 - 10.40
		1-293607-1	7.50 - 8.40
		1-293607-2	9.00 - 9.90
		1-293607-3	8.50 - 9.40
		1-293607-4	9.50 - 10.40

* Online Sample Room

** On Demand

*** For keying and tooling information, see application Specification 114-32150

3 Pole Pin Connector, Free Hanging

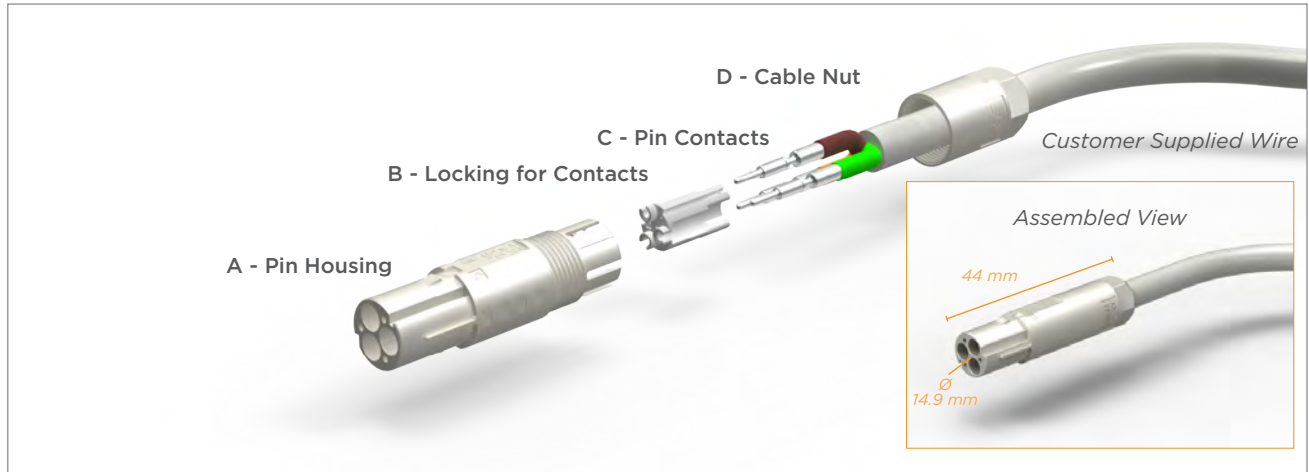

Measurements are maximum dimensions. For more accurate dimensions, refer to the customer drawings.

B - Pin Housing	Color	TE Part Number	Keying Code
 293469	Natural	293469-1*	A***
		293469-2	B***
		293469-3	C***
		293469-4**	D***
		293469-5**	E***
		293469-6**	F***
	Black	1-293469-1	A***
		1-293469-2	B***
		1-293469-3	C***
		1-293469-4**	D***
		1-293469-5**	E***
		1-293469-6**	F***

D - Cable Nut	Color	TE Part Number	Cable Dia. Range (mm ²)
 293607	Natural	293607-1*	7.50 - 8.40
		293607-2*	9.00 - 9.90
		293607-3	8.50 - 9.40
		293607-4	9.50 - 10.40
	Black	1-293607-1	7.50 - 8.40
		1-293607-2	9.00 - 9.90
		1-293607-3	8.50 - 9.40
		1-293607-4	9.50 - 10.40

B - Locking for Contacts	Color	TE Part Number
 293470	Natural	293470-1*

C - Pin Contacts	TE Part Number	Conductor Gauge
 293476 - metric 2213266 - AWG	293476-2*	1.5 mm ²
	1-293476-2*	2.5 mm ²
	2213266-5*	14 AWG
	1-2213266-2*	16-18 AWG

3 Pole T-Splitter Connector

T-Splitter	Color	TE Part Number	Keying Code
 293611	Natural	293611-1*	A***
		293611-2	B***
		293611-3	C***
		293611-4**	D***
		293611-5**	E***
		293611-6**	F***
	Black	1-293611-1	A***
		1-293611-2	B***
		1-293611-3	C***
		1-293611-4**	D***
		1-293611-5**	E***
		1-293611-6**	F***

* Online Sample Room



** On Demand

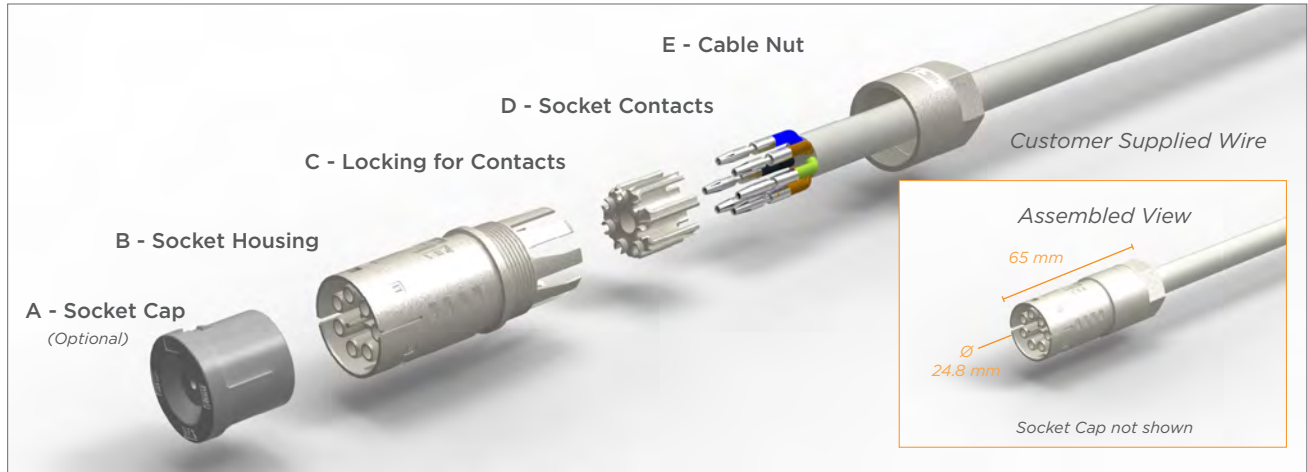

*** For keying and tooling information, see application Specification 114-32150

5, 6 & 7 Pole Socket Connector, Free Hanging





Measurements are maximum dimensions. For more accurate dimensions, refer to the customer drawings.



A - Socket Cap	Color	TE Part Number
 293682	 Gray	293682-1*

C - Locking for Contacts	Color	TE Part Number
 293658	 Natural	293658-1*

B - Socket Housing	
	293615 5 pole 293656 6 pole 293721 7 pole

D - Socket Contacts	TE Part Number	Conductor Gauge
 293475 - metric 2213265 - AWG	293475-2*	1.5 mm ²
	1-293475-2*	2.5 mm ²
	2213265-5*	14 AWG
	1-2213265-2*	16-18 AWG

	TE Part Number 5 pole	TE Part Number 6 pole	TE Part Number 7 pole	Keying Code
	293615-1*		293721-1*	A***
	293615-2		293721-2	B***
	293615-3*	293656-3*	293721-3	C***
	293615-4	293656-4	293721-4	D***
	293615-5	293656-5	293721-5	E***
	1-293615-1		1-293721-1	A***
	1-293615-2		1-293721-2	B***
	1-293615-3	1-293656-3	1-293721-3	C***
	1-293615-4	1-293656-4	1-293721-4	D***
	1-293615-5	1-293656-5	1-293721-5	E***

E - Cable Nut	Color	TE Part Number	Cable Size	Cable Dia. Range (mm ²)
 293660		293660-1*	6G x 1.5	9.60 - 9.80
		293660-2	6G x 2.5	11.00 - 11.20
		293660-3*	5G x 2.5 7G x 1.5	11.90 - 13.40
		293660-4	6G x 2.5	7.50 - 7.70
		293660-5	7G x 2.5	14.00 - 15.50
		293660-6*	5G x 1.5	9.70 - 11.20
		1-293660-1	6G x 1.5	9.60 - 9.80
		1-293660-2	6G x 2.5	11.00 - 11.20
		1-293660-3	5G x 2.5 7G 1.5	11.90 - 13.40
		1-293660-4	6G x 1.5	7.50 - 7.70
		1-293660-5	7G x 2.5	14.00 - 15.50
		1-293660-6	5G x 1.5	9.70 - 11.20

* Online Sample Room

** On Demand

*** For keying and tooling information, see application Specification 114-32150

5, 6 & 7 Pin Socket Connector, Free Hanging

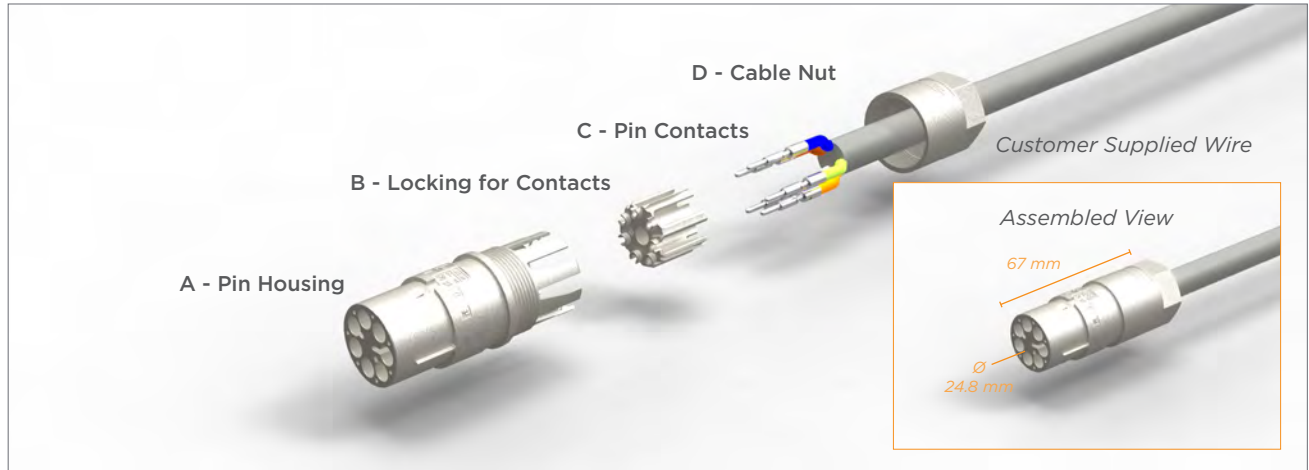

Measurements are maximum dimensions. For more accurate dimensions, refer to the customer drawings.

A - Pin Housing				
				293616 5 pole 293657 6 pole 293722 7 pole
Color	TE Part Number 5 pole	TE Part Number 6 pole	TE Part Number 7 pole	Keying Code
Natural	293616-1*		293722-1*	A***
	293616-2		293722-2	B***
	293616-3*	293657-3*	293722-3	C***
	293616-4	293657-4	293722-4	D***
	293616-5	293657-5	293722-5	E***
Black	1-293616-1		1-293722-1	A***
	1-293616-2		1-293722-2	B***
	1-293616-3	1-293657-3	1-293722-3	C***
	1-293616-4	1-293657-4	1-293722-4	D***
	1-293616-5	1-293657-5	1-293722-5	E***

B - Locking for Contacts	Color	TE Part Number
	Natural	293658-1*

C - Pin Contacts	TE Part Number	Conductor Gauge
	293476-2*	1.5 mm ²
	1-293476-2*	2.5 mm ²
	2213266-5*	14 AWG
	1-2213266-2*	16-18 AWG

293476 - metric
2213266 - AWG

D - Cable Nut	Color	TE Part Number	Cable Size	Cable Dia. Range (mm ²)
	Natural	293660-1*	6G x 1.5	9.60 - 9.80
		293660-2	6G x 2.5	11.00 - 11.20
		293660-3*	5G x 2.5 7G x 1.5	11.90 - 13.40
		293660-4	6G x 2.5	7.50 - 7.70
		293660-5	7G x 2.5	14.00 - 15.50
		293660-6	5G x 1.5	9.70 - 11.20
	Black	1-293660-1	6G x 1.5	9.60 - 9.80
		1-293660-2	6G x 2.5	11.00 - 11.20
		1-293660-3	5G x 2.5 7G 1.5	11.90 - 13.40
		1-293660-4	6G x 1.5	7.50 - 7.70
		1-293660-5	7G x 2.5	14.00 - 15.50
		1-293660-6	5G x 1.5	9.70 - 11.20

5 Pole T-Splitter Connector

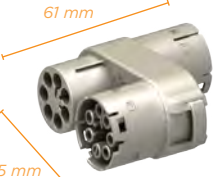
T-Splitter	Color	TE Part Number	Keying Code
	Natural	1879995-1*	A***
		1879995-2	B***
		1879995-3	C***
		1879995-4	D***
		1879995-5	E***
	Black	1-1879995-1	A***
		1-1879995-2	B***
		1-1879995-3	C***
		1-1879995-4	D***
		1-1879995-5	E***

Measurements are maximum dimensions. For more accurate dimensions, refer to the customer drawings.

* Online Sample Room

*** For keying and tooling information, see application Specification 114-32150

3 Pole Panel Mount Socket Connector



Measurements are maximum dimensions. For more accurate dimensions, refer to the customer drawings.

A - Screw Nut		Color	TE Part Number
 293481		Natural	293481-1*
		Black	1-293481-1

C - Locking for Contacts		Color	TE Part Number
 293470		Natural	293470-1*

B - Panel Mount Socket Housing		Color	TE Part Number	Keying Code
 293606	Natural		293606-1*	A***
			293606-2	B***
			293606-3	C***
			293606-4**	D***
			293606-5**	E***
			293606-6**	F***
	Black		1-293606-1	A***
			1-293606-2	B***
			1-293606-3	C***
			1-293606-4**	D***
			1-293606-5**	E***
			1-293606-6**	F***

D - Socket Contacts		TE Part Number	Conductor Gauge
 293475 - metric 2213265 - AWG		293475-2*	1.5 mm ²
		1-293475-2*	2.5 mm ²
		2213265-5*	14 AWG
		1-2213265-2*	16-18 AWG

* Online Sample Room

** On Demand

*** For keying and tooling information, see application Specification 114-32150

3 Pole Panel Mount Pin Connector

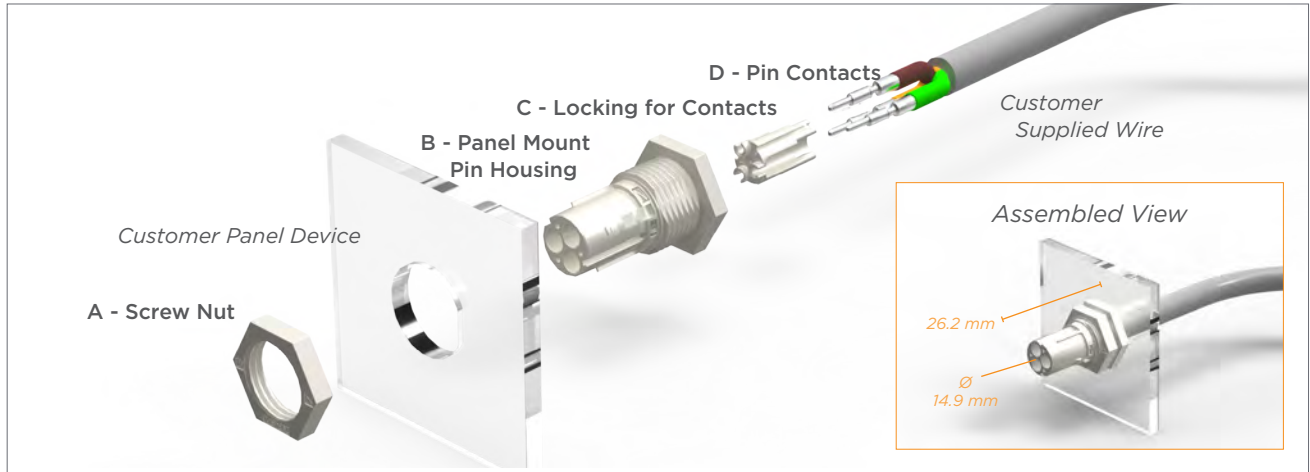

Measurements are maximum dimensions. For more accurate dimensions, refer to the customer drawings.

A - Screw Nut		Color	TE Part Number
 293481		Natural	293481-1*
		Black	1-293481-1

C - Locking for Contacts		Color	TE Part Number
 293470		Natural	293470-1*

B - Panel Mount Pin Housing		Color	TE Part Number	Keying Code
 293469	Natural	293598-1*	A***	
		293598-2	B***	
		293598-3	C***	
		293598-4**	D***	
		293598-5**	E***	
		293598-6**	F***	
	Black	1-293598-1	A***	
		1-293598-2	B***	
		1-293598-3	C***	
		1-293598-4**	D***	
		1-293598-5**	E***	
		1-293598-6**	F***	

D - Pin Contacts		TE Part Number	Conductor Gauge
 293476 - metric 2213266 - AWG	293476-2*	1.5 mm ²	
	1-293476-2*	2.5 mm ²	
	2213266-5*	14 AWG	
	1-2213266-2*	16-18 AWG	

* Online Sample Room

** On Demand

*** For keying and tooling information, see application Specification 114-32150

5, 6 & 7 Pole Panel Mount Socket Connector

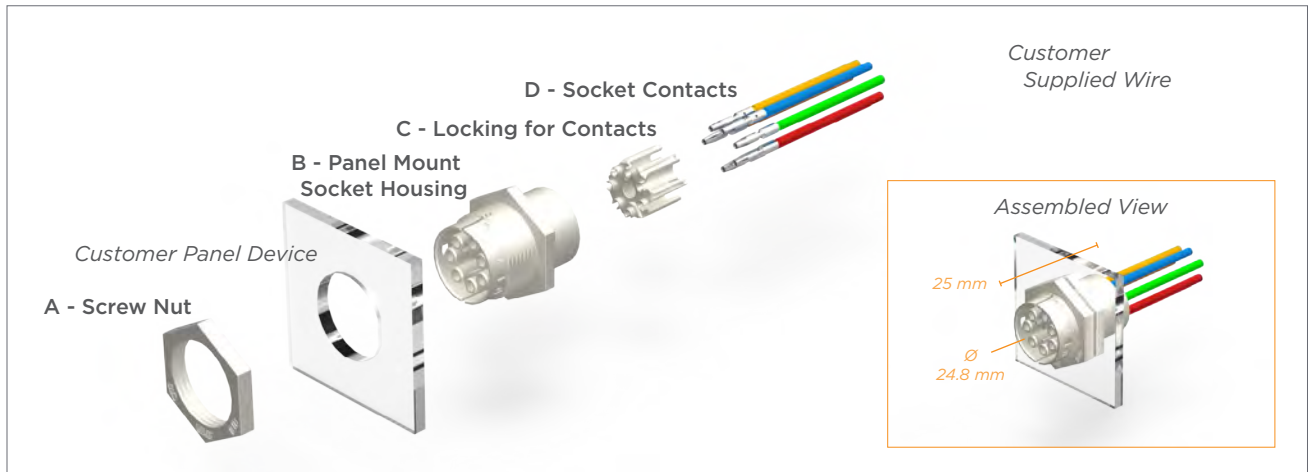

Measurements are maximum dimensions. For more accurate dimensions, refer to the customer drawings.

A - Screw Nut		Color	TE Part Number
 293708		Natural	293708-1*
		Black	1-293708-1

C - Locking for Contacts		Color	TE Part Number
 293658		Natural	293658-1*
		Black	

B - Panel Mount Socket Housing				
	293687		5 pole	
	293673		6 pole	
	293773		7 pole	
	TE Part Number 5 pole	TE Part Number 6 pole	TE Part Number 7 pole	Keying Code
Natural	293687-1*		293773-1*	A***
	293687-2		293773-2	B***
	293687-3*	293673-3*	293773-3	C***
	293687-4	293673-4	293773-4	D***
	293687-5	293673-5	293773-5	E***
Black	1-293687-1		1-293773-1	A***
	1-293687-2		1-293773-2	B***
	1-293687-3	1-293673-3	1-293773-3	C***
	1-293687-4	1-293673-4	1-293773-4	D***
	1-293687-5	1-293673-5	1-293773-5	E***

D - Socket Contacts		TE Part Number	Conductor Gauge
 293475 - metric 2213265 - AWG	293475-2*		1.5 mm ²
	1-293475-2*		2.5 mm ²
	2213265-5*		14 AWG
	1-2213265-2*		16-18 AWG

* Online Sample Room

*** For keying and tooling information, see application Specification 114-32150

5, 6 & 7 Pole Panel Mount Pin Connector

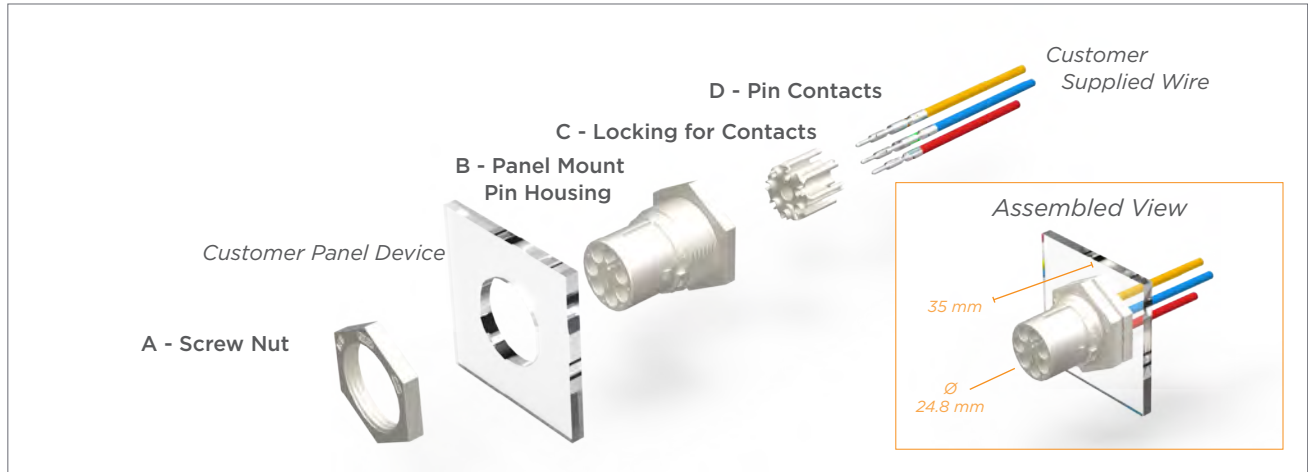

Measurements are maximum dimensions. For more accurate dimensions, refer to the customer drawings.

A - Screw Nut		Color	TE Part Number
 293708		Natural	293708-1*
		Black	1-293708-1

C - Locking for Contacts		Color	TE Part Number
 293658		Natural	293658-1*
		Black	

B - Panel Mount Pin Housing	
	293688 5 pole
	293674 6 pole
	293774 7 pole

D - Pin Contacts		TE Part Number	Conductor Gauge
 293476 - metric 2213266 - AWG		293476-2*	1.5 mm ²
		1-293476-2*	2.5 mm ²
		2213266-5*	14 AWG
		1-2213266-2*	16-18 AWG

Color	TE Part Number 5 pole	TE Part Number 6 pole	TE Part Number 7 pole	Keying Code
Natural	293688-1*		293774-1*	A***
	293688-2		293774-2	B***
	293688-3*	293674-3*	293774-3	C***
	293688-4	293674-4	293774-4	D***
	293688-5	293674-5	293774-5	E***
Black	1-293688-1		1-293774-1	A***
	1-293688-2		1-293774-2	B***
	1-293688-3	1-293674-3	1-293774-3	C***
	1-293688-4	1-293674-4	1-293774-4	D***
	1-293688-5	1-293674-5	1-293774-5	E***

* Online Sample Room

*** For keying and tooling information, see application Specification 114-32150

3 Pole PCB Mounted Socket & Pin Headers

A - Vertical PCB Socket Header

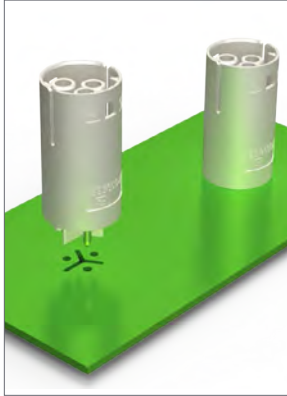

B - Horizontal PCB Socket Header

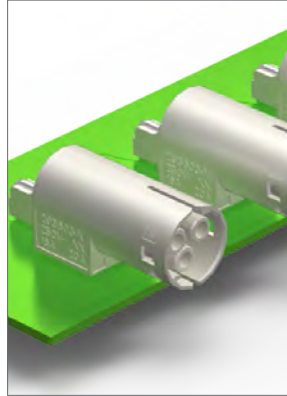

A - Vertical PCB Pin Header

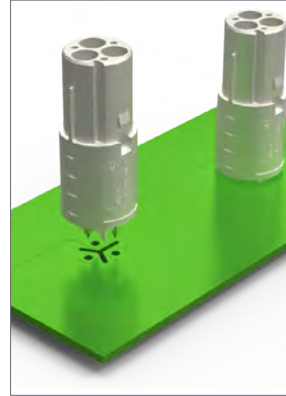

B - Horizontal PCB Pin Header

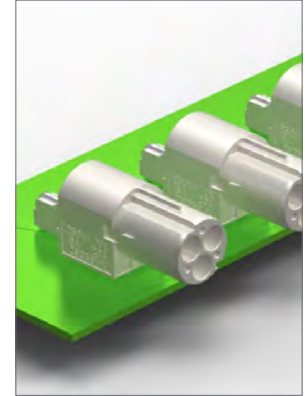

A - Vertical PCB Socket	Color	TE Part Number	Keying Code
<p>293602</p>	Natural	293602-1*	A***
		293602-2	B***
		293602-3	C***
		293602-4**	D***
		293602-5**	E***
		293602-6**	F***

Measurements are maximum dimensions. For more accurate dimensions, refer to the customer drawings.

A - Vertical PCB Pin	Color	TE Part Number	Keying Code
<p>293590</p>	Natural	293590-1*	A***
		293590-2	B***
		293590-3	C***
		293590-4**	D***
		293590-5**	E***
		293590-6**	F***

Measurements are maximum dimensions. For more accurate dimensions, refer to the customer drawings.

B - Horizontal PCB Socket	Color	TE Part Number	Keying Code
<p>293605</p>	Natural	293605-1*	A***
		293605-2	B***
		293605-3	C***
		293605-4**	D***
		293605-5**	E***
		293605-6**	F***

Measurements are maximum dimensions. For more accurate dimensions, refer to the customer drawings.

B - Horizontal PCB Pin	Color	TE Part Number	Keying Code
<p>293593</p>	Natural	293593-1*	A***
		293593-2	B***
		293593-3	C***
		293593-4**	D***
		293593-5**	E***
		293593-6**	F***

Measurements are maximum dimensions. For more accurate dimensions, refer to the customer drawings.

* Online Sample Room

** On Demand

*** For keying and tooling information, see application Specification 114-32150

5 & 6 Pole PCB Mounted Socket & Pin Headers

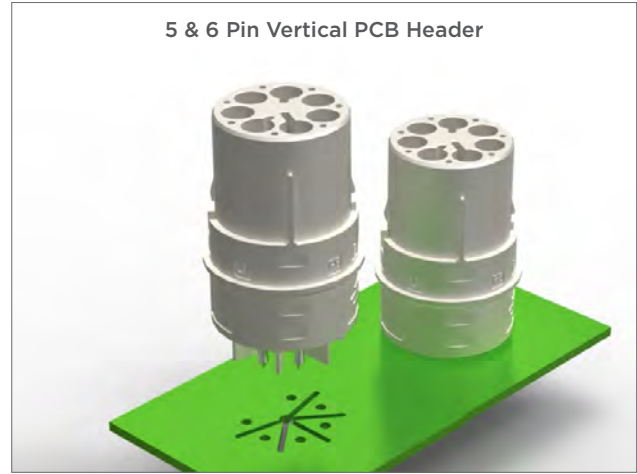

Vertical PCB Socket Header

34 mm

24.8 mm

293696	5 pole
293671	6 pole

Measurements are maximum dimensions. For more accurate dimensions, refer to the customer drawings.

TE Part Number 5 pole	TE Part Number 6 pole	Color	Keying Code
293696-1*		Natural	A***
293696-2		Natural	B***
293696-3	293671-3*	Natural	C***
293696-4	293671-4	Natural	D***
293696-5	293671-5	Natural	E***

Vertical PCB Pin Header

27.9 mm

24.8 mm

293695	5 pole
293672	6 pole

Measurements are maximum dimensions. For more accurate dimensions, refer to the customer drawings.

TE Part Number 5 pole	TE Part Number 6 pole	Color	Keying Code
293695-1*		Natural	A***
293695-2		Natural	B***
293695-3*	293672-3*	Natural	C***
293695-4	293672-4	Natural	D***
293695-5	293672-5	Natural	E***

* Online Sample Room
 ** On Demand
 *** For keying and tooling information, see application Specification 114-32150



NECTOR M Sealed Power System

The NECTOR M SEALED product portfolio offers a complete range of 3, 5, 6 and 7 pole pluggable electrical installation components with free hanging (Crimp contact & Field installable contacts), panel/chassis mount and power splitter solution. The sealed portfolio is IP67 rated, which makes it an ideal solution for outdoor (e.g. Street lighting) and high humidity application (e.g. greenhouses, parking garages & shipbuilding).

NECTOR M SEALED

Electrical

- **Operating Voltage:** 400 VAC IEC rating
600 VAC UL rating
- **Operating current:**

Contact Part Number	Contact Type	Wire Conductor Size	Single Phase Circuit Max Current	Multi-phase Circuit Max Current			
1-2213265-2 socket	Crimp	18AWG	7 A	7 A			
1-2213266-2 pin							
1-2213231-1 socket	Screw Contact						
1-2213234-1 pin							
1-2213265-2 socket	Crimp				16AWG	10 A	10 A
1-2213266-2 pin							
1-2213231-1 socket	Screw Contact						
1-2213234-1 pin							
2213265-5 socket	Crimp	14AWG	15 A	15 A			
2213266-5 pin							
1-2213231-1 socket	Screw Contact						
1-2213234-1 pin							
2213657-2 pin	Crimp				1.5 mm ²	16 A	10 A
2213656-2 socket							
1-2213231-1 socket	Screw Contact						
1-2213234-1 pin							
1-2213656-2 socket	Crimp	2.5 mm ²	20 A	16 A			
1-2213657-2 pin							
1-2213231-1 socket	Screw Contact						
1-2213234-1 pin							

Mechanical

- **Operating temperature:** -40°C to 85°C
- **IP Seal Rating:** IP67
- **UV Resistant:** Yes
- **Wire Termination Type:** Closed barrel pin & socket crimped terminals
Closed barrel pin & socket screw terminals (Field Installable version)

Standards

- IEC 61535
- UL 1977

Product Specifications

3, 5, 6 & 7 position connector:

- Application Specification: **114-32111**
- Product Specification: **108-133014**

Pole configurations

- 3 Pole (L, N, ground)
- 5 Pole (L1, S1, S2, N, ground)
- 6 Pole (L1, L2, S1, S2, N, ground)
- 7 Pole (L1, L2, L3, S1, S2, N, ground)

3 Pole Socket Connector, Free Hanging, Sealed

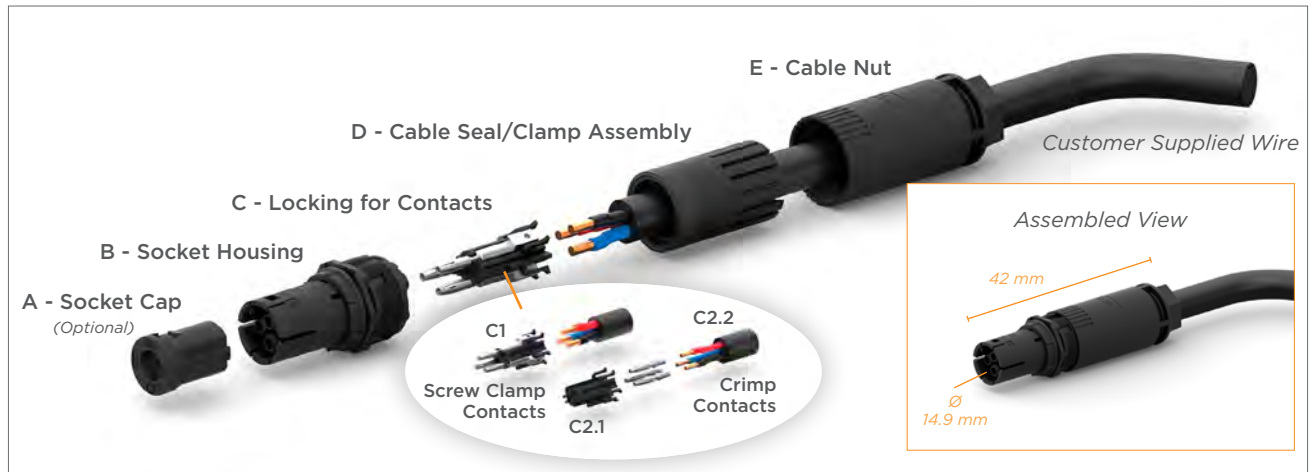



Measurements are maximum dimensions. For more accurate dimensions, refer to the customer drawings.

A - Socket Cap	TE Part Number
	2213587-1*

D - Cable Seal/Clamp Assembly	TE Part Number	Cable Diameter Range
	2213410-1*	8-11 mm outer Dia
	2213410-2	11-14 mm outer Dia

B - Socket Housing	TE Part Number	Keying Code
	2213428-1*	A***
	2213428-2	B***
	22213428-3	C***
	2213428-4	D***
	2213428-5	E***
	2213428-6	F***

E - Cable Ring Nut	TE Part Number	Cable Diameter Range
	2213413-1*	8-11 mm outer Dia
	2213413-2	11-14 mm outer Dia

C1 - Locking Assembly with Field Installable Screw Contacts	TE Part Number	Type
	2213427-1*	UL Version (14-18 AWG)
	1-2213427-1	IEC Version (1.5-2.5mm ²)

C2.1 - Locking for Crimp Contacts	TE Part Number
	1-2213396-1

C2.2 - Socket Crimp Contacts	TE Part Number	Wire Type
	2213265-5*	14 AWG
	1-2213265-2*	16-18 AWG
	2213656-2*	1.5 mm ²
	1-2213656-2*	2.5 mm ²

* Online Sample Room

*** For keying and tooling information, see application Specification 114-32111

3 Pole Pin Connector, Free Hanging, Sealed

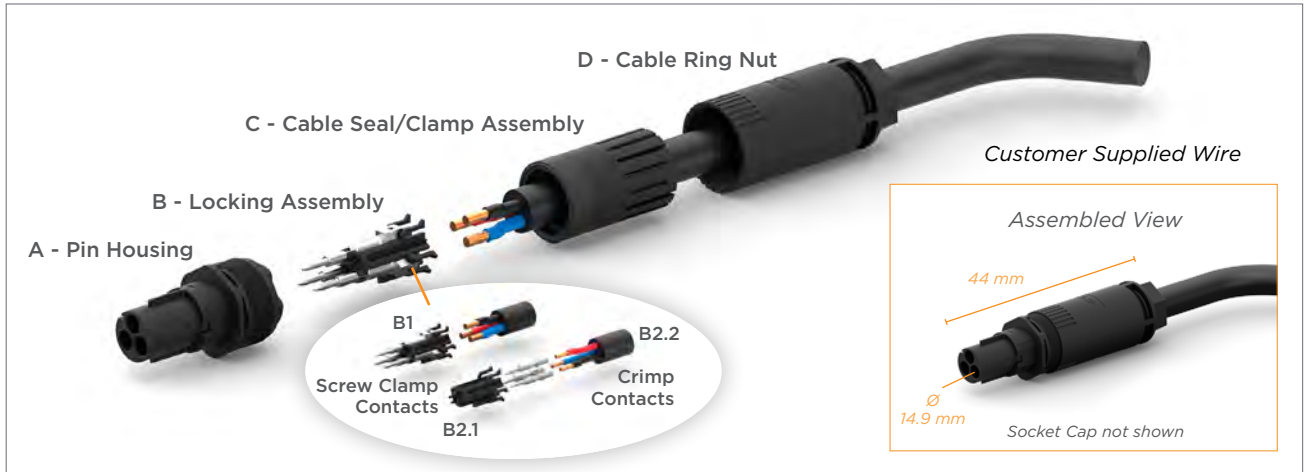



Measurements are maximum dimensions. For more accurate dimensions, refer to the customer drawings.

A - Pin Housing	TE Part Number	Keying Code
	2213414-1*	A***
	2213414-2	B***
	2213414-3	C***
	2213414-4	D***
	2213414-5	E***
	2213414-6	F***

C - Cable Seal/Clamp Assembly	TE Part Number	Cable Diameter Range
	2213410-1*	8-11 mm outer Dia
	2213410-2	11-14 mm outer Dia

D - Cable Ring Nut	TE Part Number	Cable Diameter Range
	2213413-1*	8-11 mm outer Dia
	2213413-2	11-14 mm outer Dia

B1 - Locking Assembly with Field Installable Screw Contacts		
	TE Part Number	Type
	2213395-1*	UL Version (14-18 AWG)
	1-2213395-1	IEC Version (1.5-2.5mm ²)

B2.1 - Locking for Crimp Contacts	TE Part Number
	1-2213396-1*

B2.2 - Pin Crimp Contacts	TE Part Number	Wire Type
	2213266-5*	14 AWG
	1-2213266-2*	16-18 AWG
	2213657-2*	1.5 mm ²
	1-2213657-2*	2.5 mm ²

* Online Sample Room

*** For keying and tooling information, see application Specification 114-32111

5, 6 & 7 Pole Socket Connector, Free Hanging, Sealed

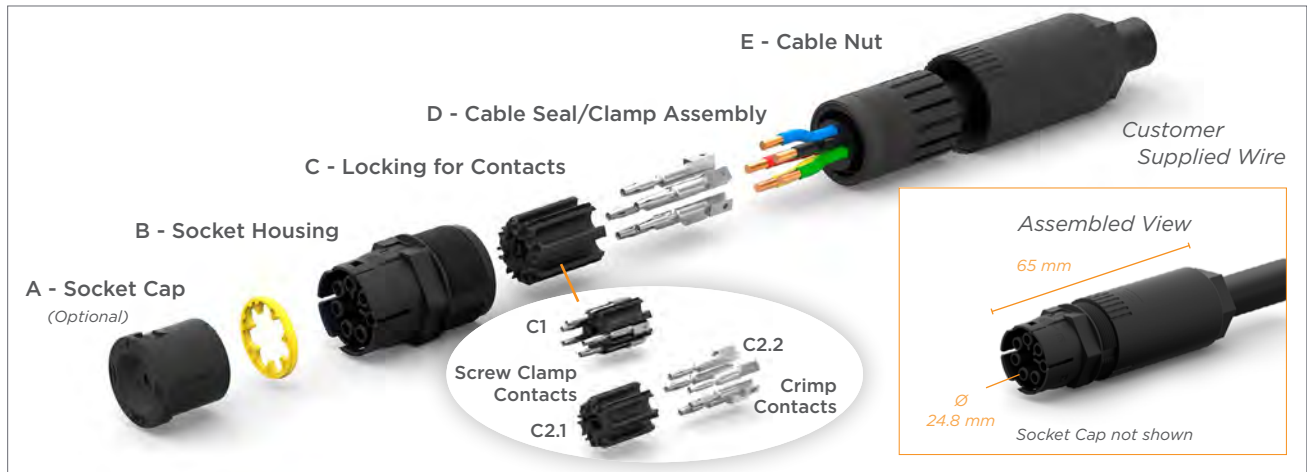



Measurements are maximum dimensions. For more accurate dimensions, refer to the customer drawings.

A - Socket Cap	TE Part Number
	2213588-1*

C2.2 - Socket Crimp Contacts	TE Part Number	Wire Type
	2213265-5*	14 AWG
	1-2213265-2*	16-18 AWG
	2213656-2*	1.5 mm ²
	1-2213656-2*	2.5 mm ²

B - Socket Housing			
		2213230	5 pole
		2213239	6 pole
		2213240	7 pole
TE Part Number 5 pole	TE Part Number 6 pole	TE Part Number 7 pole	Keying Code
2213230-1*	2213239-1*	2213240-1*	A***
2213230-2	2213239-2	2213240-2	B***
2213230-3	2213239-3	2213240-3	C***
2213230-4	2213239-4	2213240-4	D***
2213230-5	2213239-5	2213240-5	E***

D - Cable Seal/Clamp Assembly	TE Part Number	Cable Diameter Range
	2213351-1*	11-14 mm outer Dia
	2213351-2	14-17 mm outer Dia

C1 - Locking Assembly with Field Installable Screw Contacts	TE Part Number	Type
	2213231-1* (5 pole)	UL Version (14-18 AWG)
	1-2213231-1 (5 pole)	IEC Version (1.5-2.5mm ²)

E - Cable Ring Nut	TE Part Number	Cable Diameter Range
	2213229-1*	11-14 mm outer Dia
	2213229-2	14-17 mm outer Dia

C2.1 - Locking for Crimp Contacts	TE Part Number
	2213226-3*

* Online Sample Room

*** For keying and tooling information, see application Specification 114-32111

For 6 and 7 pole, please contact TE support.

5, 6 & 7 Pin Socket Connector, Free Hanging, Sealed

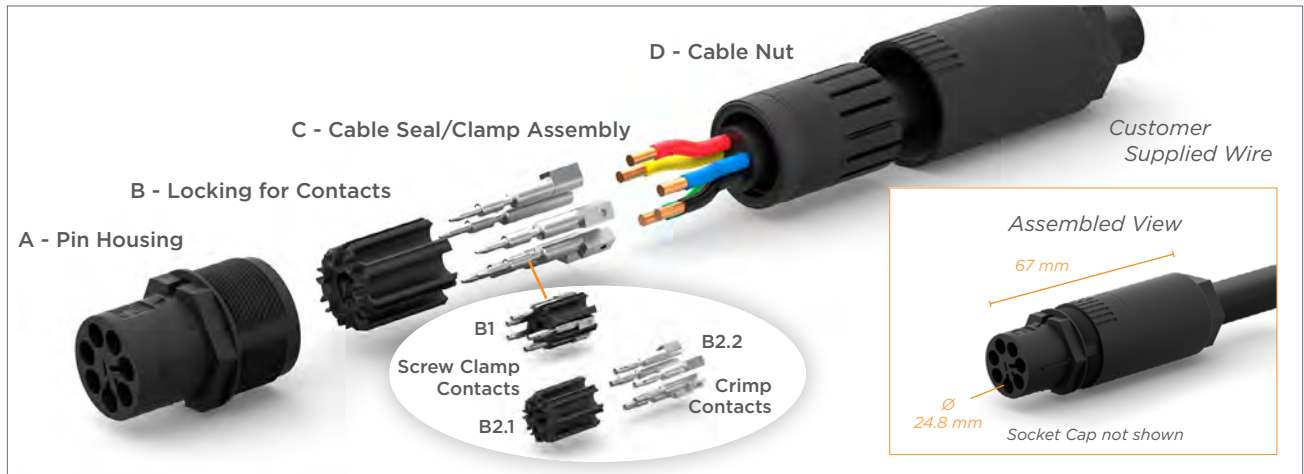

Measurements are maximum dimensions. For more accurate dimensions, refer to the customer drawings.

A - Socket Housing			
		2213228	5 pole
		2213241	6 pole
		2213242	7 pole
TE Part Number 5 pole	TE Part Number 6 pole	TE Part Number 7 pole	Keying Code
2213228-1*	2213241-1*	2213242-1*	A***
2213228-2	2213241-2	2213242-2	B***
2213228-3	2213241-3	2213242-3	C***
2213228-4	2213241-4	2213242-4	D***
2213228-5	2213241-5	2213242-5	E***

B2.2 - Pin Crimp Contacts	TE Part Number	Wire Type
	2213266-5*	14 AWG
	1-2213266-2*	16-18 AWG
	2213657-2*	1.5 mm ²
	1-2213657-2*	2.5 mm ²

C - Cable Seal/Clamp Assembly	TE Part Number	Cable Diameter Range
	2213351-1*	11-14 mm outer Dia
	2213351-2	14-17 mm outer Dia

B1 - Locking Assembly with Field Installable Screw Contacts	TE Part Number	Type
	2213234-1 (5 pole)	UL Version (14-18 AWG)
	1-2213234-1 (5 pole)	IEC Version (1.5-2.5mm ²)

D - Cable Ring Nut	TE Part Number	Cable Diameter Range
	2213229-1*	11-14 mm outer Dia
	2213229-2	14-17 mm outer Dia

B2.1 - Locking for Crimp Contacts	TE Part Number
	2213226-3*

* Online Sample Room

*** For keying and tooling information, see application Specification 114-32111

3 Pole Panel Mount Socket Connector, Sealed

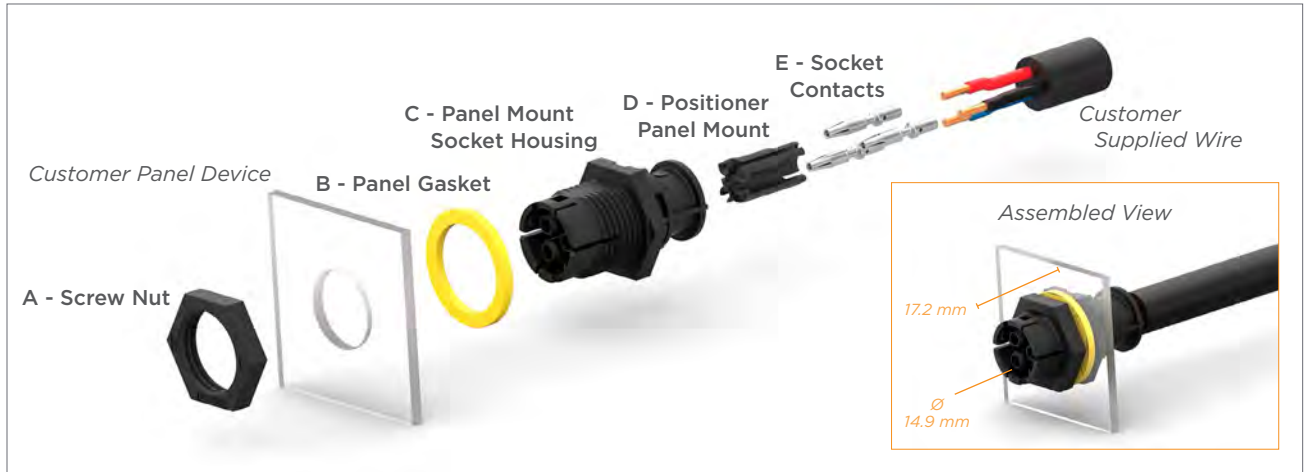

Measurements are maximum dimensions. For more accurate dimensions, refer to the customer drawings.

A - Screw Nut	TE Part Number
	2213466-1*

B - Panel Gasket	TE Part Number
	299139-1*

C - Panel Mount Socket Housing	TE Part Number	Keying Code
	2213468-1*	A***
2213468-2	B***	
2213468-3	C***	
2213468-4	D***	
2213468-5	E***	
2213468-6	F***	

D - Positioner Panel Mount	TE Part Number
	293470-1*

E - Socket Crimp Contacts	TE Part Number	Wire Type
	2213265-5*	14 AWG
1-2213265-2	16-18 AWG	
2213656-2	1.5 mm ²	
1-2213656-2	2.5 mm ²	

3 Pole T-Splitter Connector

T-Splitter	TE Part Number	Keying Code
	2213434-1*	A***
2213434-2	B***	
2213434-3	C***	
2213434-4	D***	
2213434-5	E***	
2213434-6	F***	

* Online Sample Room

** On Demand

*** For keying and tooling information, see application Specification 114-32111

3 Pole Panel Mount Pin Connector, Sealed

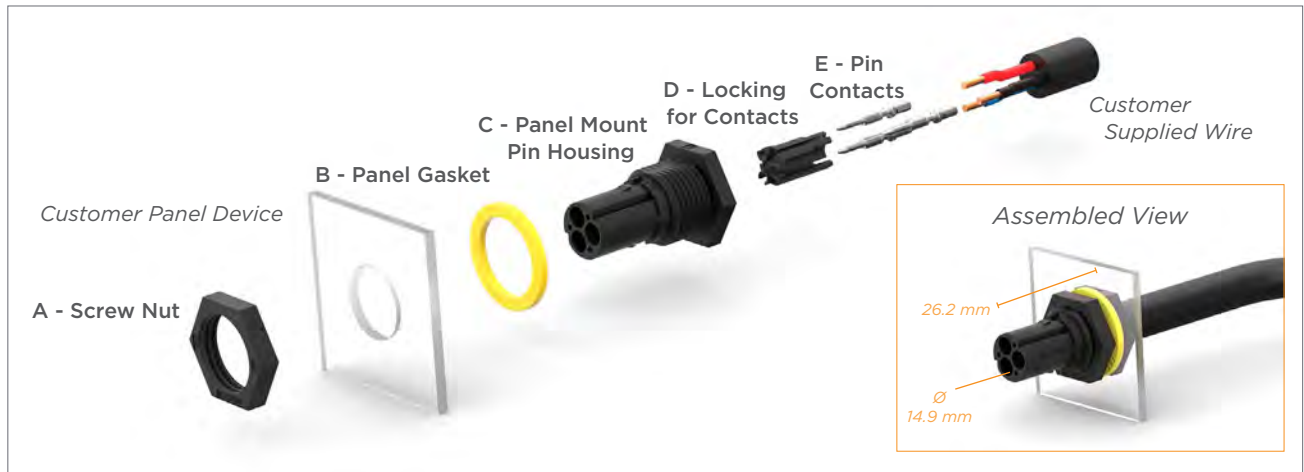

Measurements are maximum dimensions. For more accurate dimensions, refer to the customer drawings.

A - Screw Nut	TE Part Number
	2213466-1*

D - Locking for Contacts	TE Part Number
	293470-1*

B - Panel Gasket	TE Part Number
	299139-1*

E - Pin Crimp Contacts	TE Part Number	Wire Type
	2213266-5*	14 AWG
	1-2213266-2*	16-18 AWG
	2213657-2*	1.5 mm ²
	1-2213657-2*	2.5 mm ²

C - Panel Mount Pin Housing	TE Part Number	Keying Code
	2213464-1*	A***
	2213464-2	B***
	2213464-3	C***
	2213464-4	D***
	2213464-5	E***
	2213464-6	F***

* Online Sample Room

*** For keying and tooling information, see application Specification 114-32111

5, 6 & 7 Pole Panel Mount Socket Connector, Sealed





Measurements are maximum dimensions. For more accurate dimensions, refer to the customer drawings.

A - Screw Nut	TE Part Number
	2213430-1*

D - Locking for Contacts	TE Part Number
	293658-1*

B - Panel Gasket	TE Part Number
	2213223-1*

E - Socket Crimp Contacts	TE Part Number	Wire Type
	2213265-5*	14 AWG
	1-2213265-2*	16-18 AWG
	2213656-2*	1.5 mm ²
	1-2213656-2*	2.5 mm ²

C - Panel Mount Socket Housing			
		2213225	5 pole
		2213262	6 pole
		2213263	7 pole
TE Part Number 5 pole	TE Part Number 6 pole	TE Part Number 7 pole	Keying Code
2213225-1*	2213262-1*	2213263-1*	A**
2213225-2	2213262-2	2213263-2	B**
2213225-3	2213262-3	2213263-3	C**
2213225-4	2213262-4	2213263-4	D**
2213225-5	2213262-5	2213263-5	E**

* Online Sample Room

** For keying and tooling information, see application Specification 114-32111

5, 6 & 7 Pole Panel Mount Pin Connector, Sealed

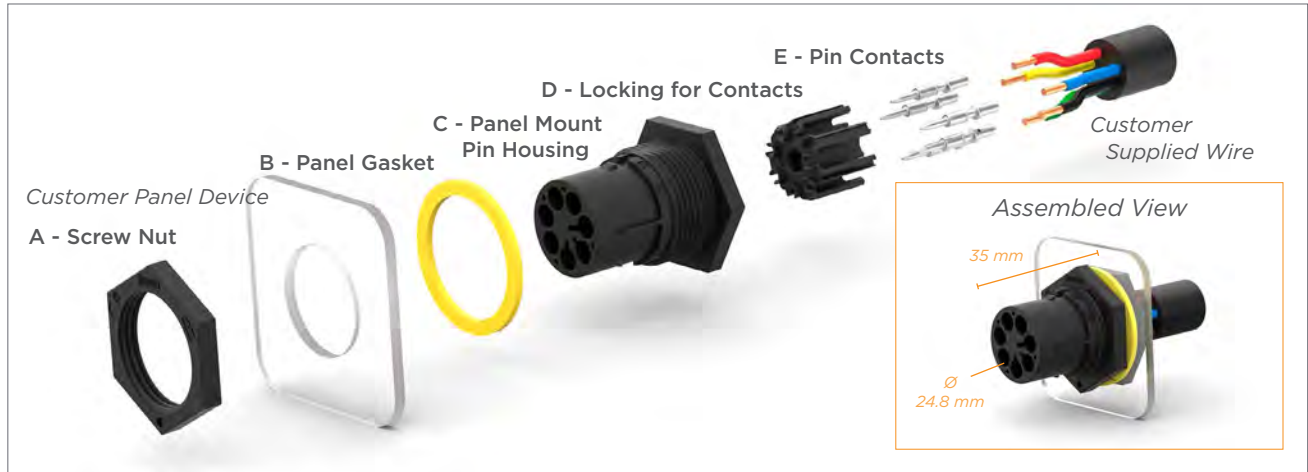

Measurements are maximum dimensions. For more accurate dimensions, refer to the customer drawings.

A - Screw Nut	TE Part Number
	2213430-1*

B - Panel Gasket	TE Part Number
	2213223-1*

C - Panel Mount Pin Housing	TE Part Number	Pole Count
	2213394	5 pole
	2213393	6 pole
	2213392	7 pole

TE Part Number	TE Part Number	TE Part Number	Keying Code
5 pole	6 pole	7 pole	
2213394-1*	2213393-1*	2213392-1*	A
2213394-2	2213393-2	2213392-2	B
2213394-3	2213393-3	2213392-3	C
2213394-4	2213393-4	2213392-4	D
2213394-5	2213393-5	2213392-5	E

D - Locking for Contacts	TE Part Number
	293658-1*

E - Pin Crimp Contacts	TE Part Number	Wire Type
	2213266-5*	14 AWG
	1-2213266-2*	16-18 AWG
	2213657-2*	1.5 mm ²
	1-2213657-2*	2.5 mm ²

5, 6 & 7 Pole T-Splitter Connector

T-Splitter	TE Part Number	Keying Code
	1879999-1	A***
	1879999-2	B***
	1879999-3	C***
	1879999-4	D***
	1879999-5	E***
	1879999-6	F***

Measurements are maximum dimensions. For more accurate dimensions, refer to the customer drawings.

* Online Sample Room

** On Demand

*** For keying and tooling information, see application Specification 114-32111



NECTOR M Sealed Cable Assemblies

Our engineers will design the cable assembly solution to meet your application needs for power, distance, and error proofing. We leverage over 70 years of manufacturing and product development expertise to ensure product quality and create customized supply chain solutions to meet your critical delivery needs.

COMMERCIAL



INDUSTRIAL



ENTERTAINMENT



RETAIL



PARKING



Double-ended Cable Assembly



	TE Part Number	Description	Configuration	Keying Code	Wire Type
3 Position	2829460-1*	Sealed 3p Pin to 3p Socket	Double Ended, 4ft 1 to 1	A***	H07RN-F 14/3
	2829461-1*	Sealed 3p Pin to 3p Socket	Double Ended, 4ft 1 to 1	A***	SE00W 14/3C
5, 6, 7 Position	2829488-1*	Sealed 5p Pin to 5p Socket	Double Ended, 4ft, 1 to 1	A***	H07RN-F 14/5
	2829489-1*	Sealed 5p Pin to 5p Socket	Double Ended, 4ft, 1 to 1	A***	SE00W 14/5C

Single-ended Cable Assembly

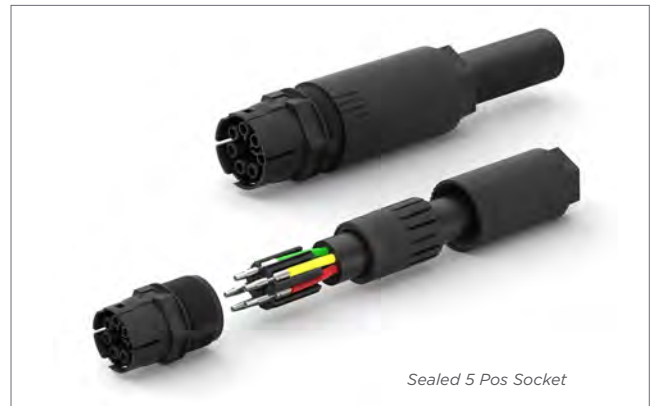

	TE Part Number	Description	Configuration	Keying Code	Wire Type
3 Position	2829462-1*	Sealed 3p Pin	Single Ended, 2ft	A***	H07RN-F 14/3
	2829463-1*	Sealed 3p Pin	Single Ended, 2ft	A***	SE00W 14/3C
	2829464-1*	Sealed 3p Socket	Single Ended, 2ft	A***	SE00W 14/3C
	2829465-1*	Sealed 3p Socket	Single Ended, 2ft	A***	H07RN-F 14/3
5, 6, 7 Position	2829490-1*	Sealed 5p Pin	Singled Ended, 2ft	A***	H07RN-F 14/5
	2829491-1*	Sealed 5p Pin	Singled Ended, 2ft	A***	SE00W 14/5C
	2829492-1*	Sealed 5p Socket	Singled Ended, 2ft	A***	H07RN-F 14/5
	2829493-1*	Sealed 5p Socket	Singled Ended, 2ft	A***	SE00W 14/5C

* Online Sample Room

*** Additional Keying Options Upon Request

Panel Mount Cable Assembly

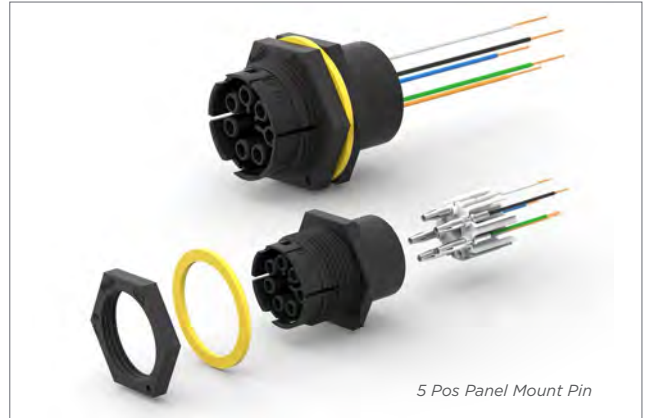

	TE Part Number	Description	Configuration	Keying Code	Wire Type
3 Position	2829470-1*	3p Panel Mount Pin	Panel Mount, 1.3ft	A***	H05V-K 18AWG
	2829471-1*	3p Panel Mount Pin	Panel Mount, 1.3ft	A***	UL1316/1452 18AWG
	2829472-1*	3p Panel Mount Socket	Panel Mount, 1.3ft	A***	H05V-K 18AWG
	2829473-1*	3p Panel Mount Socket	Panel Mount, 1.3ft	A***	UL1316/1452 18AWG
5, 6, 7 Position	2829494-1*	5p Panel Mount Pin	Panel Mount, 1.3ft	A***	H05V-K 18AWG
	2829495-1*	5p Panel Mount Pin	Panel Mount, 1.3ft	A***	UL1316/1452 18AWG
	2829496-1*	5p Panel Mount Socket	Panel Mount, 1.3ft	A***	H05V-K 18AWG
	2829497-1*	5p Panel Mount Socket	Panel Mount, 1.3ft	A***	UL1316/1452 18AWG

* Online Sample Room

*** Additional Keying Options Upon Request

LET'S CONNECT

We make it easy to connect with our experts and are ready to provide all the support you need. Just call your local support number or visit te.com/industrial to chat with a Product Information Specialist.

Technical Support

te.com/support-center

FOR MORE INFORMATION

nectorpower.com

TE Technical Support Center

Internet:	te.com/help
USA:	+1 (800) 522-6752
Canada:	+1 (905) 475-6222
Mexico	+52 (0) 55-1106-0800
Latin/S. America:	+54 (0) 11-4733-2200
Germany:	+49 (0) 6251-133-1999
UK:	+44 (0) 800-267666
France:	+33 (0) 1-3420-8686
Netherlands:	+31 (0) 73-6246-999
China:	+86 (0) 400-820-6015

Part numbers in this brochure are RoHS Compliant*, unless marked otherwise.

*as defined www.te.com/leadfree

te.com

© 2016 TE Connectivity Ltd. Company. All Rights Reserved.

5-1773465-6 JN 01/2016

NECTOR, TE, TE Connectivity and the TE connectivity (logo) are trademarks of the TE Connectivity Ltd. family of companies. Other logos, product and Company names mentioned herein may be trademarks of their respective owners. While TE has made every reasonable effort to ensure the accuracy of the information in this brochure, TE does not guarantee that it is error-free, nor does TE make any other representation, warranty or guarantee that the information is accurate, correct, reliable or current. TE reserves the right to make any adjustments to the information contained herein at any time without notice. TE expressly disclaims all implied warranties regarding the information contained herein, including, but not limited to, any implied warranties of merchantability or fitness for a particular purpose. The dimensions in this brochure are for reference purposes only and are subject to change without notice. Specifications are subject to change without notice. Consult TE for the latest dimensions and design specifications.

Данный компонент на территории Российской Федерации

Вы можете приобрести в компании MosChip.

Для оперативного оформления запроса Вам необходимо перейти по данной ссылке:

<http://moschip.ru/get-element>

Вы можете разместить у нас заказ для любого Вашего проекта, будь то серийное производство или разработка единичного прибора.

В нашем ассортименте представлены ведущие мировые производители активных и пассивных электронных компонентов.

Нашей специализацией является поставка электронной компонентной базы двойного назначения, продукции таких производителей как XILINX, Intel (ex.ALTERA), Vicor, Microchip, Texas Instruments, Analog Devices, Mini-Circuits, Amphenol, Glenair.

Сотрудничество с глобальными дистрибьюторами электронных компонентов, предоставляет возможность заказывать и получать с международных складов практически любой перечень компонентов в оптимальные для Вас сроки.

На всех этапах разработки и производства наши партнеры могут получить квалифицированную поддержку опытных инженеров.

Система менеджмента качества компании отвечает требованиям в соответствии с ГОСТ Р ИСО 9001, ГОСТ РВ 0015-002 и ЭС РД 009

Офис по работе с юридическими лицами:

105318, г.Москва, ул.Щербаковская д.3, офис 1107, 1118, ДЦ «Щербаковский»

Телефон: +7 495 668-12-70 (многоканальный)

Факс: +7 495 668-12-70 (доб.304)

E-mail: info@moschip.ru

Skype отдела продаж:

moschip.ru

moschip.ru_4

moschip.ru_6

moschip.ru_9