

# 16-Ch/Dual 8-Ch High-Performance CMOS Analog Multiplexers

## DESCRIPTION

The DG406 is a 16 channel single-ended analog multiplexer designed to connect one of sixteen inputs to a common output as determined by a 4-bit binary address. The DG407 selects one of eight differential inputs to a common differential output. Break-before-make switching action protects against momentary shorting of inputs.

An on channel conducts current equally well in both directions. In the off state each channel blocks voltages up to the power supply rails. An enable (EN) function allows the user to reset the multiplexer/demultiplexer to all switches off for stacking several devices. All control inputs, address ( $A_x$ ) and enable (EN) are TTL compatible over the full specified operating temperature range.

Applications for the DG406, DG407 include high speed data acquisition, audio signal switching and routing, ATE systems, and avionics. High performance and low power dissipation make them ideal for battery operated and remote instrumentation applications.

Designed in the 44 V silicon-gate CMOS process, the absolute maximum voltage rating is extended to 44 V, allowing operation with  $\pm 20$  V supplies. Additionally single (12 V) supply operation is allowed. An epitaxial layer prevents latchup.

For applications information please request documents 70601 and 70604.

## FEATURES

- Low on-resistance -  $R_{DS(on)}$ : 50  $\Omega$
- Low charge injection - Q: 15 pC
- Fast transition time -  $t_{TRANS}$ : 200 ns
- Low power: 0.2 mW
- Single supply capability
- 44 V supply max. rating



RoHS\*  
COMPLIANT

## BENEFITS

- Higher accuracy
- Reduced glitching
- Improved data throughput
- Reduced power consumption
- Increased ruggedness
- Wide supply ranges:  $\pm 5$  V to  $\pm 20$  V

## APPLICATIONS

- Data acquisition systems
- Audio signal routing
- Medical instrumentation
- ATE systems
- Battery powered systems
- High-rel systems
- Single supply systems

## FUNCTIONAL BLOCK DIAGRAM AND PIN CONFIGURATION

**DG406**
**Dual-In-Line and SOIC Wide-Body**

Top View

**DG407**
**Dual-In-Line and SOIC Wide-Body**

Top View

\* Pb containing terminations are not RoHS compliant, exemptions may apply

## FUNCTIONAL BLOCK DIAGRAM AND PIN CONFIGURATION

DG406

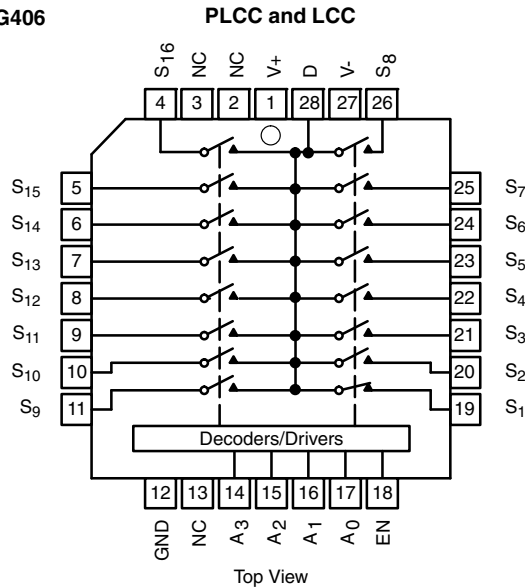

DG407



TRUTH TABLE (DG406)					
A <sub>3</sub>	A <sub>2</sub>	A <sub>1</sub>	A <sub>0</sub>	EN	On Switch
X	X	X	X	0	None
0	0	0	0	1	1
0	0	0	1	1	2
0	0	1	0	1	3
0	0	1	1	1	4
0	1	0	0	1	5
0	1	0	1	1	6
0	1	1	0	1	7
0	1	1	1	1	8
1	0	0	0	1	9
1	0	0	1	1	10
1	0	1	0	1	11
1	0	1	1	1	12
1	1	0	0	1	13
1	1	0	1	1	14
1	1	1	0	1	15
1	1	1	1	1	16

TRUTH TABLE (DG407)				
A <sub>2</sub>	A <sub>1</sub>	A <sub>0</sub>	EN	On Switch Pair
X	X	X	0	None
0	0	0	1	1
0	0	1	1	2
0	1	0	1	3
0	1	1	1	4
1	0	0	1	5
1	0	1	1	6
1	1	0	1	7
1	1	1	1	8

Logic "0" =  $V_{AL} \leq 0.8 V$   
 Logic "1" =  $V_{AH} \geq 2.4 V$   
 X = Do not Care

ORDERING INFORMATION (DG406)		
Temp. Range	Package	Part Number
- 40 °C to 85 °C	28-Pin Plastic DIP	DG406DJ DG406DJ-E3
	28-Pin PLCC	DG406DN DG406DN-T1-E3
	28-Pin Widebody SOIC	DG406DW DG406DW-E3

ORDERING INFORMATION (DG407)		
Temp. Range	Package	Part Number
- 40 °C to 85 °C	28-Pin Plastic DIP	DG407DJ DG407DJ-E3
	28-Pin PLCC	DG407DN DG407DN-T1-E3
	28-Pin Widebody SOIC	DG407DW DG407DW-E3



<b>ABSOLUTE MAXIMUM RATINGS</b>			
<b>Parameter</b>		<b>Limit</b>	<b>Unit</b>
Voltages Referenced to V-	V+	44	V
	GND	25	
Digital Inputs <sup>a</sup> , V <sub>S</sub> , V <sub>D</sub>		(V-) - 2 to (V+) + 2 V or 20 mA, whichever occurs first	
Current (Any terminal)		30	mA
Peak Current, S or D (Pulsed at 1 ms, 10 % duty cycle max.)		100	
Storage Temperature	(AK, AZ Suffix)	- 65 to 150	°C
	(DJ, DN Suffix)	- 65 to 125	
Power Dissipation (Package) <sup>b</sup>	28-Pin Plastic DIP <sup>b</sup>	625	mW
	28-Pin CerDIP <sup>d</sup>	1.2	W
	28-Pin Plastic PLCC <sup>c</sup>	450	mW
	LCC-28 <sup>e</sup>	1.35	W
	28-Pin Widebody SOIC	450	mW

**Notes:**

- a. Signals on SX, DX or INX exceeding V+ or V- will be clamped by internal diodes. Limit forward diode current to maximum current ratings.
- b. All leads soldered or welded to PC board.
- c. Derate 6 mW/°C above 75°C.
- d. Derate 12 mW/°C above 75°C.
- e. Derate 13.5 mW/°C above 75°C .



SPECIFICATIONS <sup>a</sup>										
Parameter	Symbol	Test Conditions Unless Otherwise Specified $V_+ = 15\text{ V}$ , $V_- = -15\text{ V}$ $V_{AL} = 0.8\text{ V}$ , $V_{AH} = 2.4\text{ V}^f$	Temp. <sup>b</sup>	Typ. <sup>c</sup>	A Suffix - 55 °C to 125 °C		D Suffix - 40 °C to 85 °C		Unit	
					Min. <sup>d</sup>	Max. <sup>d</sup>	Min. <sup>d</sup>	Max. <sup>d</sup>		
<b>Analog Switch</b>										
Analog Signal Range <sup>e</sup>	$V_{ANALOG}$		Full		- 15	15	- 15	15	V	
Drain-Source On-Resistance	$R_{DS(on)}$	$V_D = \pm 10\text{ V}$ , $I_S = -10\text{ mA}$ sequence each switch on	Room Full	50		100 125		100 125	$\Omega$	
$R_{DS(on)}$ Matching Between Channels <sup>g</sup>	$\Delta R_{DS(on)}$	$V_D = \pm 10\text{ V}$	Room	5					%	
Source Off Leakage Current	$I_{S(off)}$	$V_{EN} = 0\text{ V}$ $V_D = \pm 10\text{ V}$ $V_S = \pm 10\text{ V}$	Room Full	0.01	- 0.5 - 50	0.5 50	- 0.5 - 5	0.5 5	nA	
Drain Off Leakage Current	$I_{D(off)}$		DG406	Room Full	0.04	- 1 - 200	1 200	- 1 - 40		1 40
			DG407	Room Full	0.04	- 1 - 100	1 100	- 1 - 20		1 20
Drain On Leakage Current	$I_{D(on)}$		$V_S = V_D = \pm 10$ sequence each switch on	DG406	Room Full	0.04	- 1 - 200	1 200		- 1 - 40
		DG407		Room Full	0.04	- 1 - 100	1 100	- 1 - 20	1 20	
<b>Digital Control</b>										
Logic High Input Voltage	$V_{INH}$		Full		2.4		2.4		V	
Logic Low Input Voltage	$V_{INL}$		Full			0.8		0.8		
Logic High Input Current	$I_{AH}$	$V_A = 2.4\text{ V}$ , $15\text{ V}$	Full		- 1	1	- 1	1	$\mu\text{A}$	
Logic Low Input Current	$I_{AL}$	$V_{EN} = 0\text{ V}$ , $2.4\text{ V}$ , $V_A = 0\text{ V}$	Full		- 1	1	- 1	1		
Logic Input Capacitance	$C_{in}$	$f = 1\text{ MHz}$	Room	7					pF	
<b>Dynamic Characteristics</b>										
Transition Time	$t_{TRANS}$	see figure 2	Room Full	200		350 450		350 450	ns	
Break-Before-Make Interval	$t_{OPEN}$	see figure 4	Room Full	50	25 10		25 10			
Enable Turn-On Time	$t_{ON(EN)}$	see figure 3	Room Full	150		200 400		200 400		
Enable Turn-Off Time	$t_{OFF(EN)}$		Room Full	70		150 300		150 300		
Charge Injection	Q	$V_S = 0\text{ V}$ , $C_L = 1\text{ nF}$ , $R_S = 0\ \Omega$	Room	15					pC	
Off Isolation <sup>h</sup>	OIRR	$V_{EN} = 0\text{ V}$ , $R_L = 1\text{ k}\Omega$ $f = 100\text{ kHz}$	Room	- 69					dB	
Source Off Capacitance	$C_{S(off)}$	$V_{EN} = 0\text{ V}$ , $V_S = 0\text{ V}$ , $f = 1\text{ MHz}$	Room	8					pF	
Drain Off Capacitance	$C_{D(off)}$	$V_{EN} = 0\text{ V}$ $V_D = 0\text{ V}$ $f = 1\text{ MHz}$	Room	130						
			DG407	Room	65					
Drain On Capacitance	$C_{D(on)}$		DG406	Room	140					
			DG407	Room	70					
<b>Power Supplies</b>										
Positive Supply Current	$I_+$	$V_{EN} = V_A = 0$ or $5\text{ V}$	Room Full	13		30 75		30 75	$\mu\text{A}$	
Negative Supply Current	$I_-$		Room Full	- 0.01	- 1 - 10		- 1 - 10			
Positive Supply Current	$I_+$	$V_{EN} = 2.4\text{ V}$ , $V_A = 0\text{ V}$	Room Full	50		500 900		500 700		
Negative Supply Current	$I_-$		Room Full	- 0.01	- 20 - 20		- 20 - 20			



SPECIFICATIONS <sup>a</sup> (for Single Supply)									
Parameter	Symbol	Test Conditions Unless Otherwise Specified V <sub>+</sub> = 12 V, V <sub>-</sub> = 0 V V <sub>AL</sub> = 0.8 V, V <sub>AH</sub> = 2.4 V <sup>f</sup>	Temp. <sup>b</sup>	Typ. <sup>c</sup>	A Suffix - 55 °C to 125 °C		D Suffix - 40 °C to 85 °C		Unit
					Min. <sup>d</sup>	Max. <sup>d</sup>	Min. <sup>d</sup>	Max. <sup>d</sup>	
<b>Analog Switch</b>									
Analog Signal Range <sup>e</sup>	V <sub>ANALOG</sub>		Full		0	12	0	12	V
Drain-Source On-Resistance	R <sub>DS(on)</sub>	V <sub>D</sub> = 3 V, 10 V, I <sub>S</sub> = - 1 mA sequence each switch on	Room	90		120		120	Ω
R <sub>DS(on)</sub> Matching Between Channels <sup>g</sup>	ΔR <sub>DS(on)</sub>		Room	5					%
Source Off Leakage Current	I <sub>S(off)</sub>	V <sub>EN</sub> = 0 V V <sub>D</sub> = 10 V or 0.5 V V <sub>S</sub> = 0.5 V or 10 V V <sub>S</sub> = V <sub>D</sub> = ± 10 sequence each switch on	Room	0.01					nA
Drain Off Leakage Current	I <sub>D(off)</sub>		DG406	Room	0.04				
			DG407	Room	0.04				
Drain On Leakage Current	I <sub>D(on)</sub>		DG406	Room	0.04				
		DG407	Room	0.04					
<b>Dynamic Characteristics</b>									
Switching Time of Multiplexer	t <sub>OPEN</sub>	V <sub>S1</sub> = 8 V, V <sub>S8</sub> = 0 V, V <sub>IN</sub> = 2.4 V	Room	300		450		450	ns
Enable Turn-On Time	t <sub>ON(EN)</sub>	V <sub>INH</sub> = 2.4 V, V <sub>INL</sub> = 0 V V <sub>S1</sub> = 5 V	Room	250		600		600	
Enable Turn-Off Time	t <sub>OFF(EN)</sub>		Room	150		300		300	
Charge Injection	Q	C <sub>L</sub> = 1 nF, V <sub>S</sub> = 6 V, R <sub>S</sub> = 0	Room	20					pC
<b>Power Supplies</b>									
Positive Supply Current	I <sub>+</sub>	V <sub>EN</sub> = 0 V or 5 V, V <sub>A</sub> = 0 V or 5 V	Room	13		30		30	μA
Negative Supply Current	I <sub>-</sub>		Full				75		
			Room	- 0.01	- 20		- 20		
			Full		- 20		- 20		

Notes:

- a. Refer to PROCESS OPTION FLOWCHART.
- b. Room = 25 °C, Full = as determined by the operating temperature suffix.
- c. Typical values are for DESIGN AID ONLY, not guaranteed nor subject to production testing.
- d. The algebraic convention whereby the most negative value is a minimum and the most positive a maximum, is used in this data sheet.
- e. Guaranteed by design, not subject to production test.
- f. V<sub>IN</sub> = input voltage to perform proper function.
- g. ΔR<sub>DS(on)</sub> = R<sub>DS(on)</sub> max. - R<sub>DS(on)</sub> min.
- h. Worst case isolation occurs on Channel 4 due to proximity to the drain pin.

Stresses beyond those listed under "Absolute Maximum Ratings" may cause permanent damage to the device. These are stress ratings only, and functional operation of the device at these or any other conditions beyond those indicated in the operational sections of the specifications is not implied. Exposure to absolute maximum rating conditions for extended periods may affect device reliability.

## TYPICAL CHARACTERISTICS $(T_A = 25\text{ }^\circ\text{C}, \text{ unless otherwise noted})$

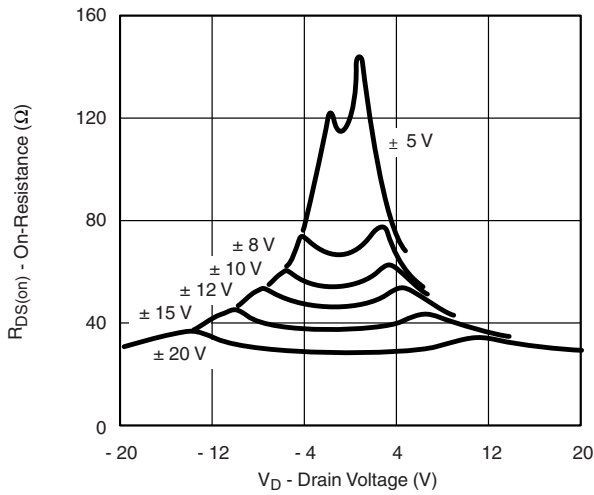

**$R_{DS(on)}$  vs.  $V_D$  and Supply**

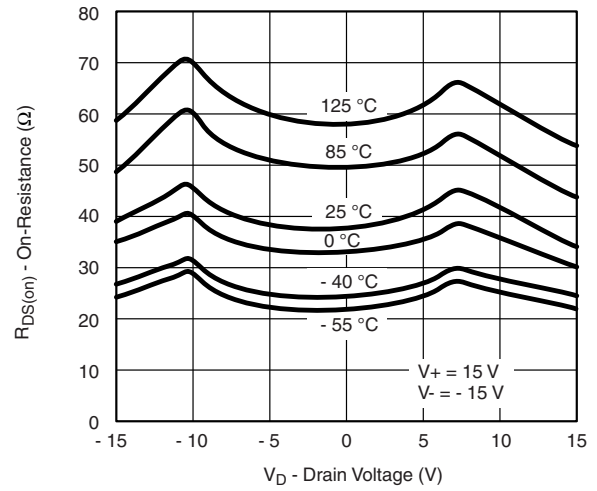

**$R_{DS(on)}$  vs.  $V_D$  and Temperature**

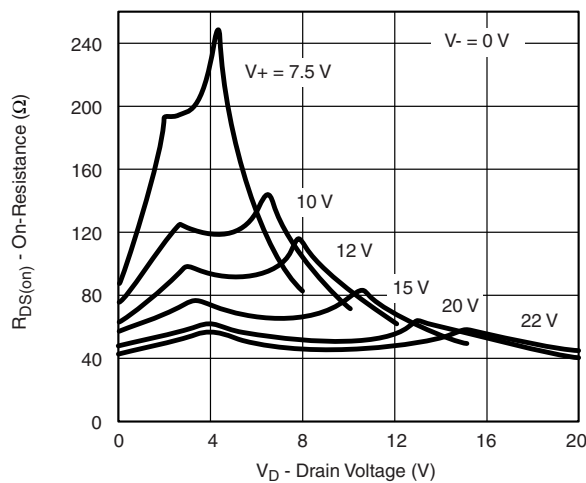

**$R_{DS(on)}$  vs.  $V_D$  and Supply**

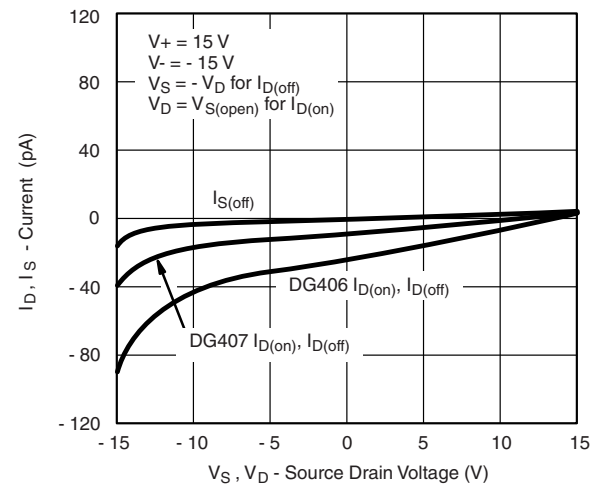

**$I_D, I_S$  Leakage Currents vs. Analog Voltage**



**$I_D, I_S$  Leakages vs. Temperature**



**Switching Times vs. Bipolar Supplies**

**TYPICAL CHARACTERISTICS** ( $T_A = 25\text{ }^\circ\text{C}$ , unless otherwise noted)



**Switching Times vs. Single Supply**



**Charge Injection vs. Analog Voltage**



**Off-Isolation vs. Frequency**



**Supply Currents vs. Switching Frequency**



**$t_{ON}/t_{OFF}$  vs. Temperature**

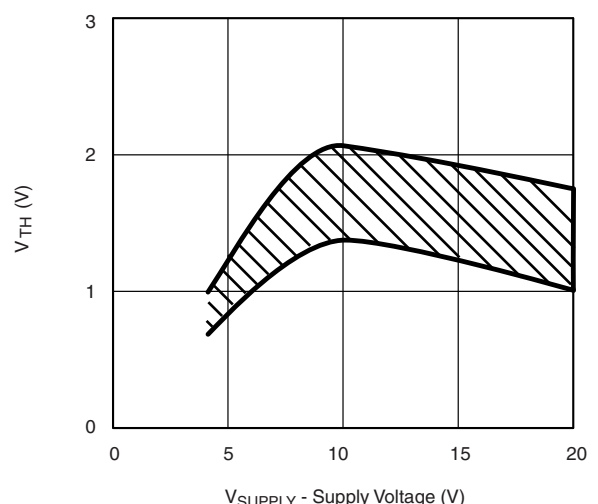

**Switching Threshold vs. Supply Voltage**

## SCHEMATIC DIAGRAM (Typical Channel)



Figure 1.

## TEST CIRCUITS



\* = S<sub>1a</sub> - S<sub>8a</sub>, S<sub>2b</sub> S<sub>±7b</sub>, D<sub>a</sub>

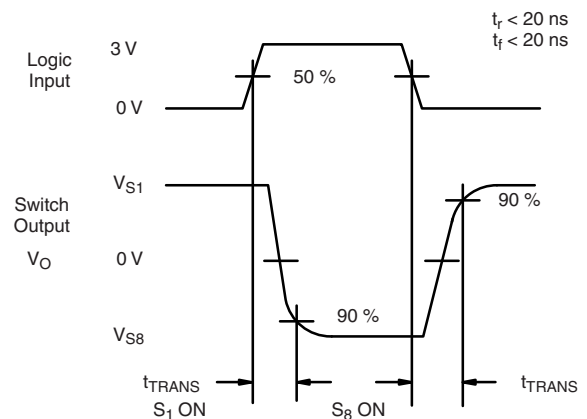

Figure 2. Transition Time



## TEST CIRCUITS

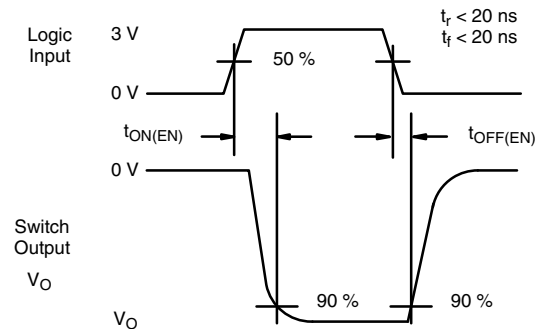

Figure 3. Enable Switching Time

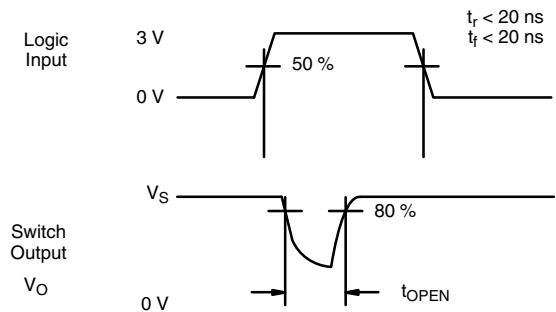

Figure 4. Break-Before-Make Interval

### APPLICATIONS HINTS

Sampling speed is limited by two consecutive events: the transition time of the multiplexer, and the settling time of the sampled signal at the output.

$t_{TRANS}$  is given on the data sheet. Settling time at the load depends on several parameters:  $R_{DS(on)}$  of the multiplexer, source impedance, the multiplexer and load capacitances, charge injection of the multiplexer and accuracy desired.

The settling time for the multiplexer alone can be derived from the model shown in figure 5. Assuming a low impedance signal source like that presented by an op amp or a buffer amplifier, the settling time of the RC network for a given accuracy is equal to  $n\tau$ :

% ACCURACY	# BITS	N
0.25	8	6
0.012	12	9
0.0017	15	11



Figure 5. Simplified Model of One Multiplexer Channel

The maximum sampling frequency of the multiplexer is:

$$f_s = \frac{1}{N(t_{SETTLING} + t_{TRANS})} \quad (1)$$

where N = number of channels to scan

$$t_{SETTLING} = n\tau = n \times R_{DS(on)} \times C_{D(on)}$$

For the DG406 then, at room temp and for 12-bit accuracy, using the maximum limits:

$$f_s = \frac{1}{16 (9 \times 100 \Omega \times 10^{-12}F) + 300 \times 10^{-12}s} \quad (2)$$

or

$$f_s = 694 \text{ kHz} \quad (3)$$

From the sampling theorem, to properly recover the original signal, the sampling frequency should be more than twice the maximum component frequency of the original signal. This assumes perfect bandlimiting. In a real application sampling at three to four times the filter cutoff frequency is a good practice.

Therefore from equation 2 above:

$$f_c = \frac{1}{4} \times f_s = 173 \text{ kHz} \quad (4)$$

From this we can see that the DG406 can be used to sample 16 different signals whose maximum component frequency can be as high as 173 kHz. If for example, two channels are used to double sample the same incoming signal then its cutoff frequency can be doubled.

The block diagram shown in Figure 6 illustrates a typical data acquisition front end suitable for low-level analog signals. Differential multiplexing of small signals is preferred since this method helps to reject any common mode noise. This is especially important when the sensors are located at a distance and it may eliminate the need for individual amplifiers. A low  $R_{DS(on)}$ , low leakage multiplexer like the DG407 helps to reduce measurement errors. The low power dissipation of the DG407 minimizes on-chip thermal gradients which can cause errors due to temperature mismatch along the parasitic thermocouple paths. Please refer to Application Note AN203 for additional information.



Figure 6. Measuring low-level analog signals is more accurate when using a differential multiplexing technique

Vishay Siliconix maintains worldwide manufacturing capability. Products may be manufactured at one of several qualified locations. Reliability data for Silicon Technology and Package Reliability represent a composite of all qualified locations. For related documents such as package/tape drawings, part marking, and reliability data, see [www.vishay.com/ppg?70061](http://www.vishay.com/ppg?70061).

### PDIP: 28-LEAD



Dim	MILLIMETERS		INCHES	
	Min	Max	Min	Max
<b>A</b>	2.29	5.08	0.090	0.200
<b>A<sub>1</sub></b>	0.39	1.77	0.015	0.070
<b>B</b>	0.38	0.56	0.015	0.022
<b>B<sub>1</sub></b>	0.89	1.65	0.035	0.065
<b>C</b>	0.204	0.30	0.008	0.012
<b>D</b>	35.10	39.70	1.380	1.565
<b>E</b>	15.24	15.88	0.600	0.625
<b>E<sub>1</sub></b>	13.21	14.73	0.520	0.580
<b>e<sub>1</sub></b>	2.29	2.79	0.090	0.110
<b>e<sub>A</sub></b>	14.99	15.49	0.590	0.610
<b>L</b>	2.60	5.08	0.100	0.200
<b>Q<sub>1</sub></b>	0.95	2.345	0.0375	0.0925
<b>S</b>	0.995	2.665	0.0375	0.105

ECN: S-03946—Rev. F, 09-Jul-01  
DWG: 5488



**PLCC: 28-LEAD**



DIM.	MILLIMETERS		INCHES	
	MIN.	MAX.	MIN.	MAX.
A	4.20	4.57	0.165	0.180
A <sub>1</sub>	2.29	3.04	0.090	0.120
A <sub>2</sub>	0.51	-	0.020	-
B	0.331	0.553	0.013	0.021
B <sub>1</sub>	0.661	0.812	0.026	0.032
D	12.32	12.57	0.485	0.495
D <sub>1</sub>	11.430	11.582	0.450	0.456
D <sub>2</sub>	9.91	10.92	0.390	0.430
e <sub>1</sub>	1.27 BSC		0.050 BSC	
ECN: T09-0766-Rev. D, 28-Sep-09 DWG: 5491				



### SOIC (WIDE-BODY): 28-LEADS



All Dimensions In Inches

ECN: E11-2209-Rev. D, 01-Aug-11  
DWG: 5850



28-LEAD LCC



Dim	MILLIMETERS		INCHES	
	Min	Max	Min	Max
<b>A</b>	1.37	2.24	0.054	0.088
<b>A<sub>1</sub></b>	1.63	2.54	0.064	0.100
<b>B</b>	0.56	0.71	0.022	0.028
<b>D</b>	11.23	11.63	0.442	0.458
<b>E</b>	11.23	11.63	0.442	0.458
<b>e</b>	1.27 BSC		0.050 BSC	
<b>L</b>	1.14	1.40	0.045	0.055
<b>L<sub>1</sub></b>	1.96	2.36	0.077	0.093

ECN: S-03946—Rev. B, 09-Jul-01  
DWG: 5319

### CERDIP: 28-LEAD



Dim	MILLIMETERS		INCHES	
	Min	Max	Min	Max
<b>A</b>	4.06	5.92	0.160	0.232
<b>A<sub>1</sub></b>	0.38	1.52	0.015	0.060
<b>B</b>	0.38	0.51	0.015	0.020
<b>B<sub>1</sub></b>	1.14	1.65	0.045	0.065
<b>C</b>	0.20	0.30	0.008	0.012
<b>D</b>	36.58	37.08	1.440	1.460
<b>E</b>	15.24	15.88	0.600	0.625
<b>E<sub>1</sub></b>	12.95	13.46	0.510	0.530
<b>e<sub>1</sub></b>	2.54 BSC		0.100 BSC	
<b>e<sub>A</sub></b>	15.24 BSC		0.600 BSC	
<b>L</b>	3.18	3.81	0.125	0.150
<b>L<sub>1</sub></b>	3.81	5.08	0.150	0.200
<b>Q<sub>1</sub></b>	1.27	2.16	0.050	0.085
<b>S</b>	1.52	2.29	0.060	0.090
$\infty$	0°	15°	0°	15°
ECN: S-03946—Rev. E, 09-Jul-01 DWG: 5434				



## Disclaimer

ALL PRODUCT, PRODUCT SPECIFICATIONS AND DATA ARE SUBJECT TO CHANGE WITHOUT NOTICE TO IMPROVE RELIABILITY, FUNCTION OR DESIGN OR OTHERWISE.

Vishay Intertechnology, Inc., its affiliates, agents, and employees, and all persons acting on its or their behalf (collectively, "Vishay"), disclaim any and all liability for any errors, inaccuracies or incompleteness contained in any datasheet or in any other disclosure relating to any product.

Vishay makes no warranty, representation or guarantee regarding the suitability of the products for any particular purpose or the continuing production of any product. To the maximum extent permitted by applicable law, Vishay disclaims (i) any and all liability arising out of the application or use of any product, (ii) any and all liability, including without limitation special, consequential or incidental damages, and (iii) any and all implied warranties, including warranties of fitness for particular purpose, non-infringement and merchantability.

Statements regarding the suitability of products for certain types of applications are based on Vishay's knowledge of typical requirements that are often placed on Vishay products in generic applications. Such statements are not binding statements about the suitability of products for a particular application. It is the customer's responsibility to validate that a particular product with the properties described in the product specification is suitable for use in a particular application. Parameters provided in datasheets and/or specifications may vary in different applications and performance may vary over time. All operating parameters, including typical parameters, must be validated for each customer application by the customer's technical experts. Product specifications do not expand or otherwise modify Vishay's terms and conditions of purchase, including but not limited to the warranty expressed therein.

Except as expressly indicated in writing, Vishay products are not designed for use in medical, life-saving, or life-sustaining applications or for any other application in which the failure of the Vishay product could result in personal injury or death. Customers using or selling Vishay products not expressly indicated for use in such applications do so at their own risk. Please contact authorized Vishay personnel to obtain written terms and conditions regarding products designed for such applications.

No license, express or implied, by estoppel or otherwise, to any intellectual property rights is granted by this document or by any conduct of Vishay. Product names and markings noted herein may be trademarks of their respective owners.

## Material Category Policy

**Vishay Intertechnology, Inc. hereby certifies that all its products that are identified as RoHS-Compliant fulfill the definitions and restrictions defined under Directive 2011/65/EU of The European Parliament and of the Council of June 8, 2011 on the restriction of the use of certain hazardous substances in electrical and electronic equipment (EEE) - recast, unless otherwise specified as non-compliant.**

**Please note that some Vishay documentation may still make reference to RoHS Directive 2002/95/EC. We confirm that all the products identified as being compliant to Directive 2002/95/EC conform to Directive 2011/65/EU.**

**Vishay Intertechnology, Inc. hereby certifies that all its products that are identified as Halogen-Free follow Halogen-Free requirements as per JEDEC JS709A standards. Please note that some Vishay documentation may still make reference to the IEC 61249-2-21 definition. We confirm that all the products identified as being compliant to IEC 61249-2-21 conform to JEDEC JS709A standards.**



## Данный компонент на территории Российской Федерации

### Вы можете приобрести в компании MosChip.

Для оперативного оформления запроса Вам необходимо перейти по данной ссылке:

<http://moschip.ru/get-element>

Вы можете разместить у нас заказ для любого Вашего проекта, будь то серийное производство или разработка единичного прибора.

В нашем ассортименте представлены ведущие мировые производители активных и пассивных электронных компонентов.

Нашей специализацией является поставка электронной компонентной базы двойного назначения, продукции таких производителей как XILINX, Intel (ex.ALTERA), Vicor, Microchip, Texas Instruments, Analog Devices, Mini-Circuits, Amphenol, Glenair.

Сотрудничество с глобальными дистрибьюторами электронных компонентов, предоставляет возможность заказывать и получать с международных складов практически любой перечень компонентов в оптимальные для Вас сроки.

На всех этапах разработки и производства наши партнеры могут получить квалифицированную поддержку опытных инженеров.

Система менеджмента качества компании отвечает требованиям в соответствии с ГОСТ Р ИСО 9001, ГОСТ РВ 0015-002 и ЭС РД 009

### Офис по работе с юридическими лицами:

105318, г.Москва, ул.Щербаковская д.3, офис 1107, 1118, ДЦ «Щербаковский»

Телефон: +7 495 668-12-70 (многоканальный)

Факс: +7 495 668-12-70 (доб.304)

E-mail: [info@moschip.ru](mailto:info@moschip.ru)

Skype отдела продаж:

moschip.ru

moschip.ru\_4

moschip.ru\_6

moschip.ru\_9