

# DATA SHEET

For a complete data sheet, please also download:

- The IC06 74HC/HCT/HCU/HCMOS Logic Family Specifications
- The IC06 74HC/HCT/HCU/HCMOS Logic Package Information
- The IC06 74HC/HCT/HCU/HCMOS Logic Package Outlines

## **74HC/HCT251** 8-input multiplexer; 3-state

Product specification  
File under Integrated Circuits, IC06

December 1990

## 8-input multiplexer; 3-state

## 74HC/HCT251

## FEATURES

- True and complement outputs
- Both outputs are 3-state for further multiplexer expansion
- Multifunction capability
- Permits multiplexing from n-lines to one line
- Output capability: standard
- I<sub>CC</sub> category: MSI

## GENERAL DESCRIPTION

The 74HC/HCT251 are high-speed Si-gate CMOS devices and are pin compatible with low power Schottky TTL (LSTTL). They are specified in compliance with JEDEC standard no. 7A.

The 74HC/HCT251 are the logic implementations of single-pole 8-position switches with the state of three select inputs ( $S_0, S_1, S_2$ ) controlling the switch positions. Assertion ( $Y$ ) and negation ( $\bar{Y}$ ) outputs are both provided. The output enable input ( $\bar{OE}$ ) is active LOW. The logic function provided at the output, when activated, is:

$$Y = \bar{OE} \cdot (I_0 \cdot \bar{S}_0 \cdot \bar{S}_1 \cdot \bar{S}_2 + I_1 \cdot S_0 \cdot \bar{S}_1 \cdot \bar{S}_2 + I_2 \cdot \bar{S}_0 \cdot S_1 \cdot \bar{S}_2 + I_3 \cdot S_0 \cdot S_1 \cdot \bar{S}_2 + I_4 \cdot \bar{S}_0 \cdot \bar{S}_1 \cdot S_2 + I_5 \cdot S_0 \cdot \bar{S}_1 \cdot S_2 + I_6 \cdot \bar{S}_0 \cdot S_1 \cdot S_2 + I_7 \cdot S_0 \cdot S_1 \cdot S_2)$$

Both outputs are in the high impedance OFF-state ( $Z$ ) when the output enable input is HIGH, allowing multiplexer expansion by tying the outputs.

## QUICK REFERENCE DATA

GND = 0 V; T<sub>amb</sub> = 25 °C; t<sub>r</sub> = t<sub>f</sub> = 6 ns

SYMBOL	PARAMETER	CONDITIONS	TYPICAL		UNIT
			HC	HCT	
t <sub>PHL</sub> / t <sub>PLH</sub>	propagation delay	C <sub>L</sub> = 15 pF; V <sub>CC</sub> = 5 V			
	I <sub>n</sub> to Y		15	19	ns
	I <sub>n</sub> to $\bar{Y}$		17	19	ns
	S <sub>n</sub> to Y		20	20	ns
	S <sub>n</sub> to $\bar{Y}$		21	21	ns
C <sub>I</sub>	input capacitance		3.5	3.5	pF
C <sub>PD</sub>	power dissipation capacitance per package	notes 1 and 2	44	46	pF

## Notes

1. C<sub>PD</sub> is used to determine the dynamic power dissipation (P<sub>D</sub> in μW):

$$P_D = C_{PD} \times V_{CC}^2 \times f_i + \sum (C_L \times V_{CC}^2 \times f_o) \text{ where:}$$

f<sub>i</sub> = input frequency in MHz

f<sub>o</sub> = output frequency in MHz

∑ (C<sub>L</sub> × V<sub>CC</sub><sup>2</sup> × f<sub>o</sub>) = sum of outputs

C<sub>L</sub> = output load capacitance in pF

V<sub>CC</sub> = supply voltage in V

2. For HC the condition is V<sub>I</sub> = GND to V<sub>CC</sub>  
For HCT the condition is V<sub>I</sub> = GND to V<sub>CC</sub> – 1.5 V

## ORDERING INFORMATION

See "74HC/HCT/HCU/HCMOS Logic Package Information".

8-input multiplexer; 3-state

74HC/HCT251

PIN DESCRIPTION

PIN NO.	SYMBOL	NAME AND FUNCTION
4, 3, 2, 1, 15, 14, 13, 12	$I_0$ to $I_7$	multiplexer inputs
5	Y	multiplexer output
6	$\bar{Y}$	complementary multiplexer output
7	$\overline{OE}$	3-state output enable input (active LOW)
8	GND	ground (0 V)
11, 10, 9	$S_0, S_1, S_2$	select inputs
16	$V_{CC}$	positive supply voltage

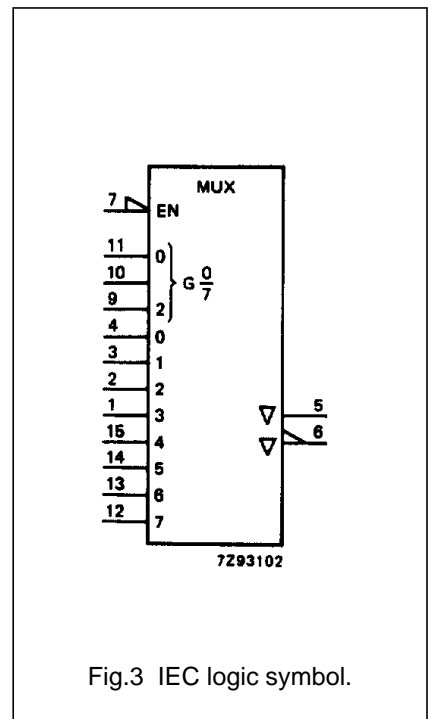
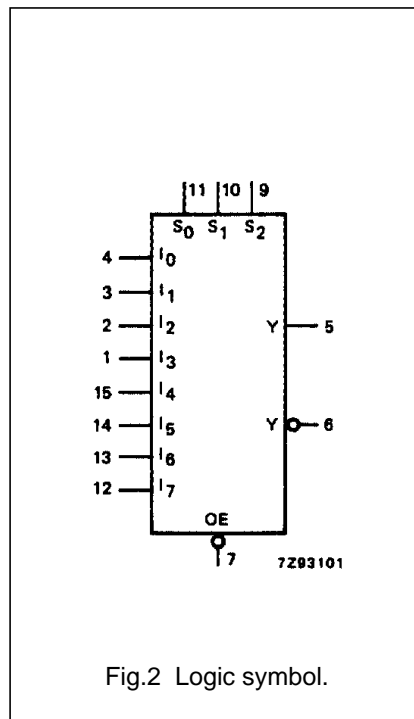
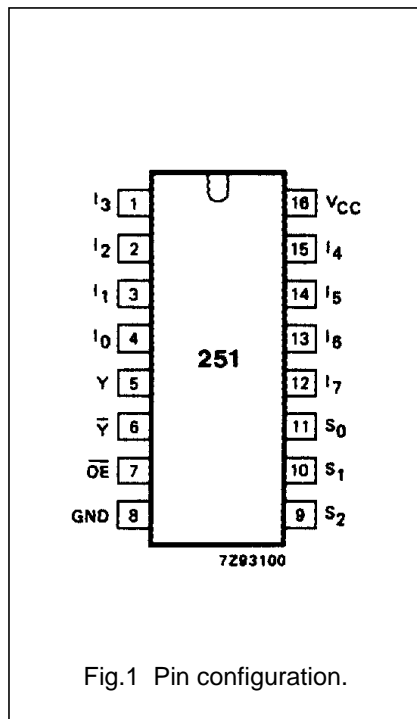

8-input multiplexer; 3-state

74HC/HCT251

FUNCTION TABLE

INPUTS												OUTPUTS	
$\overline{OE}$	$S_2$	$S_1$	$S_0$	$I_0$	$I_1$	$I_2$	$I_3$	$I_4$	$I_5$	$I_6$	$I_7$	$\overline{Y}$	Y
H	X	X	X	X	X	X	X	X	X	X	X	Z	Z
L	L	L	L	L	X	X	X	X	X	X	X	H	L
L	L	L	L	H	X	X	X	X	X	X	X	L	H
L	L	L	H	X	L	X	X	X	X	X	X	H	L
L	L	L	H	X	H	X	X	X	X	X	X	L	H
L	L	H	L	X	X	L	X	X	X	X	X	H	L
L	L	H	L	X	X	H	X	X	X	X	X	L	H
L	L	H	H	X	X	X	L	X	X	X	X	H	L
L	L	H	H	X	X	X	H	X	X	X	X	L	H
L	H	L	L	X	X	X	X	L	X	X	X	H	L
L	H	L	L	X	X	X	X	H	X	X	X	L	H
L	H	L	H	X	X	X	X	X	L	X	X	H	L
L	H	L	H	X	X	X	X	X	H	X	X	L	H
L	H	H	L	X	X	X	X	X	X	L	X	H	L
L	H	H	L	X	X	X	X	X	X	H	X	L	H
L	H	H	H	X	X	X	X	X	X	X	L	H	L
L	H	H	H	X	X	X	X	X	X	X	H	L	H

Note

- 1. H = HIGH voltage level
- L = LOW voltage level
- X = don't care
- Z = high impedance OFF-state

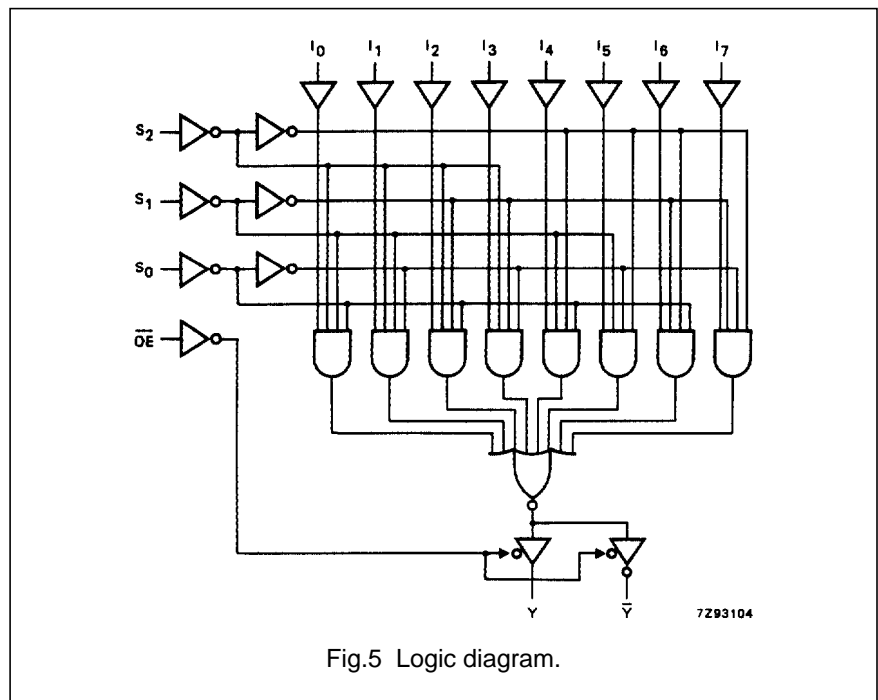
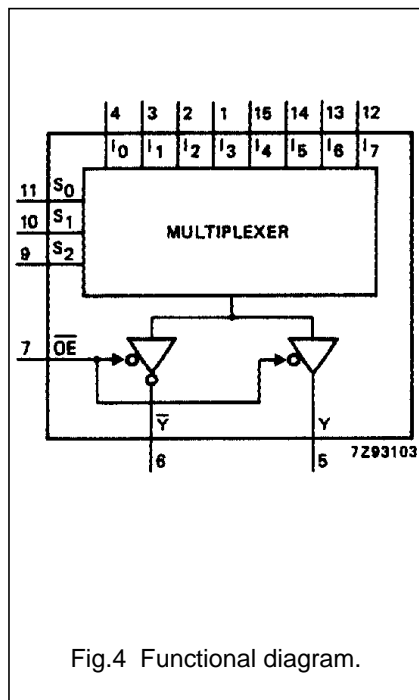

## 8-input multiplexer; 3-state

## 74HC/HCT251

**DC CHARACTERISTICS FOR 74HC**

For the DC characteristics see *"74HC/HCT/HCU/HCMOS Logic Family Specifications"*.

Output capability: standard

I<sub>CC</sub> category: MSI

**AC CHARACTERISTICS FOR 74HC**

GND = 0 V; t<sub>r</sub> = t<sub>f</sub> = 6 ns; C<sub>L</sub> = 50 pF

SYMBOL	PARAMETER	T <sub>amb</sub> (°C)						UNIT	TEST CONDITIONS		
		74HC							V <sub>CC</sub> (V)	WAVEFORMS	
		+25			-40 to +85		-40 to +125				
		min.	typ.	max.	min.	max.	min.				max.
t <sub>PHL</sub> / t <sub>PLH</sub>	propagation delay I <sub>n</sub> to Y		50 18 14	170 34 29		215 43 37		255 51 43	ns	2.0 4.5 6.0	Fig.6
t <sub>PHL</sub> / t <sub>PLH</sub>	propagation delay I <sub>n</sub> to $\bar{Y}$		55 20 16	175 35 30		220 44 37		265 53 45	ns	2.0 4.5 6.0	Fig.7
t <sub>PHL</sub> / t <sub>PLH</sub>	propagation delay S <sub>n</sub> to Y		66 24 19	205 41 35		255 51 43		310 62 53	ns	2.0 4.5 6.0	Fig.6
t <sub>PHL</sub> / t <sub>PLH</sub>	propagation delay S <sub>n</sub> to $\bar{Y}$		69 25 20	205 41 35		255 51 43		310 62 53	ns	2.0 4.5 6.0	Fig.7
t <sub>PZH</sub> / t <sub>PZL</sub>	3-state output enable time $\overline{OE}$ to Y, $\bar{Y}$		36 13 10	140 28 24		175 35 30		210 42 36	ns	2.0 4.5 6.0	Fig.7
t <sub>PHZ</sub> / t <sub>PLZ</sub>	3-state output disable time $\overline{OE}$ to Y, $\bar{Y}$		39 14 11	140 28 24		170 35 30		210 42 36	ns	2.0 4.5 6.0	Fig.7
t <sub>THL</sub> / t <sub>TLH</sub>	output transition time		19 7 6	75 15 13		95 19 16		110 22 19	ns	2.0 4.5 6.0	Figs 6 and 7

## 8-input multiplexer; 3-state

## 74HC/HCT251

**DC CHARACTERISTICS FOR 74HCT**

For the DC characteristics see *"74HC/HCT/HCU/HCMOS Logic Family Specifications"*.

Output capability: standard

I<sub>CC</sub> category: MSI

**Note to HCT types**

The value of additional quiescent supply current ( $\Delta I_{CC}$ ) for a unit load of 1 is given in the family specifications.

To determine  $\Delta I_{CC}$  per input, multiply this value by the unit load coefficient shown in the table below.

INPUT	UNIT LOAD COEFFICIENT
I <sub>n</sub>	1.00
S <sub>0</sub>	1.50
S <sub>1</sub> , S <sub>2</sub>	1.50
$\overline{OE}$	1.50

**AC CHARACTERISTICS FOR HCT**

GND = 0 V; t<sub>r</sub> = t<sub>f</sub> = 6 ns; C<sub>L</sub> = 50 pF

SYMBOL	PARAMETER	T <sub>amb</sub> (°C)							UNIT	TEST CONDITIONS	
		74HCT								V <sub>CC</sub> (V)	WAVEFORMS
		+25			-40 to +85		-40 to +125				
		min.	typ.	max.	min.	max.	min.	max.			
t <sub>PHL</sub> / t <sub>PLH</sub>	propagation delay I <sub>n</sub> to Y		22	35		44		53	ns	4.5	Fig.6
t <sub>PHL</sub> / t <sub>PLH</sub>	propagation delay I <sub>n</sub> to $\overline{Y}$		22	35		44		53	ns	4.5	Fig.7
t <sub>PHL</sub> / t <sub>PLH</sub>	propagation delay S <sub>n</sub> to Y		24	44		55		66	ns	4.5	Fig.6
t <sub>PHL</sub> / t <sub>PLH</sub>	propagation delay S <sub>n</sub> to $\overline{Y}$		25	44		55		66	ns	4.5	Fig.7
t <sub>PZH</sub> / t <sub>PZL</sub>	3-state output enable time $\overline{OE}$ to Y, $\overline{Y}$		13	28		35		42	ns	4.5	Fig.7
t <sub>PHZ</sub> / t <sub>PLZ</sub>	3-state output disable time $\overline{OE}$ to Y, $\overline{Y}$		14	28		35		42	ns	4.5	Fig.7
t <sub>THL</sub> / t <sub>TLH</sub>	output transition time		7	15		19		22	ns	4.5	Figs 6 and 7

8-input multiplexer; 3-state

74HC/HCT251

AC WAVEFORMS

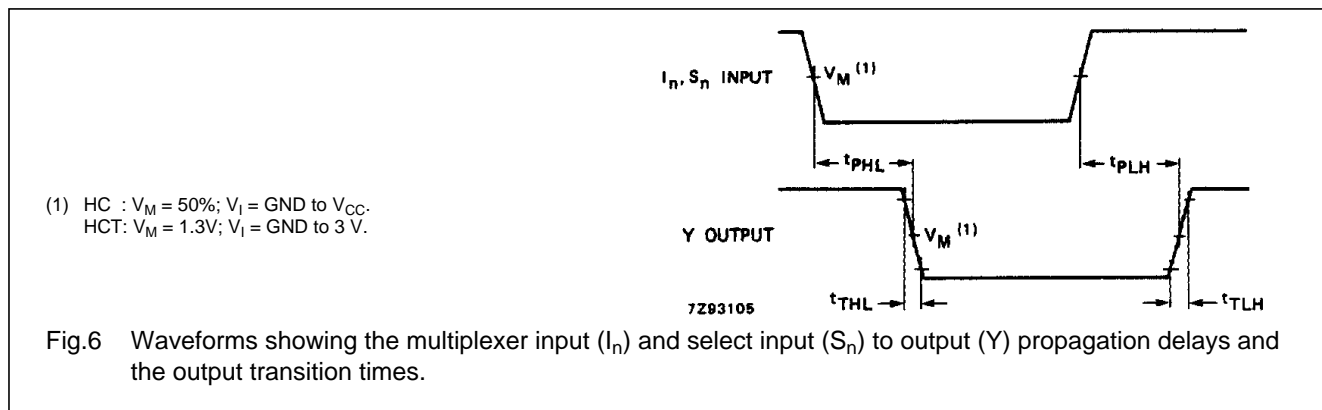

Fig.6 Waveforms showing the multiplexer input ( $I_n$ ) and select input ( $S_n$ ) to output (Y) propagation delays and the output transition times.

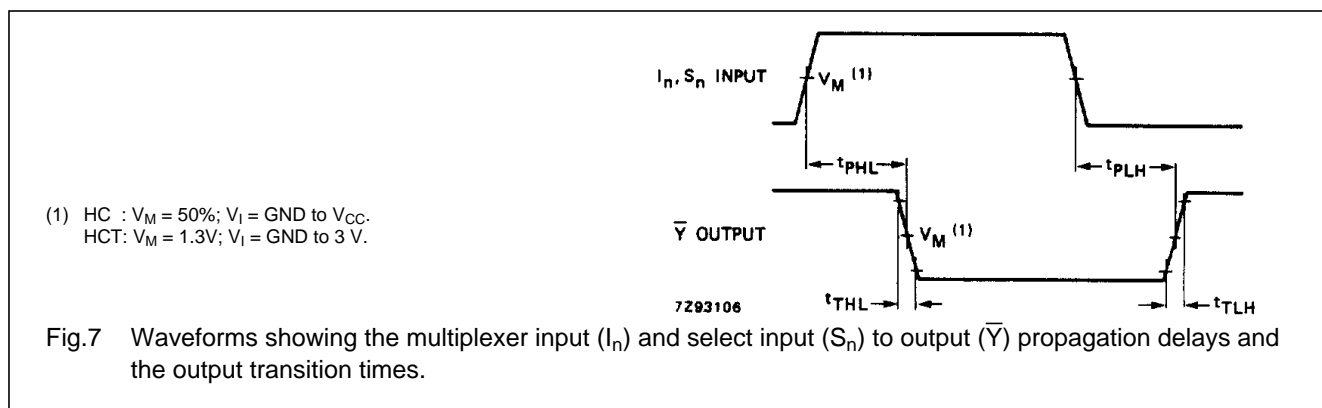

Fig.7 Waveforms showing the multiplexer input ( $I_n$ ) and select input ( $S_n$ ) to output ( $\bar{Y}$ ) propagation delays and the output transition times.

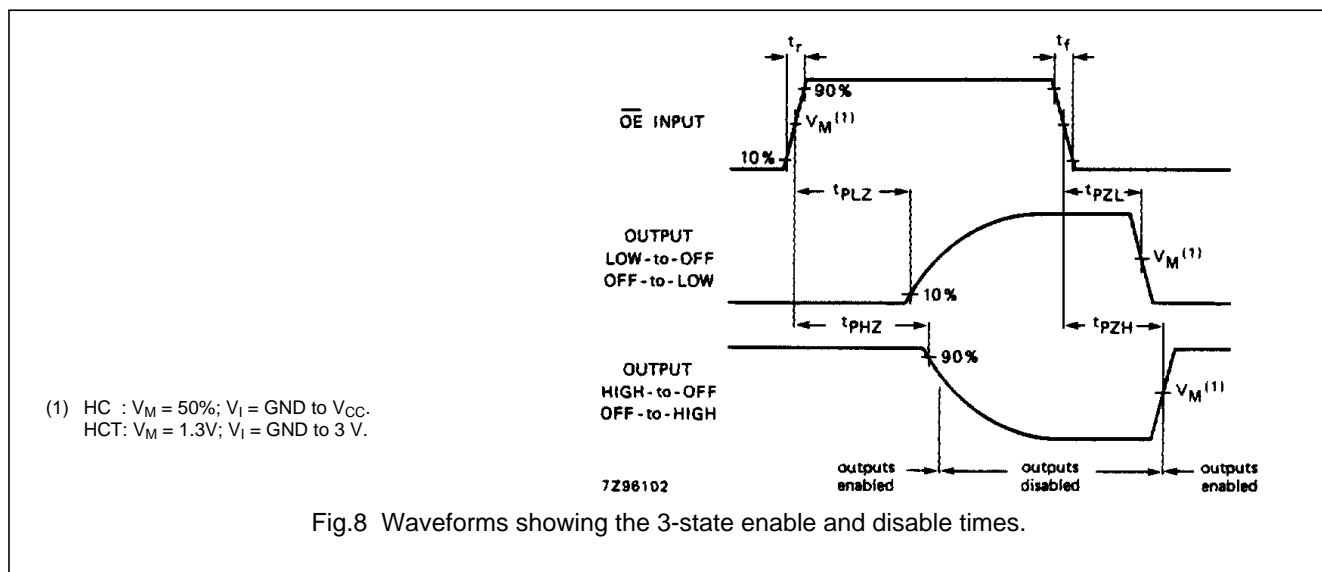

Fig.8 Waveforms showing the 3-state enable and disable times.

PACKAGE OUTLINES

See "74HC/HCT/HCU/HCMOS Logic Package Outlines".

## Данный компонент на территории Российской Федерации

### Вы можете приобрести в компании MosChip.

Для оперативного оформления запроса Вам необходимо перейти по данной ссылке:

<http://moschip.ru/get-element>

Вы можете разместить у нас заказ для любого Вашего проекта, будь то серийное производство или разработка единичного прибора.

В нашем ассортименте представлены ведущие мировые производители активных и пассивных электронных компонентов.

Нашей специализацией является поставка электронной компонентной базы двойного назначения, продукции таких производителей как XILINX, Intel (ex.ALTERA), Vicor, Microchip, Texas Instruments, Analog Devices, Mini-Circuits, Amphenol, Glenair.

Сотрудничество с глобальными дистрибьюторами электронных компонентов, предоставляет возможность заказывать и получать с международных складов практически любой перечень компонентов в оптимальные для Вас сроки.

На всех этапах разработки и производства наши партнеры могут получить квалифицированную поддержку опытных инженеров.

Система менеджмента качества компании отвечает требованиям в соответствии с ГОСТ Р ИСО 9001, ГОСТ РВ 0015-002 и ЭС РД 009

### Офис по работе с юридическими лицами:

105318, г.Москва, ул.Щербаковская д.3, офис 1107, 1118, ДЦ «Щербаковский»

Телефон: +7 495 668-12-70 (многоканальный)

Факс: +7 495 668-12-70 (доб.304)

E-mail: [info@moschip.ru](mailto:info@moschip.ru)

Skype отдела продаж:

moschip.ru

moschip.ru\_4

moschip.ru\_6

moschip.ru\_9