

Micro Relay A/VFMA

- High current version with limiting continuous current 30A at 85°C
- Pin assignment according to ISO 7588 part 3
- Customized versions on request
 - 24VDC versions with special contact gap
 - Integrated components (e.g. diode)
 - Customized marking
 - Special covers (e.g. notches, release features)
 - For latching version refer to Micro Relay Latching
 - For low noise version refer to Micro Relay Low Noise
 - For high current version refer to part number table

Typical applications

Cross carline up to 30A for example: ABS control, blower fans, cooling fan, door control, door lock, fuel pump, heated front screen, immobilizer, interior lights, seat control, seatbelt pretensioner, sun roof, trunk lock, valves, window lifter, wiper control.

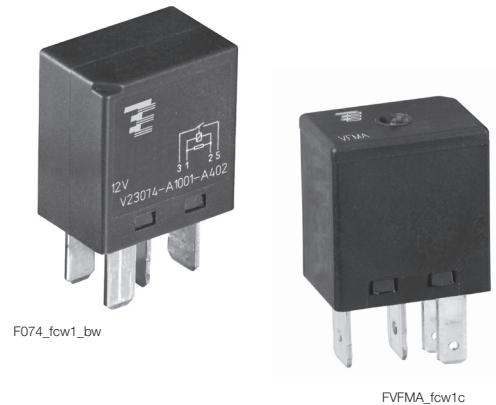

| Contact Data | Form A Standard | | Form C | | Form A HC | Form C HC |
|---|---|-------------------|---|---------------------|---|------------------|
| Contact arrangement | 1 form A, 1 NO | 1 form A, 1 NO | 1 form C, 1 CO | 1 form C, 1 CO | 1 form A, 1 NO 1 CO | 1 form C 1 CO |
| Rated voltage | 12VDC | 24VDC | 12VDC | 24VDC ⁶⁾ | 12VDC | 12VDC |
| Limiting continuous current, form A/form B | NO/NC | | NO/NC | | NO/NC | |
| 23°C | 30A | 30A | 30/20A | 30/20A | 35A | 35/25A |
| 85°C | 25A | 25A | 25/15A | 25/15A | 30A | 30/20A |
| 125°C | 10A | 10A | 10/8A | 10/8A | 15A | 15/10A |
| Limiting making current ¹⁾²⁾ , A/B (NO/NC) | 120A | 120A | 120/40A | 120/20A | 120A | 120/40A |
| Limiting breaking current | 30A | 20A | 30/15A | 20/10A | 30A | 30/20A |
| Limiting short-time current, overload current, ISO 8820-3 ³⁾ | 1.35 x 25A, 1800s 2.00 x 25A, 5s 3.50 x 25A, 0.5s 6.00 x 25A, 0.1s | | 1.35 x 25A, 1800s 2.00 x 25A, 5s 3.50 x 25A, 0.5s 6.00 x 25A, 0.1s | | 1.35 x 30A, 1800s 2.00 x 30A, 5s 3.50 x 30A, 0.5s 6.00 x 30A, 0.1s | |
| Jump start test | 24VDC for 5min conducting nominal current at 23°C | | | | | |
| Contact material | silver based | | | | | |
| Min. recommended contact load ⁴⁾ | 1A at 5VDC | | | | | |
| Initial voltage drop | 15/200mV 20/250mV | | | | | |
| Frequency of operation | 6 ops./min (0.1Hz) | | | | | |
| Electrical endurance ⁵⁾ | | | | | | |
| resistive load at 14VDC | >1x10 ⁵ ops. 25A | | >1x10 ⁵ ops. 25A (NO) | | >1x10 ⁵ ops. 30A | |
| resistive load at 28VDC | >1x10 ⁵ ops. 15A | | >1x10 ⁵ ops. 15A (NO) >1x10 ⁵ ops. 10A (NC) | | | |
| Mechanical endurance | typ. 10 ⁷ ops. | | | | | |

Max. DC load breaking capacity

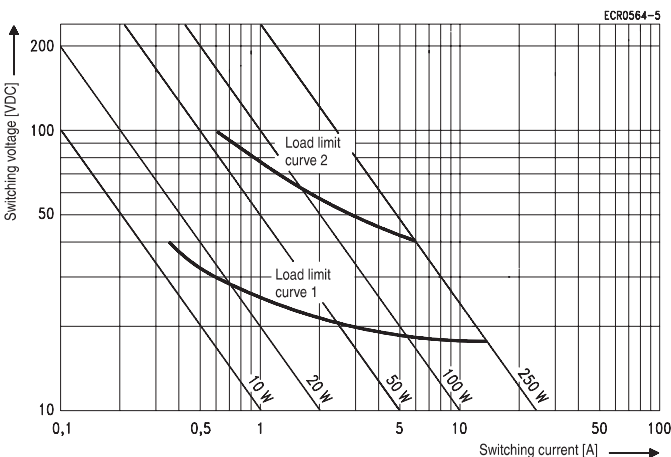

- 1) The values apply to a resistive or inductive load with suitable spark suppression and at maximum 13.5VDC for 12VDC or 27VDC for 24VDC load voltages.
- 2) For a load current duration of maximum 3s for a make/break ratio of 1:10.
- 3) Current and time are compatible with circuit protection by a typical automotive fuse. Relay will make, carry and break the specified current.
- 4) See chapter Diagnostics of Relays in our Application Notes or consult the internet at <http://relays.te.com/appnotes/>
- 5) Electrical endurance data is not valid for diode versions. Any diode or pn-junction parallel to the coil (internal or external) will significantly decrease the electrical lifetime, especially when used for inductive loads.
- 6) Not applicable for polarity reverse loads like power windows

Load limit curve 1: arc extinguishes during transit time (CO contact).
Load limit curve 2: safe shutdown, no stationary arc (NO contact).
Load limit curves measured with low inductive resistors verified for 1000 switching events.

Micro Relay A/VFMA (Continued)

Coil Data

| | |
|--------------------|----------|
| Coil voltage range | 12/24VDC |
|--------------------|----------|

Coil versions, DC coil

| Coil code | Rated voltage VDC | Operate voltage VDC | Release voltage VDC | Coil resistance ⁷⁾ Ω±10% | Rated coil power ⁷⁾ W |
|-----------|-------------------|---------------------|---------------------|-------------------------------------|----------------------------------|
| 001 | 12 | 7.2 | 1.6 | 119 | 1.20 |
| 002 | 24 | 14.4 | 3.6 | 430 | 1.34 |
| 005 | 12 | 7.2 | 1.6 | 144 | 1.00 |
| F | 12 | 7.2 | 1.2 | 90 | 1.60 |
| H | 24 | 14.4 | 3.6 | 430 | 1.34 |

All figures are given for coil without pre-energization, at ambient temperature +23°C.

7) Without components in parallel.

Coil operating range

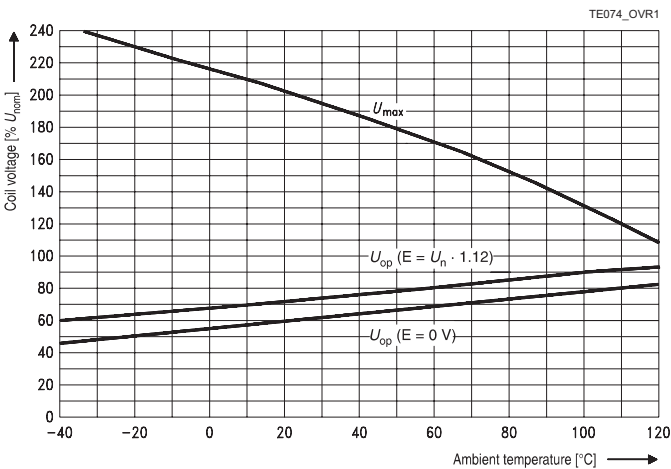

Does not take into account the temperature rise due to the contact current
E = pre-energization.

Insulation Data

| | |
|----------------------------------|-----------------------|
| Initial dielectric strength | |
| between open contacts | 500VAC _{rms} |
| between contact and coil | 500VAC _{rms} |
| Load dump test | |
| ISO 7637-1 (12VDC), test pulse 5 | Vs=+86.5VDC |
| ISO 7637-2 (24VDC), test pulse 5 | Vs=+200VDC |

Other Data

| | |
|--|--|
| EU RoHS/ELV compliance | compliant |
| Ambient temperature | -40 to +125°C |
| Climatic cycling with condensation, EN ISO 6988 | 6 cycles, storage 8/16h |
| Temperature cycling, IEC 60068-2-14, Nb | 10 cycles, -40/+85°C (5°C/min) |
| Damp heat cyclic, IEC 60068-2-30, Db, Variant 1 | 6 cycles, upper air temp. 55°C |
| Damp heat constant, IEC 60068-2-3 (78), Ca | 56 days |
| Category of environmental protection, IEC 61810 | RT I – dustproof |
| Degree of protection, IEC 60529 | IP54 |
| Corrosive gas | |
| IEC 60068-2-42 | 10±2cm ³ /m ³ SO ₂ , 10 days |
| IEC 60068-2-43 | 1±0.3cm ³ /m ³ H ₂ S, 10 days |
| Vibration resistance (functional) IEC 60068-2-6 (sine sweep) | 10 to 500Hz min. 5g ⁸⁾ |
| Shock resistance (functional) IEC 60068-2-27 (half sine) | min. 20g 11ms ⁸⁾ |
| Drop test, free fall, IEC 60068-2-32 | 1m onto concrete |
| Terminal type | plug-in, QC |
| Cover retention | |
| axial force | 150N |
| pull force | 150N |
| push force | 200N |
| Terminal retention | |
| pull force | 100N |
| push force | 100N |
| resistance to bending | 10N ⁹⁾ |
| force applied to side | 10N ⁹⁾ |
| torque | 0.3Nm |
| Weight | approx. 16 to 20g (0.5 to 0.7oz) |
| Packaging unit | |
| Micro A | 480 pcs. |
| VFMA | 600 pcs. |
| 8) No change in the switching state >10µs. Valid for NC contacts, NO contact values significantly higher. | |
| 9) Values apply 2mm from the end of the terminal. When the force is removed, the terminal must not have moved by more than 0.3mm | |

Accessories

| | |
|---------------------------|---------------------------------|
| For details see datasheet | Connectors for Micro ISO Relays |
|---------------------------|---------------------------------|

Terminal Assignment

NOD
1 form A, 1 NO with diode

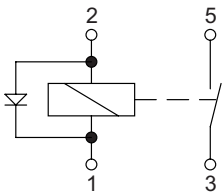

NOR
1 form A, 1 NO with resistor

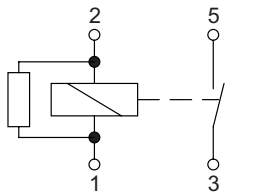

COD
1 form C, 1 CO with diode

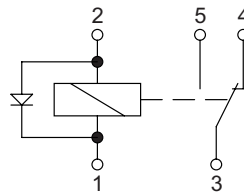

COR
1 form C, 1 CO with resistor

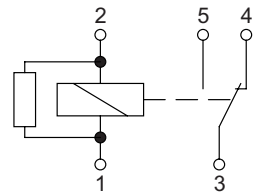

Micro Relay A/VFMA (Continued)

Dimensions

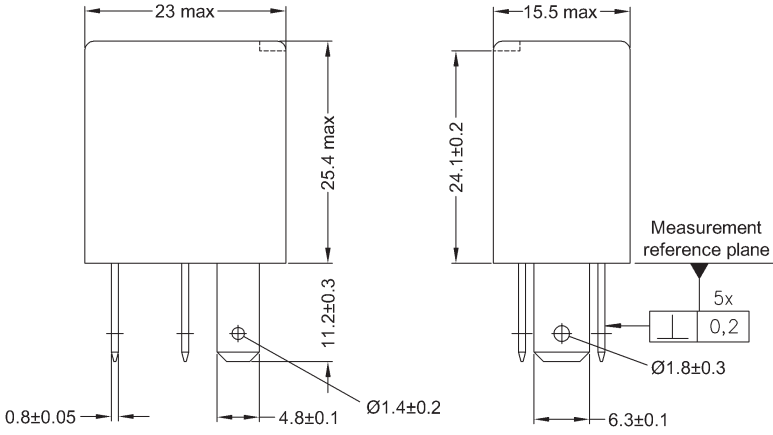

Quick connect terminal similar to ISO 8092-1.
Micro A: Terminals without holes
VFMA: Terminals with holes

View of the terminals (bottom view)



Positional tolerances: ⊕ 0,15

Micro Relay A/VFMA (Continued)

| | | | | | | | | | |
|-------------------------------|--|----------------------|--|---------------|---------------------------------------|----------|------------|--------------------------------|-----------|
| Product code structure | | Typical product code | | V23074 | -A | 1 | 001 | -A4 | 02 |
| Type | | | | | | | | | |
| V23074 | | Micro Relay A | | | | | | | |
| Version | | | | | | | | | |
| A | | Standard | | H | High current | | | | |
| Coil suppression | | | | | | | | | |
| 1 | | Resistor | | 2 | Diode | | | | |
| Coil | | | | | | | | | |
| 001 | | 12VDC | | 002 | 24VDC | | 005 | 12VDC for high current version | |
| Contact material | | | | | | | | | |
| -A4 | | Silver based | | -A5 | Silver based for high current version | | | | |
| Contact arrangement | | | | | | | | | |
| 02 | | 1 form A, 1 NO | | 03 | 1 form C, 1 NO | | | | |

| | | | | | | | | | | |
|-------------------------------|--|----------------------|--|-------------|---------------------------------------|----------|----------|----------|----------|-------------|
| Product code structure | | Typical product code | | VFMA | -1 | 1 | F | 4 | 1 | -S01 |
| Type | | | | | | | | | | |
| VFMA | | VFMA Series | | | | | | | | |
| Version | | | | | | | | | | |
| 1 | | Standard | | | | | | | | |
| Contact arrangement | | | | | | | | | | |
| 1 | | 1 form A, 1 NO | | 5 | 1 form C, 1 CO | | | | | |
| Coil | | | | | | | | | | |
| F | | 12VDC | | H | 24VDC | | | | | |
| Contact material | | | | | | | | | | |
| 4 | | Silver based | | 7 | Silver based for high current version | | | | | |
| Terminals | | | | | | | | | | |
| 1 | | Plug-in | | | | | | | | |
| Coil suppression | | | | | | | | | | |
| S01 | | Resistor | | | | | | | | |

| Product code | Equivalent to | Version | Coil suppr. | Circuit ¹⁾ | Cover Color | Coil | Arrangement | Terminals | Part number |
|-------------------|-------------------|--------------|----------------|-----------------------|-------------|-------|----------------|-------------|-------------|
| V23074-A1001-A402 | VFMA-11F41-S01 | Standard | Resistor 680Ω | NOR | Black | 12VDC | 1 form A, 1 NO | Plug-in, QC | 4-1904124-2 |
| VFMA-11F41-S01 | V23074-A1001-A402 | | | | | | | | 9-1393292-9 |
| V23074-A1001-A403 | VFMA-15F41-S01 | | | COR | | | 1 form C, 1 CO | | 4-1904124-3 |
| VFMA-15F41-S01 | V23074-A1001-A403 | | | | | | | | 1393293-8 |
| V23074-A2001-A402 | V23074-A2201-X147 | | Diode | NOD | | | 1 form A, 1 NO | | 5-1393292-8 |
| V23074-A2201-X147 | V23074-A2001-A402 | | | | Blue | | | | 5-1904135-9 |
| V23074-A2001-A403 | V23074-A2101-X148 | | | COD | Black | | 1 form C, 1 CO | | 6-1419137-4 |
| V23074-A2101-X148 | V23074-A2001-A403 | | | | Red | | | | 6-1904135-0 |
| V23074-H1005-A502 | | High current | Resistor 1000Ω | NOR | Black | | 1 form A, 1 NO | | 4-1904124-4 |
| V23074-A1002-A402 | VFMA-11H41-S01 | Standard | Resistor 1800Ω | | | 24VDC | | | 8-1393292-9 |
| VFMA-11H41-S01 | V23074-A1002-A402 | | | | | | | | 6-1415008-2 |
| V23074-A1002-A403 | | | | COR | | | 1 form C, 1 CO | | 3-1393292-8 |
| V23074-A2002-A402 | | | Diode | NOD | | | 1 form A, 1 NO | | 6-1393292-2 |
| V23074-A2002-A403 | | | | COD | | | 1 form C, 1 CO | | 6-1393292-3 |

1) See terminal assignment diagrams.

Other types on request.

This list represents the most common types and does not show all variants covered by this datasheet.

Production in Asia (only)

| Product code | Version | Coil suppression | Circuit ¹⁾ | Cover Color | Coil | Arrangement | Terminals | Part number |
|-------------------|--------------|------------------|-----------------------|-------------|-------|----------------|-------------|-------------|
| V23074-A1001-A402 | Standard | Resistor 680Ω | NOR | Black | 12VDC | 1 form A, 1 NO | Plug-in, QC | 1393292-5 |
| V23074-A1001-A403 | | | COR | | | 1 form C, 1 CO | | 8-1393292-4 |
| V23074-A2001-A402 | | Diode | NOD | | | 1 form A, 1 NO | | 2-1904111-7 |
| V23074-A2001-A403 | | | COD | | | 1 form C, 1 CO | | 9-1904105-7 |
| V23074-H1005-A502 | High current | Resistor 1000Ω | NOR | | | 1 form A, 1 NO | | 2-1414971-4 |

1) See terminal assignment diagrams.

Other types on request.

This list represents the most common types and does not show all variants covered by this datasheet.

Данный компонент на территории Российской Федерации

Вы можете приобрести в компании MosChip.

Для оперативного оформления запроса Вам необходимо перейти по данной ссылке:

<http://moschip.ru/get-element>

Вы можете разместить у нас заказ для любого Вашего проекта, будь то серийное производство или разработка единичного прибора.

В нашем ассортименте представлены ведущие мировые производители активных и пассивных электронных компонентов.

Нашей специализацией является поставка электронной компонентной базы двойного назначения, продукции таких производителей как XILINX, Intel (ex.ALTERA), Vicor, Microchip, Texas Instruments, Analog Devices, Mini-Circuits, Amphenol, Glenair.

Сотрудничество с глобальными дистрибьюторами электронных компонентов, предоставляет возможность заказывать и получать с международных складов практически любой перечень компонентов в оптимальные для Вас сроки.

На всех этапах разработки и производства наши партнеры могут получить квалифицированную поддержку опытных инженеров.

Система менеджмента качества компании отвечает требованиям в соответствии с ГОСТ Р ИСО 9001, ГОСТ РВ 0015-002 и ЭС РД 009

Офис по работе с юридическими лицами:

105318, г.Москва, ул.Щербаковская д.3, офис 1107, 1118, ДЦ «Щербаковский»

Телефон: +7 495 668-12-70 (многоканальный)

Факс: +7 495 668-12-70 (доб.304)

E-mail: info@moschip.ru

Skype отдела продаж:

moschip.ru

moschip.ru_4

moschip.ru_6

moschip.ru_9