



RF Power GaN Transistor

This 32 W RF power GaN transistor is designed for cellular base station applications covering the frequency range of 3400 to 3600 MHz.

This part is characterized and performance is guaranteed for applications operating in the 3400 to 3600 MHz band. There is no guarantee of performance when this part is used in applications designed outside of these frequencies.

3500 MHz

- Typical Single-Carrier W-CDMA Performance: $V_{DD} = 48$ Vdc, $I_{DQ} = 190$ mA, $P_{out} = 32$ W Avg., Input Signal PAR = 9.9 dB @ 0.01% Probability on CCDF.

Frequency	G_{ps} (dB)	η_D (%)	Output PAR (dB)	ACPR (dBc)	IRL (dB)
3400 MHz	15.6	37.2	7.0	-33.6	-16
3500 MHz	15.7	36.7	7.2	-34.1	-16
3600 MHz	15.9	38.9	7.2	-33.2	-13

Features

- High Terminal Impedances for Optimal Broadband Performance
- Designed for Digital Predistortion Error Correction Systems
- Optimized for Doherty Applications

A2G35S160-01SR3

**3400–3600 MHz, 32 W AVG., 48 V
 AIRFAST RF POWER GaN
 TRANSISTOR**

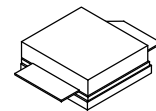

NI-400S-2S

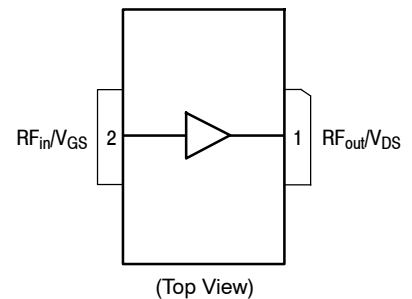

Figure 1. Pin Connections



Table 1. Maximum Ratings

Rating	Symbol	Value	Unit
Drain-Source Voltage	V_{DSS}	125	Vdc
Gate-Source Voltage	V_{GS}	-8, 0	Vdc
Operating Voltage	V_{DD}	0 to +55	Vdc
Maximum Forward Gate Current @ $T_C = 25^\circ\text{C}$	I_{GMAX}	19	mA
Storage Temperature Range	T_{stg}	-65 to +150	$^\circ\text{C}$
Case Operating Temperature Range	T_C	-55 to +150	$^\circ\text{C}$
Operating Junction Temperature Range	T_J	-55 to +225	$^\circ\text{C}$
Absolute Maximum Junction Temperature (1)	T_{MAX}	275	$^\circ\text{C}$

Table 2. Thermal Characteristics

Characteristic	Symbol	Value	Unit
Thermal Resistance by Infrared Measurement, Active Die Surface-to-Case Case Temperature 76°C , $P_D = 66\text{ W}$	$R_{\theta JC}$ (IR)	1.9 (2)	$^\circ\text{C}/\text{W}$
Thermal Resistance by Finite Element Analysis, Junction-to-Case Case Temperature 85°C , $P_D = 65\text{ W}$	$R_{\theta JC}$ (FEA)	2.5 (3)	$^\circ\text{C}/\text{W}$

Table 3. ESD Protection Characteristics

Test Methodology	Class
Human Body Model (per JESD22-A114)	1A
Machine Model (per EIA/JESD22-A115)	A
Charge Device Model (per JESD22-C101)	IV

Table 4. Electrical Characteristics ($T_A = 25^\circ\text{C}$ unless otherwise noted)

Characteristic	Symbol	Min	Typ	Max	Unit
----------------	--------	-----	-----	-----	------

Off Characteristics

Drain-Source Breakdown Voltage ($V_{GS} = -8\text{ Vdc}$, $I_D = 18.9\text{ mAdc}$)	$V_{(BR)DSS}$	150	—	—	Vdc
---	---------------	-----	---	---	-----

On Characteristics

Gate Threshold Voltage ($V_{DS} = 10\text{ Vdc}$, $I_D = 18.9\text{ mAdc}$)	$V_{GS(th)}$	-3.8	-3.1	-2.3	Vdc
Gate Quiescent Voltage ($V_{DD} = 48\text{ Vdc}$, $I_D = 190\text{ mAdc}$, Measured in Functional Test)	$V_{GS(Q)}$	-3.6	-2.6	-2.3	Vdc
Gate-Source Leakage Current ($V_{DS} = 0\text{ Vdc}$, $V_{GS} = -5\text{ Vdc}$)	I_{GSS}	-5.9	—	—	mAdc

- Functional operation above 225°C has not been characterized and is not implied. Operation at T_{MAX} (275°C) reduces median time to failure by an order of magnitude; operation beyond T_{MAX} could cause permanent damage.
- Refer to AN1955, *Thermal Measurement Methodology of RF Power Amplifiers*. Go to <http://www.nxp.com/RF> and search for AN1955.
- $R_{\theta JC}$ (FEA) must be used for purposes related to reliability and limitations on maximum junction temperature. MTTF may be estimated by the expression $MTTF$ (hours) = $10^{[A + B/(T + 273)]}$, where T is the junction temperature in degrees Celsius, $A = -8.44$ and $B = 7210$.

(continued)

Table 4. Electrical Characteristics ($T_A = 25^\circ\text{C}$ unless otherwise noted) (continued)

Characteristic	Symbol	Min	Typ	Max	Unit
Functional Tests ⁽¹⁾ (In Freescale Test Fixture, 50 ohm system) $V_{DD} = 48\text{ Vdc}$, $I_{DQ} = 190\text{ mA}$, $P_{out} = 32\text{ W Avg.}$, $f = 3500\text{ MHz}$, Single-Carrier W-CDMA, IQ Magnitude Clipping, Input Signal PAR = 9.9 dB @ 0.01% Probability on CCDF. ACPR measured in 3.84 MHz Channel Bandwidth @ $\pm 5\text{ MHz}$ Offset. [See note on correct biasing sequence.]					
Power Gain	G_{ps}	13.5	15.7	18.0	dB
Drain Efficiency	η_D	31.6	36.7	—	%
Output Peak-to-Average Ratio @ 0.01% Probability on CCDF	PAR	6.6	7.2	—	dB
Adjacent Channel Power Ratio	ACPR	—	-34.1	-31.8	dBc
Input Return Loss	IRL	—	-16	-8	dB

Load Mismatch (In Freescale Test Fixture, 50 ohm system) $I_{DQ} = 190\text{ mA}$, $f = 3500\text{ MHz}$, 12 $\mu\text{sec}(\text{on})$, 10% Duty Cycle

VSWR 10:1 at 55 Vdc, 153 W Pulsed CW Output Power (3 dB Input Overdrive from 126 W Pulsed CW Rated Power)	No Device Degradation
---	-----------------------

Typical Performance (In Freescale Test Fixture, 50 ohm system) $V_{DD} = 48\text{ Vdc}$, $I_{DQ} = 190\text{ mA}$, 3400–3600 MHz Bandwidth

P_{out} @ 1 dB Compression Point, CW	P1dB	—	126	—	W
P_{out} @ 3 dB Compression Point ⁽²⁾	P3dB	—	162	—	W
AM/PM (Maximum value measured at the P3dB compression point across the 3400–3600 MHz bandwidth)	Φ	—	-15.6	—	°
VBW Resonance Point (IMD Third Order Intermodulation Inflection Point)	VBW _{res}	—	110	—	MHz
Gain Flatness in 200 MHz Bandwidth @ $P_{out} = 32\text{ W Avg.}$	G_F	—	0.5	—	dB
Gain Variation over Temperature (-30°C to +85°C)	ΔG	—	0.02	—	dB/°C
Output Power Variation over Temperature (-30°C to +85°C)	ΔP_{1dB}	—	0.01	—	dB/°C

Table 5. Ordering Information

Device	Tape and Reel Information	Package
A2G35S160-01SR3	R3 Suffix = 250 Units, 32 mm Tape Width, 13-inch Reel	NI-400S-2S

- Part internally input matched.
- P3dB = $P_{avg} + 7.0\text{ dB}$ where P_{avg} is the average output power measured using an unclipped W-CDMA single-carrier input signal where output PAR is compressed to 7.0 dB @ 0.01% probability on CCDF.

NOTE: Correct Biasing Sequence for GaN Depletion Mode Transistors**Turning the device ON**

- Set V_{GS} to the pinch-off (V_P) voltage, typically -5 V
- Turn on V_{DS} to nominal supply voltage (50 V)
- Increase V_{GS} until I_{DS} current is attained
- Apply RF input power to desired level

Turning the device OFF

- Turn RF power off
- Reduce V_{GS} down to V_P , typically -5 V
- Reduce V_{DS} down to 0 V (Adequate time must be allowed for V_{DS} to reduce to 0 V to prevent severe damage to device.)
- Turn off V_{GS}

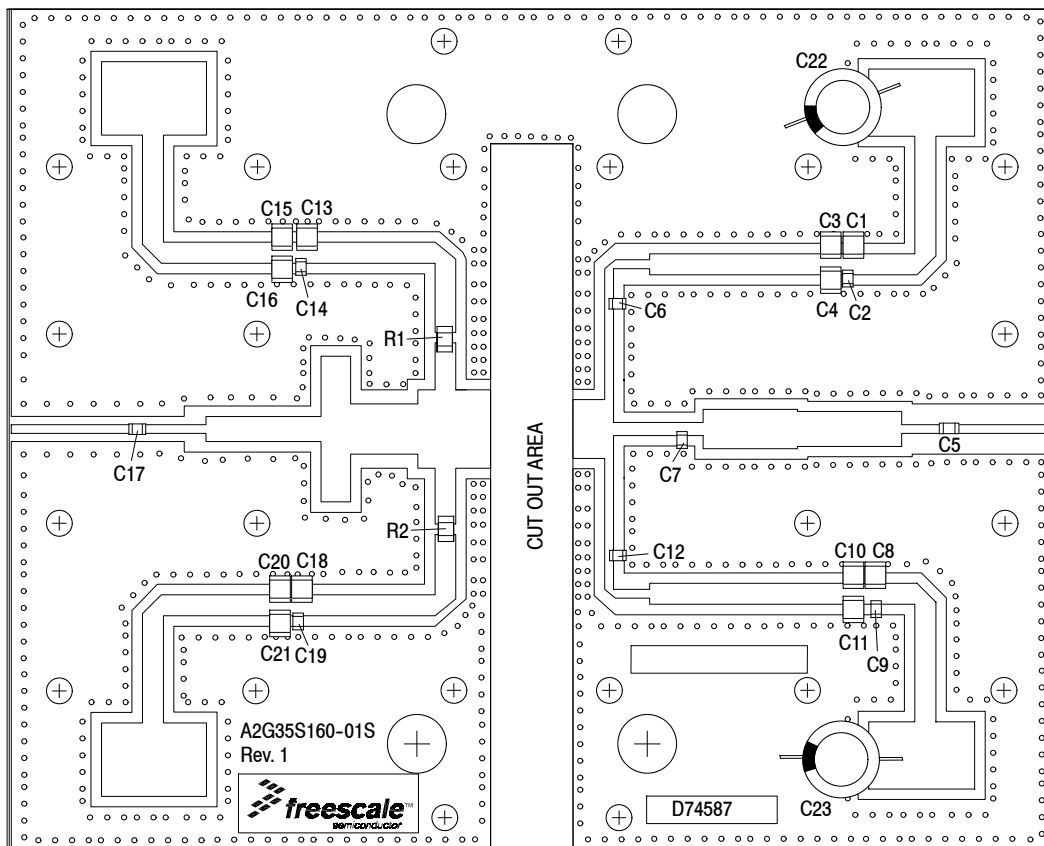

Figure 2. A2G35S160-01SR3 Test Circuit Component Layout

Table 6. A2G35S160-01SR3 Test Circuit Component Designations and Values

Part	Description	Part Number	Manufacturer
C1, C8, C13, C18	0.022 μ F Chip Capacitors	GRM31MR72A223KA01L	Murata
C2, C9, C14, C19	1 nF Chip Capacitors	GRM1885C2A102JA01D	Murata
C3, C10, C15, C20	1 μ F Chip Capacitors	GRM31CR72A105KA01L	Murata
C4, C11, C16, C21	10 μ F Chip Capacitors	GRM32ER61H106KA12L	Murata
C5, C17	12 pF Chip Capacitors	GQM1875C2E120FB12D	Murata
C6, C12	15 pF Chip Capacitors	GQM1875C2E150JB12D	Murata
C7	0.6 pF Chip Capacitor	ATC600F0R6BW250XT	ATC
C22, C23	330 μ F, 63 V Electrolytic Capacitors	MCRH63V337M13X21-RH	Multicomp
R1, R2	5.60 Ω , 1/4 W Chip Resistors	CRCW12065R60FKEA	Vishay
PCB	Rogers RO4350B, 0.023", $\epsilon_r = 3.66$	D74587	MTL

TYPICAL CHARACTERISTICS — 3400–3600 MHz

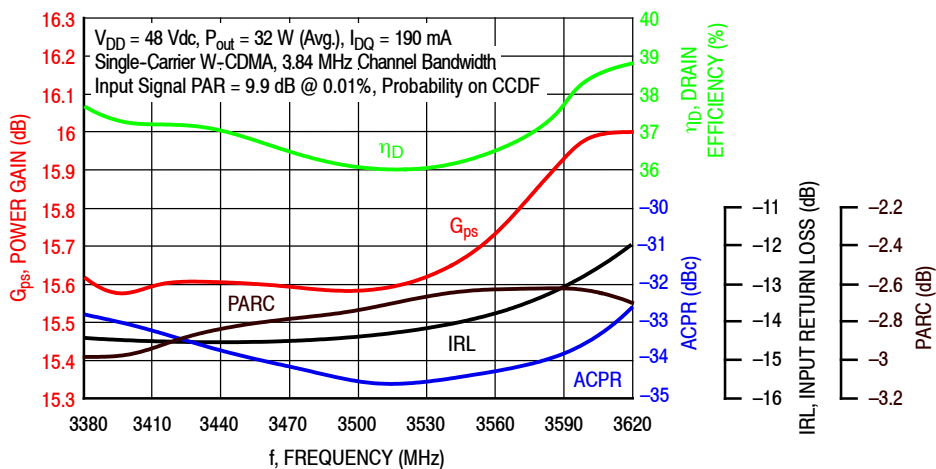

Figure 3. Single-Carrier Output Peak-to-Average Ratio Compression (PARC) Broadband Performance @ $P_{out} = 32$ Watts Avg.

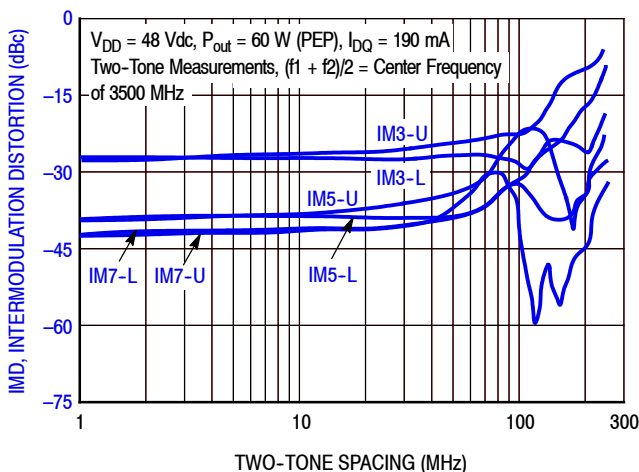

Figure 4. Intermodulation Distortion Products versus Two-Tone Spacing

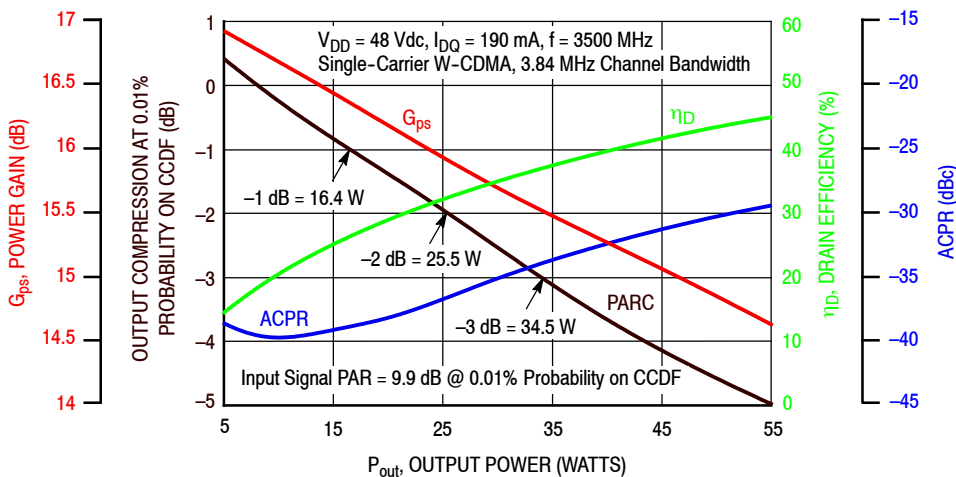

Figure 5. Output Peak-to-Average Ratio Compression (PARC) versus Output Power

TYPICAL CHARACTERISTICS — 3400–3600 MHz

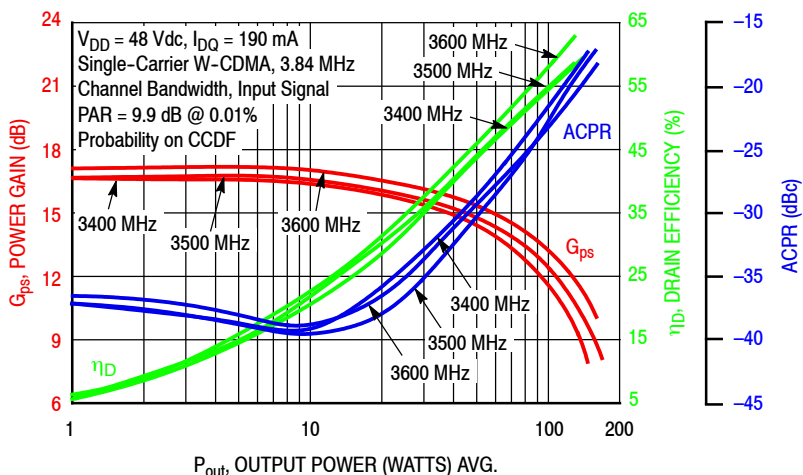

Figure 6. Single-Carrier W-CDMA Power Gain, Drain Efficiency and ACPR versus Output Power

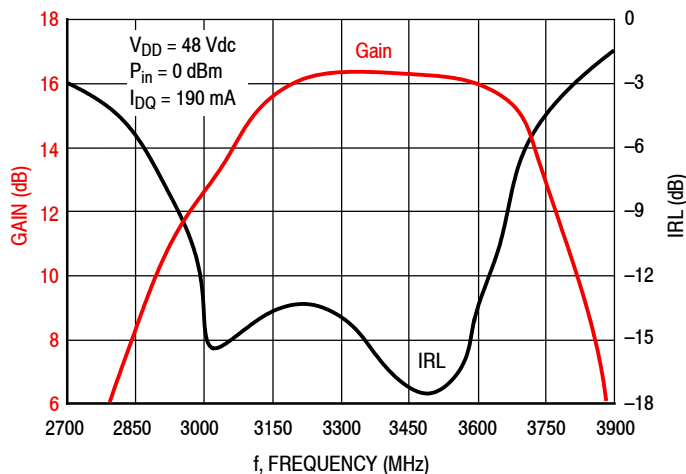
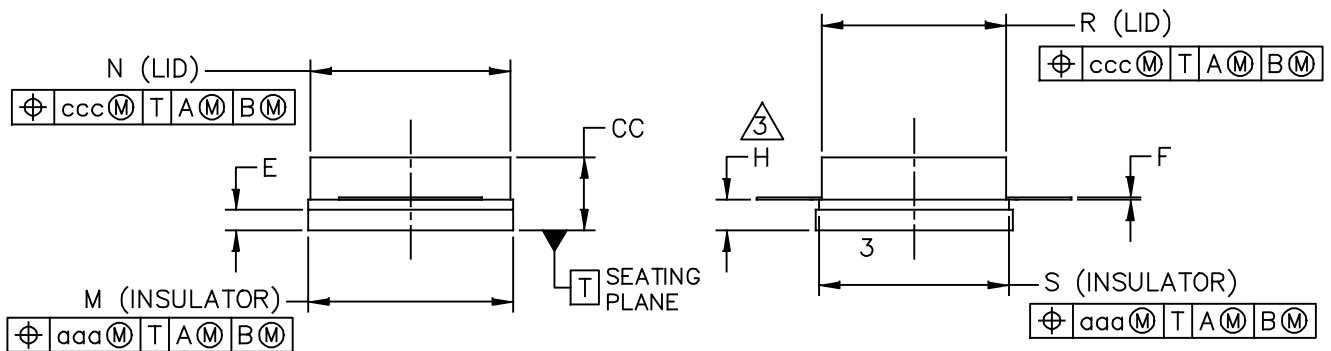
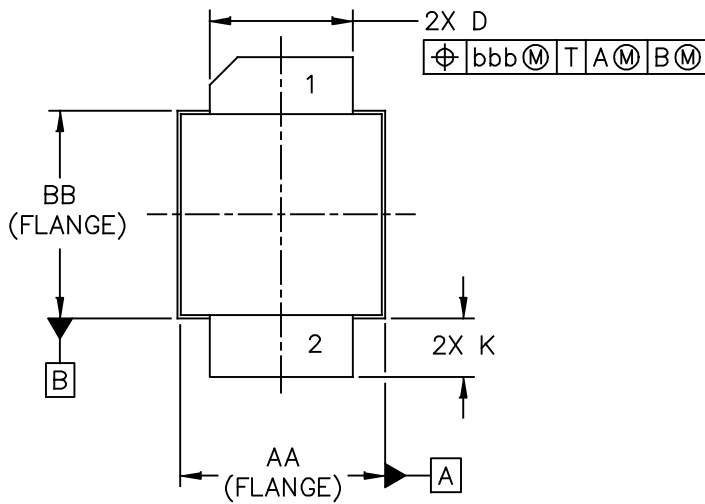

Figure 7. Broadband Frequency Response

PACKAGE DIMENSIONS



© NXP SEMICONDUCTORS N.V. ALL RIGHTS RESERVED	MECHANICAL OUTLINE	PRINT VERSION NOT TO SCALE
TITLE: NI-400S-2S	DOCUMENT NO: 98ASA10732D	REV: C
	STANDARD: NON-JEDEC	
	SOT1828-1	13 JAN 2016

NOTES:

1. CONTROLLING DIMENSION: INCH
2. INTERPRET DIMENSIONS AND TOLERANCES PER ASME Y14.5M-1994.

③ DIMENSION H IS MEASURED .030 INCH (0.762 MM) AWAY FROM THE FLANGE TO CLEAR THE EPOXY FLOW OUT REGION PARALLEL TO DATUM B.

4. INPUT & OUTPUT LEADS (PIN 1 & 2) MAY HAVE SMALL FEATURES SUCH AS SQUARE HOLES OR NOTCHES FOR MANUFACTURING CONVENIENCE.

DIM	INCH		MILLIMETER		DIM	INCH		MILLIMETER	
	MIN	MAX	MIN	MAX		MIN	MAX	MIN	MAX
AA	.395	.405	10.03	10.29	aaa	.005		0.13	
BB	.382	.388	9.70	9.86	bbb	.010		0.25	
CC	.125	.163	3.18	4.14	ccc	.015		0.38	
D	.275	.285	6.98	7.24					
E	.035	.045	0.89	1.14					
F	.004	.006	0.10	0.15					
H	.057	.067	1.45	1.70					
K	.0995	.1295	2.53	3.29					
M	.395	.405	10.03	10.29					
N	.385	.395	9.78	10.03					
R	.355	.365	9.02	9.27					
S	.365	.375	9.27	9.53					
© NXP SEMICONDUCTORS N.V. ALL RIGHTS RESERVED			MECHANICAL OUTLINE			PRINT VERSION NOT TO SCALE			
TITLE: NI-400S-2S					DOCUMENT NO: 98ASA10732D			REV: C	
					STANDARD: NON-JEDEC				
					SOT1828-1			13 JAN 2016	

PRODUCT DOCUMENTATION, SOFTWARE AND TOOLS

Refer to the following resources to aid your design process.

Application Notes

- AN1955: Thermal Measurement Methodology of RF Power Amplifiers

Engineering Bulletins

- EB212: Using Data Sheet Impedances for RF LDMOS Devices

Software

- RF High Power Model
- .s2p File

Development Tools

- Printed Circuit Boards

To Download Resources Specific to a Given Part Number:

1. Go to <http://www.nxp.com/RF>
2. Search by part number
3. Click part number link
4. Choose the desired resource from the drop down menu

REVISION HISTORY

The following table summarizes revisions to this document.

Revision	Date	Description
0	May 2016	• Initial Release of Data Sheet

How to Reach Us:

Home Page:
freescale.com

Web Support:
freescale.com/support

Information in this document is provided solely to enable system and software implementers to use Freescale products. There are no express or implied copyright licenses granted hereunder to design or fabricate any integrated circuits based on the information in this document.

Freescale reserves the right to make changes without further notice to any products herein. Freescale makes no warranty, representation, or guarantee regarding the suitability of its products for any particular purpose, nor does Freescale assume any liability arising out of the application or use of any product or circuit, and specifically disclaims any and all liability, including without limitation consequential or incidental damages. "Typical" parameters that may be provided in Freescale data sheets and/or specifications can and do vary in different applications, and actual performance may vary over time. All operating parameters, including "typicals," must be validated for each customer application by customer's technical experts. Freescale does not convey any license under its patent rights nor the rights of others. Freescale sells products pursuant to standard terms and conditions of sale, which can be found at the following address: freescale.com/SalesTermsandConditions.

Freescale and the Freescale logo are trademarks of Freescale Semiconductor, Inc., Reg. U.S. Pat. & Tm. Off. Airfast is a trademark of Freescale Semiconductor, Inc. All other product or service names are the property of their respective owners.

© 2016 Freescale Semiconductor, Inc.



Данный компонент на территории Российской Федерации

Вы можете приобрести в компании MosChip.

Для оперативного оформления запроса Вам необходимо перейти по данной ссылке:

<http://moschip.ru/get-element>

Вы можете разместить у нас заказ для любого Вашего проекта, будь то серийное производство или разработка единичного прибора.

В нашем ассортименте представлены ведущие мировые производители активных и пассивных электронных компонентов.

Нашей специализацией является поставка электронной компонентной базы двойного назначения, продукции таких производителей как XILINX, Intel (ex.ALTERA), Vicor, Microchip, Texas Instruments, Analog Devices, Mini-Circuits, Amphenol, Glenair.

Сотрудничество с глобальными дистрибьюторами электронных компонентов, предоставляет возможность заказывать и получать с международных складов практически любой перечень компонентов в оптимальные для Вас сроки.

На всех этапах разработки и производства наши партнеры могут получить квалифицированную поддержку опытных инженеров.

Система менеджмента качества компании отвечает требованиям в соответствии с ГОСТ Р ИСО 9001, ГОСТ РВ 0015-002 и ЭС РД 009

Офис по работе с юридическими лицами:

105318, г.Москва, ул.Щербаковская д.3, офис 1107, 1118, ДЦ «Щербаковский»

Телефон: +7 495 668-12-70 (многоканальный)

Факс: +7 495 668-12-70 (доб.304)

E-mail: info@moschip.ru

Skype отдела продаж:

moschip.ru

moschip.ru_4

moschip.ru_6

moschip.ru_9