

# HS35 Incremental Optical Encoder









The HS35 combines the rugged, heavy-duty features usually associated with shafted encoders into a hollow shaft style. Its design includes dual bearings and shaft seals for NEMA 4, 13 and IP65 environmental ratings, a rugged metal housing, and a sealed connector or cable gland. The HS35 accommodates shafts up to 1" in diameter. With optional insulating inserts, it can be mounted on smaller diameter shafts. It can be mounted on a through shaft or a blind shaft with a closed cover to maintain its environmental rating. The HS35 is also available with a dual output option (inset) to provide redundant encoder signals, dual resolutions, or to supply two separate controllers from a single encoder. Applications include motor feedback and vector control, printing industries, robotic control, oil service industries, and web process control.



The HS35 Dual Output Encoder

The HS35 Incremental Encoder is available with the following certifications:

-  EN 55011 and EN 61000-6-2
-  CSA Class I, Div 1 Group C&D
-  CENELEC EEX ia IIC T4
-  U.S. Standards Class I, Group A,B,C & D; Class II Group E,F & G
-  Canadian Standards Class I, Zone O, Group IIC
-  Groups: A, B, C, D, F & G

## Mechanical Specifications

- Shaft Bore:** 1.00", 0.875", 0.750", 0.625", 0.500".  
All are supplied with insulating sleeves.
- Allowable Misalignment:** 0.005" T.I.R. on mating shaft 0.75" from shaft end
- Bore Runout:** 0.001" T.I.R. maximum
- Starting Torque at 25°C:** Through shaft version (SS) = 7 in-oz (max);  
Blind shaft version (BS) = 4 in-oz (max)
- Bearings:** 52100 SAE High carbon steel
- Shaft Material:** 416 stainless steel
- Bearing Housing:** Die cast aluminum with protective finish
- Cover:** Die cast aluminum with protective finish
- Bearing Life:** 7.5 X 10<sup>9</sup> revs (50,000 hrs at 2500 RPM)
- Maximum RPM:** 6,000 RPM (see Frequency Response below)
- Moment of Inertia:** 0.019 oz-in-sec<sup>2</sup>
- Weight:** 18 oz typical

## Electrical Specifications

- Code:** Incremental
- Output Format:** 2 channels in quadrature, 1/2 cycle index gated with negative B channel
- Cycles Per Shaft Turn:** 1 to 80,000 (see table A, page 25).  
For resolutions above 5000 see interpolation options on pages 36 and 37
- Supply Voltage:** 5 to 28 VDC available (see note 5)
- Current Requirements:** 100 mA typical + output load, 250 mA (max)
- Voltage/Output:** (see note 5)  
15V/V: Line Driver, 5–15 VDC in, V<sub>out</sub> = V<sub>in</sub>  
28V/V: Line Driver, 5–28 VDC in, V<sub>out</sub> = V<sub>in</sub>  
28V/5: Line Driver, 5–28 VDC in, V<sub>out</sub> = 5 VDC  
28V/OC: Open Collector, 5–28 VDC in, OCout
- Protection Level:** Reverse, overvoltage and output short circuit (See note 5)
- Frequency Response:** 150 kHz (up to 5000 cpt resolution; 300 KHz above 5000 cpt, also see note 7)
- Output Terminations:** See table 1 page 65
- Note:** Consult factory for other electrical options

## Environmental Specifications

- Enclosure Rating:** NEMA 4 & 13 (IP65) when ordered with shaft seal (on units with an MS connector) or a cable gland (on units with cable termination)
- Temperature:** Operating, 0° to 70° C; extended temperature testing up to 105° C available (see note 8); Storage, -25° to 90° C unless extended temperature option called out
- Shock:** 50 g's for 11 msec duration
- Vibration:** 5 to 2000 Hz @ 20 g's
- Humidity:** 98% RH without condensation
- NOTES & TABLES:** All notes and tables referred to in the text can be found on the back of this page.

## HS35 Incremental Ordering Options FOR ASSISTANCE CALL 800-350-2727

Use this diagram, working from left to right to construct your model number (example: HS35F-100- R1-SS-2048-ABZC-28V/V-SM18).

All notes and tables referred to can be found on the back of this page.



**EXPRESS ENCODERS®**  
Items highlighted with    are standard Express Encoders and ship in one to three days.

T2 option is available as a standard HS35 Express Encoder.



Tel: 805-968-0782 / 800-350-2727 | Fax: 805-968-3154 / 800-960-2726  
7230 Hollister Ave., Goleta, CA 93117-2807 | [www.beisensors.com](http://www.beisensors.com)

Specification No. 02063-001 Rev.09-12

# HS35 Incremental Optical Encoder



## Dimensions

### MS Connector Termination



### R1 Tether Block and Pin



### R2 Tether Arm



### Cable Termination



### Dual Output

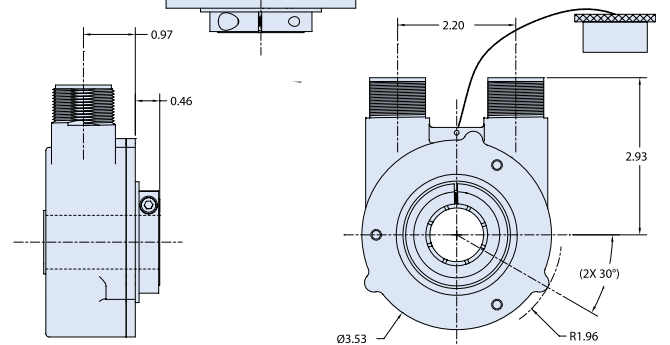

## Table 1

### Incremental Output Terminations

The connector style will determine inputs. For example, an encoder with ABC channels and an M18 connector uses the table to the right.

M18 CONNECTOR		M12 CONNECTOR	
PIN	CHANNEL	PIN	CHANNEL
A	A	A	A
B	B	B	B
C	Z	C	Z
D	+V	D	+V
E	—	E	—
F	0V	F	0V
G	CG	G	CG
H	A	H	A
I	B	J	B
J	Z	K	Z

M16 CONNECTOR	CHANNELS DESIGNATED IN MODEL NO.		
PIN	ABZ	ABC	ABZC
A	A	A	A
B	B	B	B
C	Z	A	Z
D	+V (SUPPLY VOLTAGE)		
E	—	—	B
F	0 V (CIRCUIT COMMON)		
G	CASE GROUND (CG) (except H20)		

WIRE COLOR (22AWG)	DA 15P CONNECTOR	CHANNELS DESIGNATED IN MODEL NO.		
		ABZ	ABC	ABZC
YEL	13	A	A	A
BLUE	14	B	B	B
ORN	15	Z	—	Z
W-Yel	10	—	A	A
W-Blu	11	—	B	B
W-0m	12	—	—	Z
RED	6	+V (SUPPLY VOLTAGE)		
BLK	1	0 V (CIRCUIT COMMON)		
GRN	9	CASE GROUND (CG) (except H20)		
WHITE		SHIELD DRAIN (Shielded Cable Only)		

## Figure 1

### Output Waveform



NOTE: Index location is displaced 180° (mechanical) on second output with dual output option.

## Table A

### HS35 Disc Resolutions

32	100	250	360	420	500	512
600	720	1000	1024	1200		
1500	1650	1800	2000	2100		
2048	2500	2881	2884	3600		
3710	4096	5000				

For interpolation please specify the multiplied output (up to 80,000 for the HS35) in the model number, i.e. 80,000-T16. Other resolutions available—consult factory.

NOTE: Dual resolutions available, consult factory.

## Notes

- Mounting is usually done either using the D-style square flange mount, E- or G-style servo mounts, or one of the standard face mounts, F1 for example. Consult factory for additional face mount options.
- The rubber shaft seal is recommended in virtually all installations. The most common exceptions are applications requiring a very low starting torque or those requiring operation at both high temperature and high speed. For these exceptions, a felt shaft seal is recommended. Felt seals require very low starting torque and can virtually eliminate frictional heat. Encoders ordered with felt shaft seals will have an enclosure rating of IP50 and will have less than 1/10th the Starting Torque specified under Mechanical Configurations.
- Non-standard index widths and multiple indices are available by special order. Consult factory.
- Complementary outputs are recommended for use with line driver type (source/sink) outputs. When used with differential receivers, this combination provides a high degree of noise immunity.
- Output IC's:** Output IC's are available as either Line Driver (LD) or NPN Open Collector (OC) types. Open Collectors require pull-up resistors, resulting in higher output source impedance (sink impedance is similar to that of line drivers). In general, use of a Line Driver style output is recommended. Line Drivers source or sink current and their lower impedance mean better noise immunity and faster switching times. **Warning:** Do not connect any line driver outputs directly to circuit common/0V, which may damage the driver. Unused outputs should be isolated and left floating. Our applications specialists would be pleased to discuss your system requirements and the compatibility of your receiving electronics with Line Driver type outputs.
- 28V/N:** Multi-voltage Line Driver (7272<sup>®</sup>): 100 mA source/sink. Input voltage 5 to 28 VDC +/- 5% standard (Note:  $V_{out} = V_{in}$ ). This driver is TTL compatible when used with 5 volt supply. Supply lines are protected against overvoltage to 60 volts and reverse voltage. Outputs are short circuit protected for one minute. Supply current is 120 mA typical (plus load current). This is the recommended replacement for 3904R and 7406R open collector outputs with internal pullup resistors. It is also a direct replacement for any 4469, 88C30, 8830 or 26LS31 line driver.
- 28V/5:** Multi-voltage Line Driver (7272<sup>®</sup>): 100 mA source/sink. Input voltage 5 to 28 VDC +/- 5% standard, internally regulated with 5V (TTL compatible) logic out. Supply lines are protected against overvoltage to 60 volts and reverse voltage. Outputs are short circuit protected for one minute. Supply current is 90 mA typical (plus load current).
- 15V/I:** Multi-voltage Line Driver (4469<sup>®</sup>): 100 mA source/sink. Input voltage 5 to 15 VDC +/- 5% standard (Note:  $V_{out} = V_{in}$ ). TTL compatible when used with 5 volt supply. Supply lines are protected against overvoltage to 60 volts and reverse voltage. Outputs are short circuit protected for one minute. Supply current is 90 mA typical (plus load current). This is a direct replacement for the 4469 Line Driver.
- 28V/OC:** NPN Open Collector (3904<sup>®</sup>, 7273<sup>®</sup>). Current sink of 80 mA max. Current sourced by external pull-up resistor. Output can be pulled up to voltage other than supply voltage (30 V max). Input voltage 5 to 28 VDC +/- 5% standard. Supply current is 120 mA typical. This replaces prior IC's with designations of 3904, 7406, 3302, 681 and 689. **5V/OCR, 15V/OCR, 24V/OCR:** Open Collector (3904R<sup>®</sup>, 7406R<sup>®</sup>, 7273R<sup>®</sup>): Current sink of 70 mA max. Includes internal pull-ups sized at approximately 100 ohms/volt. Max current source is 10 mA. Supply current is 100 mA typical, 120 mA with internal pull-ups. The 5V/OCR, 15V/OCR and 24V/OCR are often replaced by the 28V/I in system upgrades.
- 3904, 3904R, 4469, 5V/N, 5V/OCR, 5V/OC, 9V/OC:** Intrinsically safe line driver and open collector outputs. These drivers are specific to intrinsically safe encoders, and are installed per the appropriate control drawings listed in Table 2.1 on page 48.
- Special -S at the end of the model number is used to define a variety of non-standard features such as special shaft lengths, voltage options, or special testing. Please consult the factory to discuss your special requirements.
- Higher frequency response may be available. Please consult with the factory.
- Extended temperature ratings are available in the following ranges: -40 to 70°C, -40 to 85°C, -20 to 105°C and -40 to 105°C depending on the particular model. Some models can operate down to -55°C. Extended temperature ranges can affect other performance factors. Consult with factory for more specific information.
- Mating straight plug receptacles may be ordered from the factory:  
For M12 use MS3116F12-10S  
For M14 use MS3106F14S-6S  
For M14/19 use MS3116J14-19S  
For M16 use MS3106F16S-1S  
For M18 use MS3106F18-1S  
For M20 use MS3106F20-29S



Tel: 805-968-0782 / 800-350-2727 | Fax: 805-968-3154 / 800-960-2726  
7230 Hollister Ave., Goleta, CA 93117-2807 | [www.beisensors.com](http://www.beisensors.com)

These commodities, technology or software if exported from the United States must be in accordance with the Bureau of Industry, and Security, Export Administration regulations. Diversion contrary to U.S law is prohibited.

## Данный компонент на территории Российской Федерации

### Вы можете приобрести в компании MosChip.

Для оперативного оформления запроса Вам необходимо перейти по данной ссылке:

<http://moschip.ru/get-element>

Вы можете разместить у нас заказ для любого Вашего проекта, будь то серийное производство или разработка единичного прибора.

В нашем ассортименте представлены ведущие мировые производители активных и пассивных электронных компонентов.

Нашей специализацией является поставка электронной компонентной базы двойного назначения, продукции таких производителей как XILINX, Intel (ex.ALTERA), Vicor, Microchip, Texas Instruments, Analog Devices, Mini-Circuits, Amphenol, Glenair.

Сотрудничество с глобальными дистрибьюторами электронных компонентов, предоставляет возможность заказывать и получать с международных складов практически любой перечень компонентов в оптимальные для Вас сроки.

На всех этапах разработки и производства наши партнеры могут получить квалифицированную поддержку опытных инженеров.

Система менеджмента качества компании отвечает требованиям в соответствии с ГОСТ Р ИСО 9001, ГОСТ РВ 0015-002 и ЭС РД 009

### Офис по работе с юридическими лицами:

105318, г.Москва, ул.Щербаковская д.3, офис 1107, 1118, ДЦ «Щербаковский»

Телефон: +7 495 668-12-70 (многоканальный)

Факс: +7 495 668-12-70 (доб.304)

E-mail: [info@moschip.ru](mailto:info@moschip.ru)

Skype отдела продаж:

moschip.ru

moschip.ru\_4

moschip.ru\_6

moschip.ru\_9