

KAI-08670

3600 (H) x 2400 (V) Interline CCD Image Sensor

Description

The KAI-08670 Image Sensor is an 8.6-megapixel CCD in an APS-H optical format. Based on the TRUESENSE 7.4 micron Interline Transfer CCD Platform, the sensor provides very high smear rejection and up to 82 dB linear dynamic range through the use of a unique dual-gain amplifier. A flexible readout architecture enables use of 1, 2, or 4 outputs for full resolution readout up to 12 frames per second, while a vertical overflow drain structure suppresses image blooming and enables electronic shuttering for precise exposure control.

Table 1. GENERAL SPECIFICATIONS

Parameter	Typical Value
Architecture	Interline CCD, Progressive Scan
Total Number of Pixels	3672 (H) × 2472 (V)
Number of Effective Pixels	3624 (H) × 2424 (V)
Number of Active Pixels	3600 (H) × 2400 (V)
Pixel Size	7.4 μm (H) × 7.4 μm (V)
Active Image Size	26.64 mm (H) × 17.76 mm (V), 32 mm (Diagonal), APS-H Optical Format
Aspect Ratio	3:2
Number of Outputs	1, 2, or 4
Charge Capacity	44,000 electrons
Output Sensitivity	9.7 μV/e ⁻ (Low), 33 μV/e ⁻ (High)
Quantum Efficiency R, G, B (-FXA, -QXA) Pan (-AXA, -QXA)	33%, 39%, 40% 48%
Read Noise (f = 40 MHz)	12 e ⁻ rms
Dark Current Photodiode VCCD	1 e ⁻ /s 145 e ⁻ /s
Dark Current Doubling Temp. Photodiode VCCD	7°C 9°C
Dynamic Range High Gain Amp (40 MHz) Dual Amp, 2×2 Bin (40 MHz)	70 dB 82 dB
Charge Transfer Efficiency	0.999999
Blooming Suppression	> 1000 X
Smear	-115 dB
Image Lag	< 10 electrons
Maximum Pixel Clock Speed	40 MHz
Maximum Frame Rate Quad Output Dual Output Single Output	12 fps 6 fps 3 fps
Package	72 Pin PGA
Cover Glass	AR Coated, 2 Sides

NOTE: All Parameters are specified at T = 40°C unless otherwise noted.



ON Semiconductor®

www.onsemi.com

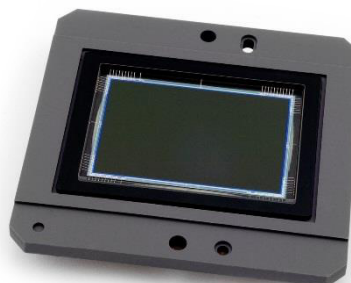

Figure 1. KAI-08670 Interline CCD Image Sensor

Features

- Superior Smear Rejection
- Up to 82 dB Linear Dynamic Range
- Bayer Color Pattern, TRUESENSE Sparse Color Filter Pattern, and Monochrome Configurations
- Progressive Scan & Flexible Readout Architecture
- High Frame Rate
- High Sensitivity – Low Noise Architecture
- Package Pin Reserved for Device Identification

Application

- Industrial Imaging and Inspection
- Traffic
- Surveillance

ORDERING INFORMATION

See detailed ordering and shipping information on page 2 of this data sheet.

KAI-08670

The sensor is available with the TRUESENSE Sparse Color Filter Pattern, a technology which provides a 2x improvement in light sensitivity compared to a standard color Bayer part.

The sensor is package and pin-compatible with the KAI-16050 Image Sensor, and shares common pin-out

and electrical configurations with a full family of ON Semiconductor Interline Transfer CCD image sensors, allowing a single camera design to be leveraged in support of multiple devices.

ORDERING INFORMATION

Table 2. ORDERING INFORMATION – KAI-08670 IMAGE SENSOR

Part Number	Description	Marking Code
KAI-08670-AXA-JD-B1	Monochrome, Special Microlens, PGA Package, Sealed Clear Cover Glass with AR Coating (Both Sides), Grade 1	KAI-08670-AXA Serial Number
KAI-08670-AXA-JD-B2	Monochrome, Special Microlens, PGA Package, Sealed Clear Cover Glass with AR Coating (Both Sides), Grade 2	
KAI-08670-AXA-JD-AE	Monochrome, Special Microlens, PGA Package, Sealed Clear Cover Glass with AR Coating (Both Sides), Engineering Grade	
KAI-08670-FXA-JD-B1	Color (Bayer RGB), Special Microlens, PGA Package, Sealed Clear Cover Glass with AR Coating (Both Sides), Grade 1	KAI-08670-FXA Serial Number
KAI-08670-FXA-JD-B2	Color (Bayer RGB), Special Microlens, PGA Package, Sealed Clear Cover Glass with AR Coating (Both Sides), Grade 2	
KAI-08670-FXA-JD-AE	Color (Bayer RGB), Special Microlens, PGA Package, Sealed Clear Cover Glass with AR Coating (Both Sides), Engineering Grade	
KAI-08670-QXA-JD-B1	Color (TRUESENSE Sparse CFA), Special Microlens, PGA Package, Sealed Clear Cover Glass with AR Coating (Both Sides), Grade 1	KAI-08670-QXA Serial Number
KAI-08670-QXA-JD-B2	Color (TRUESENSE Sparse CFA), Special Microlens, PGA Package, Sealed Clear Cover Glass with AR Coating (Both Sides), Grade 2	
KAI-08670-QXA-JD-AE	Color (TRUESENSE Sparse CFA), Special Microlens, PGA Package, Sealed Clear Cover Glass with AR Coating (Both Sides), Engineering Grade	

Table 3. ORDERING INFORMATION – EVALUATION SUPPORT

Part Number	Description
G2-FPGA-BD-14-40-A-GEVK	FPGA Board for IT-CCD Evaluation Hardware
KAI-72PIN-HEAD-BD-A-GEVB	72 Pin Imager Board for IT-CCD Evaluation Hardware
LENS-MOUNT-KIT-B-GEVK	Lens Mount Kit for IT-CCD Evaluation Hardware

See the ON Semiconductor *Device Nomenclature* document (TND310/D) for a full description of the naming convention used for image sensors. For reference documentation, including information on evaluation kits, please visit our web site at www.onsemi.com.

Bayer Color Filter Pattern

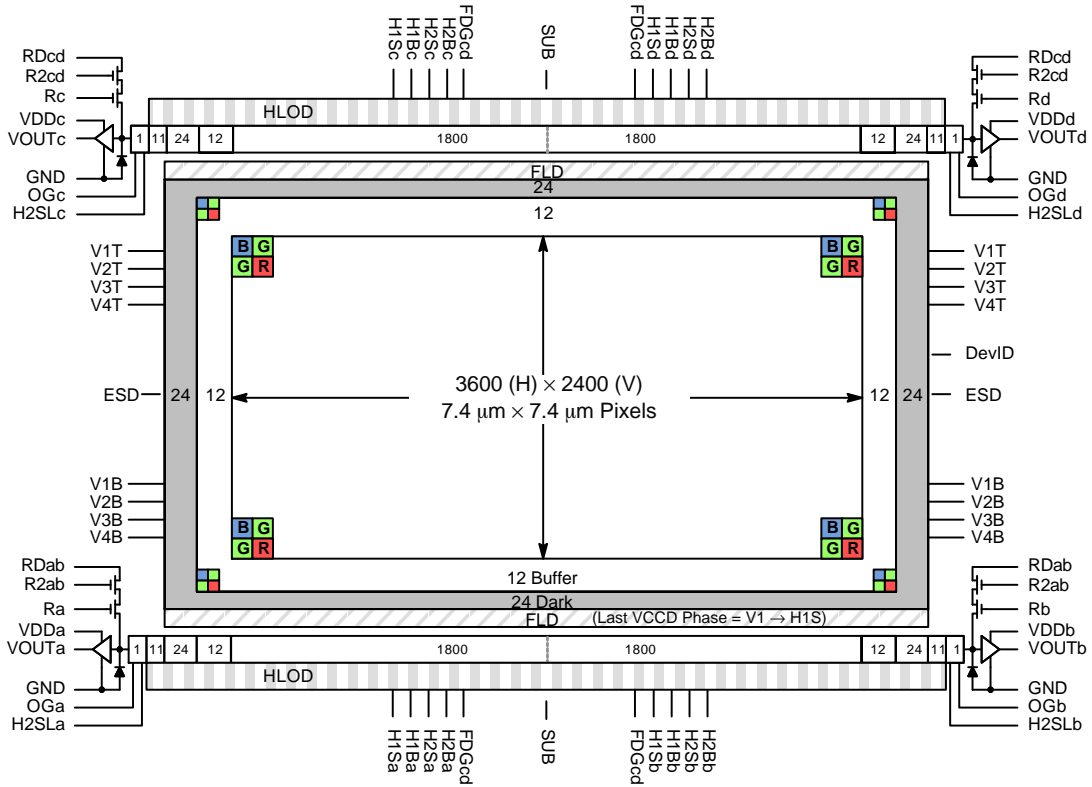

Figure 3. Bayer Color Filter Pattern

TRUESENSE Sparse Color Filter Pattern

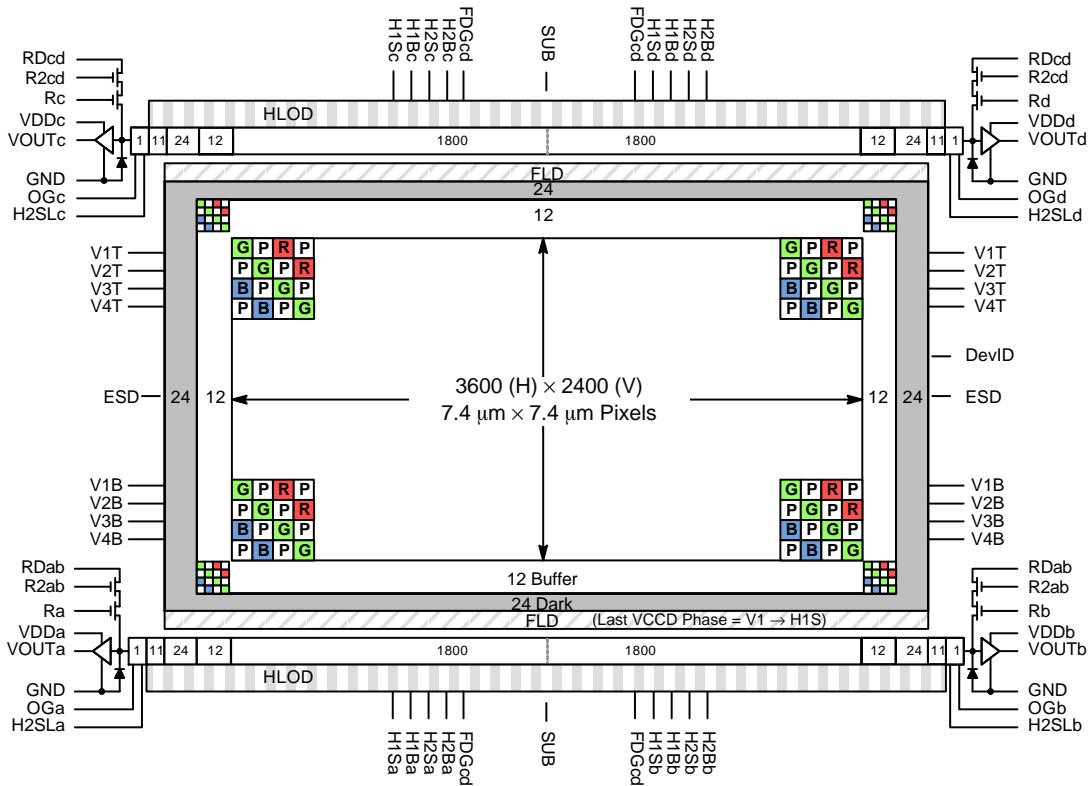

Figure 4. TRUESENSE Sparse Color Filter Pattern

Physical Description

Pin Description and Device Orientation

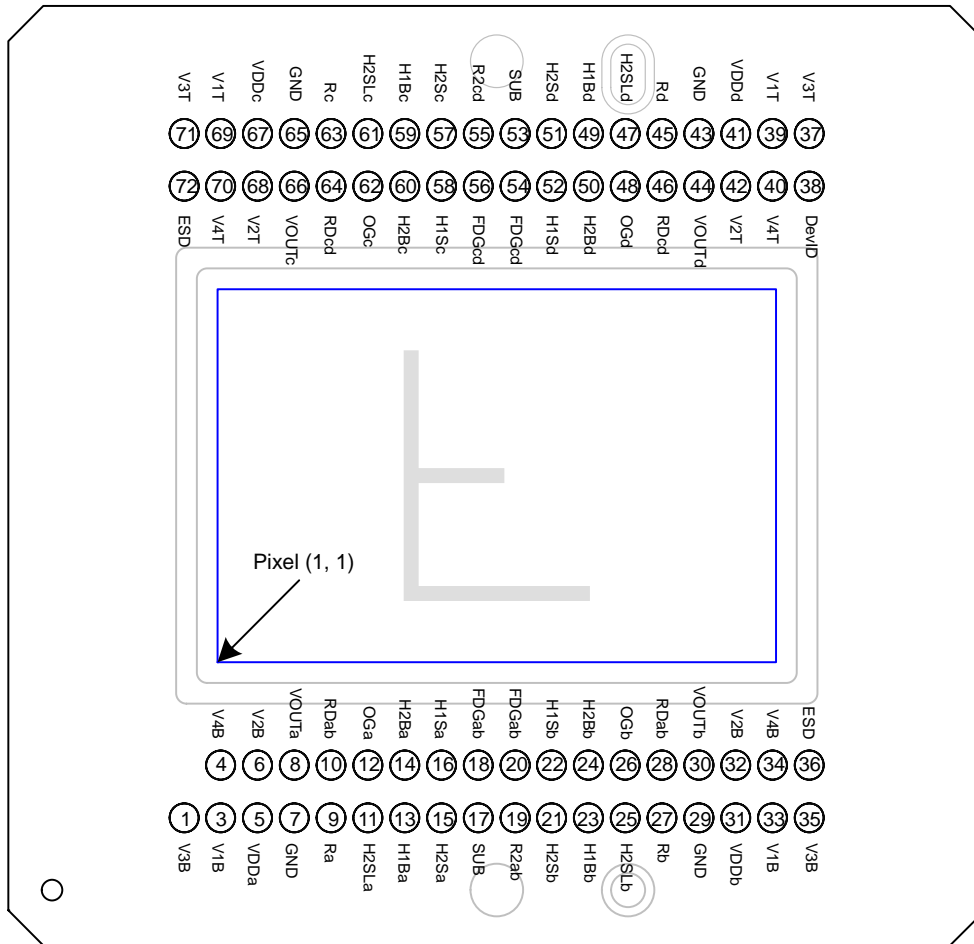

Figure 5. Package Pin Designations – Top View

Table 4. PACKAGE PIN DESCRIPTION

Pin	Name	Description
1	V3B	Vertical CCD Clock, Phase 3, Bottom
3	V1B	Vertical CCD Clock, Phase 1, Bottom
4	V4B	Vertical CCD Clock, Phase 4, Bottom
5	VDDa	Output Amplifier Supply, Quadrant a
6	V2B	Vertical CCD Clock, Phase 2, Bottom
7	GND	Ground
8	VOUa	Video Output, Quadrant a
9	Ra	Reset Gate, Standard (High) Gain, Quadrant a
10	RDab	Reset Drain, Quadrants a & b
11	H2SLa	Horizontal CCD Clock, Phase 2, Storage, Last Phase, Quadrant a
12	OGa	Output Gate, Quadrant a
13	H1Ba	Horizontal CCD Clock, Phase 1, Barrier, Quadrant a
14	H2Ba	Horizontal CCD Clock, Phase 2, Barrier, Quadrant a
15	H2Sa	Horizontal CCD Clock, Phase 2, Storage, Quadrant a

KAI-08670

Table 4. PACKAGE PIN DESCRIPTION (continued)

Pin	Name	Description
16	H1Sa	Horizontal CCD Clock, Phase 1, Storage, Quadrant a
17	SUB	Substrate
18	FDG a b	Fast Line Dump Gate, Bottom
19	R2 a b	Reset Gate, Low Gain, Quadrants a & b
20	FDG a b	Fast Line Dump Gate, Bottom
21	H2 S b	Horizontal CCD Clock, Phase 2, Storage, Quadrant b
22	H1 S b	Horizontal CCD Clock, Phase 1, Storage, Quadrant b
23	H1 B b	Horizontal CCD Clock, Phase 1, Barrier, Quadrant b
24	H2 B b	Horizontal CCD Clock, Phase 2, Barrier, Quadrant b
25	H2 SL b	Horizontal CCD Clock, Phase 1, Storage, Last Phase, Quadrant b
26	O G b	Output Gate, Quadrant b
27	R b	Reset Gate, Standard (High) Gain, Quadrant b
28	R D a b	Reset Drain, Quadrants a & b
29	GND	Ground
30	V O U T b	Video Output, Quadrant b
31	V D D b	Output Amplifier Supply, Quadrant b
32	V 2 B	Vertical CCD Clock, Phase 2, Bottom
33	V 1 B	Vertical CCD Clock, Phase 1, Bottom
34	V 4 B	Vertical CCD Clock, Phase 4, Bottom
35	V 3 B	Vertical CCD Clock, Phase 3, Bottom
36	ESD	ESD Protection Disable
37	V 3 T	Vertical CCD Clock, Phase 3, Top
38	Dev I D	Device Identification
39	V 1 T	Vertical CCD Clock, Phase 1, Top
40	V 4 T	Vertical CCD Clock, Phase 4, Top
41	V D D d	Output Amplifier Supply, Quadrant d
42	V 2 T	Vertical CCD Clock, Phase 2, Top
43	GND	Ground
44	V O U T d	Video Output, Quadrant d
45	R d	Reset Gate, Standard (High) Gain, Quadrant d
46	R D c d	Reset Drain, Quadrants c & d
47	H2 SL d	Horizontal CCD Clock, Phase 2, Storage, Last Phase, Quadrant d
48	O G d	Output Gate, Quadrant d
49	H1 B d	Horizontal CCD Clock, Phase 1, Barrier, Quadrant d
50	H2 B d	Horizontal CCD Clock, Phase 2, Barrier, Quadrant d
51	H2 S d	Horizontal CCD Clock, Phase 2, Storage, Quadrant d
52	H1 S d	Horizontal CCD Clock, Phase 1, Storage, Quadrant d
53	SUB	Substrate
54	FDG c d	Fast Line Dump Gate, Top
55	R2 c d	Reset Gate, Low Gain, Quadrants c & d
56	FDG c d	Fast Line Dump Gate, Top
57	H2 S c	Horizontal CCD Clock, Phase 2, Storage, Quadrant c
58	H1 S c	Horizontal CCD Clock, Phase 1, Storage, Quadrant c
59	H1 B c	Horizontal CCD Clock, Phase 1, Barrier, Quadrant c
60	H2 B c	Horizontal CCD Clock, Phase 2, Barrier, Quadrant c

Table 4. PACKAGE PIN DESCRIPTION (continued)

Pin	Name	Description
61	H2SLc	Horizontal CCD Clock, Phase 2, Storage, Last Phase, Quadrant c
62	OGc	Output Gate, Quadrant c
63	Rc	Reset Gate, Standard (High) Gain, Quadrant c
64	RDcd	Reset Drain, Quadrants c & d
65	GND	Ground
66	VOUc	Video Output, Quadrant c
67	VDDc	Output Amplifier Supply, Quadrant c
68	V2T	Vertical CCD Clock, Phase 2, Top
69	V1T	Vertical CCD Clock, Phase 1, Top
70	V4T	Vertical CCD Clock, Phase 4, Top
71	V3T	Vertical CCD Clock, Phase 3, Top
72	ESD	EDS Protection Disable

1. Liked named pins are internally connected and should have a common drive signal.

IMAGING PERFORMANCE

Table 5. TYPICAL OPERATIONAL CONDITIONS

(Unless otherwise noted, the Imaging Performance Specifications are measured using the following conditions.)

Description	Condition	Notes
Light Source	Continuous Red, Green and Blue LED Illumination.	1
Operation	Nominal Operating Voltages and Timing.	

1. For monochrome sensor, only green LED used.

Specifications

Table 6. PERFORMANCE SPECIFICATIONS

Description	Symbol	Min.	Nom.	Max.	Unit	Sampling Plan	Temperature Tested at (°C)
ALL CONFIGURATIONS							
Dark Field Global Non-Uniformity	DSNU	–	–	5	mVpp	Die	27, 40
Bright Field Global Non-Uniformity (Note 1)		–	2	5	% rms	Die	27, 40
Bright Field Global Peak to Peak Non-Uniformity (Note 1)	PRNU	–	10	30	% pp	Die	27, 40
Bright Field Center Non-Uniformity (Note 1)		–	1	2	% rms	Die	27, 40
Maximum Photo-Response Non-Linearity High Gain (4,000 to 20,000 electrons) Low Gain (8,000 to 80,000 electrons)	NL_HG1 NL_HG2 NL_LG1	– – –	2 3 6	– – –	%	Design	
Maximum Gain Difference between Outputs (Note 2)	ΔG	–	–	10	%	Design	
Horizontal CCD Charge Capacity	H_{Ne}	–	100	–	ke^-	Design	
Vertical CCD Charge Capacity	V_{Ne}	–	60	–	ke^-	Design	
Photodiode Charge Capacity (Note 3)	P_{Ne}	–	44	–	ke^-	Die	27, 40
Floating Diffusion Capacity – High Gain	FNe_HG	40	–	–	ke^-	Die	27, 40
Floating Diffusion Capacity – Low Gain	FNe_LG	160	–	–	ke^-	Die	27, 40
Horizontal CCD Charge Transfer Efficiency	HCTE	0.999995	0.999999	–		Die	
Vertical CCD Charge Transfer Efficiency	VCTE	0.999995	0.999999	–		Die	
Photodiode Dark Current	I_{PD}	–	1	70	e/p/s	Die	40
Vertical CCD Dark Current	I_{VD}	–	145	400	e/p/s	Die	40
Image Lag	Lag	–	–	10	e^-	Design	
Anti-Blooming Factor	X_{AB}	1,000	–	–		Design	
Vertical Smear	Smr	–	–115	–	dB	Design	
Read Noise (Note 4) High Gain Low Gain	n_{e-T}	– –	12 35	– –	e^- rms	Design	
Dynamic Range, Standard (Notes 4, 5)	DR	–	70	–	dB	Design	
Dynamic Range, Extended Linear Dynamic Range Mode (XLDR) (Notes 4, 5)	XLDR	–	82	–	dB	Design	

KAI-08670

Table 6. PERFORMANCE SPECIFICATIONS (continued)

Description	Symbol	Min.	Nom.	Max.	Unit	Sampling Plan	Temperature Tested at (°C)
ALL CONFIGURATIONS							
Output Amplifier DC Offset	V_{ODC}	–	9.0	–	V	Die	27, 40
Output Amplifier Bandwidth (Note 6)	f_{-3db}	–	250	–	MHz	Die	
Output Amplifier Impedance	R_{OUT}	–	127	–	Ω	Die	27, 40
Output Amplifier Sensitivity	$\Delta V/\Delta N$	–	33	–	$\mu V/e^-$	Design	
High Gain		–	9.7	–			
Low Gain		–		–			
KAI-08670-AXA AND KAI-08670-QXA CONFIGURATIONS							
Peak Quantum Efficiency	QE_{MAX}	–	48	–	%	Design	
Peak Quantum Efficiency Wavelength	λ_{QE}	–	490	–	nm	Design	
KAI-08670-FXA AND KAI-08670-QXA CONFIGURATIONS							
Peak Quantum Efficiency	QE_{MAX}	–	33	–	%	Design	
Red		–	39	–			
Green		–	40	–			
Blue		–		–			
Peak Quantum Efficiency Wavelength	λ_{QE}	–	605	–	nm	Design	
Red		–	535	–			
Green		–	455	–			
Blue		–		–			

1. Per color.
2. Value is over the range of 10% to 100% of linear signal level saturation.
3. The operating value of the substrate voltage, V_{AB} , will be marked on the shipping container for each device. The value of V_{AB} is set such that the photodiode charge capacity is 440 mV. This value is determined while operating the device in the low gain mode. V_{AB} value assigned is valid for both modes; high gain or low gain.
4. At 40 MHz.
5. Uses 20LOG (P_{Ne} / n_{e-T}).
6. Assumes 5 pF load.

Linear Signal Range

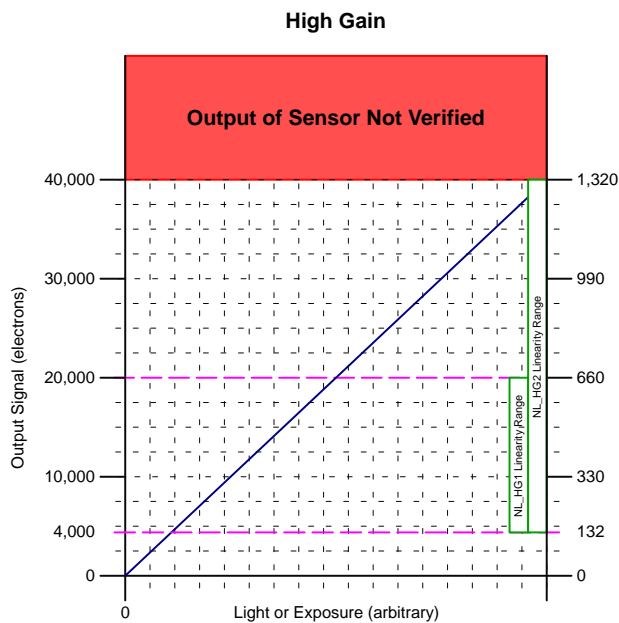

Figure 6. High Gain Linear Signal Range

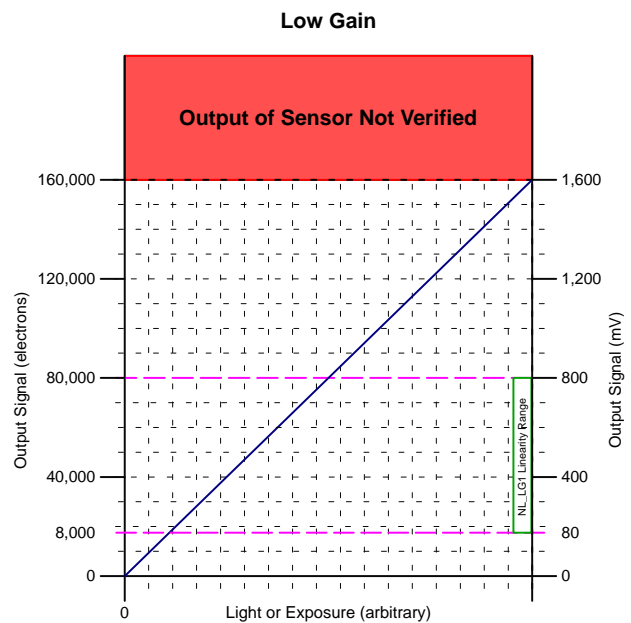

Figure 7. Low Gain Linear Signal Range

TYPICAL PERFORMANCE CURVES

Quantum Efficiency

Monochrome with Microlens

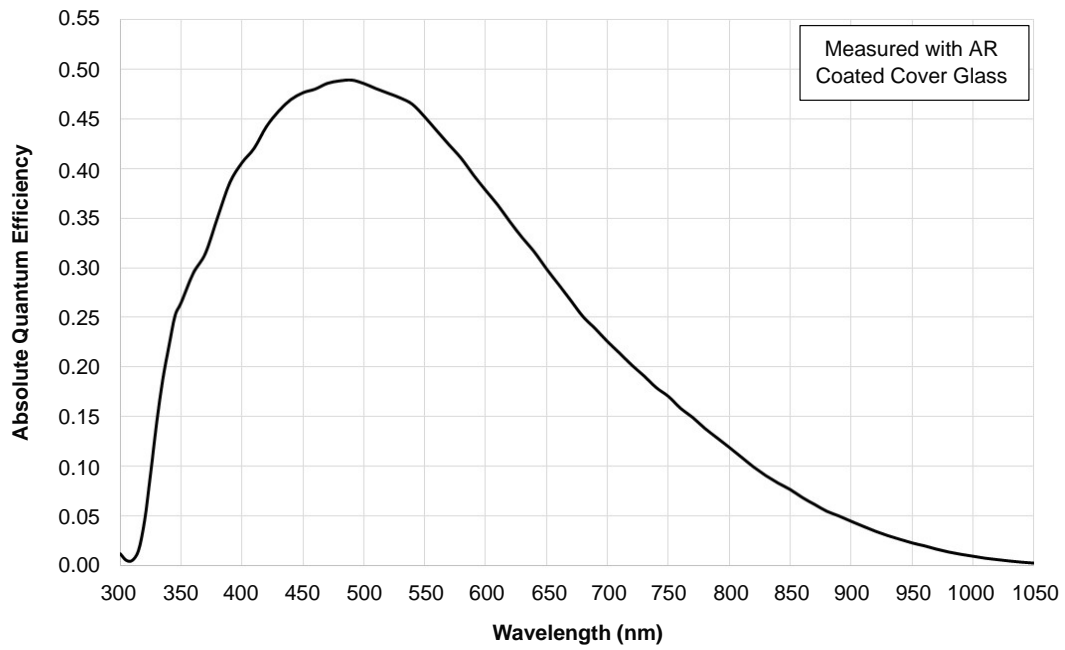

Figure 8. Monochrome with Microlens Quantum Efficiency

Color (Bayer RGB) with Microlens

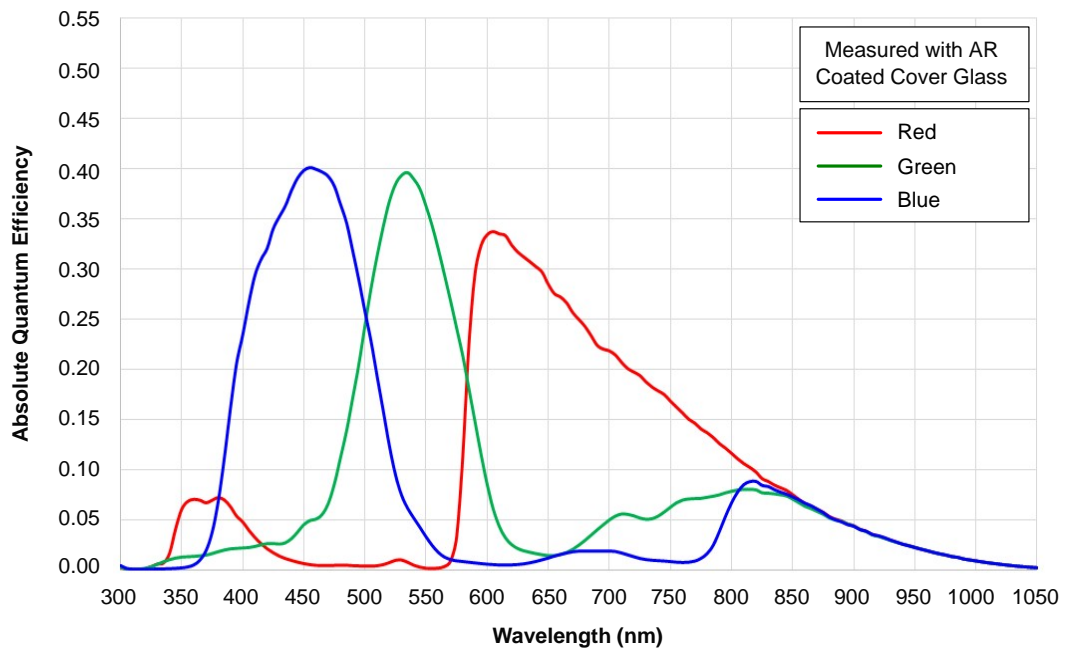

Figure 9. Color (Bayer RGB) with Microlens Quantum Efficiency

Color (TRUESENSE Sparse CFA) with Microlens

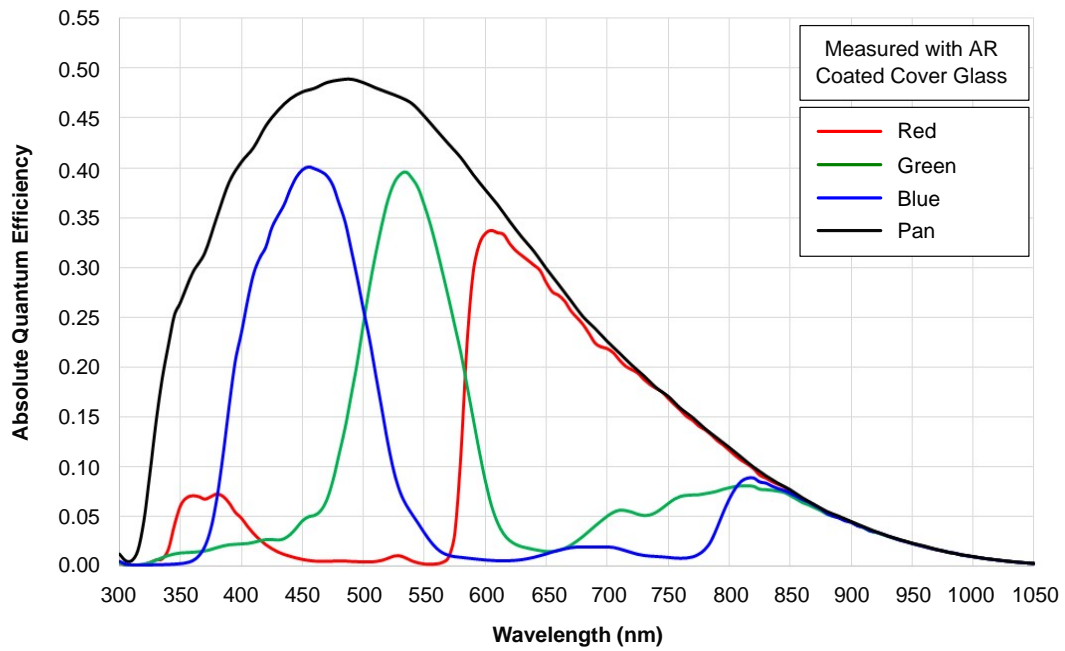

Figure 10. Color (TRUESENSE Sparse CFA) with Microlens Quantum Efficiency

Angular Quantum Efficiency

For the curves marked “Horizontal”, the incident light angle is varied in a plane parallel to the HCCD. For the curves marked “Vertical”, the incident light angle is varied in a plane parallel to the VCCD.

Monochrome with Microlens

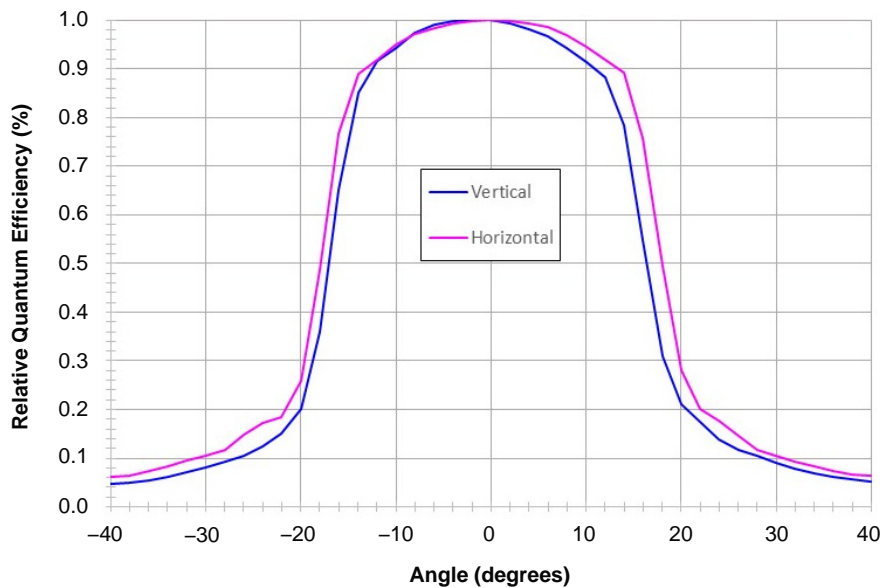

Figure 11. Monochrome with Microlens Angular Quantum Efficiency

Color (Bayer RGB) with Microlens

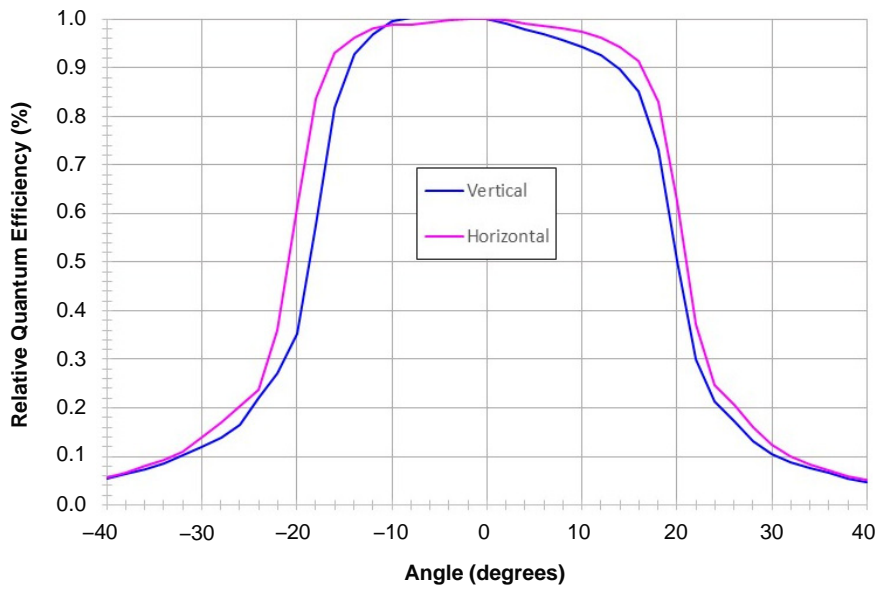

Figure 12. Color (Bayer RGB) with Microlens Angular Quantum Efficiency

Dark Current vs. Temperature

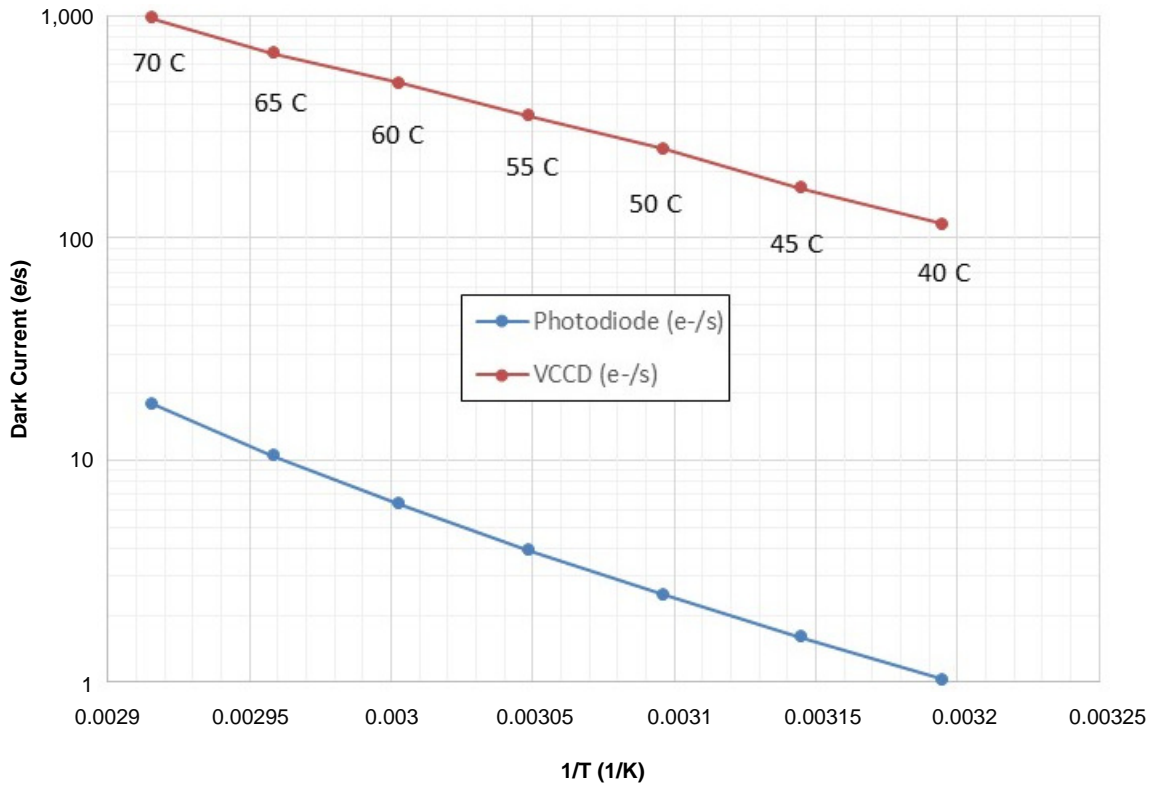

Figure 13. Dark Current vs. Temperature

Power-Estimated

Power-Estimated – Full Resolution

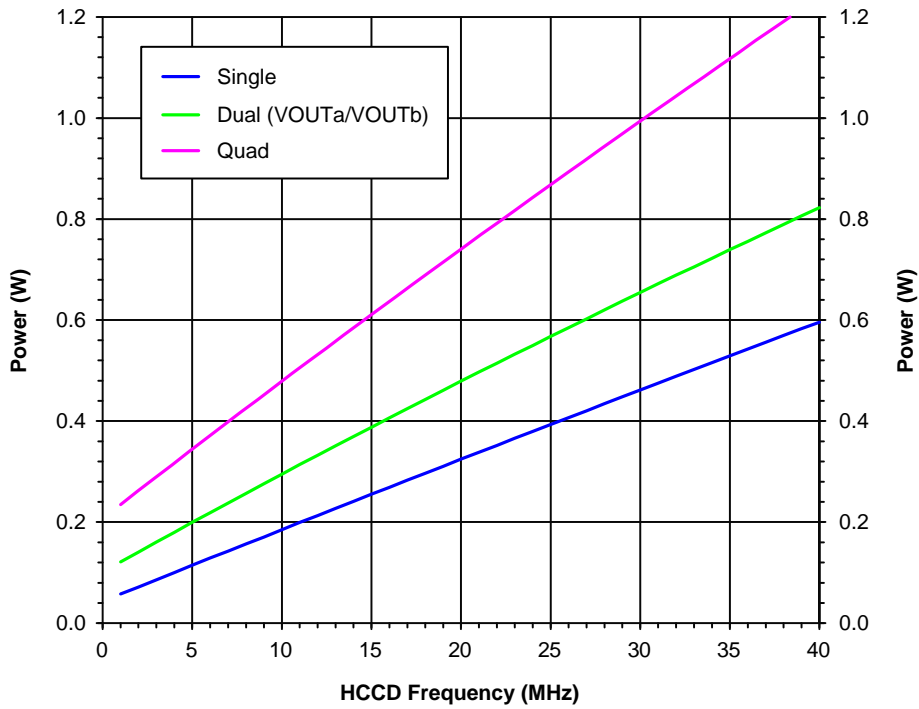

Figure 14. Power – Full Resolution

Power-Estimated – 1/4 Resolution – 2x2 Binning

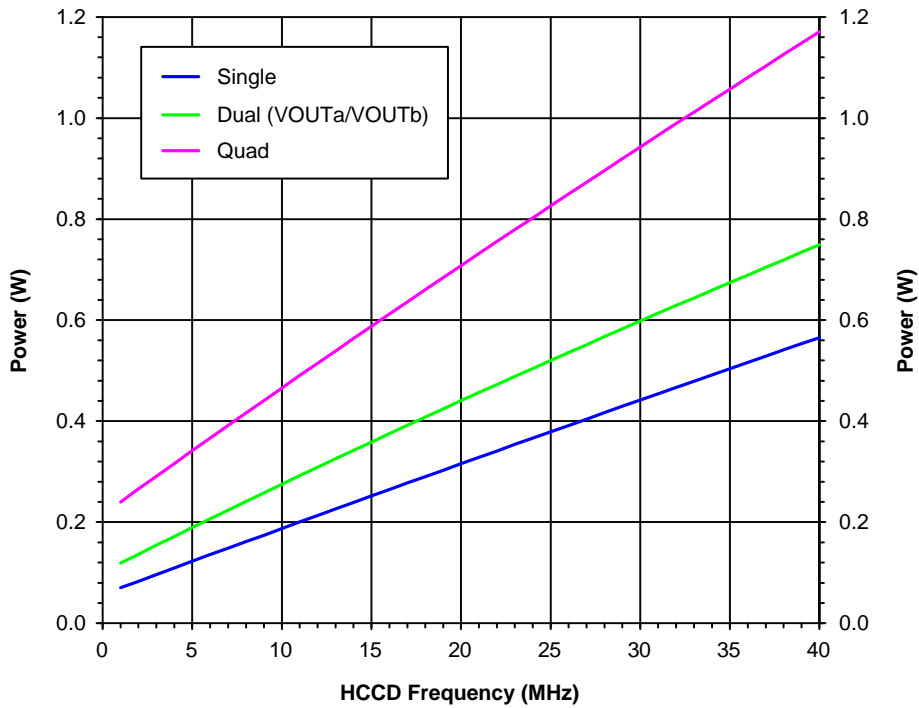

Figure 15. Power – 1/4 Resolution – Constant HCCD

Power-Estimated – 1/4 Resolution – 2x2 Binning using Variable HCCD XLDR

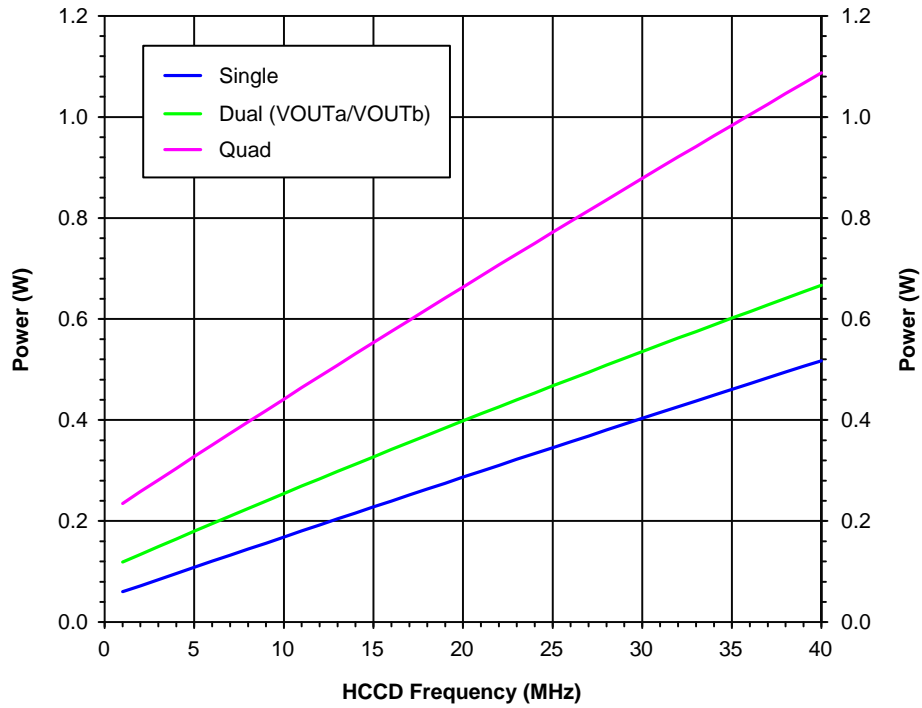

Figure 16. Power – 1/4 Resolution – Variable HCCD XLDR

Power-Estimated – 1/4 Resolution – 2x2 Binning using Constant HCCD XLDR

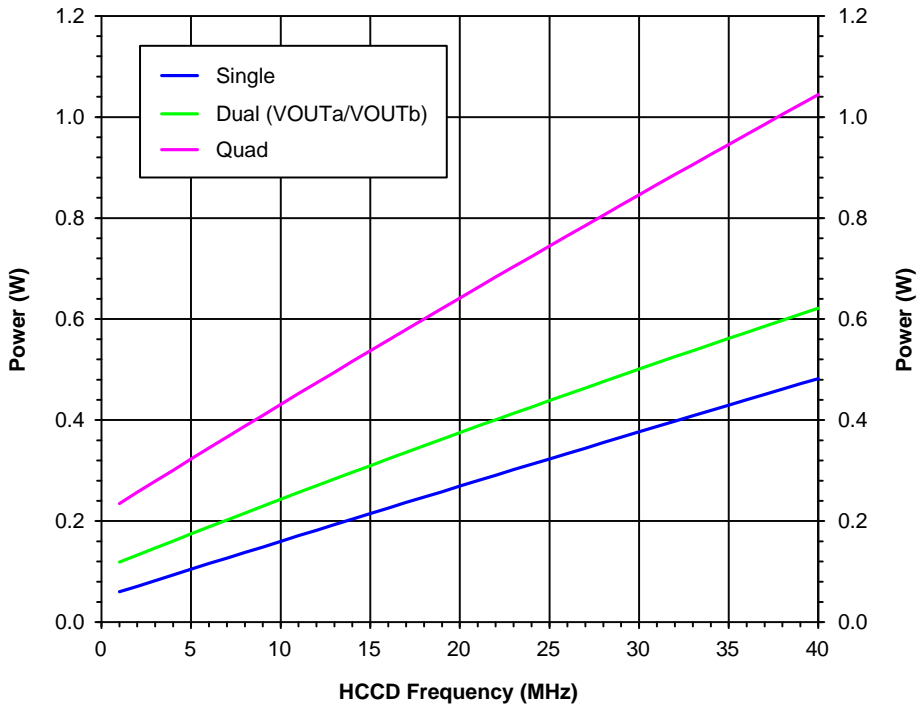

Figure 17. Power – 1/4 Resolution – Constant HCCD XLDR

Frame Rates

Frame Rates – Full Resolution

Frame rates are for low and high gain modes of operation.

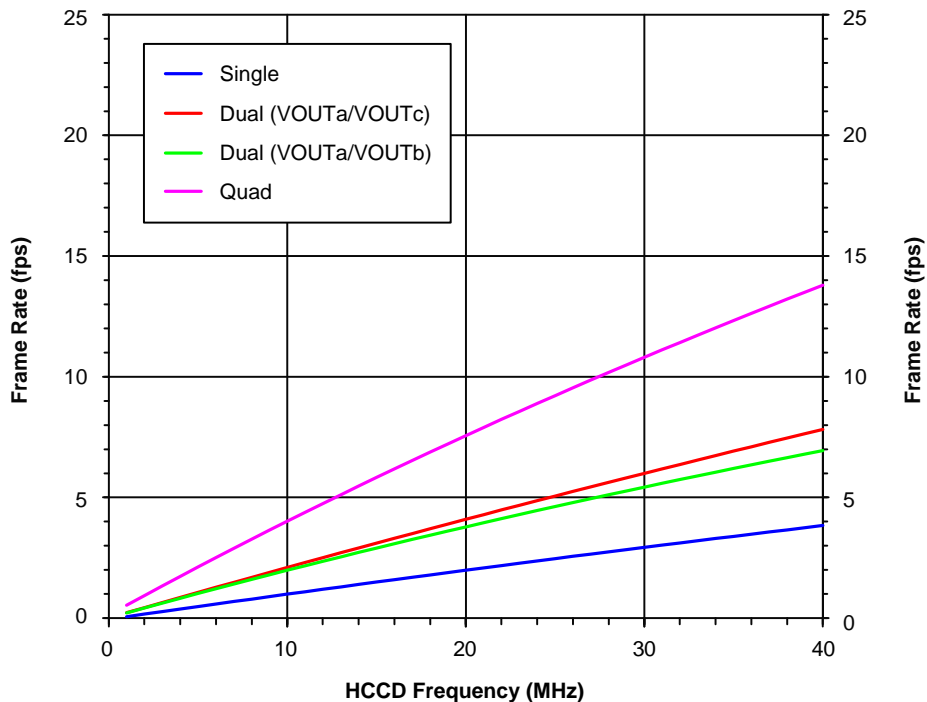

Figure 18. Frame Rates – Full Resolution

Frame Rates – 1/4 Resolution – 2x2 Binning

Frame rates are for low and high gain modes of operation.

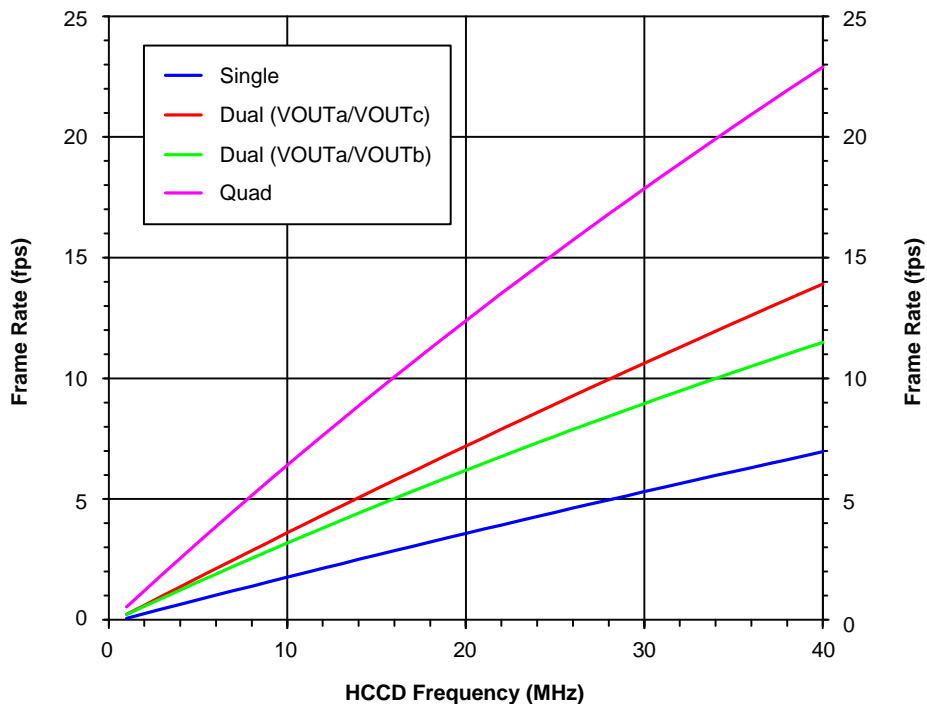

Figure 19. Frame Rates – 1/4 Resolution – Constant HCCD

Frame Rates – 1/4 Resolution – 2x2 Binning using Variable HCCD XLDR

Frame rates for variable HCCD modes of operation.

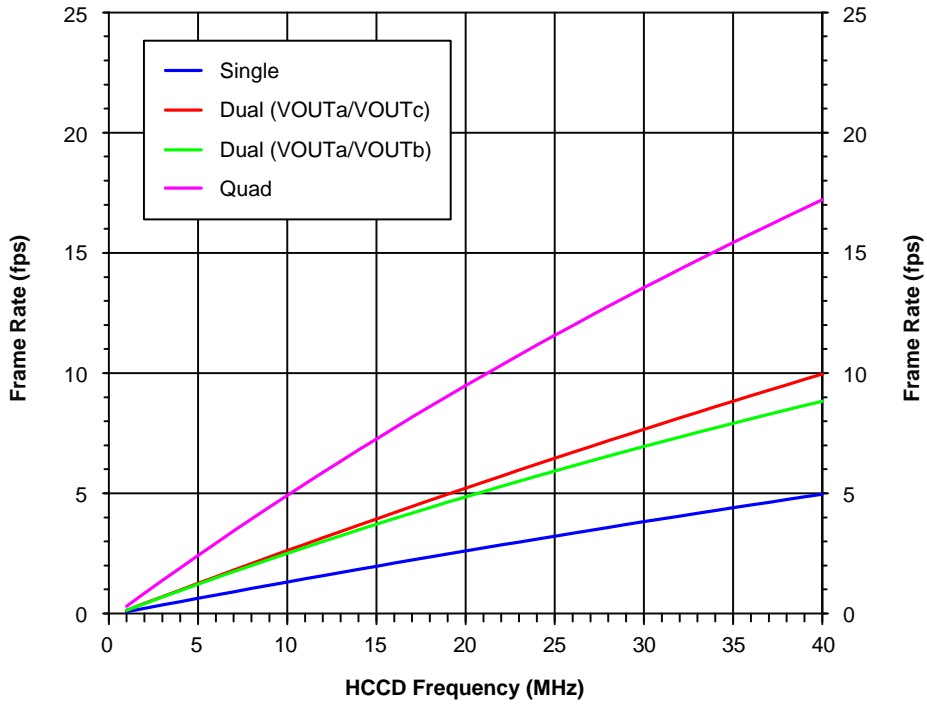

Figure 20. Frame Rates – 1/4 Resolution – Variable HCCD XLDR

Frame Rates – 1/4 Resolution – 2x2 Binning using Constant HCCD XLDR

Frame rates for a constant HCCD mode of operation.

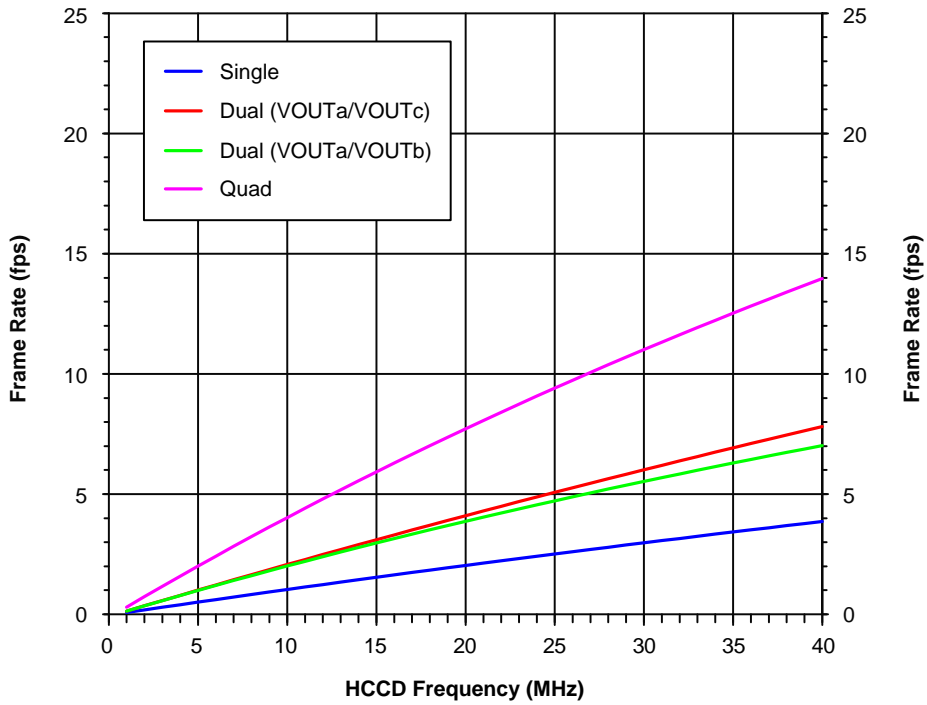

Figure 21. Frame Rates – 1/4 Resolution – Constant HCCD XLDR

DEFECT DEFINITIONS

Table 7. OPERATION CONDITIONS FOR DEFECT TESTING AT 40°C

Description	Condition	Notes
Operational Mode	One Output, Using VOUTa, Continuous Readout	
HCCD Clock Frequency	20 MHz	
Pixels per Line	3,684	
Lines per Frame	2,472	
Line Time	196.2 μ s	
Frame Time	485.1 ms	
Photodiode Integration Time (PD_Tint)	PD_Tint = Frame Time = 495.0 ms, No Electronic Shutter Used	
Temperature	40°C	
Light Source	Continuous Red, Green and Blue LED Illumination	1
Operation	Nominal Operating Voltages and Timing	

1. For monochrome sensor, only the green LED is used.

Table 8. DEFECT DEFINITIONS FOR TESTING AT 40°C

Description	Definition	Grade 1	Grade 2 Mono	Grade 2 Color	Notes
Major Dark Field Defective Bright Pixel	Defect \geq 325 mV	85	850	850	1
Major Bright Field Defective Dark Pixel	-12% \geq Defect \geq 12%	85	850	850	1
Minor Dark Field Defective Bright Pixel	Defect \geq 163 mV	170	1,700	1,700	
Cluster Defect	A group of 2 to 19 (Grade 1) or 2 to 38 (Grade 2) contiguous major defective pixels, but no more than 3 adjacent defect horizontally.	17	17	17	2
Column Defect	A group of more than 10 contiguous major defective pixels along a single column.	0	2	9	2

1. For the color devices (KAI-08670-FXA and KAI-08670-QXA), a bright field defective pixel deviates by 12% with respect to pixels of the same color.
2. Column and cluster defects are separated by no less than two (2) good pixels in any direction (excluding single pixel defects).

Table 9. OPERATION CONDITIONS FOR DEFECT TESTING AT 27°C

Description	Condition	Notes
Operational Mode	One Output, Using VOUTa, Continuous Readout	
HCCD Clock Frequency	20 MHz	
Pixels per Line	3,684	
Lines per Frame	2,472	
Line Time	196.2 μs	
Frame Time	485.1 ms	
Photodiode Integration Time (PD_Tint)	PD_Tint = Frame Time = 495.0 ms, No Electronic Shutter Used	
Temperature	27°C	
Light Source	Continuous Red, Green and Blue LED Illumination	1
Operation	Nominal Operating Voltages and Timing	

1. For monochrome sensor, only the green LED is used.

Table 10. DEFECT DEFINITIONS FOR TESTING AT 27°C

Description	Definition	Grade 1	Grade 2 Mono	Grade 2 Color	Notes
Major Dark Field Defective Bright Pixel	Defect ≥ 100 mV	85	850	850	1
Major Bright Field Defective Dark Pixel	-12% ≥ Defect ≥ 12%	85	850	850	1
Minor Dark Field Defective Bright Pixel	Defect ≥ 52 mV	170	1,700	1,700	
Cluster Defect	A group of 2 to 19 (Grade 1) or 2 to 38 (Grade 2) contiguous major defective pixels, but no more than 3 adjacent defect horizontally.	17	17	17	2
Column Defect	A group of more than 10 contiguous major defective pixels along a single column.	0	2	9	2

1. For the color devices (KAI-08670-FXA and KAI-08670-QXA), a bright field defective pixel deviates by 12% with respect to pixels of the same color.
2. Column and cluster defects are separated by no less than two (2) good pixels in any direction (excluding single pixel defects).

Defect Map

The defect map supplied with each sensor is based upon testing at an ambient (27°C) temperature. Minor point

defects are not included in the defect map. All defective pixels are reference to pixel 1, 1 in the defect maps. See Figure 22 for the location of pixel 1, 1.

TEST DEFINITIONS

Test Regions of Interest

Image Area ROI: Pixel (1, 1) to Pixel (3624, 2424)
 Active Area ROI: Pixel (13, 13) to Pixel (3612, 2412)
 Center ROI: Pixel (1763, 1163) to
 Pixel (1862, 1262)

Overclocking

The test system timing is configured such that the sensor is overclocked in both the vertical and horizontal directions. See Figure 22 for a pictorial representation of the regions of interest.

Only the Active Area ROI pixels are used for performance and defect tests.

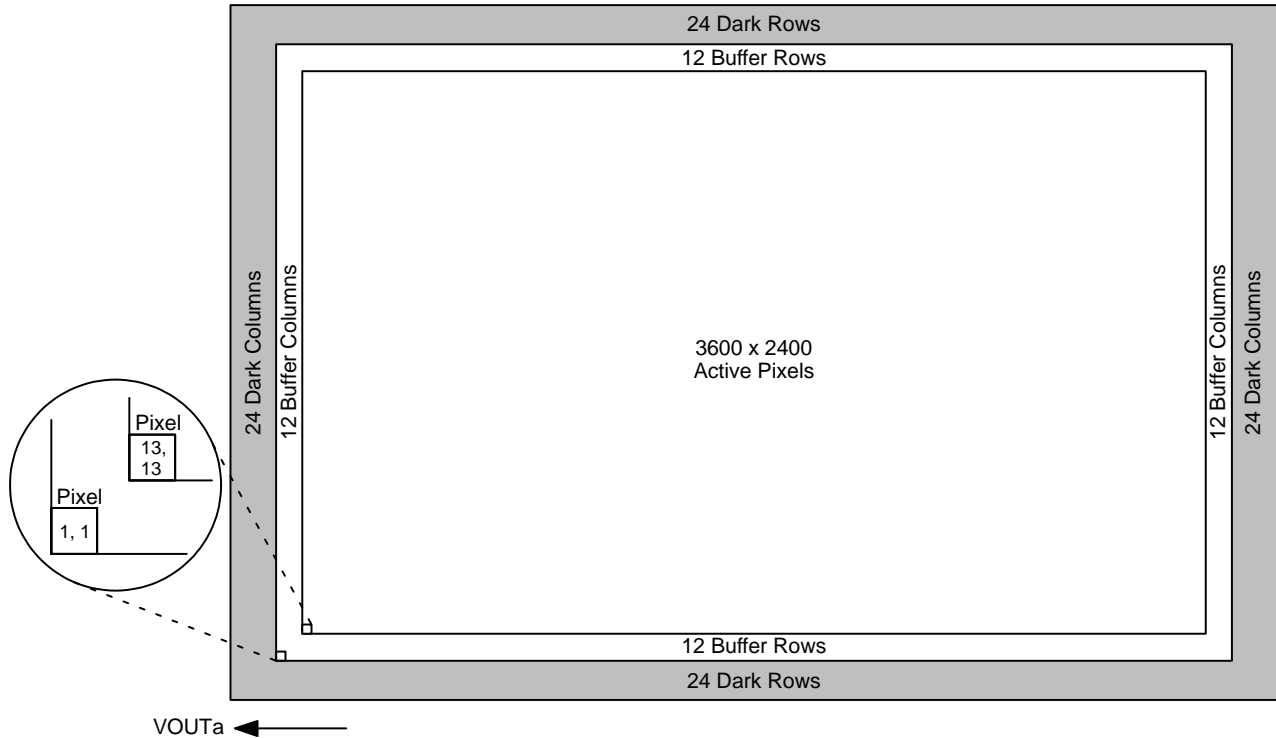

Figure 22. Regions of Interest

Tests

Dark Field Global Non-Uniformity

This test is performed under dark field conditions. The sensor is partitioned into 256 sub regions of interest, each of which is 128 by 128 pixels in size. The average signal level of each of the 256 sub regions of interest is calculated. The signal level of each of the sub regions of interest is calculated using the following formula:

$$\text{Signal of ROI}[i] = (\text{ROI Average in Counts} - \text{Horizontal Overclock Average in Counts}) \cdot \text{mV per Count}$$

Units : mVpp (millivolts Peak to Peak)

Where $i = 1$ to 256. During this calculation on the 256 sub regions of interest, the maximum and minimum signal levels are found. The dark field global uniformity is then calculated as the maximum signal found minus the minimum signal level found.

Global Non-Uniformity

This test is performed with the imager illuminated to a level such that the output is at 70% of saturation (approximately 924 mV). Prior to this test being performed the substrate voltage has been set such that the charge capacity of the sensor is 1,320 mV. Global non-uniformity is defined as:

$$\text{Global Non-Uniformity} = 100 \cdot \left(\frac{\text{Active Area Standard Deviation}}{\text{Active Area Signal}} \right)$$

Units : % rms

Active Area Signal = Active Area Average – Dark Column Average

Global Peak to Peak Non-Uniformity

This test is performed with the imager illuminated to a level such that the output is at 70% of saturation (approximately 924 mV). Prior to this test being performed the substrate voltage has been set such that the charge capacity of the sensor is 1,320 mV. The sensor is partitioned into 256 sub regions of interest, each of which is 128 by 128

pixels in size. The average signal level of each of the 256 sub regions of interest (ROI) is calculated. The signal level of each of the sub regions of interest is calculated using the following formula:

$$\text{Signal of ROI}[i] = (\text{ROI Average in Counts} - \text{Horizontal Overclock Average in Counts}) \cdot \text{mV per Count}$$

Where $i = 1$ to 256. During this calculation on the 144 sub regions of interest, the maximum and minimum signal levels are found. The global peak to peak uniformity is then calculated as:

$$\text{Global Uniformity} = 100 \cdot \left(\frac{\text{Max. Signal} - \text{Min. Signal}}{\text{Active Area Signal}} \right)$$

Units : % pp

Center Non-Uniformity

This test is performed with the imager illuminated to a level such that the output is at 70% of saturation (approximately 924 mV). Prior to this test being performed the substrate voltage has been set such that the charge capacity of the sensor is 1,320 mV. Defects are excluded for the calculation of this test. This test is performed on the center 100 by 100 pixels of the sensor. Center uniformity is defined as:

$$\text{Center ROI Uniformity} = 100 \cdot \left(\frac{\text{Center ROI Standard Deviation}}{\text{Center ROI Signal}} \right)$$

Units : % rms

Center ROI Signal = Center ROI Average – Dark Column Average

Dark Field Defect Test

This test is performed under dark field conditions. The sensor is partitioned into 256 sub regions of interest, each of which is 128 by 128 pixels in size. In each region of interest, the median value of all pixels is found. For each region of interest, a pixel is marked defective if it is greater than or equal to the median value of that region of interest plus the defect threshold specified in the “Defect Definitions” section.

Bright Field Defect Test

This test is performed with the imager illuminated to a level such that the output is at approximately 924 mV. Prior to this test being performed the substrate voltage has been set such that the charge capacity of the sensor is 1,320 mV. The average signal level of all active pixels is found. The bright and dark thresholds are set as:

$$\text{Dark Defect Threshold} = \text{Active Area Signal} \cdot \text{Threshold}$$

$$\text{Bright Defect Threshold} = \text{Active Area Signal} \cdot \text{Threshold}$$

The sensor is then partitioned into 256 sub regions of interest, each of which is 128 by 128 pixels in size. In each region of interest, the average value of all pixels is found. For each region of interest, a pixel is marked defective if it is greater than or equal to the median value of that region of interest plus the bright threshold specified or if it is less than or equal to the median value of that region of interest minus the dark threshold specified.

Example for major bright field defective pixels:

- Average value of all active pixels is found to be 924 mV.
- Dark defect threshold: $924 \text{ mV} \cdot 12\% = 111 \text{ mV}$.
- Bright defect threshold: $924 \text{ mV} \cdot 12\% = 111 \text{ mV}$.
- Region of interest #1 selected. This region of interest is pixels 17, 17 to pixels 144, 144.
 - ◆ Median of this region of interest is found to be 920 mV.
 - ◆ Any pixel in this region of interest that is $\leq (920 - 111 \text{ mV})$ 809 mV in intensity will be marked defective.
 - ◆ Any pixel in this region of interest that is $\geq (920 + 111 \text{ mV})$ 1,031 mV in intensity will be marked defective.
- All remaining 144 sub regions of interest are analyzed for defective pixels in the same manner.

OPERATION

Absolute Maximum Ratings

Absolute maximum rating is defined as a level or condition that should not be exceeded at any time per the

description. If the level or the condition is exceeded, the device will be degraded and may be damaged. Operation at these values will reduce MTTF.

Table 11. ABSOLUTE MAXIMUM RATINGS

Description	Symbol	Minimum	Maximum	Unit	Notes
Operating Temperature	T _{OP}	-50	70	°C	1
Humidity	RH	5	90	%	2
Output Bias Current	I _{OUT}	-	60	mA	3
Off-Chip Load	C _L	-	10	pF	

Stresses exceeding those listed in the Maximum Ratings table may damage the device. If any of these limits are exceeded, device functionality should not be assumed, damage may occur and reliability may be affected.

- Noise performance will degrade at higher temperatures.
- T = 25°C. Excessive humidity will degrade MTTF.
- Total for all outputs. Maximum current is -15 mA for each output. Avoid shorting output pins to ground or any low impedance source during operation. Amplifier bandwidth increases at higher current and lower load capacitance at the expense of reduced gain (sensitivity).

Table 12. ABSOLUTE MAXIMUM VOLTAGE RATINGS BETWEEN PINS AND GROUND

Description	Minimum	Maximum	Unit	Notes
VDD _α , VOUT _α , RD _α	-0.4	17.5	V	1
RD _α	-0.4	15.5	V	1
V1B, V1T	ESD - 0.4	ESD + 24.0	V	
V2B, V2T, V3B, V3T, V4B, V4T	ESD - 0.4	ESD + 14.0	V	
FDG _{ab} , FDG _{cd}	ESD - 0.4	ESD + 15.0	V	
H1S _α , H1B _α , H2S _α , H2B _α , H2SL _α , R1 _α , R2 _α , OG _α	ESD - 0.4	ESD + 14.0	V	1
ESD	-10.0	0.0	V	
SUB	-0.4	40.0	V	2

- α denotes a, b, c or d.
- Refer to Application Note *Using Interline CCD Image Sensors in High Intensity Visible Lighting Conditions*.

Reset Pin, Low Gain (R2ab and R2cd)

The R2ab and R2bc (pins 19 and 55) each have an internal circuit to bias the pins to 4.3 V. This feature assures the device is set to operate in the high gain mode when pins 19

and 55 are not connected in the application to a clock driver. Typical capacitor coupled drivers will not drive this structure.

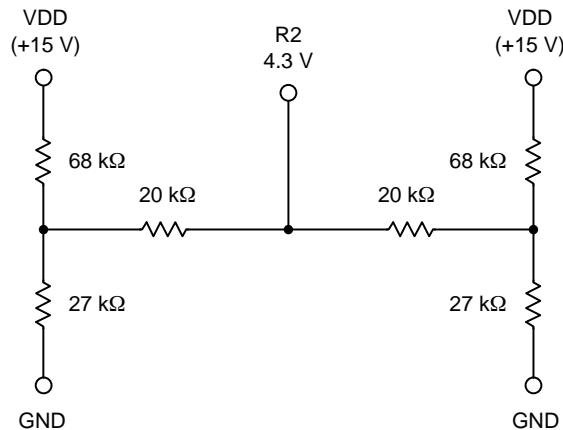
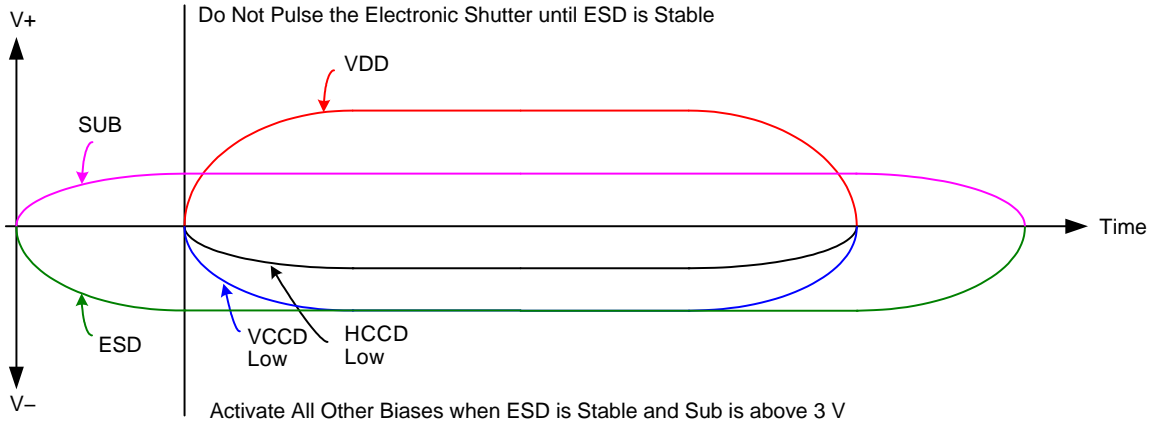

Figure 23. Equivalent Circuit for Reset Gate, Low Gain (R2ab and R2cd)

Power-Up and Power-Down Sequence

Adherence to the power-up and power-down sequence is critical. Failure to follow the proper power-up and power-down sequences may cause damage to the sensor.



Notes:

1. Activate all other biases when ESD is stable and SUB is above 3 V.
2. Do not pulse the electronic shutter until ESD is stable.
3. VDD cannot be +15 V when SUB is 0 V.
4. The image sensor can be protected from an accidental improper ESD voltage by current limiting the SUB current to less than 10 mA. SUB and VDD must always be greater than GND. ESD must always be less than GND. Placing diodes between SUB, VDD, ESD and ground will protect the sensor from accidental overshoots of SUB, VDD and ESD during power on and power off. See the figure below.

Figure 24. Power-Up and Power-Down Sequence

The VCCD clock waveform must not have a negative overshoot more than 0.4 V below the ESD voltage.

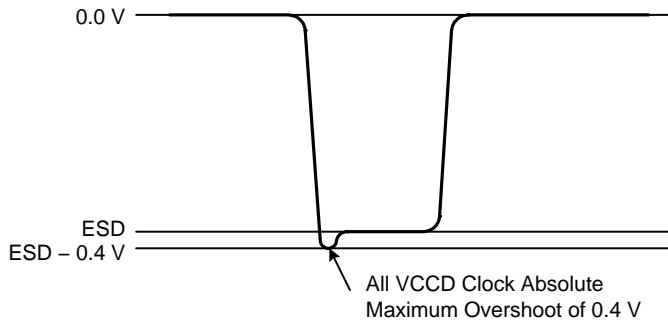

Figure 25. VCCD Clock Waveform

Example of external diode protection for SUB, VDD and ESD. α denotes a, b, c or d.

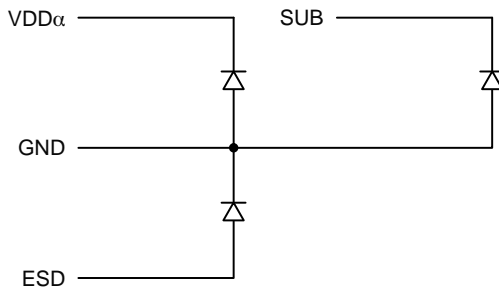

Figure 26. Example of External Diode Protection

DC Bias Operating Conditions

Table 13. DC BIAS OPERATING CONDITIONS

Description	Pins	Symbol	Min.	Nom.	Max.	Unit	Max. DC Current	Notes
Reset Drain	RD α	RD	12.4	12.6	12.8	V	10 μ A	1, 9
Output Gate	OG α	OG	-2.2	-2.0	-1.8	V	10 μ A	1
Output Amplifier Supply	VDD α	V _{DD}	14.5	15.0	15.5	V	11.0 mA	1, 2
Ground	GND	GND	0.0	0.0	0.0	V	-1.0 mA	
Substrate	SUB	V _{SUB}	5.0	V _{AB}	V _{DD}	V	50 μ A	3, 8
ESD Protection Disable	ESD	ESD	-9.2	-9.0	V _{x_L}	V	50 μ A	6, 7, 10
Output Bias Current	VOU α	I _{OUT}	-3.0	-5.0	-10.0	mA	-	1, 4, 5

1. α denotes a, b, c or d.
2. The maximum DC current is for one output. $I_{DD} = I_{OUT} + I_{SS}$. See Figure 27.
3. The operating value of the substrate voltage, V_{AB} , will be marked on the shipping container for each device. The value of V_{AB} is set such that the photodiode charge capacity is the nominal P_{Ne} (see Specifications).
4. An output load sink must be applied to each VOUT pin to activate each output amplifier.
5. Nominal value required for 40 MHz operation per output. May be reduced for slower data rates and lower noise.
6. Adherence to the power-up and power-down sequence is critical. See Power Up and Power Down Sequence section.
7. ESD maximum value must be less than or equal to $V1_L + 0.4$ V and $V2_L + 0.4$ V.
8. Refer to Application Note *Using Interline CCD Image Sensors in High Intensity Visible Lighting Conditions*.
9. 12.0 V may be used if the total output signal desired is 20,000 e⁻ or less.
10. Where V_{x_L} is the level set for V1_L, V2_L, V3_L, or V4_L in the application.



Figure 27. Output Amplifier

AC Operating Conditions

Table 14. CLOCK LEVELS

Description	Pins (Note 1)	Symbol	Level	Min.	Nom.	Max.	Unit
Vertical CCD Clock, Phase 1	V1B, V1T	V1_L	Low	-8.2	-8.0	-7.8	V
		V1_M	Mid	-0.2	0.0	0.2	
		V1_H	High	11.5	12.0	12.5	
Vertical CCD Clock, Phase 2	V2B, V2T	V2_L	Low	-8.2	-8.0	-7.8	V
		V2_H	High	-0.2	0.0	0.2	
Vertical CCD Clock, Phase 3	V3B, V3T	V3_L	Low	-8.2	-8.0	-7.8	V
		V3_H	High	-0.2	0.0	0.2	
Vertical CCD Clock, Phase 4	V4B, V4T	V4_L	Low	-8.2	-8.0	-7.8	V
		V4_H	High	-0.2	0.0	0.2	
Horizontal CCD Clock, Phase 1 Storage	H1S α	H1S_L	Low	-5.2	-4.0	-3.8	V
		H1S_A	Amplitude (Note 3)	3.8	4.0	5.2	
Horizontal CCD Clock, Phase 1 Barrier	H1B α	H1B_L	Low	-5.2	-4.0	-3.8	V
		H1B_A	Amplitude (Note 3)	3.8	4.0	5.2	
Horizontal CCD Clock, Phase 2 Storage	H2S α	H2S_L	Low	-5.2	-4.0	-3.8	V
		H2S_A	Amplitude (Note 3)	3.8	4.0	5.2	
Horizontal CCD Clock, Phase 2 Barrier	H2B α	H2B_L	Low	-5.2	-4.0	-3.8	V
		H2B_A	Amplitude (Note 3)	3.8	4.0	5.2	
Horizontal CCD Clock, Last Phase (Note 2)	H2SL α	H2SL_L	Low	-5.2	-5.0	-4.8	V
		H2SL_A	Amplitude (Note 3)	4.8	5.0	5.2	
Reset Gate	R α	R_L	Low	-3.2	-3.0	-2.8	V
		R_A	Amplitude	6.0	-	6.4	
Reset Gate 2	R2 α	R2_L	Low	-2.0	-1.8	-1.6	V
		R2_A	Amplitude	6.0	-	6.4	
Electronic Shutter (Note 4)	SUB	VES	High	29.0	30.0	40.0	V
Fast Line Dump Gate	FDG α	FDG_L	Low	-8.2	-8.0	-7.8	V
		FDG_H	High	4.5	5.0	5.5	

- α denotes a, b, c or d.
- Use separate clock driver for improved speed performance.
- The horizontal clock amplitude should be set such that the high level reaches 0.0 V. Examples:
 - If the minimum horizontal low voltage of -5.2 V is used, then a 5.2 V amplitude clock is required for a clock swing of -5.2 V to 0.0 V.
 - If the maximum horizontal low voltage of -3.8 V is used, then a 3.8 V amplitude clock is required for a clock swing of -3.8 V to 0.0 V.
- Refer to Application Note *Using Interline CCD Image Sensors in High Intensity Visible Lighting Conditions*.

The figure below shows the DC bias (V_{SUB}) and AC clock (VES) applied to the SUB pin. Both the DC bias and AC clock are referenced to ground.

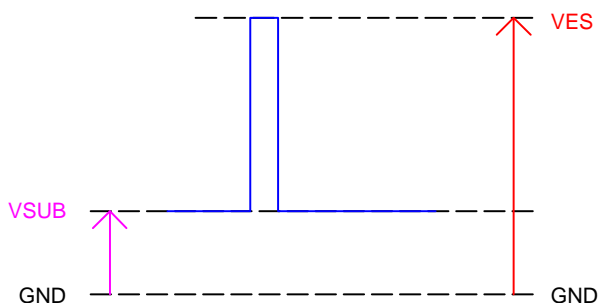

Figure 28. DC Bias and AC Clock Applied to the SUB Pin

Capacitance

Table 15. CAPACITANCE

	V1B	V2B	V3B	V4B	V1T	V2T	V3T	V4T	GND	All Pins	Unit
V1B	X	9.5	6.1	7.8	3.3	2.8	3.3	2.2	13.4	49.1	nF
V2B	X	X	11.7	5.6	2.8	1.7	2.2	1.7	3.9	41.3	nF
V3B	X	X	X	10.6	3.3	2.8	3.3	2.2	4.5	46.3	nF
V4B	X	X	X	X	2.8	2.2	2.8	1.7	12.8	42.4	nF
V1T	X	X	X	X	X	7.8	6.1	9.5	13.4	48.0	nF
V2T	X	X	X	X	X	X	8.9	3.3	12.3	41.8	nF
V3T	X	X	X	X	X	X	X	10.6	6.1	46.9	nF
V4T	X	X	X	X	X	X	X	X	2.8	40.7	nF
VSUB	1.1	1.1	1.1	1.1	1.1	1.1	1.1	1.1	6.1	6.1	nF

	H2S	H1B	H2B	GND	All Pins	Unit
H1S	34	56	33	146	269	pF
H2S	X	35	31	210	275	pF
H1B	X	X	9	234	242	pF
H2B	X	X	X	219	219	pF

1. Tables show typical cross capacitance between pins of the device.
2. Capacitance is total for all like pins.
3. Capacitance values are estimated.

Device Identification

The device identification pin (DevID) may be used to determine which 7.4 micron pixel interline CCD sensor is being used.

Table 16. DEVICE IDENTIFICATION

Description	Pins	Symbol	Min.	Nom.	Max.	Unit	Max. DC Current	Notes
Device Identification	DevID	DevID	129,000	144,000	159,000	Ω	50 μ A	1, 2, 3

1. Nominal value subject to verification and/or change during release of preliminary specifications.
2. If the Device Identification is not used, it may be left disconnected.
3. After Device Identification resistance has been read during camera initialization, it is recommended that the circuit be disabled to prevent localized heating of the sensor due to current flow through the R_DeviceID resistor.

Recommended Circuit

Note that V1 must be a different value than V2.

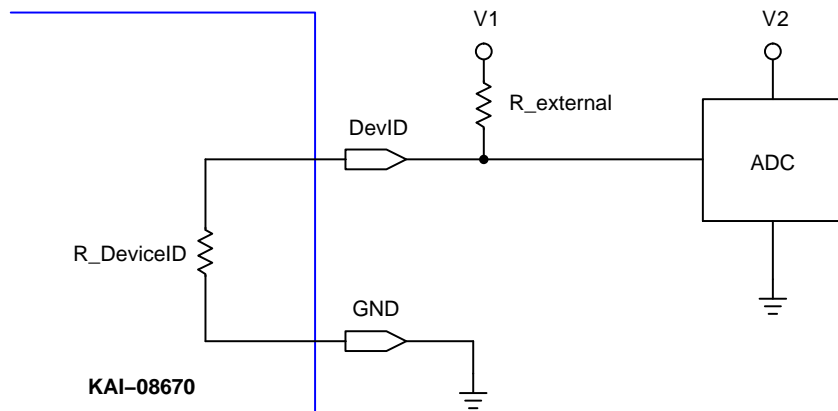

Figure 29. Device Identification Recommended Circuit

TIMING

Requirements and Characteristics

Table 17. REQUIREMENTS AND CHARACTERISTICS

Description	Symbol	Min.	Nom.	Max.	Unit	Notes
Photodiode Transfer	t_{PD}	2.0	–	–	μs	
VCCD Leading Pedestal	t_{3P}	4.0	–	–	μs	
VCCD Trailing Pedestal	t_{3D}	4.0	–	–	μs	
VCCD Transfer Delay	t_D	1.0	–	–	μs	
VCCD Transfer	t_V	3.0	–	–	μs	
VCCD Clock Cross-Over	V_{VCR}	75	–	100	%	1
VCCD Rise, Fall Times	t_{VR}, t_{VF}	5	–	10	%	1, 2
HCCD Delay	t_{HS}	2.0	–	–	μs	
HCCD Transfer	t_e	25.0	–	–	ns	
Shutter Transfer	t_{SUB}	2.0	–	–	μs	
Shutter Delay	t_{HD}	2.0	–	–	μs	
Reset Pulse	t_R	2.5	–	–	ns	
Reset – Video Delay	t_{RV}	–	2.2	–	ns	
H2SL – Video Delay	t_{HV}	–	3.1	–	ns	
Line Time	t_{LINE}	58.2	–	–	μs	Dual HCCD Readout
		104.1	–	–	μs	Single HCCD Readout
Frame Time	t_{FRAME}	72.0	–	–	ms	Quad HCCD Readout
		143.9	–	–	ms	Dual HCCD Readout
		257.4	–	–	ms	Single HCCD Readout
Line Time (XLDR Bin 2x2)	t_{LINE}	93.3	–	–	μs	Dual HCCD Readout
		162.2	–	–	μs	Single HCCD Readout
Frame Time (XLDR Bin 2x2) Constant HCCD Timing	t_{FRAME}	72.0	–	–	ms	Quad HCCD Readout
		143.9	–	–	ms	Dual HCCD Readout
		257.4	–	–	ms	Single HCCD Readout
Frame Time (XLDR Bin 2x2) Variable HCCD Timing	t_{FRAME}	57.7	–	–	ms	Quad HCCD Readout
		115.4	–	–	ms	Dual HCCD Readout
		200.5	–	–	ms	Single HCCD Readout

1. Refer to Figure 48: VCCD Clock Rise Time, Fall Time, and Edge Alignment.
2. Relative to the VCCD Transfer pulse width, t_V .

Timing Flow Charts

In the timing flow charts the number of HCCD clock cycles per row, NH, and the number of VCCD clock cycles per frame, NV, are shown in the following table.

Table 18. VALUES FOR NH AND NV WHEN OPERATING THE SENSOR IN THE VARIOUS MODES OF RESOLUTION

	Full Resolution		1/4 Resolution		XLDR	
	NV	NH	NV	NH	NV	NH
Quad	1236	1848	618	924	618	924
Dual VOUTa, VOUTc	1236	3696	618	1848	618	1848
Dual VOUTa, VOUTb	2472	1848	1236	924	1236	924
Single VOUTa	2472	3696	1236	1848	1236	1848

1. The time to read out one line $t_{LINE} = \text{Line Timing} + NH / (\text{Pixel Frequency})$.
2. The time to read out one frame $t_{FRAME} = NV \cdot t_{LINE} + \text{Frame Timing}$.
3. Line Timing: See Table 20: Line Timing.
4. Frame Timing: See Table 19: Frame Timing.
5. XLDR: eXtended Linear Dynamic Range.

No Electronic Shutter

In this case the photodiode exposure time is equal to the time to read out an image. This flow chart applies to both full and 1/4 resolution modes.

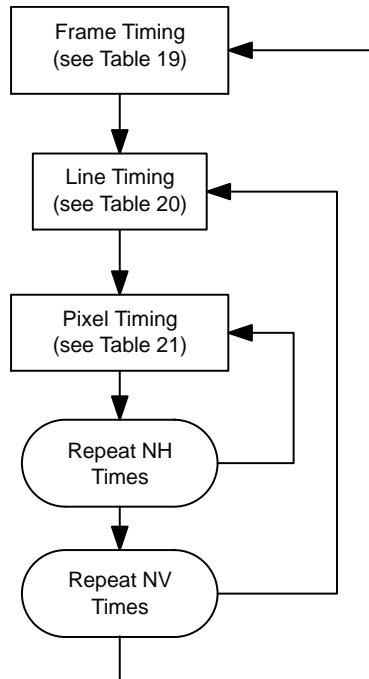
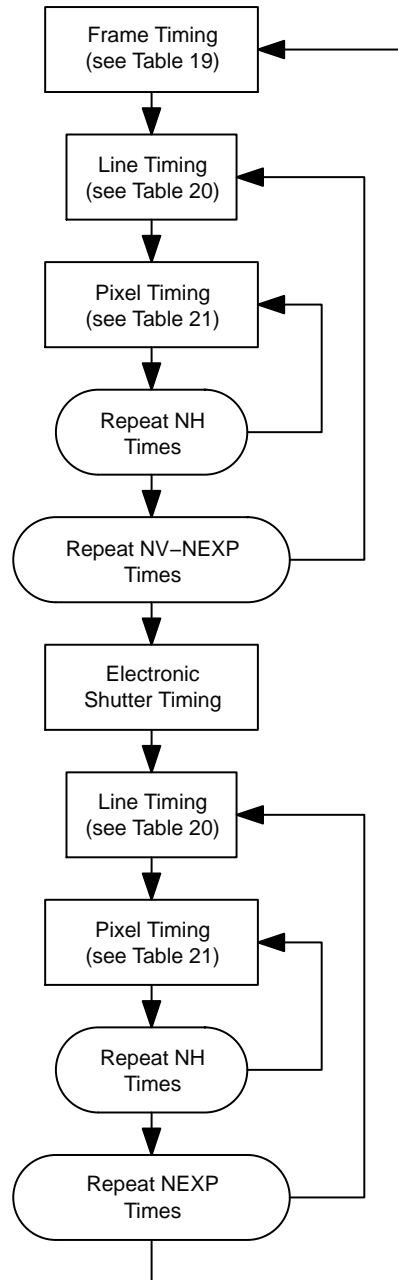

Figure 30. Timing Flow when Electronic Shutter is Not Used

Using the Electronic Shutter

This flow chart applies to both the full and 1/4 resolution modes. The exposure time begins on the falling edge of the electronic shutter pulse on the SUB pin. The exposure time

ends on the falling edge of the photodiode transfer (t_{PD}) of the V1T and V1B pins. The electronic shutter timing is shown in Figure 39.



NOTE: NEXP: Exposure time in increments of number of lines.

Figure 31. Timing Flow Chart using the Electronic Shutter for Exposure Control

Timing Tables

Frame Timing

This timing table is for transferring charge from the photodiodes to the VCCD. See Figure 32 and Figure 33 for frame timing diagrams.

Table 19. FRAME TIMING

Device Pin	Full Resolution, High Gain or Low Gain				1/4 Resolution, High Gain or Low Gain				1/4 Resolution XLDR			
	Quad	Dual VOUTa VOUTc	Dual VOUTa VOUTb	Single VOUTa	Quad	Dual VOUTa VOUTc	Dual VOUTa VOUTb	Single VOUTa	Quad	Dual VOUTa VOUTc	Dual VOUTa VOUTb	Single VOUTa
V1T	F1T		F1B		F1T		F1B		F1T		F1B	
V2T	F2T		F4B		F2T		F4B		F2T		F4B	
V3T	F3T		F3B		F3T		F3B		F3T		F3B	
V4T	F4T		F2B		F4T		F2B		F4T		F2B	
V1B	F1B				F1B				F1B			
V2B	F2B				F2B				F2B			
V3B	F3B				F3B				F3B			
V4B	F4B				F4B				F4B			
H1Sa	P1				P1Q				P1XL			
H1Ba	P1				P1Q				P1XL			
H2Sa	P2				P2Q				P2XL			
H2Ba	P2				P2Q				P2XL			
Ra	RHG/RLG				RHGQ/RLGQ				RXL			
H1Sb	P1				P1Q				P1XL			
H1Bb	P1	P2	P1	P2	P1Q	P2Q	P1Q	P2Q	P1XL	P2XL	P1XL	P2XL
H2Sb	P2				P2Q				P2XL			
H2Bb	P2	P1	P2	P1	P2Q	P1Q	P2Q	P1Q	P2XL	P1XL	P2XL	P1XL
Rb	RHG/RLG	(Note 1)	RHG/RLG	(Note 1)	RHGQ/RLGQ	(Note 1)	RHGQ/RLGQ	(Note 1)	RXL	(Note 1)	RXL	(Note 1)
R2ab	R2HG/R2LG				R2HGQ/R2LGQ				R2XL			
FDGab	-8 V				-8 V				-8 V			
H1Sc	P1		(Note 1)		P1Q		(Note 1)		P1XL		(Note 1)	
H1Bc	P1		(Note 1)		P1Q		(Note 1)		P1XL		(Note 1)	
H2Sc	P2		(Note 1)		P2Q		(Note 1)		P2XL		(Note 1)	
H2Bc	P2		(Note 1)		P2Q		(Note 1)		P2XL		(Note 1)	
Rc	RHG/RLG		(Note 1)		RHGQ/RLGQ		(Note 1)		RXL		(Note 1)	
H1Sd	P1		(Note 1)		P1Q		(Note 1)		P1XL		(Note 1)	
H1Bd	P1	P2	(Note 1)		P1Q	P2Q	(Note 1)		P1XL	P2XL	(Note 1)	
H2Sd	P2		(Note 1)		P2Q		(Note 1)		P2XL		(Note 1)	
H2Bd	P2	P1	(Note 1)		P2Q	P1Q	(Note 1)		P2XL	P1XL	(Note 1)	
Rd	RHG/RLG	(Note 1)	(Note 1)		RHGQ/RLGQ	(Note 1)	(Note 1)		RXL	(Note 1)	(Note 1)	
R2cd	R2HG/R2LG		(Note 1)		R2HGQ/R2LGQ		(Note 1)		R2XL		(Note 1)	
FDGcd	-8 V				-8 V				-8 V			
SHP (Note 2)	SHP1				SHPQ				(Note 4)			
SHD (Note 2)	SHD1				SHDQ				(Note 5)			

1. This clock should be held at its high level voltage (0 V) or held at +5.0 V for compatibility with TRUESENSE 5.5 micron Interline Transfer CCD family of products.
2. SHP and SHD are the sample clocks for the analog front end (AFE) signal processor.
3. This note intentionally left empty.
4. Use SHPLG for the AFE processing the low gain signal. Use SHPHG for the AFE processing the high gain signal.
5. Use SHDLG for the AFE processing the low gain signal. Use SHDHG for the AFE processing the high gain signal.

Line Timing

This timing is for transferring one line of charge from the VCCD to the HCCD. See Figure 34, Figure 35, Figure 37 and Figure 38 for line timing diagrams.

Table 20. LINE TIMING

Device Pin	Full Resolution, High Gain or Low Gain				1/4 Resolution, High Gain or Low Gain				1/4 Resolution XLDR			
	Quad	Dual VOUTa VOUTc	Dual VOUTa VOUTb	Single VOUTa	Quad	Dual VOUTa VOUTc	Dual VOUTa VOUTb	Single VOUTa	Quad	Dual VOUTa VOUTc	Dual VOUTa VOUTb	Single VOUTa
V1T	L1T		L1B		2× L1T		2× L1B		2× L1T		2× L1B	
V2T	L2T		L4B		2× L2T		2× L4B		2× L2T		2× L4B	
V3T	L3T		L3B		2× L3T		2× L3B		2× L3T		2× L3B	
V4T	L4T		L2B		2× L4T		2× L2B		2× L4T		2× L2B	
V1B	L1B				2× L1B				2× L1B			
V2B	L2B				2× L2B				2× L2B			
V3B	L3B				2× L3B				2× L3B			
V4B	L4B				2× L4B				2× L4B			
H1Sa	P1L				P1LQ				P1XL			
H1Ba	P1L				P1LQ				P1XL			
H2Sa	P2L				P2LQ				P2XL			
H2Ba	P2L				P2LQ				P2XL			
Ra	RHG/RLG				RHGQ/RLGQ				RXL			
H1Sb	P1L				P1LQ				P1XL			
H1Bb	P1L	P2L	P1L	P2L	P1LQ	P2LQ	P1LQ	P2LQ	P1XL	P2XL	P1XL	P2XL
H2Sb	P2L				P2LQ				P2XL			
H2Bb	P2L	P1L	P2L	P1L	P2LQ	P1LQ	P2LQ	P1LQ	P2XL	P1XL	P2XL	P1XL
Rb	RHG/RLG	(Note 1)	RHG/RLG	(Note 1)	RHGQ/RLGQ	(Note 1)	RHGQ/RLGQ	(Note 1)	RXL	(Note 1)	RXL	(Note 1)
R2ab	R2HG/R2LG				R2HGQ/R2LGQ				R2XL			
FDGAb	-8 V				-8 V				-8 V			
H1Sc	P1L		(Note 1)		P1LQ		(Note 1)		P1XL		(Note 1)	
H1Bc	P1L		(Note 1)		P1LQ		(Note 1)		P1XL		(Note 1)	
H2Sc	P2L		(Note 1)		P2LQ		(Note 1)		P2XL		(Note 1)	
H2Bc	P2L		(Note 1)		P2LQ		(Note 1)		P2XL		(Note 1)	
Rc	RHG/RLG		(Note 1)		RHGQ/RLGQ		(Note 1)		RXL		(Note 1)	
H1Sd	P1L		(Note 1)		P1LQ		(Note 1)		P1XL		(Note 1)	
H1Bd	P1L	P2L	(Note 1)		P1LQ	P2LQ	(Note 1)		P1XL	P2XL	(Note 1)	
H2Sd	P2L		(Note 1)		P2LQ		(Note 1)		P2XL		(Note 1)	
H2Bd	P2L	P1L	(Note 1)		P2LQ	P1LQ	(Note 1)		P2XL	P1XL	(Note 1)	
Rd	RHG/RLG	(Note 1)	(Note 1)		RHGQ/RLGQ	(Note 1)	(Note 1)		RXL	(Note 1)	(Note 1)	
R2cd	R2HG/R2LG		(Note 1)		R2HGQ/R2LGQ		(Note 1)		R2XL		(Note 1)	
FDGcd	-8 V				-8 V				-8 V			
SHP (Note 2)	SHP1				SHPQ				(Note 4)			
SHD (Note 2)	SHD1				SHDQ				(Note 5)			

1. This clock should be held at its high level voltage (0 V) or held at +5.0 V for compatibility with TRUESENSE 5.5 micron Interline Transfer CCD family of products.
2. SHP and SHD are the sample clocks for the analog front end (AFE) signal processor.
3. The notation 2× L1B means repeat the L1B timing twice for every line. This sums two rows into the HCCD.
4. Use SHPLG for the AFE processing the low gain signal. Use SHPHG for the AFE processing the high gain signal.
5. Use SHDLG for the AFE processing the low gain signal. Use SHDHG for the AFE processing the high gain signal.

Pixel Timing

This timing is for transferring one pixel from the HCCD to the output amplifier.

Table 21. PIXEL TIMING

Device Pin	Full Resolution, High Gain or Low Gain				1/4 Resolution, High Gain or Low Gain				1/4 Resolution XLDR			
	Quad	Dual VOUTa VOUTc	Dual VOUTa VOUTb	Single VOUTa	Quad	Dual VOUTa VOUTc	Dual VOUTa VOUTb	Single VOUTa	Quad	Dual VOUTa VOUTc	Dual VOUTa VOUTb	Single VOUTa
V1T	-8 V				-8 V				-8 V			
V2T	-8 V				-8 V				-8 V			
V3T	0 V				0 V				0 V			
V4T	0 V				0 V				0 V			
V1B	-8 V				-8 V				-8 V			
V2B	0 V				0 V				0 V			
V3B	0 V				0 V				0 V			
V4B	-8 V				-8 V				-8 V			
H1Sa	P1				P1Q				P1XL			
H1Ba	P1				P1Q				P1XL			
H2Sa	P2				P2Q				P2XL			
H2Ba	P2				P2Q				P2XL			
Ra	RHG/RLG				RHGQ/RLGQ				RXL			
H1Sb	P1				P1Q				P1XL			
H1Bb	P1	P2	P1	P2	P1Q	P2Q	P1Q	P2Q	P1XL	P2XL	P1XL	P2XL
H2Sb	P2				P2Q				P2XL			
H2Bb	P2	P1	P2	P1	P2Q	P1Q	P2Q	P1Q	P2XL	P1XL	P2XL	P1XL
Rb	RHG/RLG	(Note 1)	RHG/RLG	(Note 1)	RHGQ/RLGQ	(Note 1)	RHGQ/RLGQ	(Note 1)	RXL	(Note 1)	RXL	(Note 1)
R2ab	R2HG/R2LG				R2HGQ/R2LGQ				R2XL			
FDGab	-8 V				-8 V				-8 V			
H1Sc	P1		(Note 1)		P1Q		(Note 1)		P1XL		(Note 1)	
H1Bc	P1		(Note 1)		P1Q		(Note 1)		P1XL		(Note 1)	
H2Sc	P2		(Note 1)		P2Q		(Note 1)		P2XL		(Note 1)	
H2Bc	P2		(Note 1)		P2Q		(Note 1)		P2XL		(Note 1)	
Rc	RHG/RLG		(Note 1)		RHGQ/RLGQ		(Note 1)		RXL		(Note 1)	
H1Sd	P1		(Note 1)		P1Q		(Note 1)		P1XL		(Note 1)	
H1Bd	P1	P2	(Note 1)		P1Q	P2Q	(Note 1)		P1XL	P2XL	(Note 1)	
H2Sd	P2		(Note 1)		P2Q		(Note 1)		P2XL		(Note 1)	
H2Bd	P2	P1	(Note 1)		P2Q	P1Q	(Note 1)		P2XL	P1XL	(Note 1)	
Rd	RHG/RLG	(Note 1)	(Note 1)		RHGQ/RLGQ	(Note 1)	(Note 1)		RXL	(Note 1)	(Note 1)	
R2cd	R2HG/R2LG		(Note 1)		R2HGQ/R2LGQ		(Note 1)		R2XL		(Note 1)	
FDGcd	-8 V				-8 V				-8 V			
SHP (Note 2)	SHP1				SHPQ				(Note 4)			
SHD (Note 2)	SHD1				SHDQ				(Note 5)			

1. This clock should be held at its high level voltage (0 V) or held at +5.0 V for compatibility with TRUESENSE 5.5 micron Interline Transfer CCD family of products.
2. SHP and SHD are the sample clocks for the analog front end (AFE) signal processor.
3. This note intentionally left empty.
4. Use SHPLG for the AFE processing the low gain signal. Use SHPHG for the AFE processing the high gain signal.
5. Use SHDLG for the AFE processing the low gain signal. Use SHDHG for the AFE processing the high gain signal.

Timing Diagrams

The charge in the photodiodes is transferred to the VCCD on the rising edge of the +12 V pulse and is completed by the falling edge of the +12 V pulsed on F1T and F1B. During the

time period when F1T and F1B are at +12 V (t_{PD}) anti-blooming protection is disabled. The photodiode integration time ends on the falling edge of the +12 V pulse.

Frame Timing – Quadrant and Dual VOUTa/VOUTc Readout Modes

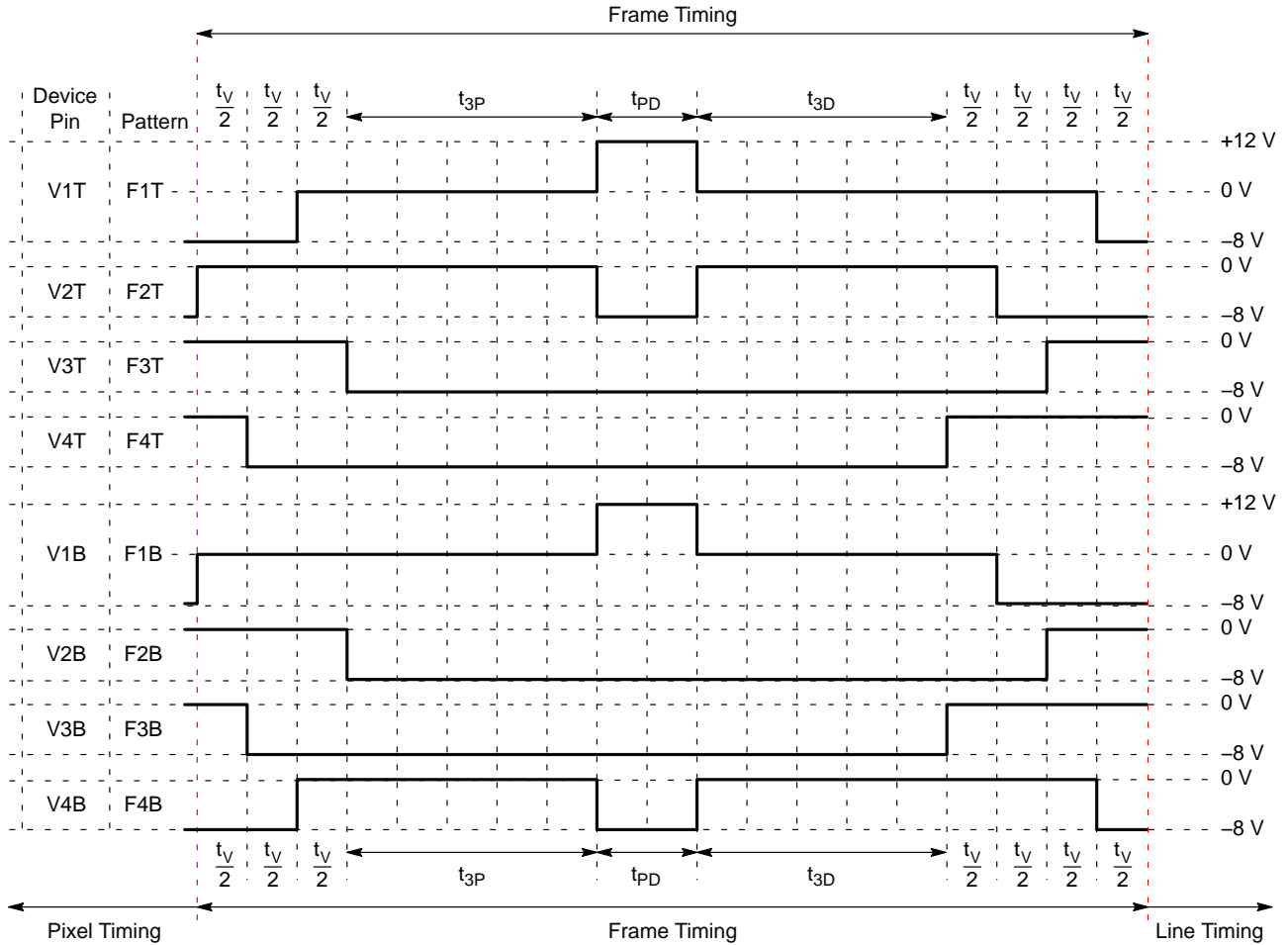

NOTE: See Table 19 for pin assignments.

Figure 32. Frame Timing Diagram Quadrant and Dual VOUTa/VOUTc Readout Modes

Frame Timing – Single and Dual VOUTa/VOUTb Readout Modes

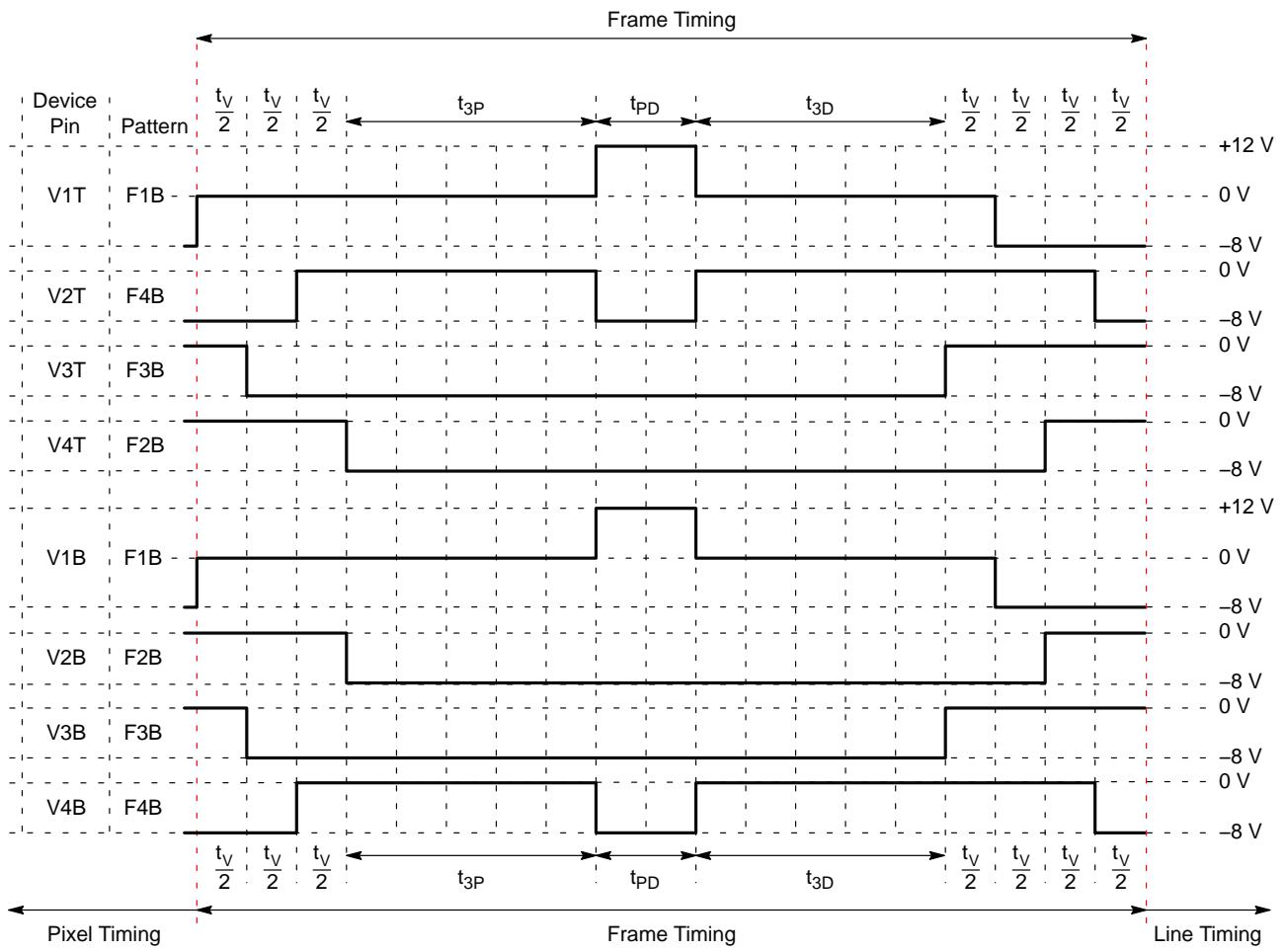

NOTE: See Table 19 for pin assignments.

Figure 33. Frame Timing Diagram Single and Dual VOUTa/VOUTb Readout Modes

Line Timing – Full Resolution – Quadrant and Dual VOUTa/VOUTc Readout Modes

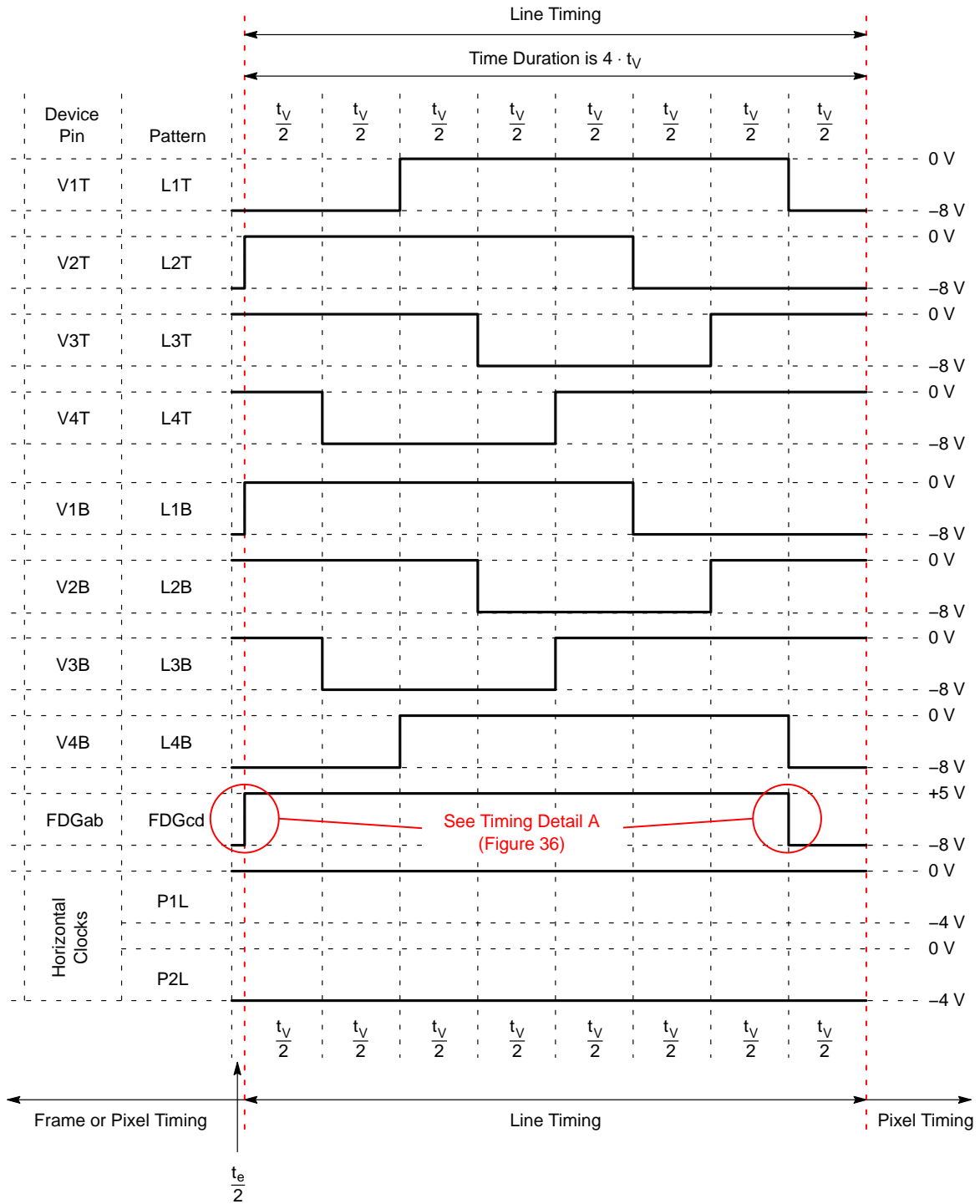

NOTE: See Table 20 for pin assignments.

Figure 34. Line Timing Diagram – Full Resolution – Quadrant and Dual VOUTa/VOUTc Readout Modes

Line Timing – Full Resolution – Single and Dual VOUTa/VOUTb Readout Modes

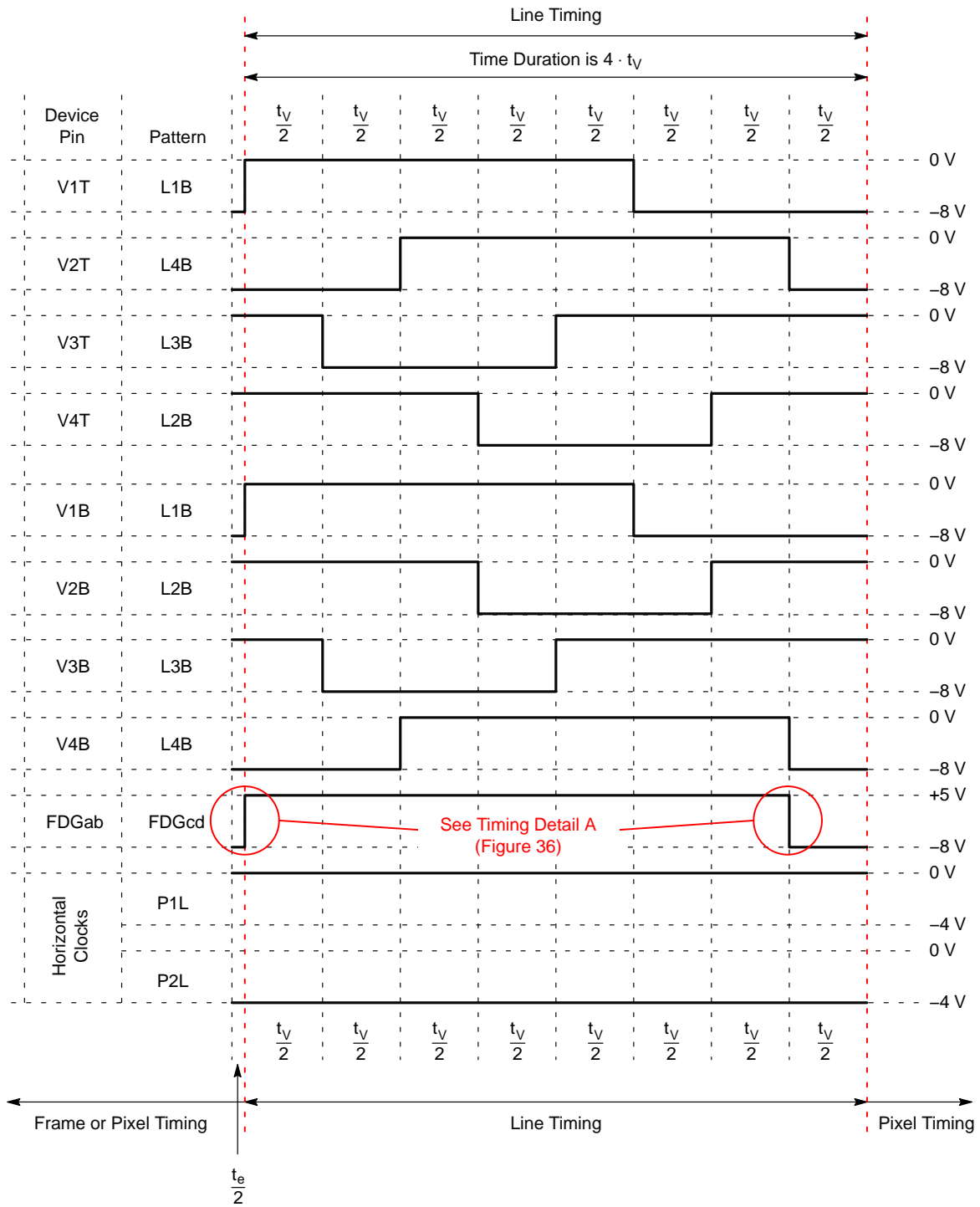

NOTE: See Table 20 for pin assignments.

Figure 35. Line Timing Diagram – Full Resolution – Single and Dual VOUTa/VOUTb Readout Modes

If the line is to be dumped then clock the FDGab and FDGcd pins as shown. This dumping process eliminates a line of charge and the HCCD does not have to be clocked.

To transfer a line from the VCCD to the HCCD without dumping the charge, hold the FDGab and FDGcd pins at a constant -8 V.

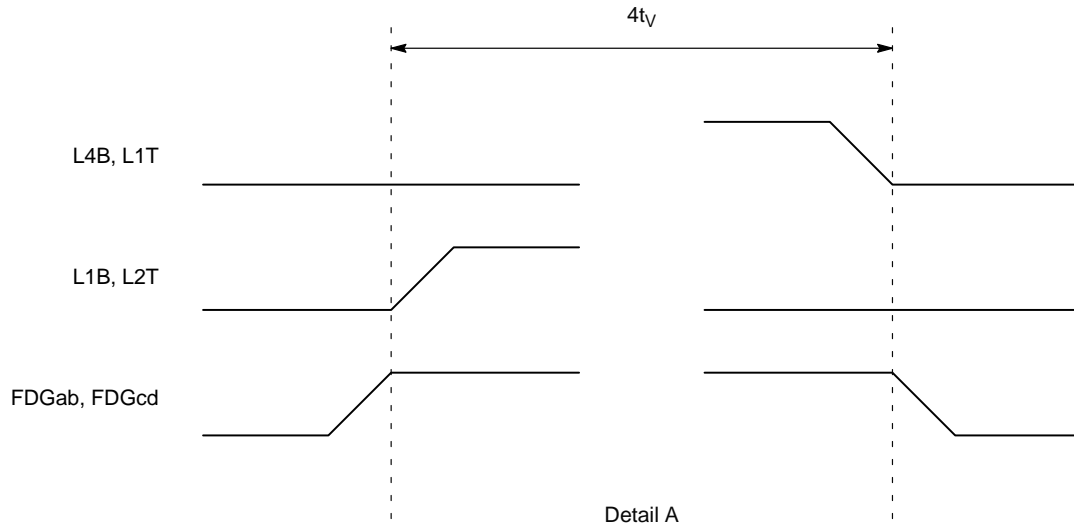
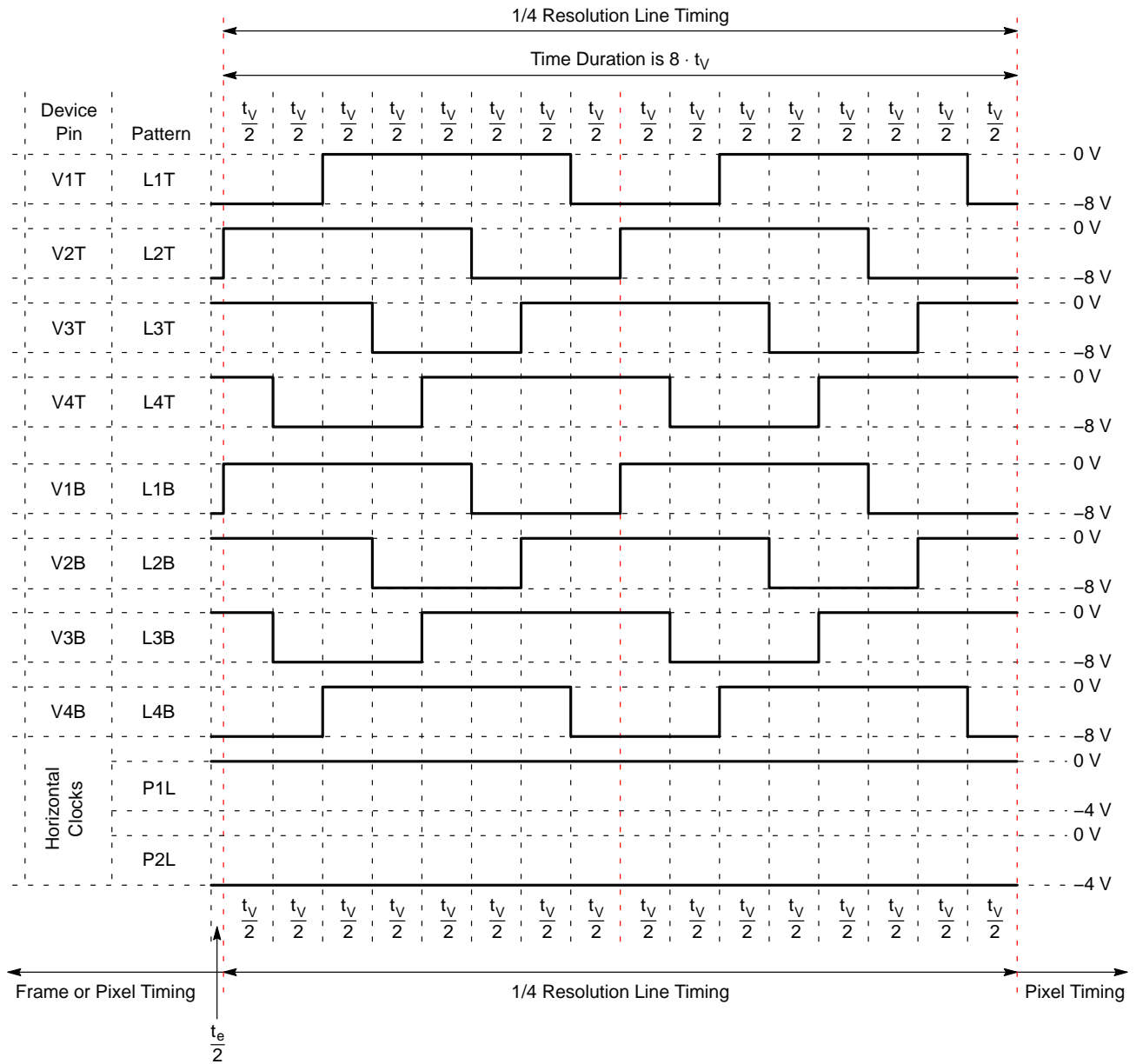

Figure 36. Fast Dump Gate Timing Detail A

When the VCCD is clocked while the FDGab and FDGcd pins are at +5 V, charge is diverted to a drain instead of transferring to the HCCD. The FDG pins must be at +5 V before the first VCCD timing edge begins its transition.

The FDG pin must not begin its transition from +5 V back to -8 V until the last VCCD timing edge has completed its transition.



NOTE: See Table 20 for pin assignments.

Figure 37. Line Timing Diagram – 1/4 Resolution – Quadrant and Dual VOUTa/VOUTc Readout Modes

Line Timing – Low Gain, High Gain and XLDR 1/4 Resolution – Single and Dual VOUTa/VOUTb Readout Modes

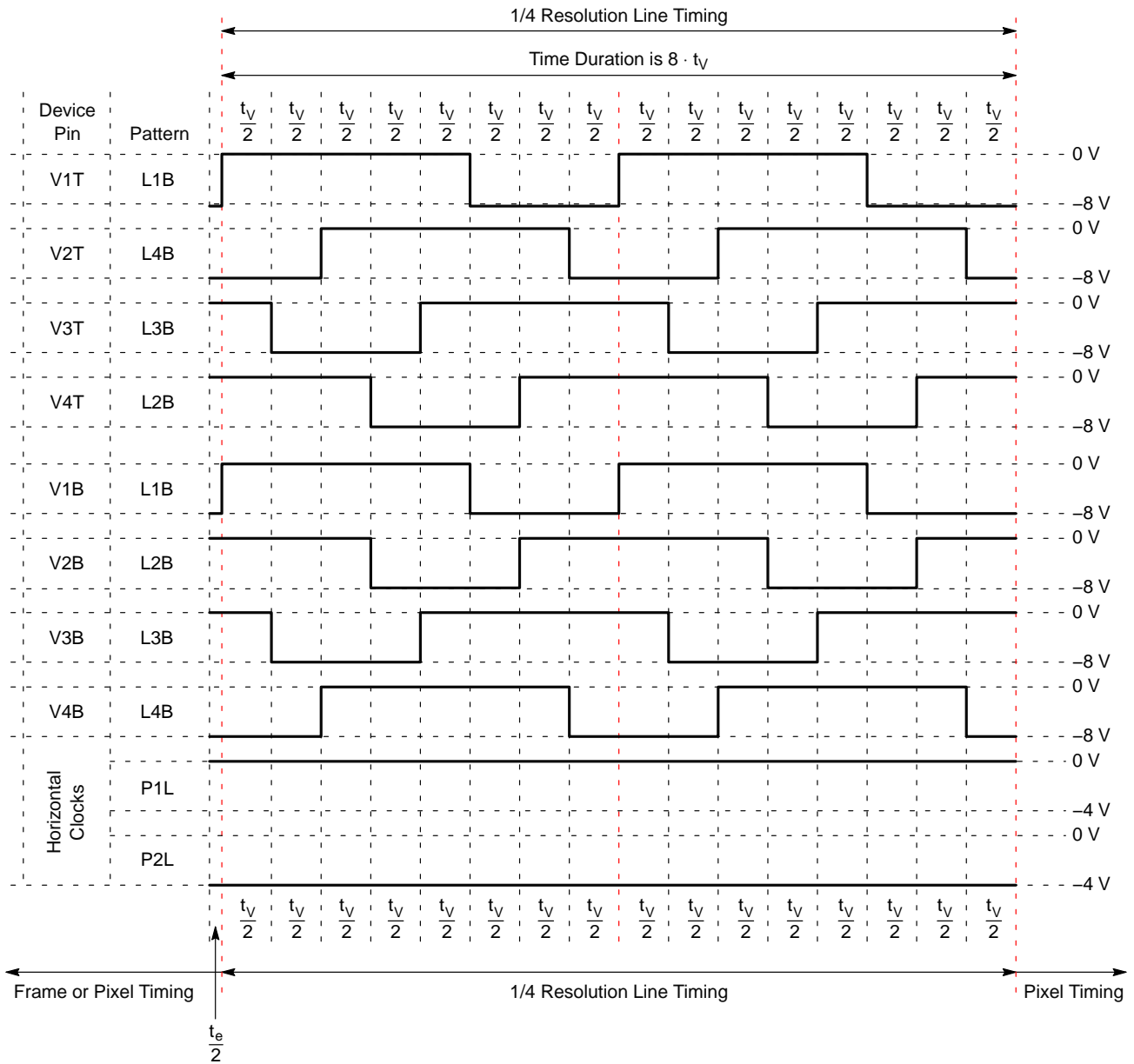

NOTE: See Table 20 for pin assignments.

Figure 38. Line Timing Diagram – 1/4 Resolution – Single and Dual VOUTa/VOUTb Readout Modes

Electronic Shutter Timing Diagrams

The electronic shutter pulse can be inserted at the end of any line of the HCCD timing. The HCCD should be empty when the electronic shutter is pulsed. A recommended position for the electronic shutter is just after the last pixel is read out of a line. The VCCD clocks should not resume until at least $t_V/2$ after the electronic shutter pulse has

finished. The HCCD clocks can be run during the electronic shutter pulse as long as the HCCD does not contain valid image data.

For short exposures less than one line time, the electronic shutter pulse can appear inside the frame timing. Any electronic shutter pulse transition should be $t_V/2$ away from any VCCD clock transition.

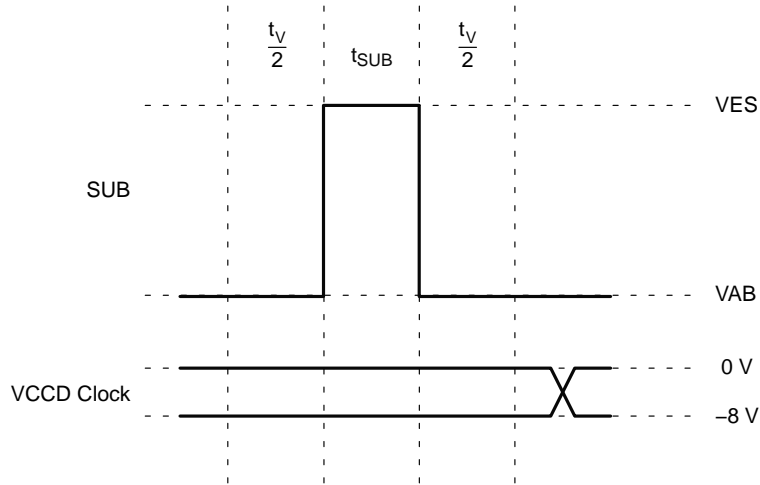

Figure 39. Electronic Shutter Timing

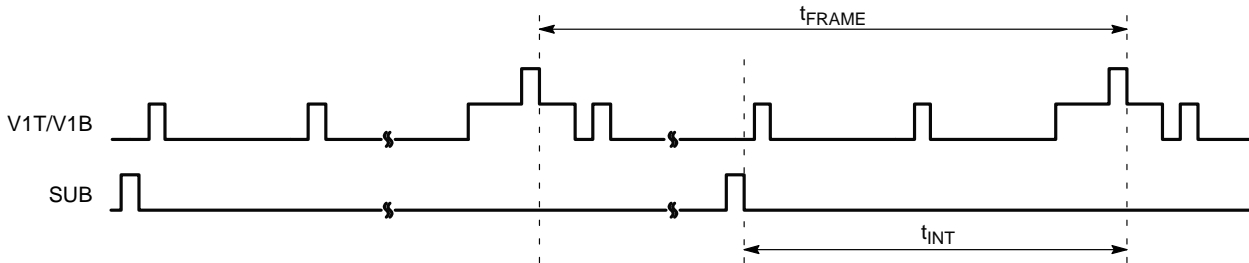

Figure 40. Frame/Electrical Shutter Timing

Pixel Timing – Full Resolution – High Gain Pixel Timing

Use this timing to read out every pixel at high gain. If the sensor is to be permanently operated at high gain, the R2ab and R2cd pins can be left floating or set to any DC voltage between +3 V and +5 V. Note the R2ab and R2cd pins are

internally biased to +4.3 V when left floating. The SHP1 and SHD1 pulses indicate where the camera electronics should sample the video waveform. The SHP1 and SHD1 pulses are not applied to the image sensor.

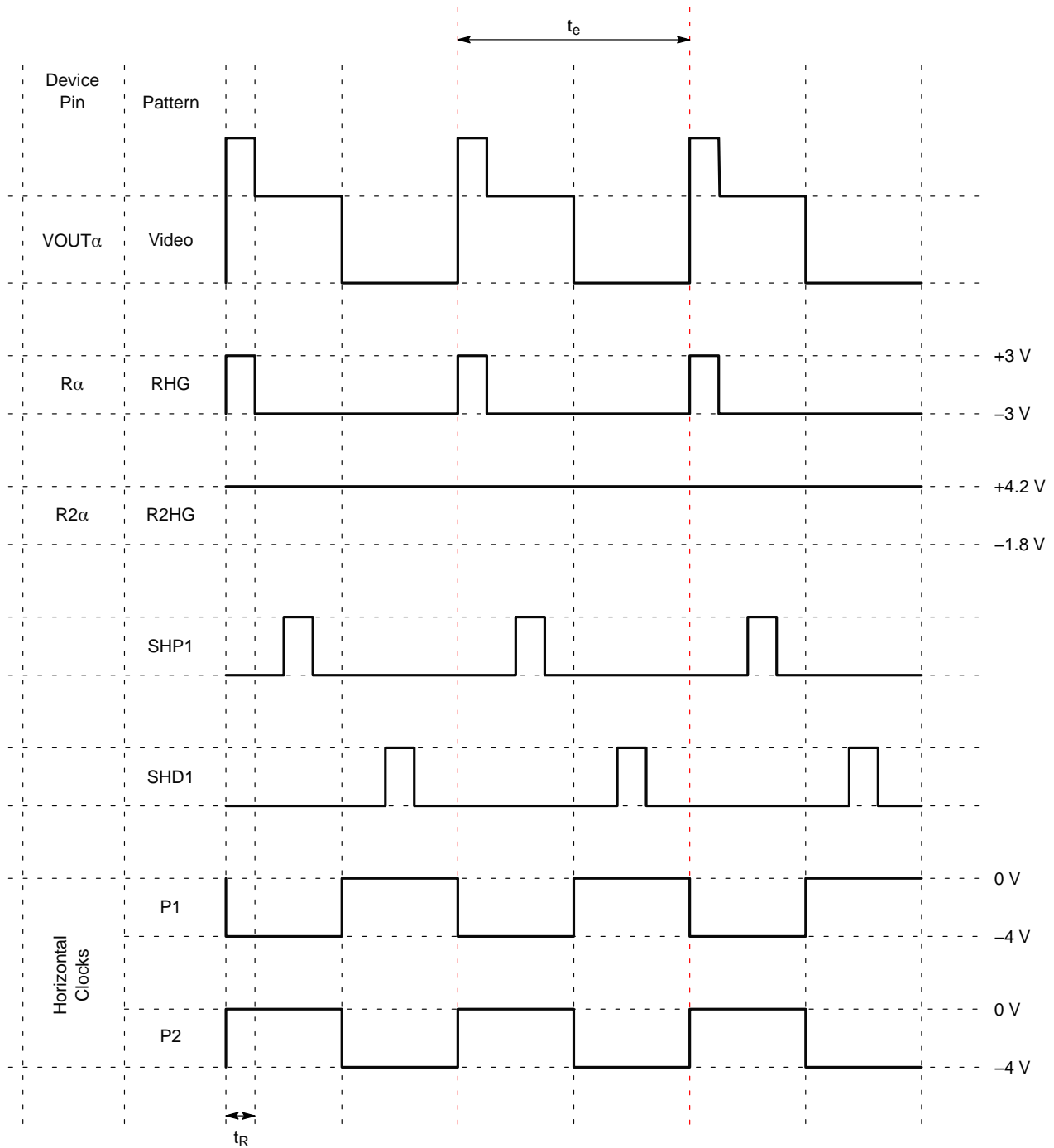

Figure 41. Pixel Timing Diagram – Full Resolution – High Gain

Pixel Timing – Full Resolution – Low Gain Pixel Timing

Use this pixel timing to read out every pixel at low gain. If the sensor is to be permanently operated at low gain, the Ra, Rb, Rc and Rd pins should be set to any DC voltage between +3 V and +5 V. The SHP1 and SHD1 pulses

indicate where the camera electronics should sample the video waveform. The SHP1 and SHD1 pulses are not applied to the image sensor.

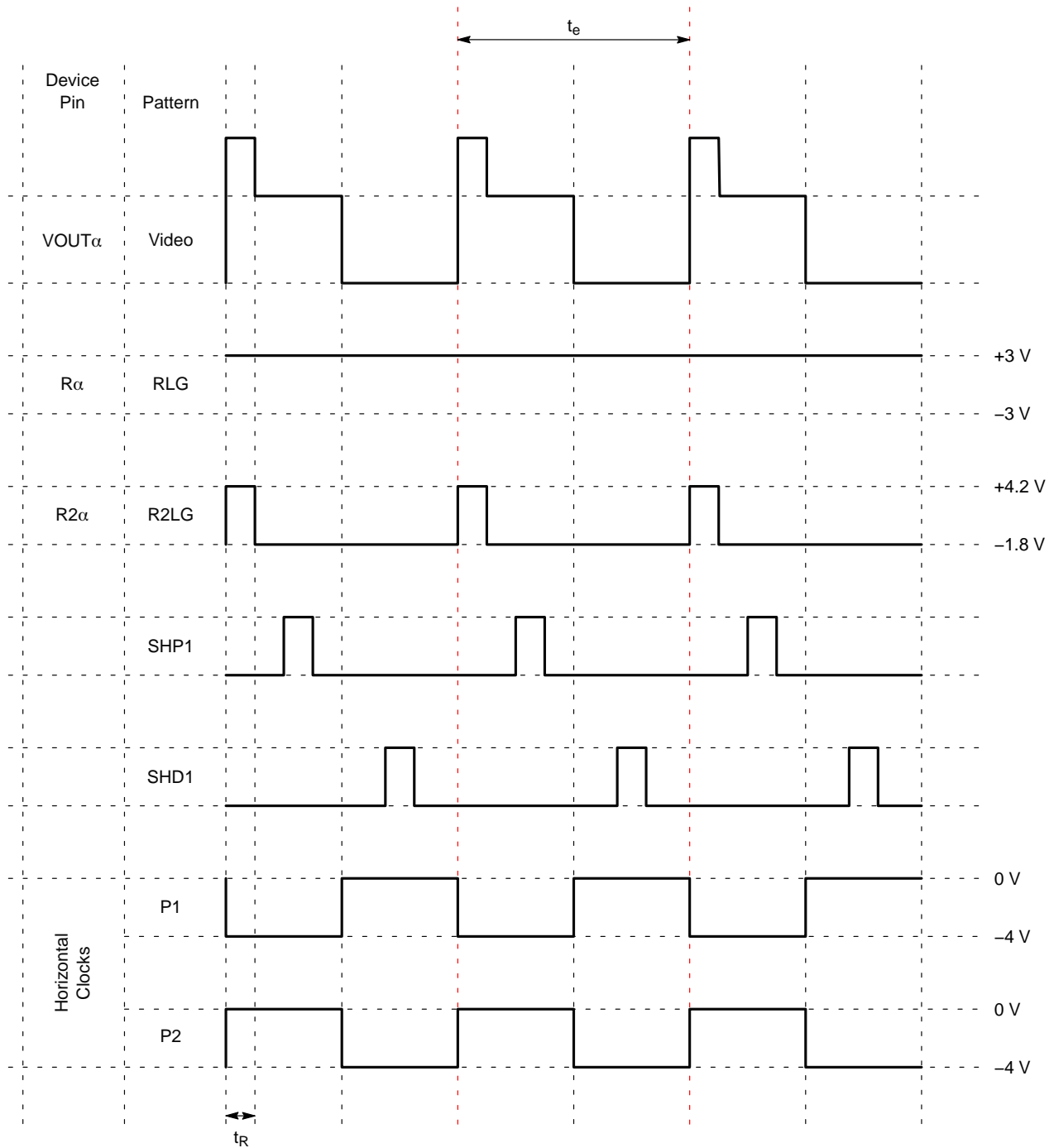

Figure 42. Pixel Timing Diagram – Full Resolution – Low Gain

Pixel Timing – 1/4 Resolution – High Gain Pixel Timing

Use this timing to read out two pixels summed on the output amplifier sense node at high gain. If the sensor is to be permanently operated at high gain, the R2ab and R2cd pins can be left floating or set to any DC voltage between +3 V and +5 V. Note the R2ab and R2cd pins are internally biased to +4.3 V when left floating. The SHPQ and SHDQ pulses indicate where the camera electronics should sample

the video waveform. The SHPQ and SHDQ pulses are not applied to the image sensor.

The Ra, Rb, Rc, and Rd pins are pulsed at half the frequency of the horizontal CCD clocks. This causes two pixels to be summed on the output amplifier sense node. The SHPQ and SHDQ clocks are also half the frequency of the horizontal CCD clocks.

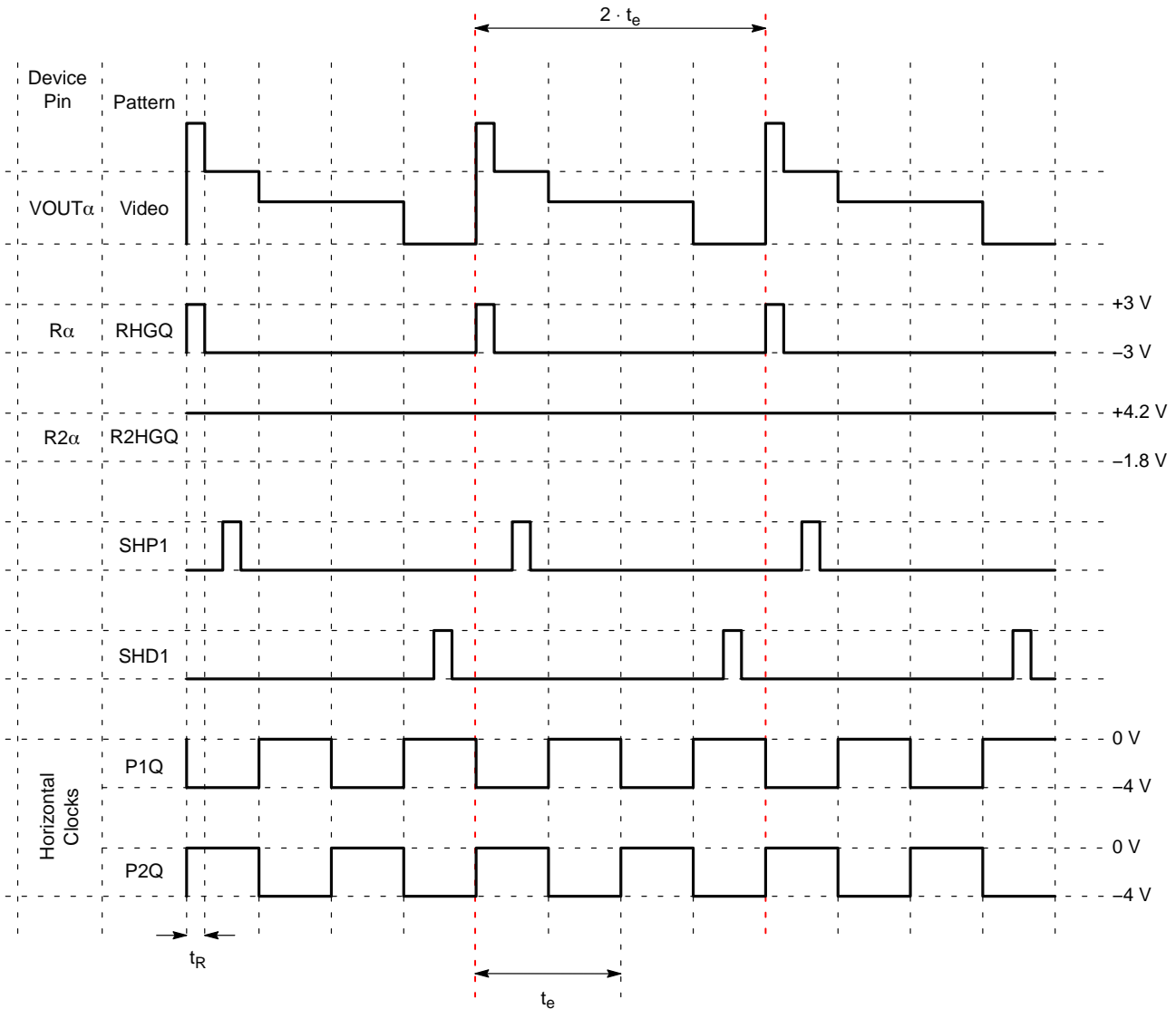

Figure 43. Pixel Timing Diagram – 1/4 Resolution – High Gain

Pixel Timing – 1/4 Resolution – Low Gain Pixel Timing

Use this timing to read out two pixels summed on the output amplifier sense node at low gain. If the sensor is to be permanently operated at low gain, the Ra, Rb, Rc and Rd pins can be set to any DC voltage between +3 V and +5 V. The SHPQ and SHDQ pulses indicate where the camera electronics should sample the video waveform. The SHPQ and SHDQ pulses are not applied to the image sensor.

The R2ab and R2cd pins are pulsed at half the frequency of the horizontal CCD clocks. This causes two pixels to be summed on the output amplifier sense node. The SHPQ and SHDQ clocks are also half the frequency of the horizontal CCD clocks.

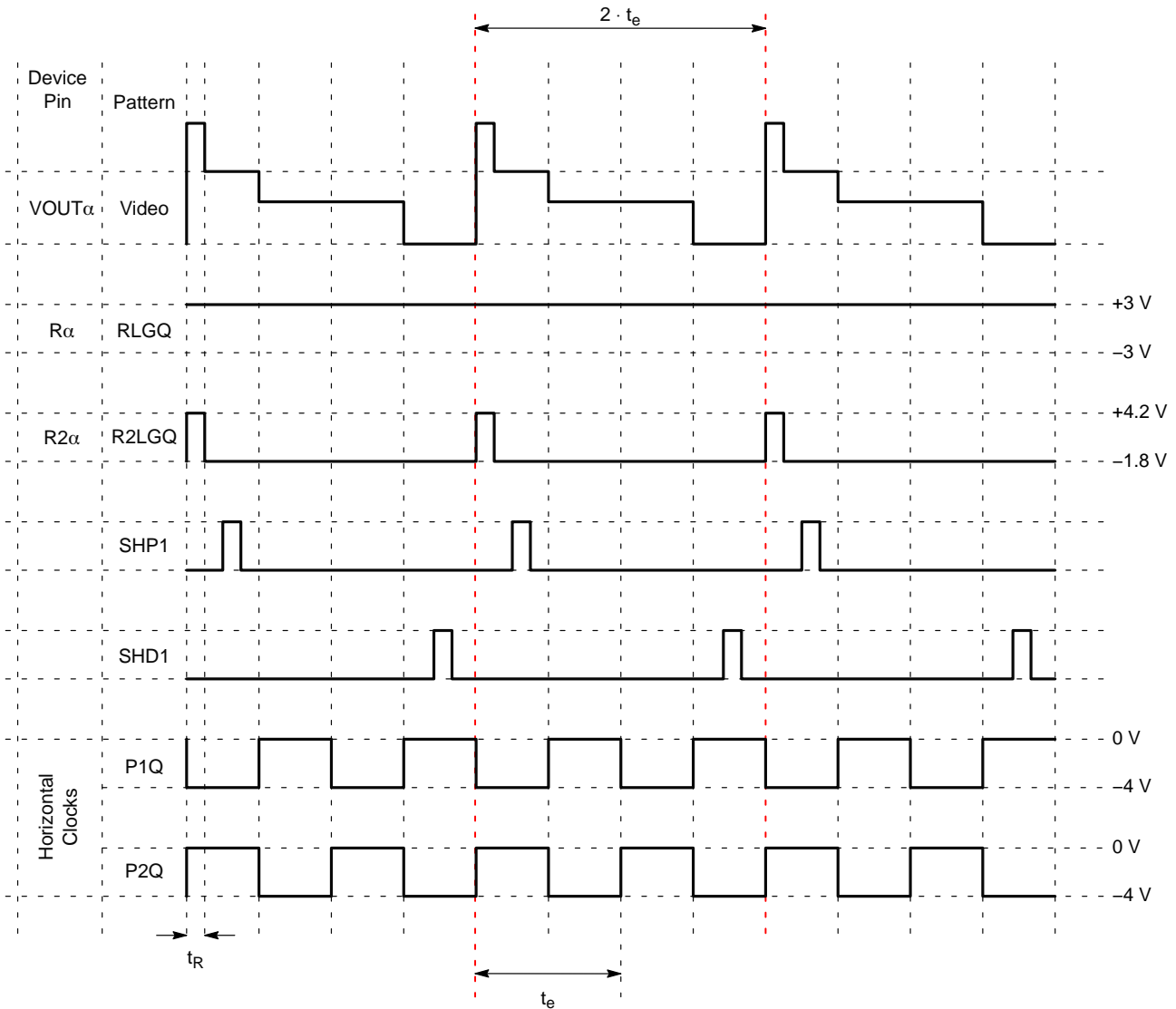

Figure 44. Pixel Timing Diagram – 1/4 Resolution – Low Gain

XLDR Pixel Timing

To operate the sensor in extended linear dynamic range (XLDR) mode, the following pixel timing should be used. This mode requires two sets of analog front end (AFE) signal processing electronic units for each output. As shown in Figure 45 one AFE samples the pixel at low gain (SHPLG and SHDLG) and the other AFE samples the pixel at high gain (SHPHG and SHDHG).

Two HCCD pixels are summed on the output amplifier node to obtain enough charge to fully use the 82 dB range of the XLDR timing. Combined with two-line VCCD summing, a total of 160,000 electrons of signal ($4 \times 40,000$)

can be sampled with 12 electrons or less noise. Note that a linear dynamic range of 82 dB is very large. Ensure that the camera optics is capable of focusing an 82 dB dynamic range image on the sensor. Lens flare caused by inexpensive optics or even dust on the lens will limit the dynamic range.

The timing shown in Figure 47 shows the HCCD not being clocked at a constant frequency. If the HCCD cannot be clocked at a variable frequency, then the HCCD may be clocked at a constant frequency (Figure 46) at the expense of about 33% slower frame rate.

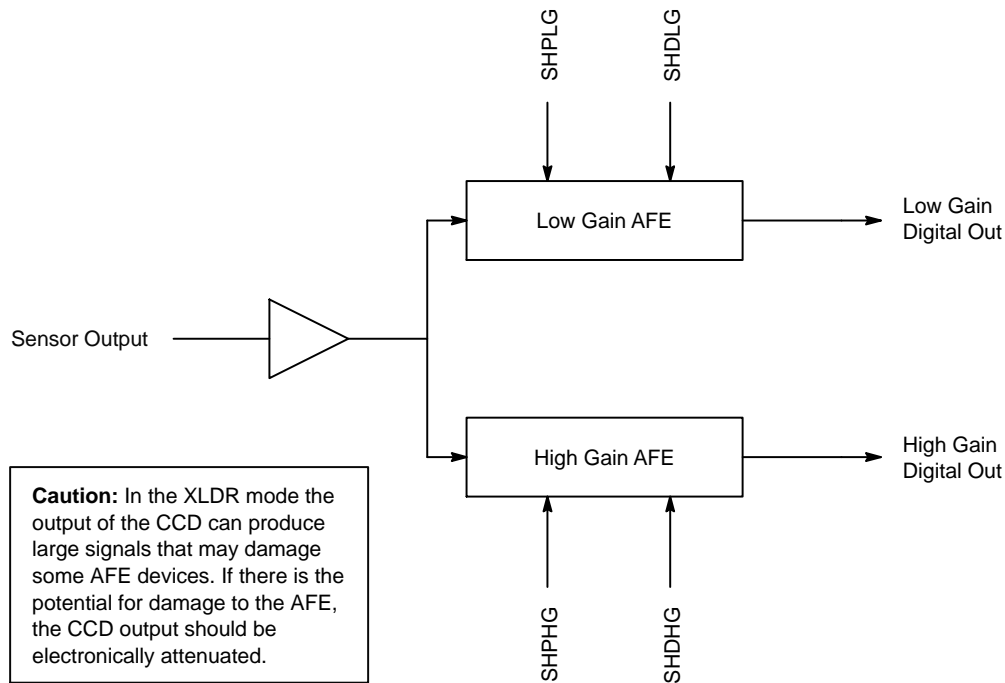

Figure 45. XLDR Timing – AFE Connections Block Diagram

Pixel Timing – 1/4 Resolution – XLDR Pixel Timing – Constant HCCD Timing

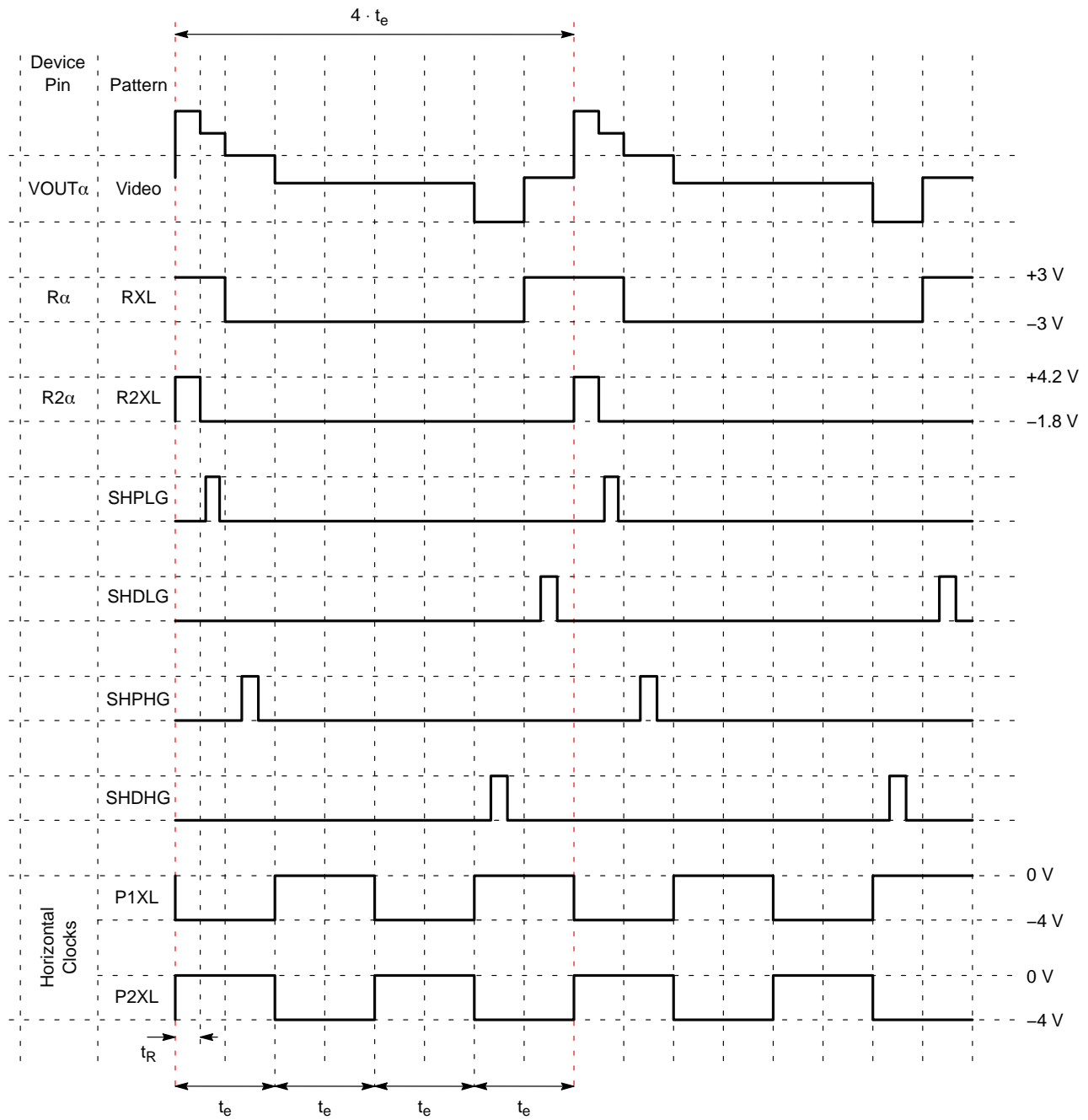

Figure 46. Pixel Timing Diagram – 1/4 Resolution – XLDR – Constant HCCD Timing

Pixel Timing – 1/4 Resolution – XLDR Pixel Timing – Variable HCCD Timing

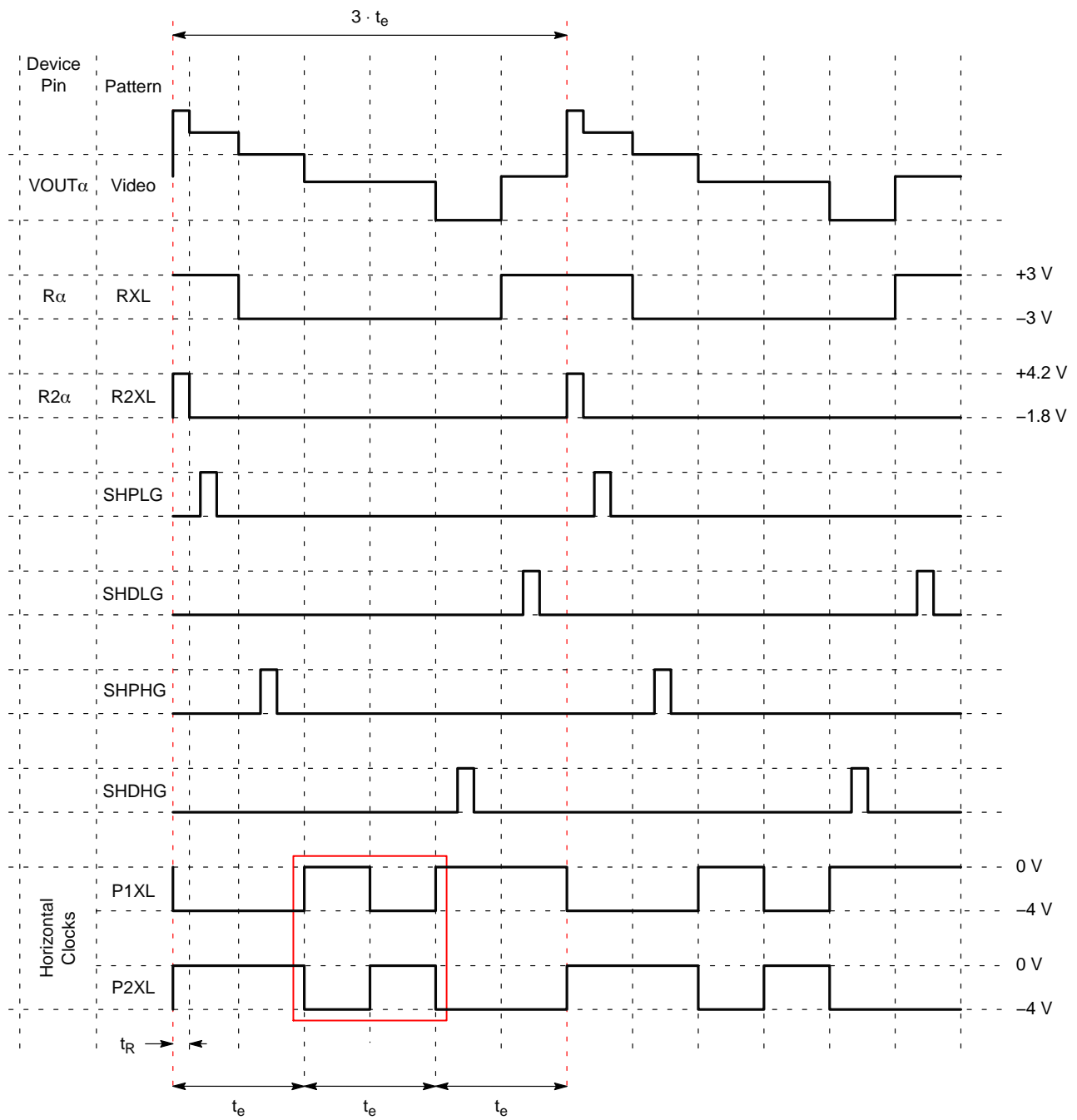

Figure 47. Pixel Timing Diagram – 1/4 Resolution – XLDR – Variable HCCD Timing

VCCD Clock Edge Alignment

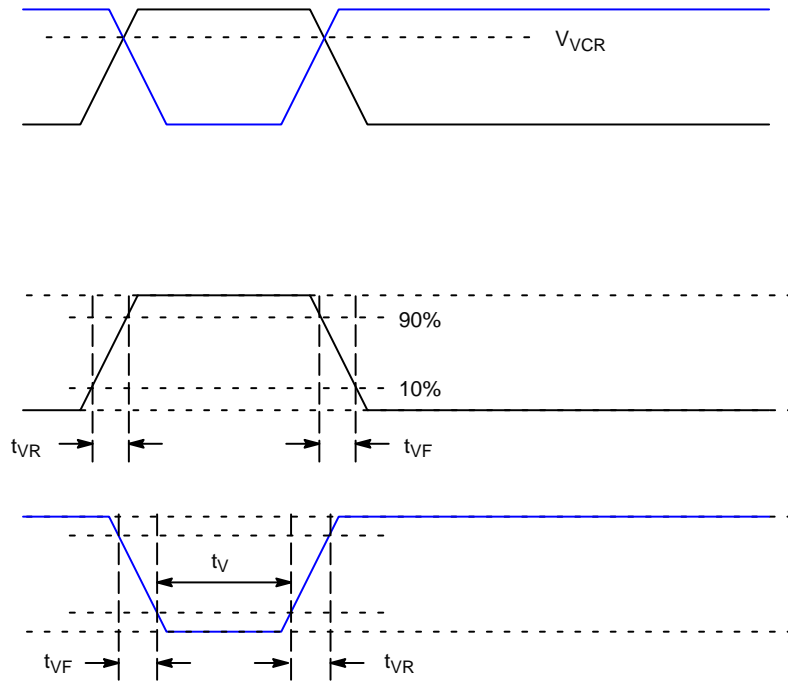

Figure 48. VCCD Clock Rise Time, Fall Time and Edge Alignment

STORAGE AND HANDLING

Table 22. STORAGE CONDITIONS

Description	Symbol	Minimum	Maximum	Unit	Notes
Storage Temperature	T _{ST}	-55	80	°C	1
Humidity	RH	5	90	%	2

1. Long-term storage toward the maximum temperature will accelerate color filter degradation.
2. T = 25°C. Excessive humidity will degrade MTTF.

For information on ESD and cover glass care and cleanliness, please download the *Image Sensor Handling and Best Practices* Application Note (AN52561/D) from www.onsemi.com.

For information on environmental exposure, please download the *Using Interline CCD Image Sensors in High Intensity Lighting Conditions* Application Note (AND9183/D) from www.onsemi.com.

For information on soldering recommendations, please download the *Soldering and Mounting Techniques Reference Manual* (SOLDERRM/D) from www.onsemi.com.

For quality and reliability information, please download the *Quality & Reliability Handbook* (HBD851/D) from www.onsemi.com.

For information on device numbering and ordering codes, please download the *Device Nomenclature* technical note (TND310/D) from www.onsemi.com.

For information on Standard terms and Conditions of Sale, please download [Terms and Conditions](http://www.onsemi.com) from www.onsemi.com.

MECHANICAL INFORMATION

Completed Assembly

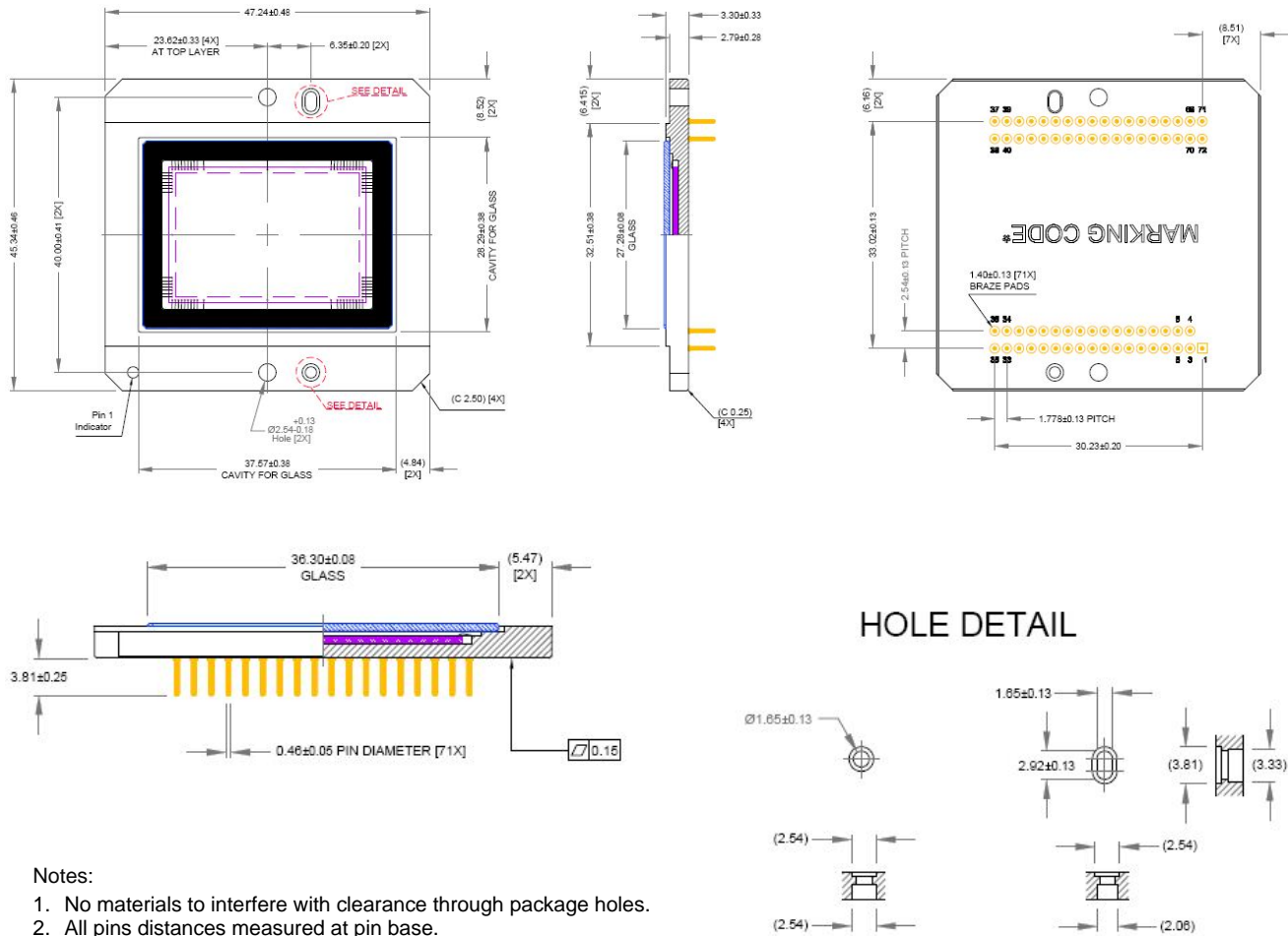

Notes:

1. No materials to interfere with clearance through package holes.
2. All pins distances measured at pin base.

Figure 49. Completed Assembly (1 of 2)

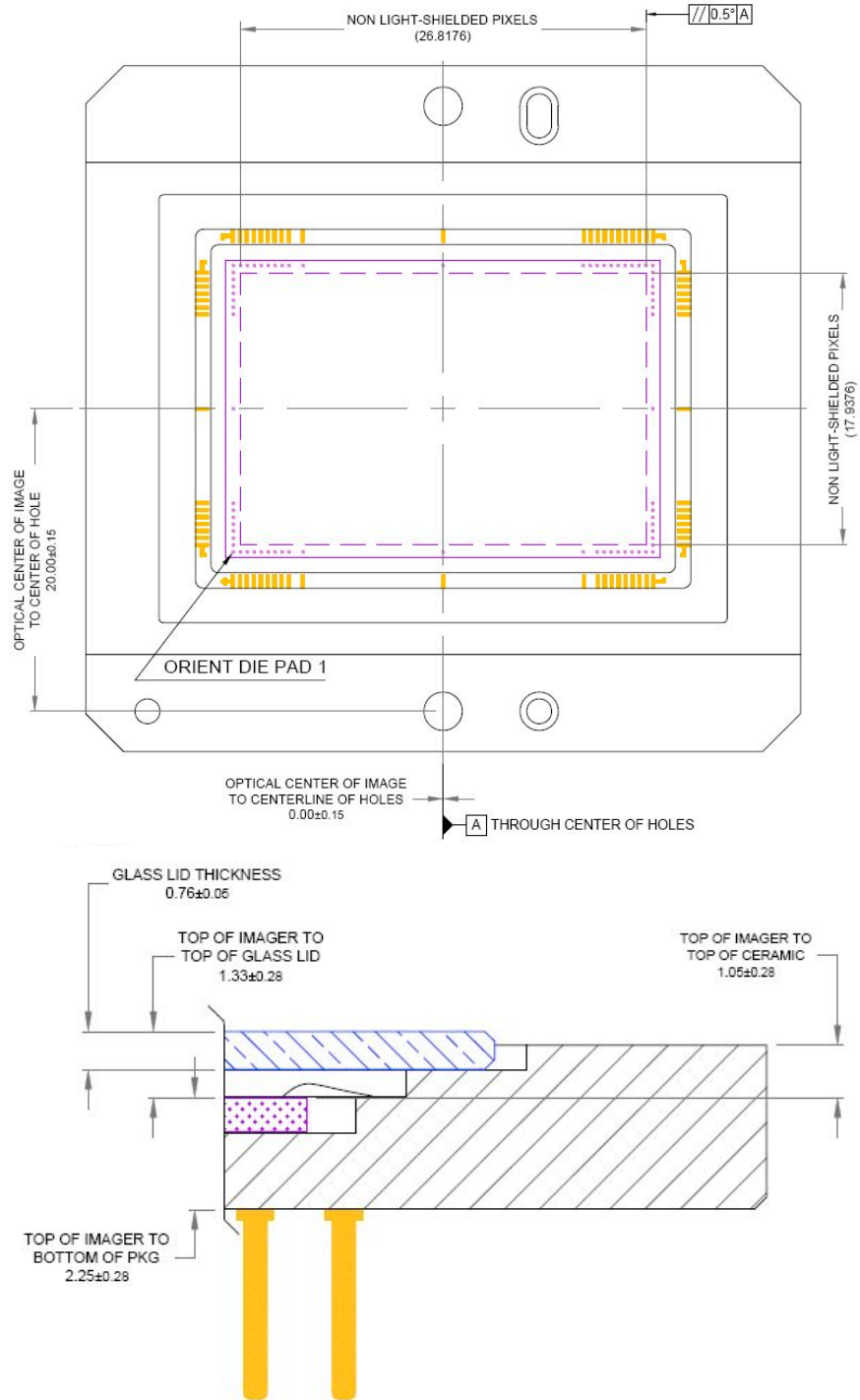

Notes:

1. Die thickness is 0.675 ±0.025 mm.
2. Imager is stepped at (X) 28.760 and (Y) 19.740 mm or standard 150 mm wafer
3. Assuming a 50 micron kerf, singulated die are approximately 28.71 × 19.69 mm.
4. Center of image array is at center of die.

Figure 50. Completed Assembly (2 of 2)

Cover Glass

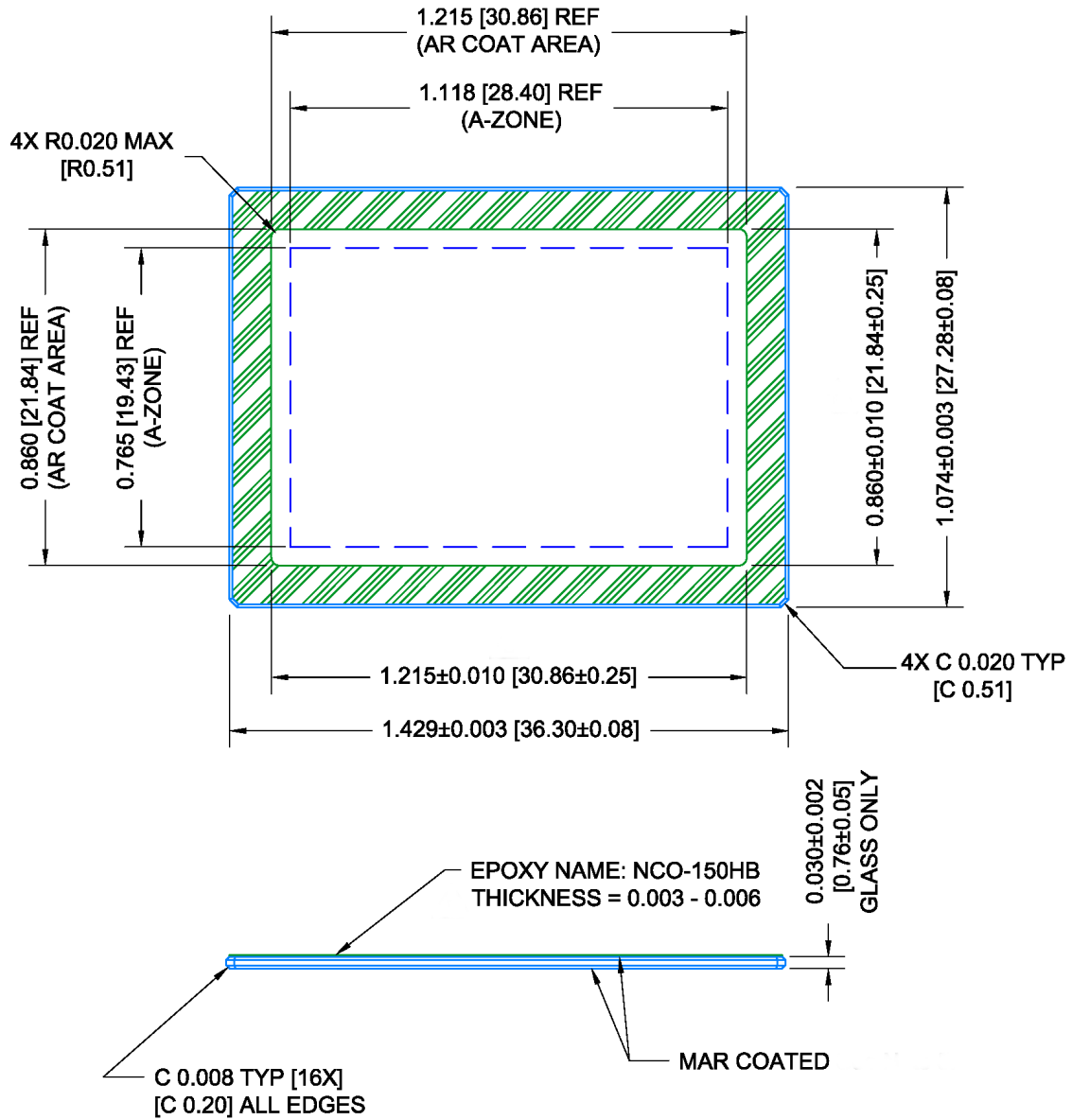

Notes:

1. Substrate = Schott D263T eco.
2. Dust, Scratch, Inclusion Specification: 10 μm maximum size in Zone A.
3. MAR coated both sides.
4. Spectral Transmission:
 - a. T > 98.0% 420-435 nm
 - b. T > 99.2% 435-630 nm
 - c. T > 98.0% 630-680 nm
5. Units: mm.

Figure 51. Cover Glass

Cover Glass Transmission

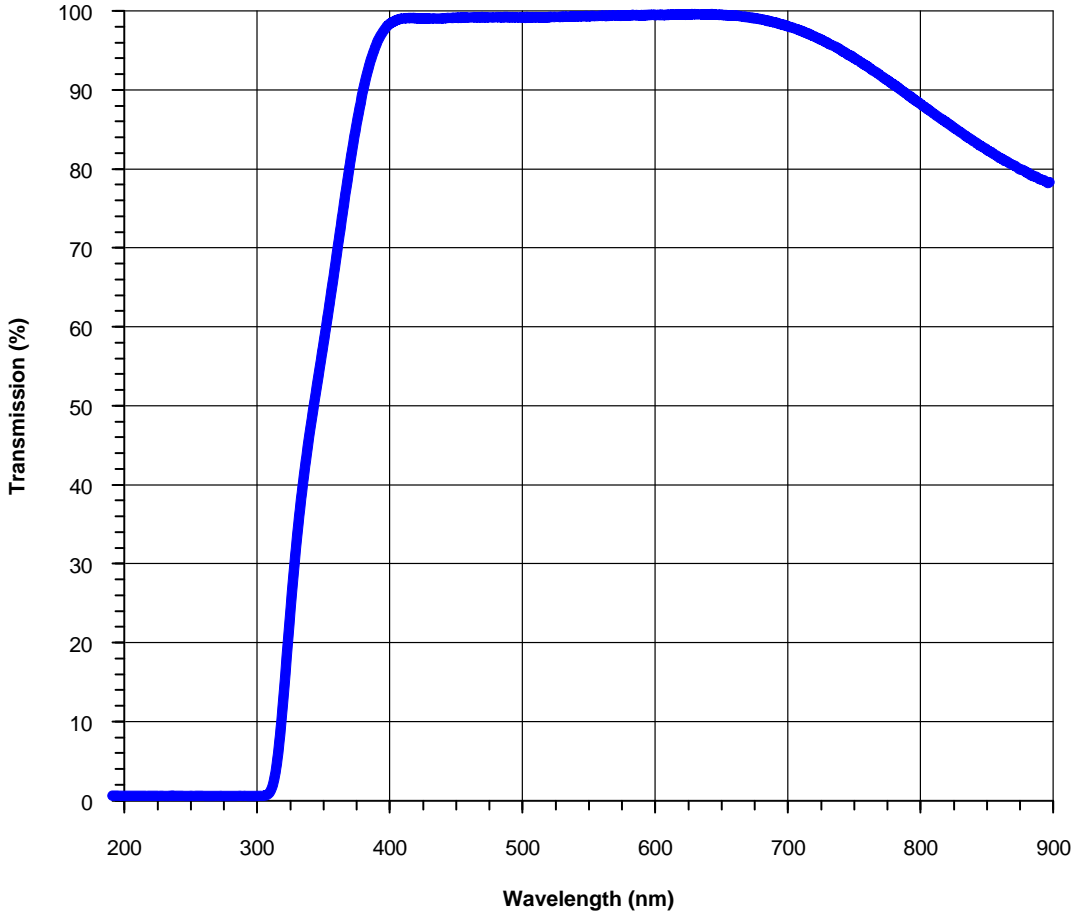



Figure 52. Cover Glass Transmission

ON Semiconductor and the  are registered trademarks of Semiconductor Components Industries, LLC (SCILLC) or its subsidiaries in the United States and/or other countries. SCILLC owns the rights to a number of patents, trademarks, copyrights, trade secrets, and other intellectual property. A listing of SCILLC's product/patent coverage may be accessed at www.onsemi.com/site/pdf/Patent-Marking.pdf. SCILLC reserves the right to make changes without further notice to any products herein. SCILLC makes no warranty, representation or guarantee regarding the suitability of its products for any particular purpose, nor does SCILLC assume any liability arising out of the application or use of any product or circuit, and specifically disclaims any and all liability, including without limitation special, consequential or incidental damages. "Typical" parameters which may be provided in SCILLC data sheets and/or specifications can and do vary in different applications and actual performance may vary over time. All operating parameters, including "Typicals" must be validated for each customer application by customer's technical experts. SCILLC does not convey any license under its patent rights nor the rights of others. SCILLC products are not designed, intended, or authorized for use as components in systems intended for surgical implant into the body, or other applications intended to support or sustain life, or for any other application in which the failure of the SCILLC product could create a situation where personal injury or death may occur. Should Buyer purchase or use SCILLC products for any such unintended or unauthorized application, Buyer shall indemnify and hold SCILLC and its officers, employees, subsidiaries, affiliates, and distributors harmless against all claims, costs, damages, and expenses, and reasonable attorney fees arising out of, directly or indirectly, any claim of personal injury or death associated with such unintended or unauthorized use, even if such claim alleges that SCILLC was negligent regarding the design or manufacture of the part. SCILLC is an Equal Opportunity/Affirmative Action Employer. This literature is subject to all applicable copyright laws and is not for resale in any manner.

PUBLICATION ORDERING INFORMATION

LITERATURE FULFILLMENT:
 Literature Distribution Center for ON Semiconductor
 P.O. Box 5163, Denver, Colorado 80217 USA
Phone: 303-675-2175 or 800-344-3860 Toll Free USA/Canada
Fax: 303-675-2176 or 800-344-3867 Toll Free USA/Canada
Email: orderlit@onsemi.com

N. American Technical Support: 800-282-9855 Toll Free
 USA/Canada
Europe, Middle East and Africa Technical Support:
 Phone: 421 33 790 2910
Japan Customer Focus Center
 Phone: 81-3-5817-1050

ON Semiconductor Website: www.onsemi.com
Order Literature: <http://www.onsemi.com/orderlit>
 For additional information, please contact your local
 Sales Representative

Данный компонент на территории Российской Федерации

Вы можете приобрести в компании MosChip.

Для оперативного оформления запроса Вам необходимо перейти по данной ссылке:

<http://moschip.ru/get-element>

Вы можете разместить у нас заказ для любого Вашего проекта, будь то серийное производство или разработка единичного прибора.

В нашем ассортименте представлены ведущие мировые производители активных и пассивных электронных компонентов.

Нашей специализацией является поставка электронной компонентной базы двойного назначения, продукции таких производителей как XILINX, Intel (ex.ALTERA), Vicor, Microchip, Texas Instruments, Analog Devices, Mini-Circuits, Amphenol, Glenair.

Сотрудничество с глобальными дистрибьюторами электронных компонентов, предоставляет возможность заказывать и получать с международных складов практически любой перечень компонентов в оптимальные для Вас сроки.

На всех этапах разработки и производства наши партнеры могут получить квалифицированную поддержку опытных инженеров.

Система менеджмента качества компании отвечает требованиям в соответствии с ГОСТ Р ИСО 9001, ГОСТ РВ 0015-002 и ЭС РД 009

Офис по работе с юридическими лицами:

105318, г.Москва, ул.Щербаковская д.3, офис 1107, 1118, ДЦ «Щербаковский»

Телефон: +7 495 668-12-70 (многоканальный)

Факс: +7 495 668-12-70 (доб.304)

E-mail: info@moschip.ru

Skype отдела продаж:

moschip.ru

moschip.ru_4

moschip.ru_6

moschip.ru_9