

# RTE Series Low Profile Rotary DIP Switches



H  
DIP

## Features/Benefits

- Thru-hole and surface mount models
- Miniature size with robust metal cover in black or silver nickel finish
- 4, 10, & 16 positions
- Large choice of codings
- Vertical, right angle or reverse versions
- RoHS compliant

## Typical Applications

- Timers, automation components
- Computer and peripherals
- Alarms, access control, smoke detectors, lighting, home protection
- Instrumentation



## Specifications

### CONTACT RATING:

Gold: 100 mA max. 10 $\mu$  A min. 30 V DC max. 20 mVDC min.

MECHANICAL LIFE: 20,000 indexations

CONTACT RESISTANCE: 100 m $\Omega$  max. initial;  
150 m $\Omega$  after life

INSULATION RESISTANCE: 10<sup>10</sup>  $\Omega$  min. initial

DIELECTRIC STRENGTH: 300 Vrms 1 mn

OPERATING TEMPERATURE: -25°C to 85°C.

STORAGE TEMPERATURE: -55°C to 85°C.

### PACKAGING:

Quantities

Terminations	Actuator	Tube	Box (in bulk)	Carrier tape	Standard Package
G	Flush, screwdriver slot			1250	1250 (1 reel)
	Shaft for button			750	750 (1 reel)
N	All versions	65			1950 (30 tubes)
V	All versions		150		1500 (10 boxes)
R	Flush, screwdriver slot	65			1950 (30 tubes)
	Shaft for button		150		1500 (10 boxes)

## Materials

COVER: Brass, nickel plated (black or silver)

BASE: PPS

ACTUATOR: LCP

MOVABLE CONTACTS: Copper alloy, gold plated.

STATIONARY CONTACTS: Brass, gold plated.

TERMINALS: See page I-28 to I-29

O-RING: Silicone

### SOLDERING PROCESS:

- Surface Mount Terminals: Infrared Reflow Soldering in accordance with IEC 61760-1.

- Non Reverse Thru-Hole Terminals: Lead free single or double wave soldering process according to C&K Procedure PS-LF-001

- Reverse Thru-Hole Terminals: Manual soldering: 3 sec / 350°C. Lead free single wave soldering process can be used but validation of the process must be done by customer

**Note:** Specifications and materials listed above are for switches with standard options. For information on specific and custom switches, consult Customer Service Center.

## How To Order

The Build-A Switch concept allows you to mix and match options to create the switch you need. Below is a complete listing of options shown in catalog. To order, simply select desired option from each category and place in the appropriate box.

*NOTE: Some of the configurations may not be available or could require some development.*



Number of Positions

- RTE04**    **ESD Protection and top plate**
- RTE10**    **0** Without ESD - standard plate
- RTE16**    **1** With ESD - standard plate <sup>2</sup>
- B** Without ESD - black plate

- Actuator**
- 0** Flush, screwdriver slot
- 2** Shaft for button

- Terminations**
- N** Thru-hole
- V** Right angle
- G** Surface mount
- R** Reverse, thru-hole

- Switch Function**
- 0** Single pole <sup>1</sup>
- 1** BCD code
- 3** Gray Code (for RTE 10)
- 4** Hexadecimal code (for RTE 16)
- 7** Gray Code (for RTE16)

- Contact/Terminal Material**
- 4** Gold 0.5  $\mu$ m/ lead free tin
- 7** Gold 1.0  $\mu$ m



1 - Single pole function not available for RTE10/RTE16  
2 - ESD protection available with "N" and "R" terminations only

# RTE Series Low Profile Rotary DIP Switches

## SWITCHES WITH STANDARD OPTIONS

### PC Mount-Terminal Option N



### Right Angle Mount-Terminal Option V

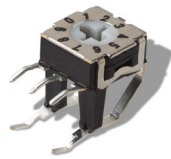

### Surface Mount-Terminal Option G

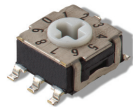

## NUMBER OF POSITIONS

### RTE04 4 POSITIONS



### RTE10 10 POSITIONS

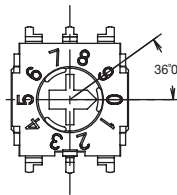

### RTE16 16 POSITIONS

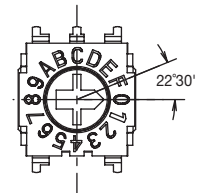

# RTE Series Low Profile Rotary DIP Switches



H

DIP

## ESD PROTECTION

0 WITHOUT



1 WITH

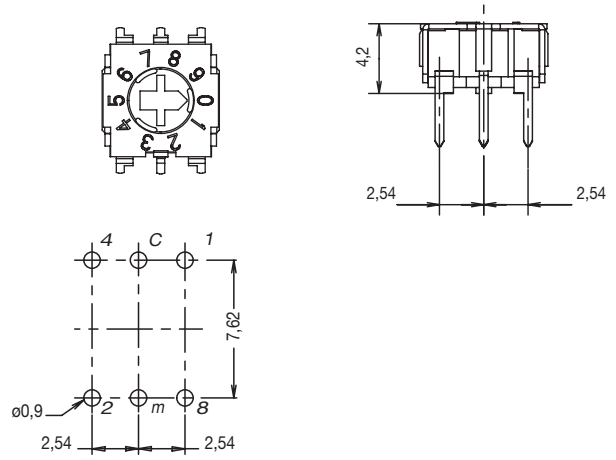

## ACTUATOR

0 SCREWDRIVER SLOT



For all RTE versions



Except for RTE1000Gx4 (SMT)  
RTE1600Gx4 (SMT)



2 SHAFT FOR BUTTON



Dimensions are shown: Inch (mm)  
Specifications and dimensions subject to change

# RTE Series Low Profile Rotary DIP Switches

## TERMINATIONS



DIP I

### N THRU-HOLE



### R REVERSE, THRU-HOLE



### V RIGHT ANGLE, THRU-HOLE

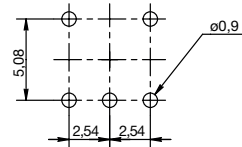

### G SURFACE MOUNT

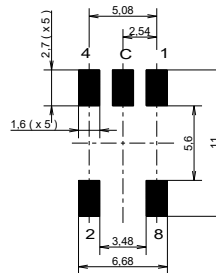
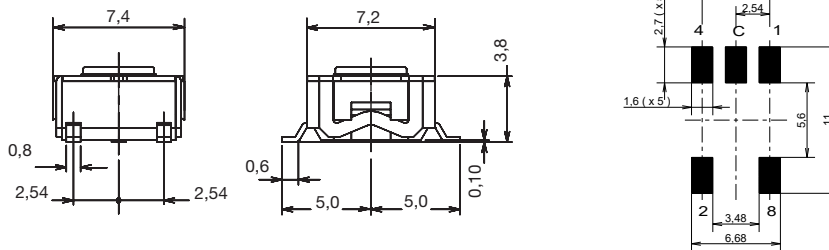

PCB layout seen component side





## SWITCH FUNCTION

### 0 SINGLE POLE

POS.	1	2	3	4
C	●	●	●	●
1	●			
2		●		
3			●	
4				●

### 1 BCD CODE

POS.	0	1	2	3	4	5	6	7	8	9
C	●	●	●	●	●	●	●	●	●	●
1		●								●
2			●	●			●	●		
4					●	●	●	●		
8									●	●

### 3 GRAY CODE ( for RTE10 only )

POS.	0	1	2	3	4	5	6	7	8	9
C	●	●	●	●	●	●	●	●	●	●
1		●	●				●	●		●
2			●	●	●					
4				●	●	●	●	●	●	●
8									●	●

### 4 HEXADECIMAL CODE

POS.	0	1	2	3	4	5	6	7	8	9	A	B	C	D	E	F
C	●	●	●	●	●	●	●	●	●	●	●	●	●	●	●	●
1		●				●		●		●		●		●		●
2			●	●			●	●			●		●	●		●
4					●	●	●	●				●	●	●	●	●
8									●	●	●	●	●	●	●	●

### 7 GRAY CODE (for RTE04 only)

POS.	1	2	3	4
C	●	●	●	●
1	●			
2		●		
4			●	
8				●

(for RTE16 only)

POS.	0	1	2	3	4	5	6	7	8	9	A	B	C	D	E	F
C	●	●	●	●	●	●	●	●	●	●	●	●	●	●	●	●
1		●	●						●	●		●		●		●
2			●	●	●	●					●	●	●	●		
4					●	●	●	●	●	●	●	●	●	●	●	●
8									●	●	●	●	●	●	●	●

## CONTACT MATERIAL

OPTION CODE	CONTACT MATERIAL	TERMINAL PLATING
4	Gold	0.5 µm / lead free tin
7	Gold	1.0 µm



First Angle  
Projection

Dimensions are shown: Inch (mm)  
Specifications and dimensions subject to change

# RTE Series Low Profile Rotary DIP Switches

## TAPE AND REEL

Tape and reel for RTExx02Gxx  
750 pieces per reel.



Tape and reel for RTExx00Gxx  
1,250 pieces per reel.



Dimensions are shown: Inch (mm)  
Specifications and dimensions subject to change

## Данный компонент на территории Российской Федерации

### Вы можете приобрести в компании MosChip.

Для оперативного оформления запроса Вам необходимо перейти по данной ссылке:

<http://moschip.ru/get-element>

Вы можете разместить у нас заказ для любого Вашего проекта, будь то серийное производство или разработка единичного прибора.

В нашем ассортименте представлены ведущие мировые производители активных и пассивных электронных компонентов.

Нашей специализацией является поставка электронной компонентной базы двойного назначения, продукции таких производителей как XILINX, Intel (ex.ALTERA), Vicor, Microchip, Texas Instruments, Analog Devices, Mini-Circuits, Amphenol, Glenair.

Сотрудничество с глобальными дистрибьюторами электронных компонентов, предоставляет возможность заказывать и получать с международных складов практически любой перечень компонентов в оптимальные для Вас сроки.

На всех этапах разработки и производства наши партнеры могут получить квалифицированную поддержку опытных инженеров.

Система менеджмента качества компании отвечает требованиям в соответствии с ГОСТ Р ИСО 9001, ГОСТ РВ 0015-002 и ЭС РД 009

### Офис по работе с юридическими лицами:

105318, г.Москва, ул.Щербаковская д.3, офис 1107, 1118, ДЦ «Щербаковский»

Телефон: +7 495 668-12-70 (многоканальный)

Факс: +7 495 668-12-70 (доб.304)

E-mail: [info@moschip.ru](mailto:info@moschip.ru)

Skype отдела продаж:

moschip.ru

moschip.ru\_4

moschip.ru\_6

moschip.ru\_9