

CONXALL®

A SWITCHCRAFT COMPANY



HDMI WEATHERTIGHT CONNECTORS

NPB | C714

HDMI WEATHERTIGHT CONNECTORS

NPB | C714



FEATURES & BENEFITS

- Sealed to IP67 & IP68 NEMA 250 (6P)
(when panel connector is rear mounted
and mated to the cable)
- Feed-thru termination on the panel for
easy field installation
- Easy to assemble
- Quick connect bayonet or threaded
style interface
- RoHS Compliant - UV F1 rated housing

APPLICATIONS

- Data transmission
- Military or industrial
GPS location devices
- Instrumentation
- Medical data carts
- Data acquisition units
- General industrial applications

HDMI WEATHERTIGHT CONNECTORS

NPB | C714

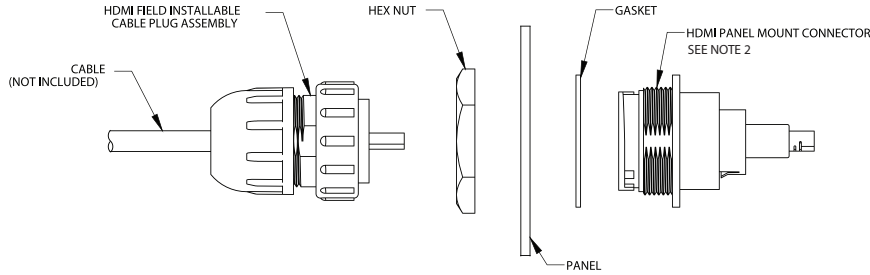

INDUSTRIAL HDMI CABLE PLUG
 QUICK CONNECT COUPLING
 (DCC-HDMIB-310 SHOWN)

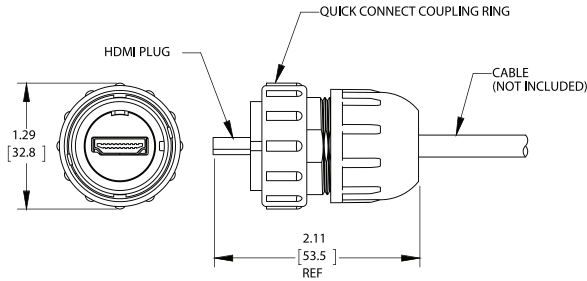

INDUSTRIAL HDMI CABLE PLUG
 THREADED COUPLING
 (DCC-HDMIT-310 SHOWN)

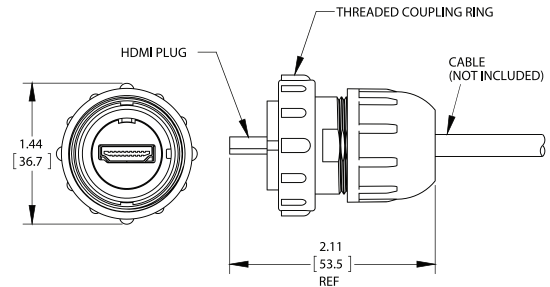

DCP-HDMIB-F SHOWN
 (HDMI FEED-THRU CONNECTOR WITH QUICK-CONNECT COUPLING)

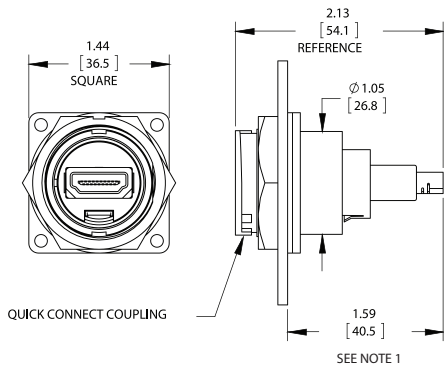

DCP-HDMIT-F SHOWN
 (HDMI FEED-THRU CONNECTOR WITH THREADED COUPLING)

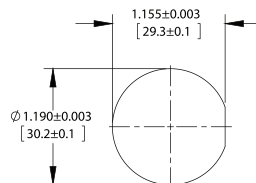
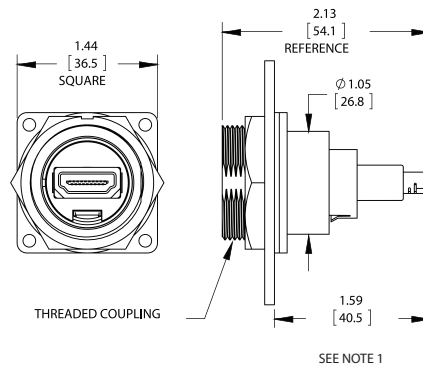

RECOMMENDED PANEL CUT-OUT
 QUICK CONNECT COUPLING
 OR THREADED COUPLING

NOTE 1: THE DIMENSION DOES NOT INCLUDE GASKET COMPRESSION.

NOTE 2: THE PANEL CONNECTOR MEETS IP67 & IP68, NEMA 250 (6P) WHEN CONNECTOR IS REAR MOUNTED USING THE HEX NUT.

UNITS ARE LISTED IN INCHES [mm]. ALL DIMENSIONS ARE REFERENCE ONLY.

PLEASE VISIT WWW.CONXALL.COM FOR THE MOST UP-TO-DATE PRODUCT SPECIFICATIONS.

HDMI WEATHERTIGHT CONNECTORS

NPB | C714

DCP-HDMIB-SC SHOWN
(HDMI CONNECTOR TO PCB HOLES WITH QUICK-CONNECT COUPLING)

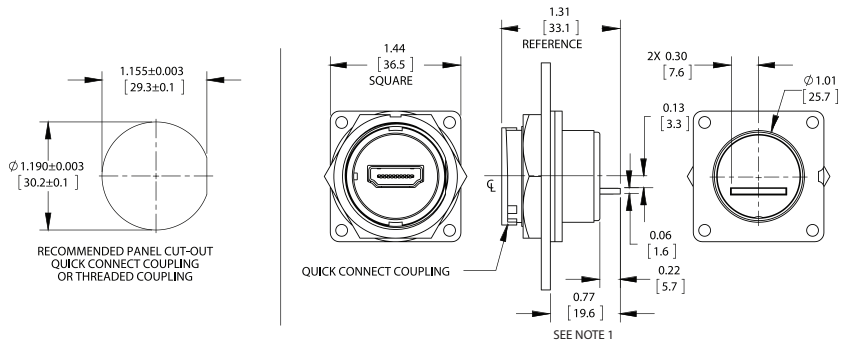

DCP-HDMIT-SC SHOWN
(HDMI CONNECTOR TO PCB HOLES WITH THREADED COUPLING)

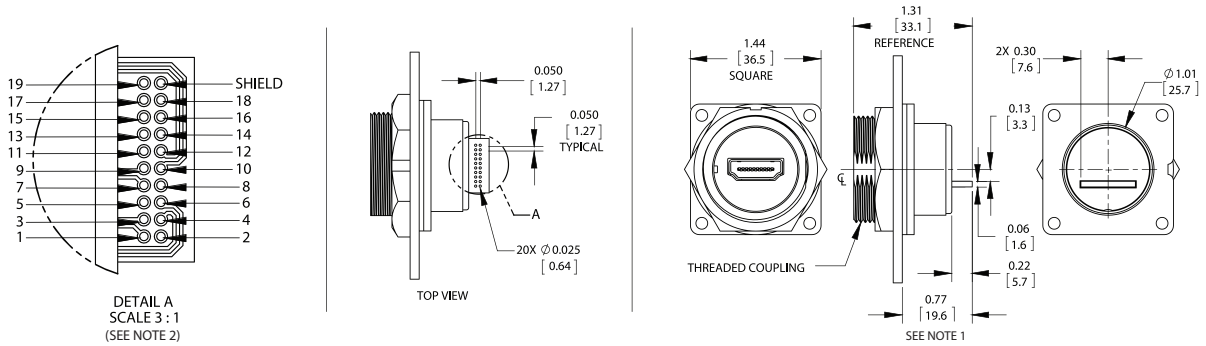

DCP-HDMIB-HD SHOWN
(HDMI CONNECTOR TO HEADER WITH QUICK-CONNECT COUPLING)

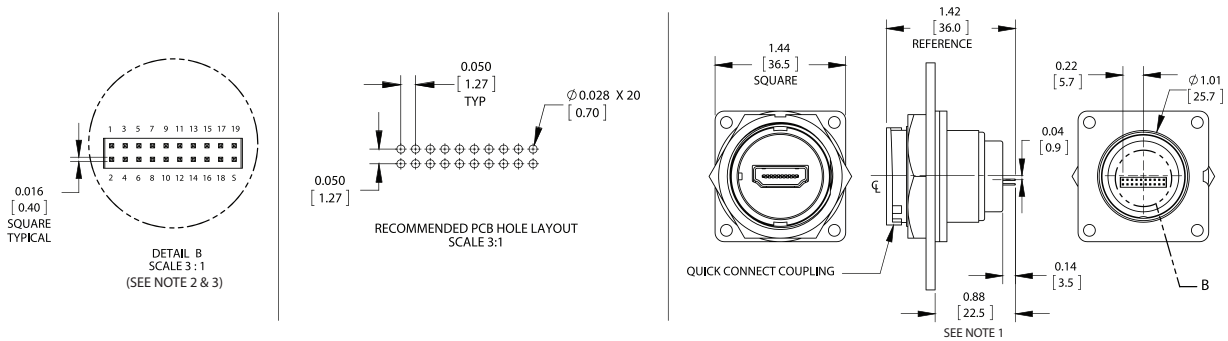

DCP-HDMIT-HD SHOWN
(HDMI CONNECTOR TO HEADER WITH THREADED COUPLING)

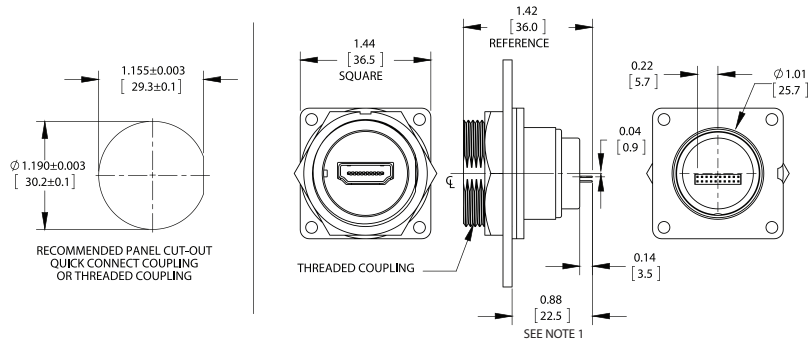

NOTE 1: THE DIMENSION DOES NOT INCLUDE GASKET COMPRESSION. NOTE 2: THE PINOUT IS TYPICAL FOR THREADED OR QUICK CONNECT COUPLING.
NOTE 3: THE NUMBERS ARE FOR REFERENCE ONLY AND DO NOT APPEAR ON THE PART.
UNITS ARE LISTED IN INCHES [mm]. ALL DIMENSIONS ARE REFERENCE ONLY.

PLEASE VISIT WWW.CONXALL.COM FOR THE MOST UP-TO-DATE PRODUCT SPECIFICATIONS.

HDMI WEATHERTIGHT CONNECTORS

NPB | C714

SPECIFICATIONS

MECHANICAL SPECIFICATIONS

Life:	Minimum 350 insertion/withdrawal cycles
Hex Nut Torque:	10-12 in-lb max
Coupling Locking Style:	Quick Connect (Bayonet) or Threaded
Backshell Style:	Threaded Nut-Squeezed Grommet

ELECTRICAL SPECIFICATIONS

Current Rating:	0.5 A
Contact Resistance:	50 mΩ max
Insulation Resistance:	10 MΩ min (mated)
Dielectric Withstanding Voltage:	300 V AC/one minute (mated)

ENVIRONMENTAL SPECIFICATIONS

Temperature Rating:	-20 °C to +80 °C (-4°F to +176°F)
Moisture Resistance:	Mil-Std 202G Method 106G
Insulation Resistance:	Mil-Std 202G Method 302
Vibration:	Mil-Std 202G Method 201A
Thermal Shock:	Mil-Std 202G Method 107G
Weathertight:	IP67 & IP68, NEMA 250 (6P) (when rear mounted & mated)
Salt Atmosphere (Corrosion):	Mil-Std 202G Method 101E

MATERIAL SPECIFICATIONS

Plug Nut, Coupling Ring:	Thermoplastic
Plug Housing, Insert:	Thermoplastic
Sealing Ring, O-Ring:	Elastomer
Panel Housing, Hex Nut:	Thermoplastic
Gasket:	Elastomer

HDMI Plug:

Shell:	Copper Alloy, Nickel Plated
Contacts:	Copper Alloy, Gold Plated over Nickel
Insulator:	Thermoplastic
PCB:	FR-4

HDMI Feed-Thru Receptacle:

Shell:	Copper Alloy, Nickel Plated
Contacts:	Copper Alloy, Gold Plated
Insulator:	Thermoplastic

HDMI PCB Receptacle:

Shell:	Copper Alloy, Tin Plated
Contacts:	Copper Alloy, Selective Gold Plated
Insulator:	Thermoplastic

MOLDED CABLE ASSEMBLIES

Consult factory for molded options

OTHER

Flame Rating:	UL 94V-0
Recommended Panel Thickness:	1/32" - 3/16" [0.8mm to 4.8mm] - Quick Connect Coupling 1/32" - 5/32" [0.8mm to 3.9mm] - Threaded Coupling

Recommended Cable Type

Cable Type:	HDMI High Speed
Outer Cable O.D. Range:	0.197"-0.236" [5.0mm-6.0mm]

HDMI WEATHERTIGHT CONNECTORS

NPB | C714

PART NUMBERS

INDUSTRIAL HDMI PLUG - FIELD INSTALLABLE

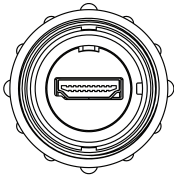

PART NUMBER	COUPLING TYPE
DCC-HDMIB-310	QUICK CONNECT
DCC-HDMIT-310	THREADED

HDMI PANEL CONNECTOR - FEED-THRU

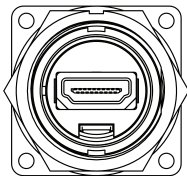

PART NUMBER	COUPLING TYPE	DESCRIPTION
DCP-HDMIB-F	QUICK CONNECT	HDMI FEED-THRU PANEL CONNECTOR
DCP-HDMIT-F	THREADED	HDMI FEED-THRU PANEL CONNECTOR

HDMI PANEL CONNECTOR - HDMI TO HEADER

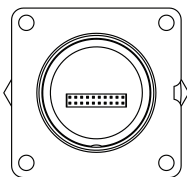

PART NUMBER	COUPLING TYPE	DESCRIPTION
DCP-HDMIB-HD	QUICK CONNECT	HDMI CONNECTOR TO 20 PIN HEADER
DCP-HDMIT-HD	THREADED	HDMI CONNECTOR TO 20 PIN HEADER

HDMI PANEL CONNECTOR - HDMI TO PCB HOLES

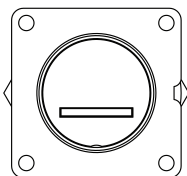

PART NUMBER	COUPLING TYPE	DESCRIPTION
DCP-HDMIB-SC	QUICK CONNECT	HDMI CONNECTOR TO PCB HOLES
DCP-HDMIT-SC	THREADED	HDMI CONNECTOR TO PCB HOLES

Данный компонент на территории Российской Федерации

Вы можете приобрести в компании MosChip.

Для оперативного оформления запроса Вам необходимо перейти по данной ссылке:

<http://moschip.ru/get-element>

Вы можете разместить у нас заказ для любого Вашего проекта, будь то серийное производство или разработка единичного прибора.

В нашем ассортименте представлены ведущие мировые производители активных и пассивных электронных компонентов.

Нашей специализацией является поставка электронной компонентной базы двойного назначения, продукции таких производителей как XILINX, Intel (ex.ALTERA), Vicor, Microchip, Texas Instruments, Analog Devices, Mini-Circuits, Amphenol, Glenair.

Сотрудничество с глобальными дистрибьюторами электронных компонентов, предоставляет возможность заказывать и получать с международных складов практически любой перечень компонентов в оптимальные для Вас сроки.

На всех этапах разработки и производства наши партнеры могут получить квалифицированную поддержку опытных инженеров.

Система менеджмента качества компании отвечает требованиям в соответствии с ГОСТ Р ИСО 9001, ГОСТ РВ 0015-002 и ЭС РД 009

Офис по работе с юридическими лицами:

105318, г.Москва, ул.Щербаковская д.3, офис 1107, 1118, ДЦ «Щербаковский»

Телефон: +7 495 668-12-70 (многоканальный)

Факс: +7 495 668-12-70 (доб.304)

E-mail: info@moschip.ru

Skype отдела продаж:

moschip.ru

moschip.ru_4

moschip.ru_6

moschip.ru_9