

## Industry First Low Capacitance ESD Protection Arrays with Backdrive Protection

### Product Description

The CM1223 family of diode arrays has been designed to provide ESD protection for electronic components or subsystems requiring minimal capacitive loading. These devices are ideal for protecting systems with high data and clock rates or for circuits requiring low capacitive loading. Each ESD channel consists of a pair of diodes in series, which steer the positive or negative ESD current pulse to either the positive ( $V_P$ ) or negative ( $V_N$ ) supply rail. A Zener diode is embedded between  $V_P$  and  $V_N$ , to absorb positive ESD strikes and provide ESD protection for the  $V_P$  rail. An additional diode is integrated to serve as backdrive current protection. The CM1223 protects against ESD pulses up to  $\pm 8$  kV per the IEC 61000-4-2 standard. In addition, all pins are protected from contact discharges of greater than  $\pm 15$  kV as outlined by the MIL-STD-883D (Method 3015) specification for Human Body Model (HBM) ESD.

These devices are particularly well-suited for protecting systems using high-speed ports such as USB2.0, IEEE1394 (Firewire<sup>®</sup>, iLink<sup>™</sup>), serial ATA, DVI, HDMI and corresponding ports in removable storage, digital camcorders, DVD-RW drives, as well as other applications where extremely low loading capacitance with ESD protection are required in a small package footprint.

### Features

- Two, Four, and Eight Channels of ESD Protection with Integrated Backdrive Protection on all Lines
- Provides ESD Protection to IEC61000-4-2 Level 4:  $\pm 8$  kV Contact Discharge &  $\pm 15$  kV Air Discharge
- Low Channel Input Capacitance of 1.0 pF (typical)
- Minimal Capacitance Change with Temperature and Voltage
- Channel I/O to GND Capacitance Difference of 0.02 pF Typical is Ideal for Differential Signals
- Mutual Capacitance between Signal Pin and Adjacent Signal Pin at 0.11 pF (typical)
- Zener Diode Protects Supply Rail and Eliminates the Need for External Bypass Capacitors
- Pin Compatible with CM1213-02, -04, and -08
- Each I/O Pin Can Withstand over 1000 ESD Strikes
- Available in SOT, and MSOP Packages
- These Devices are Pb-Free and are RoHS Compliant

### Applications

- USB 2.0 Ports at 480 Mbps in Desktop PCs, Notebooks and Peripherals
- IEEE1394 Firewire<sup>®</sup> Ports at 400 Mbps / 800 Mbps
- DVI Ports, HDMI Ports in Notebooks, Set Top Boxes, Digital TVs, LCD Displays



ON Semiconductor<sup>®</sup>

<http://onsemi.com>



SOT23-5  
SO SUFFIX  
CASE 527AH



SOT23-6  
SO SUFFIX  
CASE 527AJ

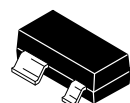

SOT-143  
SR SUFFIX  
CASE 318A

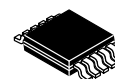

MSOP 10  
MR SUFFIX  
CASE 846AE

### BLOCK DIAGRAM

(see page 2)

### MARKING DIAGRAM

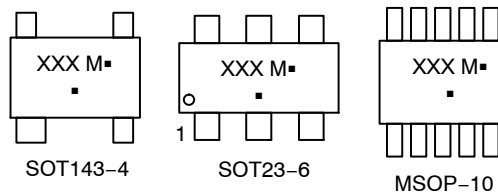

XXX = Specific Device Code  
M = Date Code  
▪ = Pb-Free Package  
(Note: Microdot may be in either location)

### ORDERING INFORMATION

Device	Package	Shipping
CM1223-02SO	SOT23-5 (Pb-Free)	3000/Tape & Reel
CM1223-02SR	SOT143-4 (Pb-Free)	3000/Tape & Reel
CM1223-04SO	SOT23-6 (Pb-Free)	3000/Tape & Reel
CM1223-04MR	MSOP-10 (Pb-Free)	4000/Tape & Reel
CM1223-08MR	MSOP-10 (Pb-Free)	4000/Tape & Reel

†For information on tape and reel specifications, including part orientation and tape sizes, please refer to our Tape and Reel Packaging Specification Brochure, BRD8011/D.

- UDI and Display Ports
- Serial ATA Ports in Desktop PCs and Hard Disk Drives
- PCI Express Ports
- General Purpose High-speed Data Line ESD Protection

# CM1223

## BLOCK DIAGRAM

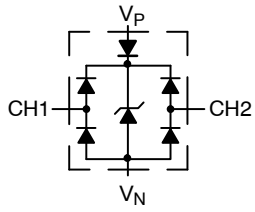

CM1223-02SO  
CM1223-02SR

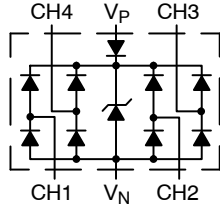

CM1223-04SO  
CM1223-04MR

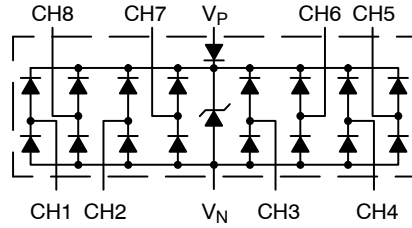

CM1223-08MR

Table 1. PIN DESCRIPTIONS

2-Channel, 5-Lead SOT23-5 Package			
Pin	Name	Type	Description
1	NC		No Connect
2	V <sub>N</sub>	GND	Negative voltage supply rail
3	CH1	I/O	ESD Channel
4	CH2	I/O	ESD Channel
5	V <sub>P</sub>	PWR	Positive voltage supply rail

2-Channel, 4-Lead SOT143-4 Package			
Pin	Name	Type	Description
1	V <sub>N</sub>	GND	Negative voltage supply rail
2	CH1	I/O	ESD Channel
3	CH2	I/O	ESD Channel
4	V <sub>P</sub>	PWR	Positive voltage supply rail

4-Channel, 6-Lead SOT23-6 Package			
Pin	Name	Type	Description
1	CH1	I/O	ESD Channel
2	V <sub>N</sub>	GND	Negative voltage supply rail
3	CH2	I/O	ESD Channel
4	CH3	I/O	ESD Channel
5	V <sub>P</sub>	PWR	Positive voltage supply rail
6	CH4	I/O	ESD Channel

4-Channel, 10-Lead MSOP-10 Package			
Pin	Name	Type	Description
1	CH1	I/O	ESD Channel
2	NC		No Connect
3	V <sub>P</sub>	PWR	Positive voltage supply rail
4	CH2	I/O	ESD Channel
5	NC		No Connect
6	CH3	I/O	ESD Channel
7	NC		No Connect
8	V <sub>N</sub>	GND	Negative voltage supply rail
9	CH4	I/O	ESD Channel
10	NC		No Connect

8-Channel, 10-Lead MSOP-10 Package			
Pin	Name	Type	Description
1	CH1	I/O	ESD Channel
2	CH2	I/O	ESD Channel
3	CH3	I/O	ESD Channel
4	CH4	I/O	ESD Channel
5	V <sub>N</sub>	GND	Negative voltage supply rail
6	CH5	I/O	ESD Channel
7	CH6	I/O	ESD Channel
8	V <sub>P</sub>	PWR	Positive voltage supply rail
9	CH7	I/O	ESD Channel
10	CH8	I/O	ESD Channel

PACKAGE / PINOUT DIAGRAMS

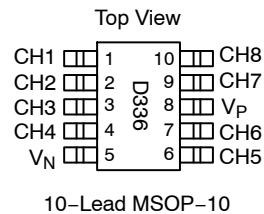
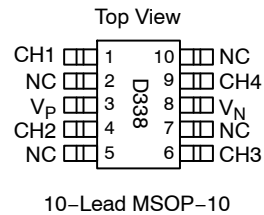
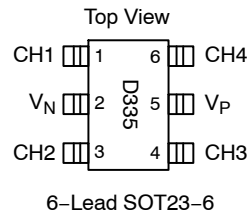
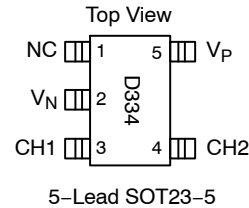
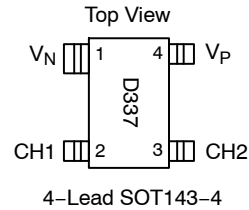

# CM1223

## SPECIFICATIONS

**Table 2. ABSOLUTE MAXIMUM RATINGS**

Parameter	Rating	Units
Operating Supply Voltage ( $V_P - V_N$ )	6.0	V
Operating Temperature Range	-40 to +85	°C
Storage Temperature Range	-65 to +150	°C
DC Voltage at any channel input	$(V_N - 0.5)$ to $(V_P + 0.5)$	V

Stresses exceeding Maximum Ratings may damage the device. Maximum Ratings are stress ratings only. Functional operation above the Recommended Operating Conditions is not implied. Extended exposure to stresses above the Recommended Operating Conditions may affect device reliability.

**Table 3. STANDARD OPERATING CONDITIONS**

Parameter	Rating	Units
Operating Temperature Range	-40 to +85	°C
Package Power Rating SOT143-4 Package (CM1223-02SR) SOT23-5 Package (CM1223-02SO) SOT23-6 Package (CM1223-04SO) MSOP-10 Package (CM1223-04MR) MSOP-10 Package (CM1223-08MR)	225 225 225 400 400	mW

**Table 4. ELECTRICAL OPERATING CHARACTERISTICS (Note1)**

Symbol	Parameter	Conditions	Min	Typ	Max	Units
$V_P$	Operating Supply Voltage ( $V_P - V_N$ )			3.3	5.5	V
$I_P$	Operating Supply Current	$(V_P - V_N) = 3.3$ V			8.0	μA
$V_{SCL}$	Signal Clamp Voltage Positive Transients Negative Transients	$I_F = 8$ mA; $T_A = 25^\circ\text{C}$	6.7 0.60	8.2 0.80		V
$I_{LEAK}$	Channel Leakage Current	$T_A = 25^\circ\text{C}$ ; $V_P = 5$ V, $V_N = 0$ V		±0.1	±1.0	μA
$C_{IN}$	Channel Input Capacitance	At 1 MHz, $V_P = 3.3$ V, $V_N = 0$ V, $V_{IN} = 1.65$ V		1.0	1.5	pF
$\Delta C_{IN}$	Channel Input Capacitance Matching	At 1 MHz, $V_P = 3.3$ V, $V_N = 0$ V, $V_{IN} = 1.65$ V		0.02		pF
$C_{MUTUAL}$	Mutual Capacitance between signal pin and adjacent signal pin	At 1 MHz, $V_P = 3.3$ V, $V_N = 0$ V, $V_{IN} = 1.65$ V		0.11		pF
$V_{ESD}$	ESD Protection – Peak Discharge Voltage at any channel input, in system a) Contact discharge per IEC 61000-4-2 standard b) Human Body Model, MIL-STD-883, Method 3015	$T_A = 25^\circ\text{C}$ ; (Notes 3 and 4) $T_A = 25^\circ\text{C}$ ; (Notes 2 and 4)		±8 ±15		kV
$V_{CL}$	Channel Clamp Voltage Positive Transients Negative Transients	$T_A = 25^\circ\text{C}$ , $I_{PP} = 1$ A, $t_P = 8/20$ μS (Note 4)		+8.8 -1.4		V
$R_{DYN}$	Dynamic Resistance Positive Transients Negative Transients	$T_A = 25^\circ\text{C}$ , $I_{PP} = 1$ A, $t_P = 8/20$ μS Any I/O pin to Ground (Note 4)		0.7 0.4		Ω

1. All parameters specified at  $T_A = -40^\circ\text{C}$  to  $+85^\circ\text{C}$  unless otherwise noted.
2. Human Body Model per MIL-STD-883, Method 3015,  $C_{Discharge} = 100$  pF,  $R_{Discharge} = 1.5$  kΩ,  $V_P = 3.3$  V,  $V_N$  grounded.
3. Standard IEC 61000-4-2 with  $C_{Discharge} = 150$  pF,  $R_{Discharge} = 330$  Ω,  $V_P = 3.3$  V,  $V_N$  grounded.
4. These measurements performed with no external capacitor on  $V_P$  ( $V_P$  floating).

PERFORMANCE INFORMATION

Input Channel Capacitance Performance Curves

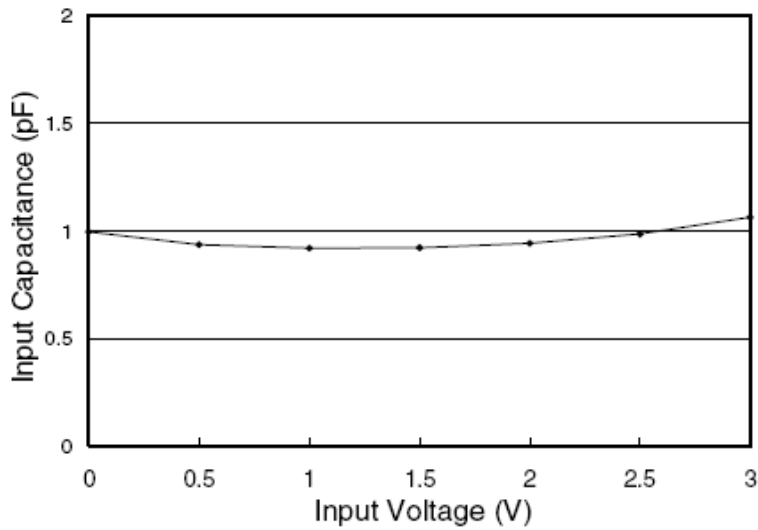

Typical Variation of  $C_{IN}$  vs.  $V_{IN}$

( $f=1\text{MHz}$ ,  $V_P = 3.3\text{V}$ ,  $V_N = 0\text{V}$ ,  $0.1 \mu\text{F}$  chip capacitor between  $V_P$  and  $V_N$ ,  $25^\circ\text{C}$ )

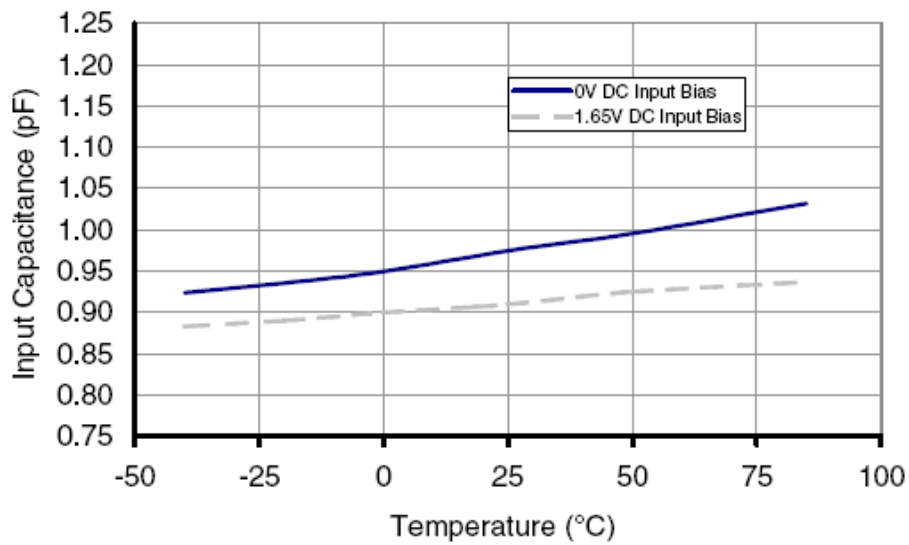

Typical Variation of  $C_{IN}$  vs. Temp

( $f=1\text{MHz}$ ,  $V_{IN}=30\text{mV}$ ,  $V_P = 3.3\text{V}$ ,  $V_N = 0\text{V}$ ,  $0.1 \mu\text{F}$  chip capacitor between  $V_P$  and  $V_N$ )

# CM1223

## PERFORMANCE INFORMATION (Cont'd)

Typical Filter Performance (nominal conditions unless specified otherwise, 50 Ohm Environment)

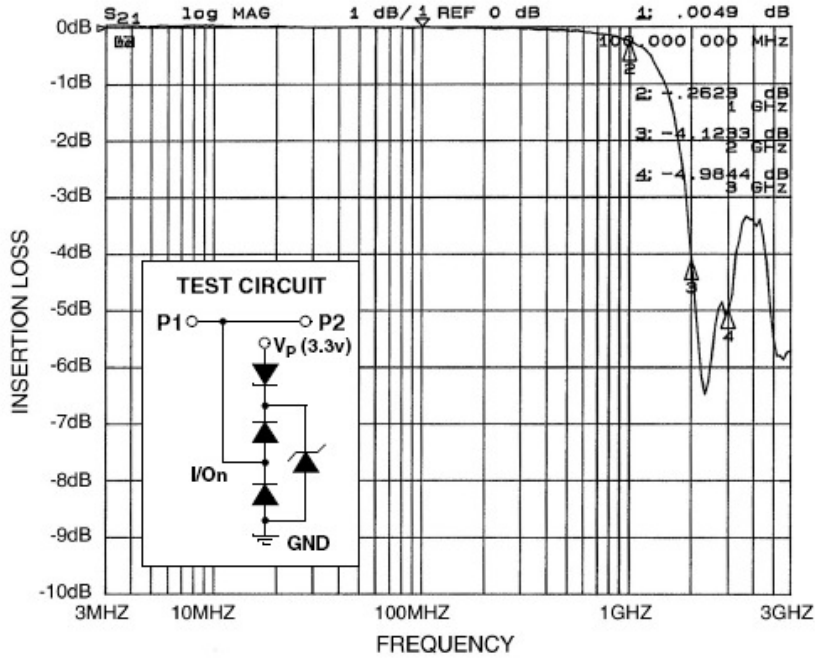

Figure 1. Insertion Loss (S21) vs. Frequency (0 V DC Bias,  $V_p=3.3$  V, MSOP-10 Package)

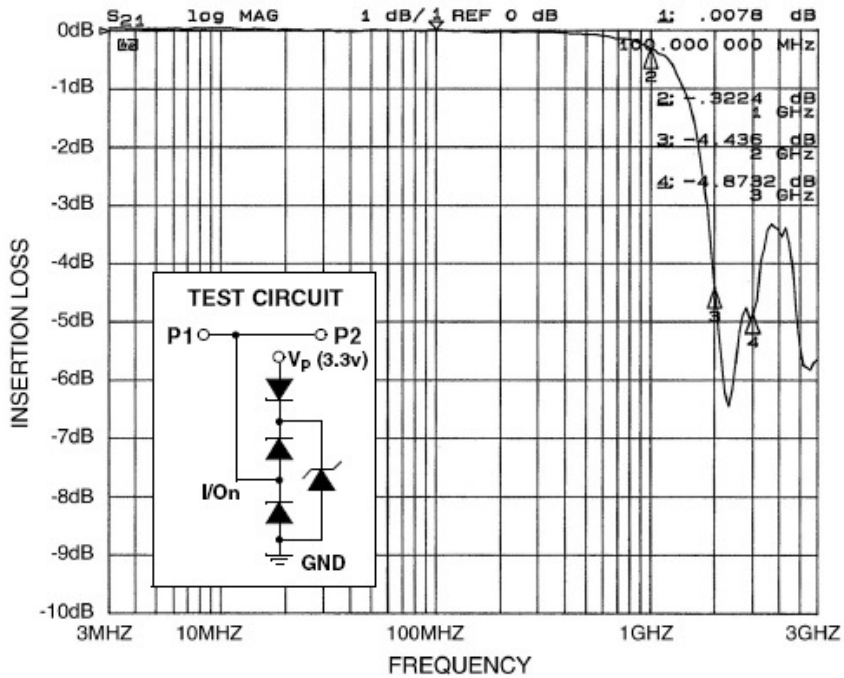

Figure 2. Insertion Loss (S21) vs. Frequency (2.5 V DC Bias,  $V_p=3.3$  V, MSOP-10 Package)

## BACKDRIVE PROTECTION

Backdrive protection is needed to block against backdrive current flowing from a high potential voltage node toward a lower potential voltage node through the interface cable.

For example, consider a DVD player connected to a TV via an HDMI interface. If the DVD player is switched off and the TV is left on, there is a possibility of reverse current flow back into the main power supply rail of the DVD player. Typically, the DVD's power supply has some form of associated bulk supply capacitance, and it is possible over time to charge that bulk supply capacitance to some intermediate level.

If that level rises above the power-on-reset (POR) voltage level of some of the integrated circuits, the DVD player may not reset properly when the DVD player is turned back on. This is largely because all CMOS logic exhibits a very high impedance on the power rail node even when "off".

To avoid this situation, the CM1223 with integrated backdrive protection diode was designed to block backdrive current, guaranteeing no more than 5  $\mu$ A on any I/O pin when the I/O pin voltage is greater than the CM1223 supply voltage.

## APPLICATION INFORMATION

### Design Considerations

To realize the maximum protection against ESD pulses, care must be taken in the PCB layout to minimize parasitic series inductances on the Supply/Ground rails as well as the signal trace segments between the signal input (typically a connector) and the ESD protection device. Application of Positive ESD Pulse between Input Channel and Ground illustrates an example of a positive 8 kV ESD pulse striking an input channel. The 8 kV ESD current pulse will divert along the path as indicated in Application of Positive ESD Pulse between Input Channel and Ground, through the D1 diode and the Zener diode back to the ground rail.

An ESD current pulse can rise from zero to its peak value in a very short time. For example, a level 4 contact discharge per the IEC61000-4-2 standard results in a current pulse that rises from zero to 30 Amps in 1ns. The CM1223 has a fast response time of less than 1ns and low clamp voltage to handle this pulse scenario.

Similarly for negative ESD pulses, parasitic series inductance from the  $V_N$  pin to the ground rail will lead to drastically increased negative voltage on the line being protected.

The CM1223 also has an integrated backdrive diode between  $V_P$  and  $V_N$  to prevent backdrive current flow from the powered sources.

As a general rule, the ESD Protection Array should be located as close as possible to the point of entry of expected electrostatic discharges.

ADDITIONAL INFORMATION

See also ON Semiconductor Application Note “Design Considerations for ESD Protection”, in the Applications section.

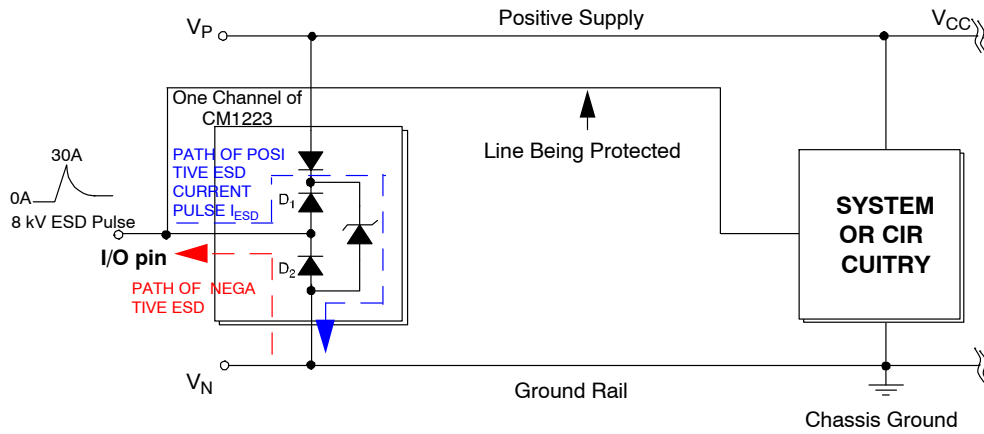

Figure 3. Application of Positive ESD Pulse between Input Channel and Ground

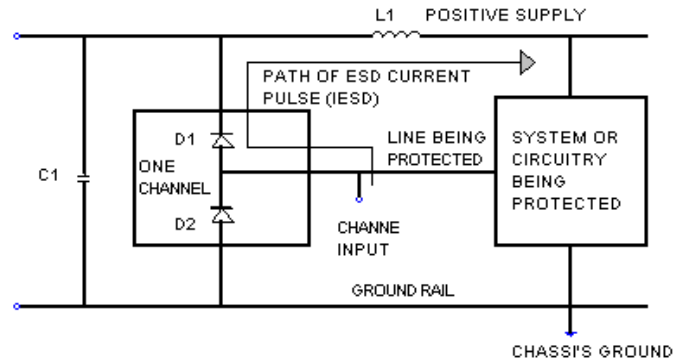

Figure 4. Application of Positive ESD Pulse between Input Channel and Ground



# CM1223

## MECHANICAL DETAILS

The CM1223 is available in SOT143-4, SOT23-5, SOT23-6, and MSOP-10 packages with a lead-free finishing. The various package drawings are presented below.

### SOT143 Mechanical Specifications

The CM1223-02SR is supplied in 4-pin SOT143 package, the CM1223-02SO in a 5-pin SOT23 package, the CM1223-04SO in a 6-pin SOT23 package, and the CM1223-08MR in a 10-lead MSOP package. Dimensions are presented below.

**Table 5. TAPE AND REEL SPECIFICATIONS**

Part Number	Chip Size (mm)	Pocket Size (mm) $B_0 \times A_0 \times K_0$	Tape Width W	Reel Diameter	Qty per Reel	$P_0$	$P_1$
CM1223-02SR	2.92 X 2.37 X 1.01	2.60 X 3.15 X 1.20	8 mm	178 mm (7")	3000	4 mm	4 mm
CM1223-02SO	2.90 X 2.80 X 1.45	3.20 X 3.20 X 1.40	8 mm	178 mm (7")	3000	4 mm	4 mm
CM1223-04SO	2.90 X 2.80 X 1.45	3.20 X 3.20 X 1.40	8 mm	178 mm (7")	3000	4 mm	4 mm
CM1223-08MR	3.00 X 3.00 X 0.85	3.30 X 5.30 X 1.30	12 mm	330 mm (13")	4000	4 mm	8 mm

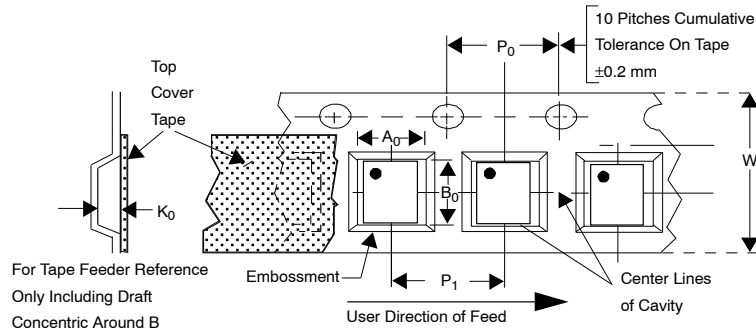

# CM1223

## PACKAGE DIMENSIONS

SOT-143  
CASE 318A-06  
ISSUE U

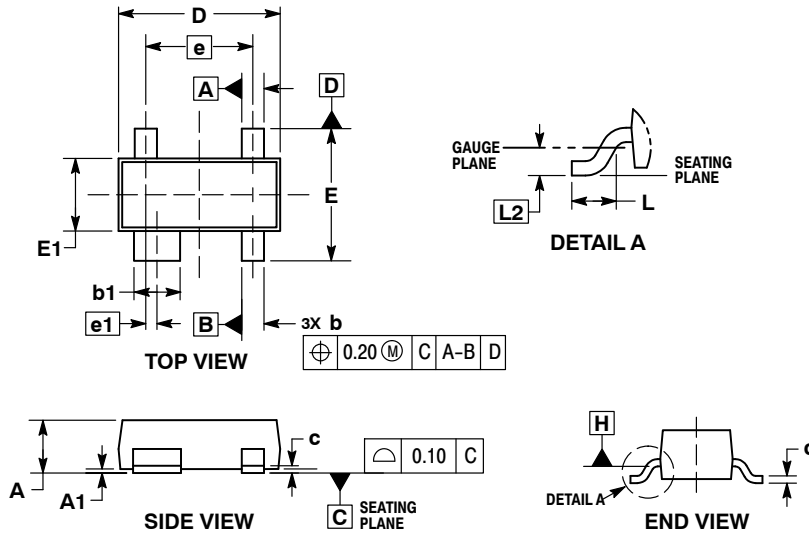

- NOTES:
1. DIMENSIONING AND TOLERANCING PER ASME Y14.5M, 1994.
  2. CONTROLLING DIMENSION: MILLIMETERS.
  3. MAXIMUM LEAD THICKNESS INCLUDES LEAD FINISH. MINIMUM LEAD THICKNESS IS THE MINIMUM THICKNESS OF BASE MATERIAL.
  4. DIMENSIONS D AND E DO NOT INCLUDE MOLD FLASH, PROTRUSIONS, OR GATE BURRS. MOLD FLASH, PROTRUSIONS, AND GATE BURRS SHALL NOT EXCEED 0.25 PER SIDE. DIMENSION E1 DOES NOT INCLUDE INTERLEAD FLASH OR PROTRUSION. INTERLEAD FLASH AND PROTRUSION SHALL NOT EXCEED 0.25 PER SIDE.
  5. DIMENSIONS D AND E1 ARE DETERMINED AT DATUM H.
  6. DATUMS A AND B ARE DETERMINED AT DATUM H.

MILLIMETERS		
DIM	MIN	MAX
A	0.80	1.12
A1	0.01	0.15
b	0.30	0.51
b1	0.76	0.94
c	0.08	0.20
D	2.80	3.05
E	2.10	2.64
E1	1.20	1.40
e	1.92 BSC	
e1	0.20 BSC	
L	0.35	0.70
L2	0.25 BSC	

### RECOMMENDED SOLDERING FOOTPRINT\*

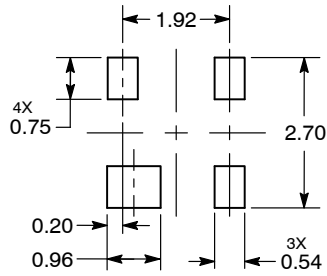

DIMENSIONS: MILLIMETERS

\*For additional information on our Pb-Free strategy and soldering details, please download the ON Semiconductor Soldering and Mounting Techniques Reference Manual, SOLDERRM/D.

# CM1223

## PACKAGE DIMENSIONS

SOT-23, 5 Lead  
CASE 527AH-01  
ISSUE O

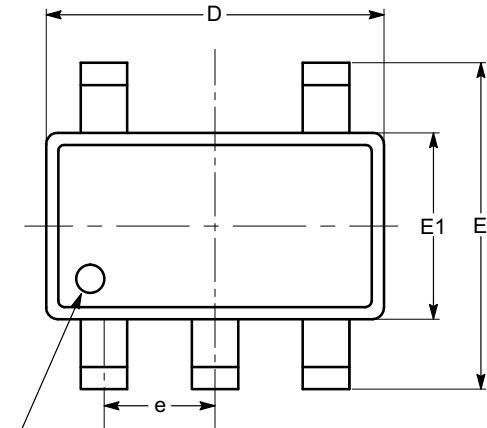

PIN #1 IDENTIFICATION

TOP VIEW

SYMBOL	MIN	NOM	MAX
A	0.90		1.45
A1	0.00		0.15
A2	0.90	1.15	1.30
b	0.30		0.50
c	0.08		0.22
D	2.90 BSC		
E	2.80 BSC		
E1	1.60 BSC		
e	0.95 BSC		
L	0.30	0.45	0.60
L1	0.60 REF		
L2	0.25 REF		
$\theta$	0°	4°	8°
$\theta 1$	5°	10°	15°
$\theta 2$	5°	10°	15°

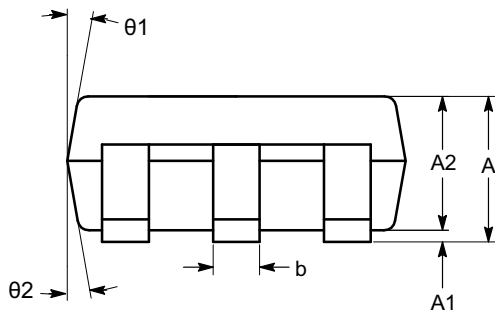

SIDE VIEW

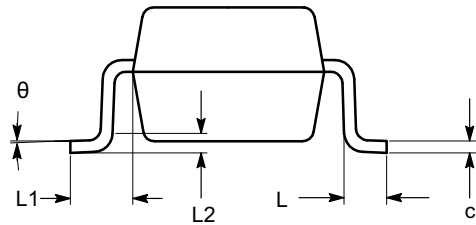

END VIEW

**Notes:**

- (1) All dimensions in millimeters. Angles in degrees.
- (2) Complies with JEDEC standard MO-178.

# CM1223

## PACKAGE DIMENSIONS

SOT-23, 6 Lead  
CASE 527AJ  
ISSUE B

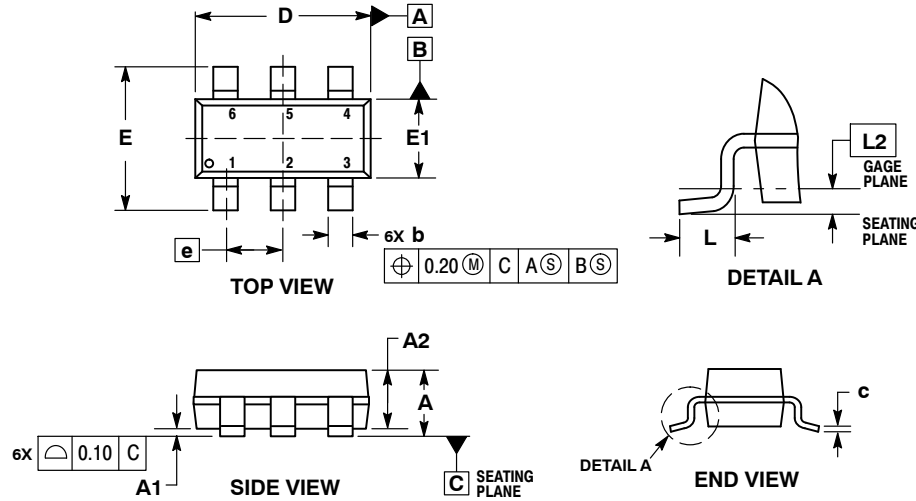

- NOTES:
1. DIMENSIONING AND TOLERANCING PER ASME Y14.5M, 1994.
  2. CONTROLLING DIMENSION: MILLIMETERS.
  3. DATUM C IS THE SEATING PLANE.

MILLIMETERS		
DIM	MIN	MAX
A	---	1.45
A1	0.00	0.15
A2	0.90	1.30
b	0.20	0.50
c	0.08	0.26
D	2.70	3.00
E	2.50	3.10
E1	1.30	1.80
e	0.95 BSC	
L	0.20	0.60
L2	0.25 BSC	

### RECOMMENDED SOLDERING FOOTPRINT\*

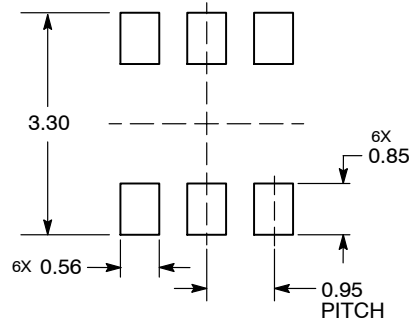

DIMENSIONS: MILLIMETERS

\*For additional information on our Pb-Free strategy and soldering details, please download the ON Semiconductor Soldering and Mounting Techniques Reference Manual, SOLDERRM/D.

# CM1223

## PACKAGE DIMENSIONS

MSOP 10, 3x3  
CASE 846AE-01  
ISSUE O

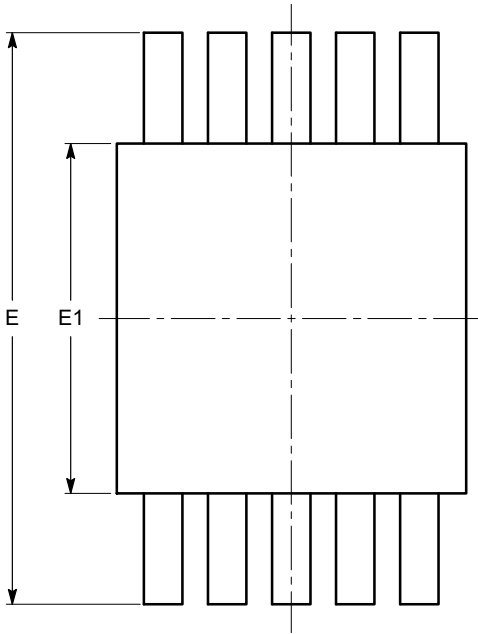

TOP VIEW

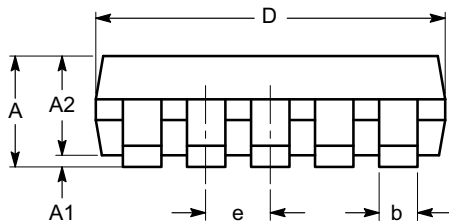

SIDE VIEW

SYMBOL	MIN	NOM	MAX
A			1.10
A1	0.00	0.05	0.15
A2	0.75	0.85	0.95
b	0.17		0.27
c	0.13		0.23
D	2.90	3.00	3.10
E	4.75	4.90	5.05
E1	2.90	3.00	3.10
e	0.50 BSC		
L	0.40	0.60	0.80
L1	0.95 REF		
L2	0.25 BSC		
$\theta$	0°		8°

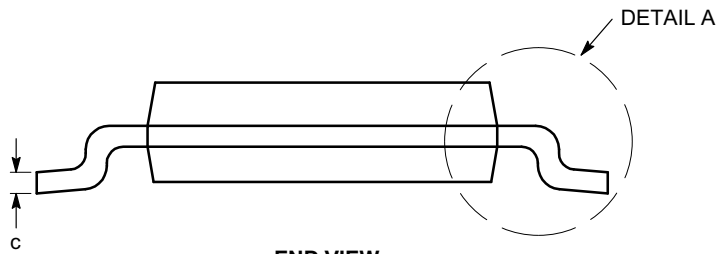

END VIEW

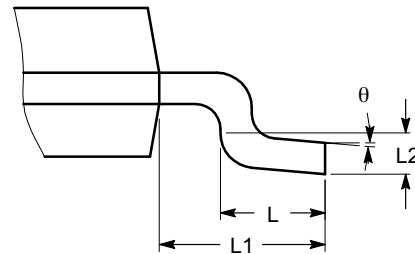

DETAIL A

**Notes:**

- (1) All dimensions are in millimeters. Angles in degrees.
- (2) Complies with JEDEC MO-187.

iLink™ is a trademark of S.J.Electro Systems, Inc.  
FireWire® is a registered trademark of Apple Computer, Inc.

**ON Semiconductor** and **ON** are registered trademarks of Semiconductor Components Industries, LLC (SCILLC). SCILLC owns the rights to a number of patents, trademarks, copyrights, trade secrets, and other intellectual property. A listing of SCILLC's product/patent coverage may be accessed at [www.onsemi.com/site/pdf/Patent-Marking.pdf](http://www.onsemi.com/site/pdf/Patent-Marking.pdf). SCILLC reserves the right to make changes without further notice to any products herein. SCILLC makes no warranty, representation or guarantee regarding the suitability of its products for any particular purpose, nor does SCILLC assume any liability arising out of the application or use of any product or circuit, and specifically disclaims any and all liability, including without limitation special, consequential or incidental damages. "Typical" parameters which may be provided in SCILLC data sheets and/or specifications can and do vary in different applications and actual performance may vary over time. All operating parameters, including "Typicals" must be validated for each customer application by customer's technical experts. SCILLC does not convey any license under its patent rights nor the rights of others. SCILLC products are not designed, intended, or authorized for use as components in systems intended for surgical implant into the body, or other applications intended to support or sustain life, or for any other application in which the failure of the SCILLC product could create a situation where personal injury or death may occur. Should Buyer purchase or use SCILLC products for any such unintended or unauthorized application, Buyer shall indemnify and hold SCILLC and its officers, employees, subsidiaries, affiliates, and distributors harmless against all claims, costs, damages, and expenses, and reasonable attorney fees arising out of, directly or indirectly, any claim of personal injury or death associated with such unintended or unauthorized use, even if such claim alleges that SCILLC was negligent regarding the design or manufacture of the part. SCILLC is an Equal Opportunity/Affirmative Action Employer. This literature is subject to all applicable copyright laws and is not for resale in any manner.

**PUBLICATION ORDERING INFORMATION**

**LITERATURE FULFILLMENT:**  
Literature Distribution Center for ON Semiconductor  
P.O. Box 5163, Denver, Colorado 80217 USA  
**Phone:** 303-675-2175 or 800-344-3860 Toll Free USA/Canada  
**Fax:** 303-675-2176 or 800-344-3867 Toll Free USA/Canada  
**Email:** [orderlit@onsemi.com](mailto:orderlit@onsemi.com)

**N. American Technical Support:** 800-282-9855 Toll Free  
USA/Canada  
**Europe, Middle East and Africa Technical Support:**  
Phone: 421 33 790 2910  
**Japan Customer Focus Center**  
Phone: 81-3-5817-1050

**ON Semiconductor Website:** [www.onsemi.com](http://www.onsemi.com)  
**Order Literature:** <http://www.onsemi.com/orderlit>  
For additional information, please contact your local Sales Representative

## Данный компонент на территории Российской Федерации

### Вы можете приобрести в компании MosChip.

Для оперативного оформления запроса Вам необходимо перейти по данной ссылке:

<http://moschip.ru/get-element>

Вы можете разместить у нас заказ для любого Вашего проекта, будь то серийное производство или разработка единичного прибора.

В нашем ассортименте представлены ведущие мировые производители активных и пассивных электронных компонентов.

Нашей специализацией является поставка электронной компонентной базы двойного назначения, продукции таких производителей как XILINX, Intel (ex.ALTERA), Vicor, Microchip, Texas Instruments, Analog Devices, Mini-Circuits, Amphenol, Glenair.

Сотрудничество с глобальными дистрибьюторами электронных компонентов, предоставляет возможность заказывать и получать с международных складов практически любой перечень компонентов в оптимальные для Вас сроки.

На всех этапах разработки и производства наши партнеры могут получить квалифицированную поддержку опытных инженеров.

Система менеджмента качества компании отвечает требованиям в соответствии с ГОСТ Р ИСО 9001, ГОСТ РВ 0015-002 и ЭС РД 009

### Офис по работе с юридическими лицами:

105318, г.Москва, ул.Щербаковская д.3, офис 1107, 1118, ДЦ «Щербаковский»

Телефон: +7 495 668-12-70 (многоканальный)

Факс: +7 495 668-12-70 (доб.304)

E-mail: [info@moschip.ru](mailto:info@moschip.ru)

Skype отдела продаж:

moschip.ru

moschip.ru\_4

moschip.ru\_6

moschip.ru\_9