

# AFBR-S10EB001Z

## Evaluation Kit for the AFBR-S10TR001Z Sensor Transceiver



### Application Note 5594

#### Introduction

This application note introduces the evaluation kit AFBR-S10EB001Z, which has been designed to be used as an evaluation platform for the Sensor Transceiver AFBR-S10TR001Z. This evaluation kit provides system designers with a convenient means to evaluate the performance of the AFBR-S10TR001Z sensor transceiver.

The document describes in detail the board included in the evaluation kit and the test setups used for the evaluation of the optical and electrical characteristics of the Sensor Transceiver AFBR-S10TR001Z.

Figure 1 shows the top view of the evaluation board of AFBR-S10TR001Z.



Figure 1. Top side of the evaluation board of AFBR-S10TR001Z

#### Evaluation kit

The evaluation kit includes:

- 1x Evaluation board
- 1x 9.0V DC power supply
- 2x Jumpers
- 1x 1-meter-long AFBR-TUS500Z transparent-jacket-POF patch-chord with AFBR-4526Z duplex connector at its ends (intended for testing of evaluation board in loop configuration).
- 1x 1-meter-long transparent-jacket-POF patch-chord with AFBR-4531Z simplex connectors at its ends
- 1x VL-to-VL AFBR-4536EZ duplex bulkhead
- 2x AFBR-4526Z duplex connectors

The evaluation kit does not include:

- Flash light source \*
- Digital multimeter
- Optical power meter
- Pulse/Pattern generator
- Oscilloscope
- High-impedance probe

\* Any Xenon-based photo camera flash light source is suitable. (Unomat B24 is recommended due to it being commonly available)

## PCB Description

The most important components of the evaluation board are listed below:

- 1x AFBR-S10TR001Z module:  
This device, identified as U3, is the sensor transceiver and, therefore, it is the core of the evaluation board.
- 1x Arduino microcontroller board:  
This device, identified as M1, is the arithmetic-logic unit (ALU) of the evaluation board, where the electrical output of the receiver of AFBR-S10TR001Z is processed. After processing this electrical output, the Arduino microcontroller decides whether the received light has been generated by an arc flash event or, on the other hand, it is due either to a heartbeat sent by the transmitter of AFBR-S10TR001Z or to ambient light.
- 1x switch button:  
This switch button, identified as SW1, allows the user choosing the desired heartbeat mode. The possible options are Internal Heartbeat Mode and External Heartbeat Mode.
- 1x SMA connector:  
This connector, identified as P6, allows the user providing an external heartbeat signal to the sensor transceiver. The aim of the heartbeat signal is to periodically check the availability of the arcflash detection system, including the sensor transceiver (AFBR-S10TR001Z) and the sensor fiber (AFBR-TUS500Z).
- 2 x 3-pin headers:  
One of the 3-pin headers, identified as JP1, allows enabling/disabling a  $50\Omega$  termination, which is placed between the SMA connector previously mentioned and ground. The aim of the  $50\Omega$  termination is to provide impedance matching in case that the external heartbeat signal is supplied from an external pulse/pattern generator with this output impedance; the second 3-pin header, identified as JP2, is used to configure the operation mode of AFBR-S10EB001Z. There are two possible operation modes: Operate and Measure. These two modes of operation are described in the next section of this application note. To enable/disable the  $50\Omega$  termination by means of JP1 and/or to select Operate mode/Measure mode by means of JP2, the user has just to shortcircuit the appropriate pins of the 3-pin headers JP1 and/or JP2 by placing a jumper on them. The required jumpers are provided with the evaluation kit.

- 3 x 2-pin header:  
One of the 2-pin headers, identified as W1, allows monitoring the forward current of the transmitter of AFBR-S10TR001Z (this current is monitored through R7, as shown in the schematic depicted in Figure 8); the purpose of the second 2-pin header, identified as W2, is to monitor the threshold fixed to differentiate between the heartbeat signal or noise generated either by ambient light or by the receiver of AFBR-S10TR001Z itself; finally, the third 2-pin header, identified as W3, allows sensing the output voltage generated by the receiver. To monitor the forward current of the transmitter of AFBR-S10TR001Z, by means of the 2-pin header W1, and/or to monitor the threshold fixed to differentiate between the heartbeat signal or noise, by means of the 2-pin header W2, a digital multimeter properly connected to said 2-pin headers is needed.
- 2x potentiometer:  
One of the potentiometers, identified as RV1, allows changing the level of the threshold used by the Arduino microcontroller to distinguish between heartbeat signal and noise; the other potentiometer, identified as RV2, allows modifying the forward current through the LED of the transmitter of AFBR-S10TR001Z, which is translated into a modification of the optical power of the heartbeat signal of the system (as mentioned before, the forward current of the transmitter of AFBR-S10TR001Z may be monitored by means of the 2-pin header identified as W1). To modify the values of the potentiometers RV1 and/or RV2, the use of the appropriate screwdriver is required.

Figure 8 shows the schematic of the evaluation board supplied in the AFBR-S10EB001Z evaluation kit.

## AFBR-S10TR001Z Transmitter

The transmitter of AFBR-S10TR001Z provides the system with the capability of sending a heartbeat signal to the receiver of said device, which makes it possible to periodically auto-test the arc flash detection system. The transmitter consists of a bare LED, which is driven by an electrical current. This electrical current may be adjusted by means of the potentiometer RV2, allowing a variation in the LOP of the transmitter ranging from -1dBm (peak) to -18dBm (peak). The 2-pin header W1, which is connected in parallel to a 10Ω resistor, makes it possible to monitor the LED driving current. When the LOP of the transmitter is -1dBm, the voltage drop measured at the 2-pin header W1 is 310mV (31mA), while this voltage drop is 7mV (700μA) when the LOP of the transmitter is -18dBm.

To monitor the LOP it is necessary to connect the transmitter of AFBR-S10TR001Z to an optical power meter by means of the 1-meter-long transparent-jacket-POF patchcord with AFBR-4531Z simplex connectors supplied with the evaluation kit AFBR-S10EB001Z.

To facilitate the adjustment of the optical power launched by the transmitter of AFBR-S10TR001Z, the 3-pin header JP2 permits switching between pulsed LED driving current (Operate mode) or continuous LED driving current (Measure mode), which is translated into pulsed output light or continuous output light. Therefore, for the adjustment of the optical power launched by the transmitter, it is recommended to select Measure mode at JP2. When this mode is selected, the optical power measured at the output of the transmitter will be given in terms of peak values. Once the desired peak value is reached by tuning the potentiometer RV2, the mode selected at JP2 is changed from Measure to Operate, which will change the light generated by the LED from continuous wave (CW) to pulsed wave.

## AFBR-S10TR001Z Receiver

The receiver of AFBR-S10TR001Z consists of an ASIC which implements the functionalities of a photodetector plus a trans-impedance amplifier (TIA). The ASIC generates a voltage output whose amplitude is proportional to the power of the received light.

The evaluation board allows the user to adjust the threshold of the heartbeat signal detection. The adjustment is made through the potentiometer RV1 and allows setting a value for the output voltage of the receiver of AFBR-S10TR001Z below which the Heartbeat Loss alarm is triggered. When this alarm is triggered, the LED D1 brightens. The lower limit at which the heartbeat detection threshold

may be fixed is 30mV, while the upper limit at which this threshold may be fixed is 4V. It is important to remark that, when it comes to triggering the Heartbeat Loss alarm, the output voltage of the receiver of AFBR-S10TR001Z is evaluated only inside the time window in which the heartbeat pulse is expected; therefore, it does not matter what said output voltage is outside the mentioned time window (see Figure 2 for clarification).

In the case of the threshold used for the detection of arc flash events, it is hardcoded in the Arduino microcontroller. This threshold is 20mV, which means that if the output voltage of AFBR-S10TR001Z is above this value, the Flash Detected alarm is triggered. When this happens, the LED D2 brightens. As in the previous case, it is important to remark that, when it comes to triggering the Flash Detected alarm, the output voltage of the receiver of AFBR-S10TR001Z is evaluated only outside the time window in which the heartbeat pulse is expected; therefore, it does not matter what said output voltage is inside the mentioned time window (see Figure 2 for clarification).

## Microcontroller

The differentiation between an arc flash event, heartbeat signal and ambient light is made through the Arduino microcontroller placed on the evaluation board. To achieve this differentiation, the microcontroller evaluates the output of the receiver of AFBR-S10TR001Z inside and outside a time window of certain duration.

Figure 2 shows a schematic of the time window referred in the previous paragraph.

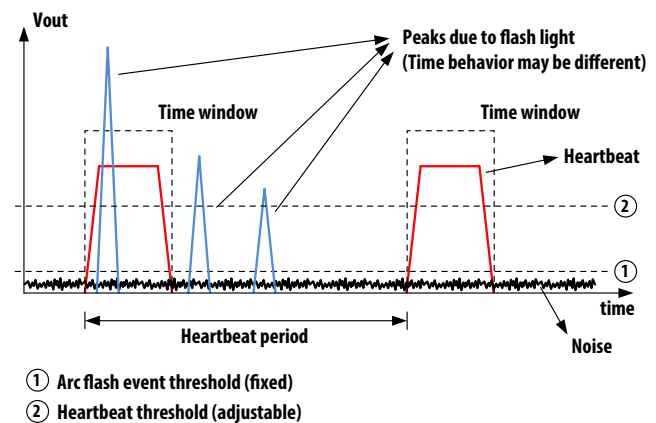

Figure 2. Schematic of the time window implemented in the Arduino microcontroller placed on AFBR-S10EB001Z

According to Figure 2, the following cases may occur:

- The receiver generates an output inside the time window whose amplitude is above the threshold set by means of RV1: in this case, the microcontroller determines that a heartbeat pulse has been received. The Heartbeat Loss alarm is not triggered. The Flash Detected alarm is not triggered either, since this alarm cannot be triggered within the time interval enclosed by the time window.
- The receiver generates an output inside the time window whose amplitude is below the threshold set by means of RV1: in this case, the microcontroller triggers the Heartbeat Loss alarm and, consequently, turns the LED D1 on. The LED D1 will remain on until the amplitude of the output generated by the receiver inside the time window is above the threshold set by means of RV1.
- The receiver generates an output outside the time window whose amplitude is above 20mV: in this case, the microcontroller triggers the Flash Detected alarm and, consequently, turns the LED D2 on, which will remain in this state for 4 seconds. In order to let the user visualize the Flash Detected alarm, any activity of the board is paused during these 4 seconds.
- The receiver generates an output outside the time window whose amplitude is below 20mV: in this case, the microcontroller determines that no arc flash event has occurred. The Flash Detected alarm is not triggered.

In addition to the differentiation between arc flash events, heartbeat pulses and pure noise, the Arduino microcontroller may also produce the electrical signal used to drive the transmitter of AFBR-S10TR001Z and generate the optical heartbeat pulses. When the Internal Heartbeat Mode is chosen by means of the switch button SW1, the Arduino microcontroller generates one 50µs-long pulse each second.

### SMA connector (P6)

The SMA connector placed on the evaluation board allows the user to supply an external heartbeat signal to the transmitter of AFBR-S10TR001Z.

The External Heartbeat Mode, can be enabled by pressing and holding the switch button SW1 until the LED D4 is on. If the output impedance of the pattern/pulse generator used to produce the external heartbeat signal is 50Ω, which is the general case, this impedance must be selected by means of the 3-pin header JP1.

Table 1 shows the characteristics that the external heartbeat signal must have.

**Table 1. External heartbeat signal characteristics**

High Voltage Level	3.5V to 5.0V
Low Voltage Level	0V to 1.5V
High level duration	100µs to 1ms
Repetition rate	0Hz to 1000Hz

### Sensor Output Voltage Test (W3)

This 2-pin header allows the user monitoring the output voltage of AFBR-S10TR001Z by means of an oscilloscope and a high-impedance probe.

## Test setups

This section explains in detail the basic test configurations that may be used to evaluate AFBR-S10TR001Z sensor transceiver by means of the evaluation board provided in the AFBR-S10EB001Z evaluation kit.

### Normal operation

Figure 3 shows the configuration for normal operation of the evaluation board.

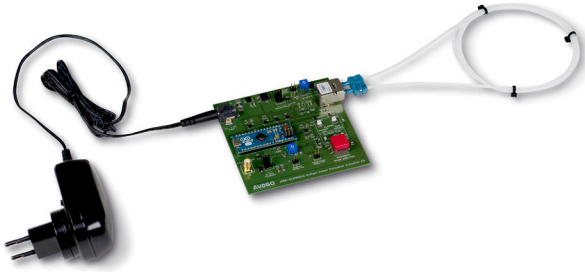

Figure 3. Configuration for normal operation of the evaluation board

In this configuration, the electrical heartbeat signal is internally generated by the Arduino microcontroller and it is later translated into the optical domain by the transmitter of AFBR-S10TR001Z. The optical heartbeat signal travels inside the core of the transparent-jacket-POF patch-cord and reaches the receiver of the AFBR-S10TR001Z within the time window specified for that purpose. The amplitude of the electrical signal generated by the receiver due to the optical heartbeat signal is above the heartbeat detection threshold which has been set by means of the potentiometer RV1; therefore, the Arduino microcontroller does not trigger the Heartbeat Loss alarm and the LED D1 remains off. No flash light is generated, which makes the LED D2 to remain off as well.

Figure 4 shows the electrical output generated by the receiver of AFBR-S10TR001Z, which is available at the 2-pin header W3 and has been monitored by means of a high-impedance probe connected to an oscilloscope.

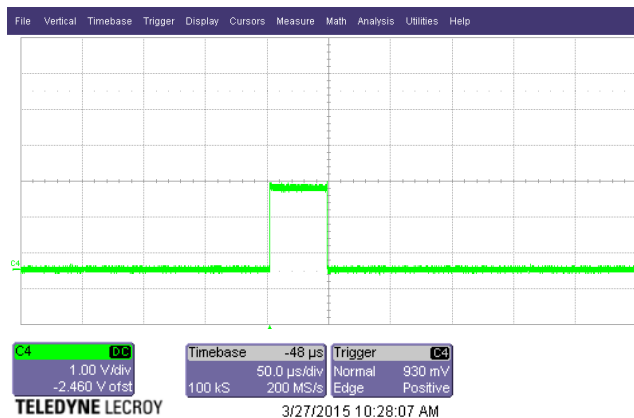

Figure 4. Electrical output available at the 2-pin header W3 for normal operation of the evaluation board

### Heartbeat loss

Figure 5 shows the configuration used to test the Heartbeat Loss alarm implemented in the evaluation board of AFBR-S10TR001Z.

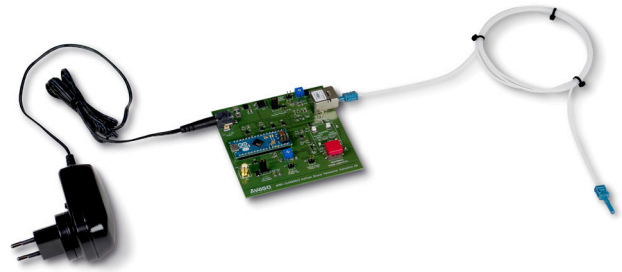

Figure 5. Configuration used to test the heartbeat loss alarm of the evaluation board

In this configuration, as in the previous one, the electrical heartbeat signal is internally generated by the Arduino microcontroller and later translated into the optical domain by the transmitter of AFBR-S10TR001Z. However, since the transparent-jacket-POF patch-cord has been disconnected from the receiver, the heartbeat signal cannot be detected, which makes the Arduino microcontroller to trigger the Heartbeat Loss alarm and to turn the LED D1 on.

The same result would be obtained if, instead of disconnecting the transparent-jacket-POF patch-cord from the receiver of AFBR-S10TR001Z, the potentiometer RV1 was set to a value which fixed a heartbeat detection threshold above the level of the output voltage generated by the receiver of AFBR-S10TR001Z when a heartbeat pulse is received.

In the same way, the Heartbeat Loss alarm would be triggered as well if, by means of the potentiometer RV2, the optical power of the heartbeat pulses was set to a value low enough as to make the receiver of AFBR-S10TR001Z to generate an electrical output below the threshold fixed for the heartbeat detection by the potentiometer RV1.

In conclusion, the Heartbeat Loss alarm may be triggered by either disconnecting the transparent-jacket-POF patch-cord from the receiver of AFBR-S10TR001Z or by fixing the potentiometers RV1 and/or RV2 to the appropriate values.



## Arc flash event detected

Figure 6 shows the configuration used to test the Flash Detected alarm implemented in the evaluation board of AFBR-S10TR001Z.

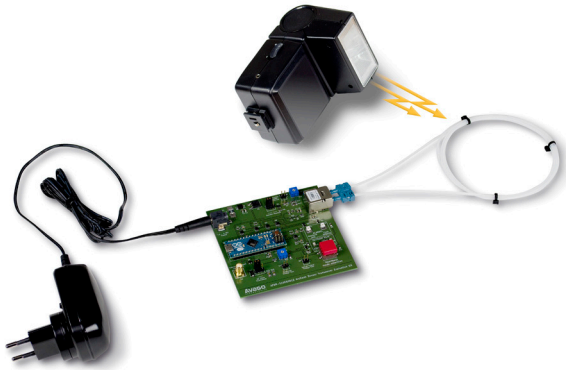

**Figure 6. Configuration used to test the arc flash event detection alarm of the evaluation board**

In this configuration, the electrical heartbeat signal is externally generated by a pulse/pattern generator. The reason for changing from internal heartbeat generation to external heartbeat generation is that the period of the heartbeat signal, when internally generated, is 1s, which is too long if, as in this case, it is desired to have a few heartbeat pulses together with the arc flash event visualized on the screen of the oscilloscope, as shown in Figure 7.

The heartbeat signal generated by the pulse/pattern generator is translated into the optical domain by the transmitter of AFBR-S10TR001Z. This optical heartbeat signal travels inside the core of the transparent-jacket-POF patch-cord and reaches the receiver of AFBR-S10TR001Z within the time window specified for that purpose.

By means of the flash light source, a flash light, which emulates an arc flash event, is generated. When the high optical power of the flash light reaches the receiver of AFBR-S10TR001Z, it generates an electrical output whose amplitude should be above the 20mV threshold fixed for the detection of arc flash events. If this is the case, the Arduino microcontroller will determine that an arc flash event has occurred, triggering the Flash Detected alarm and turning the LED D2 on. This LED will remain on for 4 seconds.

Figure 7 shows the electrical output generated by the receiver of AFBR-S10TR001Z when an arc flash event is detected. This output is available at the 2-pin header W3 and has been monitored by means of a high-impedance probe connected to an oscilloscope.

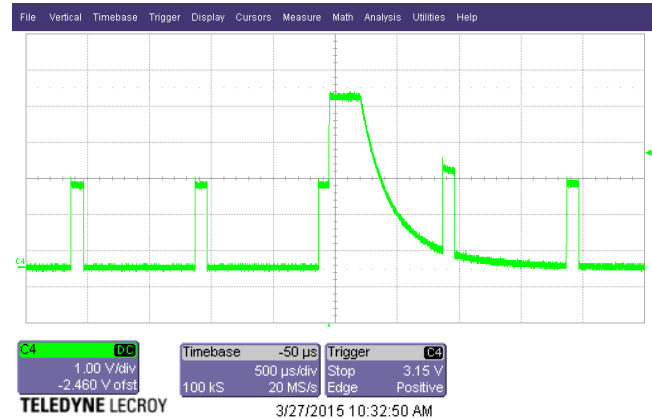

**Figure 7. Electrical output available at the 2-pin header W3 of the evaluation board when an arc flash event is detected**

As may be observed in Figure 7, the arc flash event duration is longer than one heartbeat pulse, which assures that the Flash Detected alarm would be triggered even in the case that the arc flash event started at the same time as the heartbeat pulse.

## IMPORTANT NOTE!

Both external and internal heartbeat generation may be set for any of the three test setups previously described. However, the user must select the desired heartbeat mode by means of the switch button SW1 prior to checking any of the three test setups.

## Evaluation board schematic and bill of materials (BOM)

The bill of materials (BOM) of the board included in the evaluation kit AFBR-S10EB001Z is given in Table 2. The electrical schematic of the evaluation board is shown in Figure 8.

**Table 2. Bill of materials**

Component	Description	Value	Package	Mouser P/N	Note	
C1,C3,C4, C13	Capacitor	10 $\mu$ F	0805		All capacitors have, at least, 10V rating. All capacitors are ceramic layer type.	
C10, C11	Capacitor	1 $\mu$ F	0805			
C12	Capacitor	Not populated	0805			
C2, C5, C8	Capacitor	10nF	0805			
C6	Capacitor	2.2nF	0805			
C7, C14	Capacitor	100nF	0805			
C9	Capacitor	4.7 $\mu$ F	0805			
D1	LED, amber		PLCC6	630-ASMT-QABD-AEF0E		Heartbeat Loss
D2	LED, red		PLCC6	630-ASMT-QRBD-AEF0E		Flash Detected
D3	Schottky diode		SMB	621-B240-F	B240F	
D4	LED, green		1206	630-HSMQ-C150	External Heartbeat	
D5	LED, blue		1206	630-HSMR-C150	Internal Heartbeat	
D6	Reference diode		SOT23	700-LM4040DEM3-4.1T	LM4040-4.096V	
D7	TVS diode		DO-214AC	652-SMAJ5.0CA	SMAJ5.0CA	
F1	Polyfuse	300mA	2016	576-2016L030DR	Resettable PTC	
JP1	Header 2.54mm		100mil pitch		Termination	
JP2	Header 2.54mm		100mil pitch		Operate-Measure	
L1	Ferrite		0805	875-IC0805B182R-10		
M1	Microcontroller		34-pin DIL	782-A000053	Arduino Micro	
P5	DC-Connector		RASM722X	502-RASM722X	7.5 - 9 VDC Input	
P6	RF-Connector SMA		5-pin SMA	571-5-1814832-1	External Heartbeat Input	
Q1,Q2,Q3, Q4, Q5	MOSFET N-Chan		SOT23	512-2N7002	2N7002	
R1	Resistor	39R	0805		All resistors have a tolerance up to 1% (E24 series), unless otherwise specified	
R10,R11	Resistor	180R	1206			
R9, R12,R14	Resistor	100k	0805			
R8,R13	Resistor	24k	0805			
R15,R16	Resistor	100R	1206			
R17,R18	Resistor	270R	0805			
R2, R3, R19	Resistor	510R	0805			
R20	Resistor	0R	0805			
R21,R22	Resistor	33R	0805			
R24,R25	Resistor	3.9k	0805			
R4	Resistor	130R	0805			
R5,R23	Resistor	Not populated	0805			
R6	Resistor	10k	0805			
R7	Resistor	10R	1206	756-PCF1206R-10RBT1		0.1% type
RV1,RV2	Potentiometer	5k	T70YB-Series	72-T70YB-5K		
SW1	TACT-Switch SMD		SMD-Switch	101-0624-EV (switch button) / 101-0112-EV (cap)	Heartbeat select	
U1	Voltage Regulator 5V		DPAK2	863-MC78M05CDTRKG	MC78M05	
U2,U7	IC, Monoflop		SSOP8	595-SN74LVC1G123DCTR	74LVC123	
U3	Sensor Module		AFBR-S10TR001Z		Avago Arc Flash Sensor Transceiver	
U4	IC, NAND		SSOP8	595-SN74LVC2G00DCTR	74LVC2G00	
U5	IC, Tristate buffer		SSOP8	595-SN74LVC2G125DCTR	74LVC125	
U6	IC, AND		SSOP8	595-SN74LVC2G08DCTR	74LVC2G08	
W1	Header 2.54mm		100mil pitch		Tx Current Monitor	
W2	Header 2.54mm		100mil pitch		Threshold Voltage	
W3	Header 2.54mm		100mil pitch		Output Voltage	

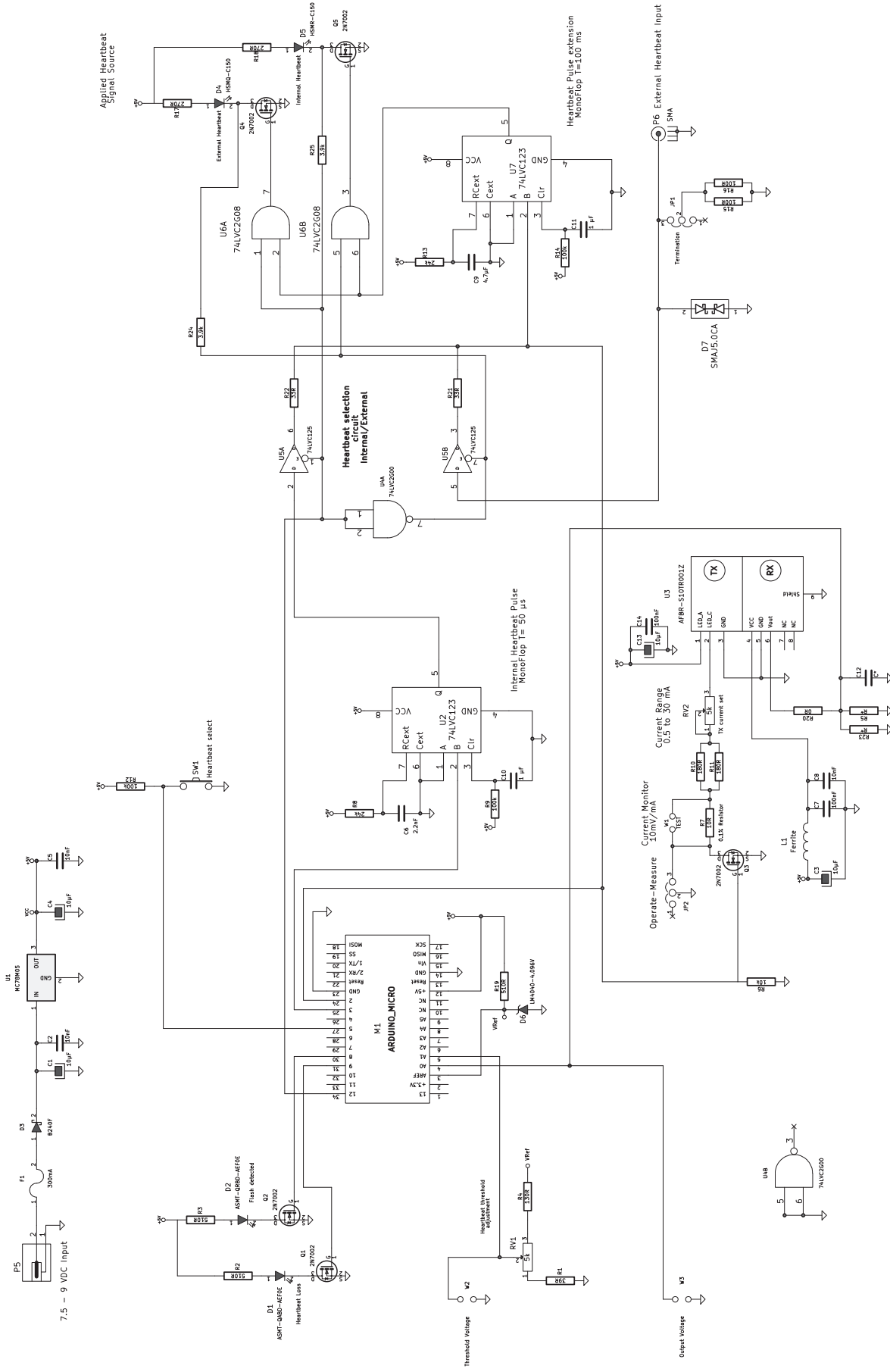

Figure 8. Schematic of the board included in the evaluation kit AFBR-S10EB001Z



For product information and a complete list of distributors, please go to our web site: [www.avagotech.com](http://www.avagotech.com)

Avago, Avago Technologies, and the A logo are trademarks of Avago Technologies in the United States and other countries.  
Data subject to change. Copyright © 2005-2015 Avago Technologies. All rights reserved.  
AV02-4913EN - May 8, 2015



## Данный компонент на территории Российской Федерации

### Вы можете приобрести в компании MosChip.

Для оперативного оформления запроса Вам необходимо перейти по данной ссылке:

<http://moschip.ru/get-element>

Вы можете разместить у нас заказ для любого Вашего проекта, будь то серийное производство или разработка единичного прибора.

В нашем ассортименте представлены ведущие мировые производители активных и пассивных электронных компонентов.

Нашей специализацией является поставка электронной компонентной базы двойного назначения, продукции таких производителей как XILINX, Intel (ex.ALTERA), Vicor, Microchip, Texas Instruments, Analog Devices, Mini-Circuits, Amphenol, Glenair.

Сотрудничество с глобальными дистрибьюторами электронных компонентов, предоставляет возможность заказывать и получать с международных складов практически любой перечень компонентов в оптимальные для Вас сроки.

На всех этапах разработки и производства наши партнеры могут получить квалифицированную поддержку опытных инженеров.

Система менеджмента качества компании отвечает требованиям в соответствии с ГОСТ Р ИСО 9001, ГОСТ РВ 0015-002 и ЭС РД 009

### Офис по работе с юридическими лицами:

105318, г.Москва, ул.Щербаковская д.3, офис 1107, 1118, ДЦ «Щербаковский»

Телефон: +7 495 668-12-70 (многоканальный)

Факс: +7 495 668-12-70 (доб.304)

E-mail: [info@moschip.ru](mailto:info@moschip.ru)

Skype отдела продаж:

moschip.ru

moschip.ru\_4

moschip.ru\_6

moschip.ru\_9