

DELPHI SERIES



FEATURES

- ♦ High Efficiency: 93.4% @ 12Vin, 5V/20A out
- ♦ Size: 30.5x15.5x12.0mm (1.20"x0.61"x0.46")
- ♦ Wide input range: 4.5V~13.2V
- ♦ Output voltage programmable from 0.59Vdc to 5.0Vdc via external resistors
- ♦ No minimum load required
- ♦ Fixed frequency operation
- ♦ Input UVLO, output OCP, SCP, OVP
- ♦ Remote On/Off (Positive logic)
- ♦ Power Good Function
- ♦ Parts/assembly comply with ROHS
- ♦ ISO 9001, TL 9000, ISO 14001, QS9000, OHSAS18001 certified manufacturing facility

Delphi D12S05020-1 Non-Isolated Point of Load

DC/DC Modules: 4.5V~13.2Vin, 0.59V~5.0Vout, 20A

The Delphi D12S05020-1 Series, 4.5V to 13.2V wide input, wide trim, single output, non-isolated point of load (POL) DC/DC converters are the latest offering from a world leader in power systems technology and manufacturing — Delta Electronics, Inc. The D12S05020-1 product family is part of the second generation, non-isolated point-of-load DC/DC power modules for the data communication applications which cut the module size by almost 50% in most of the cases compared to the first generation NC series POL modules. The D12S05020-1 product family provides an ultra wide input range to support 5V, 8V, 9.6V, and 12V bus voltage point-of-load applications and it offers 20A of output current in a vertically mounted through-hole miniature package and the output can be resistor trimmed from 0.59Vdc to 5.0Vdc. It provides a very cost effective, high efficiency, and high density point of load solution. With creative design technology and optimization of component placement, these converters possess outstanding electrical and thermal performance, as well as extremely high reliability under highly stressful operating conditions.

DATASHEET

DS_D12S05020-1_12022009

OPTIONS

APPLICATIONS

- ♦ Data Communications
- ♦ Distributed power architectures
- ♦ Servers and workstations
- ♦ LAN/WAN applications
- ♦ Data processing applications

TECHNICAL SPECIFICATIONS

(Ambient Temperature=25°C, minimum airflow=200LFM, nominal V_{in} =12Vdc unless otherwise specified.)

PARAMETER	NOTES and CONDITIONS	D12S05020-1			
		Min.	Typ.	Max.	Units
ABSOLUTE MAXIMUM RATINGS					
Input Voltage		-0.3		13.2	V
Operating Temperature	Airflow dependent, refer to thermal de-rating curves in Figure 28-35	0		85	°C
Storage Temperature		-40		125	°C
INPUT CHARACTERISTICS					
Operating Input Voltage		4.5		13.2	V
Input Under-Voltage Lockout					
Turn-On Voltage Threshold	For 5V output the input minimum is 6.5V		4.5		V
Turn-Off Voltage Threshold			4.0		V
Maximum Input Current	$V_{in}=6.5V, V_o=5.0V, I_o=20A$			16.5	A
	$V_{in}=5V, V_o=3.3V, I_o=20A$			14.7	A
No-Load Input Current	$V_{in}=12V, V_o=5.0V, I_o=0A$			60	mA
Off Converter Input Current	Remote OFF		10		mA
OUTPUT CHARACTERISTICS					
Output Voltage Adjustment Range		0.59		5.0	V
Output Voltage Set Point	With a 0.1% trim resistor	-2		+2	% V_o
Total output range	Over load, line, temperature regulation and set point	-3.0		+3.0	% V_o
Output Voltage Ripple and Noise	OSCON 680uF x2, 5Hz to 20MHz bandwidth				
Peak-to-Peak	Full Load, 12Vin, 5Vo		10	20	mVpk-pk
Output Current Range		0		20	A
Output Voltage Over-shoot at Power-On	OSCON 680uF x2,		0.5%		V_o
Output Voltage Under-shoot at Power-Off	$V_{in}=12V$, Turn OFF, OSCON 680uF x2,			100	mV
Output DC Current-Limit Inception	Hiccup mode		30		A
Over Voltage Protection	Hiccup mode		115		%
Under Voltage Protection	Hiccup mode		115		%
DYNAMIC CHARACTERISTICS					
Output Dynamic Load Response	Output step load 10A to 20A, 10A/usec				
	$V_o=5.0V$, 1360 μ F output capacitance		150		mVpk
	$V_o=3.3V$, 1360 μ F output capacitance		99		mVpk
	$V_o=2.5V$, 1360 μ F output capacitance		75		mVpk
	$V_o=1.5V$, 1360 μ F output capacitance		45		mVpk
	$V_o=1.2V$, 3280 μ F output capacitance		26		mVpk
	$V_o=0.9V$, 3280 μ F output capacitance		22		mVpk
	$V_o=0.59V$, 3280 μ F output capacitance		22		mVpk
Turn-On Transient					
Rise Time	From 10% to 90% of V_o		3	5	ms
Turn on Delay (Remote on/off)	$V_{in}=12V, I_o=\text{min-max. (With 10% of } V_o)$			5	ms
Minimum Output Capacitance		1300		5000	μ F
EFFICIENCY					
$V_o=0.59V$	$V_{in}=12V, I_o=20A$		76.8		%
$V_o=0.9V$	$V_{in}=12V, I_o=20A$		82.1		%
$V_o=1.1V$	$V_{in}=12V, I_o=20A$		83.8		%
$V_o=1.2V$	$V_{in}=12V, I_o=20A$		85.1		%
$V_o=1.5V$	$V_{in}=12V, I_o=20A$		86.6		%
$V_o=2.5V$	$V_{in}=12V, I_o=20A$		89.7		%
$V_o=3.3V$	$V_{in}=12V, I_o=20A$		90.4		%
$V_o=5.0V$	$V_{in}=12V, I_o=20A$		93.4		%
FEATURE CHARACTERISTICS					
Switching Frequency	Fixed		600		KHz
ON/OFF Control	Positive logic (internally pulled high)				
Logic High	Module On (or leave the pin open)	1.2			V
Logic Low	Module Off			0.8	V
Power Good Delay	All conditions (within 90% of V_o)			6	ms
Power Good Signal	V_o is outside +/-10% of V_o, set	0		0.4	V
	V_o is Within +/-10% of V_o, set			5.0	V
GENERAL SPECIFICATIONS					
Calculated MTBF	25°C, 300LFM, 80% load		6.33		Mhours
Weight			8.8		grams



ELECTRICAL CHARACTERISTICS CURVES

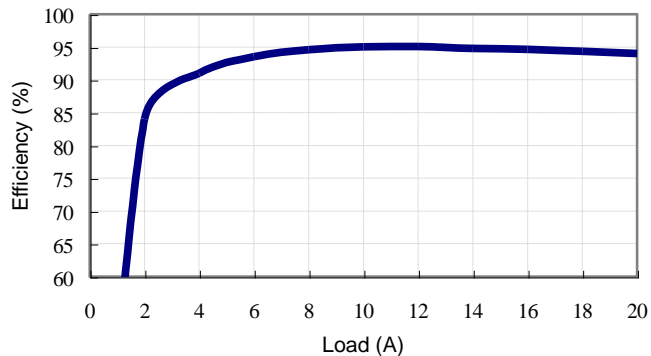

Figure 1: Converter efficiency vs. output current (5.0V output voltage, 12V input)

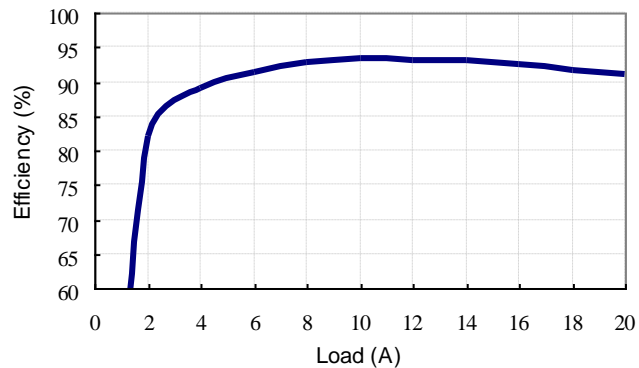

Figure 2: Converter efficiency vs. output current (3.3V output voltage, 12V input)

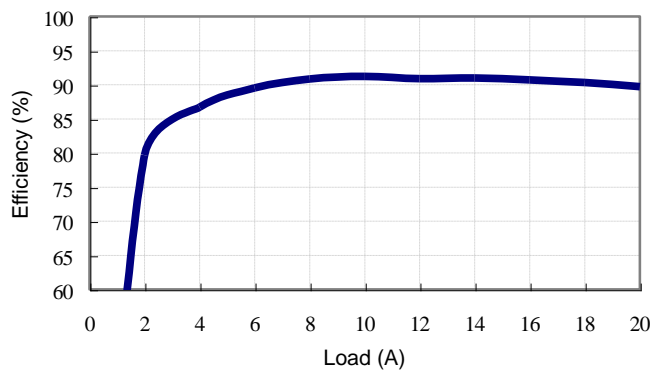

Figure 3: Converter efficiency vs. output current (2.5V output voltage, 12V input)

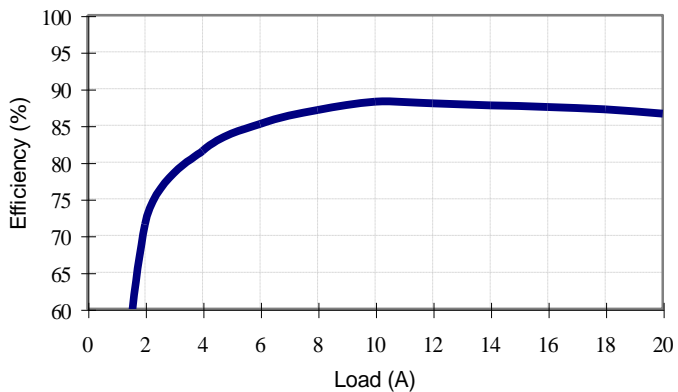

Figure 4: Converter efficiency vs. output current (1.5V output voltage, 12V input)

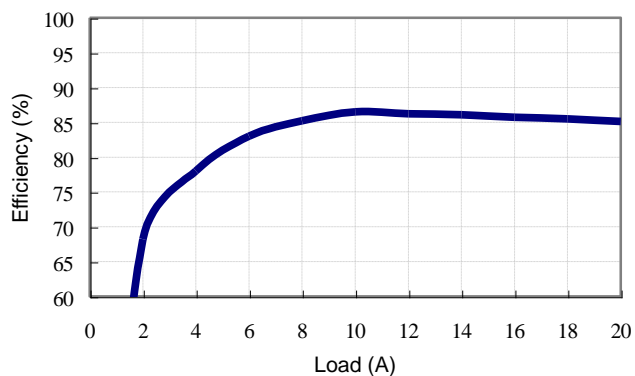

Figure 5: Converter efficiency vs. output current (1.2V output voltage, 12V input)

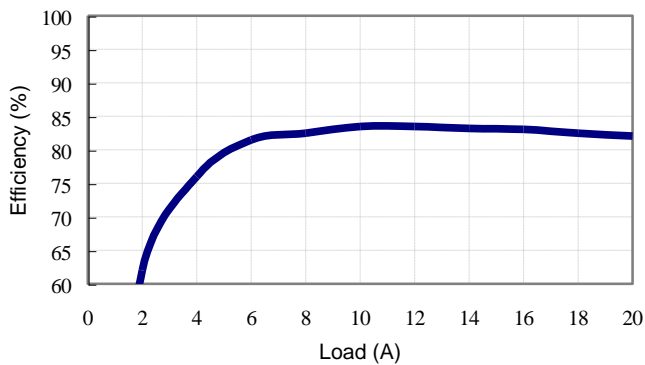

Figure 6: Converter efficiency vs. output current (0.9V output voltage, 12V input)



ELECTRICAL CHARACTERISTICS CURVES (CONTINUED)

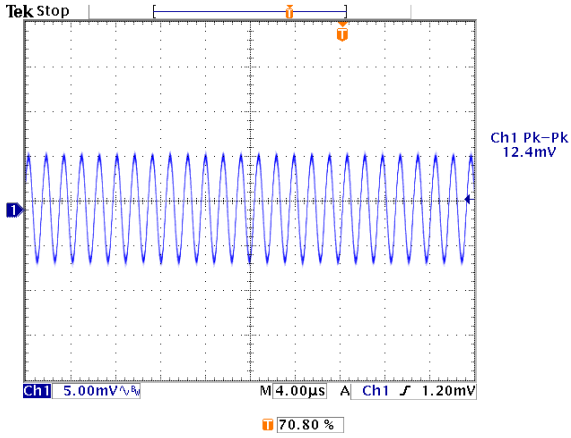

Figure 7: Output ripple & noise at 12Vin, 5.0V/20A out

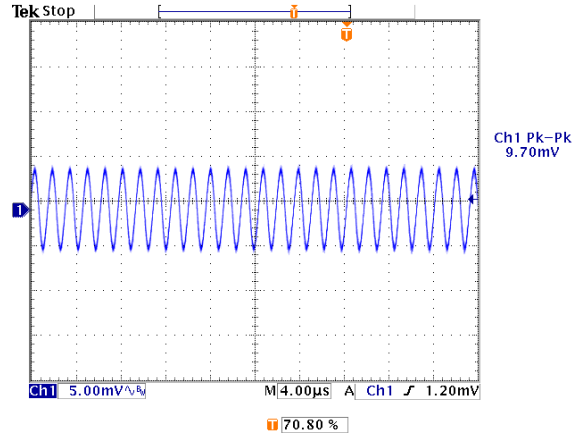

Figure 8: Output ripple & noise at 12Vin, 3.3V/20A out

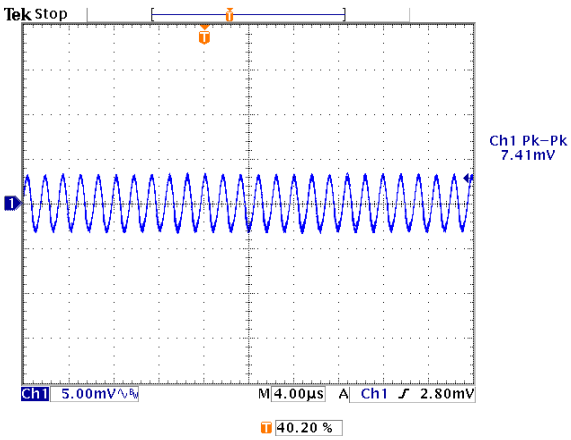

Figure 9: Output ripple & noise at 12Vin, 2.5V/20A out

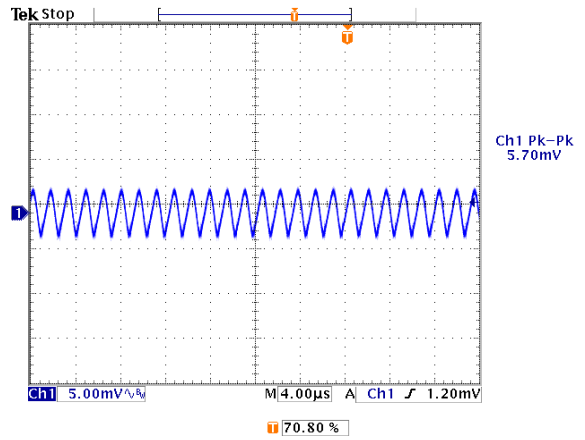

Figure 10: Output ripple & noise at 12Vin, 1.5V/20A out

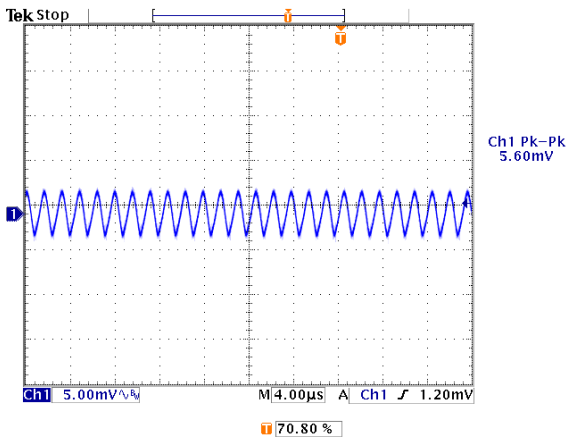

Figure 11: Output ripple & noise at 12Vin, 1.2V/20A out

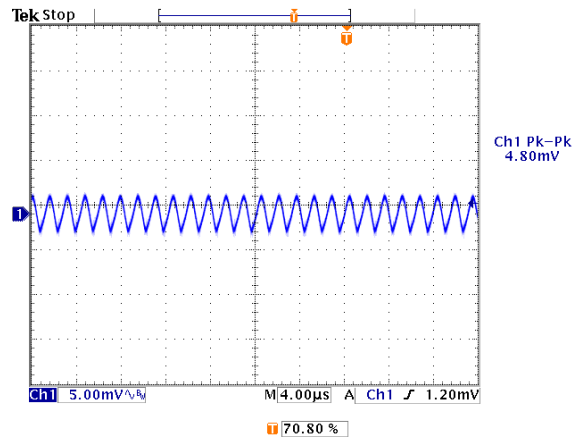

Figure 12: Output ripple & noise at 12Vin, 0.9V/20A out



ELECTRICAL CHARACTERISTICS CURVES (CONTINUED)

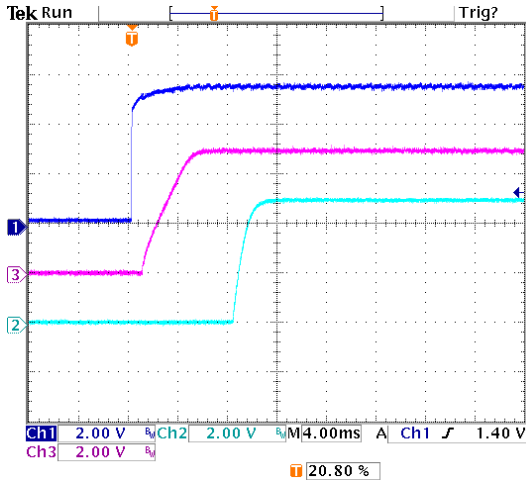

Figure 13: Control turn on at 12Vin, 5.0V/20A
Ch1: Enable, Ch3: Vo, Ch2: PG

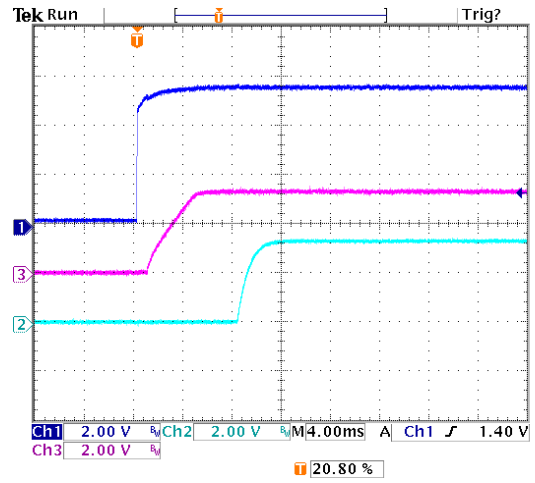

Figure 14: Control turn on at 12Vin, 3.3V/20A
Ch1: Enable, Ch3: Vo, Ch2: PG

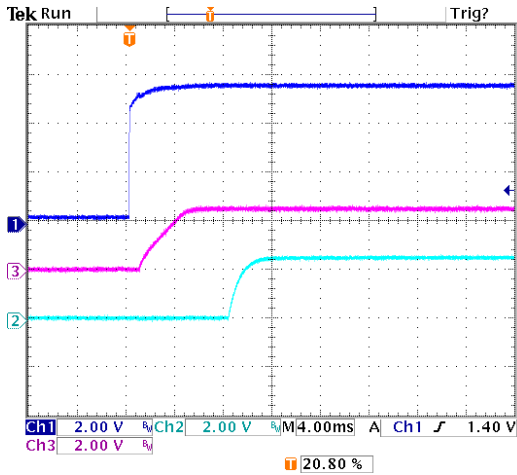

Figure 15: Control turn on at 12Vin, 2.5V/20A
Ch1: Enable, Ch3: Vo, Ch2: PG

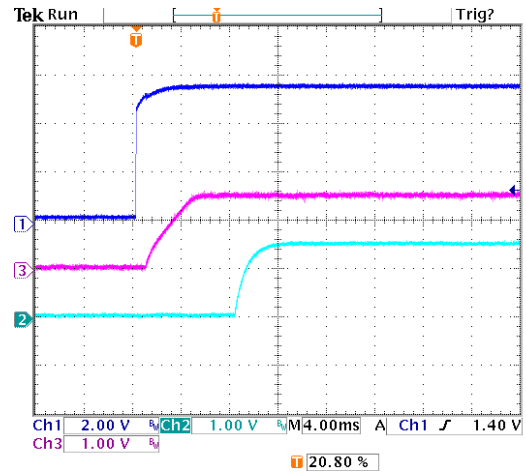

Figure 16: Control turn on at 12Vin, 1.5V/20A
Ch1: Enable, Ch3: Vo, Ch2: PG

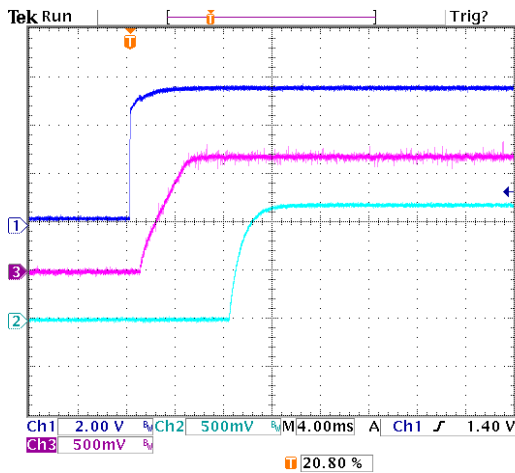

Figure 17: Control turn on at 12Vin, 1.2V/20A
Ch1: Enable, Ch3: Vo, Ch2: PG

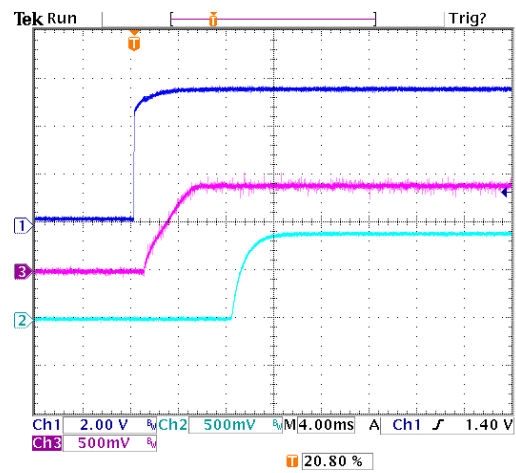

Figure 18: Control turn on at 12Vin, 0.9V/20A
Ch1: Enable, Ch3: Vo, Ch2: PG



ELECTRICAL CHARACTERISTICS CURVES (CONTINUED)

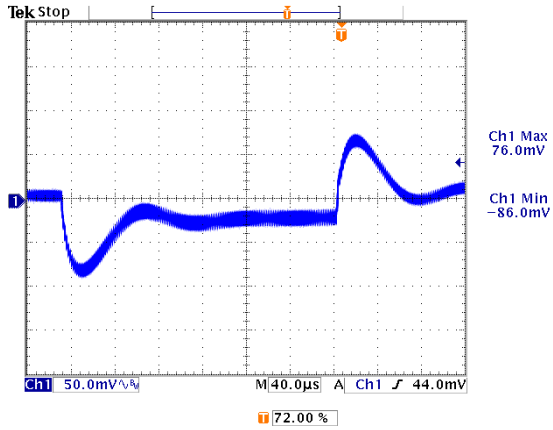

Figure 19: Transient response, 5.0V /20A, Ch1: Vo

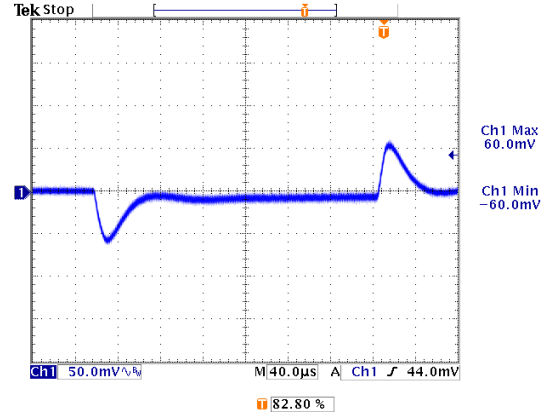

Figure 20: Transient response, 3.3V /20A, Ch1: Vo

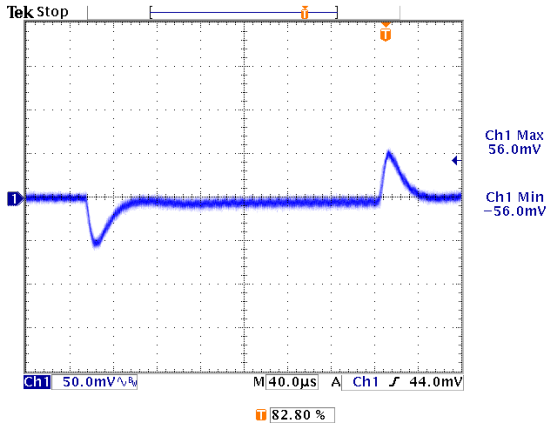

Figure 21: Transient response, 2.5V /20A, Ch1: Vo

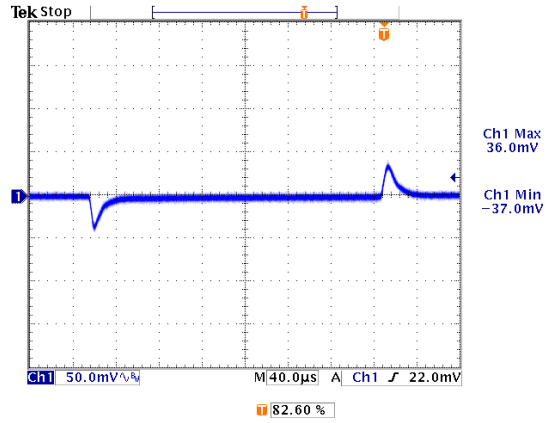

Figure 22: Transient response, 1.5V /20A, Ch1: Vo

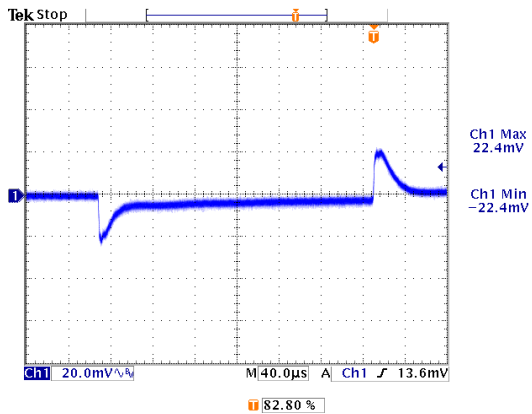

Figure 23: Transient response, 1.2V /20A, Ch1: Vo

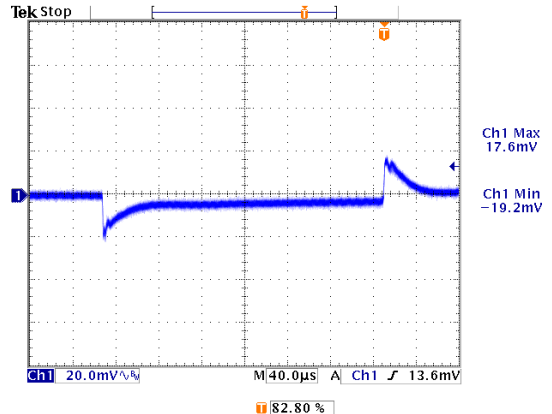

Figure 24: Transient response, 0.9V /20A, Ch1: Vo

DESIGN CONSIDERATIONS

The D12S05020-1 series uses a single phase and voltage mode controlled buck topology. The output can be adjusted in the range of 0.59Vdc to 5.0Vdc by a resistor from Trim pin to ground.

The converter can be turned ON/OFF by remote control with positive on/off (ENABLE pin) logic. The converter DC output is disabled when the signal is driven low (below 0.8V). The module will turn on when this pin is floating and the input voltage is higher than the threshold.

The converter can protect itself by entering hiccup mode against over current, short circuit, and over voltage condition.

Safety Considerations

It is recommended that the user to provide a very fast-acting type fuse in the input line for safety. The output voltage set-point and the output current in the application could define the amperage rating of the fuse.

FEATURES DESCRIPTIONS

Enable (On/Off)

The ENABLE (on/off) input allows external circuitry to put the D12S05020-1 series converter into a low power dissipation (sleep) mode. Positive ENABLE is available as standard. With the active high function, the output is guaranteed to turn on if the ENABLE pin is driven above 1.2V. The output will turn off if the ENABLE pin voltage is pulled below 0.8V.

The ENABLE input can be driven in a variety of way as shown in Figures 25.

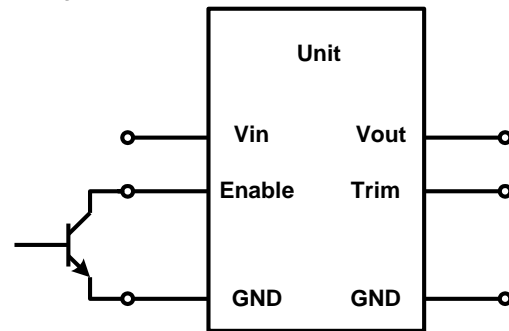

Figure 25. Enable Input drive circuit for D12S05020

Input Under-Voltage Lockout

The input under-voltage lockout prevents the converter from being damaged while operating when the input voltage is too low. The lockout occurs between 4.0V to 4.3V.

Output Capacitance

The D12S05020-1 requires minimum 1300uF output capacitor for stable operation.

Power Good

The converter provides an open collector signal called Power Good. The converter will sink less than 1uA as a logic high and sink at least 1mA as a logic low. A logic low must be less than 0.4V while sinking 1mA.

The power good signal is pulled low when an input under voltage, output over voltage or output over current conditions is detected or when the converter is disabled by ENABLE.

FEATURES DESCRIPTIONS (CON.)

Over-Current and Short-Circuit Protection

The D12S05020-1 series modules have non-latching over-current and short-circuit protection circuitry. When over current condition occurs, the module goes into the non-latching hiccup mode. When the over-current condition is removed, the module will resume normal operation.

An over current condition is detected by measuring the voltage drop across the MOSFETs. The voltage drop across the MOSFET is also a function of the MOSFET's $R_{ds(on)}$. $R_{ds(on)}$ is affected by temperature, therefore ambient temperature will affect the current limit inception point.

Output Over Voltage Protection (OVP)

The converter will shut down when an output over voltage protection is detected. Once the OVP condition is detected, controller will stop all PWM outputs, turn on low-side MOSFET and pull low the PGOOD signal to prevent any damage to load.

Paralleling

D12S05020-1 series converters do not have built-in current sharing (paralleling) ability. Hence, paralleling of multiple D12S05020-1 series converters is not recommended.

Output Voltage Programming

The output voltage of the D12S05020-1 series is adjusted by connecting an external resistor between the trim pin and output ground as shown Figure 26 and the typical trim resistor values are shown in Table 1.

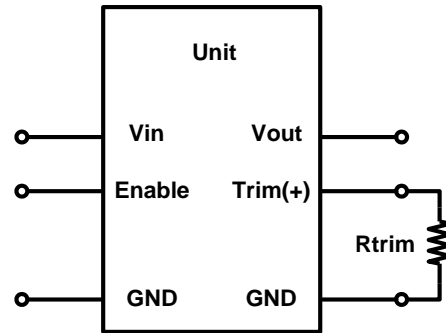

Figure 26: Trimming Output Voltage

The D12S05020-1 series module has a trim range of 0.59V to 5.0V. The trim resistor equation for the D12S05020 series is:

$$R_{trim}(\Omega) = \frac{1.18}{V_{out} - 0.59}$$

V_{out} is the output voltage set point

R_{trim} is the resistance between Trim and Ground

R_{trim} values should not be less than 240 Ω and shall be with 0.1% or better tolerance.

Output Voltage	R_{trim} (Ω)
0.59V	open
0.9 V	3.83k
1.1 V	2.32K
1.2 V	1.94K
1.5 V	1.30K
2.5V	618
3.3V	435
5.0V	267

Table 1: Typical trim resistor values



THERMAL CONSIDERATION

Thermal management is an important part of the system design. To ensure proper, reliable operation, sufficient cooling of the power module is needed over the entire temperature range of the module. Convection cooling is usually the dominant mode of heat transfer.

Hence, the choice of equipment to characterize the thermal performance of the power module is a wind tunnel.

Thermal Testing Setup

Delta's DC/DC power modules are characterized in heated vertical wind tunnels that simulate the thermal environments encountered in most electronics equipment. This type of equipment commonly uses vertically mounted circuit cards in cabinet racks in which the power modules are mounted.

The following figure shows the wind tunnel characterization setup. The power module is mounted on a test PWB and is vertically positioned within the wind tunnel. The space between the neighboring PWB and the top of the power module is constantly kept at 6.35mm (0.25").

Thermal Derating

Heat can be removed by increasing airflow over the module. To enhance system reliability, the power module should always be operated below the maximum operating temperature. If the temperature exceeds the maximum module temperature, reliability of the unit may be affected.

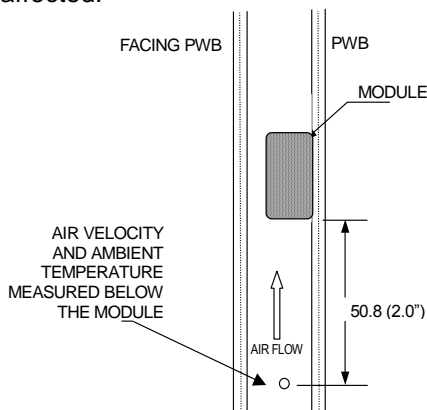

Note: Wind Tunnel Test Setup Figure Dimensions are in millimeters and (Inches)

Figure 27: Wind tunnel test setup

THERMAL CURVES

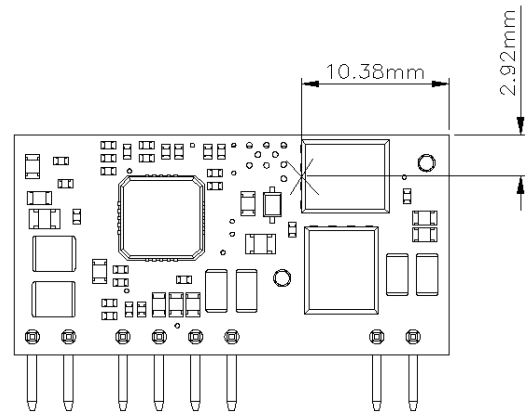

Figure 28: Temperature measurement location* The allowed maximum hot spot temperature is defined at 125°C

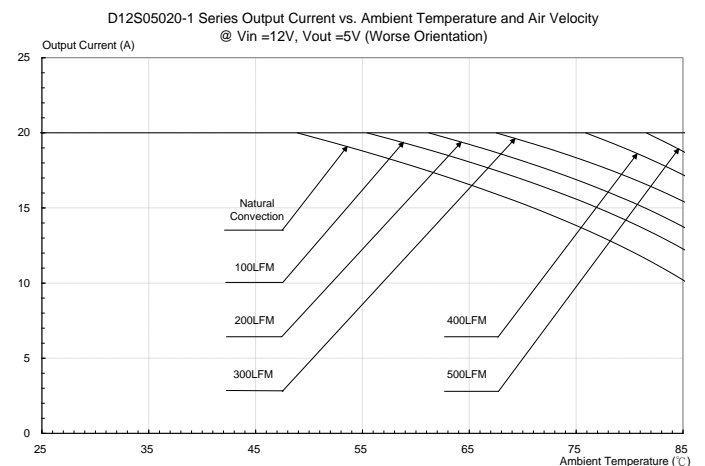

Figure 29: Output current vs. ambient temperature and air velocity @ Vin=12V, Vout=5.0V (Worse Orientation)

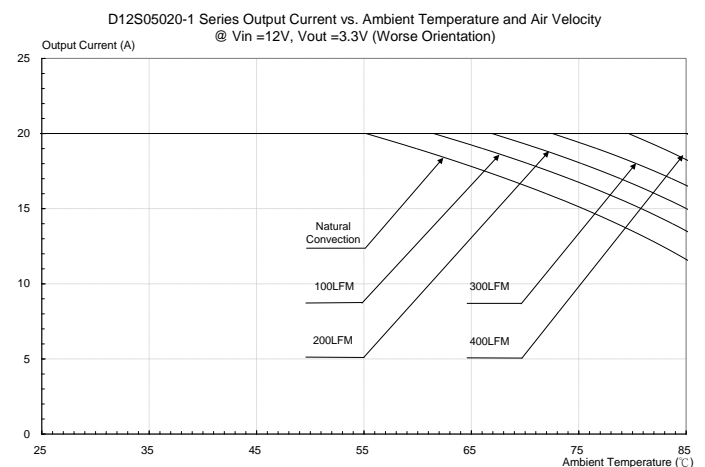

Figure 30: Output current vs. ambient temperature and air velocity @ Vin=12V, Vout=3.3V (Worse Orientation)



THERMAL CURVES (D12S05020-1)

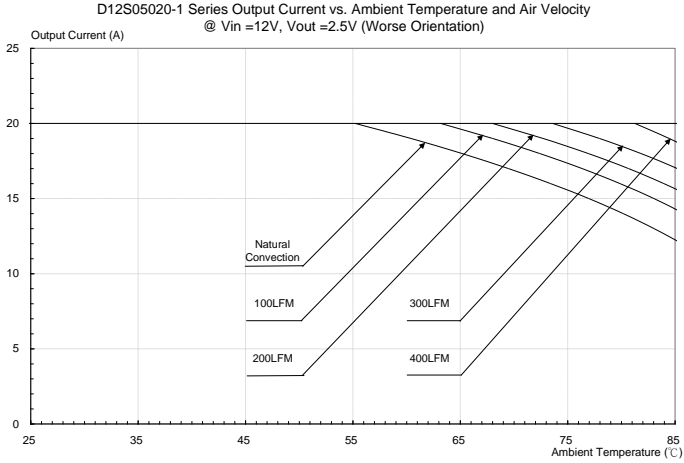

Figure 31: Output current vs. ambient temperature and air velocity @ Vin=12V, Vout=2.5V (Worse Orientation)

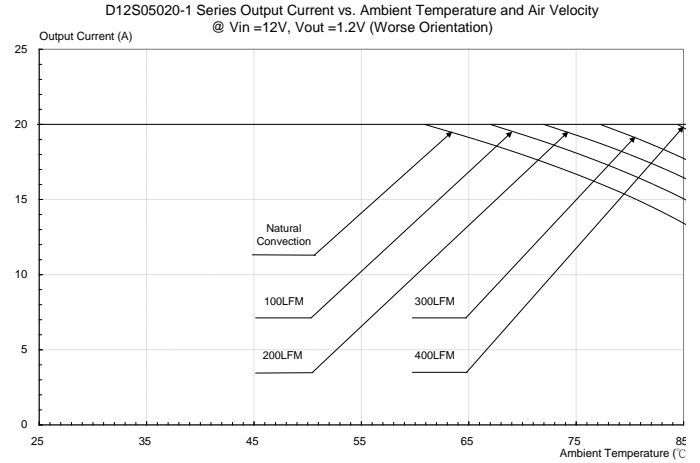

Figure 34: Output current vs. ambient temperature and air velocity @ Vin=12V, Vout=1.2V (Worse Orientation)

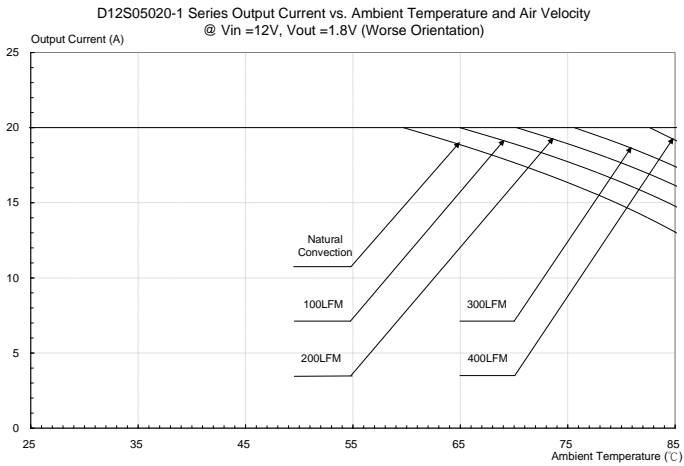

Figure 32: Output current vs. ambient temperature and air velocity @ Vin=12V, Vout=1.8V (Worse Orientation)

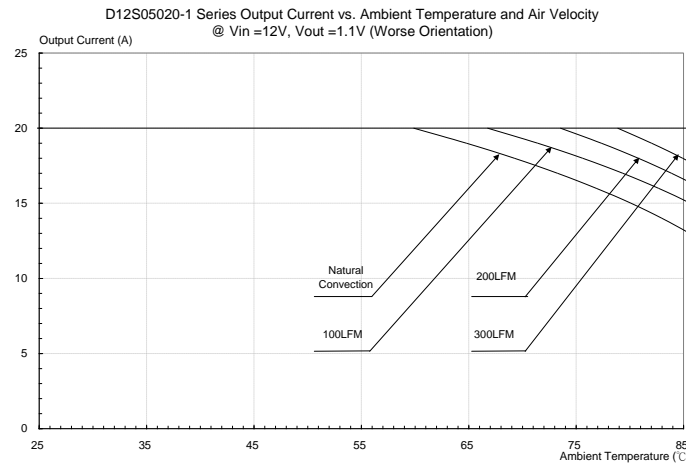

Figure 35: Output current vs. ambient temperature and air velocity @ Vin=12V, Vout=1.1V (Worse Orientation)

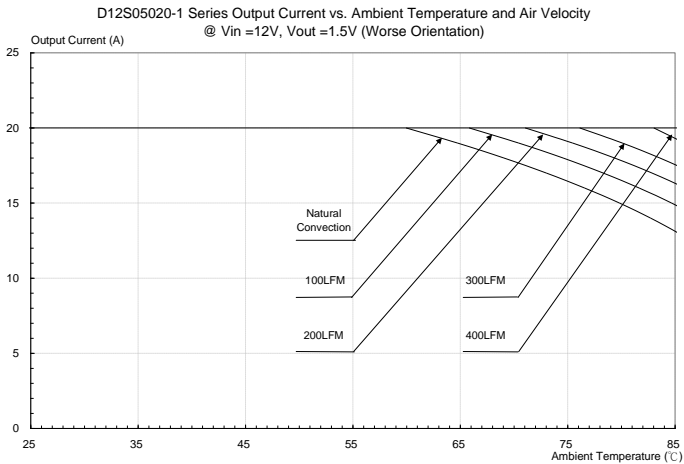

Figure 33: Output current vs. ambient temperature and air velocity @ Vin=12V, Vout=1.5V (Worse Orientation)

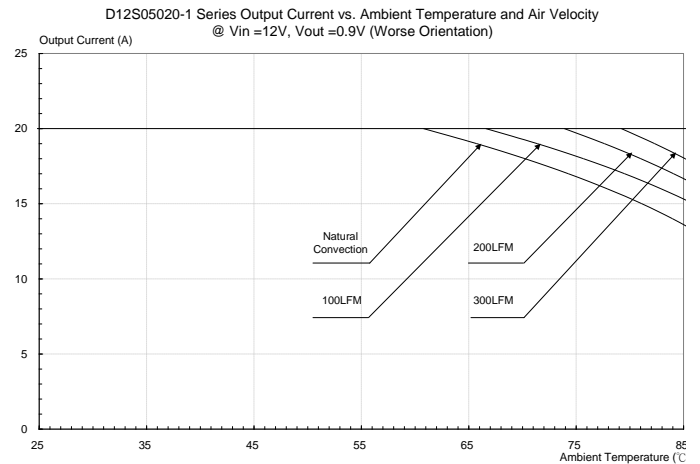
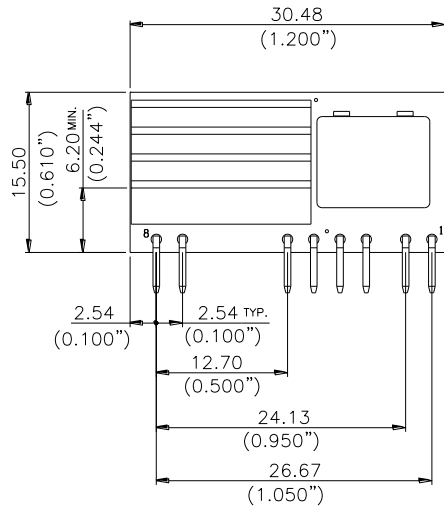

Figure 36: Output current vs. ambient temperature and air velocity @ Vin=12V, Vout=0.9V (Worse Orientation)



MECHANICAL DRAWING



TOP VIEW

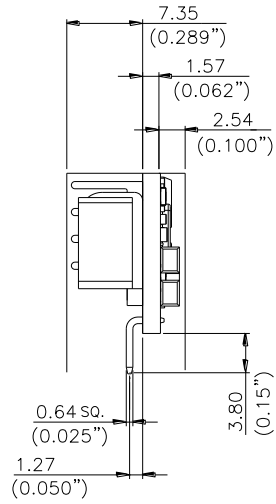

SIDE VIEW

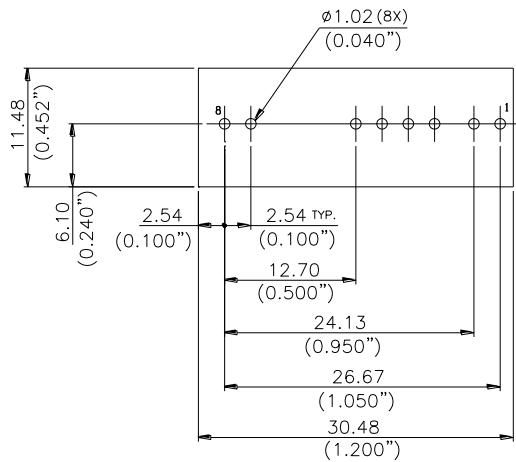

RECOMMENDED LAYOUT

PIN#	Function
1	Vout
2	TRIM
3	GND
4	PG
5	ENABLE
6	Vin
7	SENSE+
8	SENSE-

NOTE:

1. DIMENSION ARE IN MILLIMETERS MM (INCHES)
2. TOLERANCE: X.X±0.50mm (X.XX"±0.020")
X.XX±0.25mm (X.XXX"±0.010")

D12S05020-1 SERIES MODEL LIST

Model Name	Input Voltage	Output Voltage	Output Current	5Vout OCP typical	Lead Free	Pin Length
D12S05020-1 A	4.5V ~ 13.2V	0.59V ~ 5.0V	20A	30A	RoHs 5	3.50 mm
D12S05020-1 B	4.5V ~ 13.2V	0.59V ~ 5.0V	20A	32A	RoHs 5	3.80 mm
D12S05020-1 C	4.5V ~ 13.2V	0.59V ~ 5.0V	20A	30A	RoHs 6	3.80 mm
D12S05020-1 D	4.5V ~ 13.2V	0.59V ~ 5.0V	20A	30A	RoHs 6	3.50 mm
D12S05020-1 E	4.5V ~ 13.2V	0.59V ~ 5.0V	20A	32A	RoHs 6	3.80 mm

CONTACT: www.deltaww.com/dcdc

USA:

Telephone:
East Coast: 978-656-3993
West Coast: 510-668-5100
Fax: (978) 656 3964
Email: DCDC@delta-corp.com

Europe:

Telephone: +31-20-655-0967
Fax: +31-20-655-0999
Email: DCDC@delta-es.com

Asia & the rest of world:

Telephone: +886 3 4526107 ext. 6220~6224
Fax: +886 3 4513485
Email: DCDC@delta.com.tw

WARRANTY

Delta offers a two (2) year limited warranty. Complete warranty information is listed on our web site or is available upon request from Delta.

Information furnished by Delta is believed to be accurate and reliable. However, no responsibility is assumed by Delta for its use, nor for any infringements of patents or other rights of third parties, which may result from its use. No license is granted by implication or otherwise under any patent or patent rights of Delta. Delta reserves the right to revise these specifications at any time, without notice.

Данный компонент на территории Российской Федерации

Вы можете приобрести в компании MosChip.

Для оперативного оформления запроса Вам необходимо перейти по данной ссылке:

<http://moschip.ru/get-element>

Вы можете разместить у нас заказ для любого Вашего проекта, будь то серийное производство или разработка единичного прибора.

В нашем ассортименте представлены ведущие мировые производители активных и пассивных электронных компонентов.

Нашей специализацией является поставка электронной компонентной базы двойного назначения, продукции таких производителей как XILINX, Intel (ex.ALTERA), Vicor, Microchip, Texas Instruments, Analog Devices, Mini-Circuits, Amphenol, Glenair.

Сотрудничество с глобальными дистрибьюторами электронных компонентов, предоставляет возможность заказывать и получать с международных складов практически любой перечень компонентов в оптимальные для Вас сроки.

На всех этапах разработки и производства наши партнеры могут получить квалифицированную поддержку опытных инженеров.

Система менеджмента качества компании отвечает требованиям в соответствии с ГОСТ Р ИСО 9001, ГОСТ РВ 0015-002 и ЭС РД 009

Офис по работе с юридическими лицами:

105318, г.Москва, ул.Щербаковская д.3, офис 1107, 1118, ДЦ «Щербаковский»

Телефон: +7 495 668-12-70 (многоканальный)

Факс: +7 495 668-12-70 (доб.304)

E-mail: info@moschip.ru

Skype отдела продаж:

moschip.ru

moschip.ru_4

moschip.ru_6

moschip.ru_9