

## Integrated 802.11 b/g/n WLAN Module

### FEATURES

- IEEE 802.11 b/g/n (single stream n)
- Typical WLAN Transmit Power:
  - +19.0 dBm, 1 Mbps, CCK (b)
  - +15.8 dBm, 54 Mbps, OFDM (g)
  - +15.0 dBm, HT20 MCS7 (n)
- Typical WLAN Sensitivity:
  - -90 dBm, 8% PER, 11 Mbps (b)
  - -73 dBm, 10% PER, 54 Mbps (g)
  - -71 dBm, 10% PER, MCS7 (n)
- Miniature footprint: 10.5 mm x 10.5 mm
- Low height profile: 1.4 mm
- Operating voltage: 3.13V to 3.46V
- Operating temperature: -40 to +85° C
- Compact design based on Broadcom BCM4390 SoC
- Integrated ARM Cortex-M3 apps processor
- Wireless Security WEP, WPA Personal, WPA2 Personal
- Transmit and receive antenna diversity
- UART serial host interface
- Simple integration with microcontrollers and microprocessors
- Worldwide acceptance: FCC (USA), IC (Canada), and CE (Europe)
- Modular certification allows reuse of LSR FCC ID and ETSI certification without repeating the expensive testing on your end product
- RoHS compliant
- Streamlined development with LSR Design Services

### APPLICATIONS

- Thermostats, appliances, HVAC controller, and remote displays, Smart Energy
- Home entertainment control
- Sensor Networks
- Medical
- Home Monitoring
- Toys

### DESCRIPTION

The TiWi-C-W is a high performance 2.4 GHz WLAN module that contains an IP networking stack in a pre-certified footprint that simplifies the process of implementing internet connectivity.



The module includes the necessary PHY, MAC, and network layers to support WLAN applications on the integrated applications processor, or through a simple host interface.

Need to get to market quickly? Not an expert in 802.11. Need a custom antenna? Would you like to own the design? Would you like a custom design? Not quite sure what you need? Do you need help with your host board? LSR Design Services will be happy to develop custom hardware or software, or assist with integrating the design. Contact us at sales@lsr.com or call us at 262-375-4400.





- Home automation
- Home Network aggregators
- Remote appliance diagnostics/support
- Home security
- Remote storage devices
- Home network appliance
- Cameras and video surveillance
- Fitness
- Cable replacement for medical and personal healthcare

**ORDERING INFORMATION**

Order Number	Description
450-0118C	TiWi-C-W Module (Cut Tape)
450-0118R	TiWi-C-W Module (Tape and Reel, SPQ = 2000)
450-0137	TiWi-C-W Evaluation Platform
450-0143	TiWi-C-W Development Kit featuring TiWiConnect
450-0164	TiWi-C-W Serial-to-WiFi Development Kit

**Table 1 Orderable TiWi-C-W Part Numbers**

**MODULE ACCESSORIES**

	Order Number	Description
	<b>001-0001</b>	2.4 GHz Dipole Antenna with Reverse Polarity SMA Connector
	<b>080-0001</b>	U.FL to Reverse Polarity SMA Bulkhead Cable 105mm
	<b>001-0014</b>	2.4 GHz FlexPIFA Antenna
	<b>001-0030</b>	2.4 GHz Metal FlexPIFA Antenna w/U.FL Cable, 100 mm

**Table 2 Module Accessories**

**APPLICABLE DOCUMENTS**

- TiWi-C-W Module Application Guide (330-0158)
- TiWi-C-W Evaluation Platform User Guide (330-0159)

The information in this document is subject to change without notice.

---

**TABLE OF CONTENTS**

---

<b>FEATURES .....</b>	<b>1</b>
<b>APPLICATIONS .....</b>	<b>1</b>
<b>DESCRIPTION .....</b>	<b>1</b>
<b>ORDERING INFORMATION .....</b>	<b>2</b>
<b>MODULE ACCESSORIES.....</b>	<b>2</b>
<b>APPLICABLE DOCUMENTS .....</b>	<b>2</b>
<b>BLOCK DIAGRAM .....</b>	<b>5</b>
<b>FUNCTIONAL BLOCK FEATURES .....</b>	<b>5</b>
<b>WLAN Features .....</b>	<b>5</b>
<b>Network Stack Supported Protocols .....</b>	<b>6</b>
<b>Wireless Security System Features .....</b>	<b>6</b>
<b>TIWI-C-W MODULE FOOTPRINT AND PIN DEFINITIONS.....</b>	<b>7</b>
<b>PIN DESCRIPTIONS .....</b>	<b>8</b>
<b>ELECTRICAL SPECIFICATIONS .....</b>	<b>10</b>
<b>Absolute Maximum Ratings .....</b>	<b>10</b>
<b>Recommended Operating Conditions .....</b>	<b>10</b>
<b>General Characteristics .....</b>	<b>11</b>
<b>Power Consumption .....</b>	<b>12</b>
<b>Power Supply Requirements.....</b>	<b>13</b>
<b>RF Characteristics .....</b>	<b>14</b>
<b>UART HOST INTERFACE .....</b>	<b>20</b>
<b>Overview .....</b>	<b>20</b>
<b>UART Interface .....</b>	<b>20</b>
<b>UART Signal Description .....</b>	<b>20</b>
<b>Recommended Reflow Profile for Lead Free Solder .....</b>	<b>21</b>
<b>CLEANING .....</b>	<b>22</b>
<b>OPTICAL INSPECTION .....</b>	<b>22</b>

---

The information in this document is subject to change without notice.

---

<b>REWORK .....</b>	<b>22</b>
<b>SHIPPING, HANDLING, AND STORAGE .....</b>	<b>22</b>
Shipping.....	22
Handling .....	22
Moisture Sensitivity Level (MSL).....	22
Storage .....	22
Repeating Reflow Soldering.....	23
<b>AGENCY CERTIFICATIONS .....</b>	<b>24</b>
<b>AGENCY STATEMENTS.....</b>	<b>24</b>
Federal Communication Commission Interference Statement .....	24
Industry Canada Statements.....	25
<b>OEM RESPONSIBILITIES TO COMPLY WITH FCC AND INDUSTRY CANADA REGULATIONS.....</b>	<b>26</b>
<b>OEM LABELING REQUIREMENTS FOR END-PRODUCT .....</b>	<b>27</b>
<b>OEM END PRODUCT USER MANUAL STATEMENTS.....</b>	<b>28</b>
<b>EUROPE .....</b>	<b>29</b>
CE Notice .....	29
Declaration of Conformity (DOC) .....	29
<b>MECHANICAL DATA.....</b>	<b>30</b>
<b>PCB FOOTPRINT .....</b>	<b>31</b>
<b>RECOMMENDED SOLDER STENCIL .....</b>	<b>32</b>
<b>TAPE AND REEL PACKAGING.....</b>	<b>33</b>
<b>DEVICE MARKINGS.....</b>	<b>34</b>
Rev 1 Devices.....	34
Rev 3 Devices.....	34
<b>CONTACTING LSR .....</b>	<b>35</b>

---

The information in this document is subject to change without notice.

**BLOCK DIAGRAM**

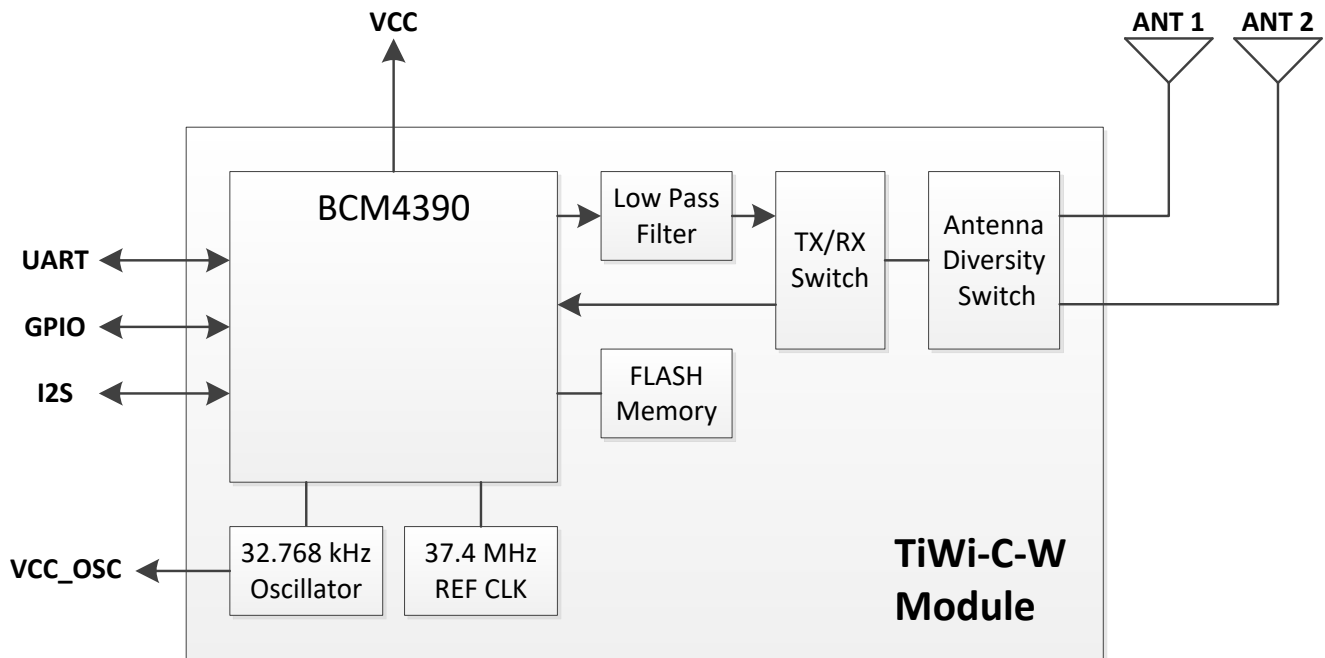

**Figure 1 TiWi-C-W Module Block Diagram – Top Level**

**FUNCTIONAL BLOCK FEATURES**

**WLAN Features**

- IEEE802.11b/g/n 1x1 2.4 GHz Radio
- Single Transmit and Single or Dual Receive Antenna Support
- **Media Access Controller (MAC)**
- Baseband Processor
- **Standards**
  - IEEE 802.11b, 802.11g, 802.11n
  - IEEE 802.11 d/i (regulatory domains and WPA2)
  - IEEE 802.11r (fast roaming between Aps)
  - IEEE 802.11w (secure management frames)

### Network Stack Supported Protocols

- **Transport layer:**
  - TCP
  - UDP
- **Network layer:**
  - IPv4, IPv6
  - Ping
  - DHCP
  - HTTP
  - NTP
  - DNS Client
- **Link layer:**
  - ARP

### Wireless Security System Features

- **Supported modes:**
  - Open (no security)
  - WEP
  - WPA Personal
  - WPA2 Personal
- **Supported encryption types:**
  - Open
  - WEP
  - AES (hardware accelerator)
  - TKIP (hardware accelerator)

**TIWI-C-W MODULE FOOTPRINT AND PIN DEFINITIONS**

To apply the TiWi-C-W module, it is important to use the module pins in your application as they are designated below, and in the corresponding pin definition table found on pages 8 and 9. Not all the pins on the TiWi-C-W module may be used, as some are reserved.

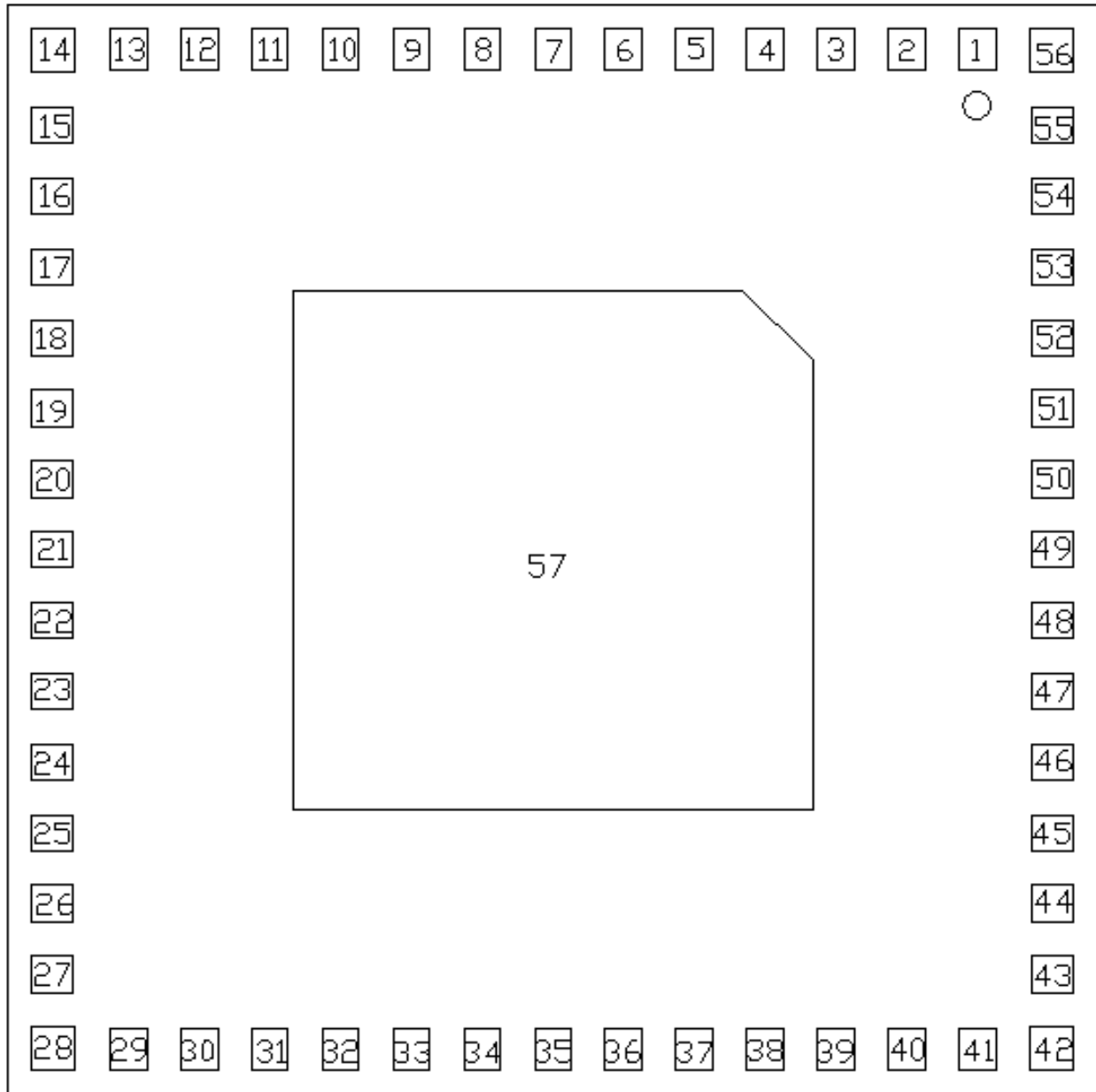

**Figure 2 TiWi-C-W Pinout (Top View)**

## PIN DESCRIPTIONS

Module Pin	Name	I/O Type	Description
1	GND	GND	GROUND
2	VCC	PI	POWER TO MODULE (3.13-3.46 VDC)
3	GND	GND	GROUND
4	RESET_N	DI	ACTIVE LOW RESET INPUT. MUST BE PULLED UP TO VCC WITH A 10k OHM RESISTOR.
5	GPIO_A11	DIO	GPIO A11
6	FLASH_OVERRIDE	DIO	INTERNAL FLASH PROGRAMMING OVERRIDE. CAN BE USED TO ASSIST IN A FORCED FLASH ERASE. SHOULD BE BROUGHT TO AND EXTERNAL PAD OR PIN.
7	OSC_32K_OUT	DO	32.768 kHz OSCILLATOR OUTPUT
8	VCC_OSC	PI	POWER TO 32.768 kHz OSCILLATOR (3.13-3.46 VDC)
9	GND	GND	GROUND
10	ANTENNA 1	RF	ANTENNA 1, 50 OHMS, SECONDARY RX ANTENNA
11	GND	GND	GROUND
12	GPIO_A10	DIO	GPIO A10
13	GND	GND	GROUND
14	ANTENNA 0	RF	ANTENNA 0, 50 OHMS, TX AND PRIMARY RX ANTENNA
15	GND	GND	GROUND
16	I2S_WS_UART2_TXD_A7	DIO	UART2 TRANSMIT DATA OUTPUT / GPIO A7
17	I2S_WS_UART2_RXD_A9	DIO	UART 2 RECEIVE DATA INPUT / GPIO A9
18	GPIO_A8	DIO	GPIO A8
19	GPIO_A6	DIO	GPIO A6
20	GND	GND	GROUND
21	UART1_CTS_N_A1	DIO	UART 1 ACTIVE LOW CLEAR-TO-SEND / GPIO A1
22	UART1_RXD	DI	UART 1 RECEIVE DATA INPUT
23	UART1_RTS_N_A0	DIO	UART 1 ACTIVE LOW REQUEST-TO-SEND / GPIO A0
24	UART1_TXD	DO	UART 1 TRANSMIT DATA OUTPUT
25	GND	GND	GROUND
26	VCC	PI	POWER TO MODULE (3.13-3.46 VDC)
27	GND	GND	GROUND
28	JTAG_TCK_A3	DIO	APPS JTAG TCK / GPIO A3

The information in this document is subject to change without notice.



Module Pin	Name	I/O Type	Description
29	JTAG_TDO_A5	DIO	APPS JTAG TDO / GPIO A5
30	JTAG_TMS_A2	DIO	APPS JTAG TMS / GPIO A2
31	JTAG_TDI_A4	DIO	APPS JTAG TDI / GPIO A4
32	WRF_GPIO_OUT	DIO	
33	UART4_TXD	DO	UART 4 TRANSMIT DATA OUTPUT
34	UART4_RXD	DI	UART 4 RECEIVE DATA INPUT
35	NC	-	NO CONNECT (DO NOT CONNECT)
36	NC	-	NO CONNECT (DO NOT CONNECT)
37	CLK_IN	-	UNUSED CLOCK IN. CONNECT TO GND THROUGH 1k OHM RESISTOR.
38	NC	-	NO CONNECT (DO NOT CONNECT)
39	NC	-	NO CONNECT (DO NOT CONNECT)
40	NC	-	NO CONNECT (DO NOT CONNECT)
41	GPIO_B2	DIO	GPIO B2
42	GPIO_B3	DIO	GPIO B3
43	GPIO_B5	DIO	GPIO B5
44	GPIO_B6	DIO	GPIO B6
45	GPIO_B4	DIO	GPIO B4
46	GND	GND	GROUND
47	VCC	PI	POWER TO MODULE (3.13-3.46 VDC)
48	GND	GND	GROUND
49	GPIO_B0	DIO	GPIO B0
50	GPIO_B1	DIO	GPIO B1
51	GPIO_B9	DIO	GPIO B9
52	GPIO_B10	DIO	GPIO B10
53	GPIO_B11	DIO	GPIO B11
54	GPIO_B8	DIO	GPIO B8
55	GPIO_B7	DIO	GPIO B7
56	GND	GND	GROUND
57	GND	GND	GROUND

PI = Power Input DI = Digital Input DO = Digital Output DIO = Bi-directional Digital Port RF = Bi-directional RF Port GND=Ground

**Table 3 TiWi-C-W Module Pin Descriptions**

The information in this document is subject to change without notice.

**ELECTRICAL SPECIFICATIONS**

**Absolute Maximum Ratings**

Parameter	Min	Max	Unit
Power supply voltage (VCC)	0	3.46	V
Oscillator power supply voltage (VCC_OSC)	0	3.46	V
Power supply voltage ripple	-2	+2	%
Voltage on digital pins	-0.5	VCC + 0.5	V
RF input power, antenna port		+10	dBm
Operating temperature	-40	+85	°C
Storage temperature	-40	+85	°C

**Table 4 Absolute Maximum Ratings**

**Recommended Operating Conditions**

Parameter	Min	Typical	Max	Unit
VCC	3.13	3.30	3.46	V
VCC_OSC	3.13	3.30	3.46	V
Voltage on digital pins	0	3.3	VCC	V
Ambient temperature range	-40	25	85	°C

**Table 5 Recommended Operating Conditions**

## General Characteristics

### DC Characteristics – General Purpose I/O

Parameter	Test Conditions	Min	Typical	Max	Unit
Logic input low, $V_{IL}$		0	-	0.8	V
Logic input high, $V_{IH}$		2.0	-	VCC	V
Logic output low, $V_{OL}$	12mA	0	-	0.8	V
Logic output high, $V_{OH}$	12mA	2.3	-	VCC	V

**Table 6 DC Characteristics General Purpose I/O**

### RF Characteristics

Parameter	Min	Typical	Max	Unit
RF frequency range	2412		2472	MHz
RF data rate	1	802.11 b/g/n rates supported	54	Mbps

**Table 7 RF Characteristics**

**Power Consumption**

Parameter	Test Conditions	Min	Typical	Max	Unit
11b TX Current	11 Mbps, T <sub>amb</sub> = +25°C, 3.3V	-	310	360	mA
11g TX Current	6 Mbps, T <sub>amb</sub> = +25°C, 3.3V	-	280	320	mA
11g TX Current	54 Mbps, T <sub>amb</sub> = +25°C, 3.3V	-	230	280	mA
11n TX Current	MCS0, T <sub>amb</sub> = +25°C, 3.3V	-	260	310	mA
11n TX Current	MCS7, T <sub>amb</sub> = +25°C, 3.3V	-	220	270	mA
11b RX Current	11 Mbps, T <sub>amb</sub> = +25°C, 3.3V	-	65	-	mA
11g RX Current	54 Mbps, T <sub>amb</sub> = +25°C, 3.3V	-	65	-	mA
11n RX Current	MCS7, T <sub>amb</sub> = +25°C, 3.3V	-	65	-	mA
Power Down Mode		-		-	uA

**Table 8 WLAN Power Consumption**

**Power Supply Requirements**

Parameter	Min	Typical	Max	Unit
VCC	3.13	3.30	3.46	V
Supply Current	-	800	-	mA

**Table 9 Power Supply Requirements**

Although the Max continuous supply current to the module is >360 mA, when providing power to the module, a power source capable of supplying 800 mA peak current for a duration of ~30 mSec is required by the module transmitter during calibration.

Module calibration occurs:

- (1) When the Module is initially powered up.
- (2) The module is reset.
- (3) When the radio is initialized.
- (4) Every 2 minutes after the radio is initialized.

Note: Radio calibration will not occur while the module is in modes Doze, Deep Sleep, Power Down or if the radio is not initialized.

**Figure 3** shows the current profile of the TiWi-C-W module during calibration. If current is limited to <800mA during this process, the module will fail to calibrate.

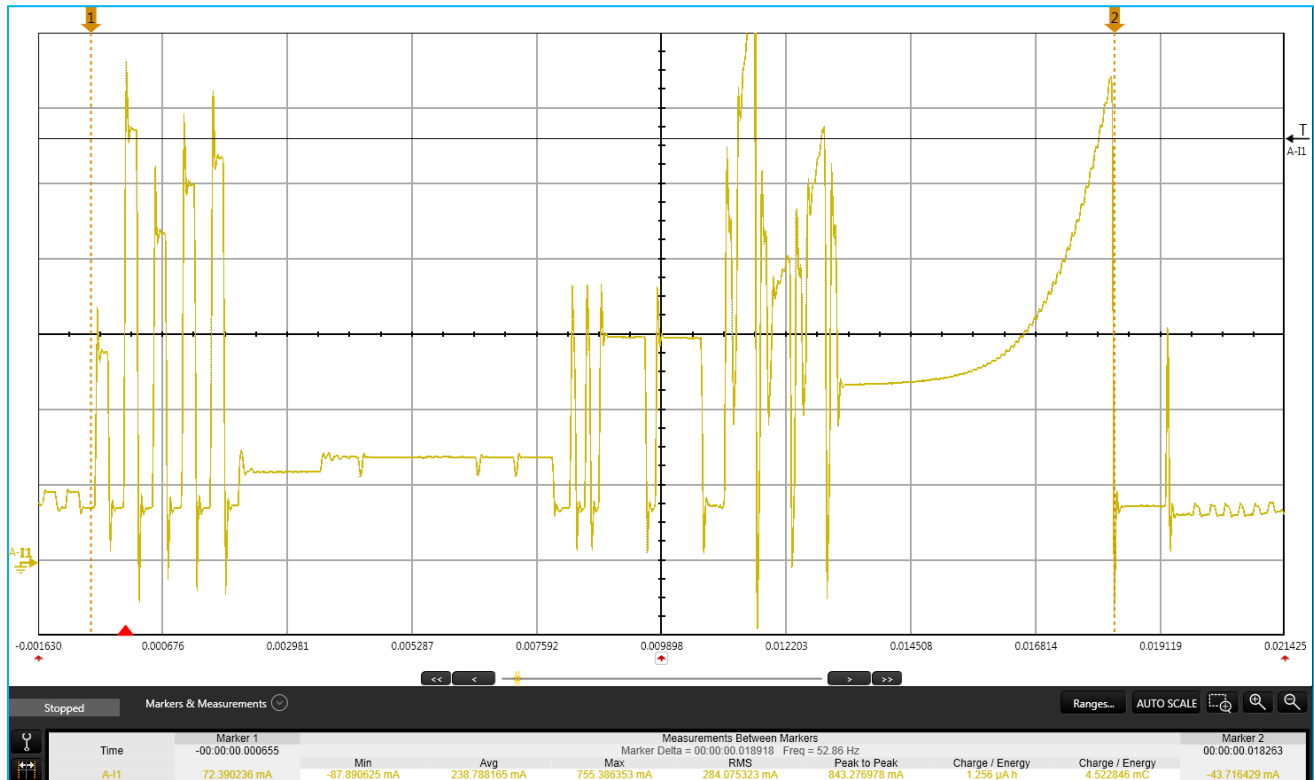

**Figure 3 Module RF Calibration Current Profile**

The information in this document is subject to change without notice.

**RF Characteristics**
**WLAN Transmitter Characteristics  
(TA = +25°C, VCC = 3.3 V)**

Parameter	Test Conditions	Min	Typ	Max	Unit
1 Mbps DSSS (b) TX Output Power	1 Mbps BPSK 802.11(b) Mask Compliance 35% EVM RMS power over TX packet	-	19.0	-	dBm
2 Mbps DSSS (b) TX Output Power	2 Mbps QPSK 802.11(b) Mask Compliance 35% EVM RMS power over TX packet	-	19.0	-	dBm
5.5 Mbps DSSS (b) TX Output Power	5.5 Mbps QPSK 802.11(b) Mask Compliance 35% EVM RMS power over TX packet	-	19.0	-	dBm
11 Mbps DSSS (b) TX Output Power	11 Mbps CCK 802.11(b) Mask Compliance 35% EVM RMS power over TX packet	-	19.0	-	dBm
6 Mbps OFDM (g) TX Output Power	6 Mbps BPSK 802.11(g) Mask Compliance -5 dB EVM RMS power over TX packet	-	17.5	-	dBm
9 Mbps OFDM (g) TX Output Power	9 Mbps BPSK 802.11(g) Mask Compliance -8 dB EVM RMS power over TX packet	-	17.5	-	dBm
12 Mbps OFDM (g) TX Output Power	12 Mbps QPSK 802.11(g) Mask Compliance -10 dB EVM RMS power over TX packet	-	17.5	-	dBm
18 Mbps OFDM (g) TX Output Power	18 Mbps QPSK 802.11(g) Mask Compliance -13 dB EVM RMS power over TX packet	-	17.5	-	dBm
24 Mbps OFDM (g) TX Output Power	24 Mbps 16-QAM 802.11(g) Mask Compliance -16 dB EVM RMS power over TX packet	-	15.8	-	dBm
36 Mbps OFDM (g) TX Output Power	36 Mbps 16-QAM 802.11(g) Mask Compliance -19 dB EVM RMS power over TX packet	-	15.8	-	dBm
48 Mbps OFDM (g) TX Output Power	48 Mbps 64-QAM 802.11(g) Mask Compliance -22 dB EVM RMS power over TX packet	-	15.8	-	dBm
54 Mbps OFDM (g) TX Output Power	54 Mbps 64-QAM 802.11(g) Mask Compliance -25 dB EVM RMS power over TX packet	-	15.8	-	dBm
MCS0 OFDM (n) TX Output Power	6.5 Mbps BPSK 802.11(n) Mask Compliance -5 dB EVM RMS power over TX packet	-	15.5	-	dBm
MCS1 OFDM (n) TX Output Power	13 Mbps QPSK 802.11(n) Mask Compliance -10 dB EVM RMS power over TX packet	-	15.5	-	dBm
MCS2 OFDM (n) TX Output Power	19.5 Mbps QPSK 802.11(n) Mask Compliance -13 dB EVM RMS power over TX packet	-	15.5	-	dBm
MCS3 OFDM (n) TX Output Power	26 Mbps 16-QAM 802.11(n) Mask Compliance -16 dB EVM RMS power over TX packet	-	15.0	-	dBm
MCS4 OFDM (n) TX Output Power	39 Mbps 16-QAM 802.11(n) Mask Compliance -19 dB EVM RMS power over TX packet	-	15.0	-	dBm
MCS5 OFDM (n) TX Output Power	52 Mbps 64-QAM 802.11(n) Mask Compliance -22 dB EVM RMS power over TX packet	-	15.0	-	dBm
MCS6 OFDM (n) TX Output Power	58.5 Mbps 64-QAM 802.11(n) Mask Compliance -25 dB EVM RMS power over TX packet	-	15.0	-	dBm
MCS7 OFDM (n) TX Output Power	65 Mbps 64-QAM 802.11(n) Mask Compliance -27 dB EVM RMS power over TX packet	-	15.0	-	dBm

**Table 10 WLAN Transmitter RF Characteristics**

The information in this document is subject to change without notice.

**WLAN Transmitter Characteristics**  
(TA = +85°C, VCC = 3.3 V)

Parameter	Test Conditions	Min	Typ	Max	Unit
1 Mbps DSSS (b) TX Output Power	1 Mbps BPSK 802.11(b) Mask Compliance 35% EVM RMS power over TX packet	-	19.0	-	dBm
2 Mbps DSSS (b) TX Output Power	2 Mbps QPSK 802.11(b) Mask Compliance 35% EVM RMS power over TX packet	-	19.0	-	dBm
5.5 Mbps DSSS (b) TX Output Power	5.5 Mbps QPSK 802.11(b) Mask Compliance 35% EVM RMS power over TX packet	-	19.0	-	dBm
11 Mbps DSSS (b) TX Output Power	11 Mbps CCK 802.11(b) Mask Compliance 35% EVM RMS power over TX packet	-	19.0	-	dBm
6 Mbps OFDM (g) TX Output Power	6 Mbps BPSK 802.11(g) Mask Compliance -5 dB EVM RMS power over TX packet	-	17.6	-	dBm
9 Mbps OFDM (g) TX Output Power	9 Mbps BPSK 802.11(g) Mask Compliance -8 dB EVM RMS power over TX packet	-	17.6	-	dBm
12 Mbps OFDM (g) TX Output Power	12 Mbps QPSK 802.11(g) Mask Compliance -10 dB EVM RMS power over TX packet	-	17.6	-	dBm
18 Mbps OFDM (g) TX Output Power	18 Mbps QPSK 802.11(g) Mask Compliance -13 dB EVM RMS power over TX packet	-	17.6	-	dBm
24 Mbps OFDM (g) TX Output Power	24 Mbps 16-QAM 802.11(g) Mask Compliance -16 dB EVM RMS power over TX packet	-	15.8	-	dBm
36 Mbps OFDM (g) TX Output Power	36 Mbps 16-QAM 802.11(g) Mask Compliance -19 dB EVM RMS power over TX packet	-	15.8	-	dBm
48 Mbps OFDM (g) TX Output Power	48 Mbps 64-QAM 802.11(g) Mask Compliance -22 dB EVM RMS power over TX packet	-	15.8	-	dBm
54 Mbps OFDM (g) TX Output Power	54 Mbps 64-QAM 802.11(g) Mask Compliance -25 dB EVM RMS power over TX packet	-	15.8	-	dBm
MCS0 OFDM (n) TX Output Power	6.5 Mbps BPSK 802.11(n) Mask Compliance -5 dB EVM RMS power over TX packet	-	15.5	-	dBm
MCS1 OFDM (n) TX Output Power	13 Mbps QPSK 802.11(n) Mask Compliance -10 dB EVM RMS power over TX packet	-	15.5	-	dBm
MCS2 OFDM (n) TX Output Power	19.5 Mbps QPSK 802.11(n) Mask Compliance -13 dB EVM RMS power over TX packet	-	15.5	-	dBm
MCS3 OFDM (n) TX Output Power	26 Mbps 16-QAM 802.11(n) Mask Compliance -16 dB EVM RMS power over TX packet	-	15.0	-	dBm
MCS4 OFDM (n) TX Output Power	39 Mbps 16-QAM 802.11(n) Mask Compliance -19 dB EVM RMS power over TX packet	-	15.0	-	dBm
MCS5 OFDM (n) TX Output Power	52 Mbps 64-QAM 802.11(n) Mask Compliance -22 dB EVM RMS power over TX packet	-	15.0	-	dBm
MCS6 OFDM (n) TX Output Power	58.5 Mbps 64-QAM 802.11(n) Mask Compliance -25 dB EVM RMS power over TX packet	-	15.0	-	dBm
MCS7 OFDM (n) TX Output Power	65 Mbps 64-QAM 802.11(n) Mask Compliance -27 dB EVM RMS power over TX packet	-	15.0	-	dBm

**Table 11 WLAN Transmitter RF Characteristics**

The information in this document is subject to change without notice.

**WLAN Transmitter Characteristics  
(TA = -40°C, VCC = 3.3 V)**

Parameter	Test Conditions	Min	Typ	Max	Unit
1 Mbps DSSS (b) TX Output Power	1 Mbps BPSK 802.11(b) Mask Compliance 35% EVM RMS power over TX packet	-	18.6	-	dBm
2 Mbps DSSS (b) TX Output Power	2 Mbps QPSK 802.11(b) Mask Compliance 35% EVM RMS power over TX packet	-	18.6	-	dBm
5.5 Mbps DSSS (b) TX Output Power	5.5 Mbps QPSK 802.11(b) Mask Compliance 35% EVM RMS power over TX packet	-	18.6	-	dBm
11 Mbps DSSS (b) TX Output Power	11 Mbps CCK 802.11(b) Mask Compliance 35% EVM RMS power over TX packet	-	18.6	-	dBm
6 Mbps OFDM (g) TX Output Power	6 Mbps BPSK 802.11(g) Mask Compliance -5 dB EVM RMS power over TX packet	-	17.0	-	dBm
9 Mbps OFDM (g) TX Output Power	9 Mbps BPSK 802.11(g) Mask Compliance -8 dB EVM RMS power over TX packet	-	17.0	-	dBm
12 Mbps OFDM (g) TX Output Power	12 Mbps QPSK 802.11(g) Mask Compliance -10 dB EVM RMS power over TX packet	-	17.0	-	dBm
18 Mbps OFDM (g) TX Output Power	18 Mbps QPSK 802.11(g) Mask Compliance -13 dB EVM RMS power over TX packet	-	17.0	-	dBm
24 Mbps OFDM (g) TX Output Power	24 Mbps 16-QAM 802.11(g) Mask Compliance -16 dB EVM RMS power over TX packet	-	15.5	-	dBm
36 Mbps OFDM (g) TX Output Power	36 Mbps 16-QAM 802.11(g) Mask Compliance -19 dB EVM RMS power over TX packet	-	15.5	-	dBm
48 Mbps OFDM (g) TX Output Power	48 Mbps 64-QAM 802.11(g) Mask Compliance -22 dB EVM RMS power over TX packet	-	15.5	-	dBm
54 Mbps OFDM (g) TX Output Power	54 Mbps 64-QAM 802.11(g) Mask Compliance -25 dB EVM RMS power over TX packet	-	15.5	-	dBm
MCS0 OFDM (n) TX Output Power	6.5 Mbps BPSK 802.11(n) Mask Compliance -5 dB EVM RMS power over TX packet	-	15.0	-	dBm
MCS1 OFDM (n) TX Output Power	13 Mbps QPSK 802.11(n) Mask Compliance -10 dB EVM RMS power over TX packet	-	15.0	-	dBm
MCS2 OFDM (n) TX Output Power	19.5 Mbps QPSK 802.11(n) Mask Compliance -13 dB EVM RMS power over TX packet	-	15.0	-	dBm
MCS3 OFDM (n) TX Output Power	26 Mbps 16-QAM 802.11(n) Mask Compliance -16 dB EVM RMS power over TX packet	-	14.7	-	dBm
MCS4 OFDM (n) TX Output Power	39 Mbps 16-QAM 802.11(n) Mask Compliance -19 dB EVM RMS power over TX packet	-	14.7	-	dBm
MCS5 OFDM (n) TX Output Power	52 Mbps 64-QAM 802.11(n) Mask Compliance -22 dB EVM RMS power over TX packet	-	14.7	-	dBm
MCS6 OFDM (n) TX Output Power	58.5 Mbps 64-QAM 802.11(n) Mask Compliance -25 dB EVM RMS power over TX packet	-	14.7	-	dBm
MCS7 OFDM (n) TX Output Power	65 Mbps 64-QAM 802.11(n) Mask Compliance -27 dB EVM RMS power over TX packet	-	14.7	-	dBm

**Table 12 WLAN Transmitter RF Characteristics**

The information in this document is subject to change without notice.



**WLAN Receiver Characteristics  
(TA = +25°C, VCC = 3.10V, 3.30V, & 3.46V)**

Parameter	Test Conditions	Min	Typ	Max	Unit
1 Mbps DSSS (b) RX Sensitivity	8% PER	-	-90	-	dBm
2 Mbps DSSS (b) RX Sensitivity	8% PER	-	-90	-	dBm
5.5 Mbps DSSS (b) RX Sensitivity	8% PER	-	-89	-	dBm
11 Mbps DSSS (b) RX Sensitivity	8% PER	-	-87	-	dBm
6 Mbps OFDM (g) RX Sensitivity	10% PER	-	-90	-	dBm
9 Mbps OFDM (g) RX Sensitivity	10% PER	-	-89	-	dBm
12 Mbps OFDM (g) RX Sensitivity	10% PER	-	-85	-	dBm
18 Mbps OFDM (g) RX Sensitivity	10% PER	-	-84.5	-	dBm
24 Mbps OFDM (g) RX Sensitivity	10% PER	-	-82	-	dBm
36 Mbps OFDM (g) RX Sensitivity	10% PER	-	-79	-	dBm
48 Mbps OFDM (g) RX Sensitivity	10% PER	-	-75	-	dBm
54 Mbps OFDM (g) RX Sensitivity	10% PER	-	-73	-	dBm
MCS0 (6.5 Mbps) OFDM (n) RX Sensitivity	10% PER	-	-90	-	dBm
MCS1 (13 Mbps) OFDM (n) RX Sensitivity	10% PER	-	-87	-	dBm
MCS2 (19.5 Mbps) OFDM (n) RX Sensitivity	10% PER	-	-85	-	dBm
MCS3 26 Mbps OFDM (n) RX Sensitivity	10% PER	-	-82	-	dBm
MCS4 39 Mbps OFDM (n) RX Sensitivity	10% PER	-	-79	-	dBm
MCS5 52 Mbps OFDM (n) RX Sensitivity	10% PER	-	-74	-	dBm
MCS6 58.5 Mbps OFDM (n) RX Sensitivity	10% PER	-	-73	-	dBm
MCS7 65 Mbps OFDM (n) RX Sensitivity	10% PER	-	-71	-	dBm
11b RX Overload Level	8% PER, 11 Mbps	-10	-	-	dBm
11g RX Overload Level	10% PER, 54 Mbps	-20	-	-	dBm
11n RX Overload Level	10% PER, MCS7	-20	-	-	dBm

**Table 13 WLAN Receiver RF Characteristics**

The information in this document is subject to change without notice.

**WLAN Receiver Characteristics**  
(TA = +85°C, VCC = 3.10V, 3.30V, & 3.46V)

Parameter	Test Conditions	Min	Typ	Max	Unit
1 Mbps DSSS (b) RX Sensitivity	8% PER	-	-89	-	dBm
2 Mbps DSSS (b) RX Sensitivity	8% PER	-	-89	-	dBm
5.5 Mbps DSSS (b) RX Sensitivity	8% PER	-	-88	-	dBm
11 Mbps DSSS (b) RX Sensitivity	8% PER	-	-86	-	dBm
6 Mbps OFDM (g) RX Sensitivity	10% PER	-	-89	-	dBm
9 Mbps OFDM (g) RX Sensitivity	10% PER	-	-88	-	dBm
12 Mbps OFDM (g) RX Sensitivity	10% PER	-	-84	-	dBm
18 Mbps OFDM (g) RX Sensitivity	10% PER	-	-83.5	-	dBm
24 Mbps OFDM (g) RX Sensitivity	10% PER	-	-82	-	dBm
36 Mbps OFDM (g) RX Sensitivity	10% PER	-	-78	-	dBm
48 Mbps OFDM (g) RX Sensitivity	10% PER	-	-74	-	dBm
54 Mbps OFDM (g) RX Sensitivity	10% PER	-	-72	-	dBm
MCS0 (6.5 Mbps) OFDM (n) RX Sensitivity	10% PER	-	-89	-	dBm
MCS1 (13 Mbps) OFDM (n) RX Sensitivity	10% PER	-	-86	-	dBm
MCS2 (19.5 Mbps) OFDM (n) RX Sensitivity	10% PER	-	-84	-	dBm
MCS3 26 Mbps OFDM (n) RX Sensitivity	10% PER	-	-81	-	dBm
MCS4 39 Mbps OFDM (n) RX Sensitivity	10% PER	-	-78	-	dBm
MCS5 52 Mbps OFDM (n) RX Sensitivity	10% PER	-	-73	-	dBm
MCS6 58.5 Mbps OFDM (n) RX Sensitivity	10% PER	-	-72	-	dBm
MCS7 65 Mbps OFDM (n) RX Sensitivity	10% PER	-	-70	-	dBm
11b RX Overload Level	8% PER, 11 Mbps	-10	-	-	dBm
11g RX Overload Level	10% PER, 54 Mbps	-20	-	-	dBm
11n RX Overload Level	10% PER, MCS7	-20	-	-	dBm

**Table 14 WLAN Receiver RF Characteristics**

The information in this document is subject to change without notice.

**WLAN Receiver Characteristics**  
(TA = -40°C, VCC = 3.10V, 3.30V, & 3.46V)

Parameter	Test Conditions	Min	Typ	Max	Unit
1 Mbps DSSS (b) RX Sensitivity	8% PER	-	-91	-	dBm
2 Mbps DSSS (b) RX Sensitivity	8% PER	-	-91	-	dBm
5.5 Mbps DSSS (b) RX Sensitivity	8% PER	-	-90	-	dBm
11 Mbps DSSS (b) RX Sensitivity	8% PER	-	-88	-	dBm
6 Mbps OFDM (g) RX Sensitivity	10% PER	-	-91	-	dBm
9 Mbps OFDM (g) RX Sensitivity	10% PER	-	-90	-	dBm
12 Mbps OFDM (g) RX Sensitivity	10% PER	-	-86	-	dBm
18 Mbps OFDM (g) RX Sensitivity	10% PER	-	-85.5	-	dBm
24 Mbps OFDM (g) RX Sensitivity	10% PER	-	-83	-	dBm
36 Mbps OFDM (g) RX Sensitivity	10% PER	-	-80	-	dBm
48 Mbps OFDM (g) RX Sensitivity	10% PER	-	-76	-	dBm
54 Mbps OFDM (g) RX Sensitivity	10% PER	-	-74	-	dBm
MCS0 (6.5 Mbps) OFDM (n) RX Sensitivity	10% PER	-	-91	-	dBm
MCS1 (13 Mbps) OFDM (n) RX Sensitivity	10% PER	-	-88	-	dBm
MCS2 (19.5 Mbps) OFDM (n) RX Sensitivity	10% PER	-	-86	-	dBm
MCS3 26 Mbps OFDM (n) RX Sensitivity	10% PER	-	-83	-	dBm
MCS4 39 Mbps OFDM (n) RX Sensitivity	10% PER	-	-80	-	dBm
MCS5 52 Mbps OFDM (n) RX Sensitivity	10% PER	-	-75	-	dBm
MCS6 58.5 Mbps OFDM (n) RX Sensitivity	10% PER	-	-74	-	dBm
MCS7 65 Mbps OFDM (n) RX Sensitivity	10% PER	-	-72	-	dBm
11b RX Overload Level	8% PER, 11 Mbps	-10	-	-	dBm
11g RX Overload Level	10% PER, 54 Mbps	-20	-	-	dBm
11n RX Overload Level	10% PER, MCS7	-20	-	-	dBm

**Table 15 WLAN Receiver RF Characteristics**

The information in this document is subject to change without notice.

## UART HOST INTERFACE

The main interface to the TiWi-C-W Module is a Universal Asynchronous Receiver Transmitter (UART). This section describes the UART host interface.

### Overview

The UART is a standard TTL level 4-wire interface (RX, TX, RTS, and CTS) with support for baud rates from 9600 bps to 4.0 Mbps. Default parameters are 115200 baud, 8 data bits, no parity bits, 1 stop bit, hardware flow control disabled.

### UART Interface

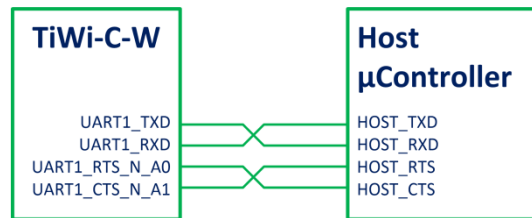

Figure 4 UART Connection from TiWi-C-W to Host

### UART Signal Description

Port Name	Input/Output	Description
UART1_TXD	DO	UART 1 TRANSMIT DATA OUTPUT
UART1_RXD	DI	UART 1 RECEIVE DATA INPUT
UART1_RTS_N_A0	DO	UART 1 ACTIVE LOW REQUEST-TO-SEND
UART1_CTS_N_A1	DI	UART 1 ACTIVE LOW CLEAR-TO-SEND

Table 16 UART Interface Signal Description

### UART TIMING

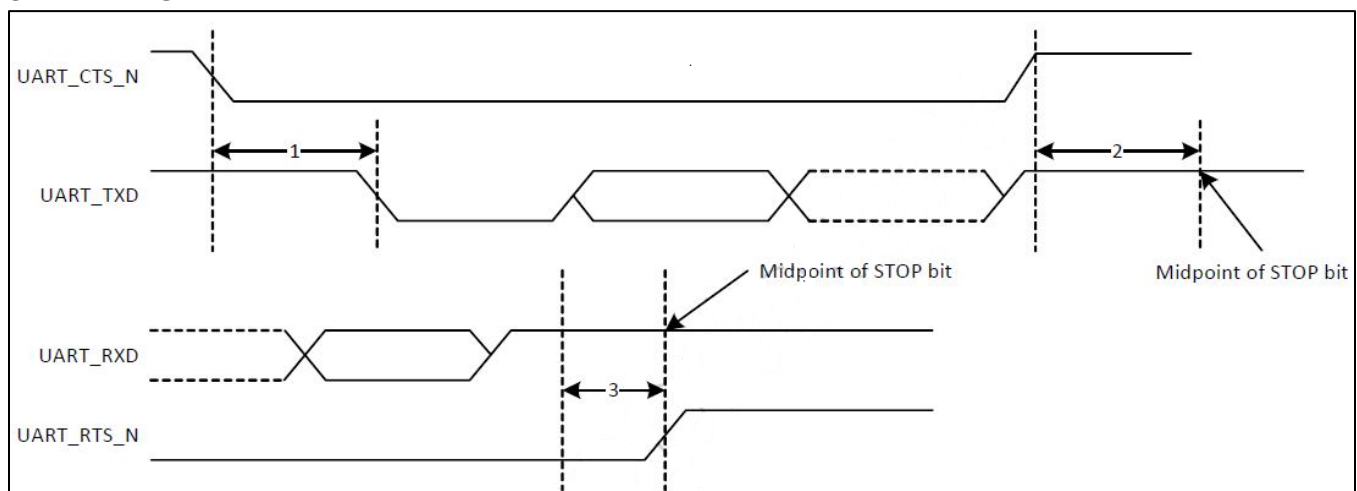

Figure 5 UART Timing

The information in this document is subject to change without notice.

**Soldering Recommendations**

**Reflow for Lead Free Solder Paste**

- Optimal solder reflow profile depends on solder paste properties and should be optimized as part of an overall process development.
- It is important to provide a solder reflow profile that matches the solder paste supplier's recommendations.
- Temperature ranges beyond that of the solder paste supplier's recommendation could result in poor solderability.
- All solder paste suppliers recommend an ideal reflow profile to give the best solderability.

**Recommended Reflow Profile for Lead Free Solder**

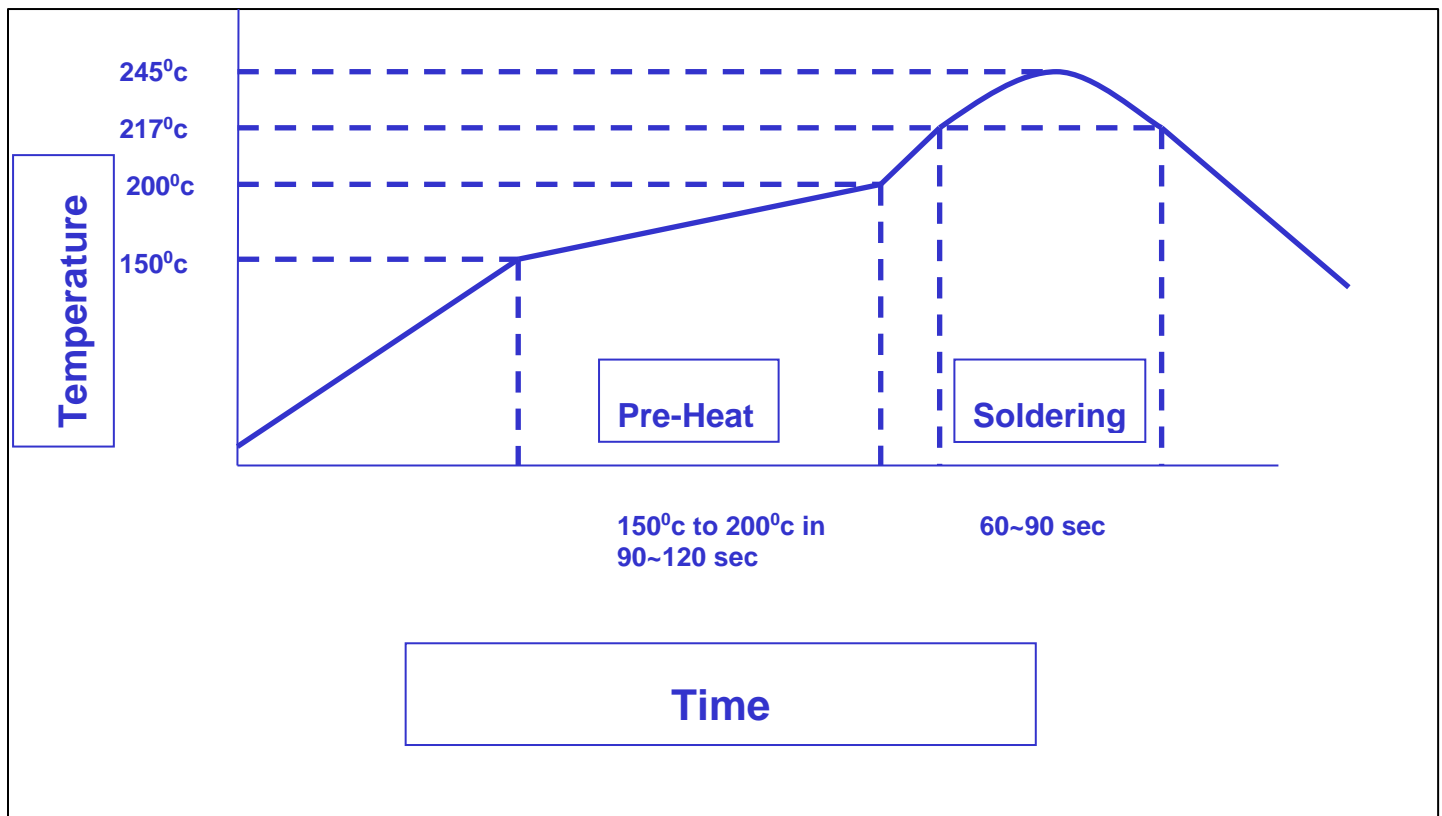

**Figure 6 Recommended Soldering Profile**

**Note:** The quality of solder joints on the surface mount pads where they contact the host board should meet the appropriate IPC Specification. See IPC-A-610-D Acceptability of Electronic Assemblies, section 8.2.1 “Bottom Only Terminations.”

## CLEANING

In general, cleaning the populated modules is strongly discouraged. Residuals under the module cannot be easily removed with any cleaning process.

- Cleaning with water can lead to capillary effects where water is absorbed into the gap between the host board and the module. The combination of soldering flux residuals and encapsulated water could lead to short circuits between neighboring pads. Water could also damage any stickers or labels.
- Cleaning with alcohol or a similar organic solvent will likely flood soldering flux residuals into the RF shield, which is not accessible for post-washing inspection. The solvent could also damage any stickers or labels.
- Ultrasonic cleaning could damage the module permanently.

## OPTICAL INSPECTION

After soldering the Module to the host board, consider optical inspection to check the following:

- Proper alignment and centering of the module over the pads.
- Proper solder joints on all pads.
- Excessive solder or contacts to neighboring pads, or vias.

## REWORK

The TiWi-C-W module can be unsoldered from the host board if the Moisture Sensitivity Level (MSL) requirements are met as described in this datasheet.

**Never attempt a rework on the module itself, e.g. replacing individual components. Such actions will terminate warranty coverage.**

## SHIPPING, HANDLING, AND STORAGE

### Shipping

Bulk orders of the TiWi-C-W modules are delivered in reels of 2000.

### Handling

The TiWi-C-W modules contain a highly sensitive electronic circuitry. Handling without proper ESD protection may damage the module permanently.

### Moisture Sensitivity Level (MSL)

Per J-STD-020, devices rated as MSL 3 and not stored in a sealed bag with desiccant pack should be baked prior to use.

Devices are packaged in a Moisture Barrier Bag with a desiccant pack and Humidity Indicator Card (HIC). Devices that will be subjected to reflow should reference the HIC and J-STD-033 to determine if baking is required.

If baking is required, refer to J-STD-033 for bake procedure.

### Storage

Per J-STD-033, the shelf life of devices in a Moisture Barrier Bag is 12 months at <40°C and <90% room humidity (RH).

Do not store in salty air or in an environment with a high concentration of corrosive gas, such as Cl<sub>2</sub>, H<sub>2</sub>S, NH<sub>3</sub>, SO<sub>2</sub>, or NO<sub>x</sub>.

Do not store in direct sunlight.

The product should not be subject to excessive mechanical shock.

---

## Repeating Reflow Soldering

Only a single reflow soldering process is encouraged for host boards.

---

## AGENCY CERTIFICATIONS

FCC ID: TFB-1001, 15.247

IC ID: 5969A-1001, RSS 210

CE: Compliant to standards EN 60950-1, EN 300 328, and EN 301 489

## AGENCY STATEMENTS

### Federal Communication Commission Interference Statement

This equipment has been tested and found to comply with the limits for a Class B digital device, pursuant to Part 15 of the FCC Rules. These limits are designed to provide reasonable protection against harmful interference in a residential installation. This equipment generates uses and can radiate radio frequency energy and, if not installed and used in accordance with the instructions, may cause harmful interference to radio communications. However, there is no guarantee that interference will not occur in a particular installation. If this equipment does cause harmful interference to radio or television reception, which can be determined by turning the equipment off and on, the user is encouraged to try to correct the interference by one of the following measures:

- Reorient or relocate the receiving antenna.
- Increase the separation between the equipment and receiver.
- Connect the equipment into an outlet on a circuit different from that to which the receiver is connected.
- Consult the dealer or an experienced radio/TV technician for help.

This device complies with Part 15 of the FCC Rules. Operation is subject to the following two conditions: (1) This device may not cause harmful interference, and (2) this device must accept any interference received, including interference that may cause undesired operation.

**FCC CAUTION:** Any changes or modifications not expressly approved by the party responsible for compliance could void the user's authority to operate this equipment.



## Industry Canada Statements

This Device complies with Industry Canada License-exempt RSS standard(s). Operation is subject to the following two conditions: (1) this device may not cause interference, and (2) this device must accept any interference, including interference that may cause undesired operation of the device.

To reduce potential radio interference to other users, the antenna type and its gain should be so chosen that the equivalent isotropically radiated power (e.i.r.p.) is not more than that permitted for successful communication.

This device has been designed to operate with the antenna(s) listed below and having a maximum gain of 2.0 dBi (LSR Dipole), 2.0 dBi (LSR FlexPIFA), 2.0 dBi (LSR mFlexPIFA), and 0.5dBi (Johanson Chip). Antennas not included in this list or having a gain greater than 2.0 dBi, 2.0 dBi, 2.0 dBi, and 0.5dBi are strictly prohibited for use with this device. The required antenna impedance is 50 ohms.

List of all Antennas Acceptable for use with the Transmitter

- 1) LSR 001-0001 2.4 GHz center-fed dipole antenna and LSR 080-0001 U.FL to Reverse Polarity SMA connector cable.
- 2) LSR 001-0014 2.4 GHz FlexPIFA antenna.
- 3) LSR 001-0030 2.4 GHz Metal FlexPIFA (mFlexPIFA) antenna.
- 4) Johanson 2450AT18A100 chip antenna.

Cet appareil est conforme avec Industrie Canada , exempts de licence standard RSS (s). L'opération est soumise aux deux conditions suivantes: (1) cet appareil ne peut pas provoquer d'interférences et (2) cet appareil doit accepter toute interférence, y compris les interférences qui peuvent causer un mauvais fonctionnement de l'appareil.

Pour réduire le risque d'interférence aux autres utilisateurs, le type d'antenne et son gain doivent être choisis de manière que la puissance isotrope rayonnée équivalente (PIRE) ne dépasse pas celle permise pour une communication réussie.

Cet appareil a été conçu pour fonctionner avec l'antenne (s) ci-dessous, et ayant un gain maximum de 2,0 dBi (LSR Dipole), 2.0 dBi (LSR FlexPIFA), 2.0 dBi (LSR mFlexPIFA), et 0.5dBi (Johanson Chip). Antennes pas inclus dans cette liste ou présentant un gain supérieure à 2,0 dBi, 2.0 dBi, 2.0 dBi, et 0.5dBi sont strictement interdits pour une utilisation avec cet appareil. L'impédance d'antenne requise est de 50 ohms.

Liste de toutes les antennes acceptables pour une utilisation avec l'émetteur

- 1) Antenne LSR 001-0001 2.4 GHz de centre-dipôle alimenté et LSR 080-0001 U.FL inverser câble connecteur SMA à polarité.
- 2) LSR 001-0014 antenne FlexPIFA 2,4 GHz.
- 3) LSR 001-0030 antenne Métal FlexPIFA (mFlexPIFA) 2,4 GHz.
- 4) Antenne de puce Johanson 2450AT18A100.

## OEM RESPONSIBILITIES TO COMPLY WITH FCC AND INDUSTRY CANADA REGULATIONS

The TiWi-C-W Module has been certified for integration into products only by OEM integrators under the following conditions:

This device is granted for use in Mobile only configurations in which the antennas used for this transmitter must be installed to provide a separation distance of at least 20cm from all person and not be co-located with any other transmitters except in accordance with FCC and Industry Canada multi-transmitter product procedures.

As long as the two conditions above are met, further transmitter testing will not be required. However, the OEM integrator is still responsible for testing their end-product for any additional compliance requirements required with this module installed (for example, digital device emissions, PC peripheral requirements, etc.).

**IMPORTANT NOTE: In the event that these conditions cannot be met (for certain configurations or co-location with another transmitter), then the FCC and Industry Canada authorizations are no longer considered valid and the FCC ID and IC Certification Number cannot be used on the final product. In these circumstances, the OEM integrator will be responsible for re-evaluating the end product (including the transmitter) and obtaining a separate FCC and Industry Canada authorization.**

Le module de TiWi-C-W a été certifié pour l'intégration dans des produits uniquement par des intégrateurs OEM dans les conditions suivantes:

Ce dispositif est accordé pour une utilisation dans des configurations mobiles seul dans lequel les antennes utilisées pour cet émetteur doit être installé pour fournir une distance de séparation d'au moins 20cm de toute personne et ne pas être colocalisés avec les autres émetteurs, sauf en conformité avec la FCC et de l'Industrie Canada, multi-émetteur procédures produit.

Tant que les deux conditions précitées sont réunies, les tests de transmetteurs supplémentaires ne seront pas tenus. Toutefois, l'intégrateur OEM est toujours responsable de tester leur produit final pour toutes les exigences de conformité supplémentaires requis avec ce module installé (par exemple, les émissions appareil numérique, les exigences de périphériques PC, etc.)

**NOTE IMPORTANTE: Dans le cas où ces conditions ne peuvent être satisfaites (pour certaines configurations ou de co-implantation avec un autre émetteur), puis la FCC et Industrie autorisations Canada ne sont plus considérés comme valides et l'ID de la FCC et IC numéro de certification ne peut pas être utilisé sur la produit final. Dans ces circonstances, l'intégrateur OEM sera chargé de réévaluer le produit final (y compris l'émetteur) et l'obtention d'un distincte de la FCC et Industrie Canada l'autorisation.**

---

## OEM LABELING REQUIREMENTS FOR END-PRODUCT

The TiWi-C-W module is labeled with its own FCC ID and IC Certification Number. The FCC ID and IC certification numbers are not visible when the module is installed inside another device, as such the end device into which the module is installed must display a label referring to the enclosed module. The final end product must be labeled in a visible area with the following:

**“Contains Transmitter Module FCC ID: TFB-1001”**

**“Contains Transmitter Module IC: 5969A-1001”**

or

**“Contains FCC ID: TFB-1001”**

**“Contains IC: 5969A-1001”**

The OEM of the TiWi-C-W Module must only use the approved antenna(s) listed above, which have been certified with this module.

Le module de TiWi-C-W est étiqueté avec son propre ID de la FCC et IC numéro de certification. L'ID de la FCC et IC numéros de certification ne sont pas visibles lorsque le module est installé à l'intérieur d'un autre appareil, comme par exemple le terminal dans lequel le module est installé doit afficher une étiquette faisant référence au module ci-joint. Le produit final doit être étiqueté dans un endroit visible par le suivant:

**“Contient Module émetteur FCC ID: TFB-1001”**

**“Contient Module émetteur IC: 5969A-1001”**

ou

**“Contient FCC ID: TFB-1001”**

**“Contient IC: 5969A-1001”**

Les OEM du module TiWi-C-W ne doit utiliser l'antenne approuvée (s) ci-dessus, qui ont été certifiés avec ce module.

---

## OEM END PRODUCT USER MANUAL STATEMENTS

The OEM integrator should not provide information to the end user regarding how to install or remove this RF module or change RF related parameters in the user manual of the end product.

**The user manual for the end product must include the following information in a prominent location:**

This device is granted for use in Mobile only configurations in which the antennas used for this transmitter must be installed to provide a separation distance of at least 20cm from all person and not be co-located with any other transmitters except in accordance with FCC and Industry Canada multi-transmitter product procedures.

Other user manual statements may apply.

L'intégrateur OEM ne devraient pas fournir des informations à l'utilisateur final sur la façon d'installer ou de supprimer ce module RF ou modifier les paramètres liés RF dans le manuel utilisateur du produit final.

**Le manuel d'utilisation pour le produit final doit comporter les informations suivantes dans un endroit bien en vue:**

Ce dispositif est accordé pour une utilisation dans des configurations mobiles seule dans laquelle les antennes utilisées pour cet émetteur doit être installé pour fournir une distance de séparation d'au moins 20cm de toute personne et ne pas être co-localisés avec les autres émetteurs, sauf en conformité avec FCC et Industrie Canada, multi-émetteur procédures produit.

Autres déclarations manuel de l'utilisateur peuvent s'appliquer.

## EUROPE

### CE Notice

This device has been tested and certified for use in the European Union. See the Declaration of Conformity (DOC) for specifics.

If this device is used in a product, the OEM has responsibility to verify compliance of the final product to the EU standards. A Declaration of Conformity must be issued and kept on file as described in the Radio and Telecommunications Terminal Equipment (R&TTE) Directive.

The 'CE' mark must be placed on the OEM product per the labeling requirements of the Directive.

### Declaration of Conformity (DOC)

This DOC can be downloaded from the LSR Wiki.

**MECHANICAL DATA**

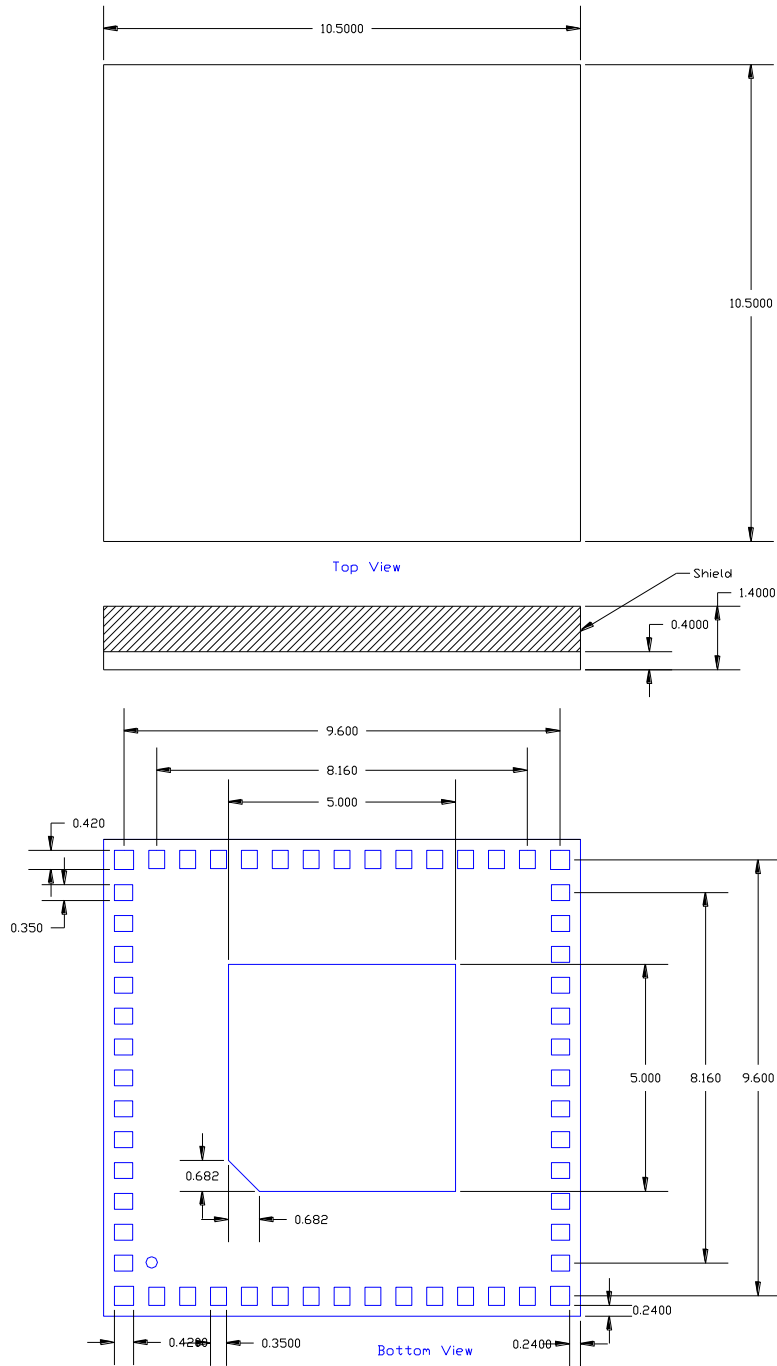

**Figure 7 Module Mechanical Dimensions (Maximum Module Height = 1.40mm)**

The information in this document is subject to change without notice.

**PCB FOOTPRINT**

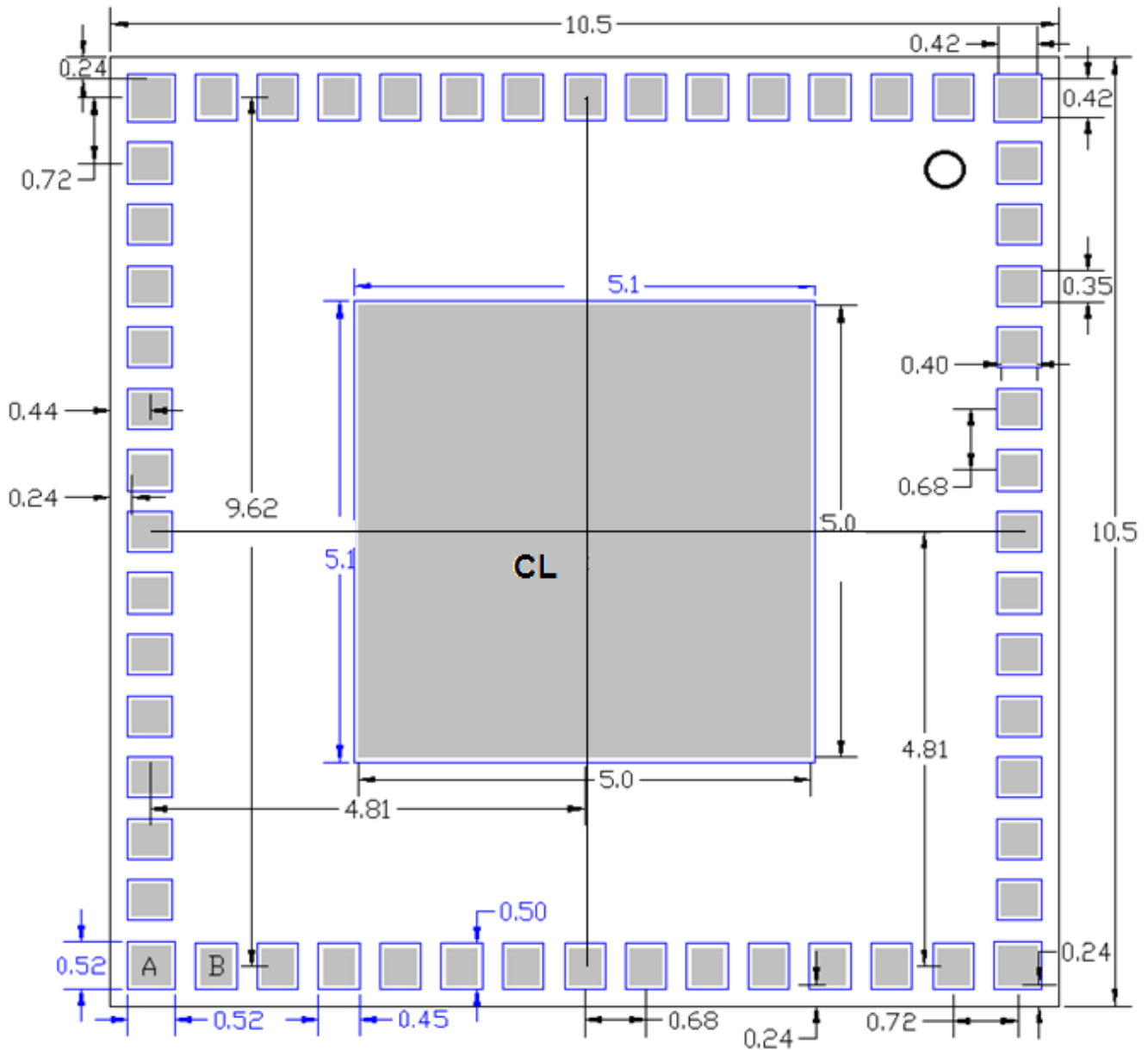

**Figure 8 TiWi-C-W Footprint (Top View)**

Note:

Three Pad Sizes	Solder Mask
Type A - 0.42 x 0.42 mm	0.52 x 0.52 mm
Type B - 0.35 x 0.40 mm	0.45 x 0.50mm (Not Centered on Type A pads)
Type C - 5.0 x 5.0 mm	5.1 x 5.1 mm

The information in this document is subject to change without notice.

**RECOMMENDED SOLDER STENCIL**

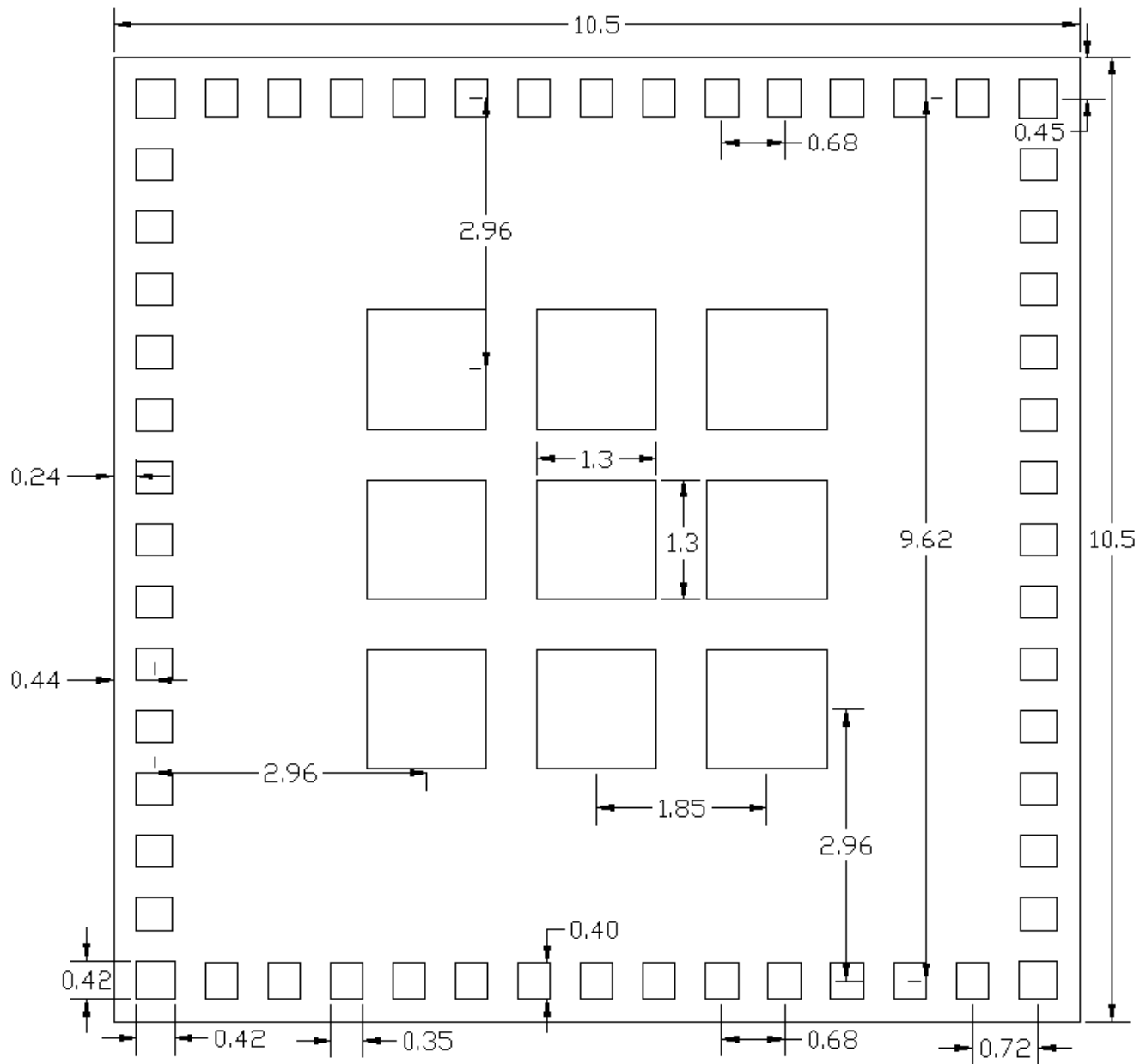
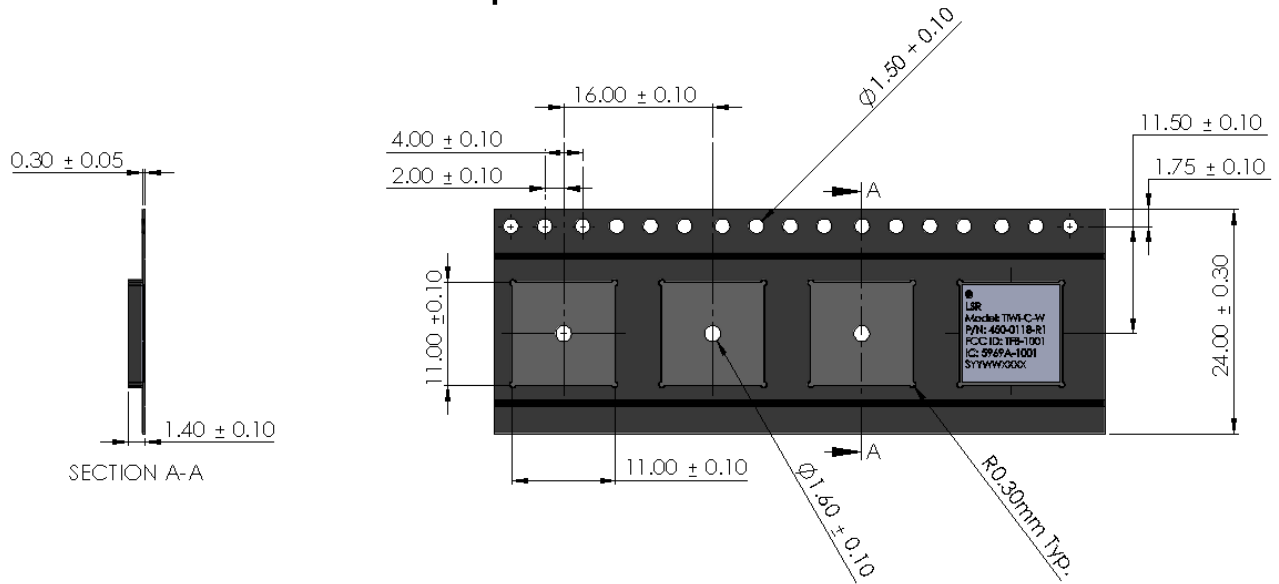

**Figure 9 - Recommended Solder Stencil (Top View)**



**TAPE AND REEL PACKAGING**

**Tape Dimensions**



**NOTES:**

1. DIM in mm.
2. 10 Sprocket Hole Pitch Cumulative Tolerance  $\pm 0.20$ mm.
3. Camber not to Exceed 1.0mm in 250mm.
4. Pocket Position Relative to Sprocket Hole Measured as True Position of Pocket, not Pocket Hole
5. A Full Reel contains 2000 Modules

**(MODULE MUST BE IN THIS ORIENTATION WHEN FEEDING)**

**Figure 10 Tape and Reel Specification**

---

## DEVICE MARKINGS

### Rev 1 Devices

LSR Model: TiWi-C-W P/N: 450-0118-R1 FCC ID: TFB-1001 IC: 5969A-1001 50C0D0001
---

Where R1 = Revision 1  
Manufacturer Code: 50C0D0001

### Rev 3 Devices

LSR Model: TiWi-C-W P/N: 450-0118-R3 FCC ID: TFB-1001 IC: 5969A-1001 50C0D0001
---

Where R3 = Revision 3  
Manufacturer Code: 50C0D0001

\*Skipped Rev 2 to align Internal MRP System\*

---

**CONTACTING LSR**

<b>Headquarters</b>	LS Research, LLC W66 N220 Commerce Court Cedarburg, WI 53012-2636 USA Tel: (262) 375-4400 Fax: (262) 375-4248
<b>Website</b>	<a href="http://www.lsr.com">www.lsr.com</a>
<b>Technical Support</b>	<a href="http://forum.lsr.com">forum.lsr.com</a>
<b>Sales Contact</b>	<a href="mailto:sales@lsr.com">sales@lsr.com</a>

© Copyright 2018 Laird. All Rights Reserved. Patent pending. Any information furnished by Laird and its agents is believed to be accurate and reliable. All specifications are subject to change without notice. Responsibility for the use and application of Laird materials or products rests with the end user since Laird and its agents cannot be aware of all potential uses. Laird makes no warranties as to non-infringement nor as to the fitness, merchantability, or sustainability of any Laird materials or products for any specific or general uses. Laird, Laird Technologies, Inc., or any of its affiliates or agents shall not be liable for incidental or consequential damages of any kind. All Laird products are sold pursuant to the Laird Terms and Conditions of Sale in effect from time to time, a copy of which will be furnished upon request. When used as a tradename herein, Laird means Laird Limited due to the acquisition by Advent or one or more subsidiaries of Laird Limited. Laird™, Laird Technologies™, corresponding logos, and other marks are trademarks or registered trademarks of Laird. Other marks may be the property of third parties. Nothing herein provides a license under any Laird or any third party intellectual property right.

---

The information in this document is subject to change without notice.

## Данный компонент на территории Российской Федерации

### Вы можете приобрести в компании MosChip.

Для оперативного оформления запроса Вам необходимо перейти по данной ссылке:

<http://moschip.ru/get-element>

Вы можете разместить у нас заказ для любого Вашего проекта, будь то серийное производство или разработка единичного прибора.

В нашем ассортименте представлены ведущие мировые производители активных и пассивных электронных компонентов.

Нашей специализацией является поставка электронной компонентной базы двойного назначения, продукции таких производителей как XILINX, Intel (ex.ALTERA), Vicor, Microchip, Texas Instruments, Analog Devices, Mini-Circuits, Amphenol, Glenair.

Сотрудничество с глобальными дистрибьюторами электронных компонентов, предоставляет возможность заказывать и получать с международных складов практически любой перечень компонентов в оптимальные для Вас сроки.

На всех этапах разработки и производства наши партнеры могут получить квалифицированную поддержку опытных инженеров.

Система менеджмента качества компании отвечает требованиям в соответствии с ГОСТ Р ИСО 9001, ГОСТ РВ 0015-002 и ЭС РД 009

### Офис по работе с юридическими лицами:

105318, г.Москва, ул.Щербаковская д.3, офис 1107, 1118, ДЦ «Щербаковский»

Телефон: +7 495 668-12-70 (многоканальный)

Факс: +7 495 668-12-70 (доб.304)

E-mail: [info@moschip.ru](mailto:info@moschip.ru)

Skype отдела продаж:

moschip.ru

moschip.ru\_4

moschip.ru\_6

moschip.ru\_9