

**PLED Unidirectional Series (PLEDxUx)**

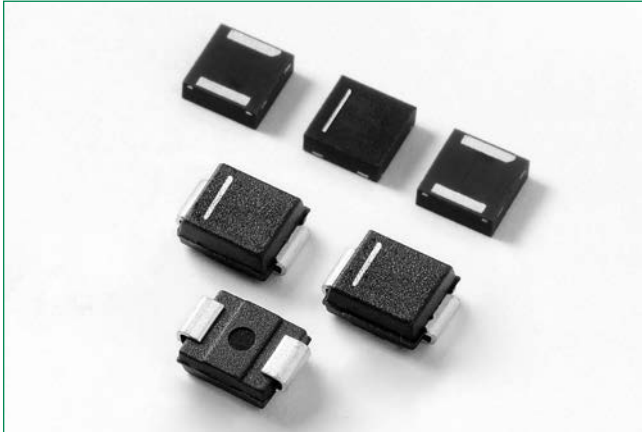

**Description**

PLED Unidirectional Series (PLEDxUx Series) open LED protectors provide a switching electronic shunt path around a single LED that fails as an open circuit. This ensures the remaining string of LEDs will continue to function even though a single LED in the string has failed open. It also provides reverse battery or reverse power polarity protection.

PLED Unidirectional Series devices were designed to enable higher reliability in outdoor LED lighting applications such as street lighting, outdoor signage, aircraft runway lighting, roadside warning lights and other applications.

Compatible with one, two and three watt LEDs that have a nominal 3V forward characteristic, PLED Unidirectional Series devices are available in two surface mount packages, the DO-214AA and the Quad Flat Pak No-lead (QFN). The QFN's low profile, chip scale package (CSP) is ideal for dense board applications.

**Agency Approvals**

Agency	Agency File Number
	E133083

**Schematic Symbol**



**Features**

- Fast switching
- Reverse Battery/Power Protection
- Automatically resets after power cycle
- Available in low profile, small footprint QFN and Standard DO214AA packages
- Compatible with industrial lighting environments
- IEC-61000-4-2 ESD 30kV (Air), 30kV (Contact)
- ESD protection of data lines in accordance with IEC 61000-4-2 (IEC801-2)
- Compatible with PWM frequencies up to 10 kHz
- RoHS compliant and halogen-free
- Recognized to UL 497B as an Isolated Loop Circuit Protector

**Electrical Characteristics** (All parameters are measured at  $T_A=25^\circ\text{C}$  unless otherwise noted)

Part Number	Marking	$V_{BR}$ Breakdown		$V_{DRM}$ Breakdown	$I_H$	$I_S$	$I_T@V_T$	$V_T$	$I_F@V_F$	$V_F$	$I_o^1$	Critical rate of rise dV/dt
		Volts		Volts	mAmps	mAmps	Amps	Volts	Amps	Volts	Amps	Volts
		Min	Max	Min	Max	Max	Max	Max	Max	Max	Min	Max
PLED6UQ12	PL6U	6	16	6	30	50	1.0	1.2	1.0	1.0	1.0	250V/ $\mu\text{s}$
PLED6US	PL6U	6	16	6	30	50	1.0	1.2	1.0	1.0		
PLED9UQ12	PL9U	9	18	9	30	50	1.0	1.2	1.0	1.0		
PLED9US	PL9U	9	18	9	30	50	1.0	1.2	1.0	1.0		
PLED13UQ12	PL13U	13	26	13	30	50	1.0	1.2	1.0	1.0		
PLED13US	PL13U	13	26	13	30	50	1.0	1.2	1.0	1.0		
PLED18UQ12	PL18U	18	33	18	30	50	1.0	1.2	1.0	1.0		
PLED18US	PL18U	18	33	18	30	50	1.0	1.2	1.0	1.0		
PLED35US	PL35U	35	50	35	30	50	1.0	1.2	1.0	1.0		

**Note:**

1.  $I_o$  - Operation current tested @ aluminum boards, ambient temp 85°C

### Thermal Considerations

Package	Symbol	Parameter	Value	Unit
 	$T_J$	Operating Junction Temperature Range	-40 to +150	$^{\circ}\text{C}$
	$T_S$	Storage Temperature Range	-65 to +150	$^{\circ}\text{C}$
	$R_{\theta JA}$	Thermal Resistance: Junction to Ambient	DO-214AA: 90 <sup>1</sup> DO-214AA: 40 <sup>2</sup> QFN: 120 <sup>1</sup> QFN: 60 <sup>3</sup>	$^{\circ}\text{C}/\text{W}$

**Notes:**

1) Standard FR-4 PCB with Copper Pads (Recommended Size)

2) Aluminum PCB

Thickness: 1.6mm

Grade: 1-2 W/mK Thermal Conductivity

Trace thickness: 2 oz

Insulation layer thickness: 215  $\mu\text{m}$

Solder Pad Dimensions: 2.0mm x 2.8mm (Recommended Size)

3) Aluminum PCB

Thickness: 1.6mm

Grade: 1-2 W/mK Thermal Conductivity

Trace thickness: 2 oz

Insulation layer thickness: 60  $\mu\text{m}$

Solder Pad Dimensions: 1.27mm x 2.54mm (Recommended Size)

### V-I Characteristics



### $V_{BR}$ vs. Junction Temperature



### Normalized DC Holding Current vs. Case Temperature

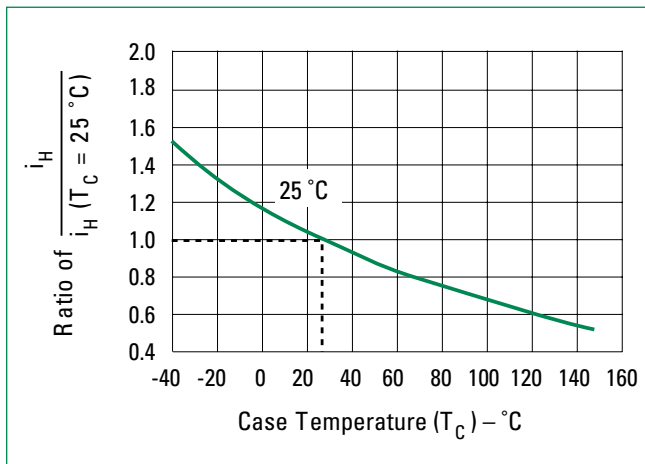

### LED Interference Test Circuit

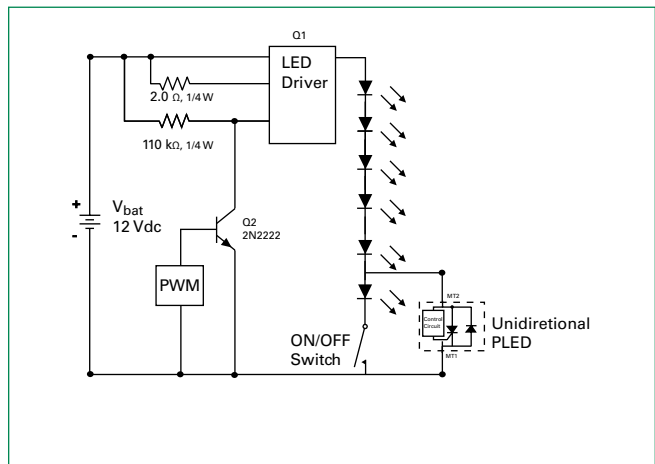

### 6 LEDs in Series 50% Duty Cycle 10kHz



### 5 LEDs and 1 PLED in Series 50% Duty Cycle 10kHz



**Note:** These two graphs show the current magnitude through the LED string with and without the PLED included. There is no noticeable effect on the LED current magnitude when the PLED is included in the circuit as compared to the LED current magnitude when the PLED is not in the circuit. (The conversion factor for the test measurement in the graphs above is 10mA/mV for the Pearson coil measurement, therefore, the current magnitude in the first figure is 10mA\*8.9 = 89mA, while the second figure is 91mA.)

### PLED in the Off-State 10kHz



**Channel 1:** current through LEDs (318 mA)  
**Channel 2:** voltage across PLED device (4.5 V)

### PLED device zeners and then turns fully on 10kHz



**Channel 1:** current through LEDs (346 mA) and PLED device once it is fully turned on 2.5 µsec later  
**Channel 2:** voltage across PLED device (21.3 V before PLED crowbars with 2 V drop)

### Soldering Parameters

<b>Reflow Condition</b>		Pb – Free assembly
<b>Pre Heat</b>	- Temperature Min ( $T_{s(min)}$ )	150°C
	- Temperature Max ( $T_{s(max)}$ )	200°C
	- Time (min to max) ( $t_s$ )	60 – 180 secs
<b>Average ramp up rate (Liquidus Temp (<math>T_L</math>) to peak)</b>		3°C/second max
<b><math>T_{s(max)}</math> to <math>T_L</math> - Ramp-up Rate</b>		3°C/second max
<b>Reflow</b>	- Temperature ( $T_L$ ) (Liquidus)	217°C
	- Temperature ( $t_L$ )	60 – 150 seconds
<b>Peak Temperature (<math>T_p</math>)</b>		260 <sup>+0/5</sup> °C
<b>Time within 5°C of actual peak temperature (<math>t_p</math>)</b>		30 seconds
<b>Ramp-down Rate</b>		6°C/second max
<b>Time 25°C to peak Temperature (<math>T_p</math>)</b>		8 minutes max
<b>Do not exceed</b>		260°C



### Physical Specifications

<b>Terminal Material</b>	Copper Alloy
<b>Terminal Finish</b>	100% Matte Tin Plated
<b>Body Material</b>	UL recognized compound meeting flammability classification V-0

### Environmental Specifications

<b>High Temperature Voltage Blocking</b>	MIL-STD-750: Method 1040, Condition A 80% min $V_{DRM}$ (VAC-peak), 150°C, 504 hours
<b>Temperature Cycling</b>	MIL-STD-750: Method 1051 -65°C to 150°C, 15-minute dwell, 100 cycles
<b>Biased Temperature &amp; Humidity</b>	EIA/JEDEC: JESD22-A101 52VDC, 85°C, 85%RH, 1008 hours
<b>High Temperature Storage</b>	MIL-STD-750: Method 1031 150°C, 1008 hours
<b>Low Temperature Storage</b>	-65°C, 1008 hours
<b>Thermal Shock</b>	MIL-STD-750: Method 1056 0°C to 100°C, 5-minute dwell, 10-second transfer, 10 cycles
<b>Resistance to Solder Heat</b>	MIL-STD-750: Method 2031 260°C, 10 seconds
<b>Moisture Sensitivity Level</b>	85%RH, +85°C, 168 hrs, 3 Reflow Cycles (+260°C Peak). JEDEC-JSTD-020, Level 1

### Part Numbering System



### Part Marking System

#### DO-214AA



#### QFN



### Packaging

Package	Description	Packaging Quantity	Industry Standard
Q12	QFN 3x3	5000	EIA-481-1
S	DO-214AA	2500	EIA-481-1

### Dimensions - QFN (3x3) Package

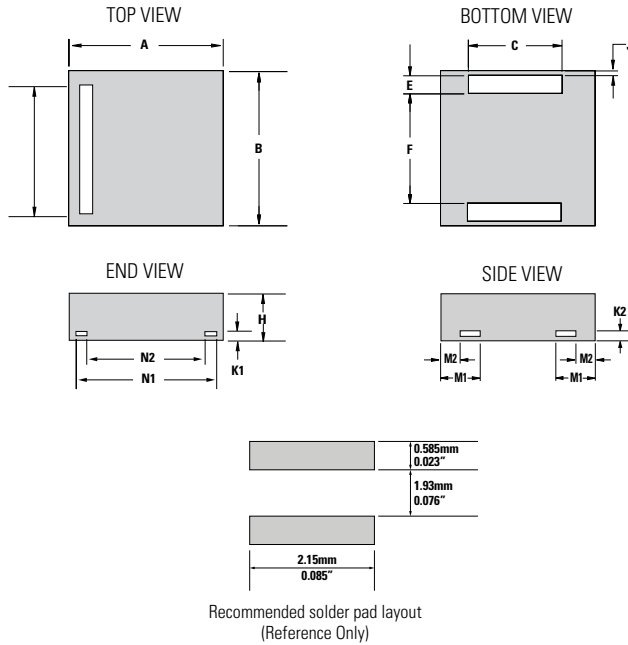

Dimensions	Inches			Millimeters		
	Min	Typ	Max	Min	Typ	Max
<b>A</b>	0.114	0.118	0.122	2.900	3.000	3.100
<b>B</b>	0.114	0.118	0.122	2.900	3.000	3.100
<b>C</b>	0.075	0.079	0.083	1.900	2.000	2.100
<b>E</b>	0.011	0.015	0.019	0.285	0.385	0.485
<b>F</b>	0.076	0.080	0.084	1.930	2.030	2.130
<b>H</b>	0.035	0.039	0.043	0.900	1.000	1.100
<b>J</b>	0.000	0.004	0.008	0.000	0.100	0.200
<b>K1</b>	0.004	0.008	0.012	0.100	0.200	0.300
<b>K2</b>	0.004	0.008	0.012	0.100	0.200	0.300
<b>M1</b>	0.056	0.060	0.064	1.143	1.530	1.630
<b>M2</b>	0.038	0.042	0.046	0.970	1.070	1.170
<b>N1</b>	0.096	0.100	0.104	2.440	2.540	2.640
<b>N2</b>	0.082	0.086	0.090	2.080	2.180	2.280

### Dimensions - DO-214 AA Package

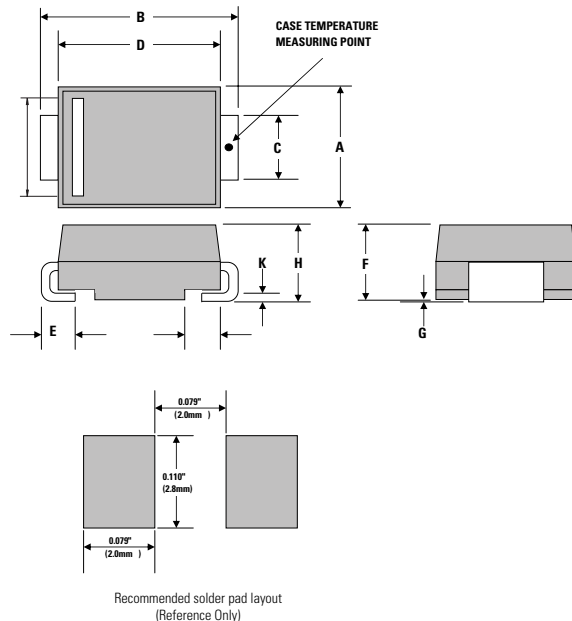

Dimensions	Inches		Millimeters	
	Min	Max	Min	Max
<b>A</b>	0.130	0.156	3.30	3.95
<b>B</b>	0.201	0.220	5.10	5.60
<b>C</b>	0.077	0.087	1.95	2.20
<b>D</b>	0.159	0.181	4.05	4.60
<b>E</b>	0.030	0.063	0.75	1.60
<b>F</b>	0.075	0.096	1.90	2.45
<b>G</b>	0.002	0.008	0.05	0.20
<b>H</b>	0.077	0.104	1.95	2.65
<b>K</b>	0.006	0.016	0.15	0.41

### Tape and Reel Specification - QFN (3x3)

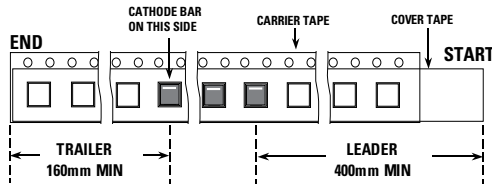

Symbols	Description	Inches		Millimeters	
		Min	Max	Min	Max
A	Reel Diameter	N/A	12.992	N/A	330.0
B	Drive Spoke Width	0.059	N/A	1.50	N/A
C	Arbor Hole Diameter	0.504	0.531	12.80	13.50
D	Drive Spoke Diameter	0.795	N/A	20.20	N/A
N	Hub Diameter	1.969	N/A	50.00	N/A
W1	Reel Inner Width at Hub	0.488	0.567	12.40	14.40
A0	Pocket Width at bottom	0.126	0.134	3.20	3.40
B0	Pocket Length at bottom	0.126	0.134	3.20	3.40
D0	Feed Hole Diameter	0.059	0.063	1.50	1.60
D1	Pocket Hole Diameter	0.059	N/A	1.50	N/A
E1	Feed hole Position 1	0.065	0.073	1.65	1.85
E2	Feed hole Position 2	0.400	0.408	10.15	10.35
F	Feed hole center-Pocket hole	0.215	0.219	5.45	5.55
K0	Pocket Depth	0.039	0.051	1.00	1.30
P0	Feed hole Pitch	0.153	0.161	3.90	4.10
P1	Component Spacing	0.311	0.319	7.90	8.10
P2	Feed hole center-Pocket hole	0.077	0.081	1.90	2.06
T	Carrier Tape Thickness	0.010	0.014	0.25	0.35
W	Embossed Carrier Tape Width	0.453	0.484	11.50	12.30
W0	Cover Tape Width	0.358	0.366	9.10	9.30

### DO-214AA Embossed Carrier Reel Pack (RP)

Meets all EIA-481-1 Standards

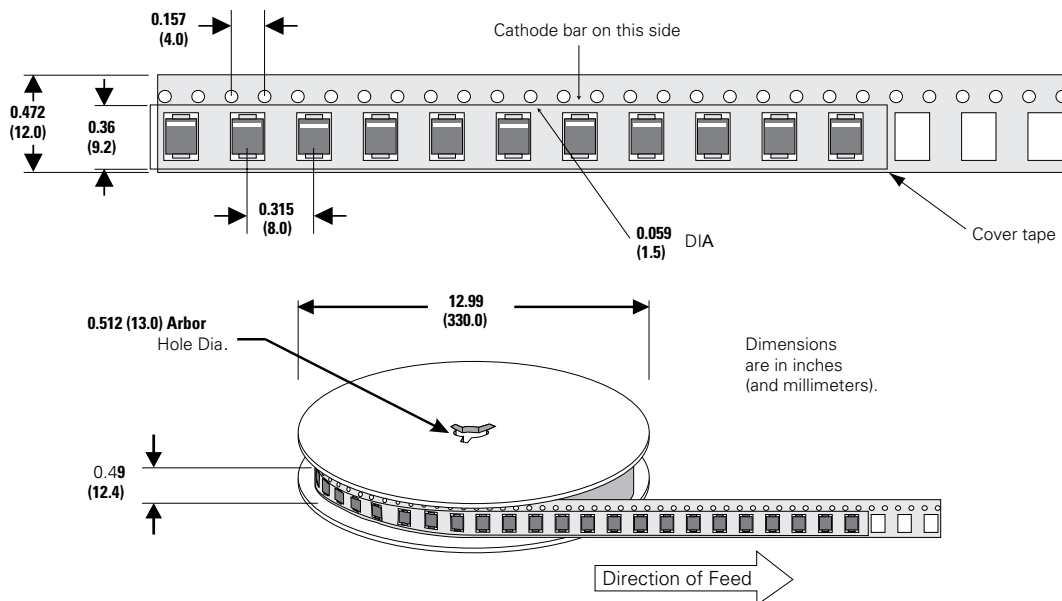

**Disclaimer Notice** - Information furnished is believed to be accurate and reliable. However, users should independently evaluate the suitability of and test each product selected for their own applications. Littelfuse products are not designed for, and may not be used in, all applications. Read complete Disclaimer Notice at: [www.littelfuse.com/disclaimer-electronics](http://www.littelfuse.com/disclaimer-electronics).

## Данный компонент на территории Российской Федерации

### Вы можете приобрести в компании MosChip.

Для оперативного оформления запроса Вам необходимо перейти по данной ссылке:

<http://moschip.ru/get-element>

Вы можете разместить у нас заказ для любого Вашего проекта, будь то серийное производство или разработка единичного прибора.

В нашем ассортименте представлены ведущие мировые производители активных и пассивных электронных компонентов.

Нашей специализацией является поставка электронной компонентной базы двойного назначения, продукции таких производителей как XILINX, Intel (ex.ALTERA), Vicor, Microchip, Texas Instruments, Analog Devices, Mini-Circuits, Amphenol, Glenair.

Сотрудничество с глобальными дистрибьюторами электронных компонентов, предоставляет возможность заказывать и получать с международных складов практически любой перечень компонентов в оптимальные для Вас сроки.

На всех этапах разработки и производства наши партнеры могут получить квалифицированную поддержку опытных инженеров.

Система менеджмента качества компании отвечает требованиям в соответствии с ГОСТ Р ИСО 9001, ГОСТ РВ 0015-002 и ЭС РД 009

### Офис по работе с юридическими лицами:

105318, г.Москва, ул.Щербаковская д.3, офис 1107, 1118, ДЦ «Щербаковский»

Телефон: +7 495 668-12-70 (многоканальный)

Факс: +7 495 668-12-70 (доб.304)

E-mail: [info@moschip.ru](mailto:info@moschip.ru)

Skype отдела продаж:

moschip.ru

moschip.ru\_4

moschip.ru\_6

moschip.ru\_9