



MICROCHIP TC646B/TC648B/TC649B

PWM Fan Speed Controllers With Auto-Shutdown, Fan Restart and FanSense™ Technology for Fault Detection

Features

- Temperature-Proportional Fan Speed for Acoustic Noise Reduction and Longer Fan Life
- Efficient PWM Fan Drive
- 3.0V to 5.5V Supply Range:
 - Fan Voltage Independent of TC646B/TC648B/TC649B Supply Voltage
 - Supports any Fan Voltage
- FanSense™ Fault Detection Circuit Protects Against Fan Failure and Aids System Testing (TC646B/TC649B)
- Automatic Shutdown Mode for “Green” Systems
- Supports Low Cost NTC/PTC Thermistors
- Over-Temperature Indication (TC646B/TC648B)
- Fan Auto-Restart
- Space-Saving 8-Pin MSOP Package

Applications

- Personal Computers & Servers
- LCD Projectors
- Datacom & Telecom Equipment
- Fan Trays
- File Servers
- General-Purpose Fan Speed Control

Package Types

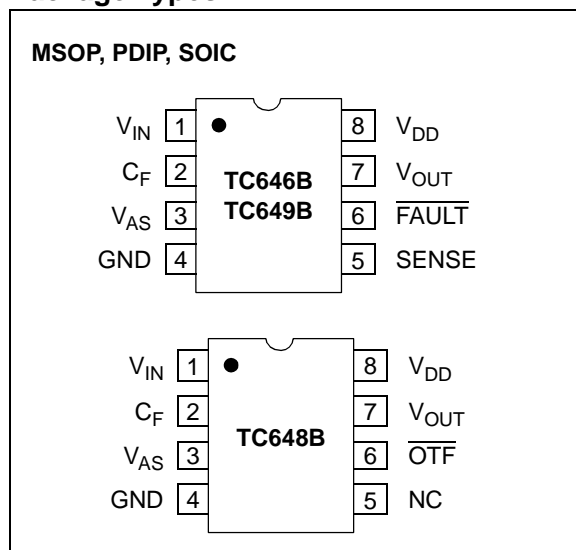

Description

The TC646B/TC648B/TC649B devices are new versions of the existing TC646/TC648/TC649 fan speed controllers. These devices are switch-mode fan speed controllers that incorporate a new fan auto-restart function. Temperature-proportional speed control is accomplished using pulse width modulation. A thermistor (or other voltage output temperature sensor) connected to the V_{IN} input supplies the required control voltage of 1.20V to 2.60V (typical) for 0% to 100% PWM duty cycle. The auto-shutdown threshold/temperature is set by a simple resistor divider on the V_{AS} input. An integrated Start-Up Timer ensures reliable fan motor start-up at turn-on, coming out of shutdown mode, auto-shutdown mode or following a transient fault. A logic low applied to V_{IN} (pin 1) causes fan shutdown.

The TC646B and TC649B also feature Microchip Technology's proprietary FanSense technology for increasing system reliability. In normal fan operation, a pulse train is present at SENSE (pin 5). A missing-pulse detector monitors this pin during fan operation. A stalled, open or unconnected fan causes the TC646B/TC649B device to turn the V_{OUT} output on full (100% duty cycle). If the fan fault persists (a fan current pulse is not detected within a $32/f$ period), the \overline{FAULT} output goes low. Even with the \overline{FAULT} output low, the V_{OUT} output is on full during the fan fault condition in order to attempt to restart the fan. \overline{FAULT} (TC646B) or \overline{OTF} (TC648B) is also asserted if the PWM reaches 100% duty cycle, indicating that maximum cooling capability has been reached and a possible overheating condition exists.

The TC646B, TC648B and TC649B devices are available in 8-pin plastic MSOP, SOIC and PDIP packages. The specified temperature range of these devices is -40 to +85°C.

TC646B/TC648B/TC649B

Functional Block Diagram



TC646B/TC648B/TC649B

1.0 ELECTRICAL CHARACTERISTICS

Absolute Maximum Ratings†

Supply Voltage (V_{DD})6.0V
 Input Voltage, Any Pin.....(GND - 0.3V) to (V_{DD} +0.3V)
 Operating Temperature Range - 40°C to +125°C
 Maximum Junction Temperature, T_J +150°C
 ESD Protection on all pins > 3 kV

† **Notice:** Stresses above those listed under “Maximum Ratings” may cause permanent damage to the device. This is a stress rating only and functional operation of the device at those or any other conditions above those indicated in the operational listings of this specification is not implied. Exposure to maximum rating conditions for extended periods may affect device reliability.

PIN FUNCTION TABLE

Name	Function
V_{IN}	Analog Input
C_F	Analog Output
V_{AS}	Analog Input
GND	Ground
SENSE/NC	Analog Input. No Connect (NC) for TC648B
$\overline{\text{FAULT}}/\text{OTF}$	Digital (Open-Drain) Output OTF for TC648B
V_{OUT}	Digital Output
V_{DD}	Power Supply Input

ELECTRICAL CHARACTERISTICS

Electrical Specifications: Unless otherwise specified, all limits are specified for $-40^\circ\text{C} < T_A < +85^\circ\text{C}$, $V_{DD} = 3.0\text{V}$ to 5.5V .						
Parameters	Sym	Min	Typ	Max	Units	Conditions
Supply Voltage	V_{DD}	3.0	—	5.5	V	
Supply Current, Operating	I_{DD}	—	200	400	μA	Pins 6, 7 Open, $C_F = 1 \mu\text{F}$, $V_{IN} = V_{C(\text{MAX})}$
Supply Current, Shutdown Mode	$I_{DD(\text{SHDN})}$	—	30	—	μA	Pins 6, 7 Open, $C_F = 1 \mu\text{F}$, $V_{IN} = 0.35\text{V}$
V_{OUT} Output						
Sink Current at V_{OUT} Output	I_{OL}	1.0	—	—	mA	$V_{OL} = 10\%$ of V_{DD}
Source Current at V_{OUT} Output	I_{OH}	5.0	—	—	mA	$V_{OH} = 80\%$ of V_{DD}
V_{IN}, V_{AS} Inputs						
Input Voltage at V_{IN} for 100% PWM Duty Cycle	$V_{C(\text{MAX})}$	2.45	2.60	2.75	V	
Over-Temperature Indication Threshold	V_{OTF}		$V_{C(\text{MAX})} + 20 \text{ mV}$		V	For TC646B and TC648B
Over-Temperature Indication Threshold Hysteresis	$V_{OTF-\text{HYS}}$		80		mV	For TC646B and TC648B
$V_{C(\text{MAX})} - V_{C(\text{MIN})}$	$V_{C(\text{SPAN})}$	1.3	1.4	1.5	V	
Hysteresis on Auto-Shutdown Comparator	V_{HAS}	—	70	—	mV	
Auto-Shutdown Threshold	V_{AS}	$V_{C(\text{MAX})} - V_{C(\text{SPAN})}$	—	$V_{C(\text{MAX})}$	V	
Voltage Applied to V_{IN} to Ensure Shutdown Mode	V_{SHDN}	—	—	$V_{DD} \times 0.13$	V	
Voltage Applied to V_{IN} to Release Shutdown Mode	V_{REL}	$V_{DD} \times 0.19$	—	—	V	$V_{DD} = 5\text{V}$
Hysteresis on V_{SHDN} , V_{REL}	V_{HYST}	—	$0.03 \times V_{DD}$	—	V	
V_{IN} , V_{AS} Input Leakage	I_{IN}	- 1.0	—	+1.0	μA	Note 1

Note 1: Ensured by design, tested during characterization.

Note 2: For $V_{DD} < 3.7\text{V}$, t_{STARTUP} and t_{MP} timers are typically $13/f$.

TC646B/TC648B/TC649B

ELECTRICAL CHARACTERISTICS (CONTINUED)

Electrical Specifications: Unless otherwise specified, all limits are specified for $-40^{\circ}\text{C} < T_A < +85^{\circ}\text{C}$, $V_{DD} = 3.0\text{V}$ to 5.5V .						
Parameters	Sym	Min	Typ	Max	Units	Conditions
Pulse-Width Modulator						
PWM Frequency	f_{PWM}	26	30	34	Hz	$C_F = 1.0\ \mu\text{F}$
SENSE Input (TC646B & TC649B)						
SENSE Input Threshold Voltage with Respect to GND	$V_{\text{TH(SENSE)}}$	50	70	90	mV	
Blanking time to ignore pulse due to V_{OUT} turn-on	t_{BLANK}	—	3.0	—	μsec	
FAULT / OTF Output						
Output Low Voltage	V_{OL}	—	—	0.3	V	$I_{\text{OL}} = 2.5\ \text{mA}$
Missing Pulse Detector Timer	t_{MP}	—	32/f	—	sec	TC646B and TC649B, Note 2
Start-up Timer	t_{STARTUP}	—	32/f	—	sec	Note 2
Diagnostic Timer	t_{DIAG}	—	3/f	—	sec	TC646B and TC649B

Note 1: Ensured by design, tested during characterization.

Note 2: For $V_{DD} < 3.7\text{V}$, t_{STARTUP} and t_{MP} timers are typically 13/f.

TEMPERATURE SPECIFICATIONS

Electrical Characteristics: Unless otherwise noted, all parameters apply at $V_{DD} = 3.0\text{V}$ to 5.5V						
Parameters	Sym	Min	Typ	Max	Units	Conditions
Temperature Ranges						
Specified Temperature Range	T_A	-40	—	+85	$^{\circ}\text{C}$	
Operating Temperature Range	T_A	-40	—	+125	$^{\circ}\text{C}$	
Storage Temperature Range	T_A	-65	—	+150	$^{\circ}\text{C}$	
Thermal Package Resistances						
Thermal Package Resistance, 8-Pin MSOP	θ_{JA}	—	200	—	$^{\circ}\text{C}/\text{W}$	
Thermal Package Resistance, 8-Pin SOIC	θ_{JA}	—	155	—	$^{\circ}\text{C}/\text{W}$	
Thermal Package Resistance, 8-Pin PDIP	θ_{JA}	—	125	—	$^{\circ}\text{C}/\text{W}$	

TC646B/TC648B/TC649B

TIMING SPECIFICATIONS



FIGURE 1-1: TC646B/TC648B/TC649B Start-up Timing.



FIGURE 1-2: Fan Fault Occurrence (TC646B and TC649B).



FIGURE 1-3: Recovery From Fan Fault (TC646B and TC649B).

TC646B/TC648B/TC649B

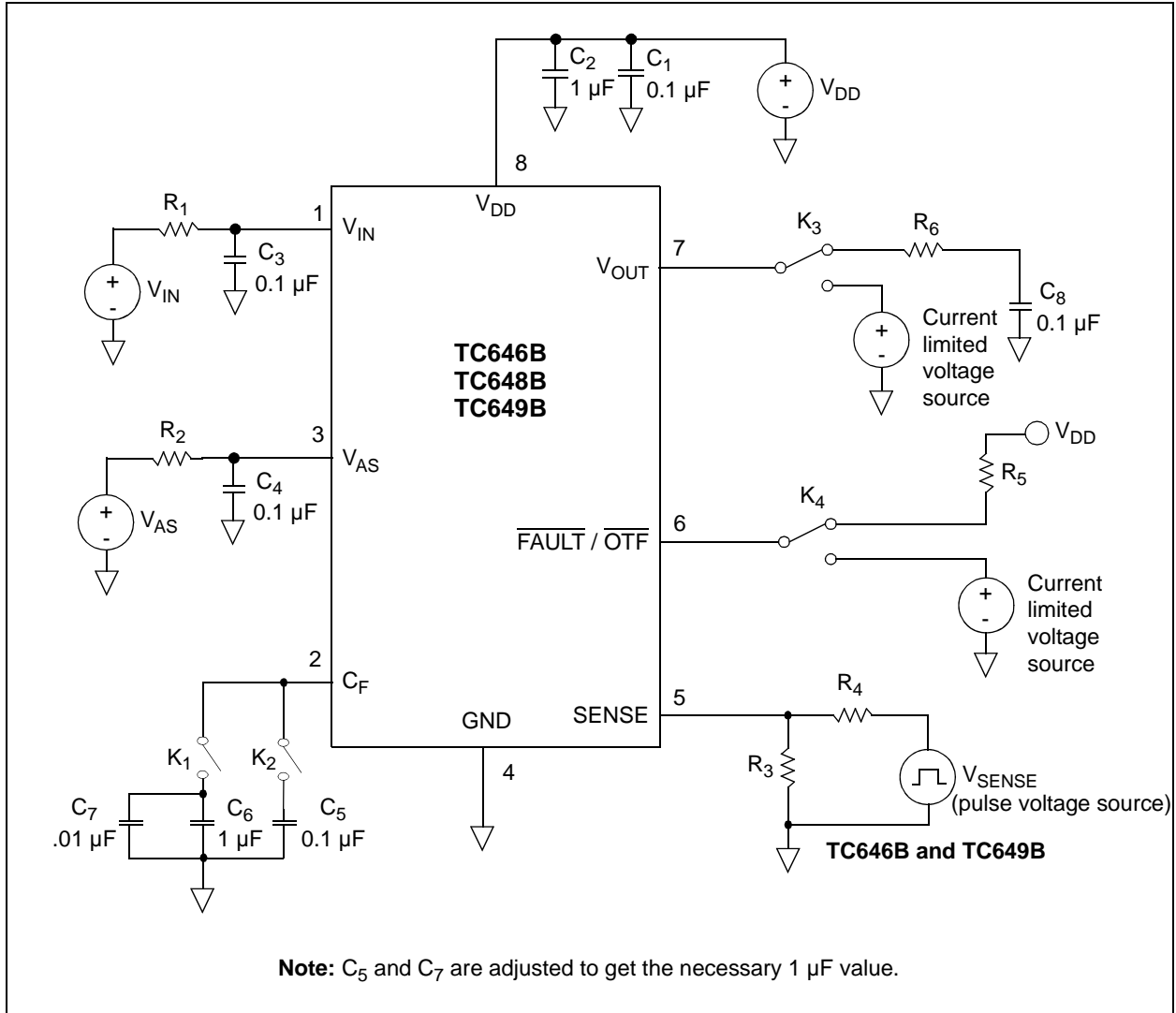

FIGURE 1-4: TC646B/TC648B/TC649B Electrical Characteristics Test Circuit.

TC646B/TC648B/TC649B

2.0 TYPICAL PERFORMANCE CURVES

Note: The graphs and tables provided following this note are a statistical summary based on a limited number of samples and are provided for informational purposes only. The performance characteristics listed herein are not tested or guaranteed. In some graphs or tables, the data presented may be outside the specified operating range (e.g., outside specified power supply range) and therefore outside the warranted range.

Note: Unless otherwise indicated, $V_{DD} = 5V$, $T_A = 25^\circ C$.



FIGURE 2-1: I_{DD} vs. Temperature.



FIGURE 2-4: PWM Frequency vs. Temperature.



FIGURE 2-2: PWM Sink Current (I_{OL}) vs. V_{OL} .



FIGURE 2-5: I_{DD} vs. V_{DD} .



FIGURE 2-3: PWM Source Current (I_{OH}) vs. $V_{DD} - V_{OH}$.



FIGURE 2-6: I_{DD} Shutdown vs. Temperature.

TC646B/TC648B/TC649B

Note: Unless otherwise indicated, $V_{DD} = 5V$, $T_A = 25^\circ C$.

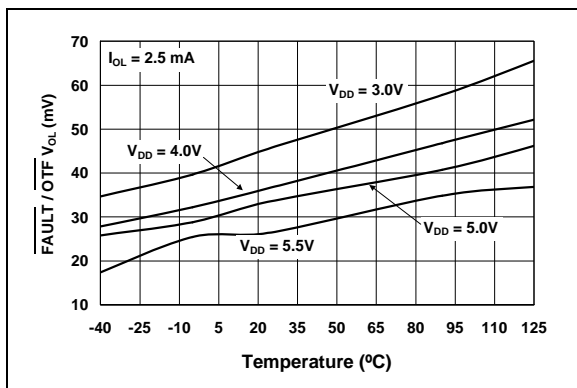

FIGURE 2-7: $\overline{FAULT} / \overline{OTF} V_{OL}$ vs. Temperature.

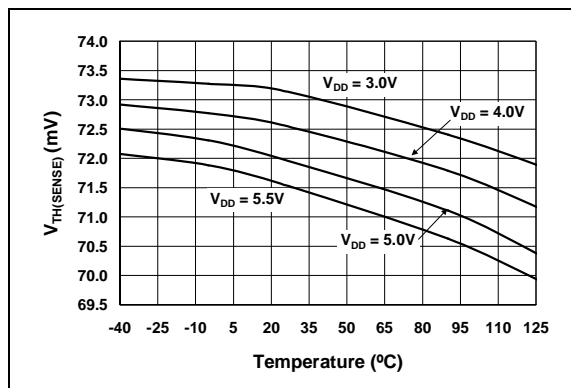

FIGURE 2-10: Sense Threshold ($V_{TH(SENSE)}$) vs. Temperature.

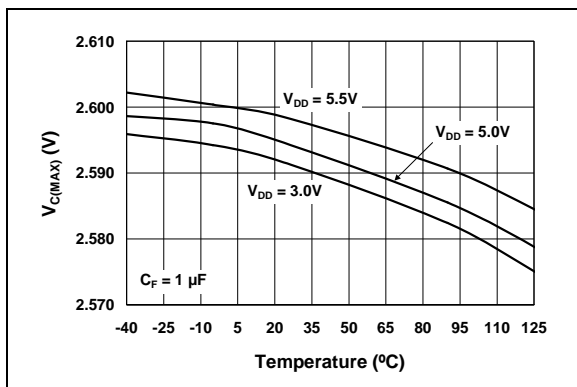

FIGURE 2-8: $V_{C(MAX)}$ vs. Temperature.

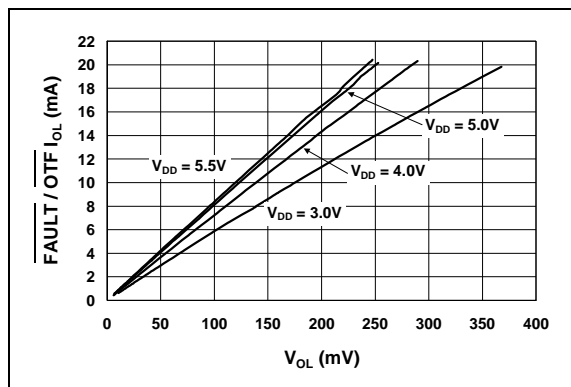

FIGURE 2-11: $\overline{FAULT} / \overline{OTF} I_{OL}$ vs. V_{OL} .



FIGURE 2-9: $V_{C(MIN)}$ vs. Temperature.

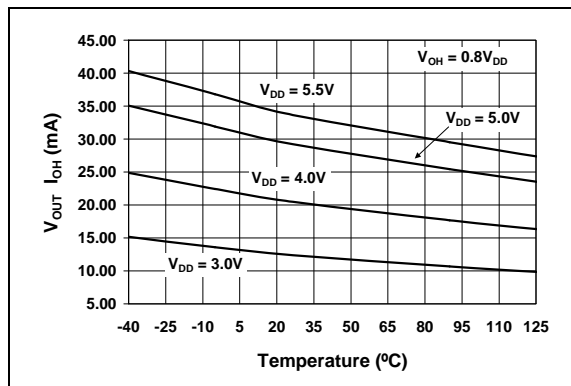

FIGURE 2-12: PWM Source Current (I_{OH}) vs. Temperature.

TC646B/TC648B/TC649B

Note: Unless otherwise indicated, $V_{DD} = 5V$, $T_A = 25^\circ C$.



FIGURE 2-13: PWM Sink Current (I_{OL}) vs. Temperature.



FIGURE 2-16: V_{OTF} Threshold vs. Temperature.



FIGURE 2-14: V_{SHDN} Threshold vs. Temperature.



FIGURE 2-17: Over-Temperature Hysteresis ($V_{OTF-HYS}$) vs. Temperature.



FIGURE 2-15: V_{REL} Threshold vs. Temperature.

TC646B/TC648B/TC649B

3.0 PIN FUNCTIONS

The descriptions of the pins are given in Table 3-1.

TABLE 3-1: PIN FUNCTION TABLE

Pin	Name	Function
1	V_{IN}	Analog Input
2	C_F	Analog Output
3	V_{AS}	Analog Input
4	GND	Ground
5	SENSE/NC	Analog Input/No Connect. NC for TC648B.
6	$\overline{\text{FAULT/OTF}}$	Digital (Open-Drain) Output OTF for TC648B
7	V_{OUT}	Digital Output
8	V_{DD}	Power Supply Input

3.1 Analog Input (V_{IN})

The thermistor network (or other temperature sensor) connects to V_{IN} . A voltage range of 1.20V to 2.60V (typical) on this pin drives an active duty cycle of 0% to 100% on the V_{OUT} pin. The TC646B, TC648B and TC649B devices enter shutdown mode when $0 \leq V_{IN} \leq V_{SHDN}$. During shutdown, the $\overline{\text{FAULT/OTF}}$ output is inactive and supply current falls to 30 μA (typical).

3.2 Analog Output (C_F)

C_F is the positive terminal for the PWM ramp generator timing capacitor. The recommended value for the C_F capacitor is 1.0 μF for 30 Hz PWM operation.

3.3 Analog Input (V_{AS})

An external resistor divider connected to V_{AS} sets the auto-shutdown threshold. Auto-shutdown occurs when $V_{IN} < V_{AS}$. The fan is automatically restarted when $V_{IN} > (V_{AS} + V_{HAS})$. During auto-shutdown, the $\overline{\text{FAULT/OTF}}$ output is inactive and supply current falls to 30 μA (typical).

3.4 Analog Input (SENSE)

Pulses are detected at SENSE as fan rotation chops the current through a sense resistor. The absence of pulses indicates a fan fault condition.

3.5 Digital (Open-Drain) Output ($\overline{\text{FAULT/OTF}}$)

$\overline{\text{FAULT/OTF}}$ goes low to indicate a fault condition. When $\overline{\text{FAULT}}$ goes low due to a fan fault (TC646B and TC649B devices), the output will remain low until the fan fault condition has been removed (16 pulses have been detected at the SENSE pin in a $32/f$ period). For the TC646B and TC648B devices, the $\overline{\text{FAULT/OTF}}$ output will also be asserted when the V_{IN} voltage reaches the V_{OTF} threshold of 2.62V (typical). This gives an over-temperature/100% fan speed indication.

3.6 Digital Output (V_{OUT})

V_{OUT} is an active-high complimentary output that drives the base of an external NPN transistor (via an appropriate base resistor) or the gate of an N-channel MOSFET. This output has asymmetrical drive. During a fan fault condition, the V_{OUT} output is continuously on.

3.7 Power Supply Input (V_{DD})

The V_{DD} pin with respect to GND provides power to the device. This bias supply voltage may be independent of the fan power supply.

3.8 Ground (GND)

Ground terminal.

3.9 No Connect (NC)

No internal connection.

4.0 DEVICE OPERATION

The TC646B/TC648B/TC649B devices are a family of temperature-proportional, PWM mode, fan speed controllers. Features of the family include minimum fan speed, fan auto-shutdown, fan auto-restart, remote shutdown, over-temperature indication and fan fault detection.

The TC64XB family is slightly different from the original TC64X family, which includes the TC642, TC646, TC647, TC648 and TC649 devices. Changes have been made to adjust the operation of the device during a fan fault condition.

The key change to the TC64XB family of devices (TC642B, TC647B, TC646B, TC648B, TC649B) is that the FAULT and V_{OUT} outputs no longer “latch” to a state during a fan fault condition. The TC646B/TC648B/TC649B family will continue to monitor the operation of the fan so that when the fan returns to normal operation, the fan speed controller will also return to normal operation (PWM mode). The operation and features of these devices are discussed in the following sections.

4.1 Fan Speed Control Methods

The speed of a DC brushless fan is proportional to the voltage across it. This relationship will vary from fan-to-fan and should be characterized on an individual basis. The speed versus applied voltage relationship can then be used to set up the fan speed control algorithm.

There are two main methods for fan speed control. The first is pulse width modulation (PWM) and the second is linear. Using either method, the total system power requirement to run the fan is equal. The difference between the two methods is where the power is consumed.

The following example compares the two methods for a 12V, 120 mA fan running at 50% speed. With 6V applied across the fan, the fan draws an average current of 68 mA.

Using a linear control method, there is 6V across the fan and 6V across the drive element. With 6V and 68 mA, the drive element is dissipating 410 mW of power.

Using the PWM approach, the fan voltage is modulated at a 50% duty cycle, with most of the 12V being dropped across the fan. With 50% duty cycle, the fan draws a RMS current of 110 mA and an average current of 72 mA. Using a MOSFET with a 1Ω R_{DS(on)} (a fairly typical value for this low current), the power dissipation in the drive element would be: 12 mW (I_{rms}² * R_{DS(on)}). Using a standard 2N2222A NPN transistor (assuming a V_{ce-sat} of 0.8V), the power dissipation would be 58 mW (I_{avg} * V_{ce-sat}).

The PWM approach to fan speed control results in much less power dissipation in the drive element. This allows smaller devices to be used and will not require special heatsinking to remove the power being dissipated in the package.

The other advantage of the PWM approach is that the voltage being applied to the fan is always near 12V. This eliminates any concern about not supplying a high enough voltage to run the internal fan components, which is very relevant in linear fan speed control.

4.2 PWM Fan Speed Control

The TC646B, TC648B and TC649B devices implement PWM fan speed control by varying the duty cycle of a fixed-frequency pulse train. The duty cycle of a waveform is the on time divided by the total period of the pulse. For example, if we take a 100 Hz waveform (10 ms) with an on time of 5.0 ms, the duty cycle of this waveform is 50% (5.0 ms / 10.0 ms). This example is shown in Figure 4-1.



FIGURE 4-1: Duty Cycle of a PWM Waveform.

The TC646B/TC648B/TC649B devices generate a pulse train with a typical frequency of 30 Hz (C_F = 1 μF). The duty cycle can be varied from 0% to 100%. The pulse train generated by the TC646B/TC648B/TC649B device drives the gate of an external N-channel MOSFET or the base of an NPN transistor. (shown in Figure 4-2). See Section 5.5, “Output Drive Device Selection”, for more information on output drive device selection.

TC646B/TC648B/TC649B



FIGURE 4-2: PWM Fan Drive.

By modulating the voltage applied to the gate of the MOSFET (Q_{DRIVE}), the voltage that is applied to the fan is also modulated. When the V_{OUT} pulse is high, the gate of the MOSFET is turned on, pulling the voltage at the drain of Q_{DRIVE} to zero volts. This places the full 12V across the fan for the t_{on} period of the pulse. When the duty cycle of the drive pulse is 100% (full on, $t_{on} = t$), the fan will run at full speed. As the duty cycle is decreased (pulse on time “ t_{on} ” is lowered), the fan will slow down proportionally. With the TC646B, TC648B and TC649B devices, the duty cycle is controlled by the V_{IN} input and can also be terminated by the V_{AS} input (auto-shutdown). This is described in more detail in Section 5.5, “Output Drive Device Selection”.

4.3 Fan Start-up

Often overlooked in fan speed control is the actual start-up control period. When starting a fan from a non-operating condition (fan speed is zero revolutions per minute (RPM)), the desired PWM duty cycle or average fan voltage cannot be applied immediately. Since the fan is at a rest position, the fan’s inertia must be overcome to get it started. The best way to accomplish this is to apply the full rated voltage to the fan for a minimum of one second. This will ensure that in all operating environments, the fan will start and operate properly. An example of the start-up timing is shown in Figure 1-1.

A key feature of the TC646B/TC648B/TC649B devices is the start-up timer. When power is first applied to the device, or when the device is brought out of the shutdown/auto-shutdown modes of operation, the V_{OUT} output will go to a high state for 32 PWM cycles (one second for $C_F = 1 \mu F$). This will drive the fan to full speed for this time frame.

During the start-up period for the TC646B and TC649B devices, the SENSE pin is being monitored for fan pulses. If pulses are detected during this period, the fan speed controller will then move to PWM operation. If pulses are not detected during the start-up period, the

start-up timer is activated again. If pulses are not detected at the SENSE pin during this additional period, the \overline{FAULT} output will go low to indicate that a fan fault condition has occurred. See Section 4.7, “FAULT/OTF Output”, for more details.

4.4 PWM Frequency & Duty Cycle Control (C_F & V_{IN} Pins)

The frequency of the PWM pulse train is controlled by the C_F pin. By attaching a capacitor to the C_F pin, the frequency of the PWM pulse train can be set to the desired value. The typical PWM frequency for a $1.0 \mu F$ capacitor is 30 Hz. The frequency can be adjusted by raising or lowering the value of the capacitor. The C_F pin functions as a ramp generator. The voltage at this pin will ramp from 1.20V to 2.60V (typically) as a sawtooth waveform. An example of this is shown in Figure 4-3.

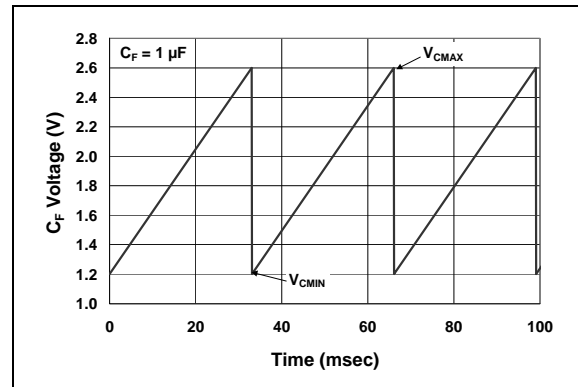

FIGURE 4-3: C_F Pin Voltage.

The duty cycle of the PWM output is controlled by the voltage at the V_{IN} input pin. The duty cycle of the PWM output is produced by comparing the voltage at the V_{IN} pin to the voltage ramp at the C_F pin. When the voltage at the V_{IN} pin is 1.20V, the duty cycle will be 0%. When the voltage at the V_{IN} pin is 2.60V, the PWM duty cycle will be 100% (these are both typical values). The V_{IN} -to-PWM duty cycle relationship is shown in Figure 4-4.

The lower value of 1.20V is referred to as “ V_{CMIN} ” and the 2.60V threshold is referred to as “ V_{CMAX} ”. A calculation for duty cycle is shown in the equation below. The voltage range between V_{CMIN} and V_{CMAX} is characterized as “ V_{CSPAN} ” and has a typical value of 1.4V, with minimum and maximum values of 1.3V and 1.5V, respectively.

EQUATION PWM DUTY CYCLE

$$Duty\ Cycle\ (\%) = \frac{(V_{IN} - V_{CMIN}) * 100}{V_{CMAX} - V_{CMIN}}$$

TC646B/TC648B/TC649B

For the TC646B, TC648B and TC649B devices, the V_{IN} pin is also used as the shutdown pin. The V_{SHDN} and V_{REL} threshold voltages are characterized in the “Electrical Characteristics Table” of Section 1.0. If the V_{IN} pin voltage is pulled below the V_{SHDN} threshold, the device will shut down (V_{OUT} output goes to a low state, the $\overline{FAULT/OTF}$ pin is inactive). If the voltage on the V_{IN} pin then rises above the release threshold (V_{REL}), the device will go through a power-up sequence (assuming that the V_{IN} voltage is also higher than the voltage at the V_{AS} pin). The power-up sequence is shown later in the “Behavioral Algorithm Flowcharts” of Section 4.9.



FIGURE 4-4: V_{IN} Voltage vs. PWM Duty Cycle (Typical).

4.5 Auto-Shutdown Mode (V_{AS})

For the TC646B, TC648B and TC649B devices, pin 3 is the V_{AS} pin and is used for setting the auto-shutdown threshold voltage.

The auto-shutdown function provides a way to set a threshold voltage (temperature) at which the fan will be shut off. This way, if the temperature in the system reaches a threshold at which the fan(s) no longer needs to operate, the fan can be shutdown automatically.

The voltage range for the V_{AS} pin is the same as the voltage range for the V_{IN} pin (1.20V to 2.60V). The voltage at the V_{AS} pin is set in this range so that when the voltage at the V_{IN} pin decreases below the voltage at the V_{AS} pin (signifying that the threshold temperature has been reached), the V_{OUT} output is shut off (goes to a low state). In auto-shutdown, the $\overline{FAULT/OTF}$ output is inactive (high-impedance). Auto-shutdown mode is exited when the V_{IN} voltage exceeds the V_{AS} voltage by the auto-shutdown hysteresis voltage (V_{HAS}). Upon exiting auto-shutdown mode, the start-up timer is triggered and the device returns to normal operation.

4.6 V_{OUT} Output (PWM Output)

The V_{OUT} output is a digital output designed for driving the base of a transistor or the gate of a MOSFET. The V_{OUT} output is designed to be able to quickly raise the base current or the gate voltage of the external drive device to its final value.

When the device is in shutdown/auto-shutdown mode, the V_{OUT} output is actively held low. The output can be varied from 0% (full off) to 100% duty cycle (full on). As previously discussed, the duty cycle of the V_{OUT} output is controlled via the V_{IN} input voltage and can be terminated based on the V_{AS} voltage.

A base current-limiting resistor is required when using a transistor as the external drive device in order to limit the amount of drive current that is drawn from the V_{OUT} output.

The V_{OUT} output can be directly connected to the gate of an external MOSFET. One concern when doing this, though, is that the fast turn-off time of the fan drive MOSFET can cause a problem because the fan motor looks like an inductor. When the MOSFET is turned off quickly, the current in the fan wants to continue to flow in the same direction. This causes the voltage at the drain of the MOSFET to rise. If there aren't any clamp diodes internal to the fan, this voltage can rise above the drain-to-source voltage rating of the MOSFET. For this reason, an external clamp diode is suggested. This is shown in Figure 4-5.



FIGURE 4-5: Clamp Diode for Fan.

4.7 $\overline{FAULT/OTF}$ Output

The $\overline{FAULT/OTF}$ output is an open-drain, active-low output. For the TC646B and TC649B devices, pin 6 is labeled as the \overline{FAULT} output and indicates when a fan fault condition has occurred. For the TC646B device, the \overline{FAULT} output also indicates when an over-temperature (OTF) condition has occurred. For the TC648B device, pin 6 is the \overline{OTF} output that indicates an over-temperature (OTF) condition has occurred.

TC646B/TC648B/TC649B

For the TC646B and TC648B devices, an over-temperature condition is indicated when the V_{IN} input reaches the V_{OTF} threshold voltage (the V_{OTF} threshold voltage is typically 20 mV higher than the V_{CMAX} threshold and has 80 mV of hysteresis). This indicates that maximum cooling capacity has been reached (the fan is at full speed) and that an overheating situation can occur. When the voltage at the V_{IN} input falls below the V_{OTF} threshold voltage by the hysteresis value ($V_{OTF-HYS}$), the $\overline{FAULT/OTF}$ output will return to the high state (a pull-up resistor is needed on the $\overline{FAULT/OTF}$ output).

For the TC646B/TC649B devices, a fan fault condition is indicated when fan current pulses are no longer detected at the SENSE pin. Pulses at the SENSE pin indicate that the fan is spinning and conducting current.

If pulses are not detected at the SENSE pin for 32 PWM cycles, the 3-cycle diagnostic timer is fired. This means that the V_{OUT} output is high for 3 PWM cycles. If pulses are detected in this 3-cycle period, normal PWM operation is resumed and no fan fault is indicated. If no pulses are detected in the 3-cycle period, the start-up timer is activated and the V_{OUT} output is driven high for 32 PWM cycles. If pulses are detected during this time-frame, normal PWM operation is resumed. If no pulses are detected during this time-period, a fan fault condition exists and the \overline{FAULT} output is pulled low.

During a fan fault condition, the \overline{FAULT} output will remain low until the fault condition has been removed. During this time, the V_{OUT} output is driven high continuously to attempt to restart the fan and the SENSE pin is monitored for fan pulses. If a minimum of 16 pulses are detected at the SENSE input over a 32 cycle time-period (one second for $C_F = 1.0 \mu F$), the fan fault condition no longer exists. Therefore, The \overline{FAULT} output is released and the V_{OUT} output returns to normal PWM operation, as dictated by the V_{IN} and V_{AS} inputs.

If the V_{IN} voltage is pulled below the V_{SHDN} level during a fan fault condition, the \overline{FAULT} output will be released and the V_{OUT} output will be shutdown ($V_{OUT} = 0V$). If the V_{IN} voltage then increases above the V_{REL} threshold and is above the V_{AS} voltage, the device will go through the normal start-up routine.

If, during a fan fault condition, the voltage at the V_{IN} pin drops below the V_{AS} voltage level, the TC646B/TC649B device will continue to hold the \overline{FAULT} line low and drive the V_{OUT} output to 100% duty cycle. If the fan fault condition is then removed, the \overline{FAULT} output will be released and the TC646B/TC649B device will enter auto-shutdown mode until the V_{IN} voltage is brought above the V_{AS} voltage by the auto-shutdown hysteresis value (V_{HAS}). The TC646B/TC649B device will then resume normal PWM mode operation.

The sink current capability of the \overline{FAULT} output is listed in the "Electrical Characteristics Table" of Section 1.0.

4.8 Sensing Fan Operation (SENSE)

The SENSE input is an analog input used to monitor the fan's operation (the TC648B device does not incorporate the fan sensing feature). It does this by sensing fan current pulses that represent fan rotation. When a fan rotates, commutation of the fan current occurs as the fan poles pass the armatures of the motor. The commutation of the fan current makes the current waveshape appear as pulses. There are two typical current waveforms of brushless DC fan motors, illustrated in Figures 4-6 and 4-7.

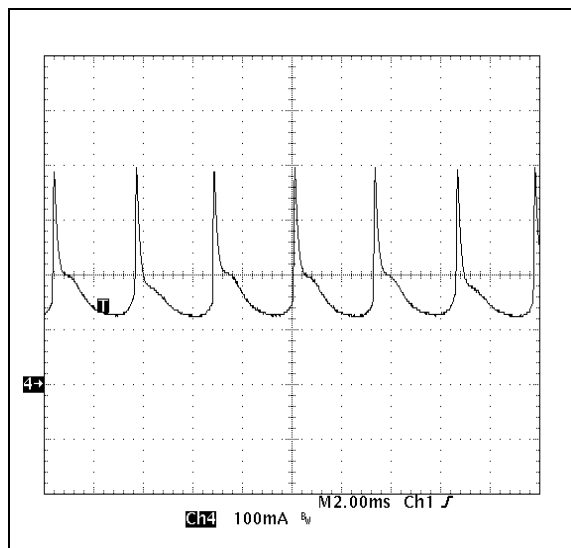

FIGURE 4-6: Fan Current With DC Offset And Positive Commutation Current.

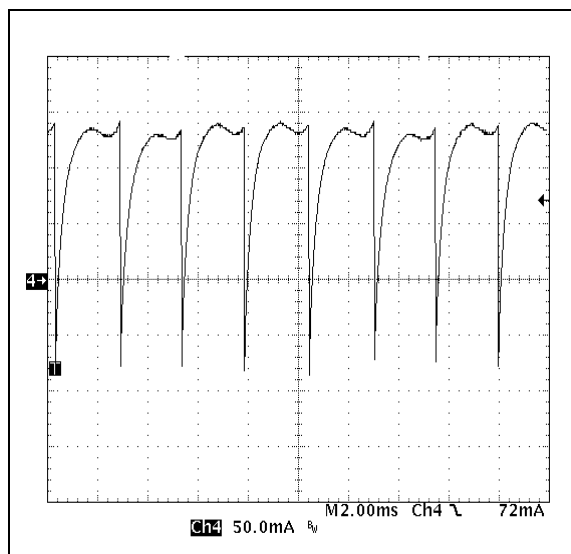

FIGURE 4-7: Fan Current With Commutation Pulses To Zero.

TC646B/TC648B/TC649B

The SENSE pin senses positive voltage pulses that have an amplitude of 70 mV (typical value). Each time a pulse is detected, the missing pulse detector timer (t_{MP}) is reset. As previously stated, if the missing pulse detector timer reaches the time for 32 cycles, the loop for diagnosing a fan fault is engaged (diagnostic timer, then the start-up timer).

Both of the fan current waveshapes shown in Figures 4-6 and 4-7 can be sensed with the sensing scheme shown in Figure 4-8.



FIGURE 4-8: Sensing Scheme For Fan Current.

The fan current flowing through R_{SENSE} generates a voltage that is proportional to the current. The C_{SENSE} capacitor removes any DC portion of the voltage across R_{SENSE} and presents only the voltage pulse portion to the SENSE pin of the TC646B/TC649B devices.

The R_{SENSE} and C_{SENSE} values need to be selected so that the voltage pulse provided to the SENSE pin is 70 mV (typical) in amplitude. Be sure to check the sense pulse amplitude over all operating conditions (duty cycles) as the current pulse amplitude will vary with duty cycle. See Section 5.0, "Applications Information", for more details on selecting values for R_{SENSE} and C_{SENSE}.

Key features of the SENSE pin circuitry are an initial blanking period after every V_{OUT} pulse and an initial pulse blanker.

The TC646B/TC649B sense circuitry has a blanking period that occurs at the turn-on of each V_{OUT} pulse. During this blanking period, the sense circuitry ignores any pulse information that is seen at the SENSE pin input. This stops the TC646B/TC649B device from falsely sensing a current pulse that is due to the fan drive device turn-on.

The initial pulse blanker is also implemented to stop false sensing of fan current pulses. When a fan is in a locked rotor condition, the fan current no longer commutates, it simply flows through one fan winding and is a DC current. When a fan is in a locked rotor condition and the TC646B/TC649B device is in PWM mode, it will see one current pulse each time the V_{OUT} output is turned on. The initial pulse blanker allows the TC646B/TC649B device to ignore this pulse and recognize that the fan is in a fault condition.

4.9 Behavioral Algorithms

The behavioral algorithms for the TC646B/TC649B and TC648B devices are shown in Figure 4-9 and Figure 4-10, respectively.

The behavioral algorithms show the step-by-step decision-making process for the fan speed controller operation. The TC646B and TC649B devices are very similar with one exception: the TC649B device does not implement the over-temperature portion of the algorithm.

TC646B/TC648B/TC649B



FIGURE 4-9: TC646B/TC649B Behavioral Algorithm.



FIGURE 4-10: TC648B Behavioral Algorithm.

TC646B/TC648B/TC649B

5.0 APPLICATIONS INFORMATION

5.1 Setting the PWM Frequency

The PWM frequency of the V_{OUT} output is set by the capacitor value attached to the C_F pin. The PWM frequency will be 30 Hz (typical) for a 1 μ F capacitor. The relationship between frequency and capacitor value is linear, making alternate frequency selections easy.

As stated in previous sections, the PWM frequency should be kept in the range of 15 Hz to 35 Hz. This will eliminate the possibility of having audible frequencies when varying the duty cycle of the fan drive.

A very important factor to consider when selecting the PWM frequency for the TC646B/TC648B/TC649B devices is the RPM rating of the selected fan and the minimum duty cycle that you will be operating at. For fans that have a full-speed rating of 3000 RPM or less, it is desirable to use a lower PWM frequency. A lower PWM frequency allows for a longer time-period to monitor the fan current pulses. The goal is to be able to monitor at least two fan current pulses during the on-time of the V_{OUT} output.

Example: The system design requirement is to operate the fan at 50% duty cycle when ambient temperatures are below 20°C. The fan full-speed RPM rating is 3000 RPM and has four current pulses per rotation. At 50% duty cycle, the fan will be operating at approximately 1500 RPM.

EQUATION

$$\text{Time for one revolution (msec.)} = \frac{60 \times 1000}{1500} = 40$$

If one fan revolution occurs in 40 msec, each fan pulse occurs 10 msec apart. In order to detect two fan current pulses, the on-time of the V_{OUT} pulse must be at least 20 msec. With the duty cycle at 50%, the total period of one cycle must be at least 40 msec, which makes the PWM frequency 25 Hz. For this example, a PWM frequency of 20 Hz is recommended. This would define a C_F capacitor value of 1.5 μ F.

5.2 Temperature Sensor Design

As discussed in previous sections, the V_{IN} analog input has a range of 1.20V to 2.60V (typical), which represents a duty cycle range on the V_{OUT} output of 0% to 100%, respectively. The V_{IN} voltages can be thought of as representing temperatures. The 1.20V level is the low temperature at which the system requires very little cooling. The 2.60V level is the high temperature, for which the system needs maximum cooling capability (100% fan speed).

One of the simplest ways of sensing temperature over a given range is to use a thermistor. By using a NTC thermistor, as shown in Figure 5-1, a temperature-variant voltage can be created.



FIGURE 5-1: Temperature Sensing Circuit.

Figure 5-1 represents a temperature-dependent, voltage divider circuit. R_T is a conventional NTC thermistor, R_1 and R_2 are standard resistors. R_1 and R_T form a parallel resistor combination that will be referred to as R_{TEMP} ($R_{TEMP} = R_1 * R_T / (R_1 + R_T)$). As the temperature increases, the value of R_T decreases and the value of R_{TEMP} will decrease with it. Accordingly, the voltage at V_{IN} increases as temperature increases, giving the desired relationship for the V_{IN} input. R_1 helps to linearize the response of the SENSE network and aids in obtaining the proper V_{IN} voltages over the desired temperature range. An example of this is shown in Figure 5-2.

If less current draw from V_{DD} is desired, a larger value thermistor should be chosen. The voltage at the V_{IN} pin can also be generated by a voltage output temperature sensor device. The key is to get the desired V_{IN} voltage-to-system (or component) temperature relationship.

The following equations apply to the circuit in Figure 5-1.

EQUATION

$$V(T1) = \frac{V_{DD} \times R_2}{R_{TEMP}(T1) + R_2}$$
$$V(T2) = \frac{V_{DD} \times R_2}{R_{TEMP}(T2) + R_2}$$

In order to solve for the values of R_1 , R_2 , V_{IN} and the temperatures at which they are to occur, need to be selected. The variables T1 and T2 represent the selected temperatures. The value of the thermistor at these two temperatures can be found in the thermistor

TC646B/TC648B/TC649B

data sheet. With the values for the thermistor and the values for V_{IN} , you now have two equations from which the values for R_1 and R_2 can be found.

Example: The following design goals are desired:

- Duty Cycle = 50% ($V_{IN} = 1.90V$) with Temperature (T_1) = 30°C
- Duty Cycle = 100% ($V_{IN} = 2.60V$) with Temperature (T_2) = 60°C

Using a 100 k Ω thermistor (25°C value), we look up the thermistor values at the desired temperatures:

- R_T (T_1) = 79428 Ω @ 30°C
- R_T (T_2) = 22593 Ω @ 60°C

Substituting these numbers into the given equations produces the following numbers for R_1 and R_2 .

- $R_1 = 34.8$ k Ω
- $R_2 = 14.7$ k Ω



FIGURE 5-2: How Thermistor Resistance, V_{IN} , and R_{TEMP} Vary With Temperature.

Figure 5-2 graphs R_T , R_{TEMP} (R_1 in parallel with R_T) and V_{IN} , versus temperature for the example shown above.

5.3 Thermistor Selection

As with any component, there are a number of sources for thermistors. A listing of companies that manufacture thermistors can be found at www.temperatures.com/thermivendors.html. This website lists over forty suppliers of thermistor products. A brief list is shown here:

- | | |
|------------------------------|-----------------------|
| - Thermometrics® | - Quality Thermistor™ |
| - Ametherm® | - Sensor Scientific™ |
| - U.S. Sensor™ | - Vishay® |
| - Advanced Thermal Products™ | - muRata® |

5.4 FanSense Network (R_{SENSE} and C_{SENSE})

The SENSE network (comprised of R_{SENSE} and C_{SENSE}) allows the TC646B and TC649B devices to detect commutation of the fan motor. R_{SENSE} converts the fan current into a voltage. C_{SENSE} AC couples this voltage signal to the SENSE pin. The goal of the SENSE network is to provide a voltage pulse to the SENSE pin that has a minimum amplitude of 90 mV. This will ensure that the current pulse caused by the fan commutation is recognized by the TC646B/TC649B device.

A 0.1 μF ceramic capacitor is recommended for C_{SENSE} . Smaller values will require that larger sense resistors be used. Using a 0.1 μF capacitor results in reasonable values for R_{SENSE} . Figure 5-3 illustrates a typical SENSE network.



FIGURE 5-3: Typical Sense Network.

The required value of R_{SENSE} will change with the current rating of the fan and the fan current waveshape. A key point is that the current rating of the fan specified by the manufacturer may be a worst-case rating, with the actual current drawn by the fan being lower than this rating. For the purposes of setting the value for R_{SENSE} , the operating fan current should be measured to get the nominal value. This can be done by using an oscilloscope current probe or using a voltage probe with a low-value resistor (0.5 Ω). Another good tool for this exercise is the TC642 Evaluation Board. This board allows the R_{SENSE} and C_{SENSE} values to be easily changed while allowing the voltage waveforms to be monitored to ensure the proper levels are being reached.

Table 5-1 shows values of R_{SENSE} according to the nominal operating current of the fan. The fan currents are average values. If the fan current falls between two of the values listed, use the higher resistor value.

TC646B/TC648B/TC649B

TABLE 5-1: FAN CURRENT VS. R_{SENSE}

Nominal Fan Current (mA)	R_{SENSE} (Ω)
50	9.1
100	4.7
150	3.0
200	2.4
250	2.0
300	1.8
350	1.5
400	1.3
450	1.2
500	1.0

The values listed in Table 5-1 are for fans that have the fan current waveshape shown in Figure 4-7. With this waveshape, the average fan current is closer to the peak value, which requires the resistor value to be higher. When using a fan that has the fan current waveshape shown in Figure 4-6, the resistor value can often be decreased since the current peaks are higher than the average and it is the AC portion of the voltage that gets coupled to the SENSE pin.

The key point when selecting an R_{SENSE} value is to try to minimize the value in order to minimize the power dissipation in the resistor. In order to do this, it is critical to know the waveshape of the fan current and not just the average value.

Figure 5-4 shows some typical waveforms for the fan current and the voltage at the SENSE pin.



FIGURE 5-4: Typical Fan Current and SENSE Pin Waveforms.

Another important factor to consider when selecting the R_{SENSE} value is the fan current value during a locked-rotor condition. When a fan is in a locked-rotor condition (fan blades are stopped even though power is being applied to the fan), the fan current can increase dramatically (often 2.5 to 3.0 times the normal operating fan current). This will effect the power rating of the R_{SENSE} resistor selected.

When selecting the fan for the application, the current draw of the fan during a locked-rotor condition should be considered. Especially if multiple fans are being used in the application.

There are two main types of fan designs when looking at fan current draw during a locked-rotor condition.

The first is a fan that will simply draw high DC currents when put into a locked-rotor condition. Many older fans were designed this way. An example of this is a fan that draws an average current of 100 mA during normal operation. In a locked-rotor condition, this fan will draw 250 mA of average current. For this design, the R_{SENSE} power rating must be sized to handle the 250 mA condition. The fan bias supply must also take this into account.

The second style design, which represents many of the newer fan designs today, acts to limit the current in a locked-rotor condition by going into a pulse mode of operation. An example of the fan current waveshape for this style fan is shown in Figure 5-5. The fan represented in Figure 5-5 is a Panasonic[®], 12V, 220 mA fan. During the on-time of the waveform, the fan current is peaking up to 550 mA. Due to the pulse mode operation, the actual RMS current of the fan is very near the 220 mA rating. Because of this, the power rating for the R_{SENSE} resistor does not have to be oversized for this application.



FIGURE 5-5: Fan Current During a Locked Rotor Condition.

5.5 Output Drive Device Selection

The TC646B/TC648B/TC649B is designed to drive an external NPN transistor or N-channel MOSFET as the fan speed modulating element. These two arrangements are shown in Figure 5-7. For lower-current fans, NPN transistors are a very economical choice for the fan drive device. It is recommended that, for higher current fans (300 mA and above), MOSFETs be used as the fan drive device. Table 5-2 provides some possible part numbers for use as the fan drive element.

When using a NPN transistor as the fan drive element, a base current-limiting resistor must be used. This is shown in Figure 5-7.

When using MOSFETs as the fan drive element, it is very easy to turn the MOSFETs on and off at very high rates. Because the gate capacitances of these small MOSFETs are very low, the TC646B/TC648B/TC649B can charge and discharge them very quickly, leading to very fast edges. Of key concern is the turn-off edge of the MOSFET. Since the fan motor winding is essentially an inductor, once the MOSFET is turned off the current that was flowing through the motor wants to continue to flow. If the fan does not have internal clamp diodes around the windings of the motor, there is no path for this current to flow through and the voltage at the drain of the MOSFET may rise until the drain-to-source rating of the MOSFET is exceeded. This will most likely cause the MOSFET to go into avalanche mode. Since there is very little energy in this occurrence, it will probably not fail the device, but it would be a long-term reliability issue.

The following is recommended:

- Ask how the fan is designed. If the fan has clamp diodes internally, this problem will not be seen. If the fan does not have internal clamp diodes, it is a good idea to install one externally (Figure 5-6). Putting a resistor between V_{OUT} and the gate of the MOSFET will also help slow down the turn-off and limit this condition.



FIGURE 5-6: Clamp Diode For Fan Turn-Off.

TC646B/TC648B/TC649B



FIGURE 5-7: Output Drive Device Configurations.

TABLE 5-2: FAN DRIVE DEVICE SELECTION TABLE (NOTE 2)

Device	Package	Max Vbe sat / Vgs(V)	Min hfe	V _{CE} /V _{DS} (V)	Fan Current (mA)	Suggested Rbase (Ω)
MMBT2222A	SOT-23	1.2	50	40	150	800
MPS2222A	TO-92	1.2	50	40	150	800
MPS6602	TO-92	1.2	50	40	500	301
SI2302	SOT-23	2.5	NA	20	500	Note 1
MGSF1N02E	SOT-23	2.5	NA	20	500	Note 1
SI4410	SO-8	4.5	NA	30	1000	Note 1
SI2308	SOT-23	4.5	NA	60	500	Note 1

Note 1: A series gate resistor may be used in order to control the MOSFET turn-on and turn-off times.

Note 2: These drive devices are suggestions only. Fan currents listed are for individual fans.

5.6 Bias Supply Bypassing and Noise Filtering

The bias supply (V_{DD}) for the TC646B/TC648B/TC649B devices should be bypassed with a 1.0 μF ceramic capacitor. This capacitor will help supply the peak currents that are required to drive the base/gate of the external fan drive devices.

As the V_{IN} pin controls the duty cycle in a linear fashion, any noise on this pin can cause duty cycle jittering. For this reason, the V_{IN} pin should be bypassed with a 0.01 μF capacitor.

In order to keep fan noise off of the TC646B/TC648B/TC649B device ground, individual ground returns for the TC646B/TC648B/TC649B and the low side of the fan current sense resistor should be used.

5.7 Design Example/Typical Application

The system has been designed with the following components and criteria:

System inlet air ambient temperature ranges from 0°C to 50°C. At 20°C, system cooling is no longer required, so the fan is to be turned off. Prior to turn-off, the fan should be run at 40% of its full fan speed. Full fan speed should be reached when the ambient air is 40°C.

The system has a surface mount, NTC-style thermistor in a 1206 package. The thermistor is mounted on a daughtercard that is directly in the inlet air stream. The thermistor is a NTC, 100 kΩ @ 25°C, Thermometrics® part number NHQ104B425R5. The given Beta for the thermistor is 4250. The system bias voltage to run the fan controller is 5V, while the fan voltage is 12V.

TC646B/TC648B/TC649B

The fan used in the system is a Panasonic®, Panaflo®-series fan, model number FBA06T12H.

A fault indication is desired when the fan is in a locked-rotor condition. This signal is used to indicate to the system that cooling is not available and a warning should be issued to the user. No fault indication from the fan controller is necessary for an over-temperature condition as this is being reported elsewhere.

Step 1: Gathering Information.

The first step in the design process is to gather the needed data on the fan and thermistor. For the fan, it is also a good idea to look at the fan current waveform, as indicated earlier in the data sheet.

Fan Information: Panasonic number: FBA06T12H

- Voltage = 12V
- Current = 145 mA (data sheet number)



FIGURE 5-8: FBA06T12H Fan Current Waveform.

From the waveform in Figure 5-8, the fan current has an average value of 120 mA, with peaks up to 150 mA. This information will help in the selection of the R_{SENSE} and C_{SENSE} values later on. Also of interest for the R_{SENSE} selection value is what the fan current does in a locked-rotor condition.



FIGURE 5-9: FBA06T12H Locked-Rotor Fan Current.

From Figure 5-9, it is seen that in a locked-rotor fault condition, the fan goes into a pulsed current mode of operation. During this mode, when the fan is conducting current, the peak current value is 360 mA for periods of 200 msec. This is significantly higher than the average full fan speed current shown in Figure 5-8. However, because of the pulse mode, the average fan current in a locked-rotor condition is lower and was measured at 68 mA. The RMS current during this mode, which is necessary for current sense resistor (R_{SENSE}) value selection, was measured at 154 mA. This is slightly higher than the RMS value during full speed operation.

Thermistor Information: Thermometrics part number: NHQ104B425R5

- Resistance Value: 100 k Ω @ 25°C
- Beta Value (β): 4250

From this information, the thermistor values at 20°C and 40°C must be found. This information is needed in order to select the proper resistor values for R_1 and R_2 (see Figure 5-13), which sets the V_{IN} voltage.

The equation for determining the thermistor values is shown below:

EQUATION

$$R_T = R_{T0} \exp \left[\frac{\beta(T_0 - T)}{T \cdot T_0} \right]$$

R_{T0} is the thermistor value at 25°C. T_0 is 298.15 and T is the temperature of interest. All temperatures are in degrees kelvin.

Using this equation, the values for the thermistor are found to be:

- R_T (20°C) = 127,462 Ω
- R_T (40°C) = 50,520 Ω

TC646B/TC648B/TC649B

Step 2: Selecting the Fan Controller.

The requirements for the fan controller are that it have auto-shutdown capability at 20°C and also indicate a fan fault condition. No over-temperature indication is necessary. From these specifications, the proper selection is the TC649B device.

Step 3: Setting the PWM Frequency.

The fan is rated at 4200 RPM with a 12V input. The goal is to run to a 40% duty cycle (roughly 40% fan speed), which equates to approximately 1700 RPM. At 1700 RPM, one full fan revolution occurs every 35 msec. The fan being used is a four-pole fan that gives four current pulses per revolution. With this information, and viewing test results at 40% duty cycle, two fan current pulses were always seen during the PWM on time with a PWM frequency of 30 Hz. For this reason, the C_F value is selected to be 1.0 μ F.

Step 4: Setting the V_{IN} Voltage.

From the design criteria, the desired duty cycle at 20°C is 40% and full fan speed should be reached at 40°C. Based on a V_{IN} voltage range of 1.20V to 2.60V, which represents 0% to 100% duty cycle, the 40% duty cycle voltage can be found using the following equation:

EQUATION

$$V_{IN} = (DC * 1.4V) + 1.20V$$

$DC = \text{Desired Duty Cycle}$

Using the above equation, the V_{IN} values are calculated to be:

- V_{IN} (40%) = 1.76V
- V_{IN} (100%) = 2.60V

Using these values along with the thermistor resistance values calculated earlier, the R_1 and R_2 resistor values can now be calculated using the following equation:

EQUATION

$$V(T1) = \frac{V_{DD} \times R_2}{R_{TEMP}(T1) + R_2}$$

$$V(T2) = \frac{V_{DD} \times R_2}{R_{TEMP}(T2) + R_2}$$

R_{TEMP} is the parallel combination of R_1 and the thermistor. $V(T1)$ represents the V_{IN} voltage at 20°C and $V(T2)$ represents the V_{IN} voltage at 40°C. Solving the equations simultaneously yields the following values ($V_{DD} = 5V$):

- $R_1 = 238,455 \Omega$
- $R_2 = 45,161 \Omega$

Using standard 1% resistor values, the selected R_1 and R_2 values are:

- $R_1 = 237 \text{ k}\Omega$
- $R_2 = 45.3 \text{ k}\Omega$

A graph of the V_{IN} voltage, thermistor resistance and R_{TEMP} resistance versus temperature for this configuration is shown in Figure 5-10.

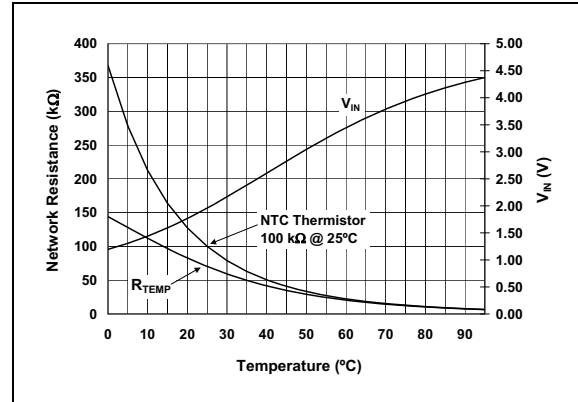

FIGURE 5-10: Thermistor Resistance, V_{IN} and R_{TEMP} vs. Temperature

Step 5: Setting the Auto-Shutdown Voltage (V_{AS}).

Setting the voltage for the auto-shutdown is done using a simple resistor voltage divider. The criteria for the voltage divider in this design is that it draw no more than 100 μ A of current. The required auto-shutdown voltage was determined earlier in the selection of the V_{IN} voltage at 40% duty cycle, since this was also set at the temperature that auto-shutdown is to occur (20°C).

- $V_{AS} = 1.76V$

Given this desired setpoint and knowing the desired divider current, the following equations can be used to solve for the resistor values for R_3 and R_4 :

EQUATION

$$I_{DIV} = \frac{5V}{R_3 + R_4}$$

$$V_{AS} = \frac{5V * R_4}{R_3 + R_4}$$

Using the equations above, the resistor values for R_3 and R_4 are found to be:

- $R_3 = 32.4 \text{ k}\Omega$
- $R_4 = 17.6 \text{ k}\Omega$

Using standard 1% resistor values yields the following values:

- $R_3 = 32.4 \text{ k}\Omega$
- $R_4 = 17.8 \text{ k}\Omega$

Step 6: Selecting the Fan Drive Device (Q_1).

Since the fan operating current is below 200 mA, a transistor or MOSFET can be used as the fan drive device. In order to reduce component count and current draw, the drive device for this design is chosen to be a N-channel MOSFET. Selecting from Table 5-2, there are two MOSFETs that are good choices, the MGSF1N02E and the SI2302. These devices have the same pinout and are interchangeable for this design.

Step 7: Selecting the R_{SENSE} and C_{SENSE} Values.

The goal again for selecting these values is to ensure that the signal at the SENSE pin is 90 mV in amplitude under all operating conditions. This will ensure that the pulses are detected by the TC649B device and that the fan operation is detected.

The fan current waveform is shown in Figure 5-8, and as discussed previously, with a waveform of this shape, the current sense resistor values shown in Table 5-1 are good reference values. Given the average fan operating current was measured to be 120 mA, this falls between two of the values listed in the table. For reference purposes, both values have been tested and these results are shown in Figures 5-11 (4.7Ω) and 5-12 (3.0Ω). The selected C_{SENSE} value is $0.1\mu\text{F}$, as this provides the appropriate coupling of the voltage to the SENSE pin.



FIGURE 5-11: SENSE pin voltage with 4.7Ω sense resistor.



FIGURE 5-12: SENSE pin voltage with 3.0Ω sense resistor.

Since the 3.0Ω value of sense resistor provides the proper voltage to the SENSE pin, it is the correct choice for this solution as it will also provide the lowest power dissipation and the maximum amount of voltage to the fan. Using the RMS fan current which was measured previously, the power dissipation in the resistor during a fan fault condition is 71 mW ($I_{\text{rms}}^2 * R_{\text{SENSE}}$). This number will set the wattage rating of the resistor that is selected. The selected value will vary depending upon the derating guidelines that are used.

Now that all the values have been selected, the schematic representation of this design can be seen in Figure 5-13.

TC646B/TC648B/TC649B



FIGURE 5-13: Design Example Schematic.

Bypass capacitor C_{VDD} is added to the design to decouple the bias voltage. This is good to have, especially when using a MOSFET as the drive device. This helps to give a localized low-impedance source for the current required to charge the gate capacitance of Q_1 . Two other bypass capacitors (labeled as C_B) were also added to decouple the V_{IN} and V_{AS} nodes. These were added simply to remove any noise present that might cause false triggerings or PWM jitter. R_5 is the pull-up resistor for the \overline{FAULT} output. The value for this resistor is system-dependent.

TC646B/TC648B/TC649B

6.0 PACKAGING INFORMATION

6.1 Package Marking Information

8-Lead PDIP (300 mil)

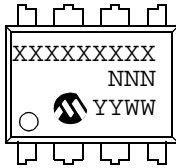

Example:

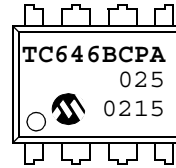

8-Lead SOIC (150 mil)

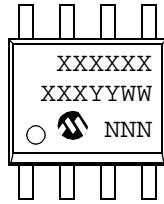

Example:



8-Lead MSOP

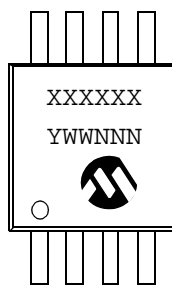

Example:

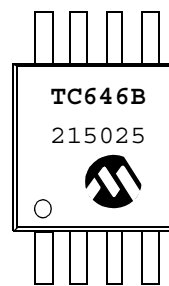

Legend:	XX...X	Customer-specific information
	Y	Year code (last digit of calendar year)
	YY	Year code (last 2 digits of calendar year)
	WW	Week code (week of January 1 is week '01')
	NNN	Alphanumeric traceability code
	(e3)	Pb-free JEDEC designator for Matte Tin (Sn)
	*	This package is Pb-free. The Pb-free JEDEC designator (e3) can be found on the outer packaging for this package.

Note: In the event the full Microchip part number cannot be marked on one line, it will be carried over to the next line, thus limiting the number of available characters for customer-specific information.

TC646B/TC648B/TC649B

8-Lead Plastic Dual In-line (PA) – 300 mil (PDIP)

Note: For the most current package drawings, please see the Microchip Packaging Specification located at <http://www.microchip.com/packaging>



Units		INCHES*			MILLIMETERS		
Dimension Limits		MIN	NOM	MAX	MIN	NOM	MAX
Number of Pins	n		8			8	
Pitch	P		.100			2.54	
Top to Seating Plane	A	.140	.155	.170	3.56	3.94	4.32
Molded Package Thickness	A2	.115	.130	.145	2.92	3.30	3.68
Base to Seating Plane	A1	.015			0.38		
Shoulder to Shoulder Width	E	.300	.313	.325	7.62	7.94	8.26
Molded Package Width	E1	.240	.250	.260	6.10	6.35	6.60
Overall Length	D	.360	.373	.385	9.14	9.46	9.78
Tip to Seating Plane	L	.125	.130	.135	3.18	3.30	3.43
Lead Thickness	c	.008	.012	.015	0.20	0.29	0.38
Upper Lead Width	B1	.045	.058	.070	1.14	1.46	1.78
Lower Lead Width	B	.014	.018	.022	0.36	0.46	0.56
Overall Row Spacing	§ eB	.310	.370	.430	7.87	9.40	10.92
Mold Draft Angle Top	α	5	10	15	5	10	15
Mold Draft Angle Bottom	β	5	10	15	5	10	15

* Controlling Parameter

§ Significant Characteristic

Notes:

Dimensions D and E1 do not include mold flash or protrusions. Mold flash or protrusions shall not exceed .010" (0.254mm) per side.

JEDEC Equivalent: MS-001

Drawing No. C04-018

TC646B/TC648B/TC649B

8-Lead Plastic Small Outline (OA) – Narrow, 150 mil (SOIC)

Note: For the most current package drawings, please see the Microchip Packaging Specification located at <http://www.microchip.com/packaging>



Dimension	Units	INCHES*			MILLIMETERS		
		MIN	NOM	MAX	MIN	NOM	MAX
Number of Pins	n		8			8	
Pitch	p		.050			1.27	
Overall Height	A	.053	.061	.069	1.35	1.55	1.75
Molded Package Thickness	A2	.052	.056	.061	1.32	1.42	1.55
Standoff §	A1	.004	.007	.010	0.10	0.18	0.25
Overall Width	E	.228	.237	.244	5.79	6.02	6.20
Molded Package Width	E1	.146	.154	.157	3.71	3.91	3.99
Overall Length	D	.189	.193	.197	4.80	4.90	5.00
Chamfer Distance	h	.010	.015	.020	0.25	0.38	0.51
Foot Length	L	.019	.025	.030	0.48	0.62	0.76
Foot Angle	f	0	4	8	0	4	8
Lead Thickness	c	.008	.009	.010	0.20	0.23	0.25
Lead Width	B	.013	.017	.020	0.33	0.42	0.51
Mold Draft Angle Top	α	0	12	15	0	12	15
Mold Draft Angle Bottom	β	0	12	15	0	12	15

* Controlling Parameter
 § Significant Characteristic

Notes:

Dimensions D and E1 do not include mold flash or protrusions. Mold flash or protrusions shall not exceed .010" (0.254mm) per side.
 JEDEC Equivalent: MS-012
 Drawing No. C04-057

TC646B/TC648B/TC649B

8-Lead Plastic Micro Small Outline Package (UA) (MSOP)

Note: For the most current package drawings, please see the Microchip Packaging Specification located at <http://www.microchip.com/packaging>



Dimension Limits	Units	INCHES			MILLIMETERS*		
		MIN	NOM	MAX	MIN	NOM	MAX
Number of Pins	n		8			8	
Pitch	p	.026 BSC			0.65 BSC		
Overall Height	A	-	-	.043	-	-	1.10
Molded Package Thickness	A2	.030	.033	.037	0.75	0.85	0.95
Standoff	A1	.000	-	.006	0.00	-	0.15
Overall Width	E	.193 TYP.			4.90 BSC		
Molded Package Width	E1	.118 BSC			3.00 BSC		
Overall Length	D	.118 BSC			3.00 BSC		
Foot Length	L	.016	.024	.031	0.40	0.60	0.80
Footprint (Reference)	F	.037 REF			0.95 REF		
Foot Angle	φ	0°	-	8°	0°	-	8°
Lead Thickness	c	.003	.006	.009	0.08	-	0.23
Lead Width	B	.009	.012	.016	0.22	-	0.40
Mold Draft Angle Top	α	5°	-	15°	5°	-	15°
Mold Draft Angle Bottom	β	5°	-	15°	5°	-	15°

*Controlling Parameter

Notes:

Dimensions D and E1 do not include mold flash or protrusions. Mold flash or protrusions shall not exceed .010" (0.254mm) per side.

JEDEC Equivalent: MO-187

Drawing No. C04-111

TC646B/TC648B/TC649B

6.2 Taping Form

Component Taping Orientation for 8-Pin MSOP Devices



Carrier Tape, Number of Components Per Reel and Reel Size:

Package	Carrier Width (W)	Pitch (P)	Part Per Full Reel	Reel Size
8-Pin MSOP	12 mm	8 mm	2500	13 in.

Component Taping Orientation for 8-Pin SOIC Devices



Carrier Tape, Number of Components Per Reel and Reel Size:

Package	Carrier Width (W)	Pitch (P)	Part Per Full Reel	Reel Size
8-Pin SOIC	12 mm	8 mm	2500	13 in.

TC646B/TC648B/TC649B

7.0 REVISION HISTORY

Revision C (January 2013)

Added a note to each package outline drawing.

TC646B/TC648B/TC649B

PRODUCT IDENTIFICATION SYSTEM

To order or obtain information, e.g., on pricing or delivery, refer to the factory or the listed sales office.

<u>PART NO.</u>	<u>X</u>	<u>/XX</u>
Device	Temperature Range	Package
Device:	TC646B: PWM Fan Speed Controller with Fan Restart, Auto-Shutdown, Fan Fault and Over-Temp Detection TC648B: PWM Fan Speed Controller with Auto-Shutdown and Over-Temp Detection TC649B: PWM Fan Speed Controller with Fan Restart, Auto-Shutdown and Fan Fault Detection	
Temperature Range:	E = -40°C to +85°C	
Package:	OA = Plastic SOIC, (150 mil Body), 8-lead PA = Plastic DIP (300 mil Body), 8-lead UA = Plastic Micro Small Outline (MSOP), 8-lead 713 = Tape and Reel (SOIC and MSOP) (TC646B and TC648B only) TR = Tape and Reel (SOIC and MSOP) (TC649B only)	

Examples:

- a) TC646BEOA: SOIC package.
- b) TC646BEOA713: Tape and Reel, SOIC package.
- c) TC646BEP A: PDIP package.
- d) TC646BEUA: MSOP package.

- a) TC648BEOA: SOIC package.
- b) TC648BEP A: PDIP package.
- c) TC648BEUA: MSOP package.
- d) TC648BEUA713: Tape and Reel, MSOP package.

- a) TC649BEOA: SOIC package.
- b) TC649BEOATR: Tape and Reel, SOIC package.
- c) TC649BEP A: PDIP package.
- d) TC649BEUA: MSOP package.

Sales and Support

Data Sheets

Products supported by a preliminary Data Sheet may have an errata sheet describing minor operational differences and recommended workarounds. To determine if an errata sheet exists for a particular device, please contact one of the following:

1. Your local Microchip sales office
2. The Microchip Worldwide Site (www.microchip.com)

Please specify which device, revision of silicon and Data Sheet (include Literature #) you are using.

Customer Notification System

Register on our web site (www.microchip.com/cn) to receive the most current information on our products.

TC646B/TC648B/TC649B

NOTES:

Note the following details of the code protection feature on Microchip devices:

- Microchip products meet the specification contained in their particular Microchip Data Sheet.
- Microchip believes that its family of products is one of the most secure families of its kind on the market today, when used in the intended manner and under normal conditions.
- There are dishonest and possibly illegal methods used to breach the code protection feature. All of these methods, to our knowledge, require using the Microchip products in a manner outside the operating specifications contained in Microchip's Data Sheets. Most likely, the person doing so is engaged in theft of intellectual property.
- Microchip is willing to work with the customer who is concerned about the integrity of their code.
- Neither Microchip nor any other semiconductor manufacturer can guarantee the security of their code. Code protection does not mean that we are guaranteeing the product as “unbreakable.”

Code protection is constantly evolving. We at Microchip are committed to continuously improving the code protection features of our products. Attempts to break Microchip's code protection feature may be a violation of the Digital Millennium Copyright Act. If such acts allow unauthorized access to your software or other copyrighted work, you may have a right to sue for relief under that Act.

Information contained in this publication regarding device applications and the like is provided only for your convenience and may be superseded by updates. It is your responsibility to ensure that your application meets with your specifications. MICROCHIP MAKES NO REPRESENTATIONS OR WARRANTIES OF ANY KIND WHETHER EXPRESS OR IMPLIED, WRITTEN OR ORAL, STATUTORY OR OTHERWISE, RELATED TO THE INFORMATION, INCLUDING BUT NOT LIMITED TO ITS CONDITION, QUALITY, PERFORMANCE, MERCHANTABILITY OR FITNESS FOR PURPOSE. Microchip disclaims all liability arising from this information and its use. Use of Microchip devices in life support and/or safety applications is entirely at the buyer's risk, and the buyer agrees to defend, indemnify and hold harmless Microchip from any and all damages, claims, suits, or expenses resulting from such use. No licenses are conveyed, implicitly or otherwise, under any Microchip intellectual property rights.

Trademarks

The Microchip name and logo, the Microchip logo, dsPIC, FlashFlex, KEELOQ, KEELOQ logo, MPLAB, PIC, PICmicro, PICSTART, PIC³² logo, rPIC, SST, SST Logo, SuperFlash and UNI/O are registered trademarks of Microchip Technology Incorporated in the U.S.A. and other countries.

FilterLab, Hampshire, HI-TECH C, Linear Active Thermistor, MTP, SEEVAL and The Embedded Control Solutions Company are registered trademarks of Microchip Technology Incorporated in the U.S.A.

Silicon Storage Technology is a registered trademark of Microchip Technology Inc. in other countries.

Analog-for-the-Digital Age, Application Maestro, BodyCom, chipKIT, chipKIT logo, CodeGuard, dsPICDEM, dsPICDEM.net, dsPICworks, dsSPEAK, ECAN, ECONOMONITOR, FanSense, HI-TIDE, In-Circuit Serial Programming, ICSP, Mindi, MiWi, MPASM, MPF, MPLAB Certified logo, MPLIB, MPLINK, mTouch, Omniscent Code Generation, PICC, PICC-18, PICDEM, PICDEM.net, PICkit, PICtail, REAL ICE, rLAB, Select Mode, SQI, Serial Quad I/O, Total Endurance, TSHARC, UniWinDriver, WiperLock, ZENA and Z-Scale are trademarks of Microchip Technology Incorporated in the U.S.A. and other countries.

SQTP is a service mark of Microchip Technology Incorporated in the U.S.A.

GestIC and ULPP are registered trademarks of Microchip Technology Germany II GmbH & Co. & KG, a subsidiary of Microchip Technology Inc., in other countries.

All other trademarks mentioned herein are property of their respective companies.

© 2002-2013, Microchip Technology Incorporated, Printed in the U.S.A., All Rights Reserved.

 Printed on recycled paper.

ISBN: 9781620768976

QUALITY MANAGEMENT SYSTEM
CERTIFIED BY DNV
== ISO/TS 16949 ==

Microchip received ISO/TS-16949:2009 certification for its worldwide headquarters, design and wafer fabrication facilities in Chandler and Tempe, Arizona; Gresham, Oregon and design centers in California and India. The Company's quality system processes and procedures are for its PIC[®] MCUs and dsPIC[®] DSCs, KEELOQ[®] code hopping devices, Serial EEPROMs, microperipherals, nonvolatile memory and analog products. In addition, Microchip's quality system for the design and manufacture of development systems is ISO 9001:2000 certified.



MICROCHIP

Worldwide Sales and Service

AMERICAS

Corporate Office
2355 West Chandler Blvd.
Chandler, AZ 85224-6199
Tel: 480-792-7200
Fax: 480-792-7277
Technical Support:
<http://www.microchip.com/support>
Web Address:
www.microchip.com

Atlanta
Duluth, GA
Tel: 678-957-9614
Fax: 678-957-1455

Boston
Westborough, MA
Tel: 774-760-0087
Fax: 774-760-0088

Chicago
Itasca, IL
Tel: 630-285-0071
Fax: 630-285-0075

Cleveland
Independence, OH
Tel: 216-447-0464
Fax: 216-447-0643

Dallas
Addison, TX
Tel: 972-818-7423
Fax: 972-818-2924

Detroit
Farmington Hills, MI
Tel: 248-538-2250
Fax: 248-538-2260

Indianapolis
Noblesville, IN
Tel: 317-773-8323
Fax: 317-773-5453

Los Angeles
Mission Viejo, CA
Tel: 949-462-9523
Fax: 949-462-9608

Santa Clara
Santa Clara, CA
Tel: 408-961-6444
Fax: 408-961-6445

Toronto
Mississauga, Ontario,
Canada
Tel: 905-673-0699
Fax: 905-673-6509

ASIA/PACIFIC

Asia Pacific Office
Suites 3707-14, 37th Floor
Tower 6, The Gateway
Harbour City, Kowloon
Hong Kong
Tel: 852-2401-1200
Fax: 852-2401-3431

Australia - Sydney
Tel: 61-2-9868-6733
Fax: 61-2-9868-6755

China - Beijing
Tel: 86-10-8569-7000
Fax: 86-10-8528-2104

China - Chengdu
Tel: 86-28-8665-5511
Fax: 86-28-8665-7889

China - Chongqing
Tel: 86-23-8980-9588
Fax: 86-23-8980-9500

China - Hangzhou
Tel: 86-571-2819-3187
Fax: 86-571-2819-3189

China - Hong Kong SAR
Tel: 852-2943-5100
Fax: 852-2401-3431

China - Nanjing
Tel: 86-25-8473-2460
Fax: 86-25-8473-2470

China - Qingdao
Tel: 86-532-8502-7355
Fax: 86-532-8502-7205

China - Shanghai
Tel: 86-21-5407-5533
Fax: 86-21-5407-5066

China - Shenyang
Tel: 86-24-2334-2829
Fax: 86-24-2334-2393

China - Shenzhen
Tel: 86-755-8864-2200
Fax: 86-755-8203-1760

China - Wuhan
Tel: 86-27-5980-5300
Fax: 86-27-5980-5118

China - Xian
Tel: 86-29-8833-7252
Fax: 86-29-8833-7256

China - Xiamen
Tel: 86-592-2388138
Fax: 86-592-2388130

China - Zhuhai
Tel: 86-756-3210040
Fax: 86-756-3210049

ASIA/PACIFIC

India - Bangalore
Tel: 91-80-3090-4444
Fax: 91-80-3090-4123

India - New Delhi
Tel: 91-11-4160-8631
Fax: 91-11-4160-8632

India - Pune
Tel: 91-20-2566-1512
Fax: 91-20-2566-1513

Japan - Osaka
Tel: 81-6-6152-7160
Fax: 81-6-6152-9310

Japan - Tokyo
Tel: 81-3-6880-3770
Fax: 81-3-6880-3771

Korea - Daegu
Tel: 82-53-744-4301
Fax: 82-53-744-4302

Korea - Seoul
Tel: 82-2-554-7200
Fax: 82-2-558-5932 or
82-2-558-5934

Malaysia - Kuala Lumpur
Tel: 60-3-6201-9857
Fax: 60-3-6201-9859

Malaysia - Penang
Tel: 60-4-227-8870
Fax: 60-4-227-4068

Philippines - Manila
Tel: 63-2-634-9065
Fax: 63-2-634-9069

Singapore
Tel: 65-6334-8870
Fax: 65-6334-8850

Taiwan - Hsin Chu
Tel: 886-3-5778-366
Fax: 886-3-5770-955

Taiwan - Kaohsiung
Tel: 886-7-213-7828
Fax: 886-7-330-9305

Taiwan - Taipei
Tel: 886-2-2508-8600
Fax: 886-2-2508-0102

Thailand - Bangkok
Tel: 66-2-694-1351
Fax: 66-2-694-1350

EUROPE

Austria - Wels
Tel: 43-7242-2244-39
Fax: 43-7242-2244-393

Denmark - Copenhagen
Tel: 45-4450-2828
Fax: 45-4485-2829

France - Paris
Tel: 33-1-69-53-63-20
Fax: 33-1-69-30-90-79

Germany - Munich
Tel: 49-89-627-144-0
Fax: 49-89-627-144-44

Italy - Milan
Tel: 39-0331-742611
Fax: 39-0331-466781

Netherlands - Drunen
Tel: 31-416-690399
Fax: 31-416-690340

Spain - Madrid
Tel: 34-91-708-08-90
Fax: 34-91-708-08-91

UK - Wokingham
Tel: 44-118-921-5869
Fax: 44-118-921-5820

11/29/12

Данный компонент на территории Российской Федерации

Вы можете приобрести в компании MosChip.

Для оперативного оформления запроса Вам необходимо перейти по данной ссылке:

<http://moschip.ru/get-element>

Вы можете разместить у нас заказ для любого Вашего проекта, будь то серийное производство или разработка единичного прибора.

В нашем ассортименте представлены ведущие мировые производители активных и пассивных электронных компонентов.

Нашей специализацией является поставка электронной компонентной базы двойного назначения, продукции таких производителей как XILINX, Intel (ex.ALTERA), Vicor, Microchip, Texas Instruments, Analog Devices, Mini-Circuits, Amphenol, Glenair.

Сотрудничество с глобальными дистрибьюторами электронных компонентов, предоставляет возможность заказывать и получать с международных складов практически любой перечень компонентов в оптимальные для Вас сроки.

На всех этапах разработки и производства наши партнеры могут получить квалифицированную поддержку опытных инженеров.

Система менеджмента качества компании отвечает требованиям в соответствии с ГОСТ Р ИСО 9001, ГОСТ РВ 0015-002 и ЭС РД 009

Офис по работе с юридическими лицами:

105318, г.Москва, ул.Щербаковская д.3, офис 1107, 1118, ДЦ «Щербаковский»

Телефон: +7 495 668-12-70 (многоканальный)

Факс: +7 495 668-12-70 (доб.304)

E-mail: info@moschip.ru

Skype отдела продаж:

moschip.ru

moschip.ru_4

moschip.ru_6

moschip.ru_9