

Chip Wire Wound Common Mode Choke

ACM-21



RoHS
Compliant



2.0 x 1.2 x 1.2mm

FEATURES:

- Small size with ferrite base
- Two line type wire wound
- High common-mode impedance at noise band and low differential-mode impedance at signal band
- Suitable for high-speed signal.

APPLICATIONS:

- EMI and Noise Suppression
- USB Line Filter for Personal Computers and Peripheral
- IEEE 1394 Line for Personal Computers, DVC, STB
- Low-Voltage Differential Signal (LVDS) for LCD panels

STANDARD SPECIFICATIONS

Abrakon P/N:	ACM-21
Operating Temperature & Humidity:	-40°C to +85°C
Storage Temperature & Humidity:	22°C to 28°C, Humidity < 80%RH (In tape and reel)

Part Number	Z	DCR	IDC	Rated Voltage	Withstanding Voltage	Insulation Resistance
Units	$\Omega \pm 20\%$	Ω (max.)	mA	Vdc	Vdc	M Ω (min.)
ACM-21-300	30	0.20	450	50	125	10
ACM-21-670	67	0.25	400	50	125	10
ACM-21-900	90	0.30	400	50	125	10
ACM-21-121	120	0.30	370	50	125	10
ACM-21-161	160	0.35	330	50	125	10
ACM-21-181	180	0.35	330	50	125	10
ACM-21-201	200	0.35	330	50	125	10
ACM-21-221	220	0.35	330	50	125	10
ACM-21-261	260	0.40	300	50	125	10
ACM-21-361	360	0.40	280	50	125	10
ACM-21-371	370	0.40	280	50	125	10

Test Conditions

Impedance: LCR Meter HP 4291B, 100MHz

DCR: Micro-Ohm meter (GOM-801G)

Withstand Voltage (VDC): 125Vdc, 60 sec, 0.5mA

Rated Voltage (VDC): 50Vdc, 1 – 5 sec

Insulation Resistance (I.R): 1mA, 1 min

PART IDENTIFICATION:

ACM-21 - M -



Impedance Code

Please refer to the table above

Packaging

Blank: bulk
T: Tape and Reel
(2k pcs/reel)

Chip Wire Wound Common Mode Choke

ACM-21



RoHS
Compliant



2.0 x 1.2 x 1.2mm

ELECTRICAL CHARACTERISTIC CURVE:

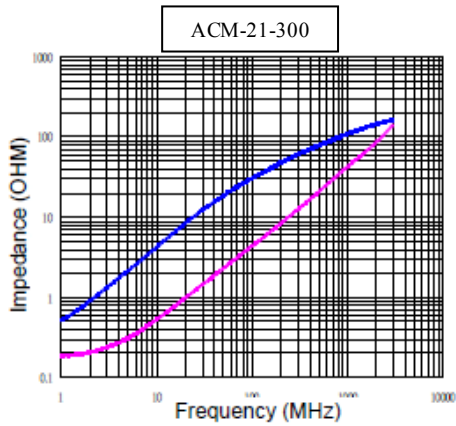

Chip Wire Wound Common Mode Choke

ACM-21



RoHS
Compliant



2.0 x 1.2 x 1.2mm

ELECTRICAL CHARACTERISTIC CURVE:

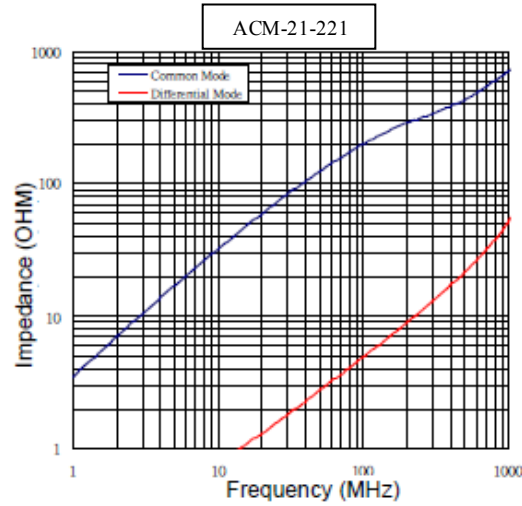

Chip Wire Wound Common Mode Choke

ACM-21



RoHS
Compliant



2.0 x 1.2 x 1.2mm

OUTLINE DIMENSIONS:

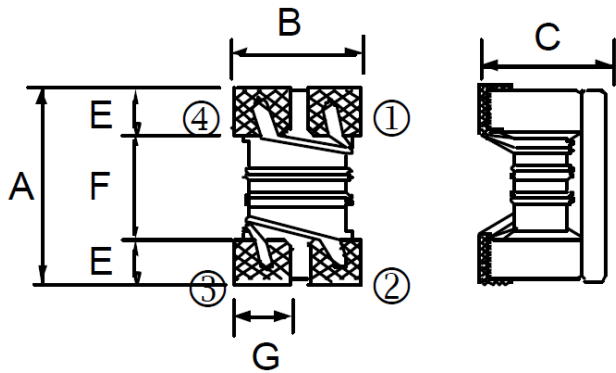

Recommended Land Pattern

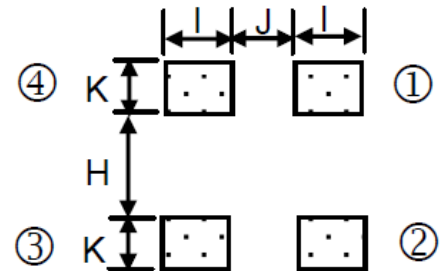

A	B	C	E	F	G
2.0±0.2	1.2±0.2	1.2±0.2	0.45	1.2	0.4

H	I	J	K
0.8	0.4	0.4	0.90

Schematic

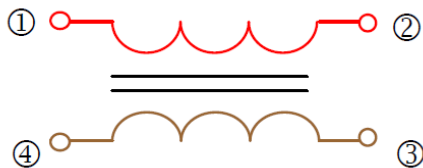

REFLOW PROFILE:

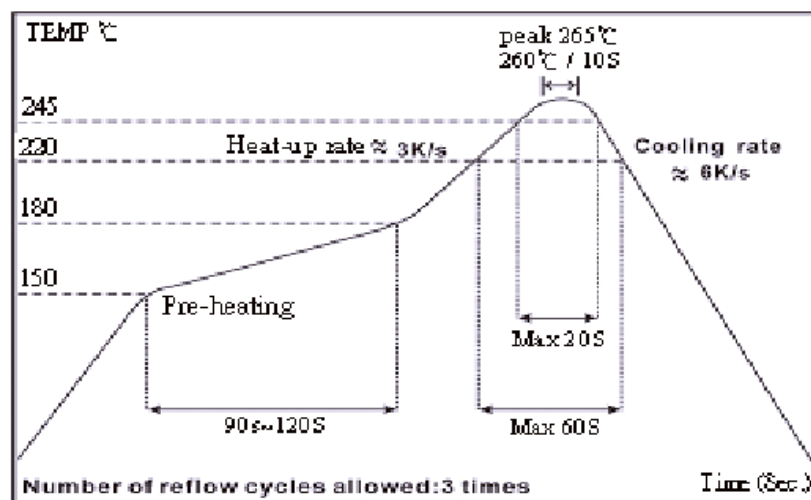

Chip Wire Wound Common Mode Choke

ACM-21



2.0 x 1.2 x 1.2mm

TAPE & REEL: 2000pcs/reel



A	B	W	E	F	P0	P1	P2	ΦD_0	t
1.40±0.10	2.55±0.05	8.0±0.20	1.75±0.10	3.5±0.10	4.00±0.10	4.00±0.10	2.00±0.10	1.50+0.10	1.35±0.10



ΦA	ΦB	ΦC	W	T
178±2.0	60±0.5	13±0.3	9+0.3	11.4±1.0

Dimension: mm

ATTENTION: Abracon Corporation's products are COTS – Commercial-Off-The-Shelf products; suitable for Commercial, Industrial and, where designated, Automotive Applications. Abracon's products are not specifically designed for Military, Aviation, Aerospace, Life-dependant Medical applications or any application requiring high reliability where component failure could result in loss of life and/or property. For applications requiring high reliability and/or presenting an extreme operating environment, written consent and authorization from Abracon Corporation is required. Please contact Abracon Corporation for more information.

ABRACON IS
ISO 9001:2008
CERTIFIED



Visit www.abracon.com for Terms & Conditions of Sale **Revised: 01.27.14**
30332 Esperanza, Rancho Santa Margarita, California 92688
tel 949-546-8000 | fax 949-546-8001 | www.abracon.com

Данный компонент на территории Российской Федерации

Вы можете приобрести в компании MosChip.

Для оперативного оформления запроса Вам необходимо перейти по данной ссылке:

<http://moschip.ru/get-element>

Вы можете разместить у нас заказ для любого Вашего проекта, будь то серийное производство или разработка единичного прибора.

В нашем ассортименте представлены ведущие мировые производители активных и пассивных электронных компонентов.

Нашей специализацией является поставка электронной компонентной базы двойного назначения, продукции таких производителей как XILINX, Intel (ex.ALTERA), Vicor, Microchip, Texas Instruments, Analog Devices, Mini-Circuits, Amphenol, Glenair.

Сотрудничество с глобальными дистрибьюторами электронных компонентов, предоставляет возможность заказывать и получать с международных складов практически любой перечень компонентов в оптимальные для Вас сроки.

На всех этапах разработки и производства наши партнеры могут получить квалифицированную поддержку опытных инженеров.

Система менеджмента качества компании отвечает требованиям в соответствии с ГОСТ Р ИСО 9001, ГОСТ РВ 0015-002 и ЭС РД 009

Офис по работе с юридическими лицами:

105318, г.Москва, ул.Щербаковская д.3, офис 1107, 1118, ДЦ «Щербаковский»

Телефон: +7 495 668-12-70 (многоканальный)

Факс: +7 495 668-12-70 (доб.304)

E-mail: info@moschip.ru

Skype отдела продаж:

moschip.ru

moschip.ru_4

moschip.ru_6

moschip.ru_9