

DATA SHEET
SE5007BT: 5 GHz Front-End Module with Power Detector

Applications

- 5 GHz WLAN (IEEE802.11a/g/n)
- Access Points, PCMCIA, PC cards, Handhelds

Features

- 5GHz Front End Module with PA, LNA and T/R Switch
- Integrated power amplifier enable pin (V_{EN})
- Buffered, temperature compensated power detector
- High and Low-Linearity mode
- 3% EVM, @17dBm, 64 QAM, 54 Mbps
- 30 dB Typical Gain
- Lead Free and RoHS compliant, halogen free package
- 16 pin 3 mm x 3 mm x 0.6 mm QFN, MSL1

Product Description

The SE5007BT is a 5GHz front end module offering high linear power for wireless LAN applications. It incorporates a power detector for control of the output power.

The SE5007BT offers a high level of integration for a simplified design, providing quicker time to market and higher application board production yield. The device integrates inter-stage match, a temperature compensated, load insensitive power detector with 20dB of dynamic range, a 3.8GHz notch filter, a T/R switch and an Rx LNA.

For wireless LAN applications, the device meets the requirements of IEEE802.11a and delivers approximately 17dBm of linear output power. It also features a low linearity mode control to reduce current consumption at low power modes.

The SE5007BT integrates the reference voltage generator, allowing for a true 1.8V CMOS compatible digital EN (enable) function to turn the power amplifier on and off.

Ordering Information

| Part Number | Package | Remark |
|--------------|----------------|---------------|
| SE5007BT | 16 Pin QFN | Samples |
| SE5007BT-R | 16 Pin QFN | Tape and Reel |
| SE5007BT-EK1 | Evaluation Kit | Standard |

Functional Block Diagram

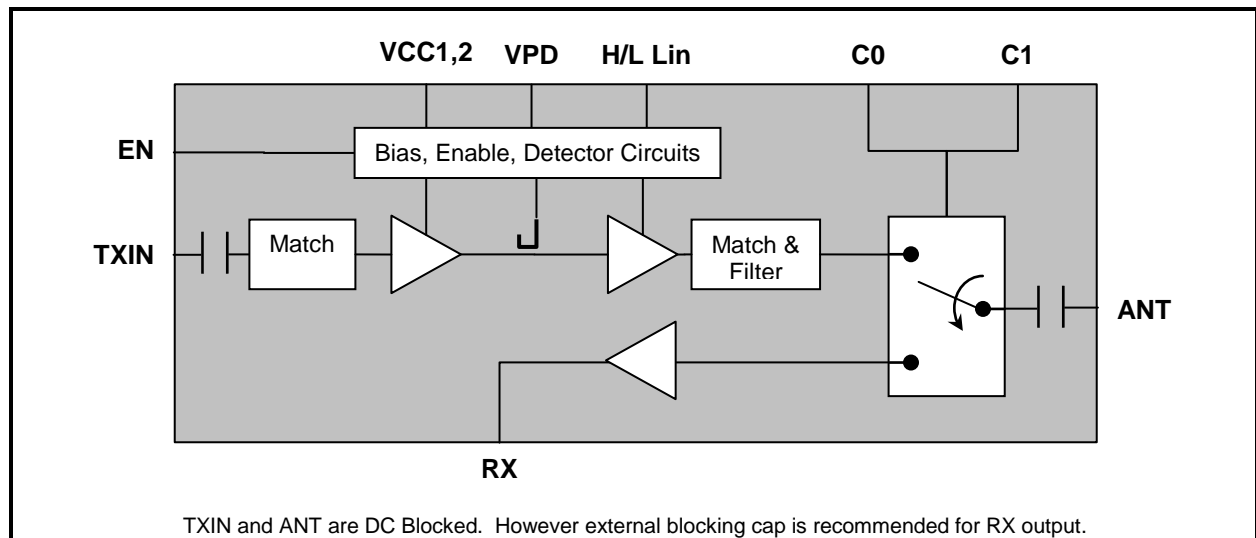

Figure 1: Functional Block Diagram

DATA SHEET
SE5007BT: 5 GHz Front-End Module with Power Detector

Pin Out Diagram

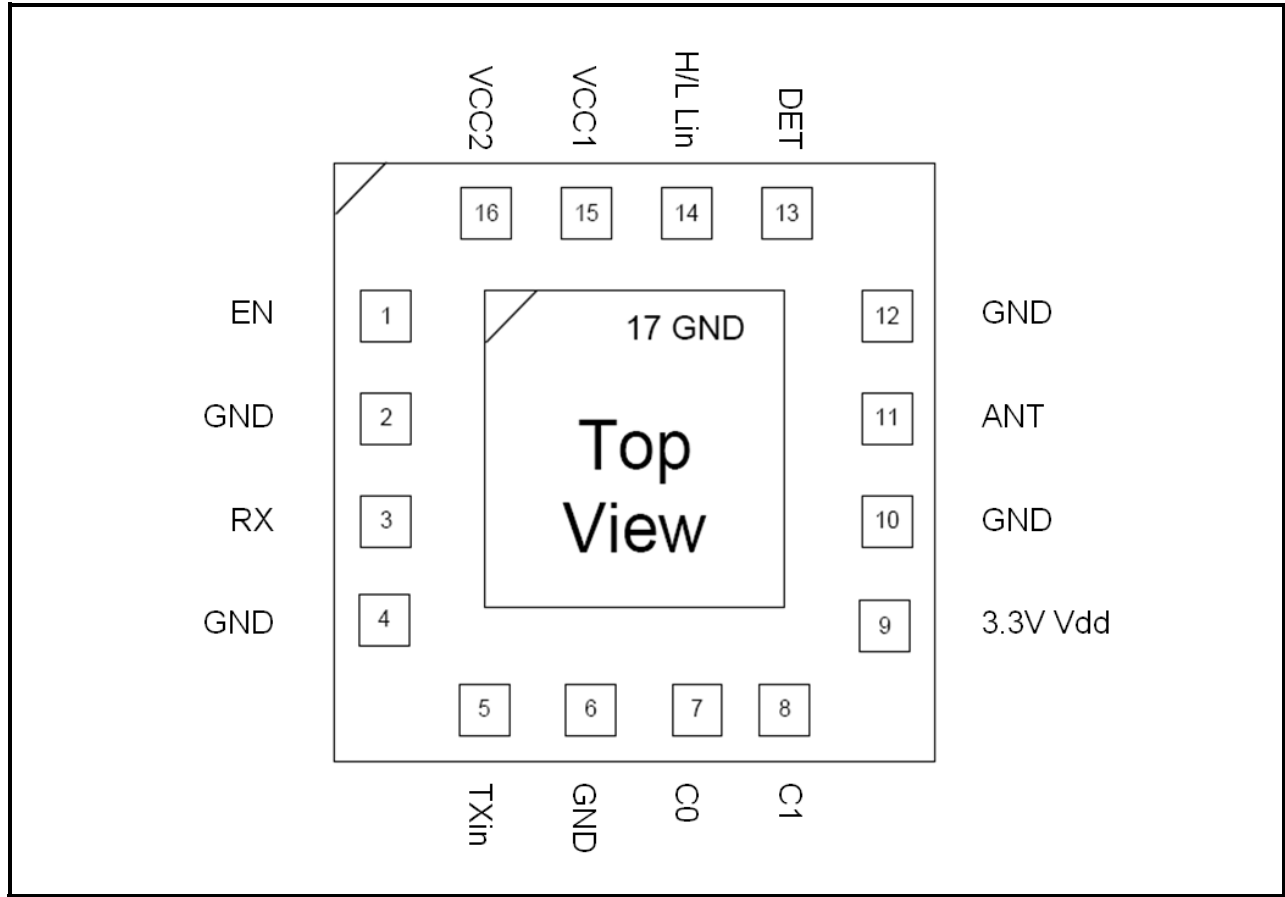

Figure 2: SE5007BT Pin-Out Diagram

Pin Out Description

| Pin No. | Name | Description |
|---------|------|-------------------------|
| 1 | EN | PA Enable |
| 2 | GND | Ground |
| 3 | RX | 5GHz LNA Output Signal |
| 4 | GND | Ground |
| 5 | TXIN | 5GHz TX RF Input Signal |
| 6 | GND | Ground |
| 7 | C0 | Switch Control Logic 1 |
| 8 | C1 | Switch Control Logic 2 |

| Pin No. | Name | Description |
|---------|---------|--------------------------------------|
| 9 | VDD | LNA Supply Voltage (3.3V+/-10% only) |
| 10 | GND | Ground |
| 11 | ANT | 5GHz Antenna output |
| 12 | GND | Ground |
| 13 | DET | Power Detector Output |
| 14 | H/L Lin | High-Low linearity Control |
| 15 | VCC1 | Power Stage Supply Voltage |
| 16 | VCC2 | Bias, Driver Stage Supply Voltage |

DATA SHEET

SE5007BT: 5 GHz Front-End Module with Power Detector

Absolute Maximum Ratings

These are stress ratings only. Exposure to stresses beyond these maximum ratings for a long period of time may cause permanent damage to, or affect the reliability of the device. Avoid operating the device outside the recommended operating conditions defined below. This device is ESD sensitive. Handling and assembly of this device should be at ESD protected workstations.

| Symbol | Definition | Min. | Max. | Unit | |
|------------------------------------|--|----------------|------|------|---|
| V _{CC1} | Supply Voltage on pin 15 (VCC1) | -0.3 | 4.8 | V | |
| V _{DD} , V _{CC2} | Supply Voltage on pins 9, 16 (VDD, VCC2) | -0.3 | 3.6 | V | |
| EN | DC input on Enable | -0.3 | 3.6 | V | |
| TXIN | RF Input Power, RF _{out} into 50Ω match | - | 12 | dBm | |
| T _{STG} | Storage Temperature Range | -40 | 150 | °C | |
| ESD _{HBM} | JEDEC JESD22-A114 all pins | Antenna Pin | - | 1000 | V |
| | | All Other Pins | - | 350 | |

Recommended Operating Conditions

| Symbol | Parameter | Min. | Max. | Unit |
|------------------------------------|--|------|------|------|
| V _{CC1} | Supply Voltage on pin 15 (VCC1) | 3.0 | 4.5 | V |
| V _{DD} , V _{CC2} | Supply Voltage on pins 9, 16 (VDD, VCC2) | 3.0 | 3.6 | V |
| T _A | Ambient Temperature | -40 | 85 | °C |

Control Logic Characteristics

Conditions: V_{CC1} = V_{CC2} = V_{DD} = V_{PAON} = V_{EN} = 3.3 V, T_A = 25 °C, as measured on Skyworks Solutions' SE5007T-EV1 evaluation board, unless otherwise noted.

| Symbol | Parameter | Conditions | Min. | Typ. | Max. | Unit |
|-------------------------|-------------------------------|--|------|------|-----------------|------|
| I _{CC-802.11a} | Supply Current, Transmit Mode | P _{OUT} = 17 dBm, 54 Mbps, 64 QAM, H/L Lin = 3.3V (High Linearity Mode) | - | 195 | - | mA |
| | | P _{OUT} = 13 dBm, 54 Mbps, 64 QAM, H/L Lin = 0V (Low Linearity Mode) | - | 140 | - | |
| | | P _{OUT} = 5 dBm, 54 Mbps, 64 QAM, H/L Lin = 0V (Low Linearity Mode) | - | 105 | - | |
| | | P _{OUT} = 19 dBm, 54 Mbps, 64 QAM, H/L Lin = 3.3V, VCC1 = 4.0V | - | 220 | - | |
| | Supply Current, Receive Mode | V _{EN} = C0 = 0V; C1 = 3.3V | - | 15 | - | |
| | | V _{EN} = C0 = C1 = 0V | - | 0.02 | - | |
| I _{OFF} | Supply Current | V _{EN} = 0 V, No RF, C0=C1=0 V Measured on VCC, VDD pins | - | 20 | 50 | μA |
| V _{ENH} | Logic High Voltage | - | 1.6 | - | V _{CC} | V |

DATA SHEET

SE5007BT: 5 GHz Front-End Module with Power Detector

| Symbol | Parameter | Conditions | Min. | Typ. | Max. | Unit |
|------------------|----------------------------------|------------|------|------|------|------|
| V _{ENL} | Logic Low Voltage | - | -0.3 | - | 0.3 | V |
| I _{ENH} | Input Current Logic High Voltage | - | - | 330 | 400 | μA |
| I _{ENL} | Input Current Logic Low Voltage | - | - | <1 | - | μA |

Switch Logic Characteristics

Conditions: V_{CC} = V_{DD} V_{EN} = 3.3 V, T_A = 25 °C, as measured on Skyworks Solutions' SE5007BT-EK1 evaluation board, all unused ports terminated with 50 ohms, unless otherwise noted.

| Symbol | Parameter | Conditions | Min. | Typ. | Max. | Unit |
|------------------|----------------------------------|---|------|------|------|------|
| ON | Low Loss Switch Control Voltage | High State = V _{CTL_ON} - V _{CTL_OFF} | 2.8 | - | 3.6 | V |
| OFF | High Loss Switch Control Voltage | Low State = V _{CTL_OFF} - V _{CTL_OFF} | 0 | - | 0.3 | V |
| C _{CTL} | Control Input Capacitance | - | - | - | 100 | pF |
| I _{CTL} | Control Line Current | V _{CTL} = V _{CTL_ON} | - | 2 | 10 | μA |

Switch Control Logic Table

| C0 | C1 | EN | Hi/L Lin | ANT |
|-----|-----|--------------------|----------|--------------------------|
| ON | OFF | ON | OFF | TX Low Linearity |
| ON | OFF | ON | ON | TX High Linearity |
| OFF | OFF | OFF | D/C | Rx Bypass |
| OFF | ON | OFF | D/C | Rx LNA ON |
| ON | ON | Un-supported state | | |

DATA SHEET
SE5007BT: 5 GHz Front-End Module with Power Detector

AC Electrical Characteristics

Transmit Characteristics

Conditions: $V_{CC1} = V_{CC2} = V_{DD} = V_{EN} = C0 = H/L Lin = 3.3V$, $C1 = 0V$, $T_A = 25\text{ }^{\circ}C$, as measured on Skyworks Solutions' SE5007T-EV1 evaluation board, unless otherwise noted

| Symbol | Parameter | Conditions | Min. | Typ. | Max. | Unit | |
|---------------------------------|---|--|--|------|------|---------|-----|
| f_{L-U} | Frequency Range | - | 4.90 | - | 5.85 | GHz | |
| P _{OUT} | Output Power, High Linearity Mode H/L Lin = 3.3V OFDM | 802.11a, 64 QAM | EVM = 3% | - | 17 | - | dBm |
| | | | EVM = 2% | - | 15 | - | |
| | | VCC1 = 4.0V, 3% EVM | EVM = 3% | - | 19 | - | |
| | | MCS0, HT20, mask compliant | - | 21 | - | | |
| | | MCS0, HT40, mask compliant | - | 20 | - | | |
| | Output Power, Low Linearity Mode H/L Lin = 0V OFDM | 802.11a, 64 QAM, EVM = 3% | - | 13 | - | | |
| | | MCS0, HT20, mask compliant | - | 17 | - | | |
| | | MCS0, HT40, mask compliant | - | 16 | - | | |
| P _{1dB} | Output 1dB compression point | No modulation | - | 24 | - | dBm | |
| S ₁₁ | Input Return Loss | P _{IN} = -25 dBm | - | 14 | - | dB | |
| S ₂₁ | Small Signal Gain, P _{IN} = -25dBm | High Linearity Mode | 28 | 31 | - | dB | |
| | | Low Linearity Mode | 26 | 30 | - | | |
| ΔS_{21} | Small Signal Gain Variation | Gain variation over single 40MHz channel | - | - | 0.5 | dB | |
| | | Gain Variation over band | -1.5 | - | 1.5 | | |
| S _{21_3.8} | Out of Band Gain | Gain at 3.8GHz | - | - | 15 | dB | |
| 2f | Harmonic | P _{OUT} = 17 dBm, OFDM | - | -50 | -42 | dBm/MHz | |
| 3f | | | - | -50 | -42 | | |
| t _r , t _f | Rise and Fall Time | - | - | 0.5 | - | us | |
| STAB | Stability | P _{OUT} = 17 dBm, 54 Mbps, 64 QAM, VSWR = 6:1, all phases | All non-harmonically related outputs less than -50 dBc/100 kHz | | | | |
| Ruggedness | Tolerance to output load mismatching | Constant P _{IN} equal to P _{OUT} = 17 dBm at 50ohms, 54 Mbps, 64 QAM, VSWR = 6:1, all phases | No damage | | | | |
| Robust | Robustness to input power | P _{IN} = 12dBm, CW, VSWR = 6:1, all phases | No damage | | | | |

DATA SHEET
SE5007BT: 5 GHz Front-End Module with Power Detector

Receive Characteristics

Conditions: $V_{CC} = C1 = V_{DD} = 3.3V$, $V_{EN} = C0 = 0V$, $T_A = 25\text{ }^{\circ}\text{C}$, as measured on Skyworks Solutions' SE5007BT-EK1 evaluation board, all unused ports terminated with 50 ohms, unless otherwise noted.

| Symbol | Parameter | Condition | Min. | Typ. | Max. | Unit |
|---------------------|---------------------------------|--|------|------|------|------|
| F _{OUT} | Frequency Range | - | 4.9 | - | 5.85 | GHz |
| RX | Insertion Loss | Bypass Mode: $C0 = C1 = 0V$ | - | -5 | - | dB |
| | RX Gain | High Gain Mode | 11 | 12 | - | |
| NF | Noise Figure | High Gain Mode | - | 2.5 | - | dB |
| RX _{RL} | Input Return Loss | At the Antenna port | - | 12 | - | dB |
| | Output Return Loss | At RX RF output | - | 8 | - | |
| RxIP1DB | Input P1DB | Measured at ANT Port; High Gain Mode | - | -5 | - | dBm |
| | | LNA Bypass Mode | - | 10 | - | |
| Rx_2.4int | Max 2.4Ghz interferer Amplitude | 1 dB degradation of IP1DB | - | -10 | -7 | dBm |
| T _{on/off} | T/R on/off switching speed | C0, C1 (50%) to RF output (10% or 90%) | - | 300 | - | nSec |

DATA SHEET
SE5007BT: 5 GHz Front-End Module with Power Detector

Power Detector Characteristics

Conditions: $V_{CC} = V_{EN} = C0 = V_{DD} = 3.3V$, $C1 = 0V$, $f = 5.4\text{ GHz}$, $T_A = 25\text{ }^\circ\text{C}$, as measured on Skyworks Solutions' SE5007BT-EV1 evaluation board, unless otherwise noted

| Symbol | Parameter | Conditions | Min. | Typ. | Max. | Unit |
|--------------------|-------------------------------|---------------------------|------|------|------------------|------|
| PDR | P _{OUT} detect range | - | 0 | - | P _{1dB} | dBm |
| VDET ₂₂ | Detector voltage | P _{OUT} = 22 dBm | 0.7 | - | 0.9 | V |
| VDET ₁₆ | Detector voltage | P _{OUT} = 16 dBm | 0.50 | - | 0.60 | V |
| VDET ₂ | Detector voltage | P _{OUT} = 2 dBm | 0.25 | - | 0.35 | V |
| PDZ _{OUT} | Output Impedance | - | - | 5 | - | KΩ |

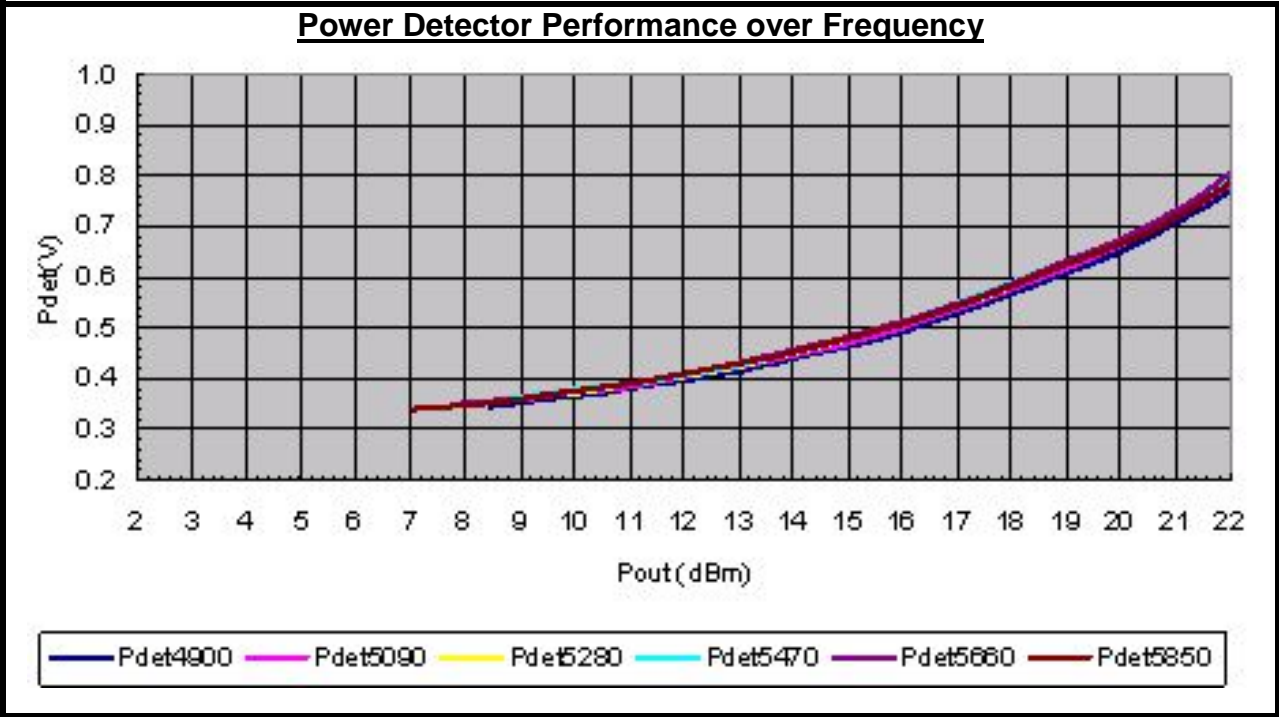

Figure 3: SE5007BT Power Detector Characteristic

DATA SHEET
SE5007BT: 5 GHz Front-End Module with Power Detector

Package Diagram

This package is Pb free and RoHS compliant. The product is rated MSL1.

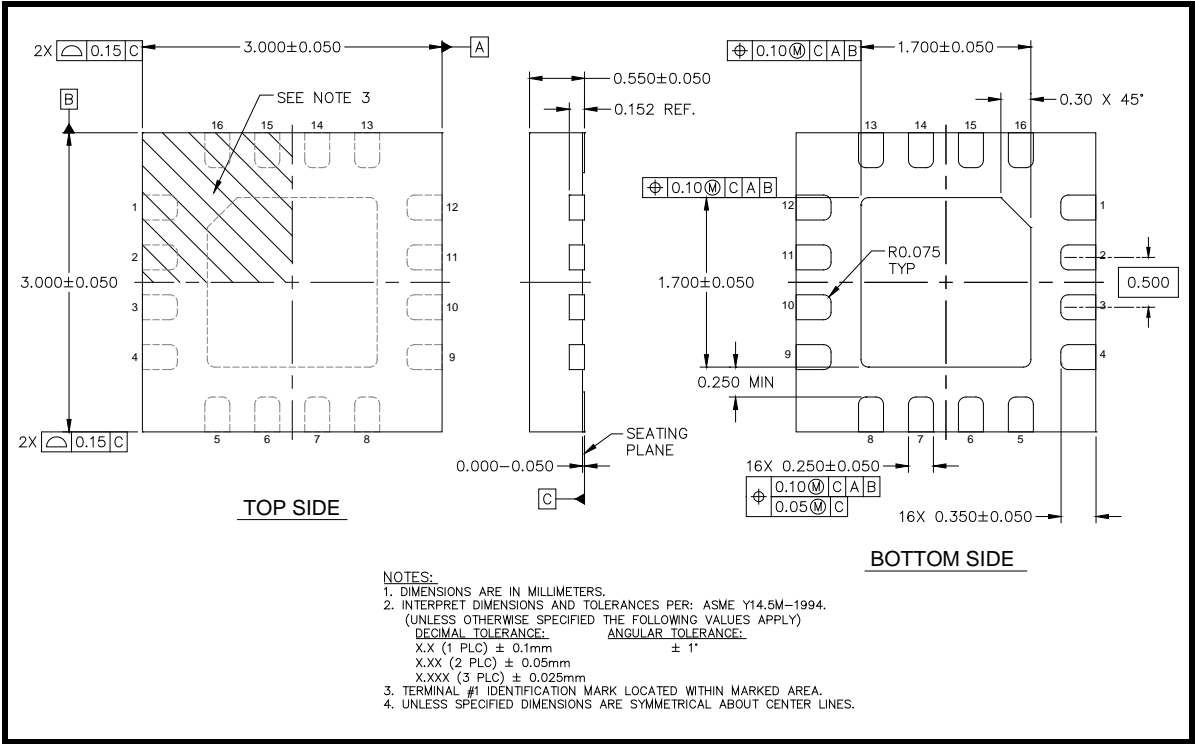
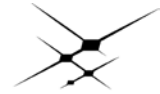

Figure 4: SE5007BT Package Diagram



DATA SHEET

SE5007BT: 5 GHz Front-End Module with Power Detector

Recommended Land and Solder Patterns

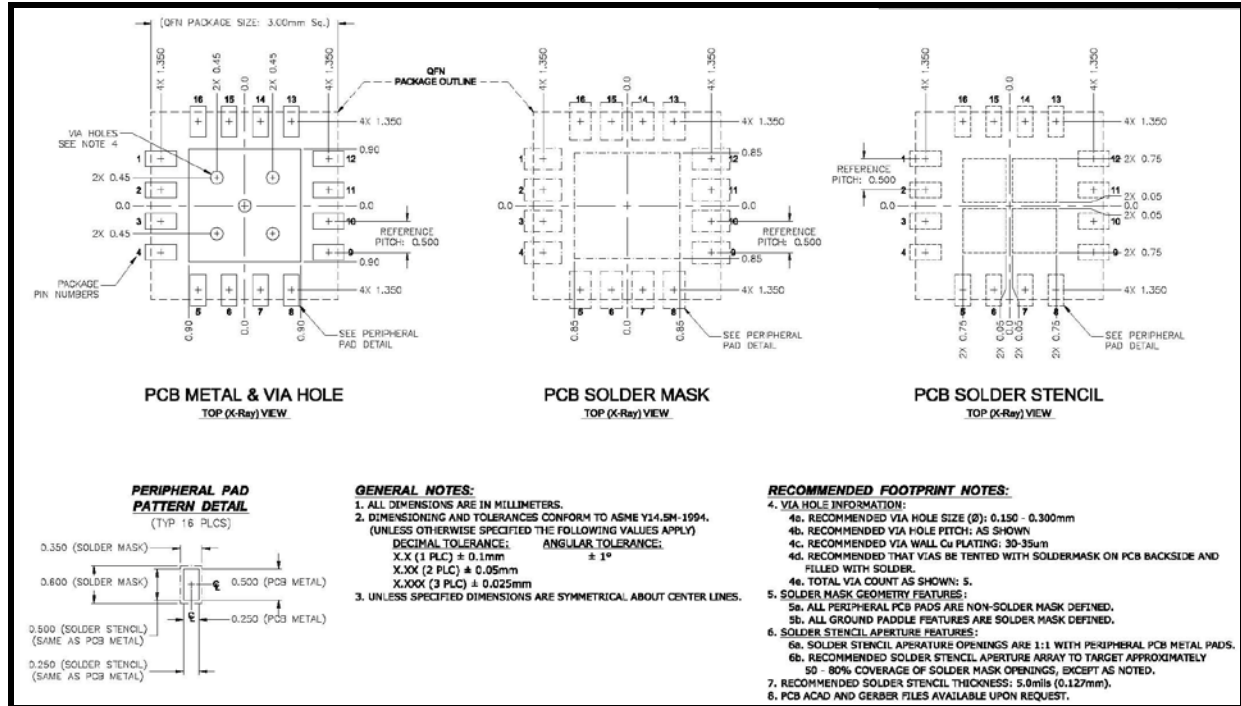

Figure 5: SE5007BT Recommended Land and Solder Pattern

Package Handling Information

Because of its sensitivity to moisture absorption, instructions on the shipping container label must be followed regarding exposure to moisture after the container seal is broken, otherwise, problems related to moisture absorption may occur when the part is subjected to high temperature during solder assembly. The SE5007BT is capable of withstanding a Pb free solder reflow. Care must be taken when attaching this product, whether it is done manually or in a production solder reflow environment. If the part is manually attached, precaution should be taken to insure that the device is not subjected to temperatures above its rated peak temperature for an extended period of time. For details on both attachment techniques, precautions, and handling procedures recommended, please refer to:

- “Quad Flat No-Lead Module Solder Reflow & Rework Information”, *Document Number QAD-00045*
- “Handling, Packing, Shipping and Use of Moisture Sensitive QFN”, *Document Number QAD-00044*



Caution! Class 1A ESD sensitive device

DATA SHEET
SE5007BT: 5 GHz Front-End Module with Power Detector

Branding Information

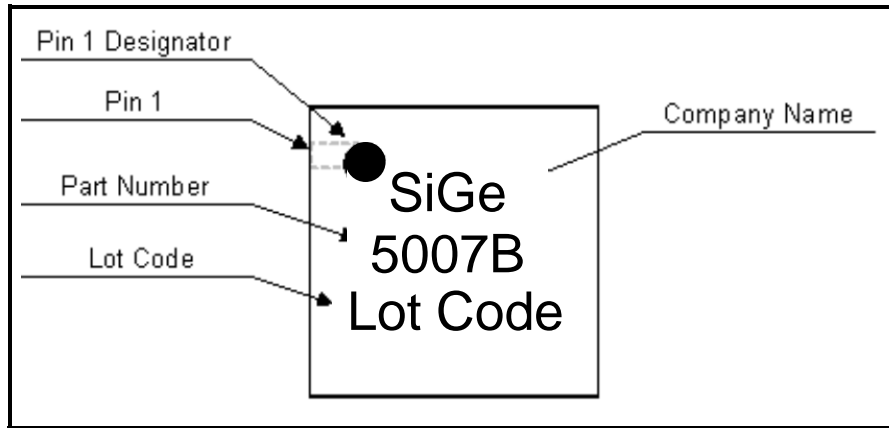

Figure 6: SE5007BT Branding

Tape and Reel Information

| Parameter | Value |
|------------------|----------------|
| Devices Per Reel | 3000 |
| Reel Diameter | 13 inches |
| Tape Width | 12 millimeters |

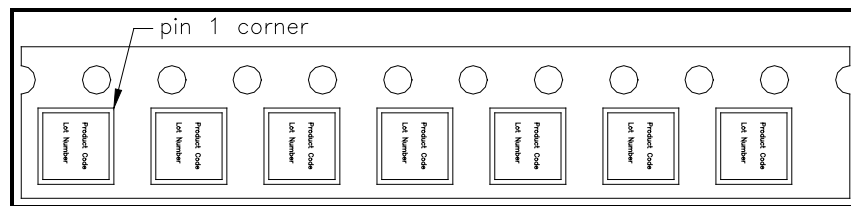

Figure 7: SE5007BT-R Tape and Reel Information

Document Change History

| Revision | Date | Notes |
|----------|--------------|---|
| 1.0 | Nov 03, 2010 | Created |
| 1.1 | Nov 22, 2010 | Updated Supply voltage specs |
| 1.2 | Dec 20, 2010 | Corrected RX Conditions in Control Logic table |
| 1.3 | Jan 03, 2011 | Updated recommended storage temperature |
| 1.4 | Feb 8, 2011 | Added 4V operation, Mask Performance, Added reference to blocked RF ports on the block diagram |
| 1.5 | Apr 25, 2011 | Update V _{ENH} (min) from 2.8V to 1.6V Corrected product description – removed reference to Balun |
| 1.6 | Apr 11, 2012 | Updated with Skyworks logo and disclaimer statement |



DATA SHEET
SE5007BT: 5 GHz Front-End Module with Power Detector

Copyright © 2012 Skyworks Solutions, Inc. All Rights Reserved.

Information in this document is provided in connection with Skyworks Solutions, Inc. ("Skyworks") products or services. These materials, including the information contained herein, are provided by Skyworks as a service to its customers and may be used for informational purposes only by the customer. Skyworks assumes no responsibility for errors or omissions in these materials or the information contained herein. Skyworks may change its documentation, products, services, specifications or product descriptions at any time, without notice. Skyworks makes no commitment to update the materials or information and shall have no responsibility whatsoever for conflicts, incompatibilities, or other difficulties arising from any future changes.

No license, whether express, implied, by estoppel or otherwise, is granted to any intellectual property rights by this document. Skyworks assumes no liability for any materials, products or information provided hereunder, including the sale, distribution, reproduction or use of Skyworks products, information or materials, except as may be provided in Skyworks Terms and Conditions of Sale.

THE MATERIALS, PRODUCTS AND INFORMATION ARE PROVIDED "AS IS" WITHOUT WARRANTY OF ANY KIND, WHETHER EXPRESS, IMPLIED, STATUTORY, OR OTHERWISE, INCLUDING FITNESS FOR A PARTICULAR PURPOSE OR USE, MERCHANTABILITY, PERFORMANCE, QUALITY OR NON-INFRINGEMENT OF ANY INTELLECTUAL PROPERTY RIGHT; ALL SUCH WARRANTIES ARE HEREBY EXPRESSLY DISCLAIMED. SKYWORKS DOES NOT WARRANT THE ACCURACY OR COMPLETENESS OF THE INFORMATION, TEXT, GRAPHICS OR OTHER ITEMS CONTAINED WITHIN THESE MATERIALS. SKYWORKS SHALL NOT BE LIABLE FOR ANY DAMAGES, INCLUDING BUT NOT LIMITED TO ANY SPECIAL, INDIRECT, INCIDENTAL, STATUTORY, OR CONSEQUENTIAL DAMAGES, INCLUDING WITHOUT LIMITATION, LOST REVENUES OR LOST PROFITS THAT MAY RESULT FROM THE USE OF THE MATERIALS OR INFORMATION, WHETHER OR NOT THE RECIPIENT OF MATERIALS HAS BEEN ADVISED OF THE POSSIBILITY OF SUCH DAMAGE.

Skyworks products are not intended for use in medical, lifesaving or life-sustaining applications, or other equipment in which the failure of the Skyworks products could lead to personal injury, death, physical or environmental damage. Skyworks customers using or selling Skyworks products for use in such applications do so at their own risk and agree to fully indemnify Skyworks for any damages resulting from such improper use or sale.

Customers are responsible for their products and applications using Skyworks products, which may deviate from published specifications as a result of design defects, errors, or operation of products outside of published parameters or design specifications. Customers should include design and operating safeguards to minimize these and other risks. Skyworks assumes no liability for applications assistance, customer product design, or damage to any equipment resulting from the use of Skyworks products outside of stated published specifications or parameters.

Skyworks, the Skyworks symbol, and "Breakthrough Simplicity" are trademarks or registered trademarks of Skyworks Solutions, Inc., in the United States and other countries. Third-party brands and names are for identification purposes only, and are the property of their respective owners. Additional information, including relevant terms and conditions, posted at www.skyworksinc.com, are incorporated by reference.

Данный компонент на территории Российской Федерации

Вы можете приобрести в компании MosChip.

Для оперативного оформления запроса Вам необходимо перейти по данной ссылке:

<http://moschip.ru/get-element>

Вы можете разместить у нас заказ для любого Вашего проекта, будь то серийное производство или разработка единичного прибора.

В нашем ассортименте представлены ведущие мировые производители активных и пассивных электронных компонентов.

Нашей специализацией является поставка электронной компонентной базы двойного назначения, продукции таких производителей как XILINX, Intel (ex.ALTERA), Vicor, Microchip, Texas Instruments, Analog Devices, Mini-Circuits, Amphenol, Glenair.

Сотрудничество с глобальными дистрибьюторами электронных компонентов, предоставляет возможность заказывать и получать с международных складов практически любой перечень компонентов в оптимальные для Вас сроки.

На всех этапах разработки и производства наши партнеры могут получить квалифицированную поддержку опытных инженеров.

Система менеджмента качества компании отвечает требованиям в соответствии с ГОСТ Р ИСО 9001, ГОСТ РВ 0015-002 и ЭС РД 009

Офис по работе с юридическими лицами:

105318, г.Москва, ул.Щербаковская д.3, офис 1107, 1118, ДЦ «Щербаковский»

Телефон: +7 495 668-12-70 (многоканальный)

Факс: +7 495 668-12-70 (доб.304)

E-mail: info@moschip.ru

Skype отдела продаж:

moschip.ru

moschip.ru_4

moschip.ru_6

moschip.ru_9