

Applications

- Commercial and Military Radar
- Satellite Communications
- General Purpose Switching

Product Features

- SPDT, Reflective Switch
- Frequency Range: 13 - 19 GHz
- Insertion Loss: < 1.7 dB
- Power Handling: 2 W (P-0.1dB)
- ITOI: 55 dBm (at P_{IN}/Tone = 22 dBm)
- Isolation: > 20 dB
- Switching Speed: 20 ns
- Control Voltages: V_{DD} = 3.3 - 5 V, V_{BIT} = 0/V_{DD} V
- Process Technology: GaAs-PHEMTES15-DR
- Package Dimensions: 4.0 x 4.0 x 1.47 mm

General Description

The TGS4310-SM is a packaged single-pole, double-throw (SPDT) reflective switch operating from 13 to 19 GHz. With an insertion loss of <1.7 dB, the TGS4310-SM supports 2 W of incident power at 0.1 dB compression.

For mechanical robustness and ease of handling, the TGS4310-SM is available in a low-cost, 4x4 mm air-cavity ceramic QFN. Fully matched to 50 ohms at all ports, it uses standard positive control voltages and requires very little control current making system integration simple without impacting DC power budgets.

The TGS4310-SM is ideally suited for a variety of Ku-band switching applications across both defense and commercial applications.

Lead-free and RoHS compliant

Evaluation Boards are available upon request.

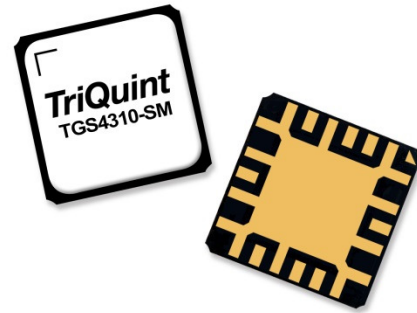

QFN 4x4 mm 22L

Functional Block Diagram

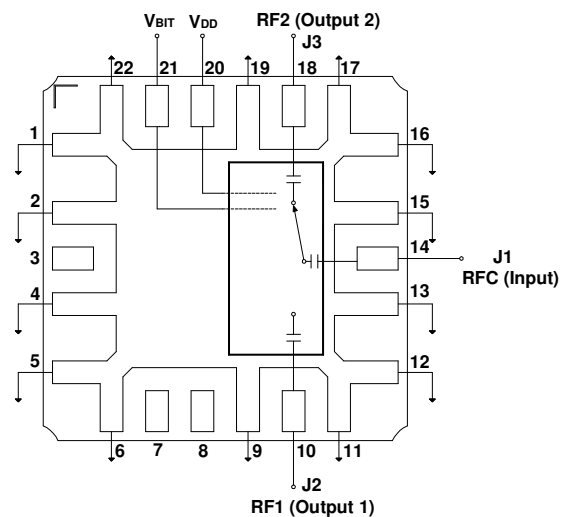

Pin Configuration

Pad No.	Symbol
1, 2, 4, 5-6, 9, 11-13, 15-17, 19, 22	GND
3, 7, 8	NC
10	RF1
14	RFC
18	RF2
20	V _{DD}
21	V _{BIT}
23	GND Paddle

Ordering Information

Part	ECCN	Description
TGS4310-SM	EAR99	13-19GHz 2W SPDT Switch

Absolute Maximum Ratings

Parameter	Value
Voltages (V_{DD} , V_{BIT})	6 V
Currents (I_{DD} , I_{BIT})	-1.7 / +1.7 mA
Power Dissipation, $T_{BASE} = 85\text{ }^{\circ}\text{C}$	1.8 W
Input Power (P_{IN}), CW/Pulsed, 50 Ω , 85 $^{\circ}\text{C}$	34 dBm
Input Power (P_{IN}), hot switching, 90/10%, 45 ns speed, 50% duty cycle	33 dBm
Channel Temperature (T_{CH})	200 $^{\circ}\text{C}$
Mounting Temperature (30 sec)	260 $^{\circ}\text{C}$
Storage Temperature	-55 to 150 $^{\circ}\text{C}$

Operation of this device outside the parameter ranges given above may cause permanent damage. These are stress ratings only, and functional operation of the device at these conditions is not implied.

Recommended Operating Conditions

Parameter	Min	Typ	Max	Units
Frequency	13		19	GHz
Input Power Handling (CW/Pulsed RF)		≤ 33		dBm
Reference Voltage, V_{DD}		3.3 - 5		V
Control Voltage, V_{BIT}		0/ V_{DD}		V
Currents (I_{DD} , I_{BIT})	See plots p. 7			
Operating Temperature	-40		+85	$^{\circ}\text{C}$

Electrical specifications are measured at specified test conditions. Specifications are not guaranteed over all recommended operating conditions.

Electrical Specifications

Test conditions unless otherwise noted: $V_{DD} = 5\text{ V}$, $V_{BIT} = 0/5\text{ V}$, $Temp = +25\text{ }^{\circ}\text{C}$. $Z_0 = 50\text{ }\Omega$

Parameter	Min	Typical	Max	Units
Operational Frequency Range	13		19	GHz
Input Power at 0.1 dB Gain Compression (P-0.1dB)		33		dBm
Insertion Loss		< 1.7		dB
Isolation		> 20		dB
Input Return Loss – On-State (Common Port RL)		> 12		dB
Output Return Loss – On-State (Switched Port RL)		> 12		dB
Output Return Loss – Off-State (Isolated Port RL)		< 1		dB
Input TOI at $P_{IN}/Tone = 22\text{ dBm}$ (ITOI)		55		dBm
IM3 at $P_{IN}/Tone = 22\text{ dBm}$		-75		dBc
IM5 at $P_{IN}/Tone = 22\text{ dBm}$		-75		dBc
Insertion Loss Temperature Coefficient		0.003		dB/ $^{\circ}\text{C}$
Switching Speed (90/10%)		20		ns

Thermal and Reliability Information

Parameter	Test Conditions	Value	Units
Thermal Resistance (θ_{JC}) ⁽¹⁾	$T_{BASE} = 85\text{ }^{\circ}\text{C}$, $V_{DD} = 5\text{ V}$, $V_{BIT} = 0/5\text{ V}$, CW, Frequency = 13 GHz, $P_{IN} = 33\text{ dBm}$ (2 W), Insertion Loss = 2 dB, $P_{OUT} = 31\text{ dBm}$ (1.25 W), $P_{DISS} = 0.75\text{ W}$	60	$^{\circ}\text{C/W}$
Channel Temperature (T_{CH}) (Under RF drive)		130	$^{\circ}\text{C}$
Median Lifetime (T_M)		1.1E+7	Hrs

Notes:

1. Thermal resistance measured to back of package.

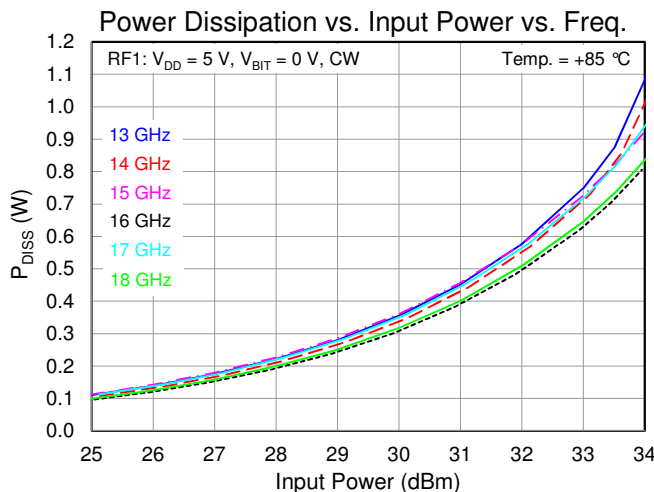

Test Conditions: $V_D = 7\text{ V}$; Failure Criteria = 10% reduction in I_{D_MAX}

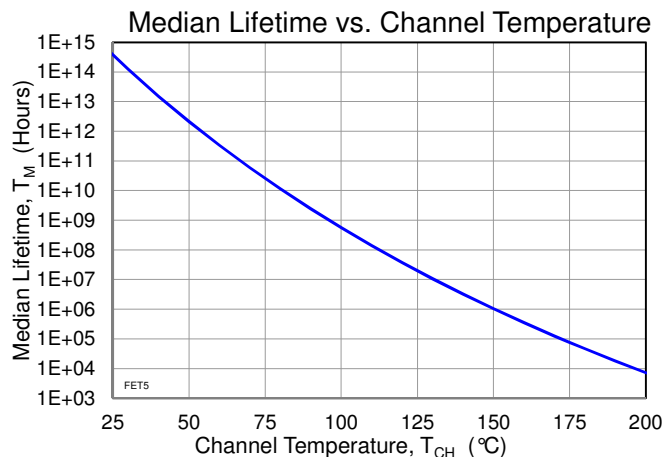

Typical Performance: Small Signal

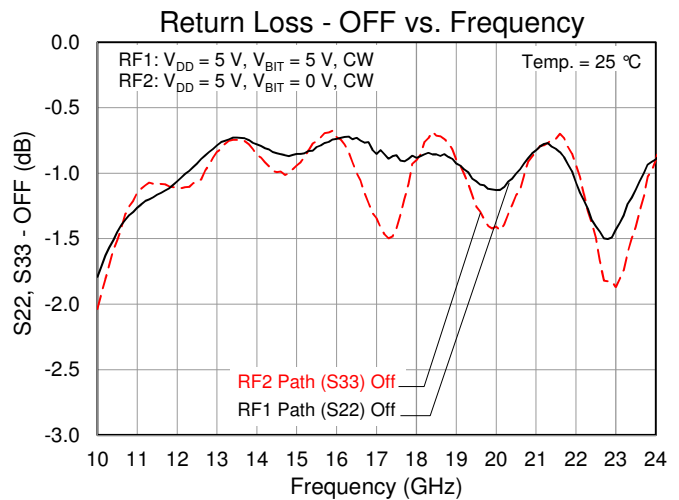
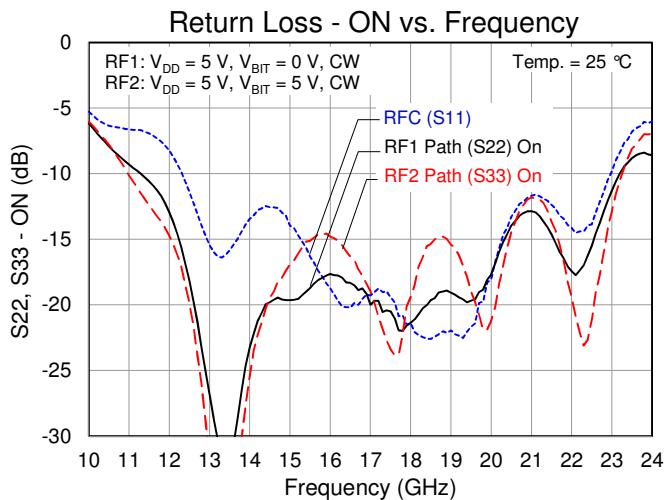
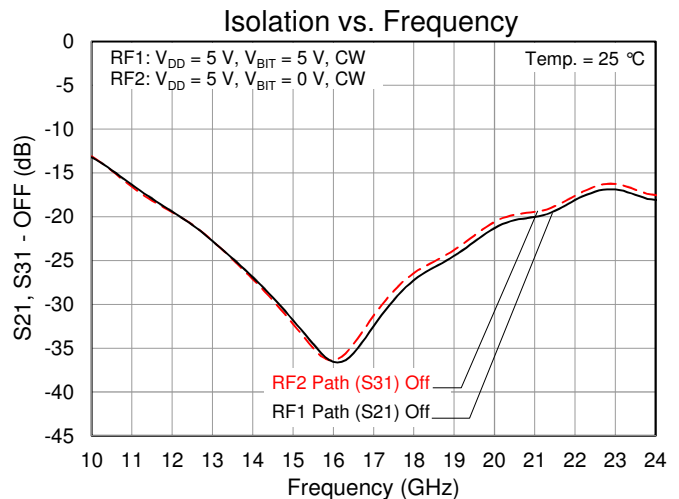
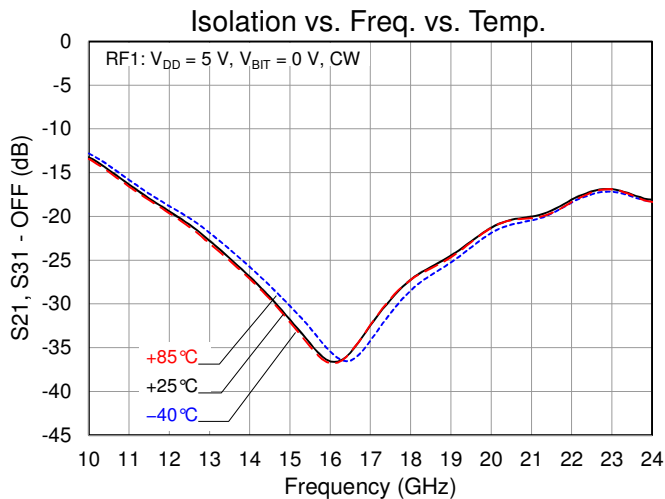
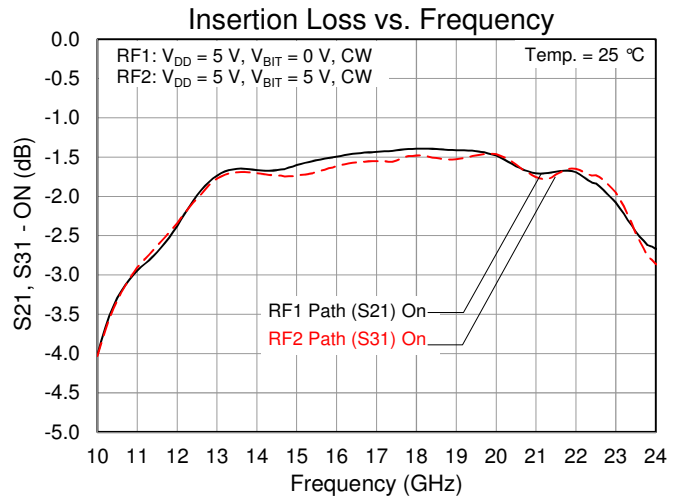
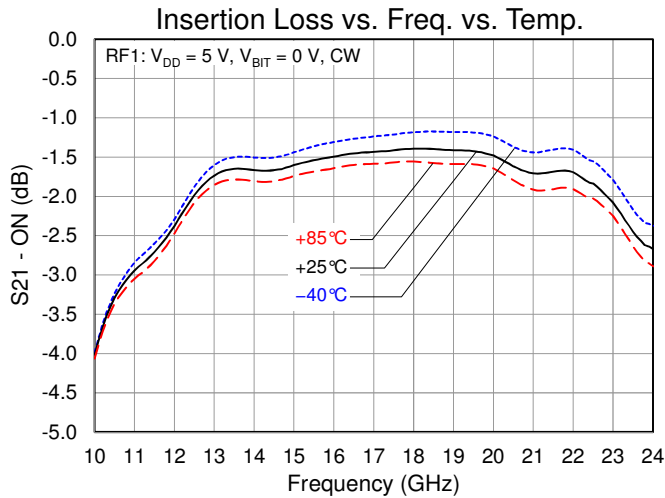

Typical Performance: Large Signal - CW

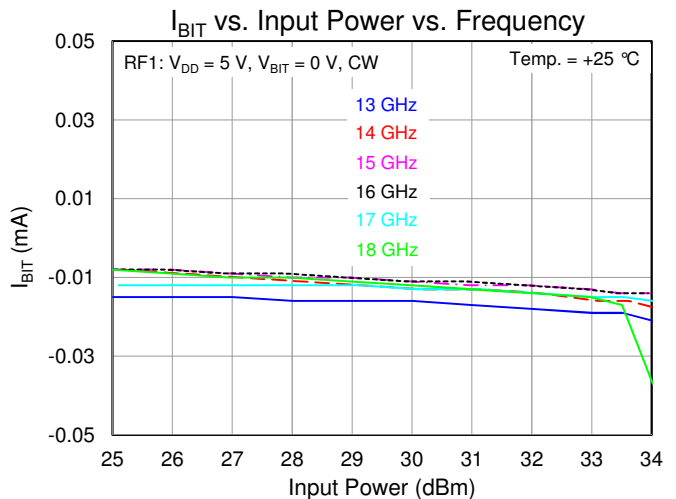
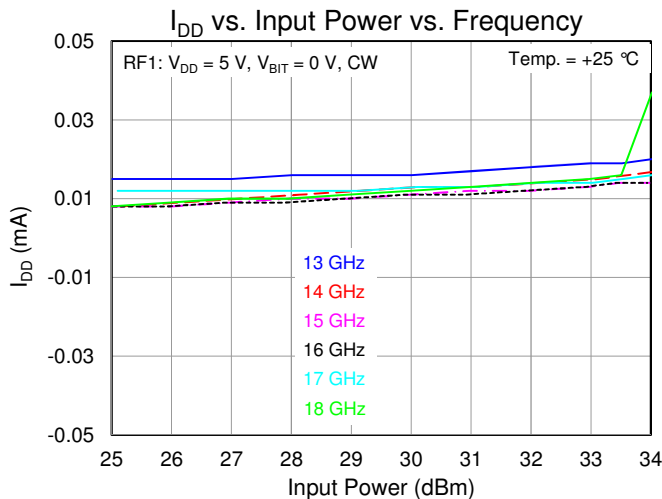
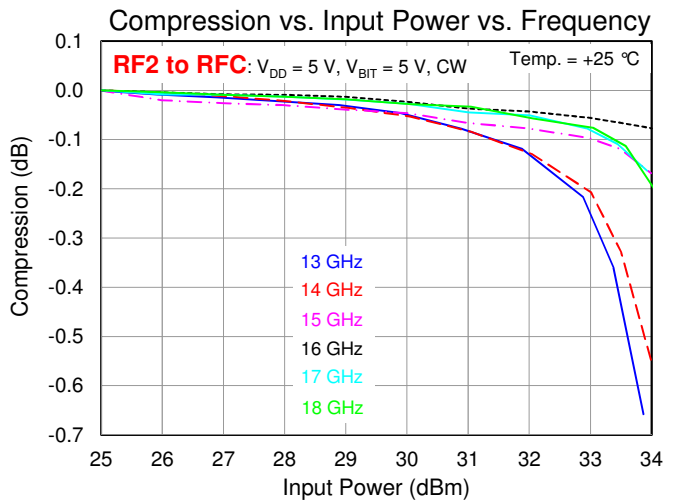
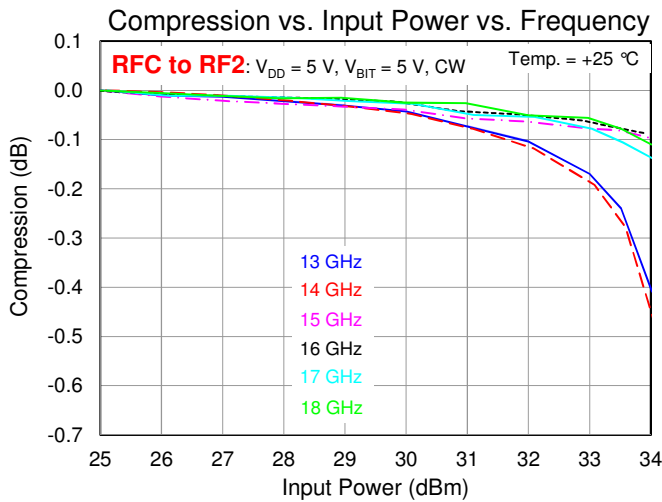
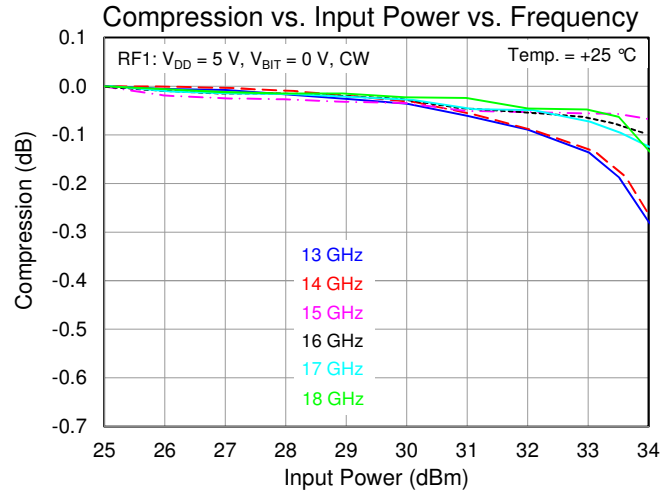
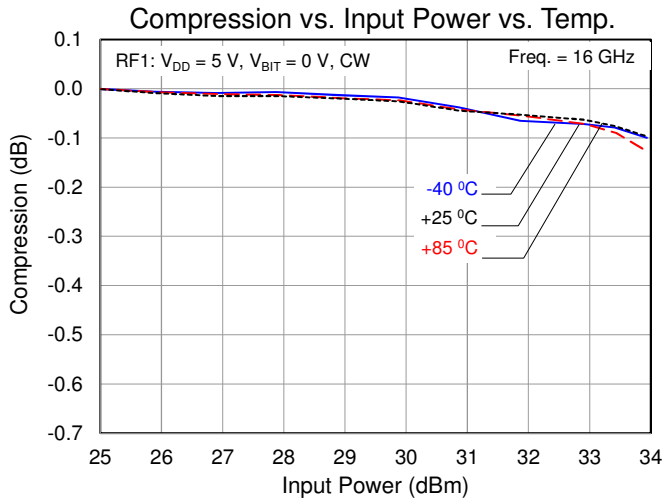

Typical Performance: Large Signal – Pulsed RF (PW = 10 us, DC = 10 %)

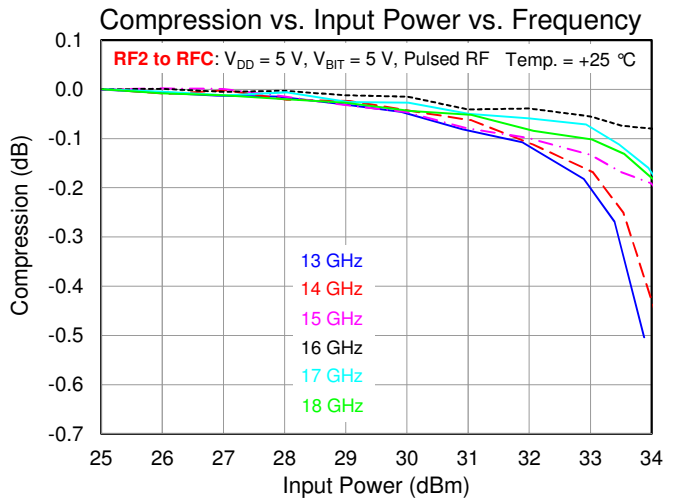
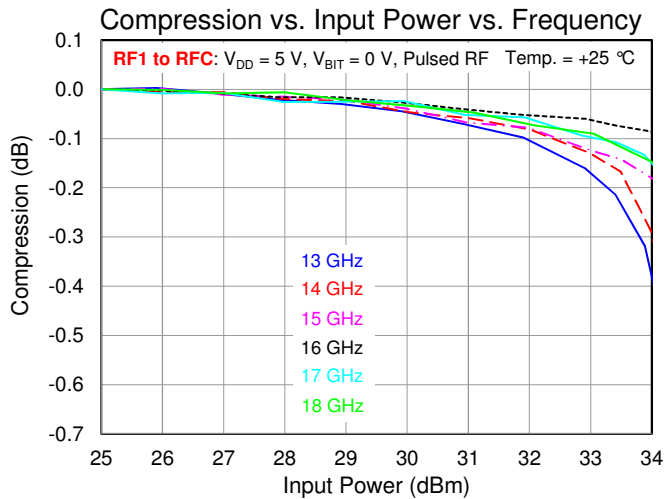
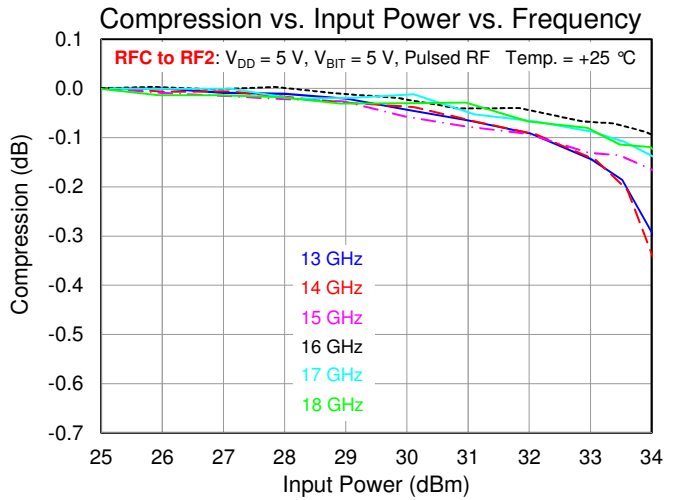
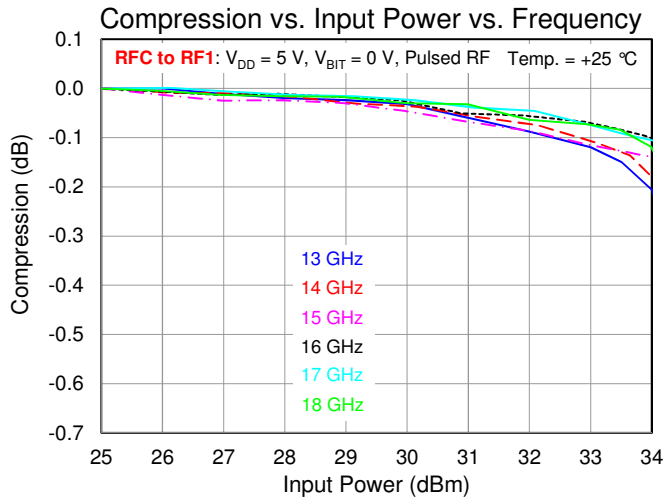

Typical Performance: Linearity

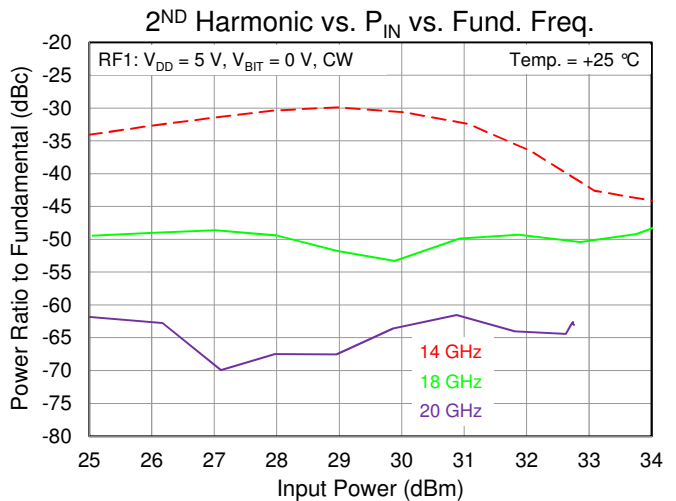
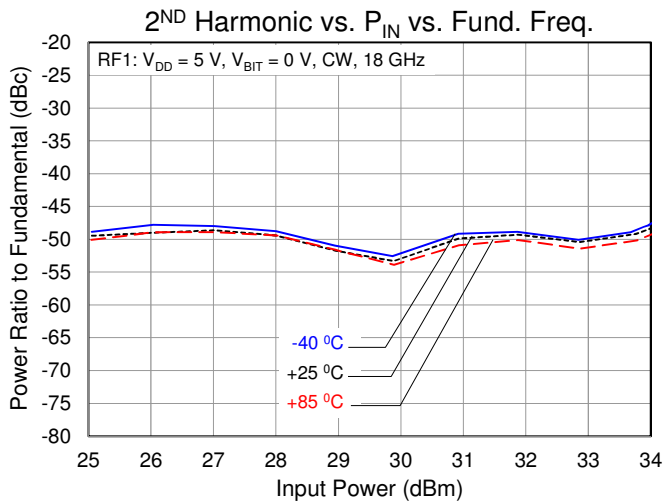
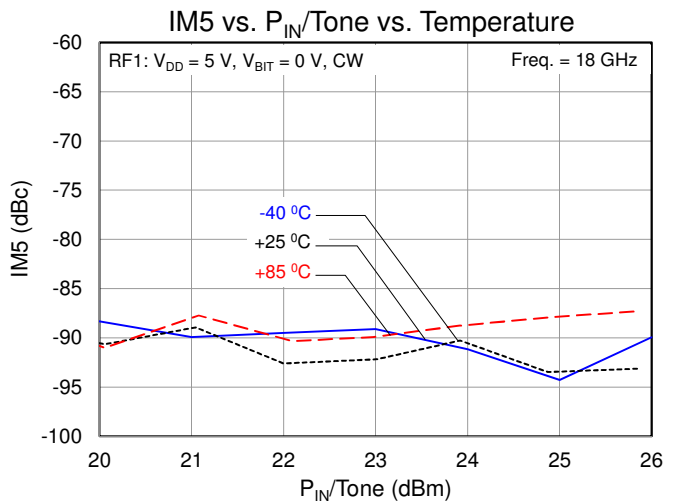
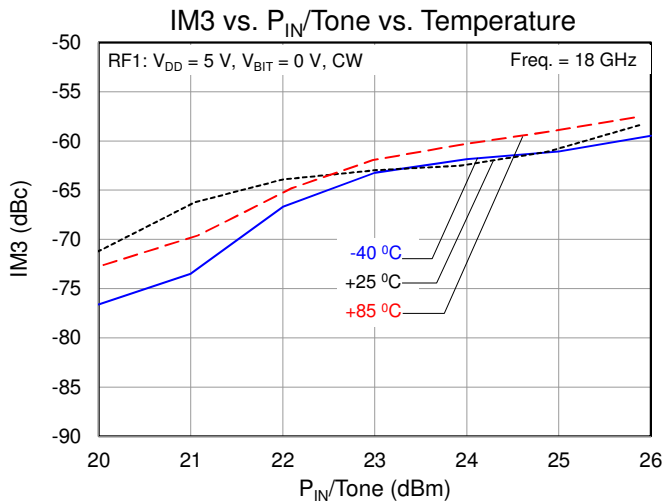
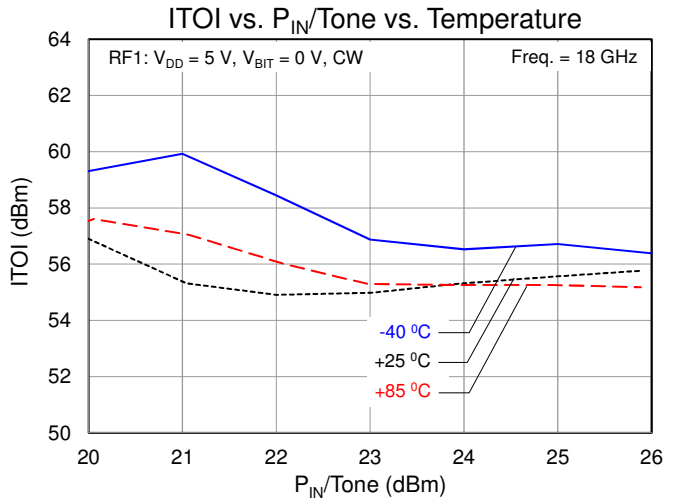
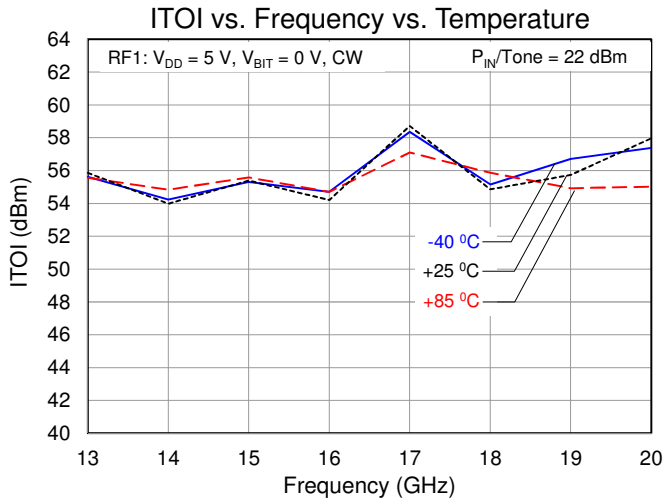

Typical Performance: Switching Speed

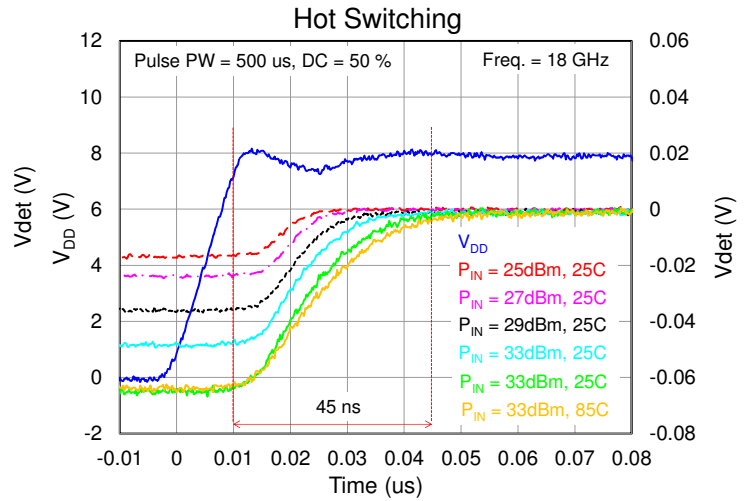
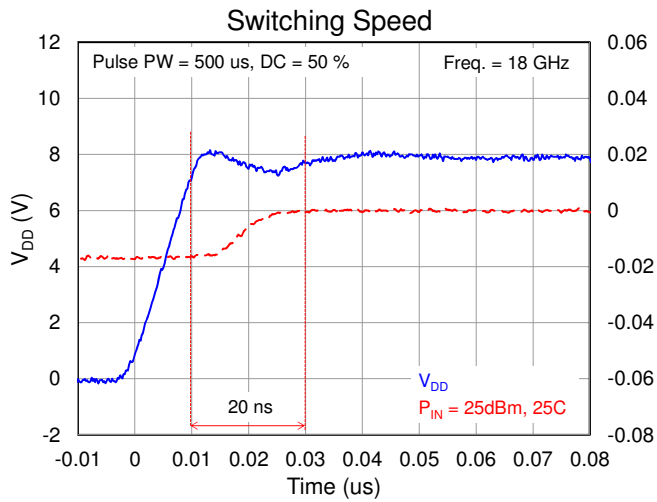

Applications Information

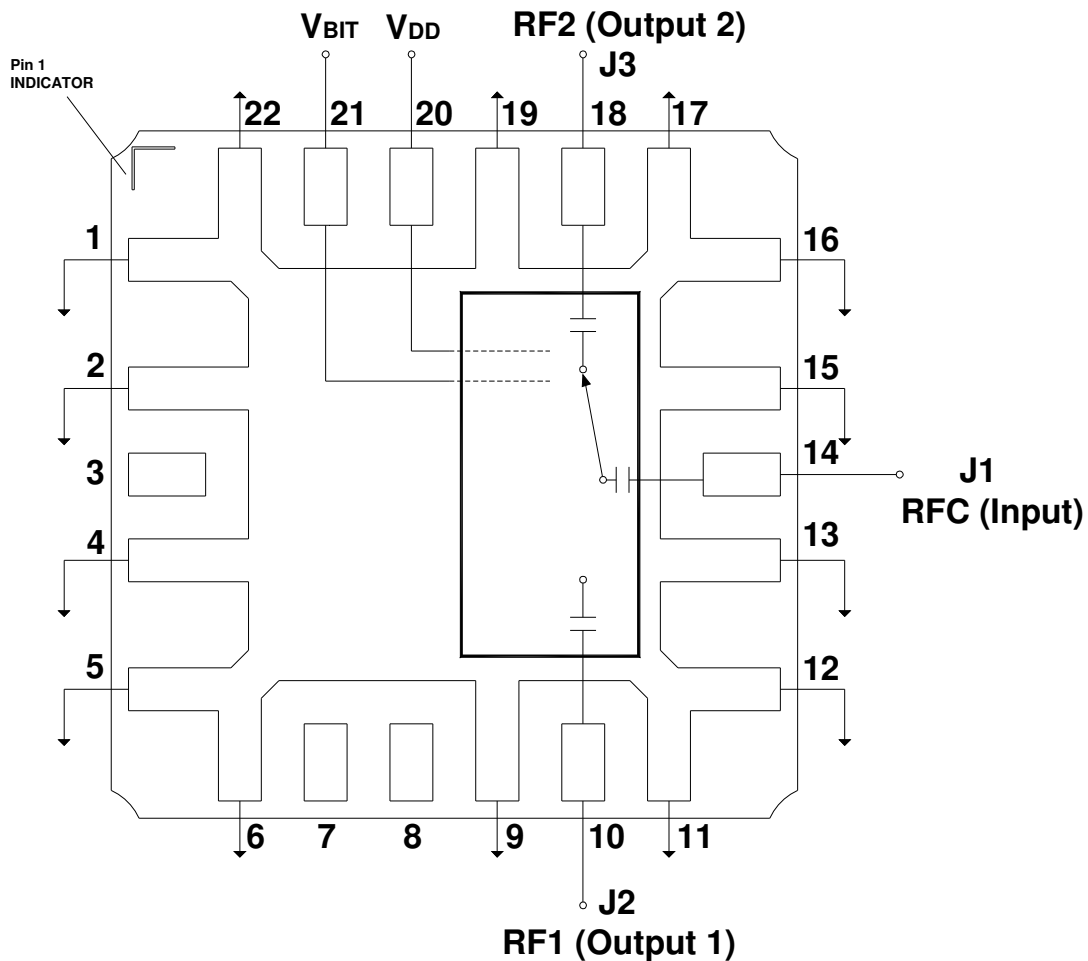

The switch can be configured as a Single Pole, Single Throw (SPST) by terminating one unused RF switched port (pin 10 or pin 18) with a 50 Ohm load.

Function Table

RF Path	State	V _{DD} (V)	V _{BIT} (V)
RFC (Input) to RF1 (Output1)	On-State (Insertion Loss)	5	0
	Off-State (Isolation)	5	5
RFC (Input) to RF2 (Output 2)	On-State (Insertion Loss)	5	5
	Off-State (Isolation)	5	0

Pin Layout

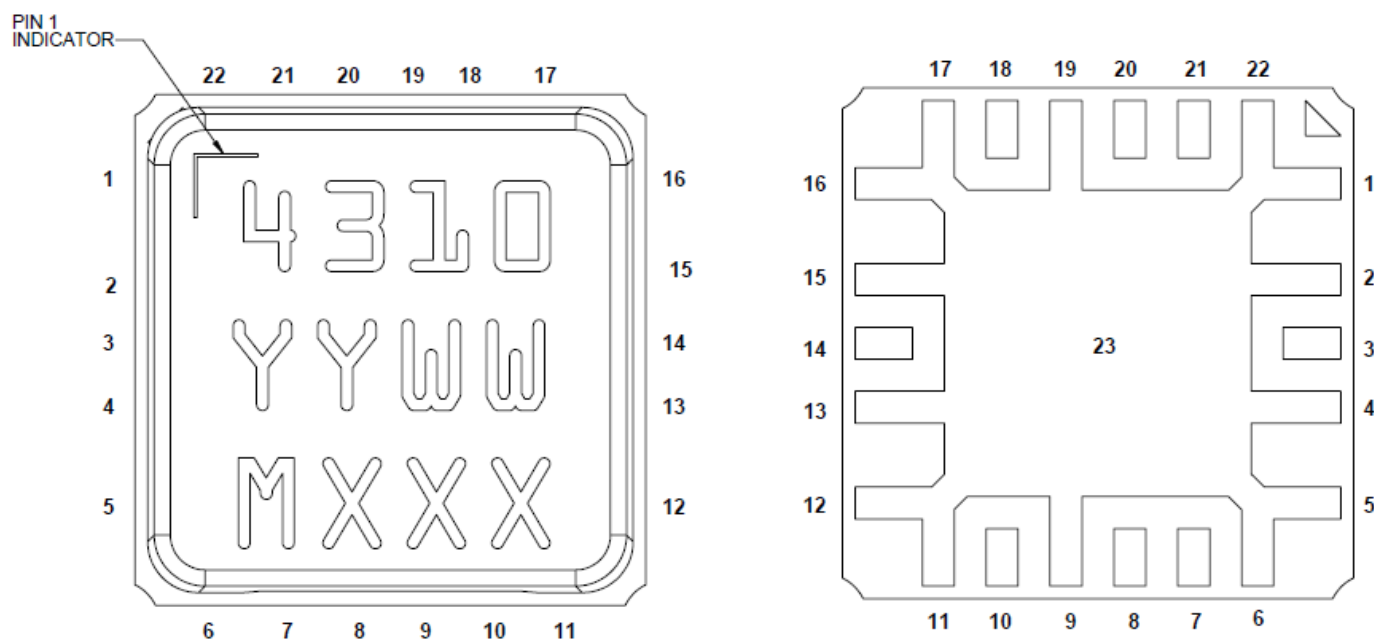

Pin Description

Pin No.	Symbol	Description
1, 2, 4, 5-6, 9, 11-13, 15-17, 19, 22	GND	Connected to ground paddle (pin 23); must be grounded on PCB
3, 7, 8	NC	No connection
10	RF1	Switched RF port 1 (Output 1); matched to 50 Ω ; DC blocked
14	RFC	Common RF port (Input); matched to 50 Ω ; DC blocked
18	RF2	Switched RF port 2 (Output 2); matched to 50 Ω ; DC blocked
20	V_{DD} (or V_D)	Reference Voltage; no bias network required
21	V_{BIT} (or V_C)	Control Voltage; no bias network required
23	GND	Ground Paddle. Multiple vias should be employed to minimize inductance and thermal resistance.

Evaluation Board

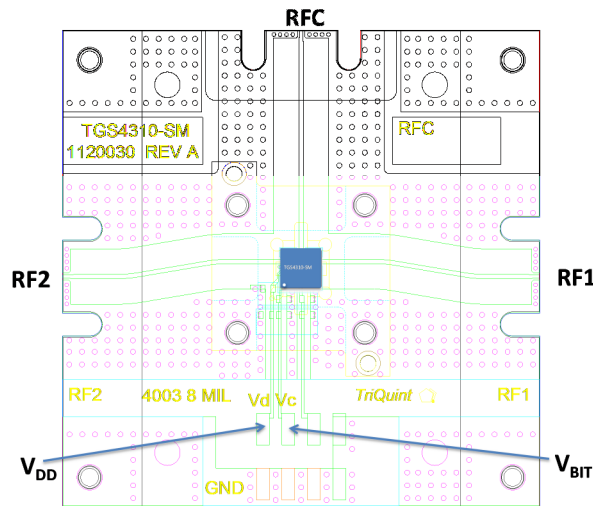

Mechanical Information

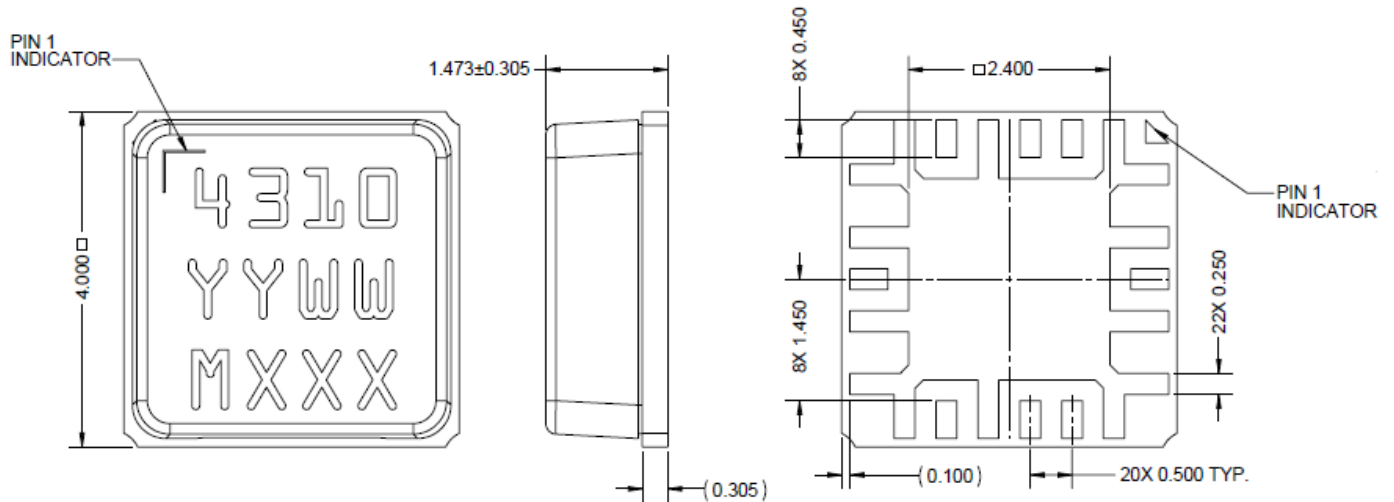

Units: mm

Tolerances: unless specified

x.xx = ± 0.25

x.xxx = ± 0.127

Materials:

Base: Ceramic

Lid: Plastic

All metalized features are gold plated

Part is epoxy sealed

Marking:

4310: Part number

YY: Part Assembly year

WW: Part Assembly week

MXXX: Batch ID

Recommended Soldering Temperature Profile

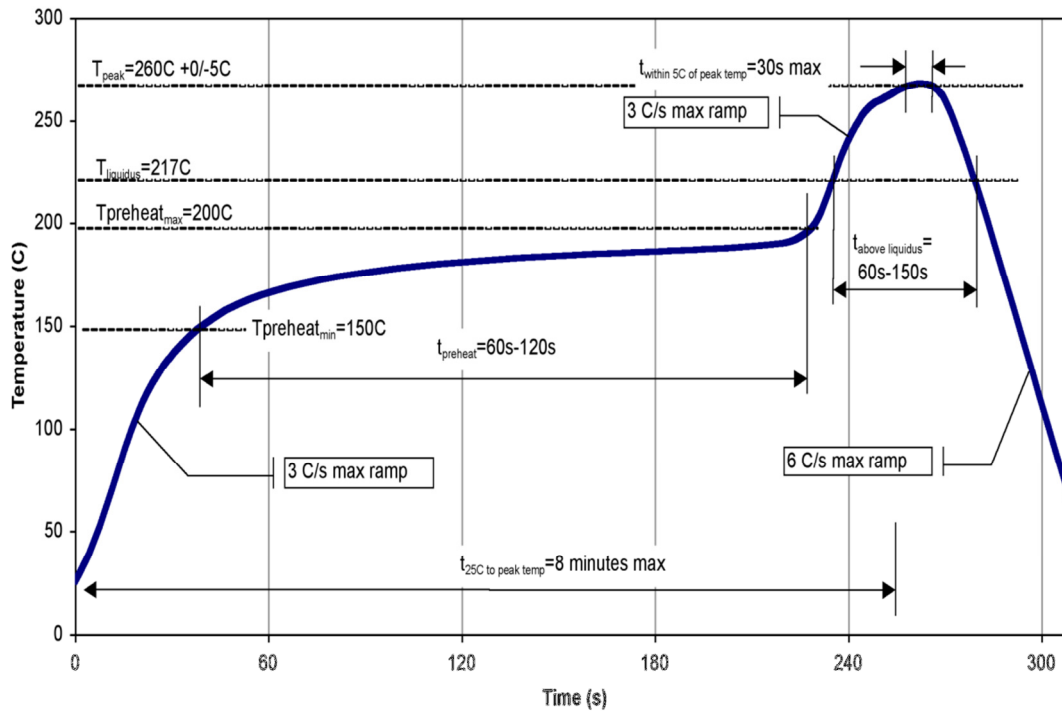

Product Compliance Information

ESD Sensitivity Ratings



Caution! ESD-Sensitive Device

ESD Rating: TBD
Value: TBD
Test: Human Body Model (HBM)
Standard: JEDEC Standard JESD22-A114

MSL Rating

Level TBD at TBD °C convection reflow
The part is rated Moisture Sensitivity Level TBD at TBD °C
per JEDEC standard IPC/JEDEC J-STD-020.

ECCN

US Department of Commerce: EAR99

Solderability

Compatible with the latest version of J-STD-020, Lead-free solder, 260 °C

RoHS Compliance

This part is compliant with EU 2002/95/EC RoHS directive (Restrictions on the Use of Certain Hazardous Substances in Electrical and Electronic Equipment).

This product also has the following attributes:

- Lead Free
- Halogen Free (Chlorine, Bromine)
- Antimony Free
- TBBP-A (C₁₅H₁₂Br₄O₂) Free
- PFOS Free
- SVHC Free

Contact Information

For the latest specifications, additional product information, worldwide sales and distribution locations, and information about TriQuint:

Web: www.triquint.com
Email: info-sales@triquint.com

Tel: +1.972.994.8465
Fax: +1.972.994.8504

For technical questions and application information: Email: info-products@triquint.com

Important Notice

The information contained herein is believed to be reliable. TriQuint makes no warranties regarding the information contained herein. TriQuint assumes no responsibility or liability whatsoever for any of the information contained herein. TriQuint assumes no responsibility or liability whatsoever for the use of the information contained herein. The information contained herein is provided "AS IS, WHERE IS" and with all faults, and the entire risk associated with such information is entirely with the user. All information contained herein is subject to change without notice. Customers should obtain and verify the latest relevant information before placing orders for TriQuint products. The information contained herein or any use of such information does not grant, explicitly or implicitly, to any party any patent rights, licenses, or any other intellectual property rights, whether with regard to such information itself or anything described by such information.

TriQuint products are not warranted or authorized for use as critical components in medical, life-saving, or life-sustaining applications, or other applications where a failure would reasonably be expected to cause severe personal injury or death.

Данный компонент на территории Российской Федерации

Вы можете приобрести в компании MosChip.

Для оперативного оформления запроса Вам необходимо перейти по данной ссылке:

<http://moschip.ru/get-element>

Вы можете разместить у нас заказ для любого Вашего проекта, будь то серийное производство или разработка единичного прибора.

В нашем ассортименте представлены ведущие мировые производители активных и пассивных электронных компонентов.

Нашей специализацией является поставка электронной компонентной базы двойного назначения, продукции таких производителей как XILINX, Intel (ex.ALTERA), Vicor, Microchip, Texas Instruments, Analog Devices, Mini-Circuits, Amphenol, Glenair.

Сотрудничество с глобальными дистрибьюторами электронных компонентов, предоставляет возможность заказывать и получать с международных складов практически любой перечень компонентов в оптимальные для Вас сроки.

На всех этапах разработки и производства наши партнеры могут получить квалифицированную поддержку опытных инженеров.

Система менеджмента качества компании отвечает требованиям в соответствии с ГОСТ Р ИСО 9001, ГОСТ РВ 0015-002 и ЭС РД 009

Офис по работе с юридическими лицами:

105318, г.Москва, ул.Щербаковская д.3, офис 1107, 1118, ДЦ «Щербаковский»

Телефон: +7 495 668-12-70 (многоканальный)

Факс: +7 495 668-12-70 (доб.304)

E-mail: info@moschip.ru

Skype отдела продаж:

moschip.ru

moschip.ru_4

moschip.ru_6

moschip.ru_9