

Applications

- Military Radar
- Electronic Warfare
- Test Equipment

Product Features

- Frequency Range: 2 to 18 GHz
- P_{SAT} : 40 dBm at $V_D = 30$ V
- PAE: 20% Typical
- Small Signal Gain: 10 dB
- Return Loss: 15 dB
- Bias: $V_D = 30$ V, $I_{DQ} = 500$ mA, $V_G = -2.3$ V Typical
- Technology: 0.25- μ m GaN on SiC
- Dimensions: 5.66 x 2.67 x 0.5 mm

General Description

The Qorvo TGA2573-2-TS is a wideband, high power GaN HEMT amplifier fabricated on Qorvo's production 0.25- μ m GaN on SiC process. Operating from 2 to 18 GHz, it achieves 40 dBm saturated output power, 20% PAE, and 10 dB small signal gain at a drain bias of 30 V.

The TGA2573-2-TS is a 4-mil thick GaN die mounted on a 15 mil thick Cu-Mo-Cu carrier. This provides the customer a known good die attach to assist in thermal management and provide easier handling

Fully matched to 50 Ω and with integrated DC blocking caps on both RF ports, the TGA2573-2-TS is ideally suited to support both commercial and defense related applications.

The TGA2573-2-TS is 100% DC and RF tested on-wafer to ensure compliance to performance specifications.

Lead-free and RoHS compliant.

The information contained on this data sheet is technical information as defined by 22 CFR 120.10 and is therefore US export controlled. Export or transfer contrary to US law is prohibited.

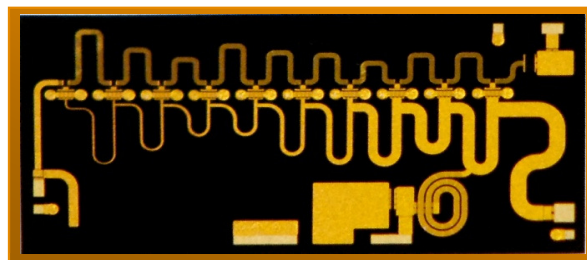

Functional Block Diagram

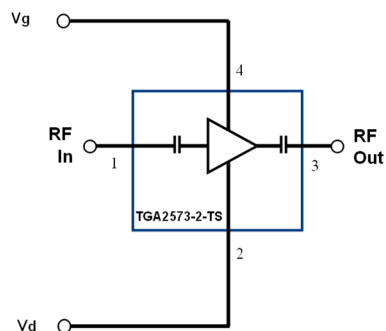

Pad Configuration

Pad No.	Symbol
1	RF In
2	V_D
3	RF Out
4	V_G

Ordering Information

Part	ECCN	Description
TGA2573-2-TS	3A611.x	Die on Thermal Spreader

Absolute Maximum Ratings

Parameter	Value
Drain Voltage (V_D) ⁽¹⁾	40 V
Gate Voltage Range (V_G)	-8 to 0 V
Drain-to-Gate Voltage (V_{DG})	80 V
Drain Current (I_D) ⁽¹⁾ ⁽²⁾	1.3 A
Gate Current (I_G) @ $T = 85$ °C	-4 to 11 mA
Power Dissipation (P_{DISS})	30 W
RF Input Power, CW, 50 Ω , $T = 25$ °C (P_{IN}) ⁽¹⁾	35 dBm
Channel Temperature (T_{CH})	275 °C
Mounting Temperature (30 Seconds)	320 °C
Storage Temperature	-55 to 150 °C

Operation of this device outside the parameter ranges given above may cause permanent damage. These are stress ratings only, and functional operation of the device at these conditions is not implied.

Recommended Operating Conditions

Parameter	Min	Typ	Max	Units
Drain Voltage (V_D)		30	35	V
Drain Current (I_D)		500		mA
Drain Current Under RF Drive (I_{D_DRIVE}) ⁽¹⁾		1200		mA
Gate Voltage (V_G)		-2.3		V

Electrical specifications are measured at specified test conditions. Specifications are not guaranteed over all recommended operating conditions.

Electrical Specifications

Test conditions unless otherwise noted: 25 °C, $V_D = 30$ V, $I_{DQ} = 500$ mA, $V_G = -2.3$ V Typical

Parameter	Typical	Units
Operational Frequency Range	2 to 18	GHz
Small Signal Gain	10	dB
Input Return Loss	15	dB
Output Return Loss	15	dB
Output Power at Saturation (Input Power = 35 dBm)	40	dBm
Output Power at 30 dBm Input Power	38	dBm
Power Added Efficiency	20	%
Output TOI at $P_{out}/tone = 25$ dBm	45	dBm
Noise Figure	6	dB
Small Signal Gain Temperature Coefficient	-0.02	dB/°C
Output Power Temperature Coefficient	-0.005	dBm/°C

The information contained on this data sheet is technical information as defined by 22 CFR 120.10 and is therefore US export controlled. Export or transfer contrary to US law is prohibited.

Thermal and Reliability Information

Parameter	Test Conditions	Value	Units
Thermal Resistance (θ_{JC}) ⁽¹⁾	$P_{DISS} < 17\text{ W}$	5.4	$^{\circ}\text{C/W}$
	$17\text{ W} < P_{DISS} < 27\text{ W}$	6.0	$^{\circ}\text{C/W}$
	$P_{DISS} > 27\text{ W}$	6.2	$^{\circ}\text{C/W}$
Channel Temperature (T_{CH})	$V_D = 30\text{ V}$, $I_D = 500\text{ mA}$,	166	$^{\circ}\text{C}$
Median Lifetime (T_M)	$P_{DISS} = 15\text{ W}$, $T_{BASE} = 85\text{ }^{\circ}\text{C}$	3.2×10^8	Hrs
Maximum Channel Temperature (T_{CH}), Under RF Drive	See plots below		

Notes:

1. Thermal resistance measured to back of carrier.

Median Lifetime and Channel Temperature Rise

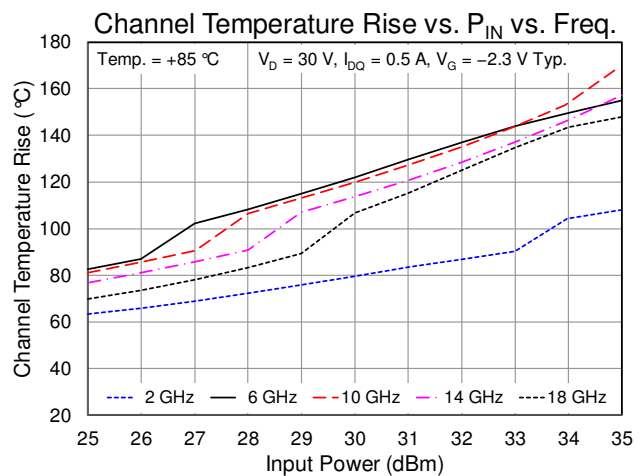
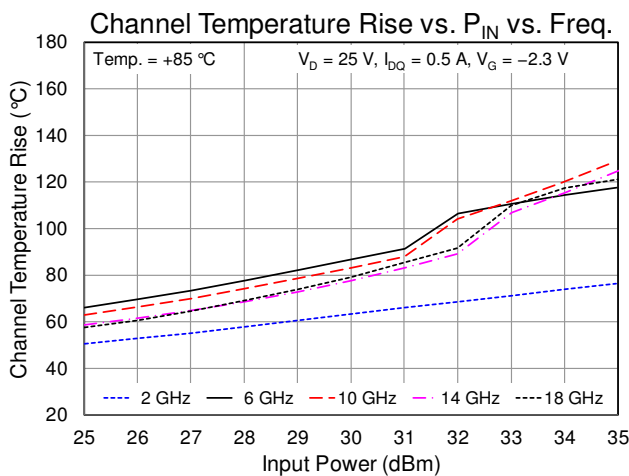
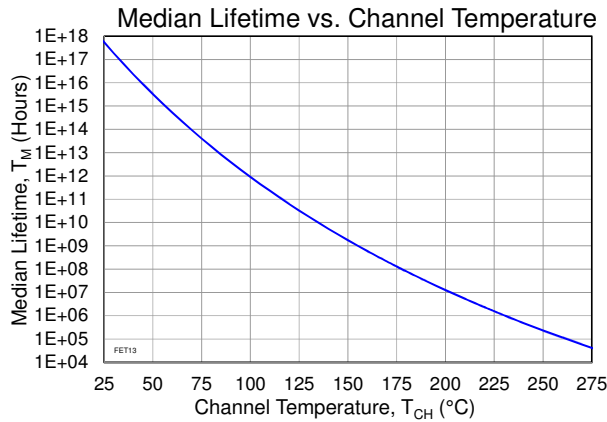

The information contained on this data sheet is technical information as defined by 22 CFR 120.10 and is therefore US export controlled. Export or transfer contrary to US law is prohibited.

Typical Performance

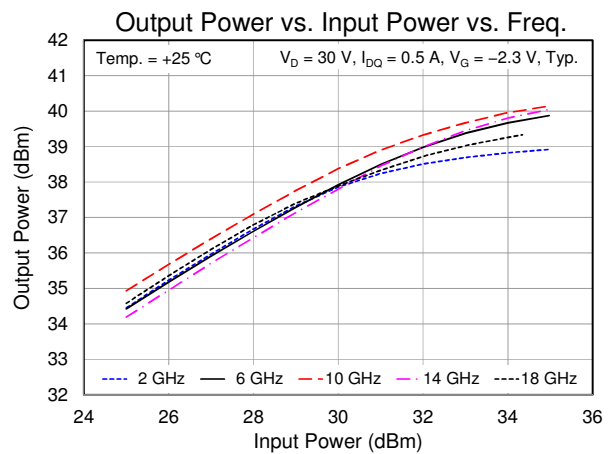
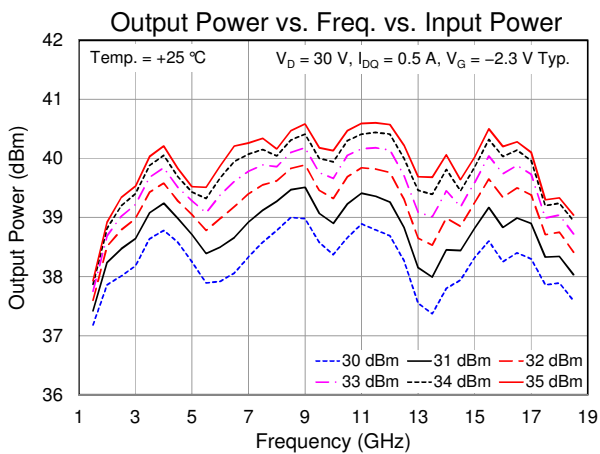
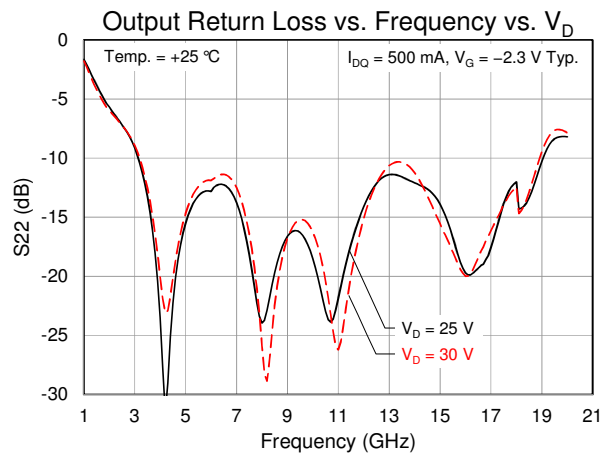
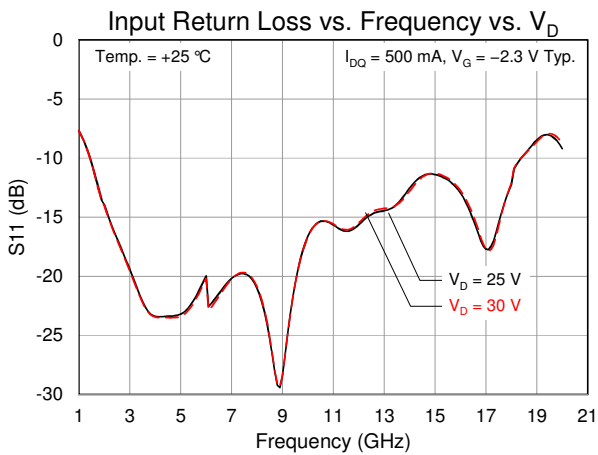
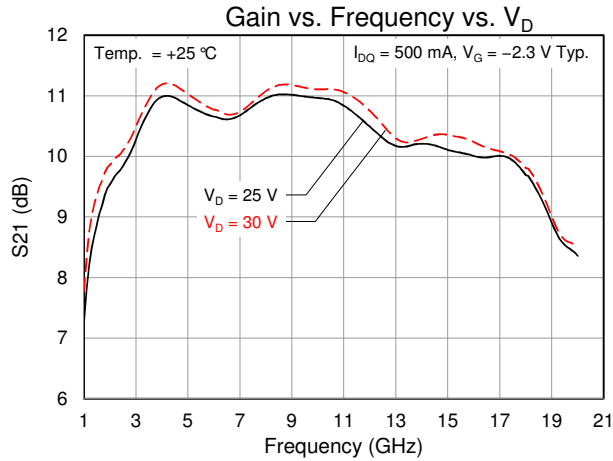

The information contained on this data sheet is technical information as defined by 22 CFR 120.10 and is therefore US export controlled. Export or transfer contrary to US law is prohibited.

Typical Performance

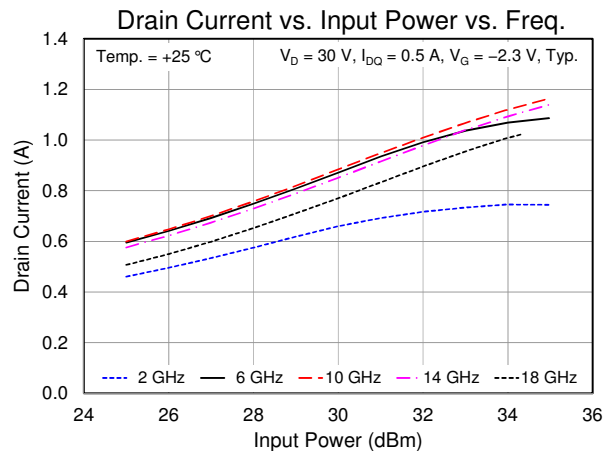
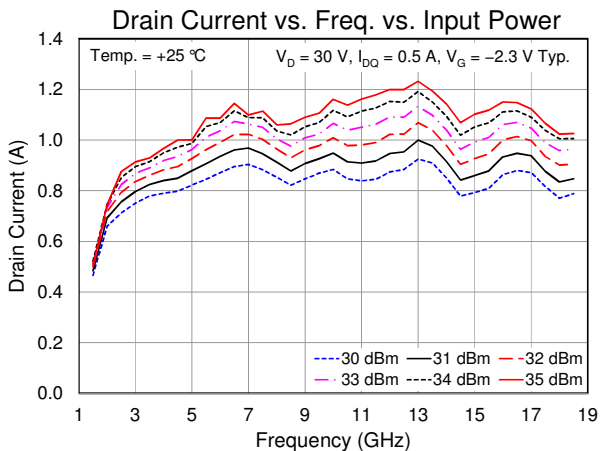
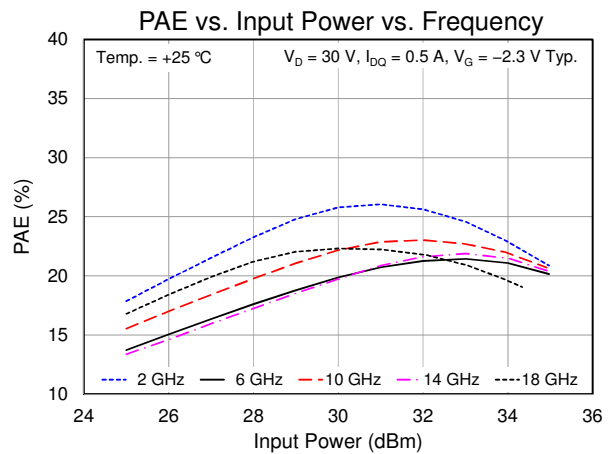
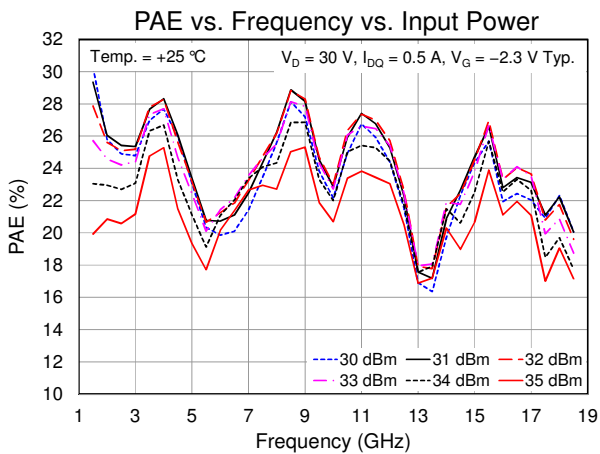
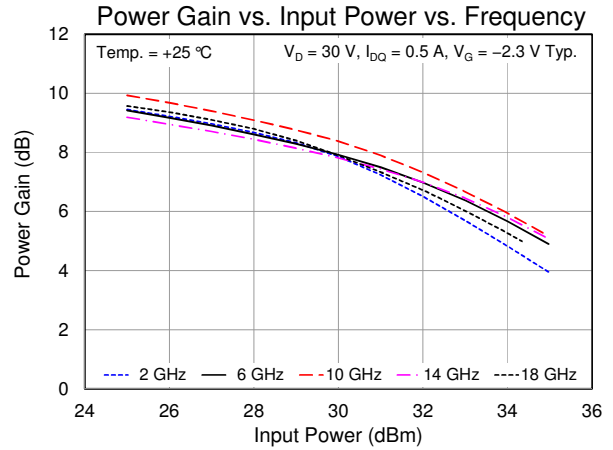
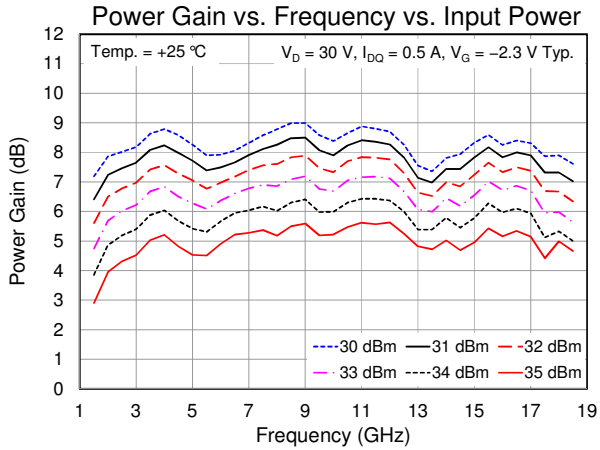

The information contained on this data sheet is technical information as defined by 22 CFR 120.10 and is therefore US export controlled. Export or transfer contrary to US law is prohibited.

Typical Performance

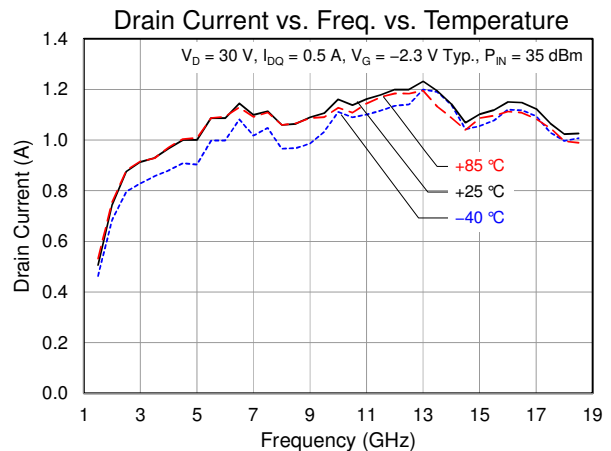
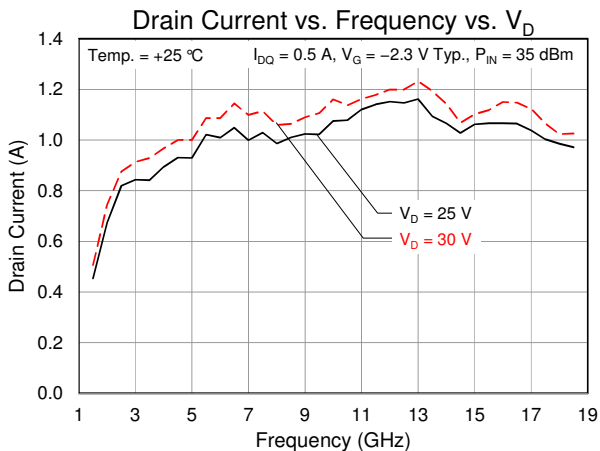
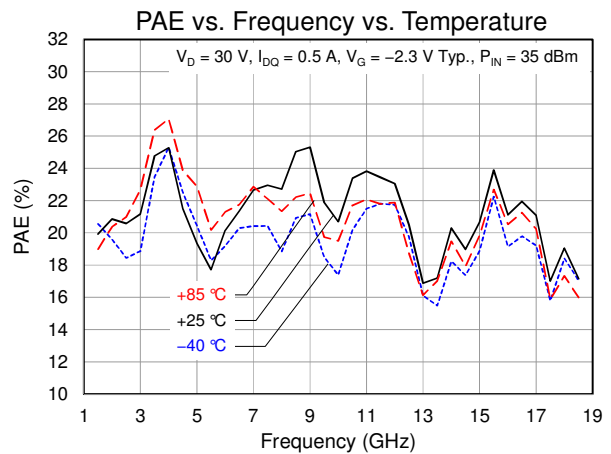
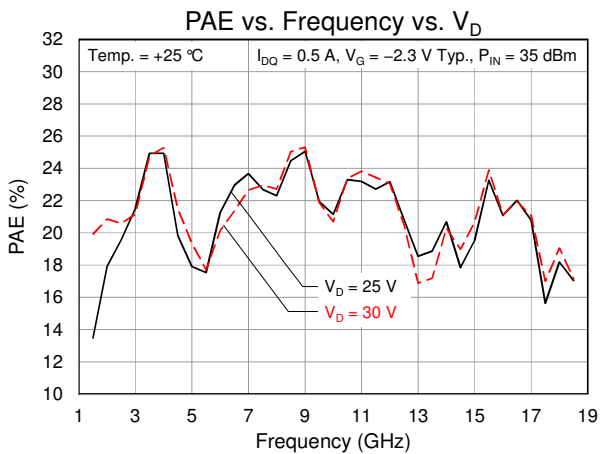
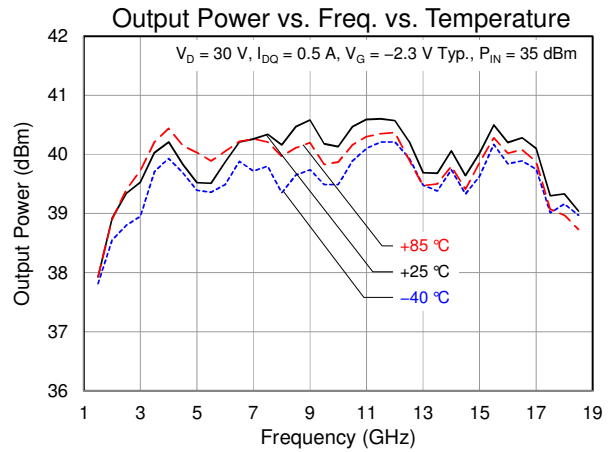
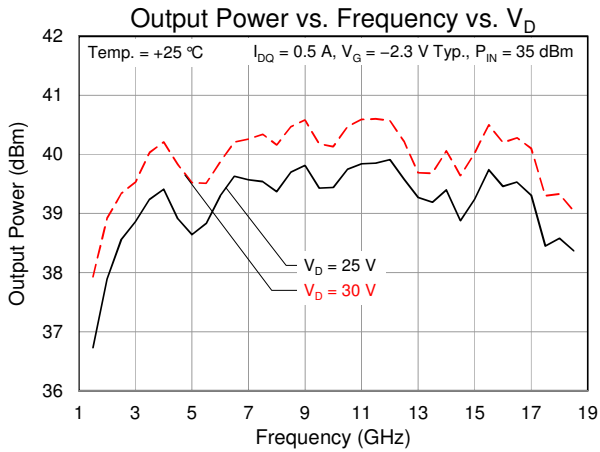

The information contained on this data sheet is technical information as defined by 22 CFR 120.10 and is therefore US export controlled. Export or transfer contrary to US law is prohibited.

Typical Performance

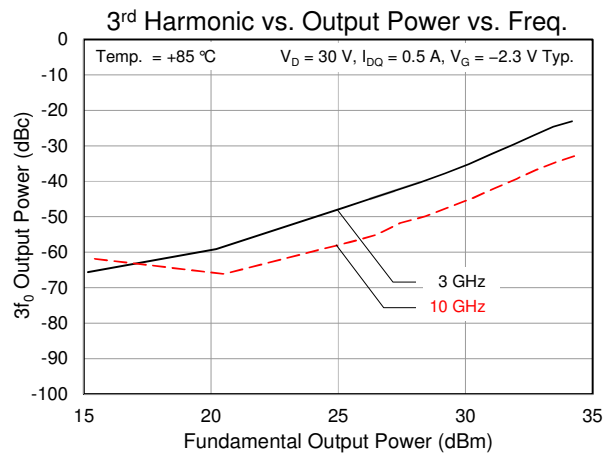
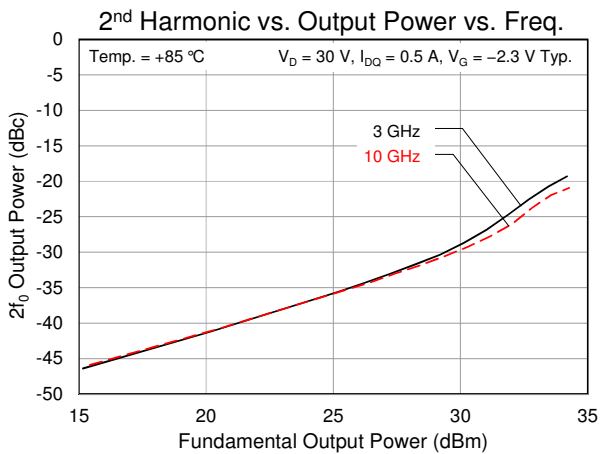
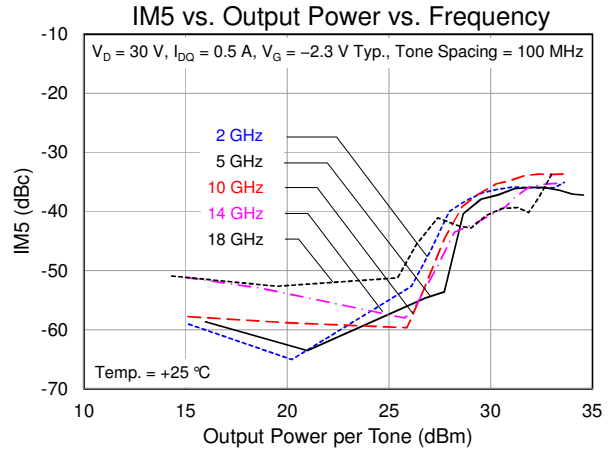
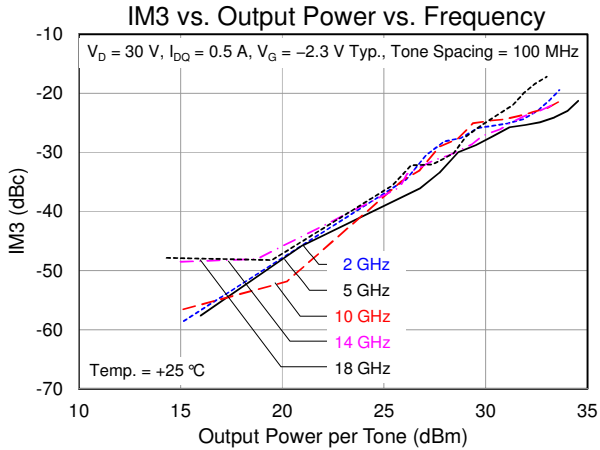

The information contained on this data sheet is technical information as defined by 22 CFR 120.10 and is therefore US export controlled. Export or transfer contrary to US law is prohibited.

Application Circuit

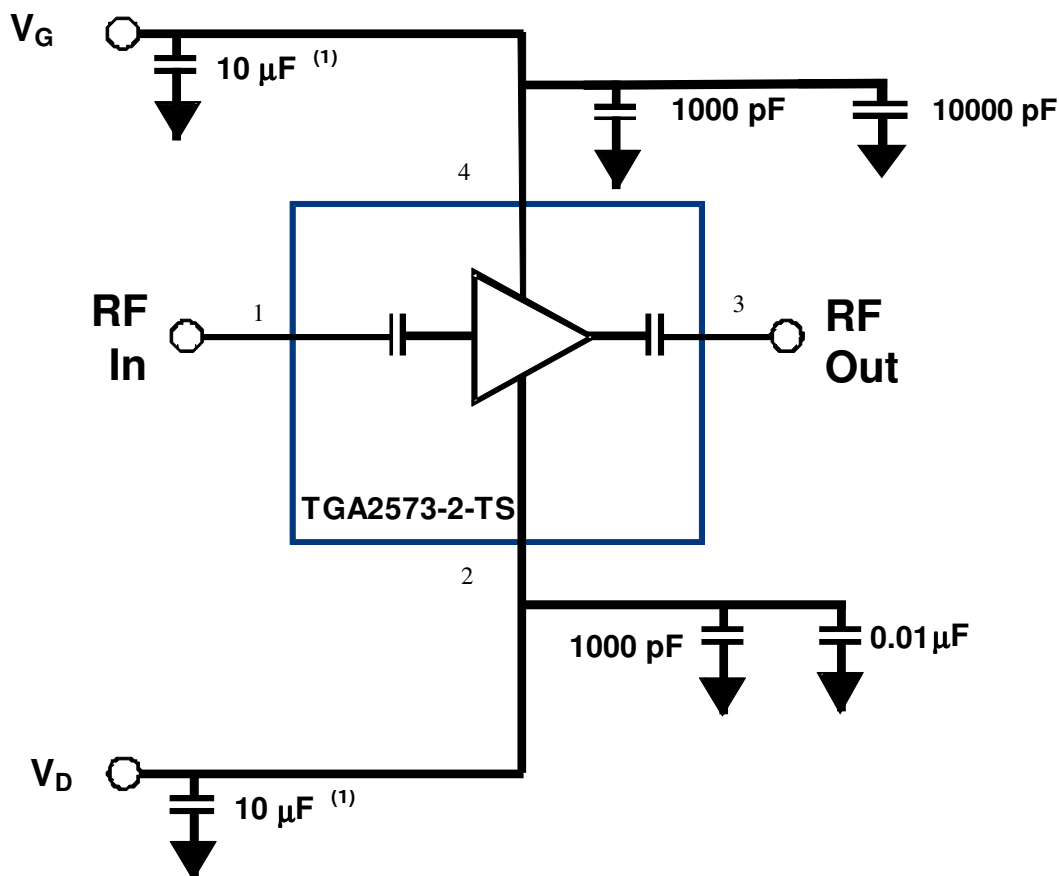

Notes:

1. Additional bypass capacitors may be required at this location. The value of these capacitors varies by application. Variables include power supply impedance, power supply stability with reactive loads, and the inductance from the power supply to this assembly. One to 47 uF tantalum capacitors are commonly used here.

Bias-up Procedure

1. Set I_D limit to 1.3 A, I_G limit to 3 mA
2. Apply -5.0 V to V_G
3. Apply +30 V to V_D
4. Adjust V_G more positive until $I_{DQ} = 500$ mA ($V_G \sim -2.3$ V Typical)
5. Apply RF signal

Bias-down Procedure

1. Turn off RF signal
2. Reduce V_G to -5.0 V. Ensure $I_{DQ} \sim 0$ mA
3. Set V_D to 0 V
4. Turn off V_D supply
5. Turn off V_G supply

The information contained on this data sheet is technical information as defined by 22 CFR 120.10 and is therefore US export controlled. Export or transfer contrary to US law is prohibited.

Bond Pad Description

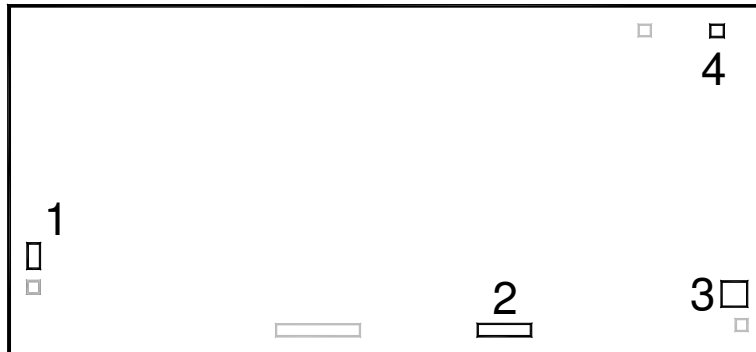

Bond Pads

Pad No.	Symbol	Description
1	RF In	Input; matched to 50 Ω
2	V _D	Drain voltage; bias network is required; see Application Circuit on page 8 as an example
3	RF Out	Output, matched to 50 Ω
4	V _G	Gate voltage; bias network is required; see Application Circuit on page 8 as an example
Backside	GND	Backside of carrier

The information contained on this data sheet is technical information as defined by 22 CFR 120.10 and is therefore US export controlled. Export or transfer contrary to US law is prohibited.

Assembly Drawing

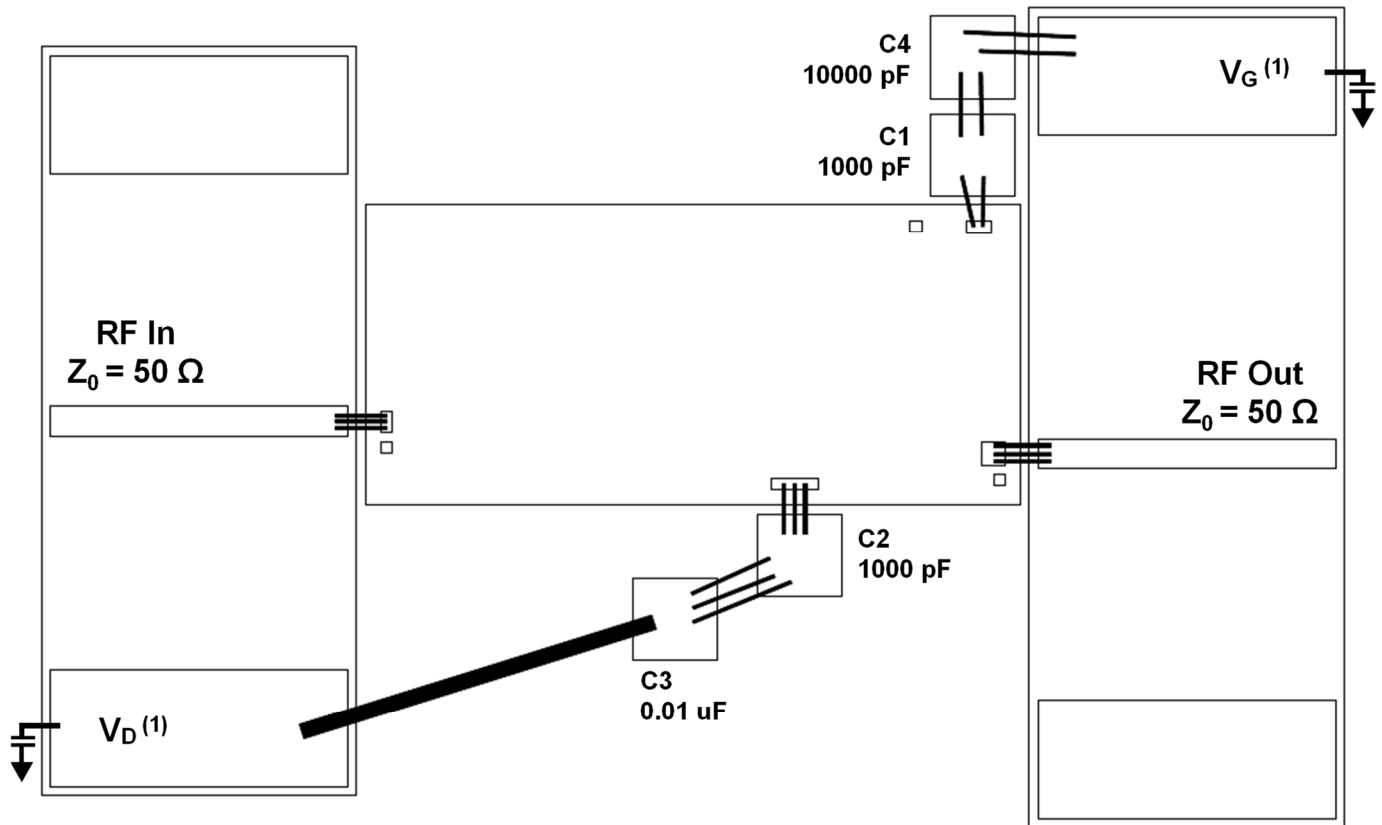

Notes:

1. See Application Circuit page 8 Note 1

Bill of Material

Ref Des.	Value	Description	Manufacturer	Part Number
C1, C2	1000 pF	Cap, 50 V, 10%, Single Layer	various	
C3	0.01 μ F	Cap, 50 V, 10%, SMD	various	
C4	10000 pF	Cap, 50 V, 10%, Single Layer	various	

The information contained on this data sheet is technical information as defined by 22 CFR 120.10 and is therefore US export controlled. Export or transfer contrary to US law is prohibited.

Mechanical Information

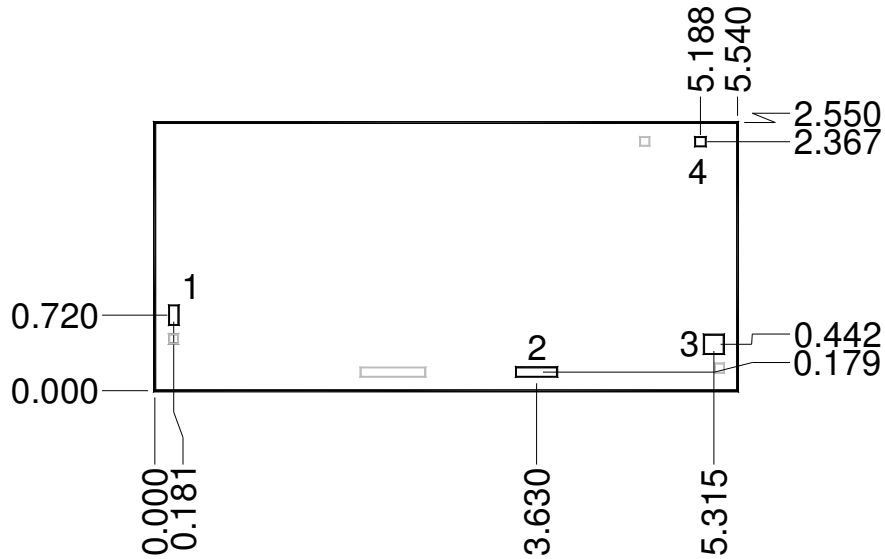

Unit: millimeters
 Thickness: 0.10
 Die x, y size tolerance: ± 0.050
 Chip edge to bond pad dimensions are shown to center of pad
 Ground is backside of die

Bond Pad Dimensions

Pad No.	Symbol	Pad Size
1	RF In	0.100 x 0.195
2	V _D	0.400 x 0.100
3	RF Out	0.200 x 0.195
4	V _G	0.110 x 0.100

The information contained on this data sheet is technical information as defined by 22 CFR 120.10 and is therefore US export controlled. Export or transfer contrary to US law is prohibited.

Mechanical Information – Die on Carrier

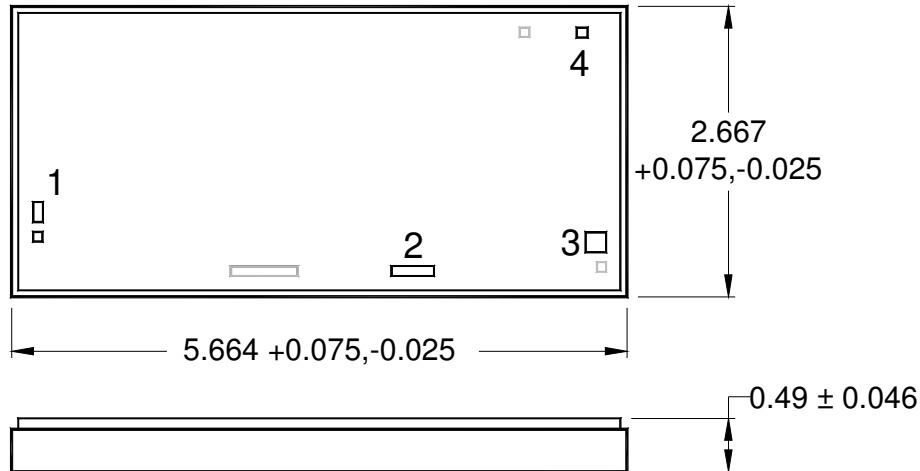

Unit: millimeters
 Material for carrier:
 Cu-Mo-Cu
 Thickness: 0.381 ± 0.025
 Plating for carrier:
 Gold (Au) over Nickel (Ni)
 MMIC die is attached to carrier using solder
 MMIC die is nominally centered on carrier.

Assembly Notes

Component placement assembly notes:

- Vacuum pencils and/or vacuum collets are the preferred method of pick up.
- Air bridges must be avoided during placement.
- The force impact is critical during auto placement.

Interconnect process assembly notes:

- Thermosonic ball bonding is the preferred interconnect technique.
- Force, time, and ultrasonics are critical parameters.
- Aluminum wire should not be used.
- Devices with small pad sizes should be bonded with 0.0007-inch wire.

The information contained on this data sheet is technical information as defined by 22 CFR 120.10 and is therefore US export controlled. Export or transfer contrary to US law is prohibited.

Product Compliance Information

ESD Sensitivity Ratings



Caution! ESD-Sensitive Device

ESD Rating: TBD
Value: TBD
Test: Human Body Model (HBM)
Standard: JEDEC Standard JESD22-A114

ECCN

US Department of State 3A611.x

RoHS Compliance

This part is compliant with the 2011/65/EU RoHS directive (Restrictions on the Use of Certain Hazardous Substances in Electrical and Electronic Equipment), as amended by Directive 2015/863/EU.

This product also has the following attributes:

- Lead Free
- Halogen Free (Chlorine, Bromine)
- Antimony Free
- TBBP-A (C₁₅H₁₂Br₄O₂) Free
- PFOS Free
- SVHC Free

Contact Information

For the latest specifications, additional product information, worldwide sales and distribution locations, and information about Qorvo:

Web: www.qorvo.com
Email: info-sales@qorvo.com

Tel: +1.972.994.8465
Fax: +1.972.994.8504

For technical questions and application information: **Email:** info-products@qorvo.com

Important Notice

The information contained herein is believed to be reliable. Qorvo makes no warranties regarding the information contained herein. Qorvo assumes no responsibility or liability whatsoever for any of the information contained herein. Qorvo assumes no responsibility or liability whatsoever for the use of the information contained herein. The information contained herein is provided "AS IS, WHERE IS" and with all faults, and the entire risk associated with such information is entirely with the user. All information contained herein is subject to change without notice. Customers should obtain and verify the latest relevant information before placing orders for Qorvo products. The information contained herein or any use of such information does not grant, explicitly or implicitly, to any party any patent rights, licenses, or any other intellectual property rights, whether with regard to such information itself or anything described by such information.

Qorvo products are not warranted or authorized for use as critical components in medical, life-saving, or life-sustaining applications, or other applications where a failure would reasonably be expected to cause severe personal injury or death.

The information contained on this data sheet is technical information as defined by 22 CFR 120.10 and is therefore US export controlled. Export or transfer contrary to US law is prohibited.

Данный компонент на территории Российской Федерации

Вы можете приобрести в компании MosChip.

Для оперативного оформления запроса Вам необходимо перейти по данной ссылке:

<http://moschip.ru/get-element>

Вы можете разместить у нас заказ для любого Вашего проекта, будь то серийное производство или разработка единичного прибора.

В нашем ассортименте представлены ведущие мировые производители активных и пассивных электронных компонентов.

Нашей специализацией является поставка электронной компонентной базы двойного назначения, продукции таких производителей как XILINX, Intel (ex.ALTERA), Vicor, Microchip, Texas Instruments, Analog Devices, Mini-Circuits, Amphenol, Glenair.

Сотрудничество с глобальными дистрибьюторами электронных компонентов, предоставляет возможность заказывать и получать с международных складов практически любой перечень компонентов в оптимальные для Вас сроки.

На всех этапах разработки и производства наши партнеры могут получить квалифицированную поддержку опытных инженеров.

Система менеджмента качества компании отвечает требованиям в соответствии с ГОСТ Р ИСО 9001, ГОСТ РВ 0015-002 и ЭС РД 009

Офис по работе с юридическими лицами:

105318, г.Москва, ул.Щербаковская д.3, офис 1107, 1118, ДЦ «Щербаковский»

Телефон: +7 495 668-12-70 (многоканальный)

Факс: +7 495 668-12-70 (доб.304)

E-mail: info@moschip.ru

Skype отдела продаж:

moschip.ru

moschip.ru_4

moschip.ru_6

moschip.ru_9