

Standard type:  (AQV258) / Reinforced type:  (AQV253H, AQV254H)   (AQV256H)

**DIP6-pin type with  
low on-resistance and  
reinforced insulation**

**PhotoMOS<sup>®</sup>  
HE 1 Form A  
(AQV250, AQV250H)**

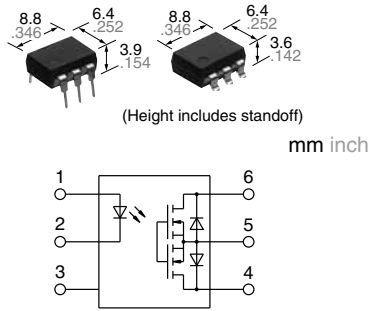

**RoHS compliant**

### FEATURES

1. Wide variation of 40V, 60V, 100V, 200V, 250V, 400V, 600V, 1,000V and 1,500V load voltage
2. Low on-resistance of Typ. 0.6Ω (AQV251)
3. Reinforced insulation type of 5,000Vrms I/O isolation available

### TYPICAL APPLICATIONS

- Measuring instruments
- Data communication equipment
- Telephone equipment
- Automatic meter reading device

### TYPES

	I/O isolation	Output rating*		Package	Part No.				Packing quantity	
					Through hole terminal	Surface-mount terminal		Tube	Tape and reel	
						Tube packing style				Tape and reel packing style
		Load voltage	Load current			Picked from the 1/2/3-pin side	Picked from the 4/5/6-pin side			
AC/DC dual use	1,500Vrms	40 V	500 mA	DIP6-pin	AQV251	AQV251A	AQV251AX	AQV251AZ	1 tube contains: 50 pcs. 1 batch contains: 500 pcs.	1,000 pcs.
		60 V	400 mA		AQV252	AQV252A	AQV252AX	AQV252AZ		
		100 V	350 mA		AQV255	AQV255A	AQV255AX	AQV255AZ		
		200 V	250 mA		AQV257	AQV257A	AQV257AX	AQV257AZ		
		250 V	200 mA		AQV253	AQV253A	AQV253AX	AQV253AZ		
		400 V	150 mA		AQV254	AQV254A	AQV254AX	AQV254AZ		
		1,000 V	30 mA		AQV259	AQV259A	AQV259AX	AQV259AZ		
		1,500 V	20 mA		AQV258	AQV258A	AQV258AX	AQV258AZ		
	Reinforced 5,000Vrms	250 V	200 mA		AQV253H	AQV253HA	AQV253HAX	AQV253HAZ		
		400 V	150 mA		AQV254H	AQV254HA	AQV254HAX	AQV254HAZ		
		600 V	130 mA		AQV256H	AQV256HA	AQV256HAX	AQV256HAZ		

\*Indicate the peak AC and DC values.

Note: The surface mount terminal indicator "A" and the packing style indicator "X" or "Z" are not marked on the device.

## RATING

### 1. Absolute maximum ratings (Ambient temperature: 25°C 77°F)

Item		Sym- bol	Type of connec- tion	AQV251(A)	AQV252(A)	AQV255(A)	AQV257(A)	AQV253(A)	AQV254(A)	AQV259(A)	AQV258(A)	AQV253H(A)	AQV254H(A)	AQV256H(A)	Remarks	
Input	LED forward current	$I_F$		50 mA												
	LED reverse voltage	$V_R$		5 V												
	Peak forward current	$I_{FP}$		1 A												f = 100 Hz, Duty factor +0.1%
	Power dissipation	$P_{in}$		75 mW												
Load voltage (peak AC)	$V_L$	40V		60V	100V	200V	250V	400V	1,000V	1,500V	250V	400V	600V			
Output	Continuous load current	$I_L$		A	0.5A	0.4A	0.35A	0.25A	0.2A	0.15A	0.03A	0.02A	0.2A	0.15A	0.13A	A connection: Peak AC, DC B, C connection: DC
				B	0.7A	0.6A	0.45A	0.35A	0.3A	0.18A	0.04A	0.025A	0.3A	0.18A	0.14A	
				C	1.0A	0.8A	0.70A	0.5A	0.4A	0.25A	0.05A	0.04A	0.4A	0.25A	0.16A	
Peak load current	$I_{peak}$	1.8A		1.5A	1.0A	0.75A	0.6A	0.5A	0.09A	0.06A	0.6A	0.5A	0.4A	A connection: 100 ms (1 shot) $V_L = DC$		
Power dissipation	$P_{out}$	360 mW														
Total power dissipation	$P_T$	410 mW														
I/O isolation voltage		$V_{iso}$	1,500 Vrms											5,000 Vrms		
Ambient temperature	Operating	$T_{opr}$	-40 to +85°C -40 to +185°F											(Non-icing at low temperatures)		
	Storage	$T_{stg}$	-40 to +100°C -40 to +212°F													

### 2. Electrical characteristics (Ambient temperature: 25°C 77°F)

Item		Sym- bol	Type of connec- tion	AQV251(A)	AQV252(A)	AQV255(A)	AQV257(A)	AQV253(A)	AQV254(A)	AQV259(A)	AQV258(A)	AQV253H(A)	AQV254H(A)	AQV256H(A)	Condition		
Input	LED operate current	Typical	—	0.9 mA								1.4 mA				$I_L = \text{Max.}$	
		Maximum		3 mA													
	LED turn off current	Minimum		—	0.4 mA												$I_L = \text{Max.}$
		Typical			0.8 mA								1.3 mA				
LED dropout voltage	Typical	$V_F$	—	1.25 V (1.14 V at $I_F = 5 \text{ mA}$ )												$I_F = 50 \text{ mA}$	
	Maximum			1.5 V													
Output	On resistance	Typical	$R_{on}$	A	0.6 Ω	0.74 Ω	1.8 Ω	2.6 Ω	5.5 Ω	12.4 Ω	85 Ω	345 Ω	5.5 Ω	12.4 Ω	20 Ω	$I_F = 5 \text{ mA}$ $I_L = \text{Max.}$ Within 1 s	
					Maximum	1 Ω	1.4 Ω	2.5 Ω	4 Ω	8 Ω	16 Ω	200 Ω	500 Ω	8 Ω	16 Ω		30 Ω
		Typical	$R_{on}$	B	0.3 Ω	0.37 Ω	0.9 Ω	1.4 Ω	2.7 Ω	6.2 Ω	60 Ω	345 Ω	2.7 Ω	6.2 Ω	15 Ω		
					Maximum	0.5 Ω	0.7 Ω	1.25 Ω	2 Ω	4 Ω	8 Ω	100 Ω	500 Ω	4 Ω	8 Ω		20 Ω
	Typical	$R_{on}$	C	0.15 Ω	0.18 Ω	0.45 Ω	0.7 Ω	1.4 Ω	3.1 Ω	30 Ω	160 Ω	1.4 Ω	3.1 Ω	7.5 Ω	$I_F = 5 \text{ mA}$ $I_L = \text{Max.}$ Within 1 s		
Maximum				0.25 Ω	0.35 Ω	0.63 Ω	1 Ω	2 Ω	4 Ω	50 Ω	250 Ω	2 Ω	4 Ω	10 Ω			
Off state leakage current	Maximum	$I_{Leak}$	—	1 μA						10 μA		1 μA			$I_F = 0 \text{ mA}$ $V_L = \text{Max.}$		
Transfer characteristics	Turn on time*	Typical	$T_{on}$	—	1.7 ms	1.4 ms	0.9 ms	1.5 ms	0.8 ms	0.6 ms	0.35 ms	2.4 ms	1.8 ms	1.2 ms	$I_F = 5 \text{ mA}$ $I_L = \text{Max.}$		
		Maximum			3 ms	2 ms	3 ms	2 ms	1 ms	4 ms	3ms						
	Turn off time*	Typical	$T_{off}$	—	0.07 ms	0.09 ms	0.1 ms	0.06 ms	0.05 ms	0.04 ms	0.06 ms	0.05 ms	0.06 ms	$I_F = 5 \text{ mA}$ $I_L = \text{Max.}$			
		Maximum			0.2 ms												
	I/O capacitance	Typical	$C_{iso}$	—	1.3 pF											f = 1 MHz $V_B = 0 \text{ V}$	
Maximum		3 pF															
Initial I/O isolation resistance	Minimum	$R_{iso}$	—	1,000 MΩ											500 V DC		

\*Turn on/Turn off time

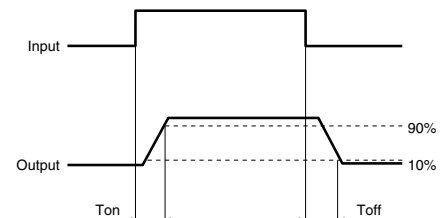

**3. Recommended operating conditions** (Ambient temperature: 25°C 77°F)

Please use under recommended operating conditions to obtain expected characteristics.

	Item	Symbol	Min.	Max.	Unit
	LED current	I <sub>F</sub>	5	30	mA
AQV251(A)	Load voltage (Peak AC)	V <sub>L</sub>	—	32	V
	Continuous load current (A connection)	I <sub>L</sub>	—	0.5	A
AQV252(A)	Load voltage (Peak AC)	V <sub>L</sub>	—	48	V
	Continuous load current (A connection)	I <sub>L</sub>	—	0.4	A
AQV255(A)	Load voltage (Peak AC)	V <sub>L</sub>	—	80	V
	Continuous load current (A connection)	I <sub>L</sub>	—	0.35	A
AQV257(A)	Load voltage (Peak AC)	V <sub>L</sub>	—	160	V
	Continuous load current (A connection)	I <sub>L</sub>	—	0.25	A
AQV253(A)	Load voltage (Peak AC)	V <sub>L</sub>	—	200	V
	Continuous load current (A connection)	I <sub>L</sub>	—	0.2	A
AQV254(A)	Load voltage (Peak AC)	V <sub>L</sub>	—	320	V
	Continuous load current (A connection)	I <sub>L</sub>	—	0.15	A
AQV259(A)	Load voltage (Peak AC)	V <sub>L</sub>	—	800	V
	Continuous load current (A connection)	I <sub>L</sub>	—	0.03	A
AQV258(A)	Load voltage (Peak AC)	V <sub>L</sub>	—	1200	V
	Continuous load current (A connection)	I <sub>L</sub>	—	0.02	A
AQV253H(A)	Load voltage (Peak AC)	V <sub>L</sub>	—	200	V
	Continuous load current (A connection)	I <sub>L</sub>	—	0.2	A
AQV254H(A)	Load voltage (Peak AC)	V <sub>L</sub>	—	320	V
	Continuous load current (A connection)	I <sub>L</sub>	—	0.15	A
AQV256H(A)	Load voltage (Peak AC)	V <sub>L</sub>	—	480	V
	Continuous load current (A connection)	I <sub>L</sub>	—	0.13	A

■ **These products are not designed for automotive use.**

If you are considering to use these products for automotive applications, please contact your local Panasonic Corporation technical representative.

■ **Continual DC bias (for AQV258\*\*, AQV259\*\*)**

In cases in which a continual DC bias is applied between the input and output, the output-side MOS-FET may deteriorate due to the voltage. Therefore, please verify operation of the actual design before using. An example of a circuit that might undergo MOS-FET deterioration due to voltage is given below.

**REFERENCE DATA**

1.-(1) Load current vs. ambient temperature characteristics

Allowable ambient temperature: -40 to +85°C  
-40 to +185°F ;

Type of connection: A

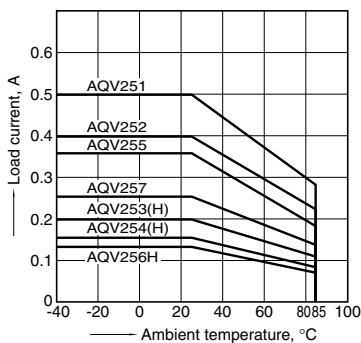

1.-(2) Load current vs. ambient temperature characteristics

Allowable ambient temperature: -40 to +85°C  
-40 to +185°F ;

Type of connection: A



2.-(1) On resistance vs. ambient temperature characteristics

Measured portion: between terminals 4 and 6;  
LED current: 5 mA;  
Continuous load current: Max. (DC)



2.-(2) On resistance vs. ambient temperature characteristics

Measured portion: between terminals 4 and 6;  
LED current: 5 mA;  
Continuous load current: Max. (DC)



2.-(3) On resistance vs. ambient temperature characteristics

Measured portion: between terminals 4 and 6;  
LED current: 5 mA;  
Continuous load current: 30 mA (DC)



3.-(1) Turn on time vs. ambient temperature characteristics

LED current: 5 mA;  
Load voltage: Max. (DC);  
Continuous load current: Max. (DC)



# HE 1 Form A (AQV250, AQV250H)

## 3.-(2) Turn on time vs. ambient temperature characteristics

LED current: 5 mA; Load voltage: Max. (DC);  
Continuous load current: Max. (DC)



## 4.-(1) Turn off time vs. ambient temperature characteristics

LED current: 5 mA; Load voltage: Max. (DC);  
Continuous load current: Max. (DC)



## 4.-(2) Turn off time vs. ambient temperature characteristics

Sample: AQV253H, AQV254H, AQV256H  
LED current: 5 mA; Load voltage: Max. (DC);  
Continuous load current: Max. (DC)



## 5.-(1) LED operate current vs. ambient temperature characteristics

Sample: AQV251, AQV252, AQV253, AQV254, AQV255, AQV257, AQV258, AQV259; Load voltage: Max. (DC); Continuous load current: Max. (DC)



## 5.-(2) LED operate current vs. ambient temperature characteristics

Sample: AQV253H, AQV254H, AQV256H; Load voltage: Max. (DC); Continuous load current: Max. (DC)



## 6.-(1) LED turn off current vs. ambient temperature characteristics

Sample: AQV251, AQV252, AQV253, AQV254, AQV255, AQV257, AQV258, AQV259; Load voltage: Max. (DC); Continuous load current: Max. (DC)



## 6.-(2) LED turn off current vs. ambient temperature characteristics

Sample: AQV253H, AQV254H, AQV256H; Load voltage: Max. (DC); Continuous load current: Max. (DC)

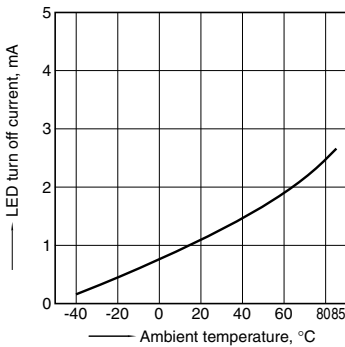

## 7. LED dropout voltage vs. ambient temperature characteristics

LED current: 5 to 50 mA

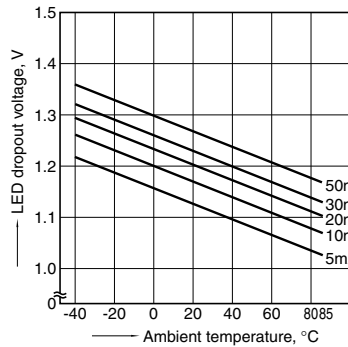

## 8.-(1) Current vs. voltage characteristics of output at MOS portion

Measured portion: between terminals 4 and 6;  
Ambient temperature: 25°C 77°F



## 8.-(2) Current vs. voltage characteristics of output at MOS portion

Measured portion: between terminals 4 and 6;  
Ambient temperature: 25°C 77°F

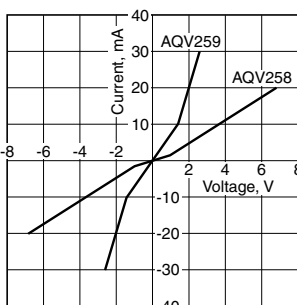

## 9.-(1) Off state leakage current vs. load voltage characteristics

Sample: AQV259; Measured portion: between terminals 4 and 6;  
Ambient temperature: 25°C 77°F



## 9.-(2) Off state leakage current vs. load voltage characteristics

Measured portion: between terminals 4 and 6;  
Ambient temperature: 25°C 77°F



## 10-(1). Turn on time vs. LED forward current characteristics

Measured portion: between terminals 4 and 6;  
Load voltage: Max. (DC); Continuous load current: Max. (DC); Ambient temperature: 25°C 77°F



## 10-(2). Turn on time vs. LED forward current characteristics

Measured portion: between terminals 4 and 6;  
Load voltage: Max. (DC); Continuous load current: Max. (DC); Ambient temperature: 25°C 77°F



## 11-(1). Turn off time vs. LED forward current characteristics

Measured portion: between terminals 4 and 6;  
Load voltage: Max. (DC); Continuous load current: Max. (DC); Ambient temperature: 25°C 77°F



## 11-(2). Turn off time vs. LED forward current characteristics

Measured portion: between terminals 4 and 6;  
Load voltage: Max. (DC); Continuous load current: Max. (DC); Ambient temperature: 25°C 77°F



## 12-(1) Output capacitance vs. applied voltage characteristics

Measured portion: between terminals 4 and 6;  
Frequency: 1 MHz;  
Ambient temperature: 25°C 77°F



## 12-(2) Output capacitance vs. applied voltage characteristics

Sample: AQV259;  
Measured portion: between terminals 4 and 6;  
Frequency: 1 MHz; Ambient temperature: 25°C 77°F

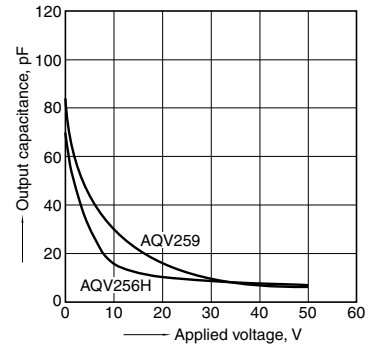

"PhotoMOS®", "PhotoMOS" and "PHOTOMOS" are registered trademarks of Panasonic Corporation.

\*Recognized in Japan, the United States, all member states of European Union and other countries.

Please contact .....

---

**Panasonic Corporation**

Electromechanical Control Business Division

■ 1006, Oaza Kadoma, Kadoma-shi, Osaka 571-8506, Japan  
[industrial.panasonic.com/ac/e/](http://industrial.panasonic.com/ac/e/)

**Panasonic®**

©Panasonic Corporation 2017

# Mouser Electronics

Authorized Distributor

Click to View Pricing, Inventory, Delivery & Lifecycle Information:

Panasonic:

[AQV214EA](#) [AQV214EH](#) [AQV212EHAZ](#)

## Данный компонент на территории Российской Федерации

### Вы можете приобрести в компании MosChip.

Для оперативного оформления запроса Вам необходимо перейти по данной ссылке:

<http://moschip.ru/get-element>

Вы можете разместить у нас заказ для любого Вашего проекта, будь то серийное производство или разработка единичного прибора.

В нашем ассортименте представлены ведущие мировые производители активных и пассивных электронных компонентов.

Нашей специализацией является поставка электронной компонентной базы двойного назначения, продукции таких производителей как XILINX, Intel (ex.ALTERA), Vicor, Microchip, Texas Instruments, Analog Devices, Mini-Circuits, Amphenol, Glenair.

Сотрудничество с глобальными дистрибьюторами электронных компонентов, предоставляет возможность заказывать и получать с международных складов практически любой перечень компонентов в оптимальные для Вас сроки.

На всех этапах разработки и производства наши партнеры могут получить квалифицированную поддержку опытных инженеров.

Система менеджмента качества компании отвечает требованиям в соответствии с ГОСТ Р ИСО 9001, ГОСТ РВ 0015-002 и ЭС РД 009

### Офис по работе с юридическими лицами:

105318, г.Москва, ул.Щербаковская д.3, офис 1107, 1118, ДЦ «Щербаковский»

Телефон: +7 495 668-12-70 (многоканальный)

Факс: +7 495 668-12-70 (доб.304)

E-mail: [info@moschip.ru](mailto:info@moschip.ru)

Skype отдела продаж:

moschip.ru

moschip.ru\_4

moschip.ru\_6

moschip.ru\_9