

Optocoupler, Phototransistor Output, High Temperature

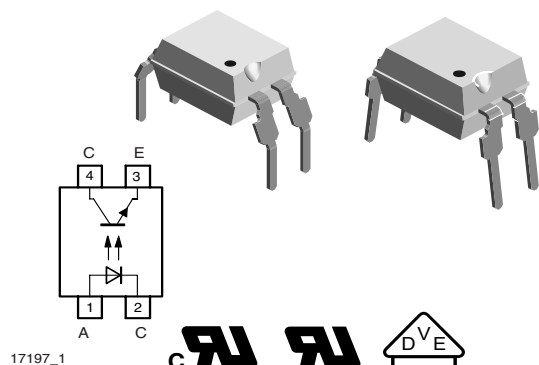

DESCRIPTION

The TCET110. consists of a phototransistor optically coupled to a gallium arsenide infrared-emitting diode in a 4-lead plastic dual inline package.

The elements are mounted on one leadframe using a coplanar technique, providing a fixed distance between input and output for highest safety requirements.

VDE STANDARDS

These couplers perform safety functions according to the following equipment standards:

- **DIN EN 60747-5-5**
Optocoupler for electrical safety requirements
- **IEC 60950/EN 60950**
Office machines (applied for reinforced isolation for mains voltage $\leq 400 V_{RMS}$)
- **VDE 0804**
Telecommunication apparatus and data processing
- **IEC 60065**
Safety for mains-operated electronic and related household apparatus

FEATURES

- Extra low coupling capacity - typical 0.2 pF
- High common mode rejection
- Low temperature coefficient of CTR
- CTR offered in 9 groups
- Reinforced isolation provides circuit protection against electrical shock (safety class II)
- Isolation materials according to UL94-VO
- Pollution degree 2 (DIN/VDE 0110/resp. IEC 60664)
- Climatic classification 55/100/21 (IEC 60068 part 1)
- Rated impulse voltage (transient overvoltage) $V_{IOTM} = 8 \text{ kV}_{peak}$
- Isolation test voltage (partial discharge test voltage) $V_{pd} = 1.6 \text{ kV}$
- Rated isolation voltage (RMS includes DC) $V_{IOWM} = 600 V_{RMS}$
- Rated recurring peak voltage (repetitive) $V_{IORM} = 848 V_{peak}$
- Thickness through insulation $\geq 0.75 \text{ mm}$
- Creepage current resistance according to VDE 0303/ IEC 60112 comparative tracking index: $CTI \geq 175$
- Lead (Pb)-free component
- Component in accordance to RoHS 2002/95/EC and WEEE 2002/96/EC



APPLICATIONS

- switch-mode power supplies
- line receiver
- computer peripheral interface
- microprocessor system interface
- Circuits for safe protective separation against electrical shock according to safety class II (reinforced isolation):
 - for appl. class I - IV at mains voltage $\leq 300 \text{ V}$
 - for appl. class I - III at mains voltage $\leq 600 \text{ V}$ according to DIN EN 60747-5-5.

AGENCY APPROVALS

- UL1577, file no. E76222 system code U, double protection
- CSA 22.2 bulletin 5A, double protection
- BSI: EN 60065:2002, EN 60950:2000 certificate no. 7081 and 7402
- DIN EN 60747-5-5
- FIMKO



TCET1100/TCET1100G

Optocoupler, Phototransistor Output, Vishay Semiconductors
High Temperature

ORDER INFORMATION	
PART	REMARKS
TCET1100	CTR 50 to 600 %, DIP-4
TCET1101	CTR 40 to 80 %, DIP-4
TCET1102	CTR 63 to 125 %, DIP-4
TCET1103	CTR 100 to 200 %, DIP-4
TCET1104	CTR 160 to 320 %, DIP-4
TCET1105	CTR 50 to 150 %, DIP-4
TCET1106	CTR 100 to 300 %, DIP-4
TCET1107	CTR 80 to 160 %, DIP-4
TCET1108	CTR 130 to 260 %, DIP-4
TCET1109	CTR 200 to 400 %, DIP-4
TCET1100G	CTR 50 to 600 %, DIP-4
TCET1101G	CTR 40 to 80 %, DIP-4
TCET1102G	CTR 63 to 125 %, DIP-4
TCET1103G	CTR 100 to 200 %, DIP-4
TCET1104G	CTR 160 to 320 %, DIP-4
TCET1105G	CTR 50 to 150 %, DIP-4
TCET1106G	CTR 100 to 300 %, DIP-4
TCET1107G	CTR 80 to 160 %, DIP-4
TCET1108G	CTR 130 to 260 %, DIP-4
TCET1109G	CTR 200 to 400 %, DIP-4

Note

G = lead form 10.16 mm; G is not marked on the body

ABSOLUTE MAXIMUM RATINGS ⁽¹⁾				
PARAMETER	TEST CONDITION	SYMBOL	VALUE	UNIT
INPUT				
Reverse voltage		V_R	6	V
Forward current		I_F	60	mA
Forward surge current	$t_p \leq 10 \mu s$	I_{FSM}	1.5	A
OUTPUT				
Collector emitter voltage		V_{CEO}	70	V
Emitter collector voltage		V_{ECO}	7	V
Collector current		I_C	50	mA
Collector peak current	$t_p/T = 0.5, t_p \leq 10 ms$	I_{CM}	100	mA
COUPLER				
Isolation test voltage (RMS)	$t = 1 min$	V_{ISO}	5000	V_{RMS}
Operating ambient temperature range		T_{amb}	- 40 to + 100	°C
Storage temperature range		T_{stg}	- 55 to + 125	°C
Soldering temperature	2 mm from case, $\leq 10 s$	T_{sld}	260	°C

Notes

(1) $T_{amb} = 25 \text{ }^\circ\text{C}$, unless otherwise specified.

Stresses in excess of the absolute maximum ratings can cause permanent damage to the device. Functional operation of the device is not implied at these or any other conditions in excess of those given in the operational sections of this document. Exposure to absolute maximum ratings for extended periods of the time can adversely affect reliability.

(2) Refer to wave profile for soldering conditions for through hole devices (DIP).

THERMAL CHARACTERISTICS (1)				
PARAMETER	TEST CONDITION	SYMBOL	VALUE	UNIT
LED power dissipation	at 25 °C	P_{diss}	100	mW
Output power dissipation	at 25 °C	P_{diss}	150	mW
Maximum LED junction temperature		T_{jmax}	125	°C
Maximum output die junction temperature		T_{jmax}	125	°C
Thermal resistance, junction emitter to board		θ_{EB}	173	°C/W
Thermal resistance, junction emitter to case		θ_{EC}	149	°C/W
Thermal resistance, junction detector to board		θ_{DB}	111	°C/W
Thermal resistance, junction detector to case		θ_{DC}	127	°C/W
Thermal resistance, junction emitter to junction detector		θ_{ED}	173	°C/W
Thermal resistance, board to ambient (2)		θ_{BA}	197	°C/W
Thermal resistance, case to ambient (2)		θ_{CA}	4041	°C/W

Notes

(1) The thermal model is represented in the thermal network below. Each resistance value given in this model can be used to calculate the temperatures at each node for a given operating condition. The thermal resistance from board to ambient will be dependent on the type of PCB, layout and thickness of copper traces. For a detailed explanation of the thermal model, please reference Vishay's Thermal Characteristics of Optocouplers Application note.

(2) For 2 layer FR4 board (4" x 3" x 0.062)



ELECTRICAL CHARACTERISTICS						
PARAMETER	TEST CONDITION	SYMBOL	MIN.	TYP.	MAX.	UNIT
INPUT						
Forward voltage	$I_F = 50 \text{ mA}$	V_F		1.25	1.6	V
Junction capacitance	$V_R = 0, f = 1 \text{ MHz}$	C_j		50		pF
OUTPUT						
Collector emitter voltage	$I_C = 1 \text{ mA}$	V_{CE0}	70			V
Emitter collector voltage	$I_E = 100 \mu\text{A}$	V_{ECO}	7			V
Collector emitter cut-off current	$V_{CE} = 20 \text{ V}, I_F = 0 \text{ A}, E = 0$	I_{CEO}		10	100	nA
COUPLER						
Collector emitter saturation voltage	$I_F = 10 \text{ mA}, I_C = 1 \text{ mA}$	V_{CEsat}			0.3	V
Cut-off frequency	$V_{CE} = 5 \text{ V}, I_F = 10 \text{ mA}, R_L = 100 \Omega$	f_c		110		kHz
Coupling capacitance	$f = 1 \text{ MHz}$	C_k		0.3		pF

Note

$T_{amb} = 25 \text{ °C}$, unless otherwise specified.

Minimum and maximum values are testing requirements. Typical values are characteristics of the device and are the result of engineering evaluation. Typical values are for information only and are not part of the testing requirements.



CURRENT TRANSFER RATIO							
PARAMETER	TEST CONDITION	PART	SYMBOL	MIN.	TYP.	MAX.	UNIT
I_C/I_F	$V_{CE} = 5\text{ V}, I_F = 1\text{ mA}$	TCET1101 TCET1101G	CTR	13	30		%
		TCET1102 TCET1102G	CTR	22	45		%
		TCET1103 TCET1103G	CTR	34	70		%
		TCET1104 TCET1104G	CTR	56	90		%
	$V_{CE} = 5\text{ V}, I_F = 5\text{ mA}$	TCET1100 TCET1100G	CTR	50		600	%
		TCET1105 TCET1105G	CTR	50		150	%
		TCET1106 TCET1106G	CTR	100		300	%
		TCET1107 TCET1107G	CTR	80		160	%
		TCET1108 TCET1108G	CTR	130		260	%
	$V_{CE} = 5\text{ V}, I_F = 10\text{ mA}$	TCET1109 TCET1109G	CTR	200		400	%
		TCET1101 TCET1101G	CTR	40		80	%
		TCET1102 TCET1102G	CTR	63		125	%
TCET1103 TCET1103G		CTR	100		200	%	
		TCET1104 TCET1104G	CTR	160		320	%

MAXIMUM SAFETY RATINGS						
PARAMETER	TEST CONDITION	SYMBOL	MIN.	TYP.	MAX.	UNIT
INPUT						
Forward current		I_F			130	mA
OUTPUT						
Power dissipation		P_{diss}			265	mW
COUPLER						
Rated impulse voltage		V_{IOTM}			8	kV
Safety temperature		T_{si}			150	°C

Note

According to DIN EN 60747-5-5 (see figure 1). This optocoupler is suitable for safe electrical isolation only within the safety ratings. Compliance with the safety ratings shall be ensured by means of suitable protective circuits.

INSULATION RATED PARAMETERS						
PARAMETER	TEST CONDITION	SYMBOL	MIN.	TYP.	MAX.	UNIT
Partial discharge test voltage - routine test	100 %, $t_{test} = 1\text{ s}$	V_{pd}	1.6			kV
Partial discharge test voltage - lot test (sample test)	$t_{Tr} = 60\text{ s}, t_{test} = 10\text{ s},$ (see figure 2)	V_{IOTM}	8			kV
		V_{pd}	1.3			kV
Insulation resistance	$V_{IO} = 500\text{ V}$	R_{IO}	10^{12}			Ω
	$V_{IO} = 500\text{ V}, T_{amb} = 100\text{ °C}$	R_{IO}	10^{11}			Ω
	$V_{IO} = 500\text{ V}, T_{amb} = 150\text{ °C}$ (construction test only)	R_{IO}	10^9			Ω



Fig. 1 - Derating Diagram



Fig. 2 - Test Pulse Diagram for Sample Test According to DIN EN 60747-5-5/DIN EN 60747-; IEC60747

SWITCHING CHARACTERISTICS						
PARAMETER	TEST CONDITION	SYMBOL	MIN.	TYP.	MAX.	UNIT
Delay time	$V_S = 5\text{ V}$, $I_C = 2\text{ mA}$, $R_L = 100\ \Omega$, (see figure 3)	t_d		3.0		μs
Rise time	$V_S = 5\text{ V}$, $I_C = 2\text{ mA}$, $R_L = 100\ \Omega$, (see figure 3)	t_r		3.0		μs
Turn-on time	$V_S = 5\text{ V}$, $I_C = 2\text{ mA}$, $R_L = 100\ \Omega$, (see figure 3)	t_{on}		6.0		μs
Storage time	$V_S = 5\text{ V}$, $I_C = 2\text{ mA}$, $R_L = 100\ \Omega$, (see figure 3)	t_s		0.3		μs
Fall time	$V_S = 5\text{ V}$, $I_C = 2\text{ mA}$, $R_L = 100\ \Omega$, (see figure 3)	t_f		4.7		μs
Turn-off time	$V_S = 5\text{ V}$, $I_C = 2\text{ mA}$, $R_L = 100\ \Omega$, (see figure 3)	t_{off}		5.0		μs
Turn-on time	$V_S = 5\text{ V}$, $I_F = 10\text{ mA}$, $R_L = 1\text{ k}\Omega$, (see figure 4)	t_{on}		9.0		μs
Turn-off time	$V_S = 5\text{ V}$, $I_F = 10\text{ mA}$, $R_L = 1\text{ k}\Omega$, (see figure 4)	t_{off}		10.0		μs



95 10804

Fig. 3 - Test Circuit, Non-Saturated Operation

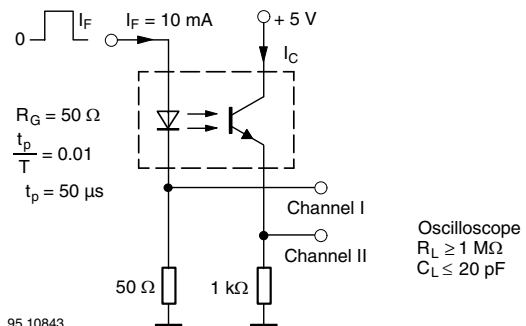

95 10843

Fig. 4 - Test Circuit, Saturated Operation

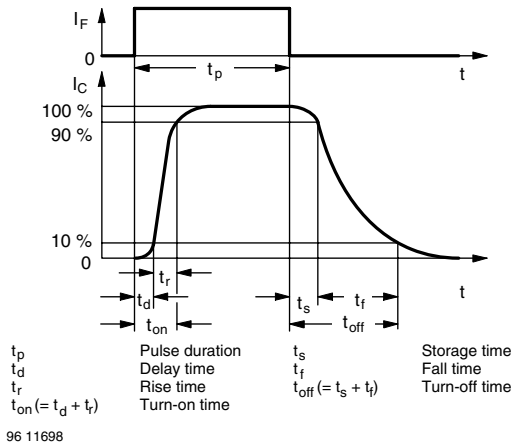

Fig. 5 - Switching Times

TYPICAL CHARACTERISTICS

$T_{amb} = 25\text{ }^\circ\text{C}$, unless otherwise specified



Fig. 6 - Total Power Dissipation vs. Ambient Temperature



Fig. 8 - Relative Current Transfer Ratio vs. Ambient Temperature



Fig. 7 - Forward Current vs. Forward Voltage



Fig. 9 - Collector Dark Current vs. Ambient Temperature



Fig. 10 - Collector Current vs. Forward Current

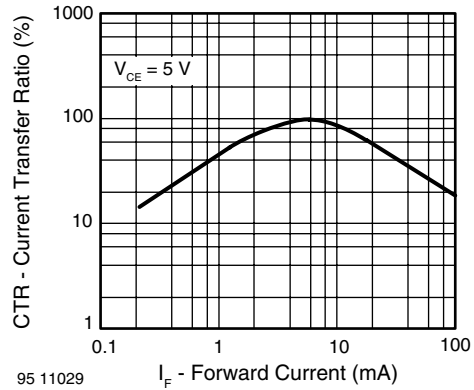

Fig. 13 - Current Transfer Ratio vs. Forward Current

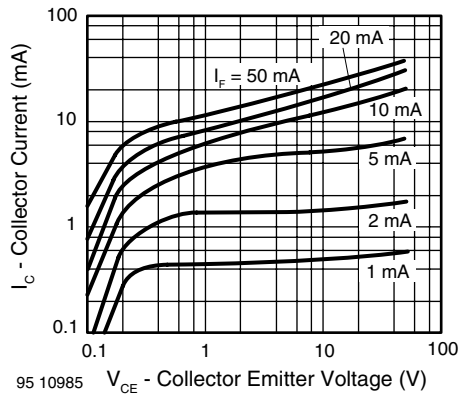

Fig. 11 - Collector Current vs. Collector Emitter Voltage

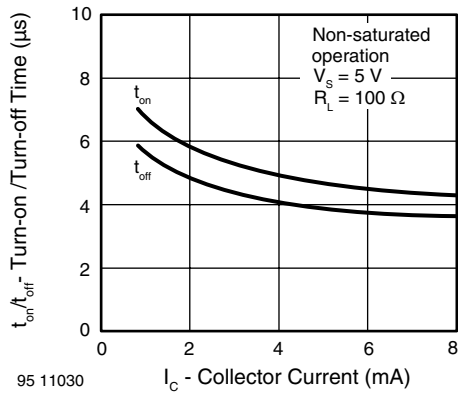

Fig. 14 - Turn-on/off Time vs. Collector Current

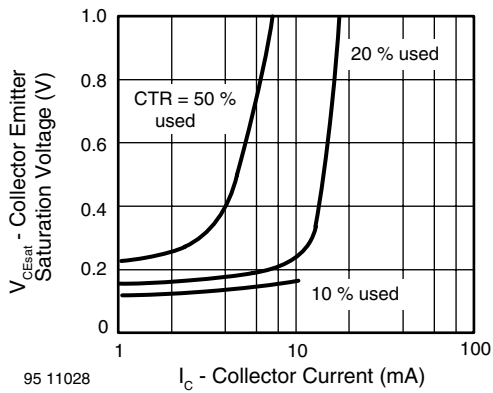

Fig. 12 - Collector Emitter Saturation Voltage vs. Collector Current

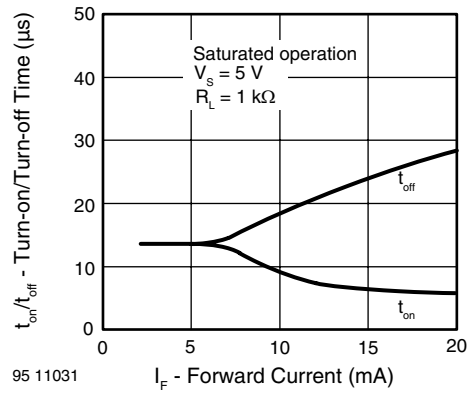

Fig. 15 - Turn-on/off Time vs. Forward Current



TCET1100/TCET1100G

Optocoupler, Phototransistor Output, Vishay Semiconductors
High Temperature

PACKAGE DIMENSIONS in millimeters



E. g.:
Special features: endstackable
to 2.54 mm (0.100") spacing

Weight: ca. 0.25 g
Creepage distance: > 6 mm
Air path: > 6 mm
after mounting on PC board

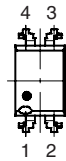

Drawing-No.: 6.544-5302.03-4
Issue: 5; 20.03.02



technical drawings
according to DIN
specifications

14789



E. g.:
Special features: endstackable
to 2.54 mm (0.100") spacing

Weight: ca. 0.25 g
Creepage distance: > 8 mm
Air path: > 8 mm
after mounting on PC board

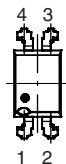

Drawing-No.: 6.544-5303.03-4
Issue: 4; 20.03.02

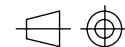

technical drawings
according to DIN
specifications

14792

OZONE DEPLETING SUBSTANCES POLICY STATEMENT

It is the policy of Vishay Semiconductor GmbH to

1. Meet all present and future national and international statutory requirements.
2. Regularly and continuously improve the performance of our products, processes, distribution and operating systems with respect to their impact on the health and safety of our employees and the public, as well as their impact on the environment.

It is particular concern to control or eliminate releases of those substances into the atmosphere which are known as ozone depleting substances (ODSs).

The Montreal Protocol (1987) and its London Amendments (1990) intend to severely restrict the use of ODSs and forbid their use within the next ten years. Various national and international initiatives are pressing for an earlier ban on these substances.

Vishay Semiconductor GmbH has been able to use its policy of continuous improvements to eliminate the use of ODSs listed in the following documents.

1. Annex A, B and list of transitional substances of the Montreal Protocol and the London Amendments respectively.
2. Class I and II ozone depleting substances in the Clean Air Act Amendments of 1990 by the Environmental Protection Agency (EPA) in the USA.
3. Council Decision 88/540/EEC and 91/690/EEC Annex A, B and C (transitional substances) respectively.

Vishay Semiconductor GmbH can certify that our semiconductors are not manufactured with ozone depleting substances and do not contain such substances.

We reserve the right to make changes to improve technical design
and may do so without further notice.

Parameters can vary in different applications. All operating parameters must be validated for each customer application by the customer. Should the buyer use Vishay Semiconductors products for any unintended or unauthorized application, the buyer shall indemnify Vishay Semiconductors against all claims, costs, damages, and expenses, arising out of, directly or indirectly, any claim of personal damage, injury or death associated with such unintended or unauthorized use.

Vishay Semiconductor GmbH, P.O.B. 3535, D-74025 Heilbronn, Germany



Disclaimer

All product specifications and data are subject to change without notice.

Vishay Intertechnology, Inc., its affiliates, agents, and employees, and all persons acting on its or their behalf (collectively, "Vishay"), disclaim any and all liability for any errors, inaccuracies or incompleteness contained herein or in any other disclosure relating to any product.

Vishay disclaims any and all liability arising out of the use or application of any product described herein or of any information provided herein to the maximum extent permitted by law. The product specifications do not expand or otherwise modify Vishay's terms and conditions of purchase, including but not limited to the warranty expressed therein, which apply to these products.

No license, express or implied, by estoppel or otherwise, to any intellectual property rights is granted by this document or by any conduct of Vishay.

The products shown herein are not designed for use in medical, life-saving, or life-sustaining applications unless otherwise expressly indicated. Customers using or selling Vishay products not expressly indicated for use in such applications do so entirely at their own risk and agree to fully indemnify Vishay for any damages arising or resulting from such use or sale. Please contact authorized Vishay personnel to obtain written terms and conditions regarding products designed for such applications.

Product names and markings noted herein may be trademarks of their respective owners.

Данный компонент на территории Российской Федерации

Вы можете приобрести в компании MosChip.

Для оперативного оформления запроса Вам необходимо перейти по данной ссылке:

<http://moschip.ru/get-element>

Вы можете разместить у нас заказ для любого Вашего проекта, будь то серийное производство или разработка единичного прибора.

В нашем ассортименте представлены ведущие мировые производители активных и пассивных электронных компонентов.

Нашей специализацией является поставка электронной компонентной базы двойного назначения, продукции таких производителей как XILINX, Intel (ex.ALTERA), Vicor, Microchip, Texas Instruments, Analog Devices, Mini-Circuits, Amphenol, Glenair.

Сотрудничество с глобальными дистрибьюторами электронных компонентов, предоставляет возможность заказывать и получать с международных складов практически любой перечень компонентов в оптимальные для Вас сроки.

На всех этапах разработки и производства наши партнеры могут получить квалифицированную поддержку опытных инженеров.

Система менеджмента качества компании отвечает требованиям в соответствии с ГОСТ Р ИСО 9001, ГОСТ РВ 0015-002 и ЭС РД 009

Офис по работе с юридическими лицами:

105318, г.Москва, ул.Щербаковская д.3, офис 1107, 1118, ДЦ «Щербаковский»

Телефон: +7 495 668-12-70 (многоканальный)

Факс: +7 495 668-12-70 (доб.304)

E-mail: info@moschip.ru

Skype отдела продаж:

moschip.ru

moschip.ru_4

moschip.ru_6

moschip.ru_9