

# Interface Technology and Switching Devices

2015/2016

# 7

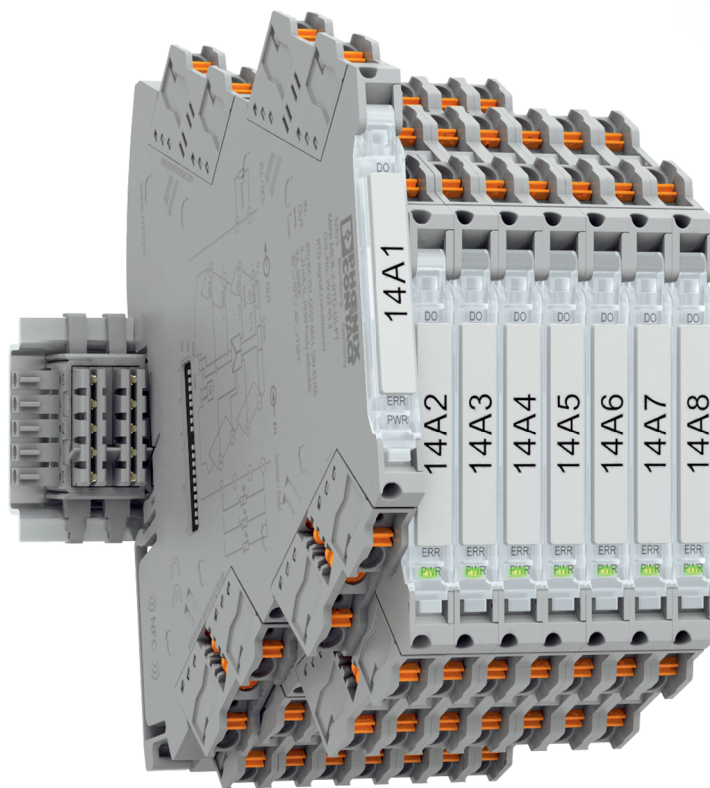



# Interface technology and switching devices



## Terminal blocks

- Terminal blocks



## Surge protection and power supplies

- Surge protection and interference suppression filters
- Power supplies and UPS
- Protective devices



## Sensor/actuator cabling and industrial connectors

- Sensor/actuator cabling
- Cables and lines
- Connectors



## Control technology, I/O systems, and automation infrastructure

- Lighting and signaling
- Fieldbus components and systems
- Functional Safety
- HMIs and industrial PCs
- I/O systems
- Industrial Ethernet
- Industrial communication technology
- Software
- Controllers
- Wireless data communication



## Marking systems, tools, and mounting material

- Marking and labeling
- Tools
- Installation and mounting material

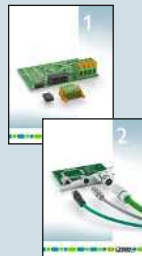

## PCB connection technology and electronics housing 2013/14

- PCB terminal blocks and PCB connectors
- Electronics housing

## Connection technology for field devices 2013/14

- Connectors
- Cables and lines

Information on these products can be found in the electronic product catalogs for 2013/14.

Or get the latest on all the new products and additional information directly in the product area of our website:

[phoenixcontact.net/products](http://phoenixcontact.net/products)

## Find out more with the web code

On some of the catalog pages, you can find our web codes: a number sign followed by a four-digit number combination.

**i** Web code: #1234 (example)

This allows you to reach information on our website quickly.

### It couldn't be simpler:

1. Go to the Phoenix Contact website
2. Enter # and the number combination in the search field
3. Receive more information and product versions

Or use the direct link:





[phoenixcontact.net/webcode/#1234](http://phoenixcontact.net/webcode/#1234)



Also discover the Phoenix Contact catalog app interactively on your tablet.



# Table of contents

<b>Complete overview</b>		<b>4</b>
<b>Electronic switching devices and motor control</b>		<b>8</b>
<b>MCR technology</b>		<b>50</b>
<b>Monitoring</b>		<b>228</b>
<b>Relay modules</b>		<b>314</b>
<b>System cabling for controllers</b>		<b>480</b>
<b>Technical information/index</b>		<b>622</b>

### Electronic switching devices and motor control



Motor management

Page 14



Hybrid motor starters

Page 20



Solid-state contactors

Page 36



IP67 motor starters

Page 46



(Ex i) signal conditioners with SIL functional safety

Page 152



(Ex i) signal conditioners with PL functional safety

Page 184



Multiplexers for HART signals

Page 222



Ex i 2-wire field devices

Page 223



Current transformers

Page 252



Current transformers for retrofitting

Page 266



Test disconnect terminal blocks  
See Catalog 3



Current transducers, current protectors

Page 272



Multifunctional monitoring relays

Page 300



Ultra-narrow timer relays

Page 308



Multifunctional timer relays

Page 310



Function modules

Page 312



Frequency inverters

Page 48

**MCR technology**



Highly compact signal conditioners with plug-in connection technology

Page 64



Highly compact signal conditioners

Page 90



Signal conditioners, head transducers, and process indicators

Page 128

**Monitoring**



Controllers  
See Catalog 8



Energy meters, function and communication modules

Page 238



Complete packages for data logging

Page 245



Compressed air meters

Page 246



PV system monitoring

Page 282



Residual current monitoring

Page 288



Components for E-Mobility

Page 292



Compact monitoring relays

Page 298



Lightning monitoring system  
See Catalog 6



HMIs  
See Catalog 8



Signal towers  
See Catalog 8

# Complete overview

## Product range overview

### Relay modules



RIFLINE complete

Page 328

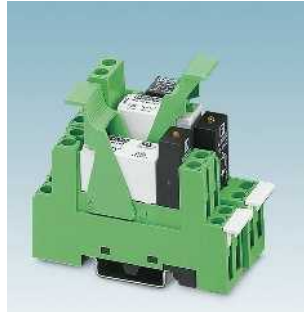

PR series

Page 378



PLC-INTERFACE

Page 400



Programmable logic relay system - PLC logic

Page 452

### System cabling for controllers



Controller-specific system cabling

Page 490



V8 adapters

Page 451

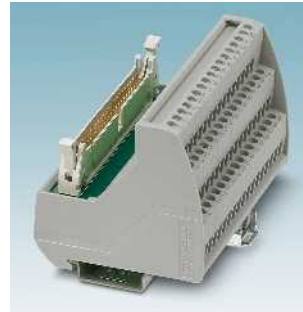

Universal modules

Page 576



Universal cables

Page 600



DEK series

Page 461



Safety devices  
See Catalog 8



Monitoring relays

Page 298



Timer relays

Page 308



Potential distributors

Page 618





# Electronic switching devices and motor control

Switching devices for starting, reversing, and protecting electric motors are some of the most frequently used components in automation technology. These are often designed redundantly for safety-sensitive applications. When it comes to reducing installation time and space requirements, CONTACTRON hybrid motor starters are the state-of-the-art alternative.

This is because CONTACTRON hybrid motor starters combine up to four functions in a single device. Integration into popular fieldbus systems is realized via the INTERFACE system connection or via the SmartWire-DT™ wiring system.

For protection of the entire system, the product range now includes the electronic motor manager (EMM). In addition to typical measured values such as voltage and current, the behavior of the system is monitored and protected by means of real power measurement. The process data in all popular fieldbus systems can be supplied via gateways and evaluated by a controller.

## Product range overview

<b>Product overview</b>	<b>10</b>
Electronic motor management	12
Network-capable hybrid motor starters with reversing function	20
Hybrid motor starters with reversing function	22
Network-capable hybrid motor starters with direct start function	24
Hybrid motor starters with direct start function	26
Hybrid motor starters with short-circuit protection	29
3-phase solid-state reversing contactors	36
3-phase solid-state contactors	38
Solid-state reversing contactor for DC motors	42
Single-phase solid-state contactors	44
IP67 motor starters	46
IP20 frequency inverters	48

## Product overview

### Motor management



Electronic motor management  
Page 14



Gateways  
Page 16



Software  
Page 17

### Hybrid motor starters



Network-capable hybrid motor starters with reversing function  
Page 20



Hybrid motor starters with reversing function  
Page 22



Network-capable hybrid motor starters with direct start function  
Page 24



Hybrid motor starters with direct start function  
Page 26

### Solid-state contactors



3-phase solid-state reversing contactors  
Page 30



3-phase solid-state contactors  
Page 38



Solid-state reversing contactor with soft starter  
Page 40



Solid-state reversing contactor for DC motors  
Page 42

### IP67 motor starters



PROFINET motor starters for distributed use  
Page 46



Stainless steel base, IP67 protection  
Page 47

### Frequency inverters



Inline frequency inverters for the control cabinet  
Page 48



Hybrid motor starters with short-circuit protection

Page 29



Loop bridge for hybrid motor starters

Page 30



SmartWire-DT™ accessories

Page 32



Single-phase solid-state contactors

Page 44



### Electronic motor management (EMM)

The electronic motor management modules offer all the advantages of modern real power monitoring.

The measuring and evaluation electronics for all performance classes. EMM offers the same functionality for all performance classes, only without a power section.

#### Power within limits

Monitoring is based on freely parameterizable switching and signaling thresholds for overload and underload detection. Identical or separate settings can be made for the thresholds relating to the two directions of rotation.

Parameterization relies on the real power consumed (calculated from three currents, voltages, and the phase angle), thereby offering a much more precise basis than if only the current is taken into consideration, as it is independent of voltage fluctuations and drive load. If a switching threshold is violated, the EMM initiates an emergency shutdown of the motor immediately (or with an adjustable “delay time”). In addition, a message can be sent via an output.

This state can only be deactivated via a defined reset. If the real power consumed is determined as being above or below the message thresholds, all that occurs is that a

check-back is returned for the duration for which the module was addressed.

In addition, signals are generated by the module for the recognition of the direction of rotation. Asymmetry and phase failures are detected and signaled.

Permanent status monitoring with high scanning rates and the fast semiconductor switch enable complete system protection, including motor protection.

Without any extra wiring - and with just a single device - pumps, actuating drives, fans, and tools are monitored for proper functioning, contamination (filter or similar), and wear. The adjustable “inrush suppression” time can be used to mask out the switching operation from the monitoring process.

### INTERFACE system

The INTERFACE system (IFS) consists of devices which can be connected to each other via the DIN rail connector (TBUS). A GATEWAY with up to 32 IFS devices forms the head of the INTERFACE system and manages the station.

INTERFACE system properties:

- Use of the INTERFACE system via the DIN rail connector for the purpose of parameterization, diagnostics, and exchange of data with one another
- Compatible with defined IFS accessories
- 24 V supply of the devices (e.g., EMM...IFS, ELR...IFS, EM-GATEWAY-IFS) via the DIN rail connector





Protection against dry running, blocking, and cavitation, warning thresholds to indicate filter contamination.



Protection against blocking, warning thresholds for bearing wear and other cases that trigger overload.



Protection against blocking and broken tools, warning thresholds for tool and bearing wear.

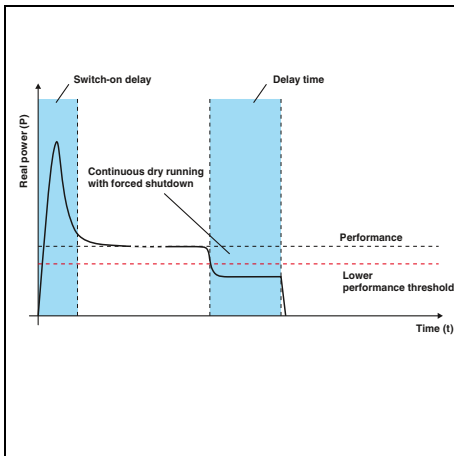

In the case of motor-driven pumps, the lower performance threshold provides reliable protection against hazardous dry running.

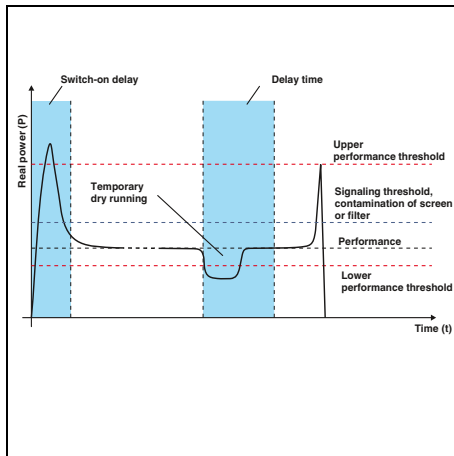

Forced shutdown of the drive can be delayed by the “delay time”. This prevents forced shutdown in the event of air bubbles.

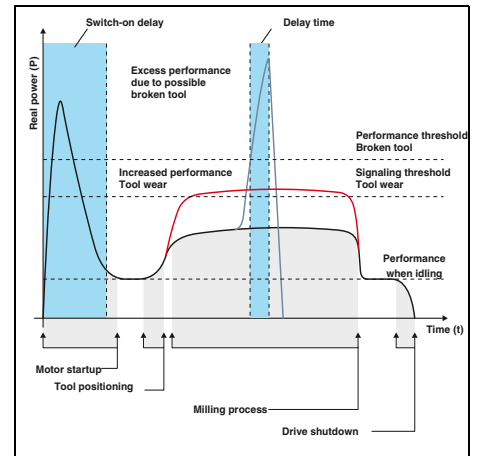

Machine tools are monitored and protected in a similar way when drilling, milling or grinding. If the feed value on a milling machine is set too high, a tool may break in the “worst-case” scenario. The power threshold - parameterized accordingly - can be used to resolve this issue.

Additionally, a message threshold signals tool wear in advance.

## Motor management

### Electronic motor management

The EMM motor management module (with/without current transformer) for all performance classes monitors and protects 3-phase loads, such as electrical drives.

- Freely parameterizable signaling or switching thresholds
- Digital outputs control external switching elements
- Optional connection to INTERFACE system and EM-GATEWAY-IFS via TBUS



Allows the use of external current transformers



With integrated current transformers

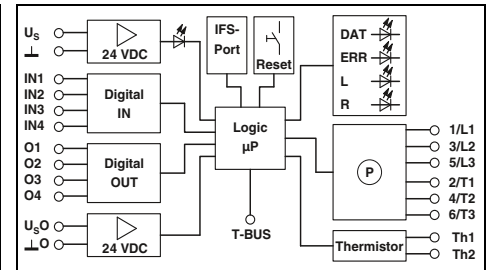
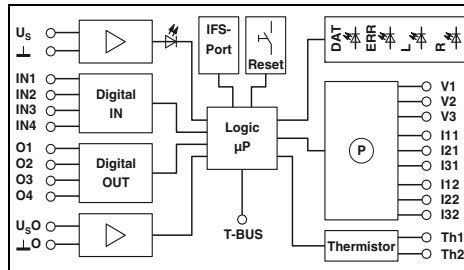

#### Technical data

Input data		
Rated control supply voltage $U_s$	24 V DC	230 V AC
Rated control supply voltage range with reference to $U_s$	0.8 ... 1.25	0.4 ... 1.1
Rated control supply current $I_s$ at $U_s$	25 mA	10 mA
Input data of digital inputs	EMM 3- 24DC/500AC-IFS	EMM 3-230AC/500AC-IFS
Number of inputs	4 (IN1 - IN4)	4 (IN1 - IN4)
Rated actuating voltage $U_c$	24 V DC	230 V AC
Rated actuating current $I_c$	3.3 mA	3.5 mA
Power measurement		
Voltage measuring input	42 V AC ... 575 V AC	42 V AC ... 575 V AC
Nominal current, voltage measuring input	< 0.5 mA	< 0.5 mA
Current measuring input	5 A (secondary external converter)	5 A (secondary external converter)
Output power of the converter	> 1.25 VA	> 1.25 VA
Internal resistance EMM	0.02 $\Omega$	0.02 $\Omega$
Output data for confirmation contacts		
O1 - O4 in the case of 1 signal	24 V DC (semiconductor output) / 500 mA	230 V AC (relay output/500 mA) / 500 mA
General data		
Rated insulation voltage	500 V	
Rated surge voltage	6 kV	6 kV
Ambient temperature (operation)	-25 °C ... 70 °C	
Standards/regulations	EN 60947 / EN 60947-4-2 DIN EN 50178 IP20	
Degree of protection in acc. with IEC 60529/EN 60529	IP20	
Mounting position	Vertical (horizontal DIN rail)	
Screw connection solid / stranded / AWG	0.14 - 2.5 mm <sup>2</sup> / 0.14 - 2.5 mm <sup>2</sup> / 26 - 12	
Dimensions	22.5 mm / 99 mm / 114.5 mm	
EMC note	Class A product, see page 625	

#### Technical data

Input data		
Rated control supply voltage $U_s$	24 V DC	230 V AC
Rated control supply voltage range with reference to $U_s$	0.8 ... 1.25	0.4 ... 1.1
Rated control supply current $I_s$ at $U_s$	25 mA	10 mA
Input data of digital inputs	EMM 3- 24DC/500AC-16-IFS	EMM 3-230AC/500AC-16-IFS
Number of inputs	4 (IN1 - IN4)	4 (IN1 - IN4)
Rated actuating voltage $U_c$	24 V DC	230 V AC
Rated actuating current $I_c$	3.3 mA	3.5 mA
Power measurement		
Voltage measuring input	-	-
Nominal current, voltage measuring input	-	-
Current measuring input	max. 16 A	max. 16 A
Output power of the converter	-	-
Internal resistance EMM	-	-
Output data for confirmation contacts		
O1 - O4 in the case of 1 signal	24 V DC (semiconductor output) / 500 mA	230 V AC (relay output/500 mA) / 500 mA
General data		
Rated insulation voltage	500 V	
Rated surge voltage	6 kV	6 kV
Ambient temperature (operation)	-25 °C ... 70 °C	
Standards/regulations	EN 60947 / EN 60947-4-2 DIN EN 50178 IP20	
Degree of protection in acc. with IEC 60529/EN 60529	IP20	
Mounting position	Vertical (horizontal DIN rail)	
Screw connection solid / stranded / AWG	0.14 - 2.5 mm <sup>2</sup> / 0.14 - 2.5 mm <sup>2</sup> / 26 - 12	
Dimensions	22.5 mm / 99 mm / 114.5 mm	
EMC note	Class A product, see page 625	

#### Ordering data

Description	Type	Order No.	Pcs. / Pkt.
Electronic motor management	EMM 3- 24DC/500AC-IFS	2297497	1
	EMM 3-230AC/500AC-IFS	2297507	1

#### Ordering data

Description	Type	Order No.	Pcs. / Pkt.
Electronic motor management	EMM 3- 24DC/500AC-16-IFS	2297523	1
	EMM 3-230AC/500AC-16-IFS	2297536	1

#### Accessories

Description	Type	Order No.	Pcs. / Pkt.
Programming adapter for configuring modules with S-PORT interface	IFS-USB-PROG-ADAPTER	2811271	1
DIN rail connector	ME 22,5 TBUS 1,5/ 5-ST-3,81 GN	2707437	50
Voltage transducer for 690 V, for EMM 3-.../500AC-IFS, comprising 3 modular terminal blocks and cover	UT 4-MTD-R/CVC 690/SET	2901667	1
Multifunctional memory module for the INTERFACE system	IFS-CONFSTICK	2986122	1
	IFS-CONFSTICK-L	2901103	1
Mini COMBICON connector	MC 1,5/ 5-ST-3,81	1803604	50
	IMC 1,5/ 5-ST-3,81	1857919	50

#### Accessories

Description	Type	Order No.	Pcs. / Pkt.
Programming adapter for configuring modules with S-PORT interface	IFS-USB-PROG-ADAPTER	2811271	1
DIN rail connector	ME 22,5 TBUS 1,5/ 5-ST-3,81 GN	2707437	50
Multifunctional memory module for the INTERFACE system	IFS-CONFSTICK	2986122	1
	IFS-CONFSTICK-L	2901103	1
Mini COMBICON connector	MC 1,5/ 5-ST-3,81	1803604	50
	IMC 1,5/ 5-ST-3,81	1857919	50

Electronic motor management

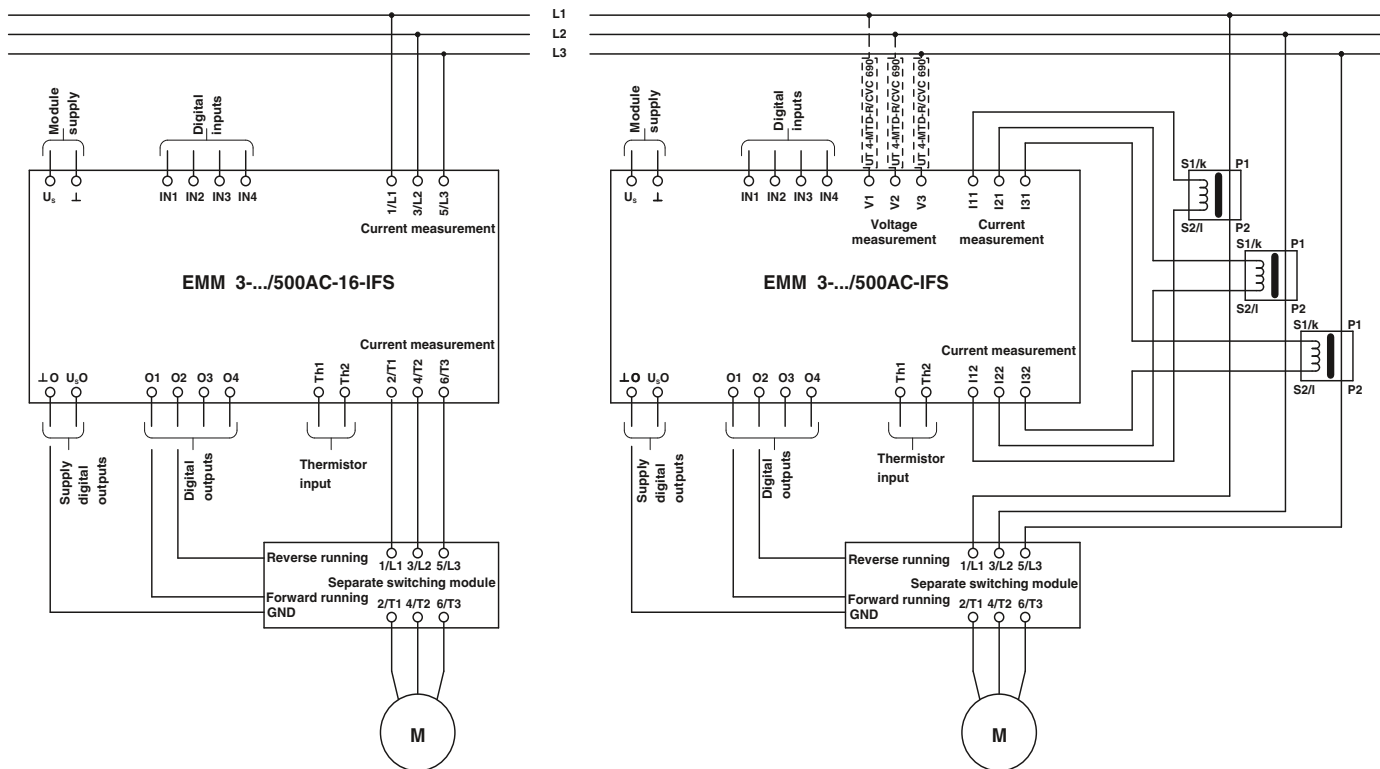

The electronic motor management modules offer all the advantages of modern real power monitoring. Every 6.6 ms, the real power of a drive system or of any other 3-phase load is calculated from three currents, voltages, and the phase angle. Currents of up to 16 A can be directly acquired and currents >16 A are supplied via external converters. Digital outputs can be used to control separate mechanical or electronic switching elements that adopt the actual switching of the load. In this configuration, the EMM reliably protects connected loads – irrespective of their power consumption – against overload and underload, and provides permanent status monitoring.

Up to 8 freely parameterizable switching, message thresholds and up to four freely configurable inputs and outputs enable the protection of electrical drives and the system.

The EMM modules can record the following data:

- Apparent real and reactive power
  - Currents and voltages
  - Phase angle
  - Cycle and operating hours counter
  - Power meter
- Additional functions:
- Adjustable bimetal function class 5-30
  - Thermistor monitor
  - Recording measured values
  - GATEWAY connection via TBUS
  - Pre-configured motor exits such as reversing starters, star-delta starters, etc.

The EMM modules can be used to record complete curves that can be used for system documentation.

Actuating and regulating drives, pumps, tools, conveyer belts or similar are switched and monitored for function, contamination or wear in the following operating modes: right rotation, left rotation, reverse, and limit switch operation (with integrated restart inhibit).

**Current transformer**

The external converters should be selected with a secondary nominal current of 5 A. The primary current is determined by the current consumption of the load (refer to connection diagram). For suitable current transformers, see INTERFACE catalog.

**TBUS DIN rail connector**

The **TBUS** (Order No. 2707437) can be used to supply several EMMs with 24 V DC or to couple up to 32 EMMs (for example) to the PROFIBUS-GATEWAY-IFS.

**Switching element**

Depending on the particular requirements of the application, either an electro-mechanical contactor or reversing contactor combination, or a solid-state contactor or a solid-state reversing contactor is to be used for the actual task of switching the load. These switching elements are controlled via the digital outputs of the EMM modules.

## Motor management

### IFS gateways for INTERFACE system devices

EM...GATEWAY-IFS for connecting INTERFACE system devices (IFS) to popular bus systems: PROFIBUS DP, Modbus, Modbus/TCP, DeviceNet™, CANopen®, and PROFINET, EtherNet/IP™.

- Communication via TBUS with up to 32 INTERFACE system devices such as EMM...IFS and ELR...IFS modules
- Equipped with freely parameterizable digital inputs and outputs
- Digital switching outputs for direct control

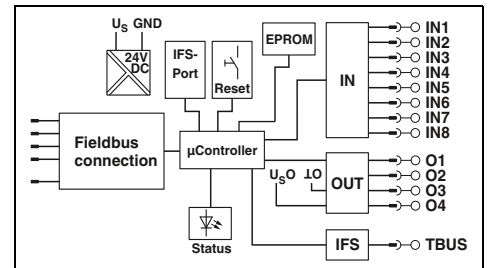

<b>Input data</b>	
Rated control supply voltage $U_S$	24 V DC -20 % ... +25 %
Rated control supply current $I_S$	85 mA (plus load current of the outputs)
Input circuit	Protection against polarity reversal
<b>Digital inputs</b>	
Rated actuating voltage $U_C$	24 V DC $\pm$ 20 %
Rated actuating current $I_C$	3 mA
Input circuit	Protection against polarity reversal
<b>Digital outputs</b>	
Maximum switching voltage	23 V DC ( $U_B - U_{resid.}$ of the output)
Max. switching current	500 mA
Residual voltage	1 V
Output protection	Parallel protection against polarity reversal, pay attention to the fuse
<b>IFS interface</b>	
Connection method	DIN rail connector
<b>General data</b>	
Ambient temperature (operation)	-35 °C ... 50 °C
Nominal operating mode	100% operating factor
Standards/regulations	EN 50178
Degree of protection	IP20
Mounting position / mounting	any / can be aligned without spacing
Connection data solid / stranded / AWG	0.2 ... 2 mm <sup>2</sup> / 0.2 ... 2.5 mm <sup>2</sup> / 12 - 24
Dimensions	22.5 mm / 99 mm / 114.5 mm
EMC note	Class A product, see page 625

#### Technical data

Rated control supply voltage $U_S$	24 V DC -20 % ... +25 %
Rated control supply current $I_S$	85 mA (plus load current of the outputs)
Input circuit	Protection against polarity reversal
Rated actuating voltage $U_C$	24 V DC $\pm$ 20 %
Rated actuating current $I_C$	3 mA
Input circuit	Protection against polarity reversal
Maximum switching voltage	23 V DC ( $U_B - U_{resid.}$ of the output)
Max. switching current	500 mA
Residual voltage	1 V
Output protection	Parallel protection against polarity reversal, pay attention to the fuse
Connection method	DIN rail connector
Ambient temperature (operation)	-35 °C ... 50 °C
Nominal operating mode	100% operating factor
Standards/regulations	EN 50178
Degree of protection	IP20
Mounting position / mounting	any / can be aligned without spacing
Connection data solid / stranded / AWG	0.2 ... 2 mm <sup>2</sup> / 0.2 ... 2.5 mm <sup>2</sup> / 12 - 24
Dimensions	22.5 mm / 99 mm / 114.5 mm
EMC note	Class A product, see page 625

<b>Description</b>
IFS gateway for PROFIBUS DP
RS-232
RS-485
Modbus/TCP
DeviceNet™
CANopen®
PROFINET
EtherNet/IP™

#### Ordering data

Type	Order No.	Pcs. / Pkt.
EM-PB-GATEWAY-IFS	2297620	1
EM-RS232-GATEWAY-IFS	2901526	1
EM-RS485-GATEWAY-IFS	2901527	1
EM-MODBUS-GATEWAY-IFS	2901528	1
EM-DNET-GATEWAY-IFS	2901529	1
EM-CAN-GATEWAY-IFS	2901504	1
EM-PNET-GATEWAY-IFS	2904472	1
EM-ETH-GATEWAY-IFS	2901988	1

<b>Programming adapter</b> for configuring modules with S-PORT interface
<b>DIN rail connector</b>
<b>Mini COMBICON connector</b>
- Socket contact
- Pin contact

#### Accessories

Type	Order No.	Pcs. / Pkt.
IFS-USB-PROG-ADAPTER	2811271	1
ME 22,5 TBUS 1,5/ 5-ST-3,81 GN	2707437	50
MC 1,5/ 5-ST-3,81	1803604	50
IMC 1,5/ 5-ST-3,81	1857919	50

**Device Type Manager (DTM) for motor management modules**

**EMM...IFS**

- CONTACTRON-DTM-IFS, programming adapter, and user manual on CD available as configuration package
- USB programming adapter also available separately as an option
- CONTACTRON-DTM-IFS also available free of charge as a separate download from phoenixcontact.com



Ordering data		
Type	Order No.	Pcs. / Pkt.
MM-CONF-SET	2297992	1
Accessories		
IFS-USB-PROG-ADAPTER	2811271	1

Description
<b>Configuration package</b> for the EMM...IFS, comprising CONTACTRON-DTM-IFS, USB programming adapter, and user manual on CD
<b>Programming adapter</b> for configuring modules with S-PORT interface





Hybrid motor starters for controlling 3-phase asynchronous motors combine up to four functions in one device as required. These include forward running, reverse running with optional reversing function including load wiring. The locking circuit for the reversing function is also integrated and certified as a single electronic reversing starter according to UL 508a and the new UL 60947-1. Furthermore, the devices protect the motor by means of an integrated motor protection relay with automatic and remote reset function. The implemented safety function according to Performance Level e (PL e) of EN ISO 13849-1 provides the emergency stop requirement. A PDT confirmation contact provides information regarding the availability of the device, and the motor state. This means that in the event of motor control without an error message the integrated current measurement and symmetry scanning ensures that the motor is turning. Even with these numerous functions, the hybrid motor starter is just 22.5 mm wide.

Short-circuit-proof hybrid motor starters with integrated protective devices, for mounting on 35 mm DIN rails and 60 mm busbar systems and connection to popular bus systems via SmartWire-DT™ complete the product portfolio.



Hybrid motor starters with up to four functions in one device: forward running, reverse running, motor protection, and emergency stop.



Short-circuit-proof hybrid motor starters with integrated fuses for mounting on 35 mm DIN rails and 60 mm busbar systems.



Connection of hybrid motor starters in a bus system via SmartWire-DT™. Gateways are provided for the main bus systems: PROFIBUS, Modbus/TCP, EtherNet/IP™, and CANopen®.



Connection of the hybrid motor starter to a bus system via the IFS INTERFACE system.

Gateways are provided for the main bus systems: PROFIBUS DP, Modbus/TCP, EtherNet/IP™, CANopen®, DeviceNet™, PROFINET, etc.

## Hybrid motor starters

### Network-capable hybrid motor starters with reversing function

These 3-phase hybrid motor starters provide up to four functions: right contactor, left contactor, motor protection relay, and emergency stop up to category 3.

They offer the following advantages:

- Connection to INTERFACE system (IFS) via TBUS
  - Connection to SmartWire-DT™ (SWD)
  - 22.5 mm wide
  - Reduction in wiring
  - Bi-metal function, adjustable up to 3 A
  - Long service life
  - Space-saving
  - 3-phase loop bridging
- Safety level according to:
- IEC 61508-1: SIL3
  - ISO 13849: PL e

Notes:
Type of housing: Polyamide PA non-reinforced, color: green.
Marking systems and mounting material See Catalog 5



new

Motor protection and SmartWire-DT™ support

Input data	
Rated control supply voltage $U_s$	24 V DC
Rated control supply voltage range with reference to $U_s$	0.8 ... 1.25
Rated control supply current $I_s$ at $U_s$	40 mA
Rated actuating voltage UC EN+	-
Rated actuating voltage range with reference to $U_c$	-
Rated actuating current $I_c$ at $U_c$	-
Input circuit	Protection against polarity reversal, surge protection
Operating voltage / status / error indicator	Green LED / Yellow LED / Red LED
Output data load side	
Output voltage range	42 V AC ... 550 V AC
Surge current	100 A (t = 10 ms)
Output protection	Surge protection
General data	
Rated insulation voltage	550 V
Rated surge voltage	6 kV (safe isolation)
Ambient temperature (operation)	-5 °C ... 55 °C
Electrical service life	3 x 10 <sup>7</sup> cycles
Standards/regulations	IEC 60947-1 / EN 60947-4-2 IEC 60947-1
Mounting position	Vertical (horizontal DIN rail)
Mounting	can be aligned with spacing: see derating
Screw connection solid / stranded / AWG	0.14 - 2.5 mm <sup>2</sup> / 0.14 - 2.5 mm <sup>2</sup> / 26 - 14
Dimensions	W / H / D 22.5 mm / 99 mm / 114.5 mm

### Technical data

Rated control supply voltage $U_s$	24 V DC
Rated control supply voltage range with reference to $U_s$	0.8 ... 1.25
Rated control supply current $I_s$ at $U_s$	40 mA
Rated actuating voltage UC EN+	-
Rated actuating voltage range with reference to $U_c$	-
Rated actuating current $I_c$ at $U_c$	-
Input circuit	Protection against polarity reversal, surge protection
Operating voltage / status / error indicator	Green LED / Yellow LED / Red LED
Output data load side	
Output voltage range	42 V AC ... 550 V AC
Surge current	100 A (t = 10 ms)
Output protection	Surge protection
General data	
Rated insulation voltage	550 V
Rated surge voltage	6 kV (safe isolation)
Ambient temperature (operation)	-5 °C ... 55 °C
Electrical service life	3 x 10 <sup>7</sup> cycles
Standards/regulations	IEC 60947-1 / EN 60947-4-2 IEC 60947-1
Mounting position	Vertical (horizontal DIN rail)
Mounting	can be aligned with spacing: see derating
Screw connection solid / stranded / AWG	0.14 - 2.5 mm <sup>2</sup> / 0.14 - 2.5 mm <sup>2</sup> / 26 - 14
Dimensions	W / H / D 22.5 mm / 99 mm / 114.5 mm

Description
<b>Load current 0.075 - 0.6 A</b> Screw connection Push-in connection
<b>Load current 0.18 A ... 3 A</b> Screw connection Push-in connection

### Ordering data

Type	Order No.	Pcs. / Pkt.
ELR H5-I-PT-SWD/500AC-06	2905073	1
ELR H5-I-PT-SWD/500AC-3	2905074	1

<b>Device plug, 8-pos.</b>
<b>DIN rail connector</b>

### Accessories

SWD4-8SF2-5 PXC	2903107	10
-----------------	---------	----



new



Motor protection, emergency stop, and INTERFACE system support



new



Motor protection and INTERFACE system support

Technical data
24 V DC 0.8 ... 1.25
40 mA 24 V DC 0.8 ... 1.25
5 mA Protection against polarity reversal, surge protection Green LED / Yellow LED / Red LED
42 V AC ... 550 V AC 100 A (t = 10 ms) Surge protection
550 V 6 kV (safe isolation) -5 °C ... 60 °C 3 x 10 <sup>7</sup> cycles IEC 60947-1 / EN 60947-4-2 / IEC 61508 / ISO 13849 IEC 60947-1 Vertical (horizontal DIN rail) can be aligned with spacing: see derating 0.14 - 2.5 mm <sup>2</sup> / 0.14 - 2.5 mm <sup>2</sup> / 26 - 14 22.5 mm / 99 mm / 114.5 mm

Technical data
24 V DC 0.8 ... 1.25
40 mA - -
- Protection against polarity reversal, surge protection Green LED / Yellow LED / Red LED
42 V AC ... 550 V AC 100 A (t = 10 ms) Surge protection
550 V 6 kV (safe isolation) -5 °C ... 60 °C 3 x 10 <sup>7</sup> cycles IEC 60947-1 / EN 60947-4-2 IEC 60947-1 Vertical (horizontal DIN rail) can be aligned with spacing: see derating 0.14 - 2.5 mm <sup>2</sup> / 0.14 - 2.5 mm <sup>2</sup> / 26 - 14 22.5 mm / 99 mm / 114.5 mm

Ordering data		
Type	Order No.	Pcs. / Pkt.
ELR H5-IES-SC/500AC-06-IFS	2905151	1
ELR H5-IES-PT/500AC-06-IFS	2905138	1
ELR H5-IES-SC/500AC-3-IFS	2905152	1
ELR H5-IES-PT/500AC-3-IFS	2905139	1

Ordering data		
Type	Order No.	Pcs. / Pkt.
ELR H5-I-SC/500AC-06-IFS	2905157	1
ELR H5-I-PT/500AC-06-IFS	2905144	1
ELR H5-I-SC/500AC-3-IFS	2905159	1
ELR H5-I-PT/500AC-3-IFS	2905146	1

Accessories		
ME 22,5 TBUS 1,5/ 5-ST-3,81 GN	2707437	50

Accessories		
ME 22,5 TBUS 1,5/ 5-ST-3,81 GN	2707437	50

## Hybrid motor starters

### Hybrid motor starters with reversing function

These 3-phase hybrid motor starters provide up to four functions: right contactor, left contactor, motor protection relay, and emergency stop up to category 3.

They offer the following advantages:

- 22.5 mm wide
- Reduction in wiring
- Bi-metal function, adjustable up to 9 A
- Long service life
- Space-saving
- 3-phase loop bridging
- Safety level according to:
  - IEC 61508-1: SIL3
  - ISO 13849: PL e

Notes:
Type of housing: Polyamide PA non-reinforced, color: green.
Marking systems and mounting material See Catalog 5

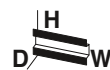

Motor protection and emergency stop



Input data		
Rated control supply voltage $U_S$	24 V DC	230 V AC (50/60 Hz)
Rated control supply voltage range with reference to $U_S$	0.8 ... 1.25	0.4 ... 1.1
Rated control supply current $I_S$ at $U_S$	40 mA	4 mA
Rated actuating voltage $U_C$ R/L	24 V DC	230 V AC
Rated actuating voltage range with reference to $U_C$	0.8 ... 1.25	0.4 ... 1.1
Rated actuating current $I_C$ at $U_C$	5 mA	7 mA
Input circuit	Protection against polarity reversal, surge protection	Surge protection
Operating voltage / status / error indicator	Green LED / Yellow LED / Red LED	
Output data load side		
Output voltage range	42 V AC ... 550 V AC	42 V AC ... 550 V AC
Surge current	100 A (t = 10 ms)	100 A (t = 10 ms)
Output protection	Surge protection	
General data		
Rated insulation voltage	500 V	
Rated surge voltage	6 kV (safe isolation)	6 kV (safe isolation)
Ambient temperature (operation)	-25 °C ... 70 °C	
Electrical service life	3 x 10 <sup>7</sup> cycles	
Standards/regulations	EN 60947 / IEC 61508 / ISO 13849 DIN EN 50178	
Mounting position	Vertical (horizontal DIN rail)	
Mounting	can be aligned with spacing: see derating	
Screw connection solid / stranded / AWG	0.14 - 2.5 mm <sup>2</sup> / 0.14 - 2.5 mm <sup>2</sup> / 26 - 14	
Dimensions	22.5 mm / 99 mm / 114.5 mm	

Technical data		
Rated control supply voltage $U_S$	24 V DC	230 V AC (50/60 Hz)
Rated control supply voltage range with reference to $U_S$	0.8 ... 1.25	0.4 ... 1.1
Rated control supply current $I_S$ at $U_S$	40 mA	4 mA
Rated actuating voltage $U_C$ R/L	24 V DC	230 V AC
Rated actuating voltage range with reference to $U_C$	0.8 ... 1.25	0.4 ... 1.1
Rated actuating current $I_C$ at $U_C$	5 mA	7 mA
Input circuit	Protection against polarity reversal, surge protection	Surge protection
Operating voltage / status / error indicator	Green LED / Yellow LED / Red LED	
Output data load side	42 V AC ... 550 V AC	42 V AC ... 550 V AC
Surge current	100 A (t = 10 ms)	100 A (t = 10 ms)
Output protection	Surge protection	
General data	500 V	
Rated insulation voltage	6 kV (safe isolation)	6 kV (safe isolation)
Rated surge voltage	-25 °C ... 70 °C	
Ambient temperature (operation)	3 x 10 <sup>7</sup> cycles	
Electrical service life	EN 60947 / IEC 61508 / ISO 13849 DIN EN 50178	
Standards/regulations	Vertical (horizontal DIN rail)	
Mounting position	can be aligned with spacing: see derating	
Mounting	0.14 - 2.5 mm <sup>2</sup> / 0.14 - 2.5 mm <sup>2</sup> / 26 - 14	
Screw connection solid / stranded / AWG	22.5 mm / 99 mm / 114.5 mm	

Description
<b>Load current 0.075 - 0.6 A</b>
Screw connection
Push-in connection
Screw connection
<b>Load current 0.18 A ... 2.4 A</b>
Screw connection
Push-in connection
Screw connection
<b>Load current 1.5 - 9 A</b>
Screw connection
Push-in connection
Screw connection
<b>Load current 0 - 9 A</b>
Screw connection
Screw connection

Ordering data		
Type	Order No.	Pcs. / Pkt.
ELR H5-IES-SC- 24DC/500AC-0,6	2900582	1
ELR H5-IES-PT- 24DC/500AC-0,6	2903902	1
ELR H5-IES-SC-230AC/500AC-0,6	2900692	1
ELR H5-IES-SC- 24DC/500AC-2	2900414	1
ELR H5-IES-PT- 24DC/500AC-2	2903904	1
ELR H5-IES-SC-230AC/500AC-2	2900420	1
ELR H5-IES-SC- 24DC/500AC-9	2900421	1
ELR H5-IES-PT- 24DC/500AC-9	2903906	1
ELR H5-IES-SC-230AC/500AC-9	2900422	1

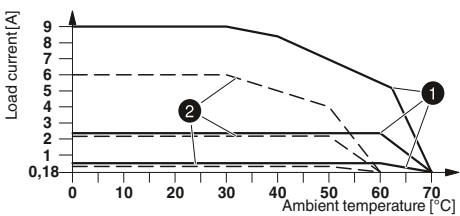
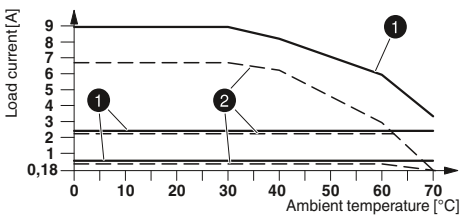





Motor protection



Reversing function only



Technical data	
24 V DC 0.8 ... 1.25	230 V AC (50/60 Hz) 0.4 ... 1.1
40 mA 24 V DC 0.8 ... 1.25	4 mA 230 V AC 0.4 ... 1.1
5 mA Protection against polarity reversal, surge protection	7 mA Surge protection
Green LED / Yellow LED / Red LED	
42 V AC ... 550 V AC 100 A (t = 10 ms)	42 V AC ... 550 V AC 100 A (t = 10 ms)
Surge protection	
500 V 6 kV (safe isolation) -25 °C ... 70 °C 3 x 10 <sup>7</sup> cycles EN 60947 DIN EN 50178 Vertical (horizontal DIN rail) can be aligned with spacing: see derating 0.14 - 2.5 mm <sup>2</sup> / 0.14 - 2.5 mm <sup>2</sup> / 26 - 14 22.5 mm / 99 mm / 114.5 mm	

Technical data	
24 V DC 0.8 ... 1.25	230 V AC (50/60 Hz) 0.4 ... 1.1
40 mA 24 V DC 0.8 ... 1.25	4 mA 230 V AC 0.4 ... 1.1
5 mA Protection against polarity reversal, surge protection	7 mA Surge protection
Green LED / Yellow LED / Red LED	
42 V AC ... 550 V AC 100 A (t = 10 ms)	42 V AC ... 550 V AC 100 A (t = 10 ms)
Surge protection	
500 V 6 kV (safe isolation) -25 °C ... 70 °C 3 x 10 <sup>7</sup> cycles EN 60947 DIN EN 50178 Vertical (horizontal DIN rail) can be aligned with spacing: see derating 0.14 - 2.5 mm <sup>2</sup> / 0.14 - 2.5 mm <sup>2</sup> / 26 - 14 22.5 mm / 99 mm / 114.5 mm	

Ordering data		
Type	Order No.	Pcs. / Pkt.
ELR H5-I-SC- 24DC/500AC-0,6	2900573	1
ELR H5-I-PT- 24DC/500AC-0,6	2903908	1
ELR H5-I-SC-230AC/500AC-0,6	2900691	1
ELR H5-I-SC- 24DC/500AC-2	2900574	1
ELR H5-I-PT- 24DC/500AC-2	2903910	1
ELR H5-I-SC-230AC/500AC-2	2900575	1
ELR H5-I-SC- 24DC/500AC-9	2900576	1
ELR H5-I-PT- 24DC/500AC-9	2903912	1
ELR H5-I-SC-230AC/500AC-9	2900578	1
		1

Ordering data		
Type	Order No.	Pcs. / Pkt.
ELR H5-SC- 24DC/500AC-9	2900538	1
ELR H5-SC-230AC/500AC-9	2900539	1

## Hybrid motor starters

### Network-capable hybrid motor starters with direct start function

These 3-phase hybrid motor starters provide up to three functions: right contactor, motor protection relay, and emergency stop up to category 3.

They offer the following advantages:

- Connection to INTERFACE system (IFS) via TBUS
  - Connection to SmartWire-DT™ (SWD)
  - 22.5 mm wide
  - Reduction in wiring
  - Bi-metal function, adjustable up to 3 A
  - Long service life
  - Space-saving
  - 3-phase loop bridging
- Safety level according to:
- IEC 61508-1: SIL3
  - ISO 13849: PL e

Notes:
Type of housing: Polyamide PA non-reinforced, color: green.
Marking systems and mounting material See Catalog 5



new

Motor protection and SmartWire-DT™ support

Input data
Rated control supply voltage $U_s$
Rated control supply voltage range with reference to $U_s$
Rated control supply current $I_s$ at $U_s$
Rated actuating voltage UC EN+
Rated actuating voltage range with reference to $U_c$
Rated actuating current $I_c$ at $U_c$
Input circuit
Operating voltage / status / error indicator
Output data load side
Output voltage range
Surge current
Output protection
General data
Rated insulation voltage
Rated surge voltage
Ambient temperature (operation)
Electrical service life
Standards/regulations
Mounting position
Mounting
Screw connection solid / stranded / AWG
Dimensions

Technical data
24 V DC (according to IEC 60947-1)
0.8 ... 1.25
40 mA
-
-
Protection against polarity reversal, surge protection
Green LED / Yellow LED / Red LED
42 V AC ... 550 V AC
100 A (t = 10 ms)
Surge protection
550 V
6 kV (safe isolation)
-5 °C ... 55 °C
3 x 10 <sup>7</sup> cycles
IEC 60947-1 / EN 60947-4-2
IEC 60947-1
Vertical (horizontal DIN rail)
can be aligned with spacing: see derating
0.14 - 2.5 mm <sup>2</sup> / 0.14 - 2.5 mm <sup>2</sup> / 26 - 14
22.5 mm / 99 mm / 114.5 mm

Description
<b>Load current 0.075 - 0.6 A</b>
Screw connection
Push-in connection
<b>Load current 0.18 A ... 3 A</b>
Screw connection
Push-in connection
<b>Device plug, 8-pos.</b>
<b>DIN rail connector</b>

Ordering data		
Type	Order No.	Pcs. / Pkt.
ELR H3-I-PT-SWD/500AC-06	2905076	1
ELR H3-I-PT-SWD/500AC-3	2905078	1
Accessories		
SWD4-8SF2-5 PXC	2903107	10



new



Motor protection, emergency stop, and INTERFACE system support



new



Motor protection and INTERFACE system support

Technical data
24 V DC 0.8 ... 1.25
40 mA 24 V DC 0.8 ... 1.25
5 mA Protection against polarity reversal, surge protection Green LED / Yellow LED / Red LED
42 V AC ... 550 V AC 100 A (t = 10 ms) Surge protection
550 V 6 kV (safe isolation) -5 °C ... 60 °C 3 x 10 <sup>7</sup> cycles IEC 60947-1 / EN 60947-4-2 / IEC 61508 / ISO 13849 IEC 60947-1 Vertical (horizontal DIN rail) can be aligned with spacing: see derating 0.14 - 2.5 mm <sup>2</sup> / 0.14 - 2.5 mm <sup>2</sup> / 26 - 14 22.5 mm / 99 mm / 114.5 mm

Technical data
24 V DC 0.8 ... 1.25
40 mA - -
- Protection against polarity reversal, surge protection Green LED / Yellow LED / Red LED
42 V AC ... 550 V AC 100 A (t = 10 ms) Surge protection
550 V 6 kV (safe isolation) -5 °C ... 60 °C 3 x 10 <sup>7</sup> cycles IEC 60947-1 / EN 60947-4-2 IEC 60947-1 Vertical (horizontal DIN rail) can be aligned with spacing: see derating 0.14 - 2.5 mm <sup>2</sup> / 0.14 - 2.5 mm <sup>2</sup> / 26 - 14 22.5 mm / 99 mm / 114.5 mm

Ordering data		
Type	Order No.	Pcs. / Pkt.
ELR H3-IES-SC/500AC-06-IFS	2905154	1
ELR H3-IES-PT/500AC-06-IFS	2905141	1
ELR H3-IES-SC/500AC-3-IFS	2905155	1
ELR H3-IES-PT/500AC-3-IFS	2905142	1

Ordering data		
Type	Order No.	Pcs. / Pkt.
ELR H3-I-SC/500AC-06-IFS	2905162	1
ELR H3-I-PT/500AC-06-IFS	2905148	1
ELR H3-I-SC/500AC-3-IFS	2905163	1
ELR H3-I-PT/500AC-3-IFS	2905149	1

Accessories		
ME 22,5 TBUS 1,5/ 5-ST-3,81 GN	2707437	50

Accessories		
ME 22,5 TBUS 1,5/ 5-ST-3,81 GN	2707437	50

## Hybrid motor starters

### Hybrid motor starters with direct start function

These 3-phase hybrid motor starters provide up to three functions: right contactor, motor protection relay, and emergency stop up to category 3.

They offer the following advantages:

- 22.5 mm wide
- Reduction in wiring
- Bi-metal function, adjustable up to 9 A
- Long service life
- Space-saving
- 3-phase loop bridging
- Safety level according to:
  - IEC 61508-1: SIL3
  - ISO 13849: PL e

Notes:
Type of housing: Polyamide PA non-reinforced, color: green.
Marking systems and mounting material See Catalog 5



### Motor protection and emergency stop



Input data	
Rated control supply voltage $U_S$	24 V DC
Rated control supply voltage range with reference to $U_S$	0.8 ... 1.25
Rated control supply current $I_S$ at $U_S$	40 mA
Rated actuation voltage $U_C$ ON	24 V DC
Rated actuating voltage range with reference to $U_C$	0.8 ... 1.25
Rated actuating current $I_C$ at $U_C$	5 mA
Input circuit	Protection against polarity reversal, surge protection
Operating voltage / status / error indicator	Green LED / Yellow LED / Red LED
Output data load side	
Output voltage range	42 V AC ... 550 V AC
Surge current	100 A (t = 10 ms)
Output protection	Surge protection
General data	
Rated insulation voltage	500 V
Rated surge voltage	6 kV (safe isolation)
Ambient temperature (operation)	-25 °C ... 70 °C
Electrical service life	$3 \times 10^7$ cycles
Standards/regulations	IEC 60947-1 / EN 60947-4-2 / IEC 61508 / ISO 13849 DIN EN 50178
Mounting position	Vertical (horizontal DIN rail)
Mounting	can be aligned with spacing: see derating
Screw connection solid / stranded / AWG	0.14 - 2.5 mm <sup>2</sup> / 0.14 - 2.5 mm <sup>2</sup> / 26 - 14
Dimensions	22.5 mm / 99 mm / 114.5 mm

Technical data	
Rated control supply voltage $U_S$	24 V DC
Rated control supply voltage range with reference to $U_S$	0.8 ... 1.25
Rated control supply current $I_S$ at $U_S$	40 mA
Rated actuation voltage $U_C$ ON	24 V DC
Rated actuating voltage range with reference to $U_C$	0.8 ... 1.25
Rated actuating current $I_C$ at $U_C$	5 mA
Input circuit	Protection against polarity reversal, surge protection
Operating voltage / status / error indicator	Green LED / Yellow LED / Red LED
Output voltage range	42 V AC ... 550 V AC
Surge current	100 A (t = 10 ms)
Output protection	Surge protection
Rated insulation voltage	500 V
Rated surge voltage	6 kV (safe isolation)
Ambient temperature (operation)	-25 °C ... 70 °C
Electrical service life	$3 \times 10^7$ cycles
Standards/regulations	IEC 60947-1 / EN 60947-4-2 / IEC 61508 / ISO 13849 DIN EN 50178
Mounting position	Vertical (horizontal DIN rail)
Mounting	can be aligned with spacing: see derating
Screw connection solid / stranded / AWG	0.14 - 2.5 mm <sup>2</sup> / 0.14 - 2.5 mm <sup>2</sup> / 26 - 14
Dimensions	22.5 mm / 99 mm / 114.5 mm

Description
<b>Load current 0.075 - 0.6 A</b>
Screw connection
Push-in connection
Screw connection
<b>Load current 0.18 A ... 2.4 A</b>
Screw connection
Push-in connection
Screw connection
<b>Load current 1.5 - 9 A</b>
Screw connection
Push-in connection
Screw connection
<b>Load current 0 - 9 A</b>
Screw connection
Screw connection

Ordering data		
Type	Order No.	Pcs. / Pkt.
ELR H3-IES-SC- 24DC/500AC-0,6	2900566	1
ELR H3-IES-PT- 24DC/500AC-0,6	2903914	1
ELR H3-IES-SC-230AC/500AC-0,6	2900689	1
ELR H3-IES-SC- 24DC/500AC-2	2900567	1
ELR H3-IES-PT- 24DC/500AC-2	2903916	1
ELR H3-IES-SC-230AC/500AC-2	2900568	1
ELR H3-IES-SC- 24DC/500AC-9	2900569	1
ELR H3-IES-PT- 24DC/500AC-9	2903918	1
ELR H3-IES-SC-230AC/500AC-9	2900570	1

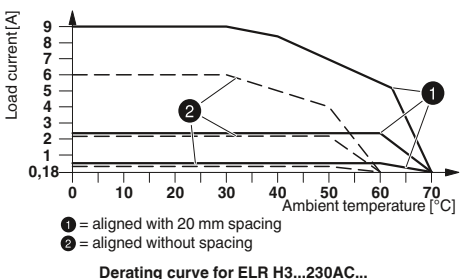
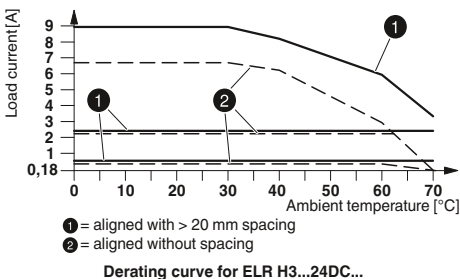



Motor protection



Direct start function only



Technical data	
24 V DC 0.8 ... 1.25	230 V AC (50/60 Hz) 0.4 ... 1.1
40 mA 24 V DC 0.8 ... 1.25	4 mA 230 V AC 0.4 ... 1.1
5 mA Protection against polarity reversal, surge protection	7 mA Surge protection
Green LED / Yellow LED / Red LED	
42 V AC ... 550 V AC 100 A (t = 10 ms)	42 V AC ... 550 V AC 100 A (t = 10 ms)
Surge protection	
500 V 6 kV (safe isolation) -25 °C ... 70 °C 3 x 10 <sup>7</sup> cycles EN 60947 DIN EN 50178 Vertical (horizontal DIN rail) can be aligned with spacing: see derating 0.14 - 2.5 mm <sup>2</sup> / 0.14 - 2.5 mm <sup>2</sup> / 26 - 14 22.5 mm / 99 mm / 114.5 mm	

Technical data	
24 V DC 0.8 ... 1.25	230 V AC (50/60 Hz) 0.4 ... 1.1
40 mA 24 V DC 0.8 ... 1.25	4 mA 230 V AC 0.4 ... 1.1
5 mA Protection against polarity reversal, surge protection	7 mA Surge protection
Green LED / Yellow LED / Red LED	
42 V AC ... 550 V AC 100 A (t = 10 ms)	42 V AC ... 550 V AC 100 A (t = 10 ms)
Surge protection	
500 V 6 kV (safe isolation) -25 °C ... 70 °C 3 x 10 <sup>7</sup> cycles EN 60947 DIN EN 50178 Vertical (horizontal DIN rail) can be aligned with spacing: see derating 0.14 - 2.5 mm <sup>2</sup> / 0.14 - 2.5 mm <sup>2</sup> / 26 - 14 22.5 mm / 99 mm / 114.5 mm	

Ordering data		
Type	Order No.	Pcs. / Pkt.
ELR H3-I-SC- 24DC/500AC-0,6	2900542	1
ELR H3-I-PT- 24DC/500AC-0,6	2903920	1
ELR H3-I-SC-230AC/500AC-0,6	2900685	1
ELR H3-I-SC- 24DC/500AC-2	2900543	1
ELR H3-I-PT- 24DC/500AC-2	2903922	1
ELR H3-I-SC-230AC/500AC-2	2900544	1
ELR H3-I-SC- 24DC/500AC-9	2900545	1
ELR H3-I-PT- 24DC/500AC-9	2903924	1
ELR H3-I-SC-230AC/500AC-9	2900546	1
		1

Ordering data		
Type	Order No.	Pcs. / Pkt.
ELR H3-SC- 24DC/500AC-9	2900530	1
ELR H3-SC-230AC/500AC-9	2900531	1

## Hybrid motor starters

### Hybrid motor starters with short-circuit protection



These short-circuit-proof 3-phase hybrid motor starters for mounting on 30 mm DIN rails or 60 mm power busbars combine four functions in one device: right contactor, left contactor, motor protection relay, and emergency stop up to category 3.

They offer the following advantages:

- 22.5 mm wide
- Bi-metal function can be set up to 9 A
- Long service life
- Space-saving
- Reduction in wiring
- 3-phase loop bridging
- Plug-in motor output terminal block
- Coordination type 2 according to IEC/EN 60947-4-2

#### Input data

Rated control supply voltage  $U_s$   
Rated control supply voltage range with reference to  $U_s$

Rated control supply current  $I_s$  at  $U_s$   
Rated actuating voltage  $U_c$  R/L  
Rated actuating voltage range with reference to  $U_c$

Rated actuating current  $I_c$  at  $U_c$   
Input circuit  
Operating voltage / status / error indicator

#### Output data load side

Output voltage range  
Load current

Min. load current  
Residual voltage  
Output protection

#### General data

Rated insulation voltage  
Rated surge voltage  
Ambient temperature (operation)  
Electrical service life  
Standards/regulations

Mounting position

Mounting

Screw connection solid / stranded / AWG

Dimensions

W / H / D

#### Description

##### Short-circuit-proof hybrid motor starter

Hybrid motor starter  
DIN rail adapter  
Power rail adapter, 160 mm  
Power rail adapter, 200 mm

**Set** consisting of short-circuit-proof hybrid motor starter and adapter

- with DIN rail adapter
- with power rail adapter, 160 mm
- with power rail adapter, 200 mm

#### Fuse

Coordination type 2 to 10 kA/500 V  
Coordination type 2 to 5 kA/400 V  
Coordination type 1 to 30 kA/500 V





For reversing 3~ AC motors up to 550 V AC/3 x 0.6 A



For reversing 3~ AC motors up to 550 V AC/3 x 2.4 A



For reversing 3~ AC motors up to 550 V AC/3 x 9 A

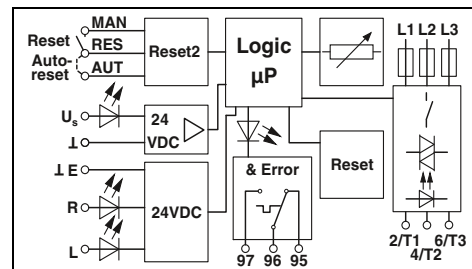
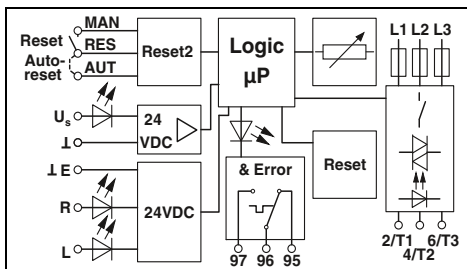
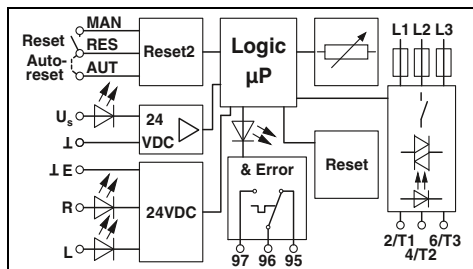

Technical data

Technical data

Technical data

24 V DC  
0.8 ... 1.25

40 mA  
24 V DC  
0.8 ... 1.25

5 mA  
Protection against polarity reversal, surge protection  
Green LED / Yellow LED / Red LED

24 V DC  
0.8 ... 1.25

40 mA  
24 V DC  
0.8 ... 1.25

5 mA  
Protection against polarity reversal, surge protection  
Green LED / Yellow LED / Red LED

24 V DC  
0.8 ... 1.25

40 mA  
24 V DC  
0.8 ... 1.25

5 mA  
Protection against polarity reversal, surge protection  
Green LED / Yellow LED / Red LED

42 V AC ... 550 V AC  
max. 600 mA

75 mA  
< 0.3 V  
Surge protection, short-circuit protection

42 V AC ... 550 V AC  
max. 2.4 A

180 mA  
< 0.4 V  
Surge protection, short-circuit protection

42 V AC ... 550 V AC  
max. 9 A

1.5 A  
< 0.6 V  
Surge protection, short-circuit protection

500 V  
6 kV (safe isolation)  
-25 °C ... 70 °C  
3 x 10<sup>7</sup> cycles  
EN 60947  
DIN EN 50178  
Vertical (horizontal DIN rail)  
Can be aligned with spacing = 20 mm  
0.14 - 2.5 mm<sup>2</sup> / 0.14 - 2.5 mm<sup>2</sup> / 26 - 14  
22.5 mm / 160 mm / 114.5 mm

500 V  
6 kV (safe isolation)  
-25 °C ... 70 °C  
3 x 10<sup>7</sup> cycles  
EN 60947  
DIN EN 50178  
Vertical (horizontal DIN rail)  
Can be aligned with spacing = 20 mm  
0.14 - 2.5 mm<sup>2</sup> / 0.14 - 2.5 mm<sup>2</sup> / 26 - 14  
22.5 mm / 160 mm / 114.5 mm

500 V  
6 kV (safe isolation)  
-25 °C ... 70 °C  
3 x 10<sup>7</sup> cycles  
EN 60947  
DIN EN 50178  
Vertical (horizontal DIN rail)  
Can be aligned with spacing = 20 mm  
0.14 - 2.5 mm<sup>2</sup> / 0.14 - 2.5 mm<sup>2</sup> / 26 - 14  
22.5 mm / 160 mm / 114.5 mm

Ordering data

Ordering data

Ordering data

Type	Order No.	Pcs. / Pkt.
ELR H51-IESSC-24DC500AC-06	2902746	1
EM RD-ADAPTER	2902747	1
EM RI-ADAPTER COMPACT	2902748	1
EM RI-ADAPTER CLASSIC	2902831	1
ELR H51-0.6-DIN-RAIL-SET	2902952	1
ELR-H51-0,6-BUSBAR-COMPACT-SET	2904333	1
ELR-H51-0,6-BUSBAR-CLASSIC-SET	2904334	1

Type	Order No.	Pcs. / Pkt.
ELR H51-IESSC-24DC500AC-2	2902744	1
EM RD-ADAPTER	2902747	1
EM RI-ADAPTER COMPACT	2902748	1
EM RI-ADAPTER CLASSIC	2902831	1
ELR H51-2.4-DIN-RAIL-SET	2902953	1
ELR-H51-2,4-BUSBAR-COMPACT-SET	2904335	1
ELR-H51-2,4-BUSBAR-CLASSIC-SET	2904336	1

Type	Order No.	Pcs. / Pkt.
ELR H51-IESSC-24DC500AC-9	2902745	1
EM RD-ADAPTER	2902747	1
EM RI-ADAPTER COMPACT	2902748	1
EM RI-ADAPTER CLASSIC	2902831	1
ELR H51-9-DIN-RAIL-SET	2902954	1
ELR-H51-9-BUSBAR-COMPACT-SET	2904337	1
ELR-H51-9-BUSBAR-CLASSIC-SET	2904338	1

Accessories

Accessories

Accessories

Type	Order No.	Pcs. / Pkt.
FUSE-10X38-16A-GR	2903126	10
FUSE-10X38-20A-GR	2903384	10
FUSE-10X38-30A-MR	2903119	10

Type	Order No.	Pcs. / Pkt.
FUSE-10X38-16A-GR	2903126	10
FUSE-10X38-20A-GR	2903384	10
FUSE-10X38-30A-MR	2903119	10

Type	Order No.	Pcs. / Pkt.
FUSE-10X38-16A-GR	2903126	10
FUSE-10X38-20A-GR	2903384	10
FUSE-10X38-30A-MR	2903119	10

## Hybrid motor starters

### Loop bridge for hybrid motor starters

The flexible CONTACTRON loop bridge (BRIDGE-...) simplifies the supply and looping through of phases L1, L2, and L3. It is available in 2 to 10-way versions for modules in the CONTACTRON family with 22.5 mm housing width.

Features of the 3-phase loop bridge:

- Saves considerable wiring
- Suitable for CONTACTRON series
  - ELR H3...
  - ELR H5...
  - ELR (W)3...
  - EMM...IFS
- Bridging of 2 to 10 devices with maximum module spacing of 22.5 mm
- Up to 575 V AC/3 x 25 A
- Additional bridge versions available on request

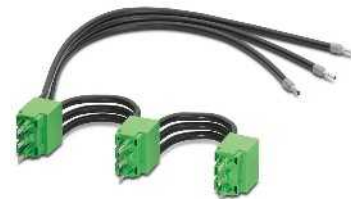

0.3 m connecting cable for hybrid motor starter with screw connection

ERC

General data	
Nominal voltage $U_N$	42 V AC ... 575 V AC
Nominal current at $U_N$	≤ 25 A
Cross section	2.5 mm <sup>2</sup>

Technical data	
Nominal voltage $U_N$	42 V AC ... 575 V AC
Nominal current at $U_N$	≤ 25 A
Cross section	2.5 mm <sup>2</sup>

Description	
<b>3-phase loop bridge</b>	
2-way	
3-way	
4-way	
5-way	
6-way	
7-way	
8-way	
9-way	
10-way	

Ordering data		
Type	Order No.	Pcs. / Pkt.
BRIDGE- 2	2900746	1
BRIDGE- 3	2900747	1
BRIDGE- 4	2900748	1
BRIDGE- 5	2900749	1
BRIDGE- 6	2900750	1
BRIDGE- 7	2900751	1
BRIDGE- 8	2900752	1
BRIDGE- 9	2900753	1
BRIDGE-10	2900754	1

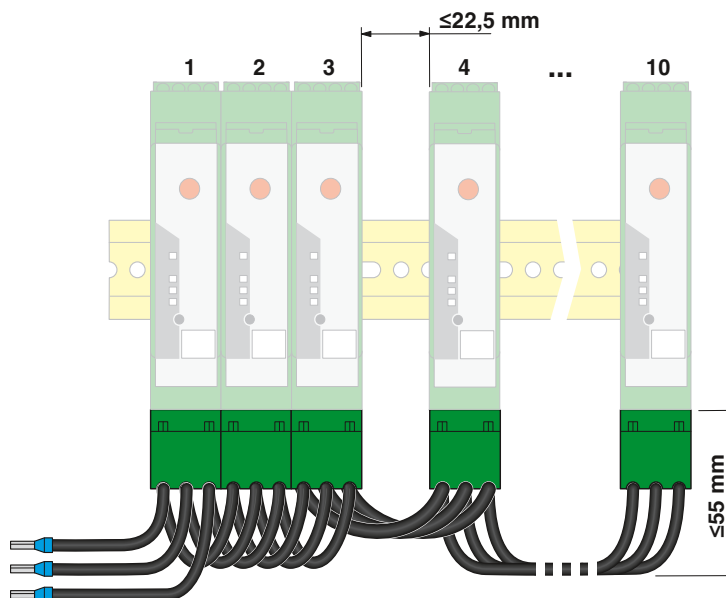

new



3 m connecting cable for hybrid motor starter with screw connection



3 m connecting cable for hybrid motor starter with push-in connection

ERC

ERC

Technical data
42 V AC ... 575 V AC
≤ 25 A
2.5 mm <sup>2</sup>

Technical data
42 V AC ... 575 V AC
≤ 25 A
2.5 mm <sup>2</sup>

Ordering data		
Type	Order No.	Pcs. / Pkt.
BRIDGE- 2-3M	2901543	1
BRIDGE- 3-3M	2901656	1
BRIDGE- 4-3M	2901659	1
BRIDGE- 5-3M	2901545	1
BRIDGE- 6-3M	2901697	1
BRIDGE- 7-3M	2901698	1
BRIDGE- 8-3M	2901700	1
BRIDGE- 9-3M	2901701	1
BRIDGE-10-3M	2901702	1

Ordering data		
Type	Order No.	Pcs. / Pkt.
BRIDGE-PT 2	2904490	1
BRIDGE-PT 3	2904491	1
BRIDGE-PT 4	2904492	1
BRIDGE-PT 5	2904493	1
BRIDGE-PT 6	2904494	1
BRIDGE-PT 7	2904495	1
BRIDGE-PT 8	2904496	1
BRIDGE-PT 9	2904497	1
BRIDGE-PT 10	2904498	1

## Hybrid motor starters

### SmartWire-DT™ accessories

Devices can be integrated seamlessly into the fieldbus world via SmartWire-DT™ with the SmartWire-DT™ “EM SWD-ADAPTER” adapter for CONTACTRON 24 V DC devices. Corresponding gateways are available for the following bus systems:

- PROFIBUS DP
- CANopen®
- Modbus/TCP / EtherNet/IP™



SmartWire-DT™ adapter



Technical data			
<b>Input data</b>			
Supply voltage $U_{AUX}$	-		
Rated current $I_{AUX}$	-		
Supply voltage $U_{POW}$	-		
Rated current $I_{POW}$	-		
<b>Input data</b>			
Description	Enable input		
Input voltage	24 V DC		
Input current	5 mA		
<b>Output data</b>			
Description	-		
Output supply	-		
Output current	-		
<b>SmartWire-DT™ interface</b>			
Connection method	Pin strip, 8-pos.		
Data rate	125 kBd / 250 kBd		
Current consumption $I_{AUX}$	120 mA		
Current consumption $I_{POW}$	25 mA		
<b>General data</b>			
Ambient temperature (operation)	-25 °C ... 55 °C		
Standards/regulations	IEC 60947-1 / EN 60947-1		
Degree of protection in acc. with IEC 60529/EN 60529	IP20		
Mounting position	any		
Mounting	On CONTACTRON hybrid motor starter		
Connection data solid / stranded / AWG	0.14 - 1 mm <sup>2</sup> / 0.14 - 1 mm <sup>2</sup> / 26 - 18		
Dimensions	22.5 mm / 165 mm / 114.5 mm		
	W / H / D		
Ordering data			
Description	Type	Order No.	Pcs. / Pkt.
<b>SmartWire-DT™ adapter</b>	<b>EM SWD-ADAPTER</b>	2902776	1
<b>Gateways</b>			
CANopen®			
PROFIBUS			
Ethernet			
<b>I/O modules</b>			
Digital, 4 inputs, 4 outputs			
Digital, 4 inputs			
Digital, 8 outputs			
Analog, 2 inputs, 2 outputs			
<b>Power feed module</b> for supplying further SmartWire-DT™ devices			



Gateways



Input/output modules



Power feed



Technical data	
24 V DC -15 % ... +20 %	-
3 A	-
24 V DC -15 % ... +20 %	-
700 mA	-
-	-
-	-
-	-
-	-
Pin strip, 8-pos.	Pin strip, 8-pos.
125 kBd / 250 kBd	125 kBd / 250 kBd
-	-
-	-
-25 °C ... 55 °C	-
EN 50178	EN 50178
IP20	IP20
any	any
-	-
0.2 - 1.5 mm <sup>2</sup> / 0.2 - 1.5 mm <sup>2</sup> / 24 - 16	0.2 - 1.5 mm <sup>2</sup> / 0.2 - 1.5 mm <sup>2</sup> / 24 - 16
35 mm / 90 mm / 127 mm	35 mm / 90 mm / 101 mm

Technical data	
-	-
-	-
-	-
-	-
-	-
-	-
Digital inputs	Analog inputs
24 V DC	-
typ. 4 mA	-
-	-
-	-
Digital outputs	Analog outputs
24 V DC -15 % ... +20 %	-
typ. 500 mA	-
-	-
-	-
Pin strip, 8-pos.	Pin strip, 8-pos.
125 kBd / 250 kBd	125 kBd / 250 kBd
-	-
-	-
-	-
-	-
EN 50178	EN 50178
IP20	IP20
any	any
-	-
0.2 - 1.5 mm <sup>2</sup> / 0.2 - 1.5 mm <sup>2</sup> / 24 - 16	0.2 - 1.5 mm <sup>2</sup> / 0.2 - 1.5 mm <sup>2</sup> / 24 - 16
35 mm / 90 mm / 101 mm	

Technical data	
24 V DC -15 % ... +20 %	-
3 A	-
24 V DC -15 % ... +20 %	-
700 mA	-
-	-
-	-
-	-
-	-
Pin strip, 8-pos.	Pin strip, 8-pos.
125 kBd / 250 kBd	125 kBd / 250 kBd
-	-
-	-
-	-
EN 50178	EN 50178
IP20	IP20
any	any
-	-
0.2 - 1.5 mm <sup>2</sup> / 0.2 - 1.5 mm <sup>2</sup> / 24 - 16	0.2 - 1.5 mm <sup>2</sup> / 0.2 - 1.5 mm <sup>2</sup> / 24 - 16
35 mm / 90 mm / 124 mm	

Ordering data		
Type	Order No.	Pcs. / Pkt.
EU5C-SWD-CAN PXC	2903098	1
EU5C-SWD-DP PXC	2903100	1
EU5C-SWD-EIP-MODTCP PXC	2903244	1

Ordering data		
Type	Order No.	Pcs. / Pkt.
EU5E-SWD-4D4D PXC	2903101	1
EU5E-SWD-4DX PXC	2903102	1
EU5E-SWD-X8D PXC	2903103	1
EU5E-SWD-2A2A PXC	2903104	1

Ordering data		
Type	Order No.	Pcs. / Pkt.
EU5C-SWD-PF2-1 PXC	2903113	1

## Hybrid motor starters

### SmartWire-DT™ accessories



Plug tools



Flat-ribbon cable, 8-pos.

Description	Color	Ordering data			Ordering data		
		Type	Order No.	Pcs. / Pkt.	Type	Order No.	Pcs. / Pkt.
Pliers for device plugs		SWD4-CRP-1 PXC	2903110	1			
Pliers for flat plugs		SWD4-CRP-2 PXC	2903114	1			
Flat-ribbon cable, 8-pos., 100 m					SWD4-100LF-8-24 PXC	2903111	1
Flat-ribbon cable, assembled with 2 flat plugs, 8-pos., 3 m					SWD4-3LF8-24-2S PXC	2903112	1

### SmartWire-DT™ accessories

Accessories for SmartWire-DT™ and SmartWire-DT™ devices for connecting digital and analog input and output signals.



Plug and coupling



Programming adapter

Description	Color	Ordering data			Ordering data		
		Type	Order No.	Pcs. / Pkt.	Type	Order No.	Pcs. / Pkt.
<b>Plug and coupling</b>							
Network dummy plug		SWD4-RC8-10 PXC	2903106	1			
Device plug, 8-pos.		SWD4-8SF2-5 PXC	2903107	10			
Flat plug, 8-pos.		SWD4-8MF2 PXC	2903108	10			
Coupling for 8-pos. flat plug		SWD4-8SFF2-5 PXC	2903109	1			
<b>Programming adapter</b>					EU4A-RJ45-USB-CAB1 PXC	2903465	1



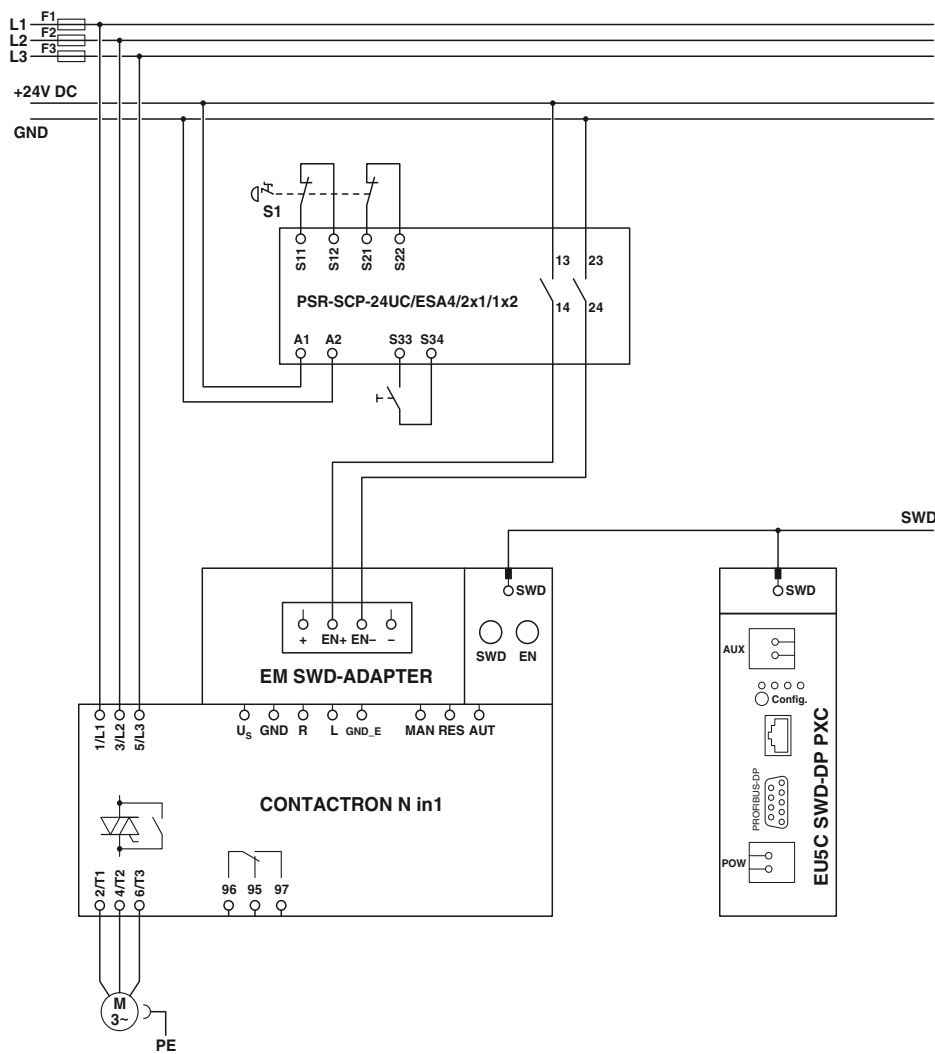

Emergency stop wiring example (two-channel)

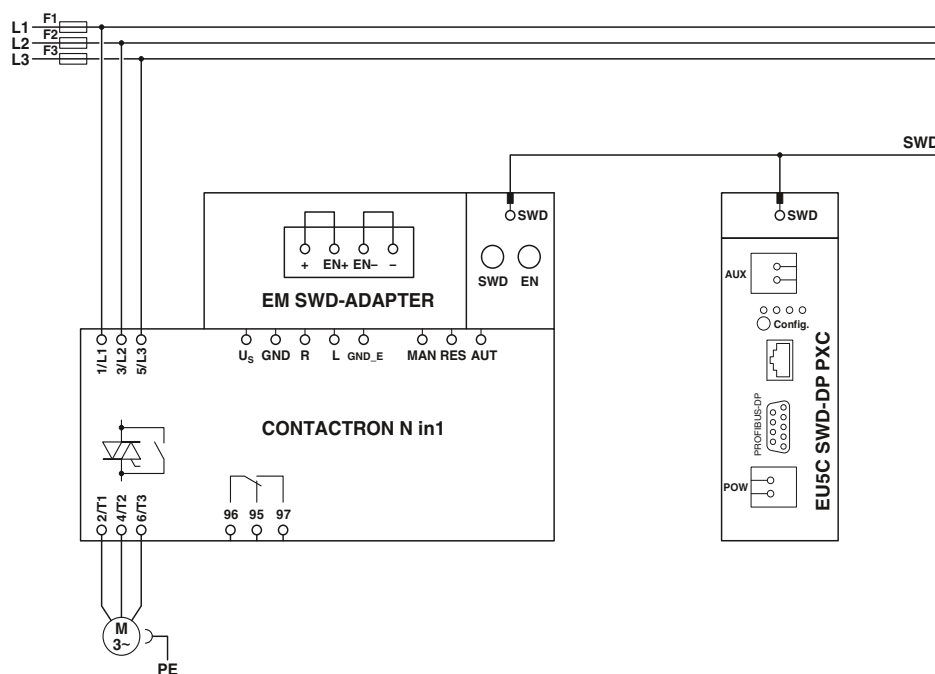

Wiring example without emergency stop

**Intended use**  
The SmartWire-DT™ adapter is approved exclusively for use in conjunction with the following CONTACTRON hybrid motor starters. If other switching devices are used, correct operation, in particular of the safety function, cannot be ensured.

**Motor protection and safe shutdown**

2900582	ELR H5-IES-SC-24DC/500AC-0,6
2900414	ELR H5-IES-SC-24DC/500AC-2
2900421	ELR H5-IES-SC-24DC/500AC-9
2900566	ELR H3-IES-SC-24DC/500AC-0,6
2900567	ELR H3-IES-SC-24DC/500AC-2
2900569	ELR H3-IES-SC-24DC/500AC-9
2297031	ELR W3- 24DC/500AC-2I
2297057	ELR W3- 24DC/500AC-9I
2902952	ELR H51-0,6-DINRAIL-SET
2902953	ELR H51-2,4-DINRAIL-SET
2902954	ELR H51-9-DINRAIL-SET
2902746	ELR H51-IESSC-24DC500AC-06
2902744	ELR H51-IESSC-24DC500AC-2
2902745	ELR H51-IESSC-24DC500AC-9

**Motor protection only**

2900573	ELR H5-I-SC-24DC/500AC-0,6
2900574	ELR H5-I-SC-24DC/500AC-2
2900576	ELR H5-I-SC-24DC/500AC-9
2900542	ELR H3-I-SC-24DC/500AC-0,6
2900543	ELR H3-I-SC-24DC/500AC-2
2900545	ELR H3-I-SC-24DC/500AC-9

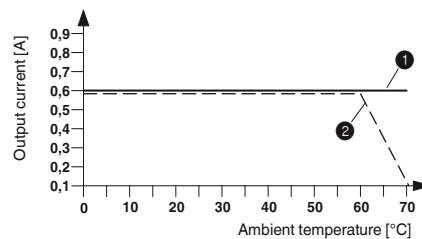

Derating curve for ELR H5-IES-SC-SWD/500AC-0,6  
100% operating time

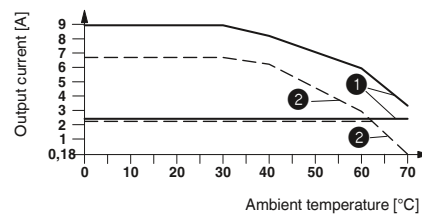

Derating curve for ELR H5-IES-SC-SWD/500AC-2 and  
ELR H5-IES-SC-SWD/500AC-9  
100% operating time

- ① Aligned with > 20 mm spacing
- ② Aligned without spacing

## Solid-state contactors

### Three-phase solid-state reversing contactors

The three-phase solid-state reversing contactors with an integrated locking circuit and load wiring are intended for applications such as control valves, slides, separating filters, ship steering gears, etc. The scope of performance ranges from 575 V AC/3 x 2 A to 575 V AC/3 x 37 A.

Advantages of three-phase solid-state reversing contactors:

- Noise-free and wear-free switching
- Integrated protective circuit
- Stable and short switching times
- Long service life
- High switching frequency
- Integrated locking and load wiring
- Thermal fuse optional

Notes:
Type of insulation housing: <b>ELR W 3...2, ELR W 3...9</b> Polyamide PA non-reinforced, color: green
<b>ELR W 3...16, ELR W 3...37</b> Polyester PBT non-reinforced, color: green
Marking systems and mounting material See Catalog 5

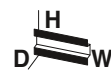

For reversing 3~ AC motors up to 575 V AC/3 x 2 A

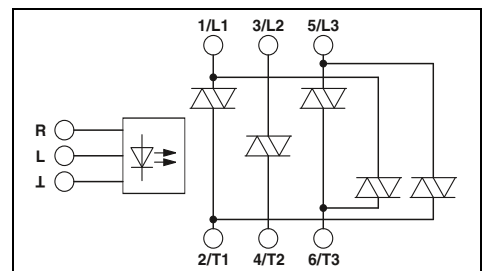

Input data
Rated actuating voltage $U_c$ R/L
Rated actuating voltage range with reference to $U_c$
Rated actuating current $I_c$ at $U_c$
Input circuit
Operating voltage / status / error indicator
Output data load side
Output voltage range
Periodic peak reverse voltage
Load current
Surge current
Min. load current
Residual voltage
Leakage current
Max. load value $I^2 \times t$ ( $t = 10$ ms)
Output protection
General data
Rated insulation voltage
Rated surge voltage
Insulation
Reversing frequency
Switching frequency
Ambient temperature (operation)
Standards/regulations
Degree of protection in acc. with IEC 60529/EN 60529
Mounting position
Mounting
Screw connection solid / stranded / AWG
- Control side
- Load side
Dimensions

Technical data	
24 V DC	230 V AC
0.8 ... 1.25	0.4 ... 1.1
12.7 mA	11.2 mA
Protection against polarity reversal, surge protection	Surge protection
- / Yellow LED / Red LED	
48 V AC ... 575 V AC	48 V AC ... 575 V AC
1200 V	1200 V
max. 2 A (see derating curve)	max. 2 A (see derating curve)
200 A ( $t = 10$ ms)	200 A ( $t = 10$ ms)
100 mA	100 mA
< 1.5 V	< 1.5 V
6 mA	6 mA
250 A <sup>2</sup> s	250 A <sup>2</sup> s
RCV circuit	
500 V	6 kV
6 kV	6 kV
Basic insulation	
max. 10 Hz	max. 2 Hz
max. 5 Hz	max. 1 Hz
-25 °C ... 70 °C	
EN 60947	
DIN EN 50178	
IP20	
Vertical (horizontal DIN rail)	
Can be aligned with spacing = 20 mm	
0.14 - 2.5 mm <sup>2</sup> / 0.14 - 2.5 mm <sup>2</sup> / 26 - 12	
0.14 - 2.5 mm <sup>2</sup> / 0.14 - 2.5 mm <sup>2</sup> / 26 - 12	
40 mm / 99 mm / 114.5 mm	

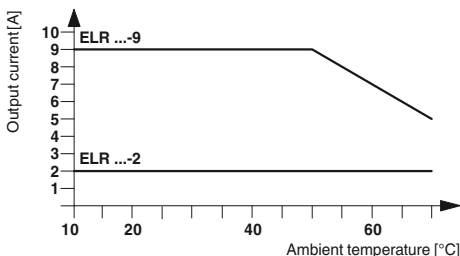

Load current as a function of the ambient temperature  
Operating time: 100% operating factor

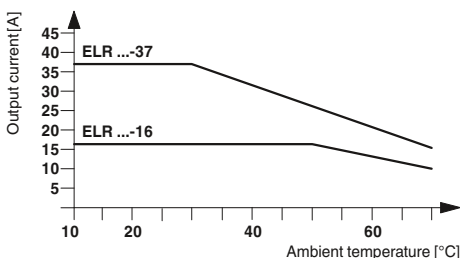

Load current as a function of the ambient temperature  
Operating time: 100% operating factor

Description
<b>3-phase solid-state reversing contactor</b>

Thermal fuse
THERMAL FUSE TF104

Ordering data		
Type	Order No.	Pcs. / Pkt.
ELR W3- 24DC/500AC- 2	2297293	1
ELR W3-230AC/500AC- 2	2297303	1

Accessories		
THERMAL FUSE TF104	2900796	1

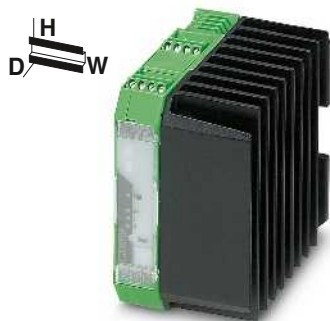

For reversing 3~ AC motors up to 575 V AC/3 x 9 A



For reversing 3~ AC motors up to 575 V AC/3 x 16 A

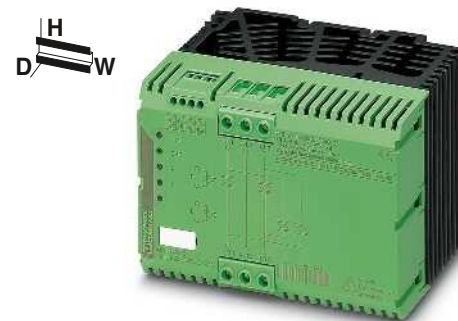

For reversing 3~ AC motors up to 575 V AC/3 x 37 A

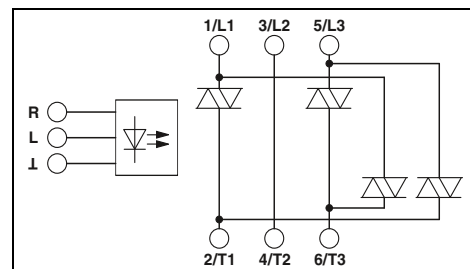
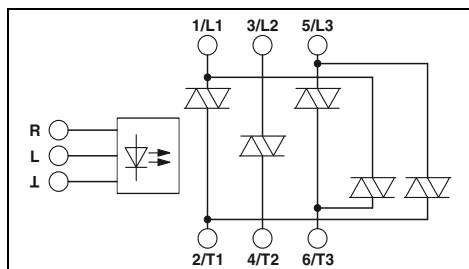
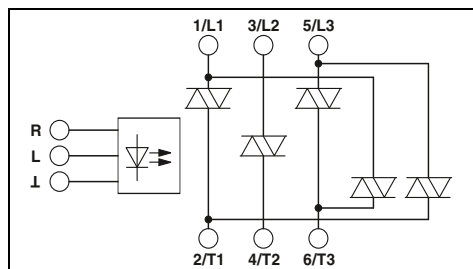

**Technical data**

**Technical data**

**Technical data**

24 V DC 0.8 ... 1.25	230 V AC 0.4 ... 1.1
12.7 mA	11.2 mA
Protection against polarity reversal, surge protection	Surge protection
- / Yellow LED / Red LED	

24 V DC 0.8 ... 1.25	230 V AC 0.4 ... 1.1
12.7 mA	11.2 mA
Protection against polarity reversal, surge protection	Surge protection
- / Yellow LED / Red LED	

24 V DC 0.8 ... 1.25	230 V AC 0.4 ... 1.1
12.7 mA	11.2 mA
Protection against polarity reversal, surge protection	Surge protection
- / Yellow LED / Red LED	

48 V AC ... 575 V AC 1200 V max. 9 A (see derating curve)	48 V AC ... 575 V AC 1200 V max. 9 A (see derating curve)
300 A (t = 10 ms)	300 A (t = 10 ms)
100 mA	100 mA
< 1.5 V	< 1.5 V
6 mA	6 mA
580 A <sup>2</sup> s	580 A <sup>2</sup> s
RCV circuit	

48 V AC ... 575 V AC 1200 V max. 16 A (see derating curve)	48 V AC ... 575 V AC 1200 V max. 16 A (see derating curve)
300 A (t = 10 ms)	300 A (t = 10 ms)
100 mA	100 mA
< 1.5 V	< 1.5 V
6 mA	6 mA
580 A <sup>2</sup> s	580 A <sup>2</sup> s
RCV circuit	

48 V AC ... 575 V AC 1200 V max. 37 A (see derating curve)	48 V AC ... 575 V AC 1200 V max. 37 A (see derating curve)
1300 A (t = 10 ms)	1300 A (t = 10 ms)
200 mA	200 mA
< 1.5 V	< 1.5 V
6 mA	6 mA
9000 A <sup>2</sup> s	9000 A <sup>2</sup> s
RCV circuit	

500 V	6 kV
Basic insulation	max. 2 Hz
max. 10 Hz	max. 1 Hz
max. 5 Hz	
-25 °C ... 70 °C	
EN 60947	
DIN EN 50178	
IP20	
Vertical (horizontal DIN rail)	
Can be aligned with spacing = 20 mm	
0.14 - 2.5 mm <sup>2</sup> / 0.14 - 2.5 mm <sup>2</sup> / 26 - 12	
0.14 - 2.5 mm <sup>2</sup> / 0.14 - 2.5 mm <sup>2</sup> / 26 - 12	
67.5 mm / 99 mm / 114.5 mm	

500 V	6 kV
Basic insulation	max. 2 Hz
max. 10 Hz	max. 1 Hz
max. 5 Hz	
-25 °C ... 70 °C	
EN 60947	
DIN EN 50178	
IP20	
Vertical (horizontal DIN rail)	
Can be aligned with spacing = 40 mm	
0.2 - 4 mm <sup>2</sup> / 0.2 - 2.5 mm <sup>2</sup> / 24 - 12	
0.5 - 16 mm <sup>2</sup> / 0.5 - 16 mm <sup>2</sup> / 20 - 6	
147.5 mm / 99 mm / 114.5 mm	

500 V	6 kV
Basic insulation	max. 2 Hz
max. 10 Hz	max. 1 Hz
max. 5 Hz	
-25 °C ... 70 °C	
EN 60947	
DIN EN 50178	
IP20	
Vertical (horizontal DIN rail)	
Can be aligned with spacing = 40 mm	
0.2 - 4 mm <sup>2</sup> / 0.2 - 2.5 mm <sup>2</sup> / 24 - 12	
0.5 - 16 mm <sup>2</sup> / 0.5 - 16 mm <sup>2</sup> / 20 - 6	
147.5 mm / 99 mm / 114.5 mm	

**Ordering data**

**Ordering data**

**Ordering data**

Type	Order No.	Pcs. / Pkt.
ELR W3-24DC/500AC-9	2297316	1
ELR W3-230AC/500AC-9	2297329	1

Type	Order No.	Pcs. / Pkt.
ELR W3-24DC/500AC-16	2297332	1
ELR W3-230AC/500AC-16	2297345	1

Type	Order No.	Pcs. / Pkt.
ELR W2+1-24DC/500AC-37	2297374	1
ELR W2+1-230AC/500AC-37	2297387	1

**Accessories**

**Accessories**

**Accessories**

THERMAL FUSE TF104	2900796	1
--------------------	---------	---

THERMAL FUSE TF104	2900796	1
--------------------	---------	---

THERMAL FUSE TF104	2900796	1
--------------------	---------	---

## Solid-state contactors

### Three-phase solid-state contactors

Motors of mixers, machine tools, conveying systems, pumps and fans up to 575 V AC/3x37 A (equivalent to 1 kW to 18.5 kW) can be controlled using the CONTACTRON three-phase solid-state contactors.

Advantages of three-phase solid-state contactor:

- Noise-free and wear-free switching
- Integrated protective circuit
- Stable and short switching times
- Long service life
- High switching frequency
- Thermal fuse optional

Notes:
Type of insulation housing: <b>ELR 3...2, ELR 3...9</b> Polyamide PA non-reinforced, color: green
<b>ELR 3...16, ELR 3...37</b> Polyester PBT non-reinforced, color: green
Marking systems and mounting material See Catalog 5

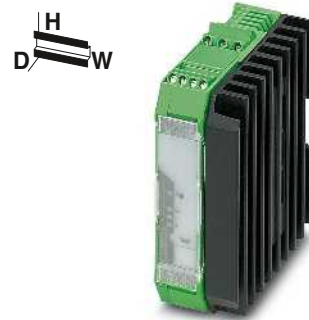

For switching 3~ AC motors up to 575 V AC/3 x 2 A

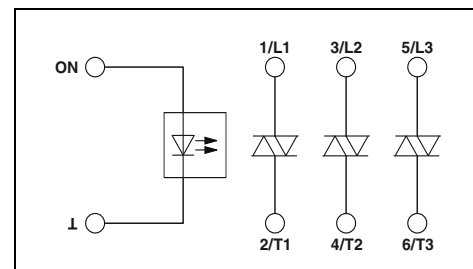

Input data		
Rated actuating voltage $U_c$ ON	24 V DC	230 V AC
Rated actuating voltage range with reference to $U_c$	0.8 ... 1.25	0.4 ... 1.1
Rated actuating current $I_c$ at $U_c$	8.3 mA	12.5 mA
Input circuit	Protection against polarity reversal, surge protection	Surge protection
Operating voltage / status / error indicator	- / Yellow LED / Red LED	
Output data load side		
Output voltage range	48 V AC ... 575 V AC	48 V AC ... 575 V AC
Periodic peak reverse voltage	1200 V	1200 V
Load current	$\leq 2$ A (see derating curve)	$\leq 2$ A (see derating curve)
Surge current	200 A (t = 10 ms)	200 A (t = 10 ms)
Min. load current	100 mA	100 mA
Residual voltage	< 1.5 V	< 1.5 V
Leakage current	6 mA	6 mA
Max. load value $I^2 \times t$ (t = 10 ms)	250 A <sup>2</sup> s	250 A <sup>2</sup> s
Output protection	RCV circuit	
General data		
Rated insulation voltage	500 V	
Rated surge voltage	6 kV	6 kV
Insulation	Basic insulation	
Switching frequency	$\leq 10$ Hz	$\leq 1$ Hz
Ambient temperature (operation)	-25 °C ... 70 °C	
Standards/regulations	EN 60947 DIN EN 50178 IP20	
Degree of protection in acc. with IEC 60529/EN 60529	Vertical (horizontal DIN rail) Can be aligned with spacing = 20 mm	
Mounting position		
Mounting		
Screw connection solid / stranded / AWG	0.14 - 2.5 mm <sup>2</sup> / 0.14 - 2.5 mm <sup>2</sup> / 26 - 12	
- Control side	0.14 - 2.5 mm <sup>2</sup> / 0.14 - 2.5 mm <sup>2</sup> / 26 - 12	
- Load side	40 mm / 99 mm / 114.5 mm	
Dimensions	W / H / D	

### Technical data

Rated actuating voltage $U_c$ ON	24 V DC	230 V AC
Rated actuating voltage range with reference to $U_c$	0.8 ... 1.25	0.4 ... 1.1
Rated actuating current $I_c$ at $U_c$	8.3 mA	12.5 mA
Input circuit	Protection against polarity reversal, surge protection	Surge protection
Operating voltage / status / error indicator	- / Yellow LED / Red LED	
Output data load side		
Output voltage range	48 V AC ... 575 V AC	48 V AC ... 575 V AC
Periodic peak reverse voltage	1200 V	1200 V
Load current	$\leq 2$ A (see derating curve)	$\leq 2$ A (see derating curve)
Surge current	200 A (t = 10 ms)	200 A (t = 10 ms)
Min. load current	100 mA	100 mA
Residual voltage	< 1.5 V	< 1.5 V
Leakage current	6 mA	6 mA
Max. load value $I^2 \times t$ (t = 10 ms)	250 A <sup>2</sup> s	250 A <sup>2</sup> s
Output protection	RCV circuit	
General data		
Rated insulation voltage	500 V	
Rated surge voltage	6 kV	6 kV
Insulation	Basic insulation	
Switching frequency	$\leq 10$ Hz	$\leq 1$ Hz
Ambient temperature (operation)	-25 °C ... 70 °C	
Standards/regulations	EN 60947 DIN EN 50178 IP20	
Degree of protection in acc. with IEC 60529/EN 60529	Vertical (horizontal DIN rail) Can be aligned with spacing = 20 mm	
Mounting position		
Mounting		
Screw connection solid / stranded / AWG	0.14 - 2.5 mm <sup>2</sup> / 0.14 - 2.5 mm <sup>2</sup> / 26 - 12	
- Control side	0.14 - 2.5 mm <sup>2</sup> / 0.14 - 2.5 mm <sup>2</sup> / 26 - 12	
- Load side	40 mm / 99 mm / 114.5 mm	
Dimensions	W / H / D	

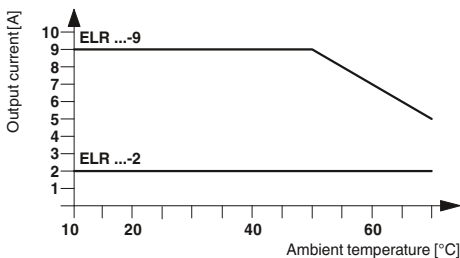

Load current as a function of the ambient temperature  
Operating time: 100% operating factor

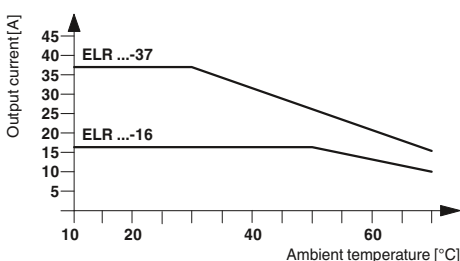

Load current as a function of the ambient temperature  
Operating time: 100% operating factor

Description
<b>Three-phase solid-state contactor</b>
Thermal fuse

### Ordering data

Type	Order No.	Pcs. / Pkt.
ELR 3- 24DC/500AC- 2	2297196	1
ELR 3-230AC/500AC- 2	2297206	1

### Accessories

Thermal fuse	Order No.	Pcs. / Pkt.
THERMAL FUSE TF104	2900796	1

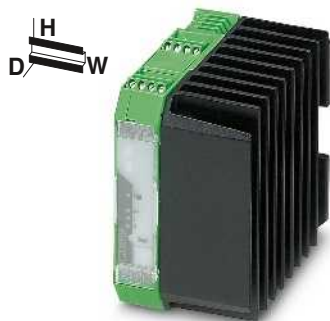

For switching 3~ AC motors up to 575 V AC/3 x 9 A



For switching 3~ AC motors up to 575 V AC/3 x 16 A



For switching 3~ AC motors up to 575 V AC/3 x 37 A

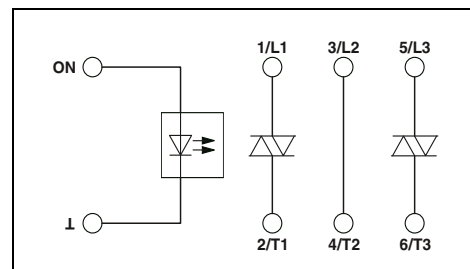
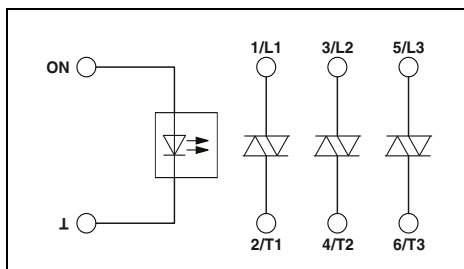
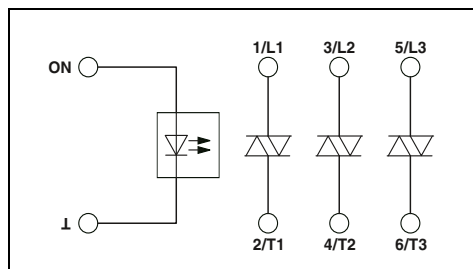

**Technical data**

**Technical data**

**Technical data**

24 V DC 0.8 ... 1.25	230 V AC 0.4 ... 1.1
8.3 mA	12.5 mA
Protection against polarity reversal, surge protection	Surge protection
- / Yellow LED / Red LED	

24 V DC 0.8 ... 1.25	230 V AC 0.4 ... 1.1
8.3 mA	12.5 mA
Protection against polarity reversal, surge protection	Surge protection
- / Yellow LED / Red LED	

24 V DC 0.8 ... 1.25	230 V AC 0.4 ... 1.1
8.3 mA	12.5 mA
Protection against polarity reversal, surge protection	Surge protection
- / Yellow LED / Red LED	

48 V AC ... 575 V AC 1200 V ≤ 9 A (see derating curve)	48 V AC ... 575 V AC 1200 V ≤ 9 A (see derating curve)
300 A (t = 10 ms)	300 A (t = 10 ms)
100 mA	100 mA
< 1.5 V	< 1.5 V
6 mA	6 mA
580 A <sup>2</sup> s	580 A <sup>2</sup> s
RCV circuit	

48 V AC ... 575 V AC 1200 V ≤ 16 A (see derating curve)	48 V AC ... 575 V AC 1200 V ≤ 16 A (see derating curve)
300 A (t = 10 ms)	300 A (t = 10 ms)
100 mA	100 mA
< 1.5 V	< 1.5 V
6 mA	6 mA
580 A <sup>2</sup> s	580 A <sup>2</sup> s
RCV circuit	

48 V AC ... 575 V AC 1200 V ≤ 37 A (see derating curve)	48 V AC ... 575 V AC 1200 V ≤ 37 A (see derating curve)
1300 A (t = 10 ms)	1300 A (t = 10 ms)
200 mA	200 mA
< 1.5 V	< 1.5 V
6 mA	6 mA
9000 A <sup>2</sup> s	9000 A <sup>2</sup> s
RCV circuit	

500 V	6 kV
Basic insulation	6 kV
≤ 10 Hz	≤ 1 Hz
-25 °C ... 70 °C	
EN 60947	
DIN EN 50178	
IP20	
Vertical (horizontal DIN rail)	
Can be aligned with spacing = 20 mm	

500 V	6 kV
Basic insulation	6 kV
≤ 10 Hz	≤ 1 Hz
-25 °C ... 70 °C	
EN 60947	
DIN EN 50178	
IP20	
Vertical (horizontal DIN rail)	
Can be aligned with spacing = 40 mm	

500 V	6 kV
Basic insulation	6 kV
≤ 10 Hz	≤ 1 Hz
-25 °C ... 70 °C	
EN 60947	
DIN EN 50178	
IP20	
Vertical (horizontal DIN rail)	
Can be aligned with spacing = 40 mm	

0.14 - 2.5 mm <sup>2</sup> / 0.14 - 2.5 mm <sup>2</sup> / 26 - 12
0.14 - 2.5 mm <sup>2</sup> / 0.14 - 2.5 mm <sup>2</sup> / 26 - 12
67.5 mm / 99 mm / 114.5 mm

0.2 - 4 mm <sup>2</sup> / 0.2 - 2.5 mm <sup>2</sup> / 24 - 12
0.5 - 16 mm <sup>2</sup> / 0.5 - 16 mm <sup>2</sup> / 20 - 6
147.5 mm / 99 mm / 114.5 mm

0.2 - 4 mm <sup>2</sup> / 0.2 - 2.5 mm <sup>2</sup> / 24 - 12
0.5 - 16 mm <sup>2</sup> / 0.5 - 16 mm <sup>2</sup> / 20 - 6
147.5 mm / 99 mm / 114.5 mm

**Ordering data**

**Ordering data**

**Ordering data**

Type	Order No.	Pcs. / Pkt.
ELR 3- 24DC/500AC- 9	2297219	1
ELR 3-230AC/500AC- 9	2297222	1

Type	Order No.	Pcs. / Pkt.
ELR 3- 24DC/500AC-16	2297235	1
ELR 3-230AC/500AC-16	2297248	1

Type	Order No.	Pcs. / Pkt.
ELR 2+1- 24DC/500AC-37	2297277	1
ELR 2+1-230AC/500AC-37	2297280	1

**Accessories**

**Accessories**

**Accessories**

THERMAL FUSE TF104	2900796	1
--------------------	---------	---

THERMAL FUSE TF104	2900796	1
--------------------	---------	---

THERMAL FUSE TF104	2900796	1
--------------------	---------	---

## Solid-state contactors

### Solid-state reversing contactor with soft starter

The ELR W 3/9-400 S soft switch can be used to increase the service life of a 3-phase induction motor.

- Parameterization is performed directly on the device via display and keyboard
- Friction time
- Torque, start
- Start time
- Stop time
- Torque, stop
- Braking time and
- Braking torque
- Drive can be controlled locally via keyboard

Notes:
Type of housing: Polycarbonate PC, color: green.
Marking systems and mounting material See Catalog 5



ERC

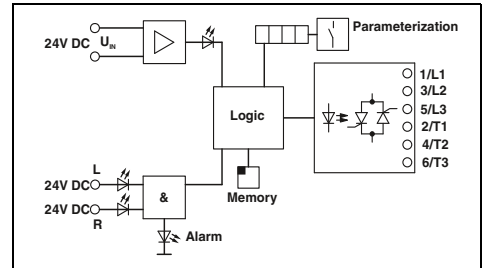

Input data
Supply nominal voltage $U_{VN}$
Supply voltage range with reference to $U_{VN}$
Quiescent current
Control voltage $U_{ST}$ right/left
Control voltage range in reference to $U_{ST}$
Typ. input current at $U_N$
Input circuit
Operating voltage / status / error indicator
Output data load side
Max. switching voltage
Output voltage range
Periodic peak reverse voltage
Load current
Surge current
Min. load current
Residual voltage
Leakage current
Output protection
General data
Test voltage input/output
Ambient temperature (operation)
Standards/regulations
Degree of protection in acc. with IEC 60529/EN 60529
Mounting position
Mounting
Screw connection solid / stranded / AWG
Dimensions
EMC note

Technical data
24 V DC
0.8 ... 1.2
85 mA
24 V DC
0.8 ... 1.2
5 mA
Protection against polarity reversal, surge protection
Green LED / Yellow LED / Red LED
440 V AC (L1/T1)
440 V AC (L2/T2)
440 V AC (L3/T3)
110 V AC ... 433 V AC
1000 V
< 8 A (IL1, at 20 °C Ta, see derating)
< 8 A (IL2, at 20 °C Ta, see derating)
< 8 A (IL3, at 20 °C Ta, see derating)
230 A (tp = 10 ms, at 25 °C)
150 mA
typ. 1.5 V (For IL)
5 mA (IL1, in switched-off state)
RC element, surge protection
2.5 kV
-20 °C ... 60 °C
EN 61000-6-2 / EN 61000-6-4
DIN EN 50178
IP20
Vertical (horizontal DIN rail)
Can be aligned with > 20 mm spacing
0.2 - 6 mm <sup>2</sup> / 0.2 - 4 mm <sup>2</sup> / 24 - 10
62 mm / 94 mm / 122 mm
Class A product, see page 625

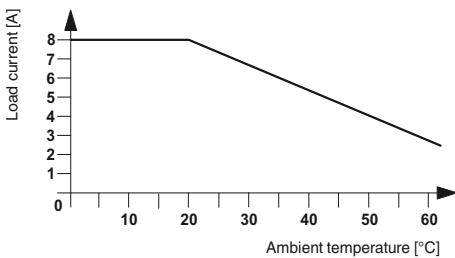

Load current as a function of the ambient temperature  
Operating time: 100% operating factor

Description
<b>Electronic reversing load relay, with an integrated soft switch</b>

Ordering data		
Type	Order No.	Pcs. / Pkt.
ELR W3/ 9-400 S	2963569	1



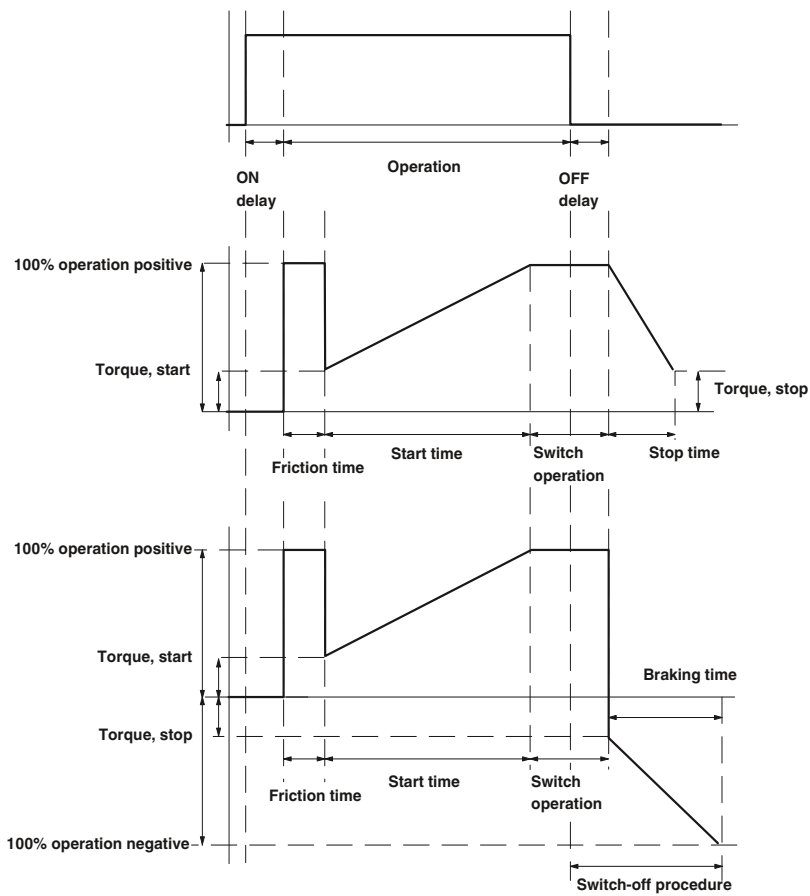

The figure shows the control of the reversing load relay with a soft starter and the operation of a three-phase current load.

## Solid-state contactors

### Electronic reversing load relays for DC motors

The ELR-DC electronic reversing load relays allow mechanically commutated DC motors to be switched. They reverse and reduce the speed of DC motors up to 24 V/6 A in a wear-free manner. A short-circuit, surge-voltage and overload-proof output guarantees reliable use in the plant.

If a 24 V DC signal is applied to the “left” input, the ELR-DC is interconnected so that the output supplies the motor with voltage. If the “right” input is triggered, the polarity of the voltage is inverted on the output. By triggering both inputs, i.e. “right” and “left”, the motor is short-circuited internally via the ELR-DC and reduces the speed.

Thanks to the internal interlocking circuit and load wiring, wiring effort is reduced to a minimum.

Notes:
Type of housing: Polycarbonate PC, color: green.
Marking systems and mounting material See Catalog 5
PWM = Pulse Width Modulation

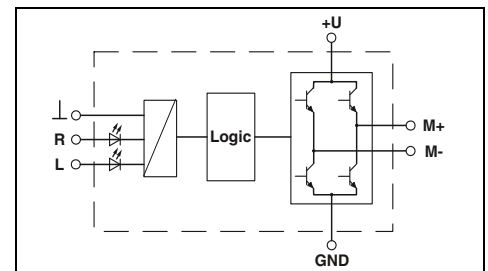

#### Technical data

<b>Input data</b>	
Control voltage $U_{ST}$ right/left	24 V DC
Control voltage range in reference to $U_{ST}$	0.8 ... 1.2
Typ. input current at $U_N$	3 mA
Input circuit	Protection against polarity reversal, surge protection
Operating voltage / status / error indicator	Green LED / yellow LED, forward running (R), yellow LED, reverse running (L) / -
<b>Output data load side</b>	
Output voltage range	10 V DC ... 30 V DC
Load current	2 A (aligned without spacing) / 6 A (see derating curve)
Quiescent current	approx. 7 mA (when switched off)
Current limitation at short-circuits	15 A
Output protection	Protection against polarity reversal, surge protection
Operating voltage / status / error indicator	Green LED / - / -
<b>General data</b>	
Test voltage input/output	2.5 kV AC
Ambient temperature (operation)	-20 °C ... 60 °C
Nominal operating mode	100% operating factor
Standards/regulations	EN 50178 / Basic insulation
Degree of protection in acc. with IEC 60529/EN 60529	IP20
Mounting position	Vertical (horizontal DIN rail)
Screw connection solid / stranded / AWG	0.2 - 6 mm <sup>2</sup> / 0.2 - 4 mm <sup>2</sup> / 24 - 10
Dimensions	12.5 mm / 99 mm / 114.5 mm
EMC note	Class A product, see page 625

24 V DC	24 V DC
0.8 ... 1.2	0.8 ... 1.2
3 mA	3 mA
Protection against polarity reversal, surge protection	
Green LED / yellow LED, forward running (R), yellow LED, reverse running (L) / -	
10 V DC ... 30 V DC	10 V DC ... 30 V DC
2 A (aligned without spacing)	6 A (see derating curve)
approx. 7 mA (when switched off)	approx. 7 mA (when switched off)
15 A	20 A
Protection against polarity reversal, surge protection	
Green LED / - / -	
2.5 kV AC	
-20 °C ... 60 °C	
100% operating factor	
EN 50178 / Basic insulation	
IP20	
Vertical (horizontal DIN rail)	
0.2 - 6 mm <sup>2</sup> / 0.2 - 4 mm <sup>2</sup> / 24 - 10	
12.5 mm / 99 mm / 114.5 mm	
Class A product, see page 625	

#### Application example

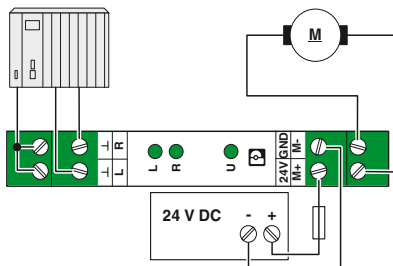

#### Status table

Input		Output	
Right	Left	M +	M -
0	0	High resistance	High resistance
1	0	+24 V	GND
0	1	GND	+24 V
1	1	GND	GND

<b>Description</b>
<b>3-phase solid-state reversing contactor, for controlling DC motors</b>

#### Ordering data

Type	Order No.	Pcs. / Pkt.
ELR W1/ 2-24DC	2963598	1
ELR W1/ 6-24DC	2982090	1

#### Load current depending on ambient temperature

Operating time: 100% OT

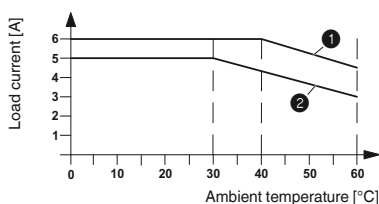

- ① Single device
- ② Aligned without spacing



## Solid-state contactors

### Single-phase solid-state contactors

Single-phase solid-state contactors are used in AC voltage networks wherever silent switching, high switching frequencies and a practically unlimited service life are required.

The robust power semiconductors switch in zero voltage crossing and thus produce no additional high frequency interference. The modules are resistant to shock loads and vibrations – they can even be used in aggressive, polluted environments without any problems.

They offer the following advantages:

- High switching frequency
  - Wear-free and output-free
  - 24 V DC and 230 V AC input voltage versions
- Common areas of application are:
- Conveyor equipment
  - Light and lighting systems
  - Conveyor equipment
  - Light and lighting systems

Notes:	
Type of housing:	Polycarbonate PC, color: green.
Marking systems and mounting material	See Catalog 5



For switching 1~ AC motors up to 660 V AC/20 A

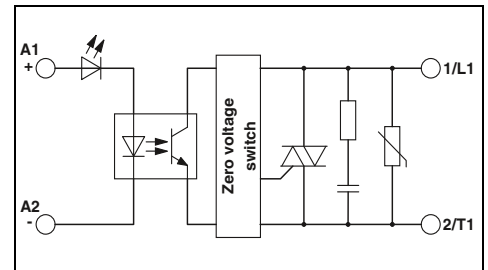

#### Technical data

Input data			
Input voltage range	4 V DC ... 32 V DC	24 V AC ... 275 V AC	
Typ. input current at $U_N$	approx. 12 mA	approx. 17 mA	
Switching level	1 signal ("H") 0 signal ("L")	$\geq 4$ V DC $\leq 1$ V DC	$\geq 22$ V AC $\leq 6$ V AC
Transmission frequency $f_{limit}$	25 Hz	6 Hz	
Operating voltage / status / error indicator		Green LED / - / -	
Output data load side			
Output voltage range	42 V AC ... 660 V AC (45/65 Hz)	42 V AC ... 660 V AC (45/65 Hz)	
Periodic peak reverse voltage	1200 V	1200 V	
Load current	20 A (see derating curve)	20 A (see derating curve)	
Surge current	250 A (t = 10 ms)	250 A (t = 10 ms)	
Min. load current	350 mA	350 mA	
Residual voltage	< 1.6 V	< 1.6 V	
Leakage current	< 3 mA (in off state)	< 3 mA (in off state)	
Phase angle (cos $\phi$ )	0.5	0.5	
Max. load value $I^2 \times t$ (t = 10 ms)	525 A <sup>2</sup> s	525 A <sup>2</sup> s	
Output protection		RCV circuit	
General data			
Test voltage input/output	4 kV <sub>rms</sub>		
Insulation	Basic insulation		
Ambient temperature (operation)	-30 °C ... 70 °C		
Standards/regulations	EN 61000-4-2 / EN 61000-4-3 / EN 61000-4-4 / EN 61000-4-5 / EN 61000-4-6 / EN 55011		
Mounting position	Vertical (horizontal DIN rail)		
Mounting	Can be aligned with $\geq 22.5$ mm spacing		
Screw connection solid / stranded / AWG	0.5 - 2.5 mm <sup>2</sup> / 0.5 - 2.5 mm <sup>2</sup> / 20 - 14		
- Control side	0.5 - 4 mm <sup>2</sup> / 0.5 - 4 mm <sup>2</sup> / 20 - 12		
- Load side	22.5 mm / 103 mm / 103 mm		
Dimensions	W / H / D		

#### Ordering data

Description	Type	Order No.	Pcs. / Pkt.
Single-phase electronic load relay	ELR 1-24DC/600AC-20	2297138	1
	ELR 1-230AC/600AC-20	2297141	1

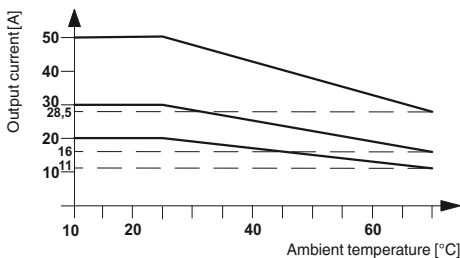

Load current as a function of the ambient temperature  
Operating time: 100% operating factor



For switching 1~ AC motors up to 660 V AC/30 A



For switching 1~ AC motors up to 660 V AC/50 A

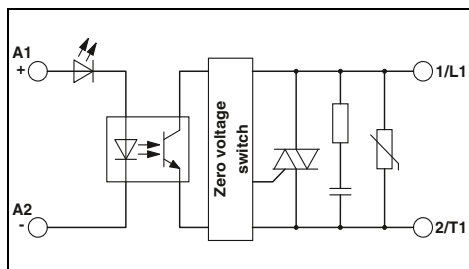
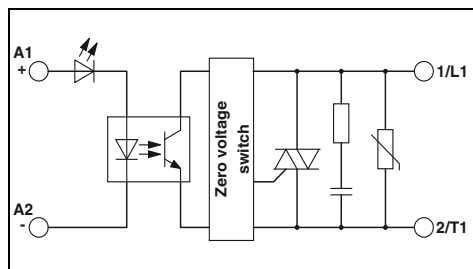

Technical data

4 V DC ... 32 V DC      24 V AC ... 275 V AC  
 approx. 12 mA      approx. 17 mA  
 ≥ 4 V DC      ≥ 22 V AC  
 ≤ 1 V DC      ≤ 6 V AC  
 25 Hz      6 Hz  
 Green LED / - / -

42 V AC ... 660 V AC (45/65 Hz)      42 V AC ... 660 V AC (45/65 Hz)  
 1200 V      1200 V  
 30 A (see derating curve)      30 A (see derating curve)  
 400 A (t = 10 ms)      400 A (t = 10 ms)  
 150 mA      150 mA  
 < 1.6 V      < 1.6 V  
 < 3 mA (in off state)      < 3 mA (in off state)  
 0.5      0.5  
 1800 A²s      1800 A²s  
 RCV circuit

4 kV<sub>rms</sub>  
 Basic insulation  
 -30 °C ... 70 °C

EN 61000-4-2 / EN 61000-4-3 / EN 61000-4-4 / EN 61000-4-5 /  
 EN 61000-4-6 / EN 55011  
 Vertical (horizontal DIN rail)  
 Can be aligned with ≥ 22.5 mm spacing

0.5 - 2.5 mm² / 0.5 - 2.5 mm² / 20 - 14  
 0.5 - 4 mm² / 0.5 - 4 mm² / 20 - 12  
 22.5 mm / 103 mm / 103 mm

Ordering data

Type	Order No.	Pcs. / Pkt.
ELR 1- 24DC/600AC-30	2297154	1
ELR 1-230AC/600AC-30	2297167	1

Technical data

4 V DC ... 32 V DC      24 V AC ... 275 V AC  
 approx. 12 mA      approx. 17 mA  
 ≥ 4 V DC      ≥ 22 V AC  
 ≤ 1 V DC      ≤ 6 V AC  
 25 Hz      6 Hz  
 Green LED / - / -

42 V AC ... 660 V AC (45/65 Hz)      42 V AC ... 660 V AC (45/65 Hz)  
 1200 V      1200 V  
 50 A (see derating curve)      50 A (see derating curve)  
 1900 A (t = 10 ms)      1900 A (t = 10 ms)  
 150 mA      150 mA  
 < 1.6 V      < 1.6 V  
 < 3 mA (in off state)      < 3 mA (in off state)  
 0.5      0.5  
 18000 A²s      18000 A²s  
 RCV circuit

4 kV<sub>rms</sub>  
 Basic insulation  
 -30 °C ... 70 °C

EN 61000-4-2 / EN 61000-4-3 / EN 61000-4-4 / EN 61000-4-5 /  
 EN 61000-4-6 / EN 55011  
 Vertical (horizontal DIN rail)  
 Can be aligned with ≥ 22.5 mm spacing

0.5 - 4 mm² / 0.5 - 4 mm² / 20 - 12  
 4 - 25 mm² / 4 - 25 mm² / 12 - 3  
 45 mm / 103 mm / 103 mm

Ordering data

Type	Order No.	Pcs. / Pkt.
ELR 1- 24DC/600AC-50	2297170	1
ELR 1-230AC/600AC-50	2297183	1

### PROFINET motor starters

Motor starters in robust stainless steel housing (IP67) can be used directly in the system as a compact function unit. This eliminates the complex wiring of individual functions in the control cabinet.

The motor starter can be used to control three-phase asynchronous motors in two directions of rotation, completely via PROFINET. Distributed sensors and actuators can be directly connected to PROFINET without the need for further intermediate stations or additional cabling. A complete PROFINET motor starter consists of three products. For example:

- ELR 5011 IP PN
- IBS IP 400 MBH-F
- IBS PG SET

#### Additional features:

- Performance classes: 1.1 kW to 3.0 kW
- One and two-motor reversing starters (CONTACTRON hybrid motor starter)
- Easy assembly
- Plug-in connection system
- Exchangeable module electronics
- Status and diagnostics indicators on the module
- 10 digital inputs for connecting sensors
- 4 digital outputs for connecting actuators



**Electronic motor starters,  
1 x 1.1 kW and 2 x 1.1 kW**

ERC PROFIBUS

Interface	
Fieldbus system	PROFINET
Connection method	8-pos. RJ45 socket on motor starter
Power supply for module electronics	
Supply voltage	24 V DC ( $U_{S1}$ / $U_{S2}$ )
Supply voltage range	20 V DC ... 30 V DC (including ripple)
Power supply for sensors	
Minimum voltage	$U_{NI} = U_{S1}$ minus 1 V
Nominal current per sensor	500 mA
Type of protection	Short-circuit/overload protection
Digital inputs	
Number of inputs	10
Connection method	M12 connector
Connection method	2, 3, 4-wire
Digital outputs	
Number of outputs	4
Connection method	M12 connector
Connection method	2-wire
Output current	max. 500 mA (per channel)
Motor starter, output	
Connection method	POWER-COMBICON
Operating voltage	360 V AC ... 550 V AC (line voltage 50/60 Hz)
Nominal current range	
Frequency range	0.18 A ... 2.4 A
Nominal motor power	50 Hz ... 60 Hz (mains frequency)
Motor monitoring	
Parameterization range	1.1 kW (at $U_{mains} = 400$ V AC)
Tripping class	0.2 A ... 2.4 A
General data	
Weight	Based on class 10 A of IEC 60947
Degree of protection	2115 g
Ambient temperature (operation)	2425 g
EMC note	IP67 in acc. with IEC 60529
	-25 °C ... 50 °C (non-condensing)

Technical data	
ELR 5011 IP PN	ELR 5011-2 IP PN
PROFINET	
8-pos. RJ45 socket on motor starter	
24 V DC ( $U_{S1}$ / $U_{S2}$ )	
20 V DC ... 30 V DC (including ripple)	
$U_{NI} = U_{S1}$ minus 1 V	
500 mA	
Short-circuit/overload protection	
10	
M12 connector	
2, 3, 4-wire	
4	
M12 connector	
2-wire	
max. 500 mA (per channel)	
POWER-COMBICON	
360 V AC ... 550 V AC (line voltage 50/60 Hz)	
0.18 A ... 2.4 A	
50 Hz ... 60 Hz (mains frequency)	
1.1 kW (at $U_{mains} = 400$ V AC)	
0.2 A ... 2.4 A	
Based on class 10 A of IEC 60947	
2115 g	2425 g
IP67 in acc. with IEC 60529	
-25 °C ... 50 °C (non-condensing)	

Description
<b>PROFINET motor starter</b> - 1-channel reversing starter, 1.1 kW - 2-channel reversing starter, 1.1 kW
<b>PROFINET motor starter</b> - 1-channel reversing starter, 3.0 kW - 2-channel reversing starter, 3.0 kW
<b>Lower housing part</b> , stainless steel - Standard version
<b>Pg screw connection</b> , plastic (IP67), for INTERBUS and PROFINET motor starters and variable frequency drives.

Ordering data		
Type	Order No.	Pcs. / Pkt.
ELR 5011 IP PN	2700745	1
ELR 5011-2 IP PN	2701007	1
IBS IP 400 MBH -F	2732868	1
IBS PG SET	2836599	1

<b>RJ45 connector</b> , shielded, with bend protection sleeve, x 2
- gray for straight cables
- green for crossed cables
<b>Bus system cable</b>
<b>Crimping pliers</b> , for assembling the RJ45 connectors

Accessories		
FL PLUG RJ45 GR/2	2744856	1
FL PLUG RJ45 GN/2	2744571	1
VS-937/...	1402611	1
FL CRIMPTOOL	2744869	1





Electronic motor starters,  
1 x 3.0 kW and 2 x 3.0 kW



Stainless steel lower housing part,  
IP67 protection



Technical data	
ELR 5030 IP PN	ELR 5030-2 IP PN
PROFINET	
8-pos. RJ45 socket on motor starter	
24 V DC ( $U_{S1} / U_{S2}$ )	
20 V DC ... 30 V DC (including ripple)	
$U_{IN} = U_{S1}$ minus 1 V	
500 mA	
Short-circuit/overload protection	
10	
M12 connector	
2, 3, 4-wire	
4	
M12 connector	
2-wire	
max. 500 mA (per channel)	
POWER-COMBICON	
360 V AC ... 550 V AC (line voltage 50/60 Hz)	
2.4 A ... 6 A	
50 Hz ... 60 Hz (mains frequency)	
3 kW (at $U_{mains} = 400$ V AC)	
2.4 A ... 6 A	
Based on class 10 A of IEC 60947	
2115 g	2425 g
IP67 in acc. with IEC 60529	
-25 °C ... 50 °C (non-condensing)	

Technical data	
IBS IP 400 MBH -F	
-	-
-	-
-	-
-	-
-	-
-	-
-	-
-	-
-	-
-	-
-	-
-	-
-	-
1130 g	-
IP67 in acc. with IEC 60529	
-	-
Class A product, see page 625	

Ordering data		
Type	Order No.	Pcs. / Pkt.
ELR 5030 IP PN	2701006	1
ELR 5030-2 IP PN	2701008	1
IBS IP 400 MBH -F	2732868	1
IBS PG SET	2836599	1

Ordering data		
Type	Order No.	Pcs. / Pkt.
IBS IP 400 MBH -F	2732868	1
IBS PG SET	2836599	1

Accessories		
	Order No.	Pcs. / Pkt.
FL PLUG RJ45 GR/2	2744856	1
FL PLUG RJ45 GN/2	2744571	1
VS-937/...	1402611	1
FL CRIMPTOOL	2744869	1

Accessories		
	Order No.	Pcs. / Pkt.
FL PLUG RJ45 GR/2	2744856	1
FL PLUG RJ45 GN/2	2744571	1
VS-937/...	1402611	1
FL CRIMPTOOL	2744869	1

## IP20 frequency inverters

### Inline frequency inverters

Inline frequency inverters for the control cabinet are the compact solution for extending your Easy Automation solution to include electronic speed regulation for asynchronous motors. The devices seamlessly integrate into the Inline system and have IP20 protection. Depending on the drive task, you can select frequency inverters from various performance classes, up to a maximum of 4 kW. In order to connect to the Inline system via the Fieldline local bus, you just need the IB IL 24 FLM-PAC Inline module. The Inline frequency inverter can be connected to a Phoenix Contact controller via the Inline module.

#### Additional features:

- Max. motor power of 0.75 kW, 1.5 kW, 2.2 kW, and 4.0 kW
- 3 x 400 V mains input ( $\pm 15\%$ ) 50/60 Hz
- DTM for parameterization and diagnostics
- 8 freely programmable parameter records
- PTC evaluation for 2.2 kW and 4.0 kW versions
- Integrated line filter
- U/f linear and U/f square operating modes
- S-ramp function
- Motor protection function ( $I^2t$ )
- Connection of a braking resistor
- DC braking
- Evaluation of the temperature switch in the motor
- Voltage boost
- 1 x analog input, 1 x analog output, 1 x relay output



Frequency inverter for max. motor power of up to 0.75 kW

Interface	
Designation	Fieldline local bus
Connection method	9-pos. D-SUB connector/socket
Power supply for module electronics	
Supply voltage	24 V DC $\pm 15\%$
Supply voltage range	20.4 V DC ... 27.6 V DC $\pm 15\%$
Digital inputs	
Number of inputs	5
Connection method	COMBICON
Connection method	Spring-cage connection
Analog inputs	
Number of inputs	1
Connection method	COMBICON
Connection method	Spring-cage connection
Analog outputs	
Number of inputs	1
Connection method	COMBICON
Connection method	Spring-cage connection
Frequency inverter output	
Rated current	2.6 A +20 %
Frequency range	0 Hz ... 400 Hz
Parameterization	Via INTERBUS
Tripping class	5.6 A OC tripping current
General data	
Weight	1400 g
Degree of protection	IP20 in acc. with IEC 60529/ EN 60529
Width	90 mm
Height	173 mm
Depth	153.5 mm

#### Technical data

Fieldline local bus	
9-pos. D-SUB connector/socket	
24 V DC $\pm 15\%$	
20.4 V DC ... 27.6 V DC $\pm 15\%$	
5	
COMBICON	
Spring-cage connection	
1	
COMBICON	
Spring-cage connection	
1	
COMBICON	
Spring-cage connection	
2.6 A +20 %	
0 Hz ... 400 Hz	
Via INTERBUS	
5.6 A OC tripping current	

Description
<b>Inline frequency inverter</b> for the control cabinet
<b>Inline Modular branch terminal</b> for coupling one Fieldline Modular M8 local bus at the end of an Inline station
<b>Remote bus cable</b> , highly flexible, 3 x 2 x 0.25 mm <sup>2</sup>

#### Ordering data

Type	Order No.	Pcs. / Pkt.
VFD 5007 IL IB	2701054	1

#### Accessories

IB IL 24 FLM-PAC	2736903	1
IBS RBC/F-T/	2740151	1



Frequency inverter for max. motor power of up to 1.5 kW



Frequency inverter for max. motor power of up to 2.2 kW



Frequency inverter for max. motor power of up to 4.0 kW

Technical data
Fieldline local bus 9-pos. D-SUB connector/socket
24 V DC $\pm 15\%$ 20.4 V DC ... 27.6 V DC $\pm 15\%$
5 COMBICON Spring-cage connection
1 COMBICON Spring-cage connection
1 COMBICON Spring-cage connection
4.1 A $+20\%$ 0 Hz ... 400 Hz Via INTERBUS 8.8 A OC tripping current
1400 g IP20 in acc. with IEC 60529/ EN 60529 90 mm 173 mm 153.5 mm

Technical data
Fieldline local bus 9-pos. D-SUB connector/socket
24 V DC $\pm 15\%$ 20.4 V DC ... 27.6 V DC $\pm 15\%$
5 COMBICON Spring-cage connection
1 COMBICON Spring-cage connection
1 COMBICON Spring-cage connection
5.8 A $+20\%$ 0 Hz ... 400 Hz Via INTERBUS 12.5 A OC tripping current
2200 g IP20 in acc. with IEC 60529/ EN 60529 117 mm 173 mm 174.5 mm

Technical data
Fieldline local bus 9-pos. D-SUB connector/socket
24 V DC $\pm 15\%$ 20.4 V DC ... 27.6 V DC $\pm 15\%$
5 COMBICON Spring-cage connection
1 COMBICON Spring-cage connection
1 COMBICON Spring-cage connection
9.5 A $+20\%$ 0 Hz ... 400 Hz Via INTERBUS 21 A OC tripping current
2200 g IP20 in acc. with IEC 60529/ EN 60529 117 mm 173 mm 174.5 mm

Ordering data		
Type	Order No.	Pcs. / Pkt.
VFD 5015 IL IB	2701055	1

Ordering data		
Type	Order No.	Pcs. / Pkt.
VFD 5022 IL IB	2701057	1

Ordering data		
Type	Order No.	Pcs. / Pkt.
VFD 5040 IL IB	2701058	1

Accessories		
Type	Order No.	Pcs. / Pkt.
IB IL 24 FLM-PAC	2736903	1
IBS RBC/F-T/	2740151	1

Accessories		
Type	Order No.	Pcs. / Pkt.
IB IL 24 FLM-PAC	2736903	1
IBS RBC/F-T/	2740151	1

Accessories		
Type	Order No.	Pcs. / Pkt.
IB IL 24 FLM-PAC	2736903	1
IBS RBC/F-T/	2740151	1

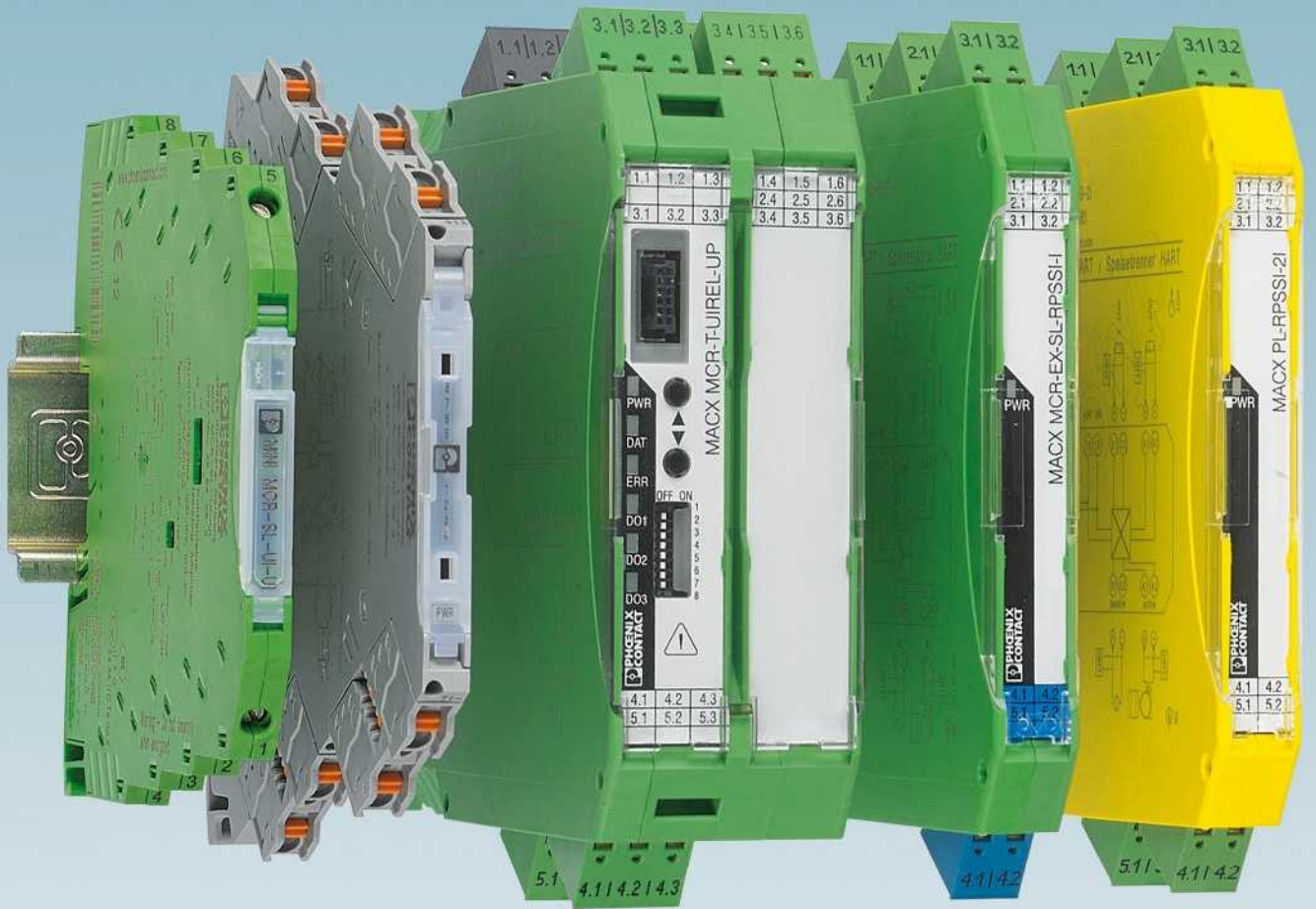

# MCR technology

From highly compact 6 mm signal conditioners to functionally safe signal conditioners through to signal isolators for intrinsically safe circuits in the Ex area: our signal conditioner range offers a solution for all applications in analog signal conditioning.

We offer the following product ranges:

## Highly compact signal conditioners with plug-in connection technology – MINI Analog Pro

For maximum convenience during installation and service

- Overall width of just 6.2 mm
- Current measurement without isolation
- Safe electrical isolation

## Highly compact signal conditioners – MINI Analog

For significant space savings and efficiency

- Overall width of just 6.2 mm
- System cabling and multiplexer solutions
- Electrical isolation

## Signal conditioners, head transducers, and digital displays – MCR Analog

- Electrical isolation
- Record and convert temperatures directly in the field
- Display process values

## Signal conditioners with SIL functional safety – MACX Analog

- For maximum signal safety
- Consistent SIL certification
- Safe electrical isolation

## Signal conditioners with PL functional safety – MACX Safety

The proven MACX range for safety applications according to the Machinery Directive

## Ex i signal conditioners with SIL functional safety – MACX Analog Ex

- For intrinsically safe circuits in the Ex area
- Maximum explosion protection for all Ex zones and gas groups
- Safe electrical isolation

## Ex i signal conditioners with PL functional safety – MACX Safety Ex

The proven MACX EX range for safety applications according to the Machinery Directive

## Product range overview

<b>Product overview</b>	<b>52</b>
<b>Selection guide for signal conditioners</b>	<b>56</b>
<b>Basics</b>	<b>58</b>
<b>Highly compact signal conditioners with plug-in connection technology – MINI Analog Pro</b>	<b>64</b>
<b>Highly compact signal conditioners – MINI Analog</b>	<b>90</b>
<b>Signal conditioners, head transducers, and process indicators – MCR Analog</b>	<b>128</b>
<b>Signal conditioners with functional safety and explosion protection - the MACX ranges</b>	<b>142</b>
<b>Signal conditioners with SIL functional safety – MACX Analog</b>	<b>152</b>
<b>Signal conditioners with PL functional safety – MACX Safety</b>	<b>184</b>
<b>Ex i signal conditioners with SIL functional safety – MACX Analog Ex</b>	<b>188</b>
<b>Ex i signal conditioners with PL functional safety – MACX Safety Ex</b>	<b>218</b>
<b>Multiplexers for HART signals</b>	<b>222</b>
<b>Ex i 2-wire field devices</b>	<b>223</b>



## Product overview

### Highly compact signal conditioners with plug-in connection technology



MINI Analog Pro

Page 64



Accessories for MINI Analog Pro

Page 84

### Highly compact signal conditioners



MINI Analog

Page 90



Supply components, feed-through terminal blocks, marking material

Page 116

### Signal conditioners with SIL functional safety



MACX Analog

Page 152



Supply components, marking material

Page 178



System cabling, Termination Carriers

Page 182



MACX Safety

Page 184

### Ex i signal conditioners with PL functional safety



MACX Safety Ex

Page 218

### Multiplexers



Multiplexers for HART signals

Page 222

### Ex i 2-wire field devices



Ex i 2-wire field devices

Page 223

### Energy and power measurement



EMpro energy meters, function and communication modules

Page 238



AC current transducers, AC/DC, AC current protectors

Page 272

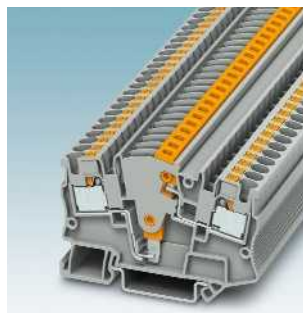

Test disconnect terminal blocks

See Catalog 3

### Monitoring and diagnostics



SOLARCHECK PV string monitoring

Page 282



EMD-BL Compact monitoring relays

Page 298

**Signal conditioners, head transducers, and process indicators**



System cabling, Termination Carriers  
Page 120



Surge protection  
Page 126



MCR Analog  
Page 128



Process indicators  
Page 140

**Ex i signal conditioners with SIL functional safety**



Configuration software  
Page 187



MACX Analog Ex  
Page 188



Supply components, marking material  
Page 213



System cabling, Termination Carriers  
Page 216

**Current measurement**



Software for usage data acquisition  
Page 244



PSK compressed air meters  
Page 246



PACT current transformers  
Page 252



PACT RCP current transformers for retrofitting  
Page 298

**Controllers**



Controllers  
See Catalog 8

**Surge protection**



Surge protection for MCR technology  
See Catalog 6



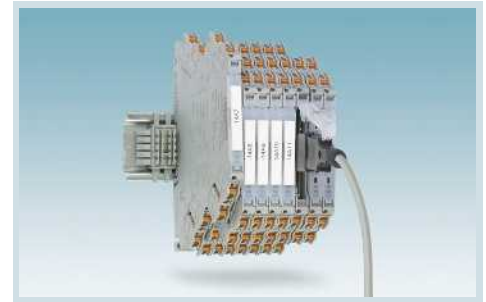

Highly compact signal conditioners - MINI Analog Pro

		Page
<b>Analog IN/Analog OUT</b>		
3-way signal conditioners	Configurable	From 68
	Fixed signal combinations	70
4-way signal duplicators	Configurable	
3-way repeater power supplies	Single-channel	71
	Signal duplicators	
	Two-channel	
2-way passive isolators	Input loop-powered	
	Output loop-powered	72
3-way output isolator	Fixed signal combinations	
Process indicators	Standard signals	
	Setpoint adjusters	
<b>Temperature</b>		
Temperature transducers	Universal	
	Universal, output loop-powered	
	For resistance thermometers (RTD)	74
	For resistance thermometers (RTD), passive	
	For Pt 100	
	For Pt 100, output loop-powered	
	For thermocouples	76
	For thermocouples, type J and K	
Temperature head transmitters	Universal, output loop-powered	
	Pt 100, output loop-powered	
<b>Frequency</b>		
Frequency transducers	Universal	
Analog frequency transducers		78
<b>Potentiometer/resistor</b>		
Potipotentiometers		80
Setpoint potentiometers		
<b>Digital IN</b>		
Signal conditioners	NAMUR sensors, floating contacts	82
	NAMUR sensors, floating contacts, 2-channel	
	NAMUR sensors on NAM	
<b>Digital OUT</b>		
Solenoid drivers	Loop-powered	
	With line fault detection	
<b>Threshold values</b>		
Threshold value switches	Standard analog signals, universal	83
	Standard analog signals	
	Temperature	
<b>Accessories</b>		
Configuration	Programming adapters	89
Constant voltage source/constant current source		84
Setpoint potentiometers		
System cabling	System adapters	
	1:1 feed-through terminal block	88
	Termination Carriers	
Multiplexers	Analog multiplexers	
	Multiplexers for HART signals	
Supply components	Power terminal/fault signaling modules/ DIN rail connector/system power supply	From 86
Marking material		89
Surge protection		
Shield fast connection		
Resistance circuit	For line fault detection	
Connector set	Screw connection or push-in connection	85

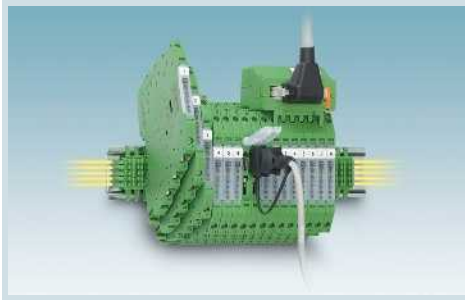

Highly compact signal conditioners - MINI Analog



Signal conditioners, head transducers, and process indicators - MCR Analog

Page	Page
From 92	
97	
98	130
99	
101	
102	
100	140
	141
	133
103	
From 104	
106	
107	
108	134
	135
109	136
110	
111	139
112	
	138
113	132
	138
89	
114	139
122	
116	
125	
123	
222	
From 116	
117	
126	
227	
180	



**Signal conditioners with SIL functional safety - MACX Analog**

		Page
<b>Analog IN/Analog OUT</b>		
3-way signal conditioners	Configurable	From 154
	Fixed signal combinations	
4-way signal duplicators	Configurable	
3-way repeater power supplies	Single-channel	158
	Signal duplicators	159
	Two-channel	161
2-way passive isolators	Input loop-powered	
	Output loop-powered	
3-way output isolators	Fixed signal combinations	162
Process indicators	Standard signals	
	Setpoint adjusters	
<b>Temperature</b>		
Temperature transducers	Universal	From 163
	Universal, output loop-powered	
	For resistance thermometers (RTD)	166
	For resistance thermometers (RTD), passive	
	For Pt 100	
	For Pt 100, output loop-powered	
	For thermocouples	168
	For thermocouples, type J and K	
Temperature head transmitters	Universal, output loop-powered	
	Pt 100, output loop-powered	
<b>Frequency</b>		
Frequency transducers	Universal	
Analog frequency transducers		
<b>Potentiometer/resistor</b>		
Potipotentiometers		From 164
Setpoint potentiometers		
<b>Digital IN</b>		
Signal conditioners	NAMUR sensors, floating contacts	172
		176
	NAMUR sensors, floating contacts, 2-channel	174
		177
	NAMUR sensors on NAM	
<b>Digital OUT</b>		
Solenoid drivers	Loop-powered	
	With line fault detection	
<b>Threshold values</b>		
Threshold value switches	Standard analog signals, universal	
	Standard analog signals	
	Temperature	163
<b>Accessories</b>		
Configuration	Configuration software	
	Programming adapter	89
	Display unit and operator interface, removable	170
	Holder module for display unit and operator interface	170
	Termination Carriers	183
Multiplexers	Analog multiplexer	
	Multiplexer for HART signals	222
Supply components	Power terminal/fault signaling modules/ DIN rail connector/system power supply	From 178
Marking material		179
Surge protection		
Shield fast connection		227
Test plugs		180
Resistance circuit	For line fault detection	180



Signal conditioners with PL functional safety - MACX Safety



Ex i signal conditioners with SIL functional safety - MACX Analog Ex



Ex i signal conditioners with PL functional safety - MACX Safety Ex

Page	Page	Page
	190	
185	190	219
	191	220
	192	
	194	
186	From 198	221
	223	
	195	
	196	
	224	
	225	
186	From 198	
	201	
	205	
	203	
	206	
	207	
	From 209	
	209	
186	200	221
89	226	89
	216	
	222	
	178	
	179	
	227	
	180	
	180	

## Input

### Maximum input signal

The maximum input signal describes the value achieved before any damage occurs to the module and the signal generator. If these values are exceeded, suppressor diodes can be triggered to short circuit this input when a surge voltage is detected. The transmission range of the analog signals is located exclusively within the specified input ranges.

### Input resistance

The input resistance of a signal conditioner or measuring transducer is determined in such a way as to ensure that the input signal is loaded only slightly. This results in a low-resistance input for current inputs and a high-resistance input for voltage inputs.

### Voltage drop

In the case of passive isolators, the input voltage drop occurs as a result of the voltage drop of the operational load and the auxiliary power consumption of the module. The greater the auxiliary power consumption of the passive isolator, the smaller the operational output load is allowed to be. Low auxiliary power consumption is regarded as an indicator of device quality.

### Common mode rejection

In the case of signal conditioners, operational amplifiers are used internally for transmission. In theory, operational amplifiers should display ideal transmission and amplification behavior. However, it is a different matter in practice. When both input voltages are changed in the same direction, i.e., exactly the same voltage to ground is applied to both input terminal blocks, this leads to an unintended output signal. Theoretically, if the operational amplifier is ideal, no output signal should appear since the differential input signal is "0 V". Common mode rejection indicates the factor (in dB) by which the common input voltage at both inputs is amplified to a lesser extent than the difference in voltage between the two inputs.

## Analog output

### Maximum output signal

During uninterrupted operation of the devices, an overload at the input cannot cause greater values than at the output.

### Zero/span adjustment

When the zero point is set, the zero point of an analog output is adjusted and set in relation to the input signal.

When the "amplification" span is set, the analog output is adjusted in relation to the input signal. In this case, the output characteristic curve is increased or decreased by an amplification factor.

### Load

The load on the output side indicates the load-carrying capacity of a measuring transducer or a signal conditioner. Current outputs can usually drive a maximum of 500  $\Omega$ , voltage outputs can be loaded with a minimum of up to 10 k $\Omega$ .

### Residual ripple/ripple

A superimposed ripple can appear on the output signal due to signal conditioning required by the circuit. The residual ripple is indicated in mV<sub>pp</sub> or mV<sub>rms</sub>.

### Open-circuit behavior

With some measuring transducers, the input signal is permanently monitored for possible open circuits in the signal line. If the signal exceeds or falls below a tolerance limit, an open circuit is detected and a defined output signal is sent. With programmable devices, the output signals can be freely selected.

## Digital output

### Relays

Many of the products with a relay output that are shown in the catalog feature hard gold-plated relay contact material. The voltage range has an important role to play in terms of how this contact material can be used. Up to 50 mA can be transmitted with voltage ranges of up to 30 V AC/36 V DC. Even very small currents are transmitted perfectly. If the afore-mentioned voltage range is exceeded and values of 250 V AC/DC are processed, currents of up to 2 A can flow. However, in this case the subsequent transmission of small currents can no longer be guaranteed.

### Transistor

A PNP transistor switching output can be used to transmit 24 V DC switching signals up to approximately 100 mA.

## General data

### Supply voltage

The product range includes DC and AC power supplies for specific products. There is a standard power supply available in the form of a 24 V DC version that operates within a voltage range of 20 ... 30 V DC. For other supply voltages, please refer to the technical data.

### Current consumption

The value specified here describes the self-consumption of the devices. It also includes the output current and, where applicable, the switching output load.

### Transmission errors

The transmission precision is a gauge of the quality of a measuring transducer. It is the deviation from the ideal transmission characteristic curve and includes linearity, span, and offset errors.

### Non-linearity

Non-linearity is the deviation from the ideal transmission precision without including span and offset errors.

The non-linearity of a signal makes it possible to evaluate the course from zero to end point. Normally, the linearity errors are expressed as a percentage that indicates the extent of deviation from the ideal transmission characteristic curve.

### Temperature coefficient

The temperature coefficient provides an assessment of the extent to which precision deviates when the ambient temperature around a signal conditioner or measuring transducer changes. In most cases this is specified as a percentage. An alternative definition is ppm/K (parts per million/Kelvin). Example: 250 ppm/K = 0.025%/K.

### Cut-off frequency

Signal conditioners are generally designed for transmitting DC signals. However, signal changes call for a dynamic form of behavior so that small AC quantities (normally: 30 Hz) can also be transmitted. This is achieved by defining a cut-off frequency. At the same time, a low cut-off frequency can be used to suppress higher-frequency AC components.

### Step response

The step response indicates the response time of the output signal when an input signal step occurs (10 ... 90%). The step response is inversely proportional to the cut-off frequency. This means that the response time decreases as the cut-off frequency increases.

### Test voltage

The test voltage indicates the electric strength of an isolated distance and is determined by type tests. In this test, a 50 Hz voltage is applied for one minute; it describes the value achieved before a disruptive discharge is able to move to another potential level in the device.

### Safe isolation

“Safe isolation” is defined as protection against hazardous shock currents. When module specifications are provided according to EN 61010, a distinction is made between error-free operation and operation under fault conditions. With error-free operation, nominal supply voltages of 30 V AC/60 V DC are valid.

### Ambient temperature range

The temperature limits specified here relate exclusively to operation. These limits do not apply to storage and transport. It is here where the temperature limits of the materials used are the decisive factor. If the devices are outside of the specified temperature range during assembly, they must be brought back within the specified temperature range prior to system startup. It is important to make sure that no condensation occurs.

### Protective circuit

In order to protect the measurement and control modules against surge voltages, suppressor diodes are connected upstream of the signal and supply paths. These diodes behave in a similar manner to conventional Zener diodes. Except for the fact that suppressor diodes have faster response times and a higher maximum current.

### Information on directives and standards

When carrying out further processing of non-independent items of equipment (components), the applicable regulations pertaining to installation must be observed.

The relevant device-specific regulations also apply with regard to installation in devices.  
(Standards applicable at the time of going to print)

Directives	EU	International
Electromagnetic Compatibility Directive (EMC)	2004/108/EC	-
Low-Voltage Directive (LVD)	2006/95/EC	-
Ex Directive (ATEX)	94/9/EC	-
<b>Product standards</b>		
Electronic equipment for use in power installations	EN 50178:1997	-
Safety requirements for electrical equipment for measurement, control, and laboratory use - Part 1: General requirements	EN 61010-1:2001	IEC 61010-1:2004
Programmable logic controllers - Part 2: Equipment requirements and tests	EN 61131-2:2007	IEC 61131-2:2007
<b>EMC</b>		
EMC - Part 6-2: Generic standards - Immunity for industrial environments	EN 61000-6-2:2005	IEC 61000-6-2:2005
EMC - Part 6-4: Generic standards - Emission standard for industrial environments	EN 61000-6-4:2007	IEC 61000-6-4:2006
Electrical equipment for measurement, control, and laboratory use EMC requirements	EN 61326-1:2006	IEC 61326-1:2005
<b>ATEX</b>		
Electrical equipment for explosive gas atmospheres - Part 0: General requirements	EN 60079-0:2006	IEC 60079-0:2007
Explosive atmospheres - Part 11: Equipment protection by intrinsic safety "i"	EN 60079-11:2007	IEC 60079-11:2006
Electrical equipment for explosive gas atmospheres - Part 15: Construction, test, and marking of protection type "n" electrical equipment	EN 60079-15:2005	IEC 60079-15:2005
<b>Environmental tests</b>		
Environmental testing - Part 2-1: Tests - Test A: Cold	EN 60068-2-1:2007	IEC 60068-2-1:2007
Environmental testing - Part 2-2: Tests - Test B: Dry heat	EN 60068-2-2:2007	IEC 60068-2-2:2007
Environmental testing - Part 2-6: Tests - Test Fc: Vibration (sinusoidal)	EN 60068-2-6:2008	IEC 60068-2-6:2008

Active isolation

3-way isolation

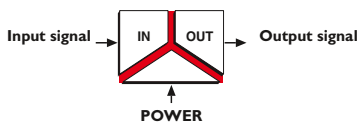

In the case of modules with this isolation method, all components that are connected to the input, output or power supply are protected against interference from each other. All three directions (input, output, and power supply) are electrically isolated from one another accordingly.

The 3-way isolation provides electrical isolation between the measurement sensor and the controller as well as between the controller and the actuating element.

On the input side, the modules need active signals. On the output side, they provide a filtered and amplified signal.

Input isolation

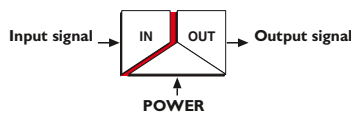

In the case of modules with this isolation method, the electronics connected on the output side (e.g., the controller) are to be protected from interference from the field. For this reason, only the input is electrically isolated from the output and the power supply which are at the same potential.

On the input side, the modules need active signals (e.g., from measurement sensors). On the output side, they provide a filtered and amplified signal (e.g., from the controller).

Repeater power supply

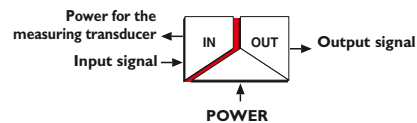

Repeater power supplies use the signal input side not only for measured value acquisition, but also to provide the necessary power to the passive measurement sensors connected on the input side.

On the output side, they provide a filtered and amplified signal (e.g., from the controller).

The isolation method used by these modules is input isolation.

Passive isolation

Passive isolation, supplied on the input side



The modules draw the power needed for signal transmission and electrical isolation from the active input circuit. On the output side, a conditioned current signal is provided to the controller or to actuating elements.

This passive isolation allows signal conditioning (interruption of ground loops) and filtering without an additional power supply.

Passive isolation, supplied on the output side (loop-powered)



The modules obtain the power needed for signal transmission and electrical isolation from the active output circuit, ideally from the PLC input board that supplies power.

On the output side, the loop-powered modules operate with a 4 ... 20 mA standard signal. On the input side, the passive isolator processes active signals.

When this isolation method is used, it is important to make sure that the active signal source connected on the output side (e.g., an active PLC input board) is able to supply the passive isolator with power, as well as operate its load.

Applications

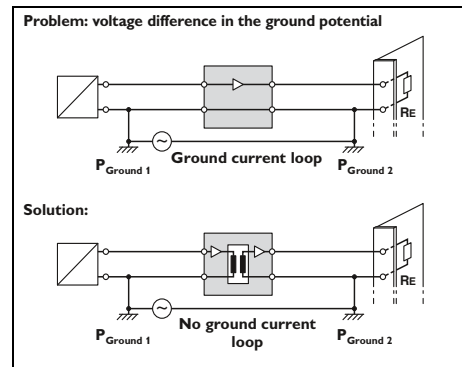
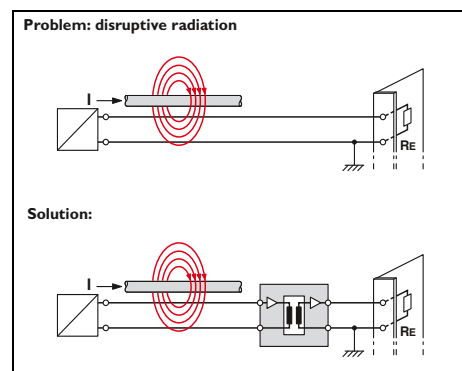



## Resistance thermometers

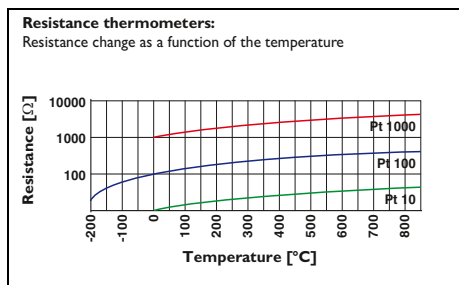

Resistance thermometers (e.g., Pt 100, Ni 1000) change their resistance value depending on the temperature. The MCR temperature transducers detect this change and convert it into a proportional analog signal.

To avoid unwanted self-heating of the sensor, the constant measured current used is kept as low as possible (MCR-T-UI... → 250  $\mu$ A).

### Two-conductor connection technology

The resistance thermometer is connected to the MCR measuring transducer using a two-core cable. Please note that the supply cable resistances are added to the measured resistance and consequently distort the result.

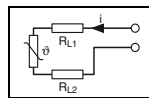

A distance of 10 m should not be exceeded.

**Example:** a 50 meter long copper cable with a cross section of 0.5 mm<sup>2</sup> has a specific resistance of 3.4  $\Omega$ . A Pt 100 sensor has a resistance change per 1 K temperature change of 0.384  $\Omega$ . This corresponds to an error of 8.8°C.

### Three-conductor connection technology

Three-conductor technology is normally used to minimize the effect of cable resistances. An additional cable is connected to the resistance thermometer, so that the latter can be measured using two measuring circuits, one of which acts as a reference. In this way, it is possible to compensate for the cable resistance.

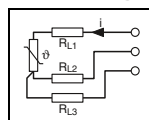

Identical cable lengths and an identical ambient temperature are essential here.

Since this is more or less the case in the majority of applications, three-wire technology is the most commonly encountered today. Line compensation is not necessary.

### Four-conductor connection technology

Four-conductor connection technology is an ideal connection technology for resistance thermometers.

The measurement result is affected neither by cable resistances nor by their temperature-dependent fluctuations. The voltage drop on the supply and return lines can therefore be measured and compensated for separately. Line compensation is not necessary.

## Thermocouples

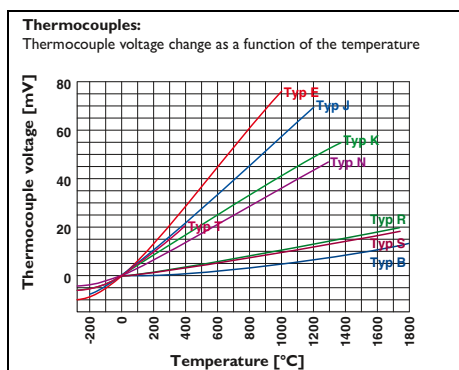

In contrast to resistance thermometers, thermocouples are active sources that generate a voltage in the microvolt range. The temperature difference measured between the measurement junction and the cold junction is converted into an absolute temperature with the help of cold junction compensation.

### Operating principle:

If different metals are joined together, a thermal voltage is produced in the metal atoms as a result of the different binding energies of the electrons. This voltage is dependent firstly on the metals themselves and secondly on the temperature.

If the same temperature prevails at the

measuring junction ( $\vartheta_1$ ) and the cold junction ( $\vartheta_2$ ), no current will flow because the generated partial voltages cancel each other out.

However, if the temperatures at the measuring junction and the cold junction are different, different voltages are produced that do not completely cancel each other out, and thus current flows.

A thermocouple thus always measures only a temperature difference. This is derived from the difference between the thermal voltages at the measuring junction and at the cold junction.

The voltage produced by the thermoelectric effect is very low; only a few microvolts per Kelvin.

**Example:** If a thermocouple type J (Fe-CuNi) is connected to a copper terminal, thermal voltages with opposite signs will be generated (at the iron-copper and copper constantan transitions) and cancel each other out.

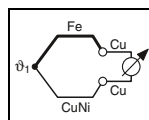

Therefore, only the difference in the thermal voltages between constantan (Cu-Ni) and iron is of relevance.

A role is also played by the temperature at the terminal point. If it is known, the temperature at the measuring junction can be derived by adding the thermal voltage measured at the same junction.

The MCR temperature transducers for thermocouples therefore detect the temperature at the terminal points and compensate this value, which is also referred to as the reference junction or the cold junction.

This process is sometimes called cold junction compensation.

## Digital displays

### Use of the freely programmable characteristic curve

The freely programmable characteristic curve, i.e., the assignment of the displayed value to the input value, is important in process applications for indicating flow rates or liquid levels.

The purpose of level measurements is very often not to determine how much liquid is still inside the tank, but rather to establish how much has been drawn out of it. In this case, the characteristic curve can simply be inverted in order to display the required value.

### Parameterization of the characteristic curve using interpolation points

With non-linear input signals, the received analog values can be assigned to the value to be displayed by means of a programmable characteristic curve. This characteristic curve can consist of up to 24 interpolation points. This allows flow sensors with a non-linear characteristic curve to be adapted, for instance. The analog signal digital displays in the Function Line additionally feature a summing function which - to take a typical example of use from bottling technology - allows you to

switch over at the touch of a button from the instantaneous value (= flow rate in l/min) to the total flow integrated in any unit. This saves space and money, because there is no need for a second digital display.

Limit values can also be called at the touch of a button. Limit values 1 and 2 can be assigned to either the actual value or the cumulative value. If the latter value is exceeded, one of the two output relays is activated.

Other applications include indicating liquid levels, pressures, and temperatures. With servo motors, the analog output signals (0 ... 10 V) generated by the tachometer can be supplied to the input of the digital display in order to indicate the motor speed.

**Application:**  
Pressure measurement and display on MCR-SL-D-U-1

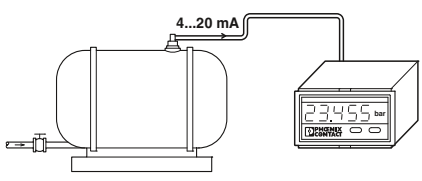
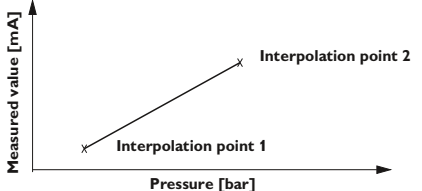

Table:	Analog signal	Display value
Interpolation point 1	4 mA	15 bar
Interpolation point 2	20 mA	30 bar

**Characteristic curve:**



## Switching behavior of relay or transistor outputs:

A different kind of switching behavior can be defined for each relay or each transistor when it reaches a preset switching point.

All the possible settings for the switching behavior are shown and explained in the list:

- The first two options include hysteresis, i.e., the behavior of the relay depends on the direction from which a switching point is reached.
- For the remaining options, with the exception of the last two ("on" and "off"), a switching tolerance is taken into account to prevent the relay contact from "chattering". The relay is not switched until the switching point plus switching tolerance has been reached.

- In the "on" state, the relay is permanently picked up. It only responds if there is an open circuit and in this case, if the relay is set to drop out when this happens.
- In the "off" state, the relay only responds if there is an open circuit and it has been set to pick up when this happens.

**Possible settings for the switching behavior**

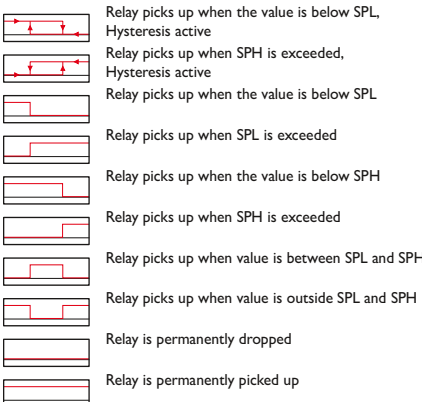

- Relay picks up when the value is below SPL. Hysteresis active
- Relay picks up when SPH is exceeded. Hysteresis active
- Relay picks up when the value is below SPL
- Relay picks up when SPL is exceeded
- Relay picks up when the value is below SPH
- Relay picks up when SPH is exceeded
- Relay picks up when value is between SPL and SPH
- Relay picks up when value is outside SPL and SPH
- Relay is permanently dropped
- Relay is permanently picked up

SPL = Set Point Low (lower switching point)  
SPH = Set Point High (upper switching point)

## Non-intrinsically safe signal transmission in potentially explosive areas

Electrical equipment operated in systems with potentially explosive areas is subject to different usage requirements, depending on the application.

For example, electrical equipment could be used in the following locations when analog signals are being transmitted:

- Sensors and actuators can be located in zone 0, zone 1 or zone 2.
- Signal transmitters can be located in zone 1, zone 2 or the safe area.
- The controller, e.g., PLC, is in the safe area.

For examples of the kinds of electrical devices that can be installed for the purpose of transmitting signals, please see the figure.

Devices must be designed to offer a suitable protection type if they are to be used in zone 2. The MINI Analog Pro, MINI Analog, and MACX Analog ranges are designed to provide protection type “n” for this purpose and must be installed in zone 2 in suitable and approved housing

(EN 60079-15 and EN 60079-0) with at least IP54 protection class.

### Example:

A sensor/actuator with protection type “n” can be connected to an isolator from the MINI Analog Pro, MINI Analog or MACX Analog ranges in zone 2.

When selecting suitable devices for zone 2, it must be ensured that the electrical data of the sensors/actuators is not exceeded.

If the sensors/actuators are mounted in explosion-proof housing or if they have their own explosion-proof housing, they can also be installed in zone 1.

### Installation requirements

The figure shows a range of options for installing electrical devices in areas with a danger of gas explosions. Special requirements regarding the configuration, selection, and installation of electrical systems in areas with a danger of gas explosions can be found in EN 60079-14.

In the 2008 edition, the relevant contents of EN 61241-14 were incorporated in EN 60079-14.

EN 61241-14 must still be observed when installing electrical equipment in areas containing combustible dust. Other important factors when it comes to running systems in potentially explosive areas are inspection, maintenance, and repairs. Stipulations regarding these matters can be found in EN 60079-17 and EN 60079-19.

### Installation of electrical devices for signal transmission

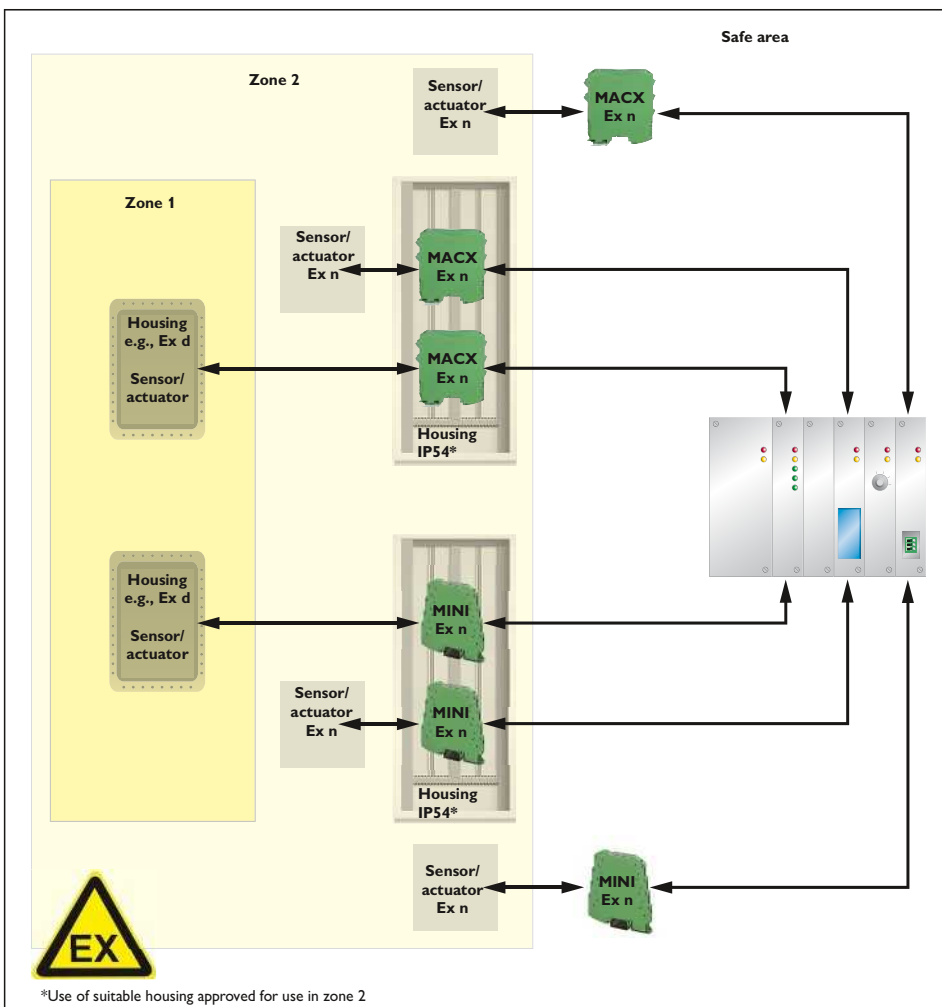

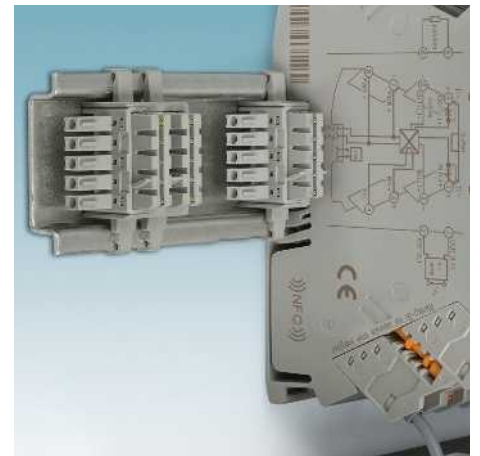
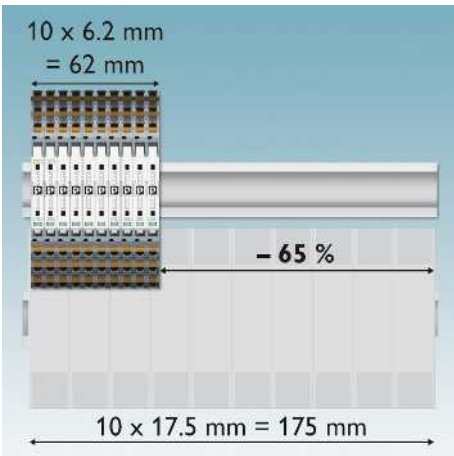
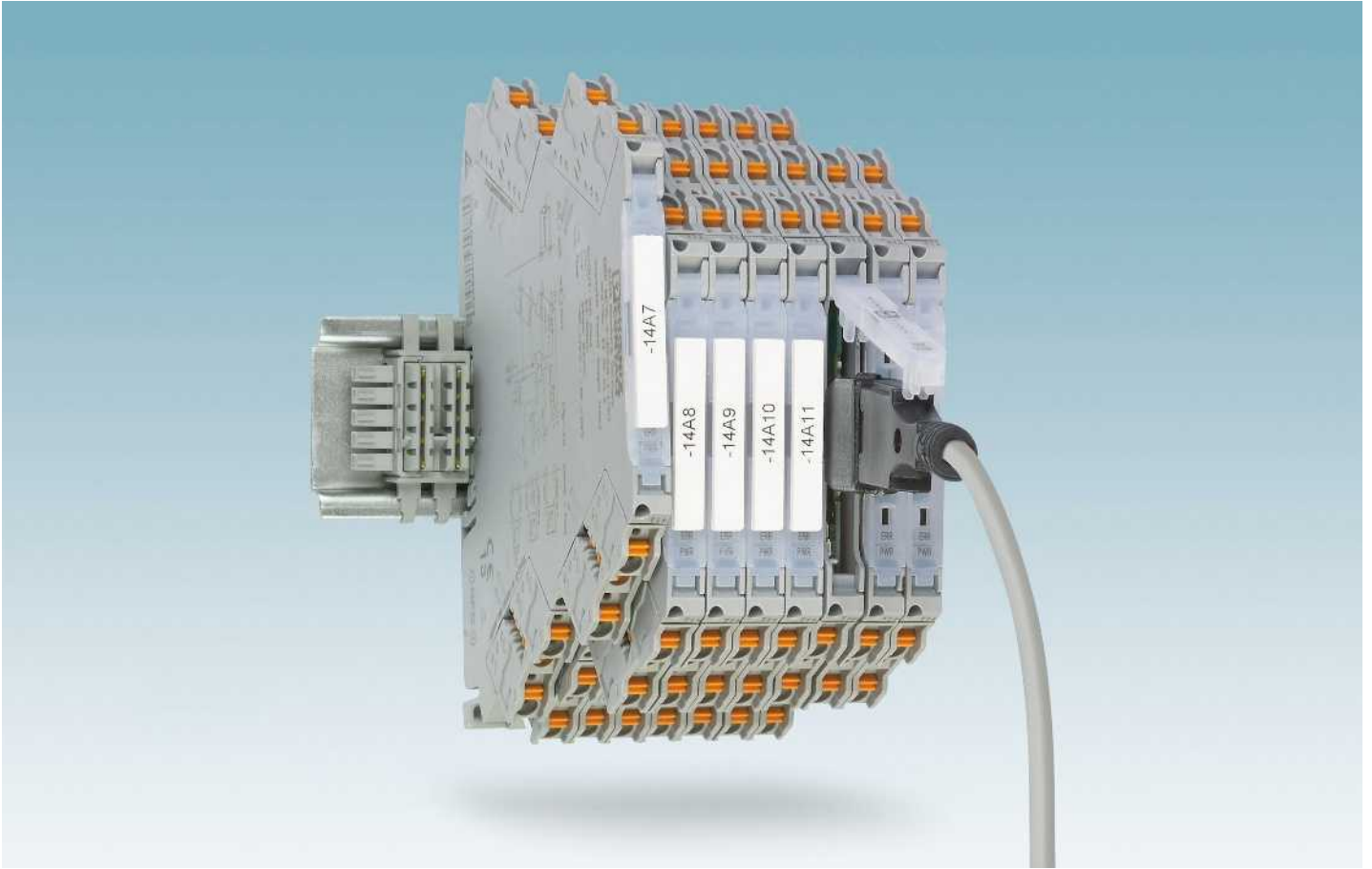

### Easier than ever but as slim as before

- MINI Analog Pro offers you the easiest installation and startup in confined spaces.
- Space savings of up to 65%

### Select from the following categories

- Analog IN/OUT
- Temperature
- Frequency
- Potentiometer
- Digital IN
- Threshold values
- Accessories

### Easy installation

- Easily visible and accessible terminal points and FASTCON Pro plug-in connection terminal blocks

### Power bridging and fault monitoring

- The DIN rail connector simplifies supply and enables group error monitoring via remote diagnostics



#### DIN rail connector-compatible

The DIN rail connector enables the modular bridging of the 24 V supply voltage.



Highly compact signal conditioners with plug-in connection technology - MINI Analog Pro

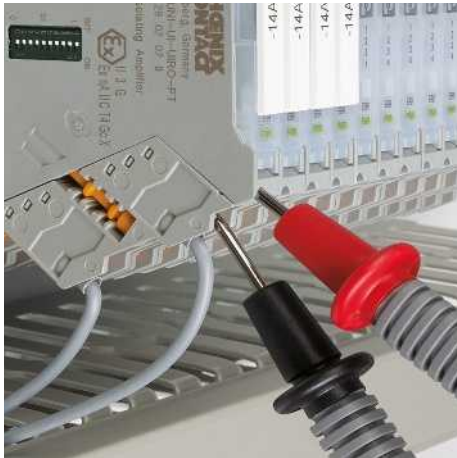

**Measure current signals during operation**

- Measure signals conveniently for startup and servicing during operation, thanks to integrated knife disconnect terminal blocks.
- The circuit does not have to be separated in order to integrate the measuring device in the signal circuit
- By setting the connector to the disconnect position, signal circuits can be easily interrupted during servicing and startup



**Numerous parameterization options**  
– Via DIP, PC or smartphone app

App functions via NFC communication



- Access to information**
- Access module information



- DIP switch setting help**
- Access module information
- Display DIP switch setting help on the smartphone



- Configuration via NFC**
- Access module information
- Display DIP switch setting help
- Wireless configuration via smartphone

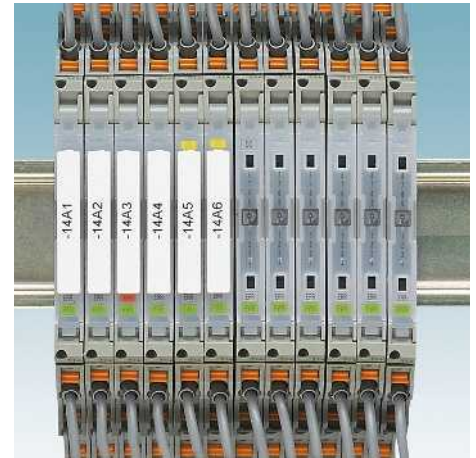

**Service-friendly**

- Large-surface marking areas for complete loop identification using standard marking material as well as constantly visible status LEDs in every module



**Choice of connection technology**

- Wiring with screw connection or fast and tool-free with push-in connection technology



**Optimum signal quality**

- The latest transmission technology and safe electrical isolation between input, output, and supply with 3 kV test voltage

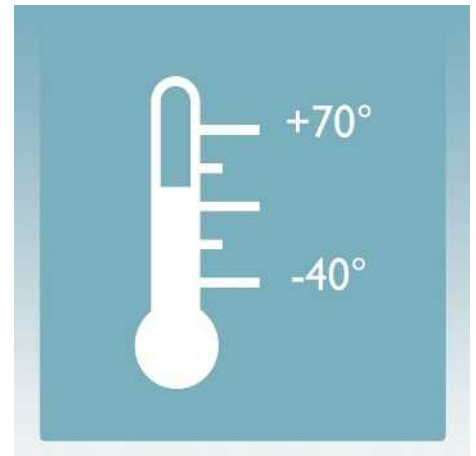

**Suitable for any application**

- Extended supply voltage and temperature range as well as multifunctional device types.

Analog IN/Analog OUT  
4-way signal conditioner

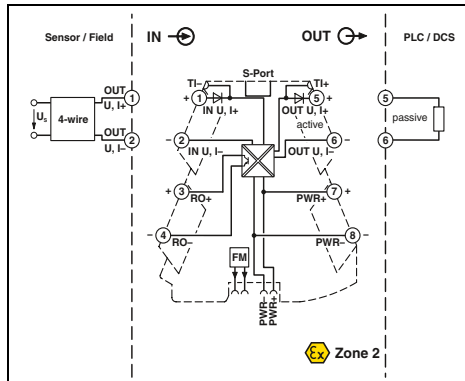
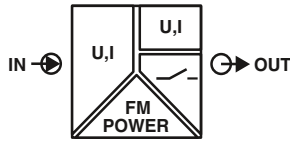

Ex n



Universal 4-way signal conditioner with switching output, configurable

Housing width 6.2 mm

- Universally configurable, highly compact signal conditioner with switching output for electrical isolation, conversion, amplification, and filtering of standard analog signals
- Plug-in connection system
- Safe 4-way isolation
- Standard signal combinations configurable via DIP switches
- Freely configurable via software or smartphone app
- Power supply and fault monitoring possible via DIN rail connector
- Limiting behavior at the output configurable
- Status and error indicator LEDs

<b>Notes:</b>
The configuration software can be downloaded from the Internet: <a href="http://phoenixcontact.net/products">phoenixcontact.net/products</a> .
Information on the programming adapters can be found on page 89
Information on MINI Analog Pro accessories can be found from page 85
To order a product with an order configuration, please enter the desired configuration by referring to the order key.

**Input data**  
Input signal (configurable via DIP switch or freely via software)

**Input resistance**  
**Output data**  
Output signal (configurable via DIP switch or freely via software)

**Maximum output signal**  
Load  $R_B$   
Ripple  
**General data**  
Supply voltage  $U_B$   
Nominal supply voltage  
Current consumption  
Power consumption

**Maximum transmission error**  
Temperature coefficient  
Step response (10-90%)

**Electrical isolation**  
Test voltage, input/output/supply  
Degree of protection  
Ambient temperature (operation)  
Mounting  
Housing material  
Dimensions W / H / D  
Push-in connection solid / stranded / AWG  
Screw connection solid / stranded / AWG  
EMC note

**Conformance / approvals**  
Conformance  
ATEX  
UL, USA / Canada

GL

**Technical data**

<b>U input</b>	<b>I input</b>
0 V ... 10 V	0 mA ... 20 mA
2 V ... 10 V	4 mA ... 20 mA
0 V ... 5 V	0 mA ... 10 mA
1 V ... 5 V	2 mA ... 10 mA
10 V ... 0 V	20 mA ... 0 mA
10 V ... 2 V	20 mA ... 4 mA
5 V ... 0 V	10 mA ... 0 mA
5 V ... 1 V	10 mA ... 2 mA
0 V ... 12 V	0 mA ... 24 mA
> 120 kΩ	approx. 50 Ω
<b>U output</b>	<b>I output</b>
0 V ... 10 V	0 mA ... 20 mA
2 V ... 10 V	4 mA ... 20 mA
0 V ... 5 V	0 mA ... 10 mA
1 V ... 5 V	2 mA ... 10 mA
0 V ... 10.5 V	0 mA ... 21 mA
approx. 12.3 V	24.6 mA
$\geq 10$ kΩ	$\leq 600$ Ω (at 20 mA)
< 20 mV <sub>PP</sub> (at 600 Ω)	< 20 mV <sub>PP</sub> (at 600 Ω)
<b>U output</b>	<b>I output</b>
9.6 V DC ... 30 V DC	
24 V DC	
32 mA (at 24 V DC)	63 mA (at 12 V DC)
	$\leq 1$ W (at $I_{OUT} = 20$ mA, 9.6 V DC, 600 Ω load)
0.1 % (of final value)	
0.01 %/K	
approx. 140 ms (15 Hz sample rate)	
approx. 45 ms (60 Hz sample rate)	
approx. 25 ms (240 Hz sample rate)	
Reinforced insulation in accordance with IEC 61010-1	
3 kV (50 Hz, 1 min.)	
IP20	
-40 °C ... 70 °C	
any	
PBT	
6.2 / 110.5 / 120.5 mm	
0.14 ... 2.5 mm <sup>2</sup> / 0.14 ... 2.5 mm <sup>2</sup> / 24 - 12	
0.2 ... 1.5 mm <sup>2</sup> / 0.2 ... 1.5 mm <sup>2</sup> / 24 - 12	
Class A product, see page 625	
<b>CE-compliant</b>	
Ex II 3 G Ex nA IIC T4 Gc X	
UL 508 Listed	
Class I, Div. 2, Groups A, B, C, D T6	
Class I, Zone 2, Group IIC T6	
GL applied for	

**Ordering data**

Type	Order No.	Pcs. / Pkt.
MINI MCR-2-UNI-UI-UIRO-PT	2902028	1
MINI MCR-2-UNI-UI-UIRO	2902026	1
MINI MCR-2-UNI-UI-UIRO-PT-C	2902027	1
MINI MCR-2-UNI-UI-UIRO-C	2902024	1

**Accessories**

IFS-USB-PROG-ADAPTER	2811271	1
NFC-USB-PROG-ADAPTER	2900013	1

**Description**

<b>4-way signal conditioner with switching output, for electrical isolation of analog signals</b>	
Standard configuration	Push-in connection
Standard configuration	Screw connection
Order configuration	Push-in connection
Order configuration	Screw connection

<b>Programming adapter</b> for configuring modules with S-PORT interface	
<b>Programming adapter</b> for configuring modules with NFC interface	

Highly compact signal conditioners with plug-in connection technology - MINI Analog Pro

Order key for MINI MCR-2-UNI-UI-UIRO(-PT)(-C) 4-way signal conditioner (standard configuration entered as an example)

Order No.	Input		Sample rate		Output		Output limitation	
	Input signal	Start	End	Output signal	Start	End		
<b>2902024</b>	<b>I</b>	<b>0.0</b>	<b>20.0</b>	<b>15</b>	<b>I</b>	<b>0.0</b>	<b>20.0</b>	<b>0</b>
2902024 ≙ MINI MCR-2- UNI-UI-UIRO-C	I ≙ I U ≙ U	0.0 ≙ 0 mA I: freely selectable between 0.0 ... 24 mA U: freely selectable between 0.0 ... 12 V	20.0 ≙ 20 mA I: freely selectable between 0.0 ... 24 mA U: freely selectable between 0.0 ... 12 V	15 ≙ 15 Hz 60 ≙ 60 Hz 240 ≙ 240 Hz	I ≙ I U ≙ U	0.0 ≙ 0 mA I: freely selectable between 0.0 ... 21 mA U: freely selectable between 0.0 ... 10.5 V	20.0 ≙ 20 mA I: freely selectable between 0.0 ... 21 mA U: freely selectable between 0.0 ... 10.5 V	0 ≙ OFF 1 ≙ ON
2902027 ≙ MINI MCR-2- UNI-UI-UIRO-PT-C								

Measuring range span at least 0.5 V/1 mA  
Increment 0.1 V/0.1 mA

Output signal span at least 0.5 V/1 mA  
Increment 0.1 V/0.1 mA

Failure information

Behavior in the event of an error

Open circuit/short circuit

Overrange

Underrange

...	<b>NE43DO</b>	<b>0.0</b>	<b>0.0</b>	<b>0.0</b>
FD ≙ freely definable	0.0 ≙ 0 mA I: freely selectable between 0.0 ... 21.5 mA U: freely selectable between 0.0 ... 11 V (free definition only for unlimited output) (signal type corresponds to selected output signal)	0.0 ≙ 0 mA I: freely selectable between 0.0 ... 21.5 mA U: freely selectable between 0.0 ... 11 V (free definition only for unlimited output) (signal type corresponds to selected output signal)	0.0 ≙ 0 mA I: freely selectable between 0.0 ... 21.5 mA U: freely selectable between 0.0 ... 11 V (free definition only for unlimited output) (signal type corresponds to selected output signal)	0.0 ≙ 0 mA I: freely selectable between 0.0 ... 21.5 mA U: freely selectable between 0.0 ... 11 V (free definition only for unlimited output) (signal type corresponds to selected output signal)
<b>Note: failure information according to NE 43 can only be selected for 4 ... 20 mA output</b>				
NE43UP ≙ NE 43 upscale NE43DO ≙ NE 43 downscale NE430 ≙ NE 43 0 mA NE43UD ≙ NE 43 upscale/downscale	21.5 mA 3.5 mA 0 mA 3.5 mA	21.5 mA 3.5 mA 0 mA 21.5 mA	21.5 mA 3.5 mA 0 mA 21.5 mA	21.5 mA 3.5 mA 0 mA 21.5 mA



**Analog IN/Analog OUT  
3-way signal conditioner**

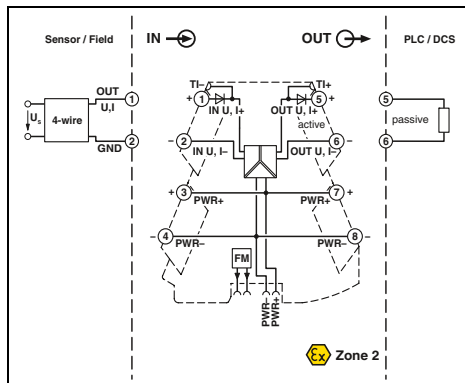
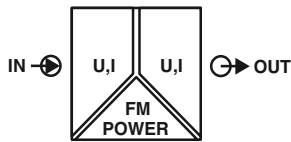

**Ex n**



**3-way signal conditioner for standard signals, configurable**



Housing width 6.2 mm

**Technical data**

**Input data**

Input signal (configurable using the DIP switch)

U input	I input
0 V ... 5 V	0 mA ... 20 mA
1 V ... 5 V	4 mA ... 20 mA
-5 V ... 5 V	-20 mA ... 20 mA
0 V ... 10 V	
2 V ... 10 V	
-10 V ... 10 V	
0 V ... 20 V	
4 V ... 20 V	
-20 V ... 20 V	
0 V ... 24 V	
4.8 V ... 24 V	
-24 V ... 24 V	
0 V ... 30 V	
6 V ... 30 V	
-30 V ... 30 V	
> 1000 kΩ	

**Output data**

Output signal (configurable using the DIP switch)

U output	I output
0 V ... 5 V	0 mA ... 20 mA
1 V ... 5 V	4 mA ... 20 mA
-5 V ... 5 V	
0 V ... 10 V	
2 V ... 10 V	
-10 V ... 10 V	

**Maximum output signal**

No-load voltage  
Short-circuit current  
Load  $R_B$   
Ripple

	approx. 63 Ω
	22 mA
	< 17 V
	< 32 mA
	≥ 10 kΩ
	≤ 600 Ω (at 20 mA)
	< 20 mV <sub>pp</sub> (at 600 Ω)
	< 20 mV <sub>pp</sub> (at 600 Ω)

**General data**

Supply voltage  $U_B$   
Nominal supply voltage  
Current consumption

U output	I output
9.6 V DC ... 30 V DC	
24 V DC	
25 mA (current output, at 24 V DC incl. load)	54 mA (current output, at 12 V DC incl. load)
	≤ 800 mW (at $I_{OUT} = 20$ mA, 9.6 V DC, 600 Ω load)

**Power consumption**

Maximum transmission error  
Temperature coefficient  
Cut-off frequency (3 dB)  
Step response (10-90%)  
Electrical isolation  
Test voltage, input/output/supply  
Degree of protection  
Ambient temperature (operation)  
Mounting  
Housing material  
Dimensions W / H / D  
Push-in connection solid / stranded / AWG  
Screw connection solid / stranded / AWG  
EMC note

≤ 0.1 % (of final value)
0.01 %/K
30 Hz (via DIP switch)
< 8.5 ms (with 30 Hz filter)
Reinforced insulation in accordance with IEC 61010-1
3 kV (50 Hz, 1 min.)
IP20
-40 °C ... 70 °C
any
PBT
6.2 / 110.5 / 120.5 mm
0.14 ... 2.5 mm <sup>2</sup> / 0.14 ... 2.5 mm <sup>2</sup> / 24 - 12
0.2 ... 1.5 mm <sup>2</sup> / 0.2 ... 1.5 mm <sup>2</sup> / 24 - 12
Class A product, see page 625

**Conformance / approvals**

Conformance  
ATEX  
UL, USA / Canada

CE-compliant
II 3 G Ex nA IIC T4 Gc X
UL 508 Listed
Class I, Div. 2, Groups A, B, C, D T6
Class I, Zone 2, Group IIC T6
GL applied for

GL

**Ordering data**

Description

**3-way signal conditioner**, for electrical isolation of analog signals

Standard configuration	Push-in connection	<b>MINI MCR-2-UI-UI-PT</b>	<b>2902040</b>	1
Standard configuration	Screw connection	<b>MINI MCR-2-UI-UI</b>	<b>2902037</b>	1
Order configuration	Push-in connection	<b>MINI MCR-2-UI-UI-PT-C</b>	<b>2902039</b>	1
Order configuration	Screw connection	<b>MINI MCR-2-UI-UI-C</b>	<b>2902036</b>	1

Type

Type	Order No.	Pcs. / Pkt.
MINI MCR-2-UI-UI-PT	2902040	1
MINI MCR-2-UI-UI	2902037	1
MINI MCR-2-UI-UI-PT-C	2902039	1
MINI MCR-2-UI-UI-C	2902036	1

## Highly compact signal conditioners with plug-in connection technology - MINI Analog Pro

Order key for MINI MCR-2-UI-UI(-PT)(-C) 3-way signal conditioner (standard configuration entered as an example)

Order No.      Input      Output      Cut-off frequency

2902036	IN03	OUT01	5K
2902036 ≙ MINI MCR-2- UI-UI-C	IN 01 ≙ 0 ... 20 mA IN 02 ≙ 4 ... 20 mA IN 03 ≙ 0 ... 10 V IN 04 ≙ 2 ... 10 V	OUT 01 ≙ 0...20 mA OUT 02 ≙ 4 ... 20 mA OUT 03 ≙ 0 ... 10 V OUT 04 ≙ 2 ... 10 V	30 Hz 5 kHz
2902039 ≙ MINI MCR-2- UI-UI-PT-C	IN 05 ≙ 0 ... 5 V IN 06 ≙ 1 ... 5 V IN 21 ≙ -5 ... 5 V IN 22 ≙ -10 ... 10 V IN 23 ≙ -20 ... 20 V IN 32 ≙ 0 ... 20 V IN 35 ≙ -20 ... 20 mA IN 38 ≙ 0 ... 24 V IN 39 ≙ 0 ... 30 V IN 80 ≙ -30 ... 30 V IN 93 ≙ -24 ... 24 V IN 94 ≙ 4.8 ... 24 V IN 95 ≙ 6 ... 30 V IN 96 ≙ 4 ... 20 V	OUT 05 ≙ 0 ... 5 V OUT 06 ≙ 1 ... 5 V OUT 13 ≙ -5 ... 5 V OUT 14 ≙ -10 ... 10 V	

Signal combination for MINI MCR-2-UI-UI(-PT)(-C) signal conditioner

Input	Output							
	0 ... 20 mA	4 ... 20 mA	0 ... 5 V	1 ... 5 V	-5 ... 5 V	0 ... 10 V	2 ... 10 V	-10 ... 10 V
0 ... 20 mA	X	X	X	X	X	X	X	X
4 ... 20 mA	X	X	X	X	X	X	X	X
-20 ... 20 mA	X	X	X	X	X	X	X	X
0 ... 5 V	X	X	X	X	X	X	X	X
1 ... 5 V	X	X	X	X	X	X	X	X
-5 ... 5 V	X	X	X	X	X	X	X	X
0 ... 10 V	X	X	X	X	X	X	X	X
2 ... 10 V	X	X	X	X	X	X	X	X
-10 ... 10 V	X	X	X	X	X	X	X	X
0 ... 20 V	X	X	X	X	X	X	X	X
4 ... 20 V	X	X	X	X	X	X	X	X
-20 ... 20 V	X	X	X	X	X	X	X	X
0 ... 24 V	X	X	X	X	X	X	X	X
4.8 ... 24 V	X	X	X	X	X	X	X	X
-24 ... 24 V	X	X	X	X	X	X	X	X
0 ... 30 V	X	X	X	X	X	X	X	X
6 ... 30 V	X	X	X	X	X	X	X	X
-30 ... 30 V	X	X	X	X	X	X	X	X

Analog IN/Analog OUT  
3-way signal conditioner

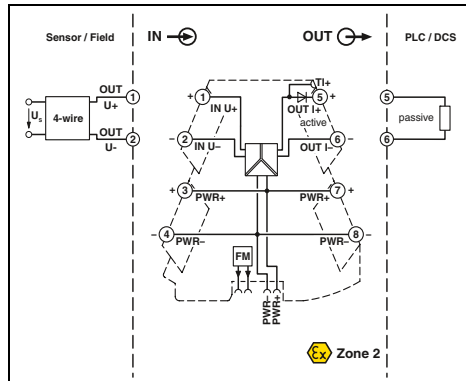
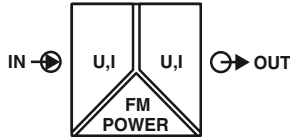

3-way signal conditioner with fixed signal combinations

- Highly compact signal conditioner for electrical isolation, conversion, amplification, and filtering of standard analog signals
- Fixed signal combinations
- Plug-in connection system
- Safe 3-way isolation
- Power supply and fault monitoring possible via DIN rail connector
- Status LED

**Notes:**  
Information on MINI Analog Pro accessories can be found from page 85

<b>Input data</b>	U input	I input
Input resistance	approx. 100 kΩ	approx. 63 Ω
<b>Output data</b>	U output	I output
Maximum output signal	11 V	22 mA
No-load voltage	< 15 mA	< 17 V
Short-circuit current	≥ 10 kΩ	≤ 600 Ω (at 20 mA)
Load R <sub>B</sub>	< 20 mV <sub>PP</sub> (at 10 kΩ)	< 20 mV <sub>PP</sub> (at 600 Ω)
Ripple		
<b>General data</b>		
Supply voltage U <sub>B</sub>	9.6 V DC ... 30 V DC	
Nominal supply voltage	24 V DC	
Typ. current consumption	25 mA (at 24 V DC)	
Maximum transmission error	0.1 % (of final value)	
Temperature coefficient	0.01 %/K	
Cut-off frequency (3 dB)	approx. 30 Hz	
Step response (10-90%)	approx. 10 ms	
Degree of protection	IP20	
Electrical isolation	Reinforced insulation in accordance with IEC 61010-1	
Test voltage, input/output/supply	3 kV (50 Hz, 1 min.)	
Ambient temperature (operation)	-40 °C ... 70 °C	
Housing material	PBT	
Dimensions W / H / D	6.2 / 110.5 / 120.5 mm	
Push-in connection solid / stranded / AWG	0.14 ... 2.5 mm <sup>2</sup> / 0.14 ... 2.5 mm <sup>2</sup> / 24 - 12	
Screw connection solid / stranded / AWG	0.2 ... 1.5 mm <sup>2</sup> / 0.2 ... 1.5 mm <sup>2</sup> / 24 - 12	
EMC note	Class A product, see page 625	
<b>Conformance / approvals</b>		
Conformance	CE-compliant	
ATEX	Ex II 3 G Ex nA IIC T4 Gc X	
UL, USA / Canada	UL 508 Listed	
	Class I, Div. 2, Groups A, B, C, D T6	
	Class I, Zone 2, Group IIC T6	
	GL applied for	
GL		

Technical data		
U input	I input	
approx. 100 kΩ	approx. 63 Ω	
U output	I output	
11 V	22 mA	
< 15 mA	< 17 V	
≥ 10 kΩ	≤ 600 Ω (at 20 mA)	
< 20 mV <sub>PP</sub> (at 10 kΩ)	< 20 mV <sub>PP</sub> (at 600 Ω)	
9.6 V DC ... 30 V DC		
24 V DC		
25 mA (at 24 V DC)		
0.1 % (of final value)		
0.01 %/K		
approx. 30 Hz		
approx. 10 ms		
IP20		
Reinforced insulation in accordance with IEC 61010-1		
3 kV (50 Hz, 1 min.)		
-40 °C ... 70 °C		
PBT		
6.2 / 110.5 / 120.5 mm		
0.14 ... 2.5 mm <sup>2</sup> / 0.14 ... 2.5 mm <sup>2</sup> / 24 - 12		
0.2 ... 1.5 mm <sup>2</sup> / 0.2 ... 1.5 mm <sup>2</sup> / 24 - 12		
Class A product, see page 625		
CE-compliant		
Ex II 3 G Ex nA IIC T4 Gc X		
UL 508 Listed		
Class I, Div. 2, Groups A, B, C, D T6		
Class I, Zone 2, Group IIC T6		
GL applied for		

Description	Input signal	Output signal
<b>3-way signal conditioner, for electrical isolation of analog signals</b>		
Push-in connection	0 ... 10 V	0 ... 20 mA
Screw connection	0 ... 10 V	0 ... 20 mA
Push-in connection	0 ... 10 V	4 ... 20 mA
Screw connection	0 ... 10 V	4 ... 20 mA
Push-in connection	0 ... 20 mA	0 ... 10 V
Screw connection	0 ... 20 mA	0 ... 10 V
Push-in connection	4 ... 20 mA	0 ... 10 V
Screw connection	4 ... 20 mA	0 ... 10 V
Push-in connection	0 ... 20 mA, 4 ... 20 mA	0 ... 20 mA, 4 ... 20 mA
Screw connection	0 ... 20 mA, 4 ... 20 mA	0 ... 20 mA, 4 ... 20 mA
Push-in connection	0 ... 10 V, 2 ... 10 V	0 ... 10 V, -10 ... 10 V
Screw connection	0 ... 10 V, 2 ... 10 V	0 ... 10 V, -10 ... 10 V

Ordering data		
Type	Order No.	Pcs. / Pkt.
MINI MCR-2-U-I0-PT	2902023	1
MINI MCR-2-U-I0	2902022	1
MINI MCR-2-U-I4-PT	2902030	1
MINI MCR-2-U-I4	2902029	1
MINI MCR-2-I0-U-PT	2902001	1
MINI MCR-2-I0-U	2902000	1
MINI MCR-2-I4-U-PT	2902003	1
MINI MCR-2-I4-U	2902002	1
MINI MCR-2-I-I-PT	2901999	1
MINI MCR-2-I-I	2901998	1
MINI MCR-2-U-U-PT	2902043	1
MINI MCR-2-U-U	2902042	1

**Analog IN/Analog OUT**  
**3-way repeater power supply**

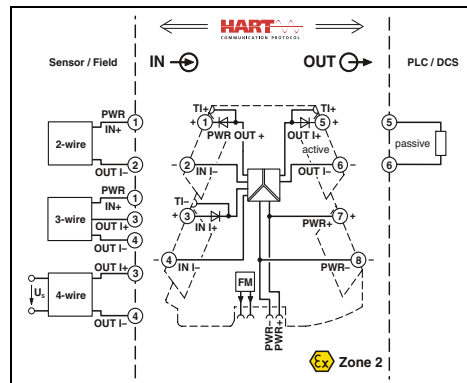
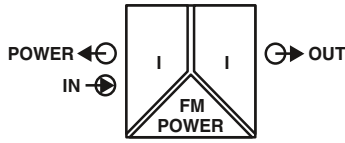

**3-way repeater power supply with HART transmission**



Ex:

Housing width 6.2 mm

- Highly compact repeater power supply for electrical isolation, conversion, amplification, and filtering of standard analog signals
- Supply of 2-wire and passive 3-wire sensors
- Can also be used as an isolator without supply
- Plug-in connection system
- Safe 3-way isolation
- Bidirectional HART transmission as an option
- Power supply and fault monitoring possible via DIN rail connector
- Status LED

**Notes:**

Information about power bridging, system cabling, and marking components can be found from page 116

**Input data**

Input signal

Input resistance  
Transmitter supply voltage

**Output data**

Output signal  
Maximum output signal  
No-load voltage  
Load  $R_B$   
Ripple

**General data**

Supply voltage  $U_B$   
Nominal supply voltage  
Current consumption  
Power consumption

Maximum transmission error

Temperature coefficient  
Cut-off frequency (3 dB)  
Communication

Step response (10-90%)

Electrical isolation  
Test voltage, input/output/supply  
Degree of protection  
Ambient temperature (operation)

Mounting  
Housing material  
Dimensions W / H / D  
Push-in connection solid / stranded / AWG  
Screw connection solid / stranded / AWG  
EMC note

**Conformance / approvals**

Conformance  
ATEX  
UL, USA / Canada

GL

**Technical data**

0 ... 20 mA, isolator operation /  
4 ... 20 mA, repeater power supply and isolator operation  
approx. 68  $\Omega$   
> 19.5 V

0 ... 20 mA / 4 ... 20 mA  
24 mA  
< 20 V  
 $\leq 600 \Omega$  (at 20 mA)  
< 20 mV<sub>PP</sub> (at 600  $\Omega$ )

9.6 V DC ... 30 V DC  
24 V DC  
25 mA (at 24 V DC and in isolator operation)  
 $\leq 1400$  mW (at  $I_{OUT} = 20$  mA, 9.6 V DC, 600  $\Omega$  load)

0.1 % (of final value)  
0.01 %/K  
> 1.75 kHz (typ.)  
HART specification in both operating modes  
(RPSS isolator / RPSS repeater power supply)  
< 200  $\mu$ s (typ.)

Reinforced insulation in accordance with IEC 61010-1  
3 kV (50 Hz, 1 min.)  
IP20  
-40 °C ... 70 °C  
any  
PBT  
6.2 / 110.5 / 120.5 mm  
0.14 ... 2.5 mm<sup>2</sup> / 0.14 ... 2.5 mm<sup>2</sup> / 24 - 12  
0.2 ... 1.5 mm<sup>2</sup> / 0.2 ... 1.5 mm<sup>2</sup> / 24 - 12  
Class A product, see page 625

CE-compliant  
 II 3 G Ex nA IIC T4 Gc X  
UL 508 Listed  
Class I, Div. 2, Groups A, B, C, D T5  
Class I, Zone 2, Group IIC T5  
GL applied for

**Ordering data**

Description

**3-way repeater power supply with HART transmission**

Push-in connection  
Screw connection

Type	Order No.	Pcs. / Pkt.
MINI MCR-2-RPSS-II-PT	2902015	1
MINI MCR-2-RPSS-I-I	2902014	1

**Analog IN/Analog OUT**  
**2-way passive isolator,**  
**output loop-powered**

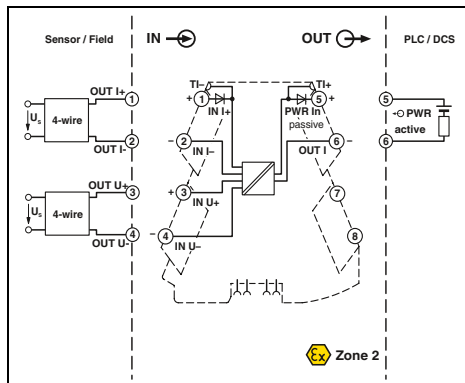
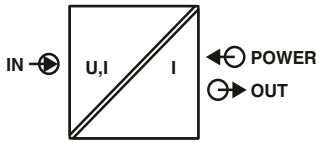

**Configurable,**  
**up to 74 signal combinations**

Housing width 6.2 mm

**Technical data**

**U input** | **I input**  
 2 ... 10 V, additional ranges can be configured, see table

< 30 V | < 40 mA  
 (electric strength up to 30 V)  
 approx. 100 kΩ (at ≤ 1 V, otherwise approximately 1 MΩ) | ≤ 50 Ω

4 ... 20 mA  
 29 mA  
 (U<sub>B</sub> - 8 V) / 22 mA  
 < 20 mV<sub>pp</sub> (at 600 Ω)

3 mA  
 < 0.1 % (of final value)  
 0.01 %/K, typ. 0.005 %/K  
 approx. 30 Hz  
 15 ms  
 Reinforced insulation in accordance with IEC 61010-1  
 3 kV (50 Hz, 1 min.)  
 IP20  
 -40 °C ... 70 °C  
 PBT  
 6.2 / 110.5 / 120.5 mm  
 0.14 ... 2.5 mm<sup>2</sup> / 0.14 ... 2.5 mm<sup>2</sup> / 24 - 12  
 0.2 ... 1.5 mm<sup>2</sup> / 0.2 ... 1.5 mm<sup>2</sup> / 24 - 12

CE-compliant  
 Ex II 3 G Ex nA IIC T4 Gc X  
 UL applied for  
 Class I, Div. 2, Groups A, B, C, D T5 applied for

- Highly compact passive isolator for electrical isolation and filtering of standard analog signals
- Safe 2-way isolation
- Supplied by an output loop
- Does not require any additional auxiliary voltage
- Up to 74 signal combinations can be configured using DIP switches
- Plug-in connection technology
- Voltage input from mV voltages up to 30 V
- Current input from 2 mA right up to 40 mA
- Status LED

**Notes:**  
 To order a product with an order configuration, please enter the desired configuration by referring to the order key.  
 Information on MINI Analog Pro accessories can be found from page 85

<b>Input data</b>	Input signal (configurable using the DIP switch)
Maximum input signal	
Input resistance	
<b>Output data</b>	Output signal
Maximum output signal	
Load R <sub>B</sub>	
Ripple	
<b>General data</b>	Current consumption
Maximum transmission error	
Temperature coefficient	
Cut-off frequency (3 dB)	
Step response (10-90%)	
Electrical isolation	
Test voltage, input/output/supply	
Degree of protection	
Ambient temperature (operation)	
Housing material	
Dimensions W / H / D	
Push-in connection solid / stranded / AWG	
Screw connection solid / stranded / AWG	
<b>Conformance / approvals</b>	Conformance
ATEX	
UL, USA / Canada	

**Ordering data**

Description	Type	Order No.	Pcs. / Pkt.
<b>Output loop-powered 2-way isolator</b> , for isolating current signals without auxiliary power			
Standard configuration Push-in connection	<b>MINI MCR-2-UI-I-OLP-PT</b>	<b>2902063</b>	1
Standard configuration Screw connection	<b>MINI MCR-2-UI-I-OLP</b>	<b>2902061</b>	1
Order configuration Push-in connection	<b>MINI MCR-2-UI-I-OLP-PT-C</b>	<b>2902062</b>	1
Order configuration Screw connection	<b>MINI MCR-2-UI-I-OLP-C</b>	<b>2902060</b>	1

**Order key for MINI MCR-2-UI-I-OLP(-PT)(-C)**

Order No.	Input	Output
<b>2602060</b>	<b>0 mV ... 1000 mV</b>	
2902060 ≙	0 mV ... 1000 mV	0 V ... 10 V
MINI MCR-2-UI-I-OLP-C	0 mV ... 750 mV	0 V ... 7.5 V
	0 mV ... 500 mV	0 V ... 5 V
	0 mV ... 300 mV	0 V ... 3 V
	0 mV ... 250 mV	0 V ... 2.5 V
	0 mV ... 200 mV	0 V ... 2 V
	0 mV ... 150 mV	0 V ... 1.5 V
	0 mV ... 125 mV	0 V ... 1.25 V
	0 mV ... 120 mV	0 V ... 1.2 V
	0 mV ... 100 mV	0 V ... 30 V
	0 mV ... 75 mV	0 V ... 25 V
	0 mV ... 60 mV	0 V ... 20 V
	0 mV ... 50 mV	0 V ... 12.5 V
		0 V ... 15 V
		0 V ... 10 V
		-1000 mV ... 1000 mV
		-750 mV ... 750 mV
		-500 mV ... 500 mV
		-300 mV ... 300 mV
		-250 mV ... 250 mV
		-200 mV ... 200 mV
		-125 mV ... 125 mV
		-120 mV ... 120 mV
		-150 mV ... 150 mV
		-100 mV ... 100 mV
		-75 mV ... 75 mV
		-60 mV ... 60 mV
		-50 mV ... 50 mV
		-10 V ... 10 V
		-7.5 V ... 7.5 V
		-5 V ... 5 V
		-3 V ... 3 V
		-2.5 V ... 2.5 V
		-2 V ... 2 V
		-1.25 V ... 1.25 V
		-1.2 V ... 1.2 V
		-1.5 V ... 1.5 V
		-30 V ... 30 V
		-25 V ... 25 V
		-20 V ... 20 V
		-12.5 V ... 12.5 V
		-12 V ... 12 V
		-15 V ... 15 V
		1 V ... 5 V
		0 mA ... 40 mA
		0 mA ... 30 mA
		0 mA ... 20 mA
		0 mA ... 12 mA
		0 mA ... 10 mA
		0 mA ... 8 mA
		0 mA ... 7.5 mA
		0 mA ... 2.5 mA
		0 mA ... 2 mA
		4 mA ... 20 mA
		2 mA ... 10 mA
		1 mA ... 5 mA



Temperature  
Temperature transducer for  
resistance thermometers

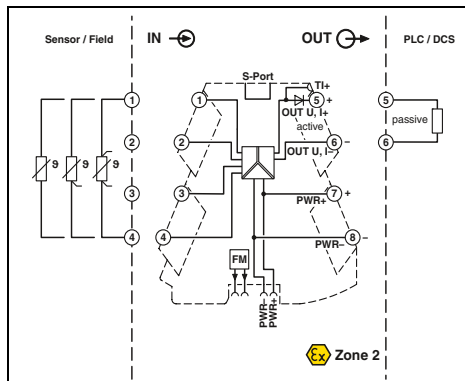
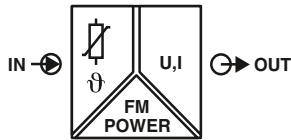

Ex n



Universal temperature transducer  
for resistance thermometers

Housing width 6.2 mm

Technical data

- Universally configurable, highly compact temperature transducer for electrical isolation, conversion, amplification, and filtering of resistance thermometer and remote resistance-type sensor signals
- For 2, 3 or 4-wire sensors according to IEC 751, JIS, GOST

- Plug-in connection system
- Safe 3-way isolation
- Standard signal combinations configurable via DIP switches
- Freely configurable via software or smartphone app
- Power supply and fault monitoring possible via DIN rail connector
- Status and error indicator LEDs

Notes:
The configuration software can be downloaded from the Internet: <a href="http://phoenixcontact.net/products">phoenixcontact.net/products</a> .
Information on the programming adapters can be found on page 89
Information on MINI Analog Pro accessories can be found from page 85
To order a product with an order configuration, please enter the desired configuration by referring to the order key.

<b>Input data</b>	Input signal (can be configured using DIP switches) Temperature range
<b>Measuring range span</b>	Linear resistance measuring range
<b>Output data</b>	Output signal (configurable via DIP switch or freely via software)
<b>Maximum output signal</b>	No-load voltage Short-circuit current Load $R_B$ Ripple
<b>General data</b>	Supply voltage $U_B$ Current consumption Power consumption
<b>Transmission error</b>	Temperature coefficient Step response (0–99%)
<b>Electrical isolation</b>	Test voltage, input/output/supply Ambient temperature (operation) Housing material Dimensions W / H / D Push-in connection solid / stranded / AWG Screw connection solid / stranded / AWG EMC note
<b>Conformance / approvals</b>	Conformance ATEX UL, USA / Canada
GL	

Pt, Ni, Cu sensors : 2, 3, 4-wire -200 °C ... 850 °C (range depends on sensor type, range can be set freely via software or in increments via DIP switches)	
≥ 20 K 0 Ω ... 4000 Ω (minimum measuring span: 10% of the selected measuring range)	
<b>U output</b> 0 ... 5 V / 1 ... 5 V	<b>I output</b> 0 ... 20 mA / 4 ... 20 mA
0 ... 10 V / 10 ... 0 V approx. 12.3 V	20 ... 0 mA / 20 ... 4 mA 24.6 mA < 17.5 V
< 31.5 mA ≥ 10 kΩ < 20 mV <sub>pp</sub>	≤ 600 Ω (at 20 mA) < 20 mV <sub>pp</sub> (at 600 Ω)
9.6 V DC ... 30 V DC 32 mA (at 24 V DC) ≤ 850 mW (at I <sub>OUT</sub> = 20 mA, 9.6 V DC, 600 Ω load)	
0.1 % * 350 K / set measuring range; 0.1 % > 350 K (Pt/Ni) 0.3 % * 200 K / set measuring range; 0.3 % > 200 K (Cu)	
0.01 %/K typ. 200 ms (2-wire) typ. 500 ms (3-wire) typ. 500 ms (4-wire) Reinforced insulation in accordance with IEC 61010-1 3 kV (50 Hz, 1 min.) -40 °C ... 70 °C PBT 6.2 / 110.5 / 120.5 mm 0.14 ... 2.5 mm <sup>2</sup> / 0.14 ... 2.5 mm <sup>2</sup> / 24 - 12 0.2 ... 1.5 mm <sup>2</sup> / 0.2 ... 1.5 mm <sup>2</sup> / 24 - 12 Class A product, see page 625	
CE-compliant Ex II 3 G Ex nA IIC T4 Gc X UL 508 Listed Class I, Div. 2, Groups A, B, C, D T6 Class I, Zone 2, Group IIC T6 GL applied for	

Ordering data

Description	Temperature transducer for resistance thermometers
Standard configuration	Push-in connection
Standard configuration	Screw connection
Order configuration	Push-in connection
Order configuration	Screw connection

Type	Order No.	Pcs. / Pkt.
MINI MCR-2-RTD-UI-PT	2902052	1
MINI MCR-2-RTD-UI	2902049	1
MINI MCR-2-RTD-UI-PT-C	2902051	1
MINI MCR-2-RTD-UI-C	2902048	1

Accessories

<b>Programming adapter</b> for configuring modules with S-PORT interface
<b>Programming adapter</b> for configuring modules with NFC interface

IFS-USB-PROG-ADAPTER	2811271	1
NFC-USB-PROG-ADAPTER	2900013	1



Highly compact signal conditioners with plug-in connection technology - MINI Analog Pro

Order key for MINI MCR-2-RTD-UI(-PT)(-C) temperature transducer (standard configuration entered as example)

Order No.	Sensor type	Connection technology	Measuring range		Measuring unit	Output		
			Start	End		Output signal	Start	End
2902048	PT100	3	-50	150	C	I	4.0	20.0
2902048 ≙ MINI MCR-2-RTD-UI-C	PT100 ≙ Pt 100 IEC 751 PT200 ≙ Pt 200 IEC 751 PT500 ≙ Pt 500 IEC 751 PT1000 ≙ Pt 1000 IEC 751 PT100G ≙ Pt 100 GOST 6651-2009 (α = 0.00394) PT1000G ≙ Pt 1000 GOST 6651-2009 (α = 0.00394) PT100J ≙ Pt 100 JIS C1604/1997 PT1000J ≙ Pt 1000 JIS C1604/1997 Ni100 ≙ Ni 100 DIN 43760 Ni1000 ≙ Ni 1000 DIN 43760 Cu50 ≙ Cu 50 GOST 6651-2009 (α = 0.00428) Cu100 ≙ Cu 100 GOST 6651-2009 (α = 0.00428) Cu53 ≙ Cu 53 GOST 6651-2009 (α = 0.00426)	2 ≙ 2-wire 3 ≙ 3-wire 4 ≙ 4-wire	freely selectable between -200°C ... 850°C (measuring range limits depend on sensor type)	freely selectable between -200°C ... 850°C (measuring range limits depend on sensor type)	C ≙ °C F ≙ °F	I ≙ I U ≙ U	0.0 ≙ 0 mA I: freely selectable between 0.0 ... 21 mA U: freely selectable between 0.0 ... 10.5 V	20.0 ≙ 20 mA I: freely selectable between 0.0 ... 21 mA U: freely selectable between 0.0 ... 10.5 V

Minimum measuring span 20 K  
Output signal span at least 0.5 V/1 mA  
Increment 0.1 V/0.1 mA

Failure information

Behavior in the event of an error

Open circuit

Short circuit

Overrange

Underrange

...	NE43DO	0.0	0.0	0.0	0.0
FD ≙ freely definable	0.0 ≙ 0 mA I: freely selectable between 0.0 ... 21.5 mA U: freely selectable between 0.0 ... 11 V (signal type corresponds to selected output signal)	0.0 ≙ 0 mA I: freely selectable between 0.0 ... 21.5 mA U: freely selectable between 0.0 ... 11 V (signal type corresponds to selected output signal)	0.0 ≙ 0 mA I: freely selectable between 0.0 ... 21.5 mA U: freely selectable between 0.0 ... 11 V (signal type corresponds to selected output signal)	0.0 ≙ 0 mA I: freely selectable between 0.0 ... 21.5 mA U: freely selectable between 0.0 ... 11 V (signal type corresponds to selected output signal)	0.0 ≙ 0 mA I: freely selectable between 0.0 ... 21.5 mA U: freely selectable between 0.0 ... 11 V (signal type corresponds to selected output signal)
<b>Note: failure information according to NE 43 can only be selected for 4 ... 20 mA output</b>					
NE43UP ≙ NE 43 upscale NE43DO ≙ NE 43 downscale NE430 ≙ NE 43 0 mA NE43UD ≙ NE 43 upscale/downscale	21.5 mA 3.5 mA 0 mA 3.5 mA	21.5 mA 3.5 mA 0 mA 3.5 mA	21.5 mA 3.5 mA 0 mA 3.5 mA	21.5 mA 3.5 mA 0 mA 21.5 mA	21.5 mA 3.5 mA 0 mA 21.5 mA

Sensor types and measuring ranges for MINI MCR-2-RTD-UI(-PT)(-C) temperature transducer

Sensor type	Standard	Measuring range	Smallest measuring span	Adjustable using:
Pt100	IEC 751 = GOST 6651-2009 (α = 0.00385)	-200°C ... +850°C	20 K	DIP switch
Pt200	IEC 751 = GOST 6651-2009 (α = 0.00385)	-200°C ... +850°C	20 K	DIP switch
Pt500	IEC 751 = GOST 6651-2009 (α = 0.00385)	-200°C ... +850°C	20 K	Software or smartphone app
Pt1000	IEC 751 = GOST 6651-2009 (α = 0.00385)	-200°C ... +850°C	20 K	Software or smartphone app
Pt100	GOST 6651-2009 (α = 0.00391)	-200°C ... +850°C	20 K	Software or smartphone app
Pt1000	GOST 6651-2009 (α = 0.00391)	-200°C ... +850°C	20 K	Software or smartphone app
Pt100	JIS C1604-1997	-200°C ... +850°C	20 K	Software or smartphone app
Pt1000	JIS C1604-1997	-200°C ... +850°C	20 K	Software or smartphone app
Ni100	DIN 43760	-60°C ... +250°C	20 K	Software or smartphone app
Ni1000	DIN 43760	-60°C ... +250°C	20 K	Software or smartphone app
Cu50	GOST 6651-2009 (α = 0.0428)	-180°C ... +200°C	20 K	Software or smartphone app
Cu100	GOST 6651-2009 (α = 0.0428)	-180°C ... +200°C	20 K	Software or smartphone app
Cu53	GOST 6651-2009 (α = 0.0426)	-50°C ... +180°C	20 K	Software or smartphone app
Customer-specific characteristic curves		-200°C ... +850°C	20 K	Software or smartphone app

Temperature  
Temperature transducer  
for thermocouples

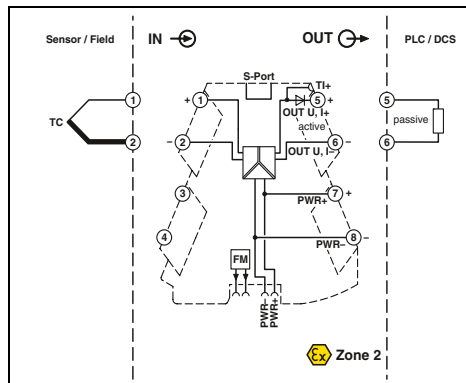
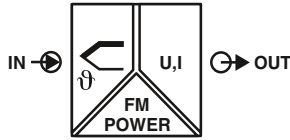

Universal temperature transducer for thermocouples

Housing width 6.2 mm

- Universally configurable, highly compact temperature transducer for electrical isolation, conversion, amplification, and filtering of thermocouple signals
- For thermocouples according to IEC 584 and GOST
- Internal cold junction compensation
- Plug-in connection system
- Safe 3-way isolation
- Standard signal combinations configurable via DIP switches
- Freely configurable via software or smartphone app
- Power supply and fault monitoring possible via DIN rail connector
- Status and error indicator LEDs

<b>Notes:</b>
The configuration software can be downloaded from the Internet: <a href="http://phoenixcontact.net/products">phoenixcontact.net/products</a> .
Information on the programming adapters can be found on page 89
Information on MINI Analog Pro accessories can be found from page 85
To order a product with an order configuration, please enter the desired configuration by referring to the order key.

<b>Input data</b>	Input signal (can be configured using DIP switches)
Temperature range	
Measuring range span	
<b>Output data</b>	Output signal (configurable via DIP switch or freely via software)
Maximum output signal	
No-load voltage	
Short-circuit current	
Load R <sub>B</sub>	
Ripple	
<b>General data</b>	
Supply voltage U <sub>B</sub>	
Current consumption	
Power consumption	
Transmission error	
Cold junction errors	
Temperature coefficient	
Step response (0-99%)	
Electrical isolation	
Test voltage, input/output/supply	
Ambient temperature (operation)	
Housing material	
Dimensions W / H / D	
Push-in connection solid / stranded / AWG	
Screw connection solid / stranded / AWG	
EMC note	
<b>Conformance / approvals</b>	
Conformance	
ATEX	
UL, USA / Canada	
GL	

<b>Technical data</b>	
B, E, J, K, N, R, S, T, L, U, A-1, A-2, A-3, M, L	
-250 °C ... 2500 °C (range depends on sensor type, range can be set freely via software or in increments via DIP switches)	
min. 50 K	
<b>U output</b>	<b>I output</b>
0 ... 5 V / 1 ... 5 V	0 ... 20 mA / 4 ... 20 mA
0 ... 10 V / 10 ... 0 V	20 ... 0 mA / 20 ... 4 mA
approx. 12.3 V	24.6 mA
	< 17.5 V
< 31.5 mA	
≥ 10 kΩ	≤ 600 Ω (at 20 mA)
< 20 mV <sub>pp</sub>	< 20 mV <sub>pp</sub> (at 600 Ω)
9.6 V DC ... 30 V DC	
32.7 mA (at 24 V DC)	
≤ 850 mW (at I <sub>OUT</sub> = 20 mA, 9.6 V DC, 600 Ω load)	
0.1 % * 600 K / set measuring range; 0.1 % > 600 K (E, J, K, N, T, L, U, M Gost, L Gost) 0.2 % * 600 K / set measuring range; 0.2 % > 600 K (B, R, S, A1, A2, A3)	
- ( typ. 2 K (2 K + (0.2 K * ΔT)) )	
≤ 0.01 %/K	
typ. 400 ms	
Reinforced insulation in accordance with IEC 61010-1	
3 kV (50 Hz, 1 min.)	
-40 °C ... 70 °C	
PBT	
6.2 / 110.5 / 120.5 mm	
0.14 ... 2.5 mm <sup>2</sup> / 0.14 ... 2.5 mm <sup>2</sup> / 24 - 12	
0.2 ... 1.5 mm <sup>2</sup> / 0.2 ... 1.5 mm <sup>2</sup> / 24 - 12	
Class A product, see page 625	
CE-compliant	
Ex II 3 G Ex nA IIC T4 Gc X	
UL 508 Listed	
Class I, Div. 2, Groups A, B, C, D T6	
Class I, Zone 2, Group IIC T6	
GL applied for	

<b>Description</b>	
<b>Temperature transducer for resistance thermometers</b>	
Standard configuration	Push-in connection
Standard configuration	Screw connection
Order configuration	Push-in connection
Order configuration	Screw connection
<b>Programming adapter for configuring modules with S-PORT interface</b>	
<b>Programming adapter for configuring modules with NFC interface</b>	

<b>Ordering data</b>		
<b>Type</b>	<b>Order No.</b>	<b>Pcs. / Pkt.</b>
MINI MCR-2-TC-UI-PT	2905249	1
MINI MCR-2-TC-UI	2902055	1
MINI MCR-2-TC-UI-PT-C	2905248	1
MINI MCR-2-TC-UI-C	2902053	1
<b>Accessories</b>		
IFS-USB-PROG-ADAPTER	2811271	1
NFC-USB-PROG-ADAPTER	2900013	1

Highly compact signal conditioners with plug-in connection technology - MINI Analog Pro

Order key for MINI MCR-2-TC-UI(-PT)(-C) temperature transducer (standard configuration entered as an example)

Order No.	Sensor type	Cold junction error compensation	Measuring range		Measuring unit	Output	Start	End	...
			Start	End					
2902048	J	1	-200	1200	C	I	4.0	20.0	/ ...
2902053 ≙ MINI MCR-2-TC-UI-C	B ≙ B IEC 584-1 (Pt30Rh-Pt6Rh) E ≙ E IEC 584-1 (NiCr-CuNi) J ≙ J IEC 584-1 (Fe-CuNi) K ≙ K IEC 584-1 (NiCr-Ni) N ≙ N IEC 584-1 (NiCrSi-NiSi) R ≙ R IEC 584-1 (Pt13Rh-Pt) S ≙ S IEC 584-1 (Pt10Rh-Pt) T ≙ T IEC 584-1 (Cu-CuNi) L ≙ L DIN 43760 (Fe-CuNi) U ≙ U DIN 43760 (Cu-CuNi) A1G ≙ A-1 GOST 8.585-2001 A2G ≙ A-2 GOST 8.585-2001 A3G ≙ A-3 GOST 8.585-2001 MG ≙ M GOST 8.585-2001 LG ≙ L GOST 8.585-2001	0 ≙ OFF 1 ≙ ON	freely selectable between -250°C ... 2500°C (measuring range limits depend on sensor type)	freely selectable between -250°C ... 2500°C (measuring range limits depend on sensor type)	C ≙ °C F ≙ °F	I ≙ I U ≙ U	0.0 ≙ 0 mA I: freely selectable between 0.0 ... 21 mA U: freely selectable between 0.0 ... 10.5 V	20.0 ≙ 20 mA I: freely selectable between 0.0 ... 21 mA U: freely selectable between 0.0 ... 10.5 V	
			Minimum measuring span 50 K		Output signal span at least 0.5 V/1 mA Increment 0.1 V/0.1 mA				

Failure information

Behavior in the event of an error

	Open circuit	Overrange	Underrange
... / NE43DO	0.0	0.0	0.0
FD ≙ freely definable	0.0 ≙ 0 mA I: freely selectable between 0.0 ... 21.5 mA U: freely selectable between 0.0 ... 11 V (signal type corresponds to selected output signal)	0.0 ≙ 0 mA I: freely selectable between 0.0 ... 21.5 mA U: freely selectable between 0.0 ... 11 V (signal type corresponds to selected output signal)	0.0 ≙ 0 mA I: freely selectable between 0.0 ... 21.5 mA U: freely selectable between 0.0 ... 11 V (signal type corresponds to selected output signal)
<b>Note: failure information according to NE 43 can only be selected for 4 ... 20 mA output</b>			
NE43UP ≙ NE 43 upscale NE43DO ≙ NE 43 downscale NE430 ≙ NE 43 0 mA NE43UD ≙ NE 43 upscale/downscale	21.5 mA 3.5 mA 0 mA 3.5 mA	21.5 mA 3.5 mA 0 mA 21.5 mA	21.5 mA 3.5 mA 0 mA 21.5 mA

Sensor types and measuring ranges for MINI MCR-2-TC-UI(-PT)(-C) temperature transducer

Sensor type	Standard	Measuring range	Smallest measuring span	Adjustable using:
B	IEC 584-1	+500°C ... +1820 °C	50 K	Software or smartphone app
E	IEC 584-1	-230°C ... +1000°C	50 K	Software or smartphone app
J	IEC 584-1	-210°C ... +1200°C	50 K	DIP switch
K	IEC 584-1	-250°C ... +1372°C	50 K	DIP switch
N	IEC 584-1	-200°C ... +1300°C	50 K	Software or smartphone app
R	IEC 584-1	-50°C ... +1768°C	50 K	Software or smartphone app
S	IEC 584-1	-50°C ... +1768°C	50 K	Software or smartphone app
T	IEC 584-1	-200°C ... +400°C	50 K	Software or smartphone app
L	DIN 43710	-200°C ... +900°C	50 K	Software or smartphone app
U	DIN 43710	-200°C ... +600°C	50 K	Software or smartphone app
A-1	GOST 8.585	0°C ... +2500°C	50 K	Software or smartphone app
A-2	GOST 8.585	0°C ... +1800°C	50 K	Software or smartphone app
A-3	GOST 8.585	0°C ... +1800°C	50 K	Software or smartphone app
M	GOST 8.585	-200°C ... +100°C	50 K	Software or smartphone app
L	GOST 8.585	-200°C ... +800°C	50 K	Software or smartphone app
Customer-specific characteristic curves		-250°C ... +2500°C	50 K	Software or smartphone app

Frequency  
Analog frequency transducer

new

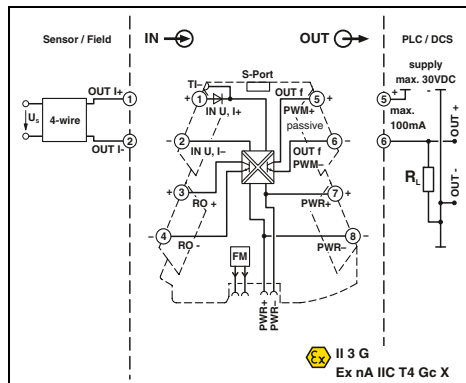
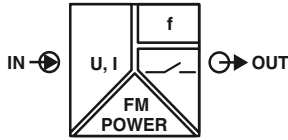

Ex n



Configurable,  
frequency, PWM or switching output

Housing width 6.2 mm

Technical data

<b>Input data</b>	Input signal (configurable via DIP switch or freely via software)
Maximum input signal	Input resistance
<b>Output data</b>	Output signal (configurable via DIP switch or freely via software)
Minimum load	Load current maximum
Maximum switching voltage	Overrange/underrange
<b>General data</b>	Supply voltage $U_B$
Nominal supply voltage	Current consumption
Power consumption	Maximum transmission error
Temperature coefficient	Step response (0–99%)
Electrical isolation	Test voltage, input/output/supply
Degree of protection	Ambient temperature (operation)
Mounting	Housing material
Dimensions W / H / D	Push-in connection solid /stranded / AWG
Screw connection solid / stranded / AWG	Conformance / approvals
Conformance	ATEX
UL, USA / Canada	GL

<b>U input</b>	<b>I input</b>
0 V ... 10 V	0 mA ... 20 mA
2 V ... 10 V	4 mA ... 20 mA
0 V ... 5 V	0 mA ... 10 mA
1 V ... 5 V	2 mA ... 10 mA
10 V ... 0 V	20 mA ... 0 mA
10 V ... 2 V	20 mA ... 4 mA
5 V ... 0 V	10 mA ... 0 mA
5 V ... 1 V	10 mA ... 2 mA
0 V ... 12 V	0 mA ... 24 mA
12 V	24 mA
> 120 kΩ	approx. 50 Ω
<b>Frequency output</b>	<b>PWM output</b>
0 Hz ... 10 kHz / 0 Hz ... 5 kHz	15.6 kHz (10 bit) / 1.9 kHz (10 bit)
0 Hz ... 2.5 kHz / 0 Hz ... 1 kHz	3.9 Hz (12 bit) / 488 Hz (12 bit)
0 Hz ... 500 Hz / 0 Hz ... 250 Hz	977 Hz (14 bit) / 122 Hz (14 bit)
0 Hz ... 100 Hz / 0 Hz ... 50 Hz	244 Hz (16 bit) / 31 Hz (16 bit)
4 mA ≤ (U <sub>L</sub> / R <sub>L</sub> ) ≤ 100 mA	12 mA ≤ (U <sub>L</sub> / R <sub>L</sub> ) ≤ 100 mA
100 mA	
30 V	
Can be set (via software)	
9.6 V DC ... 30 V DC	
24 V DC	
25 mA (12 V DC)	
12.5 mA (24 V DC)	
≤ 350 mW (9.6 V DC)	
≤ 0.1 % (> 7 kHz ≤ 0.2 %)	
< 0.01 %/K	
120 ms (15 Hz sample rate)	
Further values can be set via software	
Reinforced insulation in accordance with IEC 61010-1	
3 kV (50 Hz, 1 min.)	
IP20	
-40 °C ... 70 °C	
any	
PBT	
6.2 / 110.5 / 120.5 mm	
0.14 ... 2.5 mm <sup>2</sup> / 0.14 ... 2.5 mm <sup>2</sup> / 24 - 12	
0.2 ... 1.5 mm <sup>2</sup> / 0.2 ... 1.5 mm <sup>2</sup> / 24 - 12	
CE-compliant	
Ex II 3 G Ex nA IIC T4 Gc X	
UL applied for Class I, Div. 2, Groups A, B, C, D T5 applied for GL applied for	

- Universally configurable highly compact analog-to-frequency transducer for electrical isolation, amplification, conversion and filtering of standard analog signals to frequencies or PWM signals
- Plug-in connection technology
- Safe 3-way isolation
- Additional switching output
- Frequency output can be used as second switching output
- Standard signal combinations configurable via DIP switches
- Freely configurable via software or smartphone app
- Power supply and fault monitoring possible via DIN rail connector
- Status and error indicator LEDs

<b>Notes:</b>
The configuration software can be downloaded from the Internet: <a href="http://phoenixcontact.net/products">phoenixcontact.net/products</a> .
Information on the programming adapters can be found on page 89
Information on MINI Analog Pro accessories can be found from page 85
To order a product with an order configuration, enter the required configuration by referring to the adjacent order key.

Description	
<b>Analog frequency converter with limit value function</b>	
Standard configuration	Push-in connection
Standard configuration	Screw connection
Order configuration	Push-in connection
Order configuration	Screw connection

<b>Programming adapter</b> for configuring modules with S-PORT interface	
<b>Programming adapter</b> for configuring modules with NFC interface	

Ordering data		
Type	Order No.	Pcs. / Pkt.
MINI MCR-2-UI-FRO-PT	2902032	1
MINI MCR-2-UI-FRO	2902031	1
MINI MCR-2-UI-FRO-PT-C	2906202	1
MINI MCR-2-UI-FRO-C	2906201	1

Accessories		
IFS-USB-PROG-ADAPTER	2811271	1
NFC-USB-PROG-ADAPTER	2900013	1

Highly compact signal conditioners with plug-in connection technology - MINI Analog Pro

Order key for MINI MCR-2-UI-FRO-(PT)-(-C) measuring transducer (standard configuration entered as example)

Order No.	Input Input signal	Start		End		Sample rate	Output Output signal	Carrier frequency	Start		End		Output limitation
<b>2906201</b>	<b>I</b>	<b>0.0</b>	<b>20.0</b>	<b>15</b>	<b>I</b>	<b>0</b>	<b>0</b>	<b>1000</b>	<b>15</b>				
2906201 ≙ MINI MCR-2- UI-FRO-C	I ≙ I U ≙ U	0.0 ≙ 0 mA I: freely selectable between 0.0 ... 24 mA	20.0 ≙ 20 mA I: freely selectable between 0.0 ... 24 mA	15 Hz ≙ 15 Hz 60 Hz ≙ 60 Hz 240 Hz ≙ 240 Hz	f ≙ f	0 ≙ at frequency output	0 ≙ 0 Hz f: freely selectable between 0...10 kHz	10000 ≙ 10 kHz f: freely selectable between 0...10 kHz	0 ≙ off 1 ≙ on				
2906202 ≙ MINI MCR-2- UI-FRO-PT-C		U: freely selectable between 0.0 ... 12 V	U: freely selectable between 0.0 ... 12 V		PWM ≙ PWM	15.6 k ≙ 15.6 kHz 15.6 kHz (10 bits) 1.9 kHz (10 bits) 7.8 kHz (11 bits) 977 Hz (11 bits) 3.9 kHz (12 bits) 488 Hz (12 bits) 1.9 kHz (13 bits) 244 Hz (13 bits) 977 Hz (14 bits) 122 Hz (14 bits) 488 Hz (15 bits) 61 Hz (15 bits) 244 Hz (16 bits) 31 Hz (16 bits)	D: freely selectable between 0.0 ... 100%	D: freely selectable between 0.0 ... 100%					

Measuring range span at least 0.5 V/1 mA  
Increment 0.1 V/0.1 mA

Output signal span at least 10 Hz/1%  
Increment 1 Hz/0.1%

Failure information

Behavior in the event of an error

Open circuit/short circuit

Overrange

Underrange

...	FD	0	0	0
FD ≙ freely definable  Failure information only adjustable for unlimited output	0 ≙ 0 Hz f: freely selectable between 0 ... 11 kHz D: freely selectable between 0.0 and 100%	0 ≙ 0 Hz f: freely selectable between 0 ... 11 kHz D: freely selectable between 0.0 and 100%	0 ≙ 0 Hz f: freely selectable between 0 ... 11 kHz D: freely selectable between 0.0 and 100%	0 ≙ 0 Hz f: freely selectable between 0 ... 11 kHz D: freely selectable between 0.0 and 100%
	(free definition only for unlimited output) (signal type corresponds to selected output signal)	(free definition only for unlimited output) (signal type corresponds to selected output signal)	(free definition only for unlimited output) (signal type corresponds to selected output signal)	(free definition only for unlimited output) (signal type corresponds to selected output signal)

Potentiometer  
Potiposition transducer

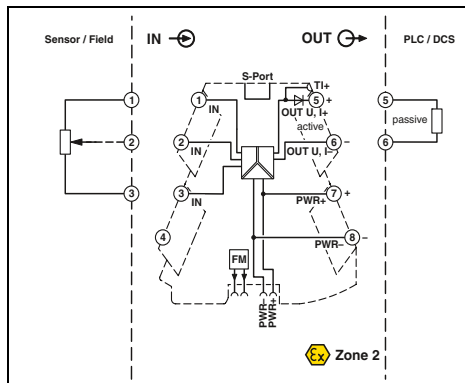
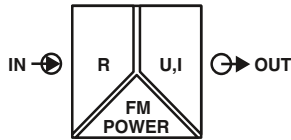

Ex n



Potiposition transducer, configurable



Housing width 6.2 mm

- Universally configurable, highly compact potiposition transducer for electrical isolation, conversion, amplification, and filtering of potentiometer signals
- For potentiometers from 100 Ω to 100 kΩ
- Automatic potentiometer detection without manual adjustment
- Plug-in connection system
- Safe 3-way isolation
- Standard signal combinations configurable via DIP switches
- Freely configurable via software or smartphone app
- Power supply and fault monitoring possible via DIN rail connector
- Status and error indicator LEDs

Notes:
The configuration software can be downloaded from the Internet: <a href="http://phoenixcontact.net/products">phoenixcontact.net/products</a> .
Information on the programming adapters can be found on page 89
Information on MINI Analog Pro accessories can be found from page 85
To order a product with an order configuration, please enter the desired configuration by referring to the order key.

<b>Input data</b>	Potentiometer
<b>Output data</b>	Output signal (configurable via DIP switch or freely via software)
Maximum output signal	No-load voltage
Short-circuit current	Load $R_B$
Ripple	Behavior in the event of a sensor error
<b>General data</b>	Supply voltage $U_B$
Nominal supply voltage	Current consumption
Power consumption	Maximum transmission error
Temperature coefficient	Step response (0-99%)
Electrical isolation	Test voltage, input/output/supply
Degree of protection	Ambient temperature (operation)
Mounting	Housing material
Dimensions W / H / D	Push-in connection solid / stranded / AWG
Screw connection solid / stranded / AWG	EMC note
<b>Conformance / approvals</b>	Conformance
ATEX	UL, USA / Canada
GL	

Technical data	
100 Ω ... 100 kΩ	I output
U output	0 ... 20 mA / 4 ... 20 mA
1 ... 5 V / 10 ... 0 V	0 ... 5 V / 0 ... 10 V
20 ... 0 mA / 20 ... 4 mA	approx. 12.3 V
24.6 mA	< 31.5 mA
< 17.5 V	$\geq 10 \text{ k}\Omega$
	< 20 mV <sub>pp</sub> (at 10 kΩ)
	configurable
	9.6 V DC ... 30 V DC
	24 V DC
	33 mA (at 24 V DC)
	$\leq 850 \text{ mW}$ (at $I_{OUT} = 20 \text{ mA}$ , 9.6 V DC, 600 Ω load)
	< 0.1 % ( $R < 240 \Omega = < 0.2 \%$ )
	0.01 %/K
	< 60 ms
	Reinforced insulation in accordance with IEC 61010-1
	3 kV (50 Hz, 1 min.)
	IP20
	-40 °C ... 70 °C
	any
	PBT
	6.2 / 110.5 / 120.5 mm
	0.14 ... 2.5 mm <sup>2</sup> / 0.14 ... 2.5 mm <sup>2</sup> / 24 - 12
	0.2 ... 1.5 mm <sup>2</sup> / 0.2 ... 1.5 mm <sup>2</sup> / 24 - 12
	Class A product, see page 625
	CE-compliant
	Ex II 3 G Ex nA IIC T4 Gc X
	UL 508 Listed
	Class I, Div. 2, Groups A, B, C, D T5
	Class I, Zone 2, Group IIC T5
	GL applied for

Description	
<b>Potiposition transducer</b>	
Standard configuration	Push-in connection
Standard configuration	Screw connection
Order configuration	Push-in connection
Order configuration	Screw connection

<b>Programming adapter</b> for configuring modules with S-PORT interface
<b>Programming adapter</b> for configuring modules with NFC interface

Ordering data		
Type	Order No.	Pcs. / Pkt.
MINI MCR-2-POT-UI-PT	2902017	1
MINI MCR-2-POT-UI	2902016	1
MINI MCR-2-POT-UI-PT-C	2905006	1
MINI MCR-2-POT-UI-C	2905005	1

Accessories		
Type	Order No.	Pcs. / Pkt.
IFS-USB-PROG-ADAPTER	2811271	1
NFC-USB-PROG-ADAPTER	2900013	1

Highly compact signal conditioners with plug-in connection technology - MINI Analog Pro

Order key for MINI MCR-2-POT-UI-(PT)-(-C) potipotentiometer transducer (standard configuration entered as an example)

Order No.	Automatic potentiometer detection	Output			Filter	Open circuit detect	...
		Output signal	Start	End			
<b>2905005</b>	<b>AUTO</b>	<b>I</b>	<b>4.0</b>	<b>20.0</b>	<b>1</b>	<b>ON</b>	
2905005 ≙ MINI MCR-2- POT-UI-C	AUTO ≙ ON OFF ≙ OFF	I ≙ I U ≙ U	0.0 ≙ 0 mA I: freely selectable between 0.0 ... 21 mA U: freely selectable between 0.0 ... 10.5 V	20.0 ≙ 20 mA I: freely selectable between 0.0 ... 21 mA U: freely selectable between 0.0 ... 10.5 V	1 2 3 4 5 6 7 8 9 10	ON ≙ ON OFF ≙ OFF	
2905006 ≙ MINI MCR-2- POT-UI-PT-C							

Output signal span at least 0.5 V/1 mA  
Increment 0.1 V/0.1 mA

Failure information

Behavior in the event of an error

Open circuit slider

Input open (no potentiometer connected)

Overrange

Underrange

...	<b>NE43DO</b>	<b>0.0</b>	<b>0.0</b>	<b>0.0</b>	<b>0.0</b>
FD ≙ freely definable	0.0 ≙ 0 mA I: freely selectable between 0.0 ... 21.5 mA U: freely selectable between 0.0 ... 11 V (only if open circuit detection is on) (signal type corresponds to selected output signal)	0.0 ≙ 0 mA I: freely selectable between 0.0 ... 21.5 mA U: freely selectable between 0.0 ... 11 V (signal type corresponds to selected output signal)	0.0 ≙ 0 mA I: freely selectable between 0.0 ... 21.5 mA U: freely selectable between 0.0 ... 11 V (signal type corresponds to selected output signal)	0.0 ≙ 0 mA I: freely selectable between 0.0 ... 21.5 mA U: freely selectable between 0.0 ... 11 V (signal type corresponds to selected output signal)	0.0 ≙ 0 mA I: freely selectable between 0.0 ... 21.5 mA U: freely selectable between 0.0 ... 11 V (signal type corresponds to selected output signal)
<b>Note: failure information according to NE 43 can only be selected for 4 ... 20 mA output</b>					
NE43UP ≙ NE 43 upscale NE43DO ≙ NE 43 downscale NE430 ≙ NE 43 0 mA NE43UD ≙ NE 43 upscale/downscale	21.5 mA 3.5 mA 0 mA 3.5 mA	21.5 mA 3.5 mA 0 mA 3.5 mA	21.5 mA 3.5 mA 0 mA 21.5 mA	21.5 mA 3.5 mA 0 mA 21.5 mA	21.5 mA 3.5 mA 0 mA 21.5 mA



Digital IN  
Signal conditioner

new

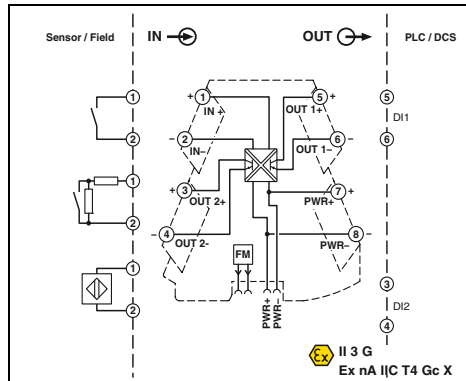
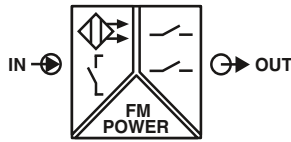

Ex n



Configurable,  
for NAMUR sensors and floating contacts

Housing width 6.2 mm

Technical data

- Highly compact signal conditioner for electrical isolation, amplification, and duplication of proximity sensor signals
- For proximity sensors in accordance with IEC 60947-5-6 and EN 50227
- Floating contacts and contacts with resistance circuit can be connected
- Plug-in connection technology
- Input and output signals can be configured via DIP switches
- Transistor switching contacts on the output
- Second output can be used as a doubler or error signaling output
- Safe 3-way isolation
- Switchover between operating current and quiescent current (inverted switching behavior)
- Power supply and fault monitoring possible via DIN rail connector
- Status LEDs

<b>Input data</b>	Input signal
<b>Control circuit</b>	No-load voltage Switching points (in acc. with IEC 60947-5-6)
<b>Line fault detection</b>	
<b>Switching output</b>	Transistor output Max. switching voltage Max. switching current Switching frequency
<b>General data</b>	Supply voltage $U_B$ Nominal supply voltage Current consumption
<b>Power consumption</b>	Electrical isolation Test voltage, input/output/supply Degree of protection Ambient temperature (operation) Mounting Housing material Dimensions W / H / D Push-in connection solid / stranded / AWG Screw connection solid / stranded / AWG
<b>Conformance / approvals</b>	Conformance ATEX UL, USA / Canada GL

NAMUR proximity sensors (EN 60947-5-6) open circuit switch contacts Switch contacts with resistance circuit
8.2 V DC $\pm 10\%$ < 1.2 mA (blocking) > 2.1 mA (conductive) > 6 mA (in the event of a short-circuit) < 0.35 mA (in the event of an open circuit)
2 N/O contacts 30 V DC 50 mA 5 kHz
9.6 V DC ... 30 V DC 24 V DC 35 mA (12 V DC) 18 mA (24 V DC) 450 mW (9.6 V DC) Reinforced insulation in accordance with IEC 61010-1 3 kV (50 Hz, 1 min.) IP20 -40 °C ... 70 °C any PBT 6.2 / 110.5 / 120.5 mm 0.14 ... 2.5 mm <sup>2</sup> / 0.14 ... 2.5 mm <sup>2</sup> / 24 - 12 0.2 ... 1.5 mm <sup>2</sup> / 0.2 ... 1.5 mm <sup>2</sup> / 24 - 12
CE-compliant Ex II 3 G Ex nA IIC T4 Gc X UL applied for Class I, Div. 2, Groups A, B, C, D T5 applied for GL applied for

**Notes:**  
Information on MINI Analog Pro accessories can be found from page 85

Ordering data

Description	Type	Order No.	Pcs. / Pkt.
NAMUR signal conditioner	Push-in connection	MINI MCR-2-NAM-2RO-PT	2902005 1
	Screw connection	MINI MCR-2-NAM-2RO	2902004 1

new

Limit values, threshold value switch

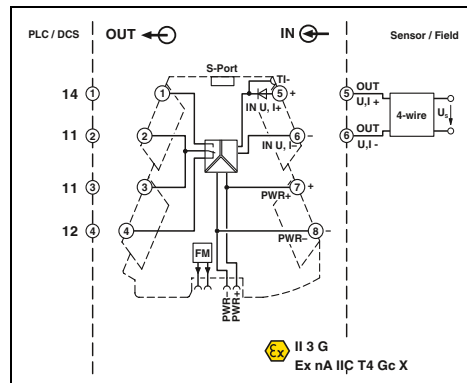
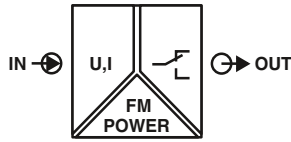

Configurable, with relay PDT output

Housing width 6.2 mm

- Universally configurable highly compact threshold value switch for switching analog limit values
- Plug-in connection technology
- Safe 3-way isolation
- Standard switching behavior can be configured via DIP switches
- Freely configurable via software or smartphone app
- PDT relay at output
- Limiting continuous current up to 6 A
- Power supply and fault monitoring possible via DIN rail connector
- Status and error indicator LEDs

**Notes:**

The configuration software can be downloaded from the Internet: <a href="http://phoenixcontact.net/products">phoenixcontact.net/products</a> .
Information on the programming adapters can be found on page 89
Information on MINI Analog Pro accessories can be found from page 85

<b>Input data</b>	Input signal (configurable using the DIP switch)
Maximum input signal	12 V
Input resistance	> 120 kΩ
Specification of the switching point	Can be set via software or in increments via DIP switches
<b>Switching output</b>	1 PDT
Relay output	AgSnO <sub>2</sub> , hard gold-plated
Contact material	250 V AC
Max. switching voltage	6 A
Limiting continuous current	can be set freely via software
Hysteresis (configurable using the DIP switch)	0 s ... 10 s (can be set freely via software)
Setting range of the response delay (configurable using the DIP switch)	
<b>General data</b>	
Supply voltage U <sub>B</sub>	9.6 V DC ... 30 V DC
Nominal supply voltage	24 V DC
Current consumption	20 mA (at 24 V DC) 40 mA (at 12 V DC)
Power consumption	≤ 0.5 W
Maximum transmission error	0.1 % (of final value)
Temperature coefficient	0.01 %/K
Step response (0-99%)	typ. 140 ms (can be set via software)
Electrical isolation	Reinforced insulation in accordance with IEC 61010-1
Test voltage, input/output/supply	3 kV (50 Hz, 1 min.)
Degree of protection	IP20
Ambient temperature (operation)	-40 °C ... 70 °C
Mounting	any
Housing material	PBT
Dimensions W / H / D	6.2 / 110.5 / 120.5 mm
Push-in connection solid / stranded / AWG	0.14 ... 2.5 mm <sup>2</sup> / 0.14 ... 2.5 mm <sup>2</sup> / 24 - 12
Screw connection solid / stranded / AWG	0.2 ... 1.5 mm <sup>2</sup> / 0.2 ... 1.5 mm <sup>2</sup> / 24 - 12
<b>Conformance / approvals</b>	
Conformance	CE-compliant
ATEX	Ex II 3 G Ex nA nC IIC T4 Gc X
UL, USA / Canada	UL applied for Class I, Div. 2, Groups A, B, C, D T5 applied for
GL	GL applied for

Technical data	
U input	I input
0 ... 10 V / 0 ... 12 V	0 ... 20 mA / 0 ... 24 mA
12 V	24 mA
> 120 kΩ	approx. 50 Ω
Can be set via software or in increments via DIP switches	

1 PDT
AgSnO <sub>2</sub> , hard gold-plated
250 V AC
6 A
can be set freely via software
0 s ... 10 s (can be set freely via software)

9.6 V DC ... 30 V DC
24 V DC
20 mA (at 24 V DC)
40 mA (at 12 V DC)
≤ 0.5 W
0.1 % (of final value)
0.01 %/K
typ. 140 ms (can be set via software)
Reinforced insulation in accordance with IEC 61010-1
3 kV (50 Hz, 1 min.)
IP20
-40 °C ... 70 °C
any
PBT
6.2 / 110.5 / 120.5 mm
0.14 ... 2.5 mm <sup>2</sup> / 0.14 ... 2.5 mm <sup>2</sup> / 24 - 12
0.2 ... 1.5 mm <sup>2</sup> / 0.2 ... 1.5 mm <sup>2</sup> / 24 - 12

CE-compliant
Ex II 3 G Ex nA nC IIC T4 Gc X
UL applied for Class I, Div. 2, Groups A, B, C, D T5 applied for
GL applied for

Description	Push-in connection	Screw connection
<b>Threshold value switch with relay PDT output</b>		

Ordering data		
Type	Order No.	Pcs. / Pkt.
MINI MCR-2-UI-REL-PT	2902035	1
MINI MCR-2-UI-REL	2902033	1

<b>Programming adapter</b> for configuring modules with S-PORT interface
<b>Programming adapter</b> for configuring modules with NFC interface

Accessories		
IFS-USB-PROG-ADAPTER	2811271	1
NFC-USB-PROG-ADAPTER	2900013	1

### Accessories

#### Constant voltage/constant current source

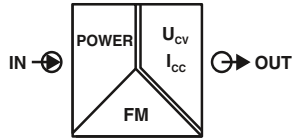

- Constant voltage/constant current source for potentiometers, measuring bridges, encoders, etc.
- Plug-in connection technology
- Highly precise
- Output signals can be configured via DIP switches
- Input signal corresponds to power supply
- Input signal and therefore energy supply and fault monitoring via the DIN rail connector
- For voltages up to 10 V and currents up to 20 mA
- Status LED

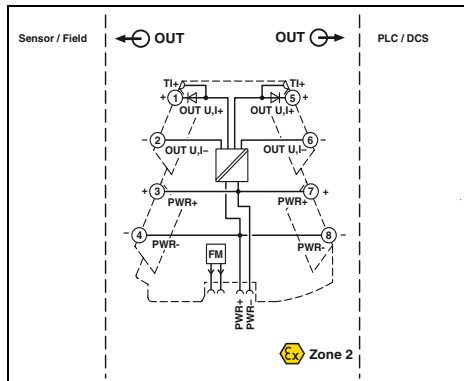

new

Output signals, configurable

Housing width 6.2 mm

#### Technical data

Input data	
Input signal	9.6 ... 30 V
Output data	
Output signal (can be configured using DIP switches)	U output 10 V DC 8.75 V DC 7.5 V DC 6.25 V DC 5 V DC 3.75 V DC 2.5 V DC 1.25 V DC
Short-circuit current	> 32 mA
Ripple	< 20 mV <sub>pp</sub> (at 600 Ω)
General data	
Supply voltage U <sub>B</sub>	9.6 V DC ... 30 V DC
Power consumption	< 1.1 W (9.6 V DC)
Maximum transmission error	≤ 0.1 % (of final value)
Temperature coefficient	< 0.01 %/K
Electrical isolation	Reinforced insulation in accordance with IEC 61010-1
Test voltage, input/output/supply	3 kV (50 Hz, 1 min.)
Degree of protection	IP20
Ambient temperature (operation)	-40 °C ... 70 °C
Housing material	PBT
Dimensions W / H / D	6.2 / 110.5 / 120.5 mm
Push-in connection solid / stranded / AWG	0.14 ... 2.5 mm <sup>2</sup> / 0.14 ... 2.5 mm <sup>2</sup> / 24 - 12
Screw connection solid / stranded / AWG	0.2 ... 1.5 mm <sup>2</sup> / 0.2 ... 1.5 mm <sup>2</sup> / 24 - 12
Conformance / approvals	
Conformance	CE-compliant
ATEX	Ex II 3 G Ex nA IIC T4 Gc X
UL, USA / Canada	UL applied for Class I, Div. 2, Groups A, B, C, D T5 applied for

U output	I output
20 mA	20 mA
17.5 mA	15 mA
15 mA	12.5 mA
12.5 mA	10 mA
10 mA	7.5 mA
7.5 mA	5 mA
5 mA	2.5 mA

Supply voltage U <sub>B</sub>	9.6 V DC ... 30 V DC
Power consumption	< 1.1 W (9.6 V DC)
Maximum transmission error	≤ 0.1 % (of final value)
Temperature coefficient	< 0.01 %/K
Electrical isolation	Reinforced insulation in accordance with IEC 61010-1
Test voltage, input/output/supply	3 kV (50 Hz, 1 min.)
Degree of protection	IP20
Ambient temperature (operation)	-40 °C ... 70 °C
Housing material	PBT
Dimensions W / H / D	6.2 / 110.5 / 120.5 mm
Push-in connection solid / stranded / AWG	0.14 ... 2.5 mm <sup>2</sup> / 0.14 ... 2.5 mm <sup>2</sup> / 24 - 12
Screw connection solid / stranded / AWG	0.2 ... 1.5 mm <sup>2</sup> / 0.2 ... 1.5 mm <sup>2</sup> / 24 - 12
Conformance / approvals	
Conformance	CE-compliant
ATEX	Ex II 3 G Ex nA IIC T4 Gc X
UL, USA / Canada	UL applied for Class I, Div. 2, Groups A, B, C, D T5 applied for

#### Ordering data

Description	
Constant voltage/constant current source	Push-in connection Screw connection

Type	Order No.	Pcs. / Pkt.
MINI MCR-2-CVCS-PT	2902065	1
MINI MCR-2-CVCS	2902064	1

#### Accessories

Setpoint potentiometer, for individual setpoint definition	
Resistance value 4.7 kΩ	
Resistance value 10 kΩ	

Accessories	Order No.	Pcs. / Pkt.
EMG 30-SP- 4K7LIN	2940252	10
EMG 30-SP-10K LIN	2942124	10

**Accessories****Screw connection connector set**

new

- FASTCON Pro connector set
- Consisting of four connectors, one each for every position on the module
- Suitable for all MINI Analog Pro modules
- Four-way coding prevents incorrect insertion into the device
- Screw connection technology



Ordering data			
Description	Type	Order No.	Pcs. / Pkt.
FASTCON Pro connector set with screw connection technology	FASTCON PRO-SET	2906227	1

**Accessories****Push-in connection connector set**

new

- FASTCON Pro connector set
- Consisting of four connectors, one each for every position on the module
- Suitable for all MINI Analog Pro modules
- Four-way coding prevents incorrect insertion into the device
- Push-in connection technology



Ordering data			
Description	Type	Order No.	Pcs. / Pkt.
FASTCON Pro connector set with push-in connection technology	FASTCON PRO-SET-PT	2906228	1

### Accessories

#### ME 6,2 TBUS... DIN rail connector

- For bridging the supply voltage
- Reduces wiring costs
- Module replacement without interrupting the supply to the remaining modules (hot swappable)
- One DIN rail connector for two MINI Analog Pro modules
- Only distinguished by color coding



For bridging the supply voltage



For bridging the supply voltage

Description
<b>DIN rail connector (TBUS)</b> , for bridging the supply voltage, can be snapped onto 35 mm DIN rails as per EN 60715, with UL approval
Color: green Color: gray

Ordering data		
Type	Order No.	Pcs. / Pkt.
ME 6,2 TBUS-2 1,5/5-ST-3,81 GN	2869728	10

Ordering data		
Type	Order No.	Pcs. / Pkt.
ME 6,2 TBUS-2 1,5/5-ST-3,81 GY	2695439	10

### Accessories

#### Power terminal

- Power terminal for supplying the supply voltage to the DIN rail connector
- Plug-in connection system
- Increased output current of 3.2 A
- For up to 115 MINI Analog Pro modules
- Monitoring of supplies in combination with the fault monitoring module
- Flexible redundant supply from one or both module sides
- Status and error indicator LEDs

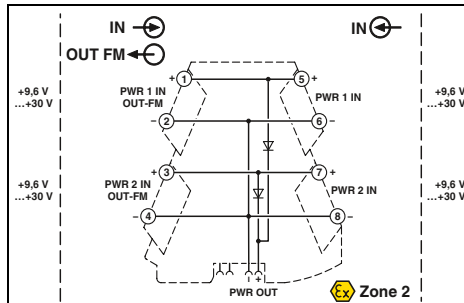

Redundant supply for existing 24 V

**Notes:**  
Observe the supply instructions for the MINI and MACX modules.

Input data/output data
Input voltage range
Output voltage
Output current
General data
Ambient temperature (operation)
Housing material
EMC note
Conformance / approvals
Conformance
ATEX
UL, USA / Canada
GL

Technical data
9.9 V DC ... 30 V DC
Input voltage - 0.3 V
≤ 3.2 A
-40 °C ... 70 °C
PBT
Class A product, see page 625
CE-compliant
Ex II 3 G Ex nA IIC T4 Gc X
UL 508 Listed
Class I, Div. 2, Groups A, B, C, D T6
Class I, Zone 2, Group IIC T6
GL applied for

Description
<b>MINI Analog Pro power terminal</b>
Push-in connection
Screw connection

Ordering data		
Type	Order No.	Pcs. / Pkt.
MINI MCR-2-PTB-PT	2902067	1
MINI MCR-2-PTB	2902066	1

## Accessories

### ME 17,5 TBUS-... DIN rail connector

- For bridging the supply voltage when using a MINI POWER system power supply

#### Notes:

If the system power supply is used, two ME 17,5 TBUS DIN rail connectors are required. This allows you to establish the connection to the ME 6,2 TBUS DIN rail connector of the MINI Analog system and provide an effective power supply.



For system power supply

Description	Ordering data		
	Type	Order No.	Pcs. / Pkt.
<p><b>DIN rail connector</b>, for bridging the supply voltage, can be snapped onto 35 mm DIN rails as per EN 60715, with UL approval, two pieces are required per system power supply</p>	ME 17,5 TBUS 1,5/ 5-ST-3,81 GN	2709561	10

## Accessories

### System power supply

- For supplying the supply voltage via the DIN rail connector where AC voltages are available
- Nominal input voltage range 100 ... 240 V AC
- 24 V DC output voltage
- For up to 60 MINI Analog modules
- For up to 1.5 A, secondary
- Status and error signaling via diagnostics LEDs



For applications with local voltages of over 100 V

Description	Ordering data		
	Type	Order No.	Pcs. / Pkt.
<p><b>System power supply</b>, primary-switched, with zone 2 approval. Further information can be found in Catalog 6, Surge protection and power supplies.</p>	MINI-PS-100-240AC/24DC/1.5/EX	2866653	1
<p><b>System power supply</b>, primary-switched (not for zone 2) Further information can be found in Catalog 6, Surge protection and power supplies.</p>	MINI-SYS-PS-100-240AC/24DC/1.5	2866983	1

### Accessories

#### Feed-through terminal block

- Feed-through terminal block for 1:1 forwarding of signals that are already electrically isolated in the MINI Analog Pro group
- Plug-in connection system

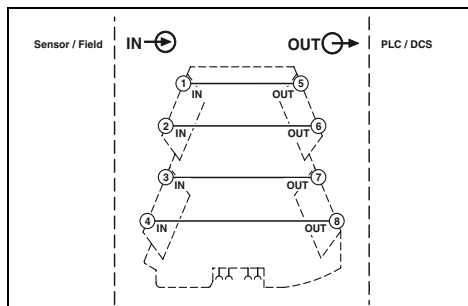

For signals already electrically isolated

General data	
Degree of protection	IP20
Ambient temperature (operation)	-40 °C ... 70 °C
Mounting	any
Housing material	PBT
Dimensions W / H / D	6.2 / 110.5 / 120.5 mm
Screw connection solid / stranded / AWG	0.2 ... 1.5 mm <sup>2</sup> / 0.2 ... 1.5 mm <sup>2</sup> / 24 - 12
Conformance / approvals	
Conformance	CE-compliant
ATEX	Ex II 3 G Ex nA IIC T4 Gc X
UL, USA / Canada	UL 508 Listed Class I, Div. 2, Groups A, B, C, D T6 Class I, Zone 2, Group IIC T6
GL	GL applied for

Technical data		
IP20		
-40 °C ... 70 °C		
any		
PBT		
6.2 / 110.5 / 120.5 mm		
0.2 ... 1.5 mm <sup>2</sup> / 0.2 ... 1.5 mm <sup>2</sup> / 24 - 12		
CE-compliant		
Ex II 3 G Ex nA IIC T4 Gc X		
UL 508 Listed		
Class I, Div. 2, Groups A, B, C, D T6		
Class I, Zone 2, Group IIC T6		
GL applied for		

Description	
<b>MINI Analog Pro feed-through terminal block</b>	
	Screw connection

Ordering data		
Type	Order No.	Pcs. / Pkt.
MINI MCR-2-TB	2902068	1

### Accessories

#### Fault signaling module

- Fault monitoring module for evaluating and reporting group errors from the fault monitoring system
- Monitoring of up to 115 connected MINI Analog Pro modules
- Plug-in connection system
- Monitoring of supply voltages of MINI MCR-2-PTB(-PT) power terminals
- Drawing off the supply is possible
- Fault signaling via an N/C contact
- Status and error indicator LEDs
- CE-compliant

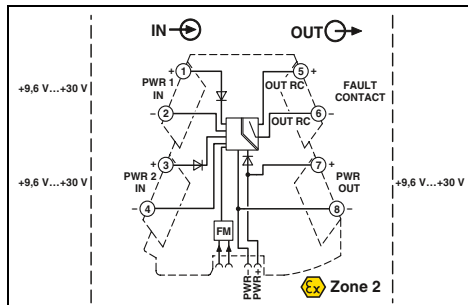

For group error indication and supply monitoring

Input data/output data	
Input signal	9.9 V DC ... 30 V DC
Output signal	9.6 V DC ... 29.7 V DC
Switching output	
Max. switching voltage	30 V DC
Max. switching current	50 mA
General data	
Test voltage input/output	1.5 kV AC (50 Hz, 1 min.)
EMC note	Class A product, see page 625
Conformance / approvals	
ATEX	Ex II 3 G Ex nA IIC T4 Gc X
UL, USA / Canada	UL 508 Listed Class I, Div. 2, Groups A, B, C, D T6 Class I, Zone 2, Group IIC T6
GL	GL applied for

Technical data		
9.9 V DC ... 30 V DC		
9.6 V DC ... 29.7 V DC		
30 V DC		
50 mA		
1.5 kV AC (50 Hz, 1 min.)		
Class A product, see page 625		
CE-compliant		
Ex II 3 G Ex nA IIC T4 Gc X		
UL 508 Listed		
Class I, Div. 2, Groups A, B, C, D T6		
Class I, Zone 2, Group IIC T6		
GL applied for		

Description	
<b>MINI Analog Pro fault signaling module</b>	
	Push-in connection
	Screw connection

Ordering data		
Type	Order No.	Pcs. / Pkt.
MINI MCR-2-FM-RC-PT	2904508	1
MINI MCR-2-FM-RC	2904504	1



Accessories

Programming adapters

IFS-USB-PROG-ADAPTER and NFC-USB-PROG-ADAPTER programmable adapters for configuring Phoenix Contact interface modules with S-PORT or NFC interface.

The adapters are used with the FDT/DTM or the ANALOG-CONF software. For programming MACX Analog, MINI Analog Pro, and MINI Analog.



General data		Technical data		
EMC note		Class A product, see page 625		
Description		Ordering data		
<b>Programming adapter</b> for configuring modules with S-PORT interface		<b>Type</b>	<b>Order No.</b>	<b>Pcs. / Pkt.</b>
<b>Programming adapter</b> for configuring modules with NFC interface		IFS-USB-PROG-ADAPTER	2811271	1
		NFC-USB-PROG-ADAPTER	2900013	1

Accessories

Marking labels for transparent cover

- Snap-in labels and adhesive labels with large area for marking
- For snapping-into or sticking onto MINI Analog Pro covers, without overlapping the status and error LEDs
- The sheets can be marked quickly and easily using the BLUEMARK CLED and the THERMOMARK CARD...
- They can also be custom printed according to customer requirements



Unmarked and marked according to customer specifications

Description		Ordering data			Ordering data		
Description	Color	Type	Order No.	Pcs. / Pkt.	Type	Order No.	Pcs. / Pkt.
<b>UniCard</b> , can be marked with THERMOMARK CARD and BLUEMARK, 24-section, 8 individual labels per strip, lettering field size: 30 x 5 mm							
Lettering field size: 30 x 5 mm	white	UCT-EM (30X5)	0801505	10			
10-section, lettering field size: 15 x 5 mm	white	UCT-EM (30X5) CUS	0801589	1			
10-section, lettering field size: 15 x 5 mm	white	UC-EMLP (15X5)	0819301	10			
	white	UC-EMLP (15X5) CUS	0824550	1			
<b>Self-adhesive marker strips</b> , unprinted, continuous, material off the roll, for marking with thermal transfer printer, can be separated using cutter, pitch as desired, strip length of up to 1000 mm, 10 strips, strip height of 5.0 mm, 1 roll = 90 m							
	white				SK 5,0 WH:REEL	0805221	1

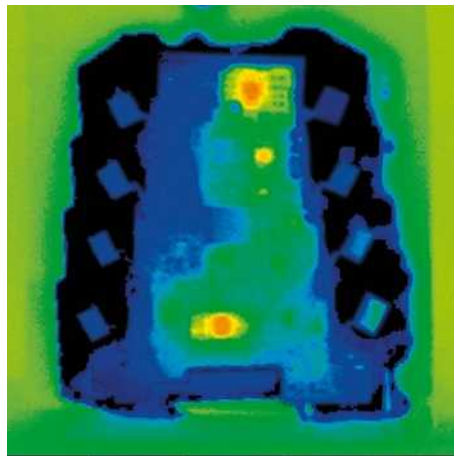
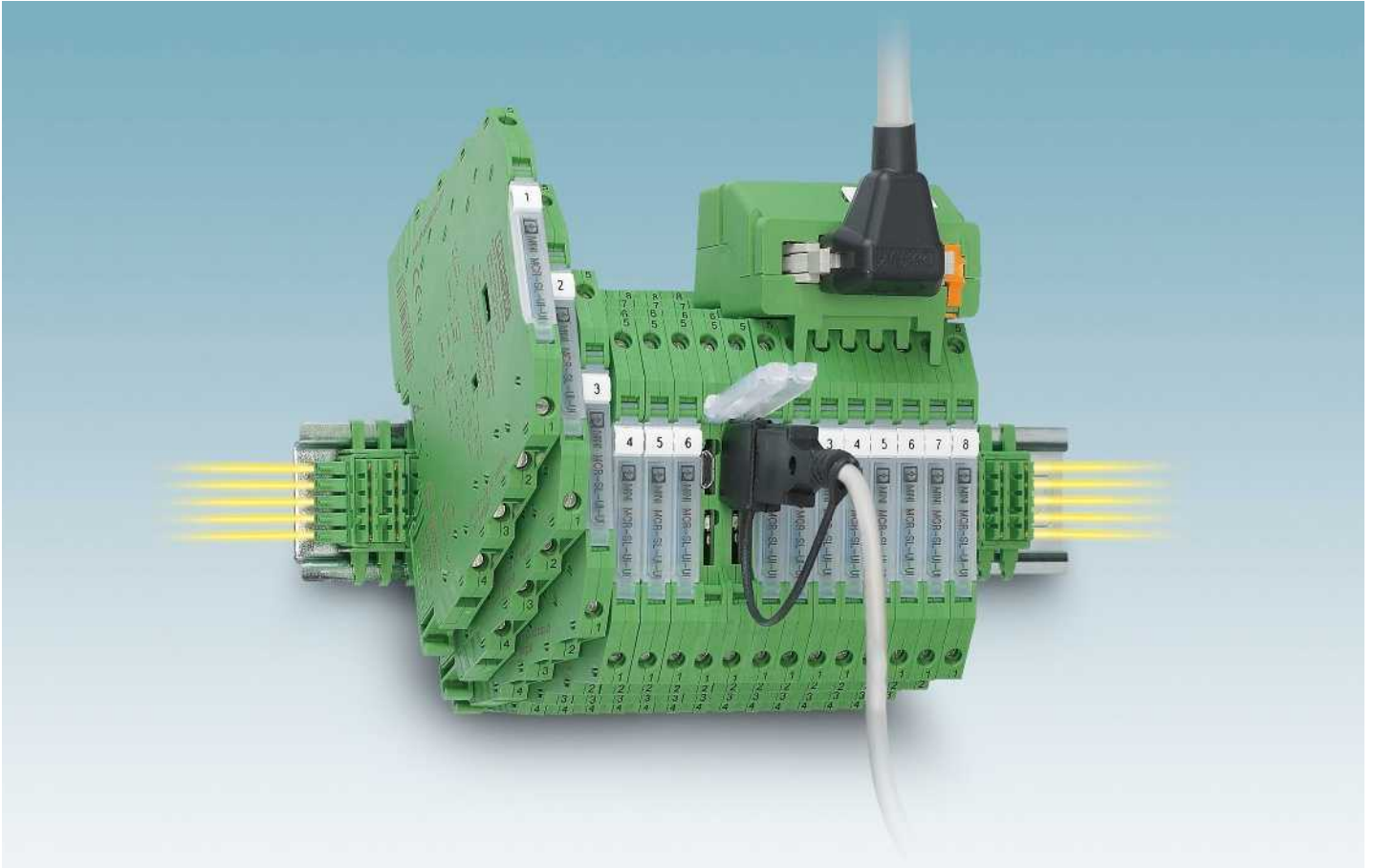

### Extremely compact and efficient

The signal conditioners from the MINI Analog range offer the full spectrum of analog signal conditioning. They are therefore extremely efficient with regard to saving costs, space, and energy.

### Choose the right MINI Analog signal conditioner for your application:

- Analog IN/OUT
- Temperature
- Frequency
- Potentiometer/resistor
- Digital IN
- Threshold values
- Accessories

### Low power consumption

- The resulting minimal self-heating ensures long service life and a high degree of operational reliability

### Clearly arranged wiring

- Eight connections with a choice of screw or spring-cage terminal blocks



**DIN rail connector-compatible**  
The DIN rail connector enables modular bridging of the 24 V supply voltage.

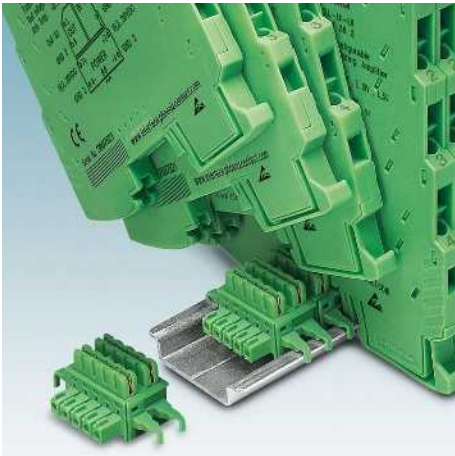

**Fault monitoring and power bridging**

– The DIN rail connector simplifies supply and enables group error monitoring



**High operational reliability**

– 3-way electrical isolation increases the operational reliability against system disturbances



**Easy configuration**

– Can be configured easily via DIP switches or software, for extended functionality and monitoring



**Reduction in analog inputs on controllers**

– The MINI Analog multiplexer reduces up to eight analog signals to a 4 ... 20 mA signal

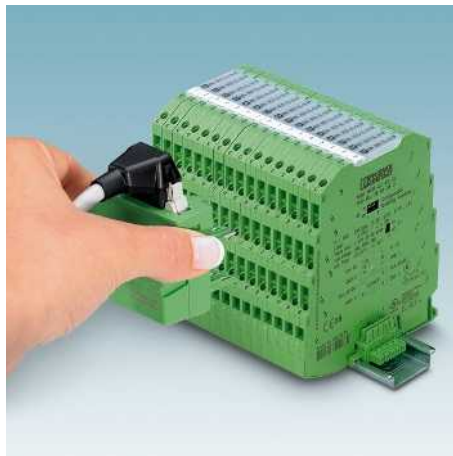

**Time-saving system cabling**

– Plug and Play – for eight channels on the signal conditioner and controller side



**Fast and error-free signal connection**

– Compact Termination Carriers connect MINI Analog devices to the automation systems – Plug and Play and hot-swappable

Analog IN/Analog OUT  
3-way signal conditioner

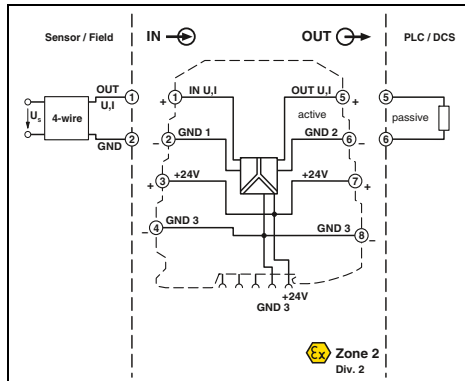
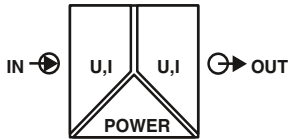

Ex n



Configurable,  
up to 36 signal combinations



Housing width 6.2 mm

- Highly compact signal conditioner for electrical isolation, conversion, amplification, and filtering of standard analog signals
- Up to 36 signal combinations can be configured using DIP switches
- 3-way isolation
- Low power consumption
- Power supply possible through the foot element (DIN rail connector)
- Standard configuration:  
0 ... 10 V input, 0 ... 20 mA output

**Notes:**  
To order a product with an order configuration, enter the required configuration by referring to the adjacent order key.  
Information about power bridging, system cabling, and marking components can be found from page 116

<b>Input data</b>	Input signal
<b>Input resistance</b>	
<b>Output data</b>	Output signal
<b>Maximum output signal</b>	No-load voltage
<b>Short-circuit current</b>	Load $R_B$
<b>Ripple</b>	
<b>General data</b>	Supply voltage $U_B$
	Nominal supply voltage
	Current consumption
<b>Power consumption</b>	
	Maximum transmission error
	Temperature coefficient
	Cut-off frequency (3 dB)
	Step response (10-90%)
	Electrical isolation
	Test voltage, input/output/supply
	Degree of protection
	Ambient temperature (operation)
	Mounting
	Housing material
	Dimensions W / H / D
	Screw connection solid / stranded / AWG
	Spring-cage connection solid / stranded / AWG
	EMC note
<b>Conformance / approvals</b>	
	Conformance
	ATEX
	UL, USA / Canada
	GL

Technical data	
<b>U input</b>	<b>I input</b>
0 ... 5 V / 1 ... 5 V	0 ... 20 mA / 4 ... 20 mA
0 ... 10 V / 2 ... 10 V	
approx. 100 k $\Omega$	approx. 50 $\Omega$
<b>U output</b>	<b>I output</b>
0 ... 5 V / 1 ... 5 V	0 ... 20 mA / 4 ... 20 mA
0 ... 10 V / 2 ... 10 V	
approx. 12.5 V	28 mA
	approx. 12.5 V
	approx. 22 mA
	$\geq 10$ k $\Omega$
	< 20 mV <sub>pp</sub> (at 10 k $\Omega$ )
	< 20 mV <sub>pp</sub> (at 500 $\Omega$ )
<b>U output</b>	<b>I output</b>
19.2 V DC ... 30 V DC	
24 V DC	
< 9 mA (voltage output, at 24 V DC incl. load)	< 19 mA (current output, at 24 V DC incl. load)
< 200 mW (voltage output)	< 450 mW (current output)
$\leq 0.1$ % (of final value)	
< 0.01 %/K, typ. < 0.002 %/K	
approx. 100 Hz	
approx. 3.2 ms	
Basic insulation according to EN 61010	
1.5 kV (50 Hz, 1 min.)	
IP20	
-20 °C ... 65 °C	
any	
PBT	
6.2 / 93.1 / 102.5 mm	
0.2 ... 2.5 mm <sup>2</sup> / 0.2 ... 2.5 mm <sup>2</sup> / 26 - 12	
0.2 ... 2.5 mm <sup>2</sup> / 0.2 ... 2.5 mm <sup>2</sup> / 24 - 12	
Class A product, see page 625	
CE-compliant	
Ex II 3 G Ex nA IIC T4 Gc X	
UL 508 Recognized	
Class I, Div. 2, Groups A, B, C, D T5	
GL EMC 2 D	

Description	
<b>MCR 3-way signal conditioner</b> , for electrical isolation of analog signals	
Order configuration	Screw connection
Order configuration	Spring-cage connection
Standard configuration	Screw connection
Standard configuration	Spring-cage connection

Ordering data		
Type	Order No.	Pcs. / Pkt.
MINI MCR-SL-UI-UI	2864383	1
MINI MCR-SL-UI-UI-SP	2864710	1
MINI MCR-SL-UI-UI-NC	2864150	1
MINI MCR-SL-UI-UI-SP-NC	2864163	1

Order key MINI MCR-SL-UI-UI(-SP) (standard configuration entered as an example)

Order No.	Input	Output	Factory calibration certificate (FCC)
<b>2864383</b>	<b>IN03</b>	<b>OUT01</b>	<b>NONE</b>
2864383 ≙ MINI MCR-SL-UI-UI	IN01 ≙ 0 ... 20 mA IN02 ≙ 4 ... 20 mA IN03 ≙ 0 ... 10 V IN04 ≙ 2 ... 10 V IN05 ≙ 0 ... 5 V IN06 ≙ 1 ... 5 V	OUT01 ≙ 0 ... 20 mA OUT02 ≙ 4 ... 20 mA OUT03 ≙ 0 ... 10 V OUT04 ≙ 2 ... 10 V OUT05 ≙ 0 ... 5 V OUT06 ≙ 1 ... 5 V	NONE ≙ without FCC Yes ≙ with FCC (a fee is charged)  YESPLUS ≙ FCC with 5 measuring points (a fee is charged)

Configuration table for input and output signals

Input	Output	DIP switch SW 2						DIP switch SW 1	
		DIP 1	DIP 2	DIP 3	DIP 4	DIP 5	DIP 6	DIP 1	DIP 2
0 - 10 V	0 - 20 mA	OFF	OFF	OFF	OFF	OFF	OFF	OFF	OFF
	4 - 20 mA	OFF	OFF	OFF	OFF	OFF	ON	OFF	OFF
	0 - 10 V	ON	OFF	ON	OFF	OFF	OFF	OFF	OFF
	2 - 10 V	ON	OFF	ON	OFF	OFF	ON	OFF	OFF
	0 - 5 V	ON	ON	OFF	OFF	OFF	OFF	OFF	OFF
2 - 10 V	1 - 5 V	ON	ON	OFF	OFF	OFF	ON	OFF	OFF
	0 - 20 mA	OFF	OFF	OFF	ON	ON	OFF	OFF	OFF
	4 - 20 mA	OFF	OFF	OFF	OFF	OFF	OFF	OFF	OFF
	0 - 10 V	ON	OFF	ON	ON	ON	OFF	OFF	OFF
	2 - 10 V	ON	OFF	ON	OFF	OFF	OFF	OFF	OFF
0 - 5 V	0 - 5 V	ON	ON	OFF	ON	ON	OFF	OFF	OFF
	1 - 5 V	ON	ON	OFF	OFF	OFF	OFF	OFF	OFF
	0 - 20 mA	OFF	OFF	OFF	OFF	OFF	OFF	ON	OFF
	4 - 20 mA	OFF	OFF	OFF	OFF	OFF	ON	ON	OFF
	0 - 10 V	ON	OFF	ON	OFF	OFF	OFF	ON	OFF
1 - 5 V	2 - 10 V	ON	OFF	ON	OFF	OFF	OFF	ON	OFF
	0 - 5 V	ON	ON	OFF	ON	ON	OFF	ON	OFF
	1 - 5 V	ON	ON	OFF	OFF	OFF	OFF	ON	OFF
	0 - 20 mA	OFF	OFF	OFF	ON	ON	OFF	ON	OFF
	4 - 20 mA	OFF	OFF	OFF	OFF	OFF	OFF	ON	OFF
0 - 20 mA	0 - 10 V	ON	OFF	ON	ON	ON	OFF	OFF	ON
	2 - 10 V	ON	OFF	ON	OFF	OFF	ON	OFF	ON
	0 - 5 V	ON	ON	OFF	OFF	OFF	OFF	OFF	ON
	1 - 5 V	ON	ON	OFF	OFF	OFF	ON	OFF	ON
	4 - 20 mA	OFF	OFF	OFF	ON	ON	OFF	OFF	ON
4 - 20 mA	4 - 20 mA	OFF	OFF	OFF	OFF	OFF	OFF	OFF	ON
	0 - 10 V	ON	OFF	ON	ON	ON	OFF	OFF	ON
	2 - 10 V	ON	OFF	ON	OFF	OFF	OFF	OFF	ON
	0 - 5 V	ON	ON	OFF	ON	ON	OFF	OFF	ON
	1 - 5 V	ON	ON	OFF	OFF	OFF	OFF	OFF	ON

Application example: level measurement

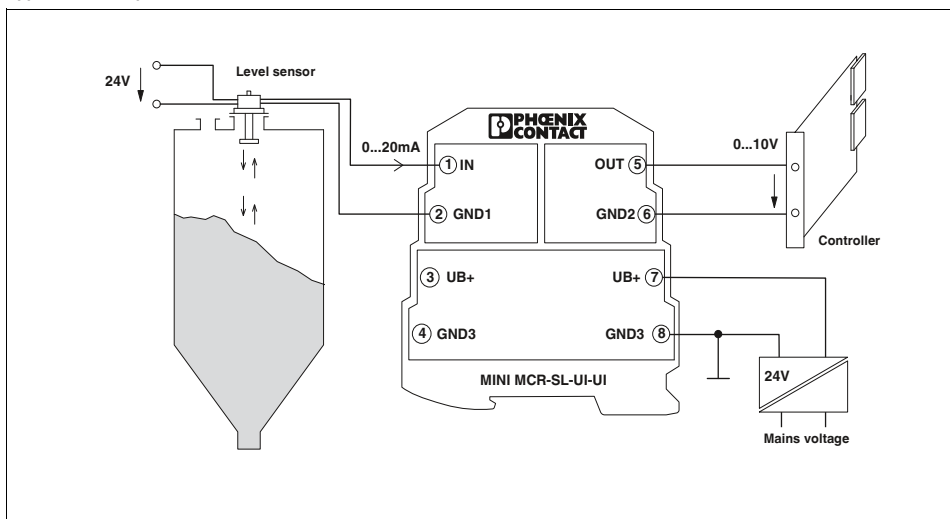



Analog IN/Analog OUT  
3-way signal conditioner

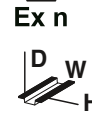
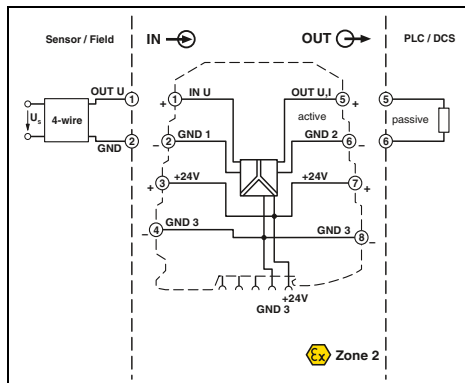
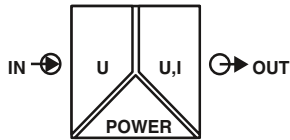

Configurable, for shunt measurements



Housing width 6.2 mm

- Highly compact signal conditioner for electrical isolation, conversion, amplification, and filtering of mV signals to create standard analog signals
- Ideal for converting signals in the case of shunt measurements
- Up to 280 signal combinations can be configured using DIP switches
- 3-way isolation
- Low power consumption
- Power supply possible through the foot element (DIN rail connector)
- Standard configuration:  
0 ... 50 mV input, 0 ... 20 mA output

**Notes:**  
To order a product with an order configuration, enter the required configuration by referring to the adjacent order key.  
Information about power bridging, system cabling, and marking components can be found from page 116

<b>Input data</b>	Input signal (can be configured using DIP switches)
Maximum input signal	approx. 30 V DC
Input resistance	approx. 10 kΩ
<b>Output data</b>	U output
Output signal (configurable using the DIP switch)	0 ... 5 V / 1 ... 5 V
	I output
	0 ... 20 mA / 4 ... 20 mA
	0 ... 10 V / 2 ... 10 V
	-5 ... 5 V / -10 ... 10 V (the bipolar output can only be used for bipolar input signals)
Maximum output signal	12.5 V
Load R <sub>B</sub>	≥ 10 kΩ
Ripple	< 20 mV <sub>pp</sub> (at 10 kΩ)
	28 mA
	< 500 Ω (at 20 mA)
	< 20 mV <sub>pp</sub> (at 500 Ω)
<b>General data</b>	
Supply voltage U <sub>B</sub>	19.2 V DC ... 30 V DC
Nominal supply voltage	24 V DC
Power consumption	< 450 mW (current output)
Maximum transmission error	≤ 0.2 %
Temperature coefficient	< 0.01 %/K, typ. < 0.002 %/K
Cut-off frequency (3 dB)	100 Hz / 30 Hz switchable
Step response (10-90%)	3.5 ms (at 100 Hz)
Electrical isolation	Basic insulation according to EN 61010
Test voltage, input/output/supply	1.5 kV (50 Hz, 1 min.)
Degree of protection	IP20
Ambient temperature (operation)	-20 °C ... 65 °C
Mounting	any
Housing material	PBT
Dimensions W / H / D	6.2 / 93.1 / 102.5 mm
Screw connection solid / stranded / AWG	0.2 ... 2.5 mm <sup>2</sup> / 0.2 ... 2.5 mm <sup>2</sup> / 26 - 12
Spring-cage connection solid / stranded / AWG	0.2 ... 2.5 mm <sup>2</sup> / 0.2 ... 2.5 mm <sup>2</sup> / 24 - 12
EMC note	Class A product, see page 625
<b>Conformance / approvals</b>	
Conformance	CE-compliant
ATEX	Ex II 3 G Ex nA IIC T4 Gc X
UL, USA / Canada	UL 508 Recognized
	Class I, Div. 2, Groups A, B, C, D T5 applied for
GL	GL EMC 2 D

Technical data

0 ... 50 mV	
approx. 30 V DC	
approx. 10 kΩ	
U output	I output
0 ... 5 V / 1 ... 5 V	0 ... 20 mA / 4 ... 20 mA
0 ... 10 V / 2 ... 10 V	
-5 ... 5 V / -10 ... 10 V (the bipolar output can only be used for bipolar input signals)	
12.5 V	28 mA
≥ 10 kΩ	< 500 Ω (at 20 mA)
< 20 mV <sub>pp</sub> (at 10 kΩ)	< 20 mV <sub>pp</sub> (at 500 Ω)
19.2 V DC ... 30 V DC	
24 V DC	
< 450 mW (current output)	
≤ 0.2 %	
< 0.01 %/K, typ. < 0.002 %/K	
100 Hz / 30 Hz switchable	
3.5 ms (at 100 Hz)	
Basic insulation according to EN 61010	
1.5 kV (50 Hz, 1 min.)	
IP20	
-20 °C ... 65 °C	
any	
PBT	
6.2 / 93.1 / 102.5 mm	
0.2 ... 2.5 mm <sup>2</sup> / 0.2 ... 2.5 mm <sup>2</sup> / 26 - 12	
0.2 ... 2.5 mm <sup>2</sup> / 0.2 ... 2.5 mm <sup>2</sup> / 24 - 12	
Class A product, see page 625	
CE-compliant	
Ex II 3 G Ex nA IIC T4 Gc X	
UL 508 Recognized	
Class I, Div. 2, Groups A, B, C, D T5 applied for	
GL EMC 2 D	

Ordering data

Description	Type	Order No.	Pcs. / Pkt.
<b>MCR 3-way signal conditioner</b> , for converting mV voltages to standard signals			
Order configuration Screw connection	<b>MINI MCR-SL-SHUNT-UI</b>	<b>2810858</b>	1
Order configuration Spring-cage connection	<b>MINI MCR-SL-SHUNT-UI-SP</b>	<b>2810874</b>	1
Standard configuration Screw connection	<b>MINI MCR-SL-SHUNT-UI-NC</b>	<b>2810780</b>	1
Standard configuration Spring-cage connection	<b>MINI MCR-SL-SHUNT-UI-SP-NC</b>	<b>2810793</b>	1

Order key for MINI MCR-SL-SHUNT-UI(-SP) (standard configuration entered as an example)

Order No.	Input				Output	Cut-off frequency	Factory calibration certificate (FCC)
2810858	IN40				OUT01	100	NONE
2810858 ≙ MINI MCR-SL-SHUNT-UI	IN40 ≙ 0 ... 50 mV IN24 ≙ 0.60 mV IN41 ≙ 0.75 mV IN42 ≙ 0.80 mV IN25 ≙ 0.100 mV IN43 ≙ 0.120 mV IN44 ≙ 0.150 mV IN26 ≙ 0.200 mV IN45 ≙ 0.240 mV IN27 ≙ 0.300 mV	IN28 ≙ 0.500 mV IN46 ≙ 0.600 mV IN47 ≙ 0.750 mV IN48 ≙ 0.800 mV IN29 ≙ 0 ... 1.0 V IN49 ≙ 0 ... 1.2 V IN50 ≙ 0 ... 1.5 V IN30 ≙ 0 ... 2.0 V IN51 ≙ 0 ... 2.4 V IN52 ≙ 0 ... 3.0 V	IN53 ≙ -50..+50 mV IN13 ≙ -60..+60 mV IN54 ≙ -75..+75 mV IN55 ≙ -80..+80 mV IN14 ≙ -100..+100 mV IN56 ≙ -120..+120 mV IN57 ≙ -150..+150 mV IN15 ≙ -200..+200 mV IN58 ≙ -240..+240 mV IN16 ≙ -300..+300 mV	IN17 ≙ -500..+500 mV IN59 ≙ -600..+600 mV IN60 ≙ -750..+750 mV IN61 ≙ -800..+800 mV IN18 ≙ -1.0 ... +1.0 V IN62 ≙ -1.2 ... +1.2 V IN63 ≙ -1.5 ... +1.5 V IN19 ≙ -2.0 ... +2.0 V IN64 ≙ -2.4 ... +2.4 V IN65 ≙ -3.0 ... +3.0 V	OUT01 ≙ 0 ... 20 mA OUT02 ≙ 4 ... 20 mA OUT03 ≙ 0 ... 10 V OUT04 ≙ 2 ... 10 V OUT05 ≙ 0 ... 5 V OUT06 ≙ 1 ... 5 V  OUT13 ≙ -5 ... +5 V OUT14 ≙ -10 ... +10 V	30 ≙ 30 Hz 100 ≙ 100 Hz	NONE ≙ without FCC YES ≙ with FCC (a fee is charged)  YESPLUS ≙ FCC with 5 measuring points (a fee is charged)

Note:  
A bipolar output (-5 ... +5 V, -10 ... +10 V) can only be used for a bipolar input signal.

Combination table for input and output signals

Input	Voltage output					Current output		
	-10 ... +10 V	0 ... 10 V	2 ... 10 V	-5 ... +5 V	0 ... 5 V	1 ... 5 V	0 ... 20 mA	4 ... 20 mA
0 ... 50 mV		x	x		x	x	x	x
0.60 mV		x	x		x	x	x	x
0.75 mV		x	x		x	x	x	x
0.80 mV		x	x		x	x	x	x
0.100 mV		x	x		x	x	x	x
0.120 mV		x	x		x	x	x	x
0 ... 150 mV		x	x		x	x	x	x
0.200 mV		x	x		x	x	x	x
0.240 mV		x	x		x	x	x	x
0.300 mV		x	x		x	x	x	x
0.500 mV		x	x		x	x	x	x
0.600 mV		x	x		x	x	x	x
0.750 mV		x	x		x	x	x	x
0.800 mV		x	x		x	x	x	x
0 ... 1 V		x	x		x	x	x	x
0 ... 1.2 V		x	x		x	x	x	x
0 ... 1.5 V		x	x		x	x	x	x
0 ... 2 V		x	x		x	x	x	x
0 ... 2.4 V		x	x		x	x	x	x
0 ... 3 V		x	x		x	x	x	x
-50 ... 50 mV	x	x	x	x	x	x	x	x
-60 ... 60 mV	x	x	x	x	x	x	x	x
-75 ... 75 mV	x	x	x	x	x	x	x	x
-80 ... 80 mV	x	x	x	x	x	x	x	x
-100 ... 100 mV	x	x	x	x	x	x	x	x
-120 ... 120 mV	x	x	x	x	x	x	x	x
-150 ... 150 mV	x	x	x	x	x	x	x	x
-200 ... 200 mV	x	x	x	x	x	x	x	x
-240 ... 240 mV	x	x	x	x	x	x	x	x
-300 ... 300 mV	x	x	x	x	x	x	x	x
-500 ... 500 mV	x	x	x	x	x	x	x	x
-600 ... 600 mV	x	x	x	x	x	x	x	x
-750 ... 750 mV	x	x	x	x	x	x	x	x
-800 ... 800 mV	x	x	x	x	x	x	x	x
-1 ... 1 V	x	x	x	x	x	x	x	x
-1.2 ... 1.2 V	x	x	x	x	x	x	x	x
-1.5 ... 1.5 V	x	x	x	x	x	x	x	x
-2 ... 2 V	x	x	x	x	x	x	x	x
-2.4 ... 2.4 V	x	x	x	x	x	x	x	x
-3 ... 3 V	x	x	x	x	x	x	x	x

Application example: monitoring of loading and unloading currents

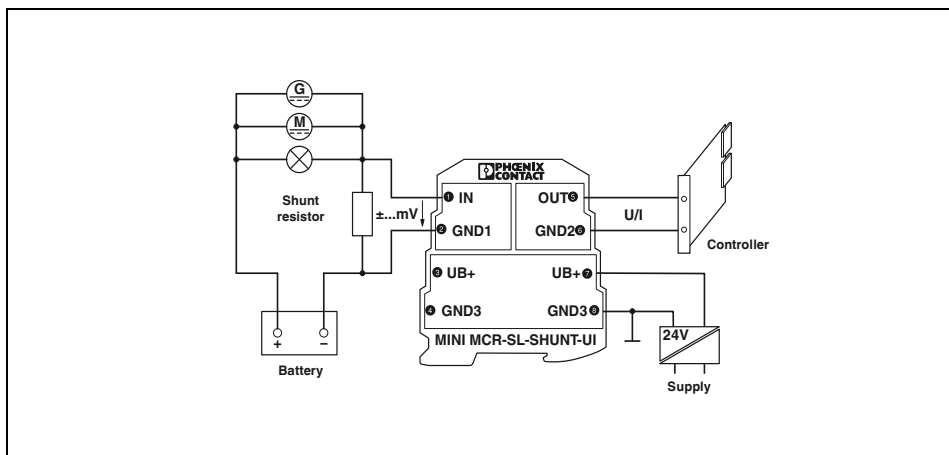



Analog IN/Analog OUT  
3-way signal conditioner

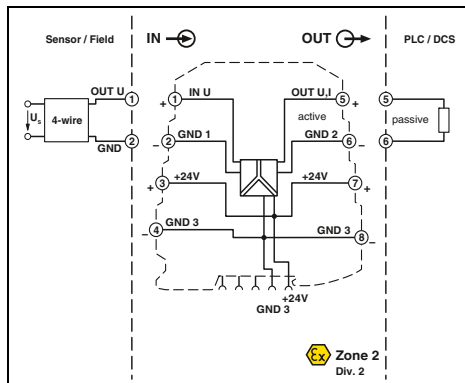
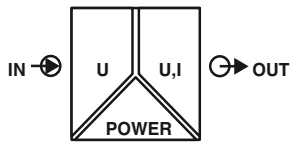

Ex n



Configurable,  
for 0 ... 24 V / 0 ... 30 V input signals



Housing width 6.2 mm

- Highly compact signal conditioner for electrical isolation, conversion, amplification, and filtering of 24 V or 30 V DC signals to create standard analog signals
- Up to 12 signal combinations can be configured using DIP switches
- 3-way isolation
- Low power consumption
- Power supply possible through the foot element (DIN rail connector)
- Standard configuration:  
0 ... 30 V input, 0 ... 20 mA output

**Notes:**  
To order a product with an order configuration, please enter the desired configuration by referring to the order key; see below.  
Information about power bridging, system cabling, and marking components can be found from page 116

<b>Input data</b>	
Input signal	0 ... 24 V / 0 ... 30 V
Input resistance	approx. 125 kΩ (0 ... 24 V)
<b>Output data</b>	
Output signal (configurable using the DIP switch)	U output: 0 ... 5 V / 1 ... 5 V I output: 0 ... 20 mA / 4 ... 20 mA
Maximum output signal	0 ... 10 V / 2 ... 10 V
No-load voltage	≤ 12.5 V
Short-circuit current	28 mA
Load R <sub>B</sub>	≤ 12.5 V
Ripple	≤ 22 mA
<b>General data</b>	
Supply voltage U <sub>B</sub>	19.2 V DC ... 30 V DC
Power consumption	< 450 mW
Maximum transmission error	< 0.1 % (of final value)
Temperature coefficient	< 0.01 %/K, typ. < 0.002 %/K
Cut-off frequency (3 dB)	approx. 100 Hz
Step response (10-90%)	approx. 3.5 ms
Electrical isolation	Basic insulation according to EN 61010
Test voltage, input/output/supply	1.5 kV (50 Hz, 1 min.)
Ambient temperature (operation)	-20 °C ... 65 °C
Housing material	PBT
Dimensions W / H / D	6.2 / 93.1 / 102.5 mm
Screw connection solid / stranded / AWG	0.2 ... 2.5 mm <sup>2</sup> / 0.2 ... 2.5 mm <sup>2</sup> / 26 - 12
Spring-cage connection solid / stranded / AWG	0.2 ... 2.5 mm <sup>2</sup> / 0.2 ... 2.5 mm <sup>2</sup> / 24 - 12
EMC note	Class A product, see page 625
<b>Conformance / approvals</b>	
Conformance	CE-compliant
ATEX	Ex II 3 G Ex nA IIC T4 Gc X
UL, USA / Canada	UL 508 Recognized
	Class I, Div. 2, Groups A, B, C, D T5
	GL EMC 2 D

**Technical data**

<b>Technical data</b>	
Input signal	0 ... 24 V / 0 ... 30 V
Input resistance	approx. 125 kΩ (0 ... 24 V)
Output data	U output: 0 ... 5 V / 1 ... 5 V I output: 0 ... 20 mA / 4 ... 20 mA
Maximum output signal	0 ... 10 V / 2 ... 10 V
No-load voltage	≤ 12.5 V
Short-circuit current	28 mA
Load R <sub>B</sub>	≤ 12.5 V
Ripple	≤ 22 mA
General data	
Supply voltage U <sub>B</sub>	19.2 V DC ... 30 V DC
Power consumption	< 450 mW
Maximum transmission error	< 0.1 % (of final value)
Temperature coefficient	< 0.01 %/K, typ. < 0.002 %/K
Cut-off frequency (3 dB)	approx. 100 Hz
Step response (10-90%)	approx. 3.5 ms
Electrical isolation	Basic insulation according to EN 61010
Test voltage, input/output/supply	1.5 kV (50 Hz, 1 min.)
Ambient temperature (operation)	-20 °C ... 65 °C
Housing material	PBT
Dimensions W / H / D	6.2 / 93.1 / 102.5 mm
Screw connection solid / stranded / AWG	0.2 ... 2.5 mm <sup>2</sup> / 0.2 ... 2.5 mm <sup>2</sup> / 26 - 12
Spring-cage connection solid / stranded / AWG	0.2 ... 2.5 mm <sup>2</sup> / 0.2 ... 2.5 mm <sup>2</sup> / 24 - 12
EMC note	Class A product, see page 625
Conformance / approvals	
Conformance	CE-compliant
ATEX	Ex II 3 G Ex nA IIC T4 Gc X
UL, USA / Canada	UL 508 Recognized
	Class I, Div. 2, Groups A, B, C, D T5
	GL EMC 2 D

**Ordering data**

<b>Description</b>		<b>Type</b>	<b>Order No.</b>	<b>Pcs. / Pkt.</b>
MCR 3-way signal conditioner, for electrical isolation of analog signals		MINI MCR-SL-U-UI	2864053	1
Order configuration	Screw connection	MINI MCR-SL-U-UI-SP	2811213	1
Order configuration	Spring-cage connection	MINI MCR-SL-U-UI-NC	2865007	1
Standard configuration	Screw connection	MINI MCR-SL-U-UI-SP-NC	2810078	1
Standard configuration	Spring-cage connection			

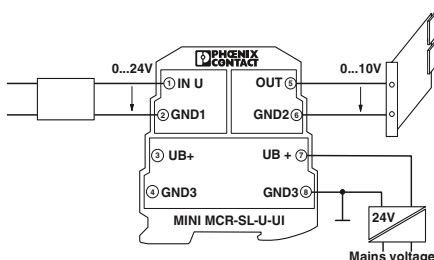

Signal conversion according to uninterruptible power supply (UPS)

Order key MINI MCR-SL-U-UI(-SP) (standard configuration entered as an example)

<b>Order No.</b>	<b>Input</b>	<b>Output</b>
2864053	IN39	OUT01
2864053 = MINI MCR-SL-U-UI	IN38 ≙ 0...24 V IN39 ≙ 0...30 V	OUT01 ≙ 0 ... 20 OUT02 ≙ 4 ... 20 OUT03 ≙ 0...10 V OUT04 ≙ 2...10 V OUT05 ≙ 0...5 V OUT06 ≙ 1...5 V
2811213 ≙ MINI MCR-SL-U-UI-SP		

Analog IN/Analog OUT  
3-way signal conditioner

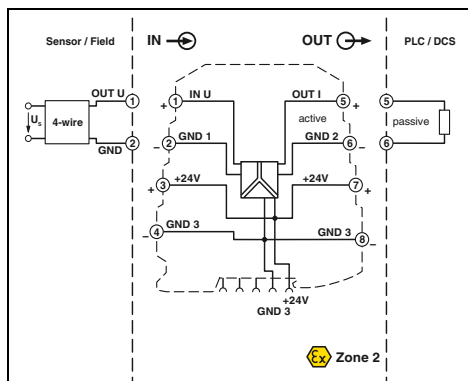
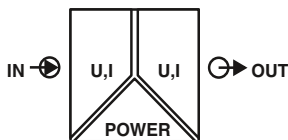

Ex n



With fixed signal combinations



Ex: Ex

- Highly compact signal conditioner for electrical isolation, conversion, amplification, and filtering of standard analog signals
- Fixed signal combinations
- Entry-level alternative to configurable signal conditioners
- 3-way isolation
- Low power consumption
- Power supply possible through the foot element (DIN rail connector)

Notes:

Information about power bridging, system cabling, and marking components can be found from page 116

<b>Input data</b>	U input	I input
Input resistance	approx. 100 kΩ	approx. 50 Ω
<b>Output data</b>	U output	I output
Maximum output signal	12.5 V	28 mA
No-load voltage		approx. 12.5 V
Short-circuit current	approx. 2 mA	
Load R <sub>B</sub>	≥ 10 kΩ	≤ 500 Ω
Ripple	< 20 mV <sub>PP</sub> (at 10 kΩ)	< 20 mV <sub>PP</sub> (at 500 Ω)
<b>General data</b>	Supply voltage U <sub>B</sub>	19.2 V DC ... 30 V DC
Supply voltage U <sub>B</sub>	Nominal supply voltage	24 V DC
Nominal supply voltage	Current consumption	< 20 mA
Current consumption	Maximum transmission error	≤ 0.1 % (of final value)
Maximum transmission error	Temperature coefficient	< 0.01 %/K, typ. < 0.002 %/K
Temperature coefficient	Cut-off frequency (3 dB)	approx. 100 Hz
Cut-off frequency (3 dB)	Step response (10-90%)	approx. 3.5 ms
Step response (10-90%)	Degree of protection	IP20
Degree of protection	Electrical isolation	Basic insulation according to EN 61010
Electrical isolation	Test voltage, input/output/supply	1.5 kV (50 Hz, 1 min.)
Test voltage, input/output/supply	Ambient temperature (operation)	-20 °C ... 65 °C
Ambient temperature (operation)	Housing material	PBT
Housing material	Dimensions W / H / D	6.2 / 93.1 / 102.5 mm
Dimensions W / H / D	Screw connection solid / stranded / AWG	0.2 ... 2.5 mm <sup>2</sup> / 0.2 ... 2.5 mm <sup>2</sup> / 26 - 12
Screw connection solid / stranded / AWG	Spring-cage connection solid / stranded / AWG	0.2 ... 2.5 mm <sup>2</sup> / 0.2 ... 2.5 mm <sup>2</sup> / 24 - 12
Spring-cage connection solid / stranded / AWG	EMC note	Class A product, see page 625
EMC note	<b>Conformance / approvals</b>	
<b>Conformance / approvals</b>	Conformance	CE-compliant
Conformance	ATEX	Ex II 3 G Ex nA IIC T4 Gc X
ATEX	UL, USA / Canada	UL 508 Recognized
UL, USA / Canada	GL	Class I, Div. 2, Groups A, B, C, D T5 applied for
GL		GL EMC 2 D

Technical data	
U input	I input
approx. 100 kΩ	approx. 50 Ω
U output	I output
12.5 V	28 mA
	approx. 12.5 V
approx. 2 mA	
≥ 10 kΩ	≤ 500 Ω
< 20 mV <sub>PP</sub> (at 10 kΩ)	< 20 mV <sub>PP</sub> (at 500 Ω)
19.2 V DC ... 30 V DC	
24 V DC	
< 20 mA	
≤ 0.1 % (of final value)	
< 0.01 %/K, typ. < 0.002 %/K	
approx. 100 Hz	
approx. 3.5 ms	
IP20	
Basic insulation according to EN 61010	
1.5 kV (50 Hz, 1 min.)	
-20 °C ... 65 °C	
PBT	
6.2 / 93.1 / 102.5 mm	
0.2 ... 2.5 mm <sup>2</sup> / 0.2 ... 2.5 mm <sup>2</sup> / 26 - 12	
0.2 ... 2.5 mm <sup>2</sup> / 0.2 ... 2.5 mm <sup>2</sup> / 24 - 12	
Class A product, see page 625	
CE-compliant	
Ex II 3 G Ex nA IIC T4 Gc X	
UL 508 Recognized	
Class I, Div. 2, Groups A, B, C, D T5 applied for	
GL EMC 2 D	

Description	Input signal	Output signal
<b>MCR 3-way signal conditioner</b> , for electrical isolation of analog signals		
Screw connection	0 ... 10 V	0 ... 20 mA
Spring-cage connection	0 ... 10 V	0 ... 20 mA
Screw connection	0 ... 10 V	4 ... 20 mA
Spring-cage connection	0 ... 10 V	4 ... 20 mA
Screw connection	0 ... 20 mA	0 ... 10 V
Spring-cage connection	0 ... 20 mA	0 ... 10 V
Screw connection	4 ... 20 mA	0 ... 10 V
Spring-cage connection	4 ... 20 mA	0 ... 10 V
Screw connection	0 ... 20 mA, 4 ... 20 mA	0 ... 20 mA, 4 ... 20 mA
Spring-cage connection	0 ... 20 mA, 4 ... 20 mA	0 ... 20 mA, 4 ... 20 mA
Screw connection	0 ... 10 V, -10 ... 10 V	0 ... 10 V, -10 ... 10 V
Spring-cage connection	0 ... 10 V, -10 ... 10 V	0 ... 10 V, -10 ... 10 V

Ordering data		
Type	Order No.	Pcs. / Pkt.
MINI MCR-SL-U-I-0	2813512	1
MINI MCR-SL-U-I-0-SP	2813570	1
MINI MCR-SL-U-I-4	2813525	1
MINI MCR-SL-U-I-4-SP	2813583	1
MINI MCR-SL-I-U-0	2813541	1
MINI MCR-SL-I-U-0-SP	2813554	1
MINI MCR-SL-I-U-4	2813538	1
MINI MCR-SL-I-U-4-SP	2813567	1
MINI MCR-SL-I-I	2864406	1
MINI MCR-SL-I-I-SP	2864723	1
MINI MCR-SL-U-U	2864684	1
MINI MCR-SL-U-U-SP	2864697	1

Analog IN/Analog OUT signal duplicator

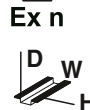
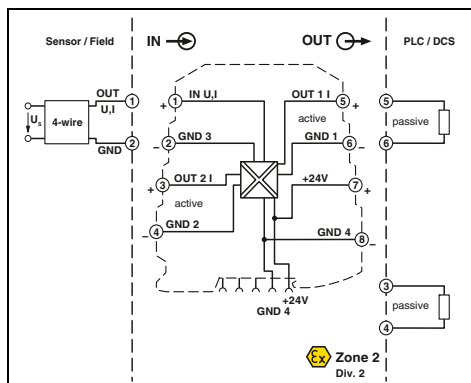
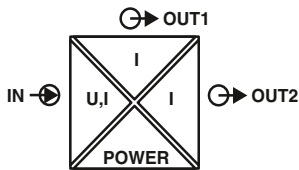

Configurable, with two current output signals



Housing width 6.2 mm

- Highly compact signal conditioner for electrical isolation, conversion, amplification, filtering, and duplication of standard analog signals
- Duplication of a standard analog signal on two current outputs
- Up to 8 signal combinations can be configured using DIP switches
- 4-way isolation
- Power supply possible through the foot element (DIN rail connector)
- Standard configuration: Input: 0 ... 10 V, output 1: 0 ... 20 mA, output 2: 0 ... 20 mA

**Notes:**  
 To order a product with an order configuration, please enter the desired configuration by referring to the order key; see below.  
 Information about power bridging, system cabling, and marking components can be found from page 116

<b>Input data</b>	Input signal Maximum input signal Input resistance
<b>Output data</b>	Output signal (configurable using the DIP switch)
<b>General data</b>	Maximum output signal No-load voltage Load R <sub>B</sub> Ripple
<b>General data</b>	Supply voltage U <sub>B</sub> Current consumption Power consumption Maximum transmission error Temperature coefficient Cut-off frequency (3 dB) Step response (0-99%) Electrical isolation Test voltage, input/output/supply Ambient temperature (operation) Housing material Dimensions W / H / D Screw connection solid / stranded / AWG Spring-cage connection solid / stranded / AWG EMC note
<b>Conformance / approvals</b>	Conformance ATEX UL, USA / Canada  GL

Technical data	
<b>U input</b>	<b>I input</b>
0 ... 10 V / 1 ... 5 V	0 ... 20 mA / 4 ... 20 mA
30 V	50 mA
approx. 100 kΩ	approx. 50 Ω
2x; 0 ... 20 mA / 4 ... 20 mA	
22 mA 9 V ≤ 250 Ω (at 20 mA) < 20 mV <sub>pp</sub> (at 250 Ω)	
19.2 V DC ... 30 V DC < 30 mA (at 24 V DC incl. load) < 600 mW ≤ 0.2 % (of final value), typ. < 0.1 % < 0.01 %/K, typ. < 0.004 %/K approx. 35 Hz approx. 10 ms Basic insulation according to EN 61010 1.5 kV (50 Hz, 1 min.) -20 °C ... 60 °C PBT 6.2 / 93.1 / 102.5 mm 0.2 ... 2.5 mm <sup>2</sup> / 0.2 ... 2.5 mm <sup>2</sup> / 26 - 12 0.2 ... 2.5 mm <sup>2</sup> / 0.2 ... 2.5 mm <sup>2</sup> / 24 - 12 Class A product, see page 625	
CE-compliant Ex II 3 G Ex nA IIC T4 Gc X UL 508 Recognized Class I, Div. 2, Groups A, B, C, D T5 GL EMC 2 D	

Description	Order configuration
<b>MCR signal duplicator</b> , for duplication and electrical isolation of analog signals	
Order configuration	Screw connection
Order configuration	Spring-cage connection
Standard configuration	Screw connection
Standard configuration	Spring-cage connection

Ordering data		
Type	Order No.	Pcs. / Pkt.
MINI MCR-SL-UI-2I	2864794	1
MINI MCR-SL-UI-2I-SP	2864804	1
MINI MCR-SL-UI-2I-NC	2864176	1
MINI MCR-SL-UI-2I-SP-NC	2864189	1

Order key MINI MCR-SL-UI-2I(-SP) (standard configuration entered as an example)

Order No.	Input	Output combination <sup>1)</sup>	Behavior of the analog outputs	Factory calibration certificate (FCC)
2864794	IN03	A	0	NONE
2864794 ≙ MINI MCR-SL-UI-2I	IN01 ≙ 0 ... 20 mA IN02 ≙ 4 ... 20 mA IN03 ≙ 0 ... 10 V IN06 ≙ 1 ... 5 V	A B C	0 ≙ Analog behavior 1 ≙ Limitation	NONE ≙ without FCC Yes ≙ with FCC (a fee is charged)  YESPLUS ≙ FCC with 5 measuring points (a fee is charged)
2864804 ≙ MINI MCR-SL-UI-2I-SP				

Explanation for output combination:

	Output 1	Output 2
A	0 ... 20 mA	0 ... 20 mA
B	0 ... 20 mA	4 ... 20 mA
C	4 ... 20 mA	4 ... 20 mA

<sup>1)</sup> For explanations, see adjacent text on the right; for further details, see data sheet: [www.phoenixcontact.net/products](http://www.phoenixcontact.net/products)

Analog IN/Analog OUT  
repeater power supply

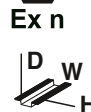
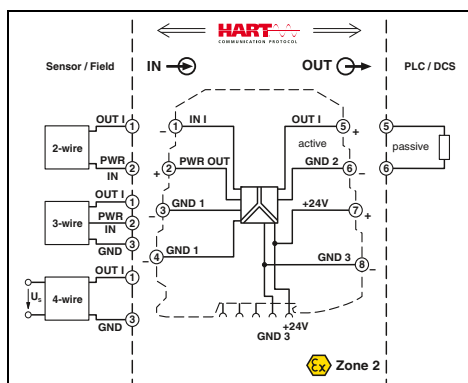
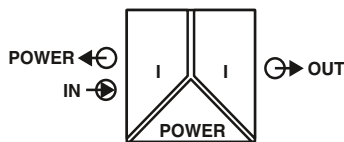

Available with HART transmission as an option



Housing width 6.2 mm

Technical data

	MINI MCR-SL-RPSS-I-I	MINI MCR-SL-RPS-I-I
<b>Input data</b>		
Input signal	0 ... 20 mA, isolator operation / 4 ... 20 mA approx. 50 Ω	0 ... 20 mA, isolator operation / 4 ... 20 mA approx. 50 Ω
Input resistance	16.5 V	14.7 V DC ... 25.5 V DC U <sub>B</sub> - max. 4.5 V for load 0 mA ... 20 mA
Transmitter supply voltage		
<b>Output data</b>		
Output signal	0 ... 20 mA / 4 ... 20 mA	0 ... 20 mA / 4 ... 20 mA
Maximum output signal	21 mA	28 mA
No-load voltage	approx. 12.5 V	approx. 12.5 V
Load R <sub>B</sub>	≤ 500 Ω (at I = 20 mA)	≤ 500 Ω (at I = 20 mA)
Ripple	< 20 mV <sub>rms</sub> (at 500 Ω)	< 20 mV <sub>rms</sub> (at 500 Ω)
<b>General data</b>		
Supply voltage U <sub>B</sub>	20.4 V DC ... 30 V DC	19.2 V DC ... 30 V DC
Nominal supply voltage	24 V DC	24 V DC
Current consumption	< 900 mW (at 24 V DC and in repeater power supply operation)	< 900 mW (at 24 V DC and in repeater power supply operation)
Power consumption	≤ 0.2 % (of final value), typ. ≤ 0.1 % (of final value)	≤ 0.2 % (of final value), typ. ≤ 0.1 % (of final value)
Maximum transmission error	< 0.005 %/K, typ. < 0.002 %/K	< 0.01 %/K, typ. < 0.002 %/K
Temperature coefficient	175 Hz (typ.)	approx. 100 Hz
Cut-off frequency (3 dB)	HART specification in both operating modes (RPSS isolator / RPSS repeater power supply)	-
Communication		
Step response (10-90%)	< 2 ms (typ.)	approx. 3.5 ms
Electrical isolation	Basic insulation according to EN 61010	
Test voltage, input/output/supply	1.5 kV (50 Hz, 1 min.)	1.5 kV (50 Hz, 1 min.)
Degree of protection	IP20	IP20
Ambient temperature (operation)	-20 °C ... 60 °C	-20 °C ... 60 °C
Mounting	any	any
Housing material	PBT	PBT
Dimensions W / H / D	6.2 / 93.1 / 102.5 mm	6.2 / 93.1 / 102.5 mm
Screw connection solid / stranded / AWG	0.2 ... 2.5 mm <sup>2</sup> / 0.2 ... 2.5 mm <sup>2</sup> / 26 - 12	
Spring-cage connection solid / stranded / AWG	0.2 ... 2.5 mm <sup>2</sup> / 0.2 ... 2.5 mm <sup>2</sup> / 24 - 12	
EMC note	Class A product, see page 625	
<b>Conformance / approvals</b>		
Conformance	CE-compliant	CE-compliant
ATEX	Ex II 3 G Ex nA IIC T4 Gc X	Ex II 3 G Ex nA IIC T4 Gc X
UL, USA / Canada	UL 508 Recognized applied for Class I, Div. 2, Groups A, B, C, D T5 applied for	UL 508 Recognized Class I, Div. 2, Groups A, B, C, D T5
GL	GL EMC 2 D	GL EMC 2 D

- Highly compact repeater power supply for electrical isolation, amplification, and filtering of standard analog signals
- Supply of 2-wire and passive 3-wire sensors
- Can also be used as an isolator without supply
- 3-way isolation
- Bidirectional HART transmission as an option
- Power supply possible through the foot element (DIN rail connector)

Notes:

Information about power bridging, system cabling, and marking components can be found from page 99

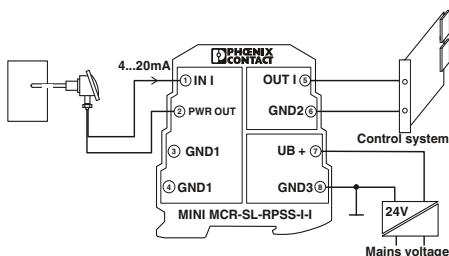

Repeater power supply operation with a passive sensor

Ordering data

Description	Type	Order No.	Pcs. / Pkt.	
MCR repeater power supply with HART® protocol	Screw connection	MINI MCR-SL-RPSS-I-I	2864079	1
with HART® protocol	Spring-cage connection	MINI MCR-SL-RPSS-I-I-SP	2810230	1
	Screw connection	MINI MCR-SL-RPS-I-I	2864422	1
	Spring-cage connection	MINI MCR-SL-RPS-I-I-SP	2864752	1

Analog IN/Analog OUT  
3-way output isolator

new

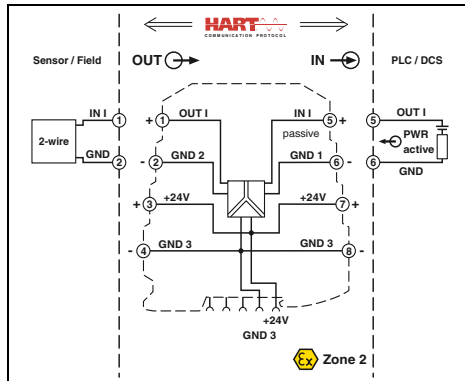
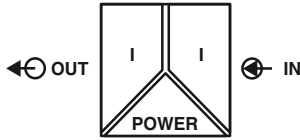

HART transmission

Housing width 6.2 mm

- Highly compact output signal conditioner for electrical isolation, conversion, amplification, and filtering of standard analog signals
- For controlling I/P converters, control valves, and displays
- 3-way isolation
- Bidirectional HART transmission
- Power supply possible through the foot element (DIN rail connector)

**Notes:**  
Information about power bridging, system cabling, and marking components can be found from page 116

<b>Input data</b>	Input signal Maximum input signal Input voltage limitation
<b>Output data</b>	Output signal Load $R_B$ Ripple
<b>General data</b>	Supply voltage $U_B$ Nominal supply voltage Power consumption Maximum transmission error Temperature coefficient Cut-off frequency (3 dB) Communication Step response (10-90%) Electrical isolation Test voltage, input/output/supply Degree of protection Ambient temperature (operation) Mounting Housing material Dimensions W / H / D Screw connection solid / stranded / AWG Spring-cage connection solid / stranded / AWG
<b>Conformance / approvals</b>	Conformance ATEX UL, USA / Canada
<b>GL</b>	

Technical data	
<b>Input data</b>	0 ... 20 mA / 4 ... 20 mA 20 mA < 2 V (20 mA)
<b>Output data</b>	0 ... 20 mA / 4 ... 20 mA $\leq 800 \Omega$ (at 20 mA) < 20 mV <sub>rms</sub>
<b>General data</b>	19.2 V DC ... 30 V DC 24 V DC < 600 mW (at 24 V DC) $\leq 0.1 \%$ (of final value) typ. < 0.01 %/K > 175 Hz HART specification < 2 ms Basic insulation according to EN 61010 1.5 kV (50 Hz, 1 min.) IP20 -20 °C ... 60 °C any PBT 6.2 / 93.1 / 102.5 mm 0.2 ... 2.5 mm <sup>2</sup> / 0.2 ... 2.5 mm <sup>2</sup> / 26 - 12 0.2 ... 2.5 mm <sup>2</sup> / 0.2 ... 2.5 mm <sup>2</sup> / 24 - 12
<b>Conformance / approvals</b>	CE-compliant Ex II 3 G Ex nA IIC T4 Gc X UL 508 Recognized applied for Class I, Div. 2, Groups A, B, C, D T5 applied for GL applied for

Description	Type
<b>3-way output isolator</b>	Screw connection <b>MINI MCR-SL-IDS-I-I</b>
	Spring-cage connection <b>MINI MCR-SL-IDS-I-I-SP</b>

Ordering data		
Type	Order No.	Pcs. / Pkt.
MINI MCR-SL-IDS-I-I	2905577	1
MINI MCR-SL-IDS-I-I-SP	2905578	1

**Analog IN/Analog OUT**  
**2-way passive isolator,**  
**input loop-powered**

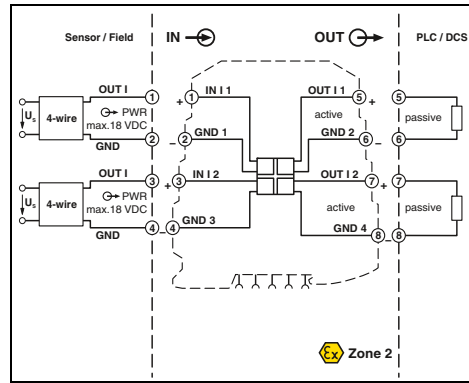
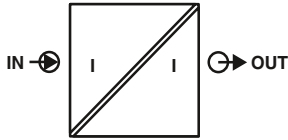

Ex n



Either 1 or 2-channel



Ex: Housing width 6.2 mm

- Highly compact 2-wire passive isolator for electrical isolation and filtering of standard analog signals
- Input loop-supplied
- Does not require any additional auxiliary voltage
- 2 channels in conj. with an overall width of just 6.2 mm
- Voltage drop on signal conditioner of just 1.7 V

**Notes:**

When using passive isolators, make sure that the current sourcing voltage of the measuring transducer  $U_B$  is sufficient to drive the maximum current of 20 mA via the passive isolator with a voltage drop  $U_V = 1.7 \text{ V}$  and load  $R_B$ .

This means:  
 $U_B \geq U_E = 1.7 \text{ V} + 20 \text{ mA} \times R_B$

Information on components for power bridging, system cabling, and marking can be found in Catalog 7, Interface technology and switching devices or at phoenixcontact.net/products

**Input data**

Input signal  
 Voltage drop  
 Response current  
 Maximum input current / overload  
 Maximum input voltage

**Output data**

Output signal  
 Load  $R_B$   
 Ripple

**General data**

Maximum transmission error  
 Additional error per 100  $\Omega$  load  
 Temperature coefficient  
 Cut-off frequency (3 dB)  
 Step response (10-90%)  
 Electrical isolation  
 Test voltage input/output  
 Degree of protection  
 Ambient temperature (operation)  
 Mounting  
 Housing material  
 Dimensions W / H / D  
 Screw connection solid / stranded / AWG  
 Spring-cage connection solid / stranded / AWG  
 Conformance / approvals  
 Conformance  
 ATEX  
 UL, USA / Canada

GL

**Technical data**

0 ... 20 mA / 4 ... 20 mA  
 1.7 V (at I = 20 mA)  
 approx. 190  $\mu\text{A}$   
 40 mA  
 18 V

0 ... 20 mA / 4 ... 20 mA  
 < 600  $\Omega$  (at I = 20 mA output signal)  
 < 10 mV<sub>rms</sub> (at 600  $\Omega$ )

$\leq 0.1 \%$  (of final value)  
 0.03 % (of measured value / 100  $\Omega$  load)  
 $\leq 0.002 \%$ /K (of measured value / 100  $\Omega$  load)  
 75 Hz  
 5 ms (at 600  $\Omega$  load)  
 Basic insulation according to EN 61010  
 1.5 kV (50 Hz, 1 min.)  
 IP20  
 -20 °C ... 65 °C  
 any  
 PBT  
 6.2 / 93.1 / 102.5 mm  
 0.2 ... 2.5 mm<sup>2</sup> / 0.2 ... 2.5 mm<sup>2</sup> / 26 - 12  
 0.2 ... 2.5 mm<sup>2</sup> / 0.2 ... 2.5 mm<sup>2</sup> / 24 - 12

CE-compliant  
 II 3 G Ex nA II T6 X  
 UL 508 Recognized  
 Class I, Div. 2, Groups A, B, C, D  
 GL EMC 2 D

**Ordering data**

**Description**

**MCR passive isolator**, for electrical isolation of current signals without auxiliary power

two-channel	Screw connection
two-channel	Spring-cage connection
single-channel	Screw connection
single-channel	Spring-cage connection

**Type**

**Order No.**

Pcs. / Pkt.

MINI MCR-SL-2CP-I-I	2864655	1
MINI MCR-SL-2CP-I-I-SP	2864781	1
MINI MCR-SL-1CP-I-I	2864419	1
MINI MCR-SL-1CP-I-I-SP	2864749	1

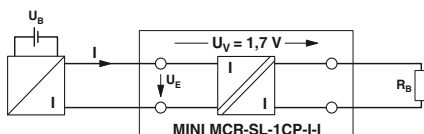



**Analog IN/Analog OUT**  
2-way isolator, output loop-powered

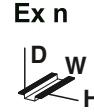
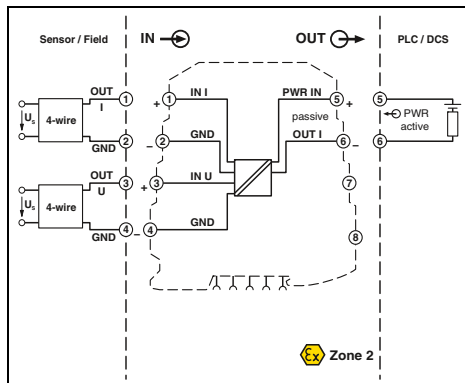
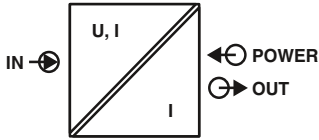

**Configurable,  
up to 74 signal combinations,  
output loop-powered**

Ex:   
Housing width 6.2 mm

- Highly compact signal conditioner for electrical isolation, conversion, and filtering of standard analog signals
- Supplied by an output loop
- Does not require any additional auxiliary voltage
- Up to 74 signal combinations can be configured using DIP switches
- Voltage input from mV voltages right up to 30 volts
- Current input from 2 mA right up to 40 mA
- 2-way isolation
- Standard configuration: Input 2...10 V, output 4...20 mA

**Notes:**  
Other input signals that have not been listed can be provided on request.  
Information on components for power bridging, system cabling, and marking can be found in Catalog 7, Interface technology and switching devices or at phoenixcontact.net/products

<b>Input data</b>	Input signal (configurable using the DIP switch)
Maximum input signal	< 40 V
Input resistance	approx. 100 kΩ (at ≤ 1 V, otherwise approximately 1 MΩ)
<b>Output data</b>	Output signal Maximum output signal Load R <sub>B</sub> Ripple
<b>General data</b>	Current consumption Power consumption Maximum transmission error Temperature coefficient ZERO / SPAN adjustment Cut-off frequency (3 dB) Step response (10-90%) Electrical isolation Test voltage input/output Degree of protection Ambient temperature (operation) Mounting Housing material Dimensions W / H / D Screw connection solid / stranded / AWG Spring-cage connection solid / stranded / AWG EMC note
<b>Conformance / approvals</b>	CE-compliant ATEX UL, USA / Canada

Technical data	
U input	I input
2 ... 10 V, additional ranges can be configured, see table	
< 40 V	< 50 mA (electric strength up to 30 V)
approx. 100 kΩ (at ≤ 1 V, otherwise approximately 1 MΩ)	≤ 50 Ω
4 ... 20 mA 35 mA (U <sub>B</sub> - 8 V) / 22 mA < 20 mV <sub>pp</sub> (at 500 Ω)	
< 3.5 mA (without signal current) 28 mW (without signal) < 0.1 % (of final value) 0.01 %/K, typ. 0.005 %/K ± 2 % / ± 2 % approx. 30 Hz approx. 16 ms Basic insulation according to EN 61010 1.5 kV (50 Hz, 1 min.) IP20 -25 °C ... 70 °C any PBT 6.2 / 93.1 / 102.5 mm 0.2 ... 2.5 mm <sup>2</sup> / 0.2 ... 2.5 mm <sup>2</sup> / 26 - 12 0.2 ... 2.5 mm <sup>2</sup> / 0.2 ... 2.5 mm <sup>2</sup> / 24 - 12 Class A product, see page 625	
CE-compliant Ex II 3 G Ex nA IIC T4 Gc X UL 508 Listed Class I, Div. 2, Groups A, B, C, D T5 Class I, Zone 2, Group IIC	

Ordering data				
Description	Type	Order No.	Pcs. / Pkt.	
<b>MCR isolator, output loop-powered</b>	Screw connection	<b>MINI MCR-SL-UI-I-LP-NC</b>	2902829	1
	Spring-cage connection	<b>MINI MCR-SL-UI-I-LP-SP-NC</b>	2902830	1

**Possible input signal ranges** (configurable via DIP switch)

0...40 mA	0...30 V	0...10 V	2...10 V	0...1000 mV	±30 V	±10 V	±1000 mV
0...30 mA	0...25 V	0...7.5 V		0...750 mV	±25 V	±7.5 V	±750 mV
0...20 mA	4...20 mA	0...20 V	0...5 V	1...5 V	0...500 mV	±20 V	±5 V
0...12 mA		0...15 V	0...3 V		0...300 mV	±15 V	±3 V
0...10 mA	2...10 mA	0...12.5 V	0...2.5 V		0...250 mV	±12.5 V	±2.5 V
0...8 mA		0...12 V	0...2 V		0...200 mV	±12 V	±2 V
0...7.5 mA		0...1.5 V			0...150 mV	±1.5 V	±150 mV
0...6 mA		0...1.25 V			0...125 mV	±1.25 V	±125 mV
0...5 mA	1...5 mA	0...1.2 V			0...120 mV	±1.2 V	±120 mV
0...4 mA					0...100 mV		±100 mV
0...3 mA					0...75 mV		±75 mV
0...2.5 mA					0...60 mV		±60 mV
0...2 mA					0...50 mV		±50 mV



**Temperature**  
**Temperature transducer**  
**for resistance thermometers**

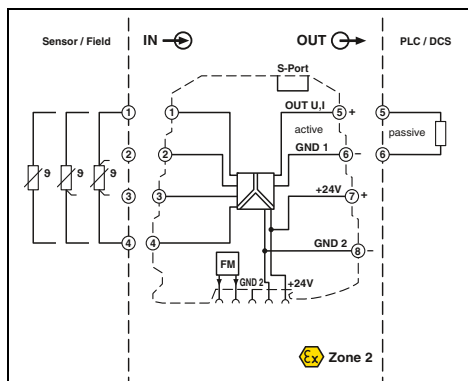
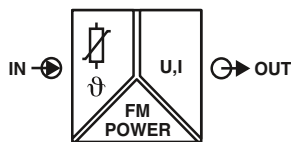

Ex n



**Universal measuring transducer for resistance thermometers**



Housing width 6.2 mm

**Technical data**

**Input data**

Input signal (can be configured using DIP switches)  
 Temperature range

Measuring range span  
 Linear resistance measuring range

**Output data**

Output signal

Maximum output signal  
 Load  $R_B$   
 Ripple

**General data**

Supply voltage  $U_B$   
 Current consumption  
 Power consumption  
 Transmission error

Temperature coefficient  
 Step response (0–99%)

**Electrical isolation**

Test voltage, input/output/supply  
 Ambient temperature (operation)  
 Dimensions W / H / D  
 Screw connection solid / stranded / AWG  
 Spring-cage connection solid / stranded / AWG  
 EMC note

**Conformance / approvals**

Conformance  
 ATEX  
 UL, USA / Canada

**GL**

**Description**

**Temperature transducer for resistance thermometers**

Standard configuration Screw connection  
 Standard configuration Spring-cage connection

**Programming adapter** for configuring modules with S-PORT interface

Pt, Ni, Cu sensors : 2, 3, 4-wire  
 -200 °C ... 850 °C (range depends on sensor type, range can be set freely via software or in increments via DIP switches)

min. 50 K  
 0 Ω ... 4000 Ω (minimum measuring span: 10% of the selected measuring range)

U output	I output
0 ... 5 V / 1 ... 5 V	0 ... 20 mA / 4 ... 20 mA
0 ... 10 V / 10 ... 0 V	20 ... 0 mA / 20 ... 4 mA
approx. 12.3 V	24.6 mA
10 kΩ	500 Ω (at 20 mA)
< 20 mV <sub>pp</sub>	< 20 mV <sub>pp</sub> (at 500 Ω)

9.6 V DC ... 30 V DC  
 < 27 mA (at 24 V DC)  
 ≤ 700 mW (at I<sub>OUT</sub> = 20 mA, 9.6 V DC, load 500 Ω)  
 0.1 % \* 350 K / set measuring range; 0.1 % > 350 K (Pt/Ni)  
 0.3 % \* 200 K / set measuring range; 0.3 % > 200 K (Cu)

0.01 %/K  
 typ. 200 ms (2-wire)  
 typ. 500 ms (3-wire)  
 typ. 500 ms (4-wire)  
 Basic insulation according to EN 61010  
 1.5 kV (50 Hz, 1 min.)  
 -20 °C ... 65 °C  
 6.2 / 93.1 / 102.5 mm  
 0.2 ... 2.5 mm<sup>2</sup> / 0.2 ... 2.5 mm<sup>2</sup> / 26 - 12  
 0.2 ... 2.5 mm<sup>2</sup> / 0.2 ... 2.5 mm<sup>2</sup> / 24 - 12  
 Class A product, see page 625

CE-compliant  
 Ex II 3 G Ex nA IIC T4 Gc X  
 UL 508 Listed  
 Class I, Div. 2, Groups A, B, C, D T4  
 Class I, Zone 2, Group IIC  
 GL applied for

**Ordering data**

Type	Order No.	Pcs. / Pkt.
MINI MCR-RTD-UI-NC	2902849	1
MINI MCR-RTD-UI-SP-NC	2902850	1

**Accessories**

IFS-USB-PROG-ADAPTER	2811271	1
----------------------	---------	---

Universal temperature transducer for electrical isolation, conversion, amplification, and filtering of resistance thermometers and remote resistance-type sensors

- High level of accuracy over the entire measuring range
- For 2, 3 or 4-wire sensors according to IEC 751, JIS, GOST
- Configurable via DIP switches and software
- Software available free of charge on the Internet
- Power supply possible through the foot element (DIN rail connector)
- Supports fault monitoring
- Standard configuration: Pt 100 IEC 751 sensor; 3-wire; -50 ... 150°C; output 4 ... 20 mA; error evaluation according to NE43 (downscale); fault monitoring contact responds to any errors

**Notes:**

The configuration software can be downloaded from the Internet: phoenixcontact.net/products.

Information on the programming adapters can be found on page 89

Information about power bridging, system cabling, and marking components can be found from page 116

Sensor type	Standard	Measuring range	Smallest measuring range span
Pt100	IEC 751 = GOST 6651-2009 (α = 0.00385)	-200°C ... +850°C	50 K
Pt200	IEC 751 = GOST 6651-2009 (α = 0.00385)	-200°C ... +850°C	50 K
Pt500	IEC 751 = GOST 6651-2009 (α = 0.00385)	-200°C ... +850°C	50 K
Pt1000	IEC 751 = GOST 6651-2009 (α = 0.00385)	-200°C ... +850°C	50 K
Pt100	GOST 6651-2009 (α = 0.00391)	-200°C ... +850°C	50 K
Pt1000	GOST 6651-2009 (α = 0.00391)	-200°C ... +850°C	50 K
Pt100	JIS C1604-1997	-200°C ... +850°C	50 K
Pt1000	JIS C1604-1997	-200°C ... +850°C	50 K
Ni100	DIN 43760	-60°C ... +250°C	50 K
Ni1000	DIN 43760	-60°C ... +250°C	50 K
Cu50	GOST 6651-2009 (α = 1.428)	-180°C ... +200°C	50 K
Cu100	GOST 6651-2009 (α = 1.428)	-180°C ... +200°C	50 K
Cu53	GOST 6651-2009 (α = 1.426)	-50°C ... +180°C	50 K

Customer-specific characteristic curves

Temperature  
Temperature transducer for Pt 100

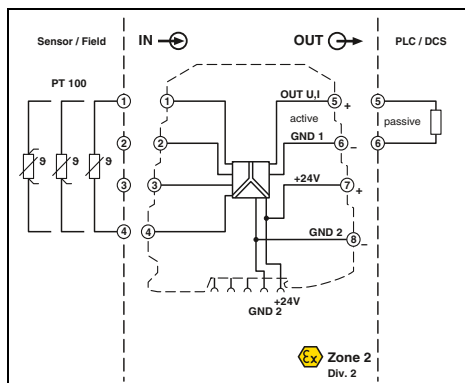
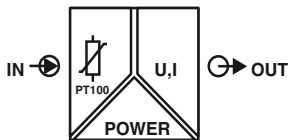

Ex n



Configurable, for a temperature measuring range of -50°C ... +200°C



Housing width 6.2 mm

Technical data

- Highly compact temperature transducer for electrical isolation, conversion, amplification, and filtering of Pt 100 signals to create standard signals
- Optimized temperature measuring range of -50°C to +200°C for increased accuracy
- For 2, 3 or 4-wire Pt 100 sensors according to IEC 60751
- Input and output signals can be configured via DIP switches
- 3-way isolation
- Error signaling via diagnostics LED and analog signal
- Power supply possible through the foot element (DIN rail connector)

Input data	
Input signal (can be configured using DIP switches)	Temperature range
Measuring range span	Output data
Output signal	Output signal
Maximum output signal	Load R <sub>B</sub>
Ripple	General data
Supply voltage U <sub>B</sub>	Current consumption
Power consumption	Transmission error for the full/set measuring range
Temperature coefficient	Step response (0-99%)
Electrical isolation	Test voltage, input/output/supply
Ambient temperature (operation)	Housing material
Dimensions W / H / D	Screw connection solid / stranded / AWG
Spring-cage connection solid / stranded / AWG	EMC note
Conformance / approvals	Conformance
ATEX	UL, USA / Canada
GL	

Pt 100 (IEC 60751/EN 60751): 2, 3, 4-wire	-50 °C ... 200 °C (configurable)
min. 50 K	U output
0 ... 5 V / 1 ... 5 V	I output
0 ... 10 V / 10 ... 0 V	0 ... 20 mA / 4 ... 20 mA
approx. 12.5 V	20 ... 0 mA / 20 ... 4 mA
> 10 kΩ	23 mA
< 20 mV <sub>pp</sub> (at 10 kΩ)	< 500 Ω (at 20 mA)
	< 20 mV <sub>pp</sub> (at 500 Ω)
19.2 V DC ... 30 V DC	
< 21 mA (at 24 V DC)	
< 500 mW	
≤ 0.25%; ((50 K / Δ Temp) + 0.05)%	
< 0.02 %/K	
< 200 ms	
Basic insulation according to EN 61010	
1.5 kV (50 Hz, 1 min.)	
-20 °C ... 65 °C	
PBT	
6.2 / 93.1 / 102.5 mm	
0.2 ... 2.5 mm <sup>2</sup> / 0.2 ... 2.5 mm <sup>2</sup> / 26 - 12	
0.2 ... 2.5 mm <sup>2</sup> / 0.2 ... 2.5 mm <sup>2</sup> / 24 - 12	
Class A product, see page 625	
CE-compliant	
Ex II 3 G Ex nA IIC T4 Gc X	
UL 508 Recognized	
Class I, Div. 2, Groups A, B, C, D T5	
GL EMC 2 D	

**Notes:**  
To order a product with an order configuration, please enter the desired configuration by referring to the order key; see below.  
Information about power bridging, system cabling, and marking components can be found from page 116

Ordering data

Description	Type	Order No.	Pcs. / Pkt.
MCR temperature transducer, for Pt 100 temperature sensors			
Order configuration Screw connection	MINI MCR-SL-PT100-UI-200	2864309	1
Order configuration Spring-cage connection	MINI MCR-SL-PT100-UI-200-SP	2864192	1
Unconfigured Screw connection	MINI MCR-SL-PT100-UI-200-NC	2864370	1
Unconfigured Spring-cage connection	MINI MCR-SL-PT100-UI-200-SP-NC	2864202	1

Order key MINI MCR-SL-PT100-UI-200(-SP) (standard configuration entered as an example)

Order No.	Connection technology	Measuring range [°C]	Output	Failure information 1)	Factory calibration certificate (FCC)
2864309	3	0 ... 100	OUT01	A	NONE
2864309 ≙	2 ≙ 2-wire	0	OUT01 ≙ 0 ... 20 mA	A	NONE ≙ without FCC
MINI MCR-SL-PT100-UI-200	3 ≙ 3-wire	-5	OUT02 ≙ 4 ... 20 mA	B	Yes ≙ with FCC (a fee is charged)
	4 ≙ 4-wire	-10	OUT03 ≙ 0...10 V	C	
		-15	OUT05 ≙ 0...5 V	D	
		-20	OUT06 ≙ 1...5 V		YESPLUS ≙ FCC with 5 measuring points (a fee is charged)
2864192 ≙		-30	OUT07 ≙ 20 ... 0 mA		
MINI MCR-SL-PT100-UI-200-SP		-40	OUT08 ≙ 20 ... 4 mA		
		-50	OUT09 ≙ 10...0 V		

Failure information (depends on the output signal range):					
Overrange			Open circuit		
0 ... 20 mA	4 ... 20 mA	0 ... 10 V	0 ... 20 mA	4 ... 20 mA	0 ... 10 V
A 20.5 mA	20.5 mA	10.25 V	21 mA	21 mA	10.5 V
B 20.5 mA	20.5 mA	10.25 V	21 mA	21 mA	10.5 V
C 20 mA	20 mA	10 V	21 mA	21 mA	10.5 V
D 20 mA	20 mA	10 V	0 mA	4 mA	0 V
Underrange			Short circuit		
0 ... 20 mA	4 ... 20 mA	0 ... 10 V	0 ... 20 mA	4 ... 20 mA	0 ... 10 V
A 0 mA	4 mA	0 V	0 mA	4 mA	0 V
B 0 mA	3.5 mA	0 V	0 mA	3 mA	0 V
C 0 mA	4 mA	0 V	21 mA	21 mA	10.5 V
D 0 mA	4 mA	0 V	0 mA	4 mA	0 V

1) For explanations, see adjacent text on the right; for further details, see data sheet: [www.phoenixcontact.net/products](http://www.phoenixcontact.net/products)

Temperature  
Temperature transducer for Pt 100

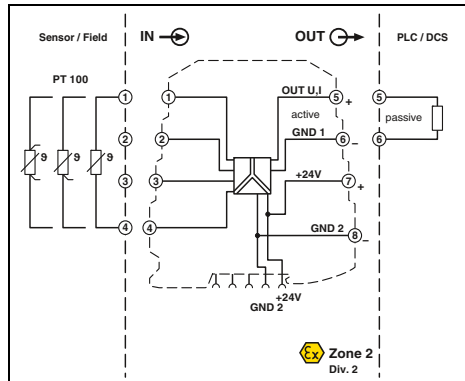
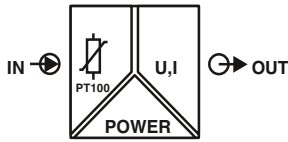

Configurable, for a temperature measuring range of -150°C ... +850°C

CE, UL, IEC, Ex  
Ex: Ex n  
Housing width 6.2 mm

Technical data

**Input data**  
Input signal (can be configured using DIP switches)  
Temperature range  
Measuring range span

**Output data**  
Output signal (configurable using the DIP switch)

Maximum output signal  
Load  $R_B$   
Ripple

**General data**  
Supply voltage  $U_B$   
Current consumption  
Power consumption  
Transmission error for the full/set measuring range

Pt 100 (IEC 60751/EN 60751): 2, 3, 4-wire  
-150 °C ... 850 °C (configurable)  
min. 50 K

U output	I output
0 ... 5 V / 1 ... 5 V	0 ... 20 mA / 4 ... 20 mA
0 ... 10 V / 10 ... 0 V	20 ... 0 mA / 20 ... 4 mA
approx. 12.5 V	23 mA
$\geq 10 \text{ k}\Omega$	< 500 $\mu\text{A}$ (at 20 mA)
< 20 mV <sub>pp</sub> (at 10 k $\Omega$ )	< 20 mV <sub>pp</sub> (at 500 $\Omega$ )

Temperature coefficient  
Step response (0–99%)  
Electrical isolation  
Test voltage, input/output/supply  
Ambient temperature (operation)  
Housing material  
Dimensions W / H / D  
Screw connection solid / stranded / AWG  
Spring-cage connection solid / stranded / AWG  
EMC note

**Conformance / approvals**  
Conformance  
ATEX  
UL, USA / Canada

19.2 V DC ... 30 V DC  
< 21 mA (at 24 V DC)  
< 500 mW  
 $\leq 0.2\%$ ; ((100 K / set measuring range [K]) + 0.1)%

< 0.02 %/K  
< 160 ms  
Basic insulation according to EN 61010  
1.5 kV (50 Hz, 1 min.)  
-20 °C ... 65 °C  
PBT  
6.2 / 93.1 / 102.5 mm  
0.2 ... 2.5 mm<sup>2</sup> / 0.2 ... 2.5 mm<sup>2</sup> / 26 - 12  
0.2 ... 2.5 mm<sup>2</sup> / 0.2 ... 2.5 mm<sup>2</sup> / 24 - 12  
Class A product, see page 625

CE-compliant  
Ex II 3 G Ex nA IIC T4 Gc X  
UL 508 Recognized  
Class I, Div. 2, Groups A, B, C, D T5  
GL EMC 2 D

Ordering data

Description	
<b>MCR temperature transducer, for Pt 100 temperature sensors</b>	
Order configuration	Screw connection
Order configuration	Spring-cage connection
Unconfigured	Screw connection
Unconfigured	Spring-cage connection

Type	Order No.	Pcs. / Pkt.
MINI MCR-SL-PT100-UI	2864435	1
MINI MCR-SL-PT100-UI-SP	2864736	1
MINI MCR-SL-PT100-UI-NC	2864273	1
MINI MCR-SL-PT100-UI-SP-NC	2864286	1

**Notes:**  
To order a product with an order configuration, please enter the desired configuration by referring to the order key; see below.  
Information about power bridging, system cabling, and marking components can be found from page 116

Order key MINI MCR-SL-PT100-UI-(SP) (standard configuration entered as an example)

Order No.	Connection technology	Measuring range [°C]	Output	Failure information 1)	Factory calibration certificate (FCC)
2864435	3	0 ... 100	OUT01	A	NONE
2864435 $\cong$ MINI MCR-SL-PT100-UI	2 $\cong$ 2-wire	0 ... 100 (increment)	OUT01 $\cong$ 0 ... 20 mA OUT02 $\cong$ 4 ... 20 mA OUT03 $\cong$ 0 ... 10 V OUT05 $\cong$ 0...5 V OUT06 $\cong$ 1...5 V	A B C D	NONE $\cong$ without FCC Yes $\cong$ with FCC (a fee is charged)
2864736 $\cong$ MINI MCR-SL-PT100-UI-SP	3 $\cong$ 3-wire 4 $\cong$ 4-wire	0 ... 100 (5 K) 110...300 (10 K) 320...700 (20 K) 750...850 (50 K)	OUT07 $\cong$ 20 ... 0 mA OUT08 $\cong$ 20 ... 4 mA OUT09 $\cong$ 10...0 V		YESPLUS $\cong$ FCC with 5 measuring points (a fee is charged)

Failure information (depends on the output signal range):

	Overrange			Open circuit		
	0 ... 20 mA	4 ... 20 mA	0 ... 10 V	0 ... 20 mA	4 ... 20 mA	0 ... 10 V
A	20.5 mA	20.5 mA	10.25 V	21 mA	21 mA	10.5 V
B	20.5 mA	20.5 mA	10.25 V	21 mA	21 mA	10.5 V
C	20 mA	20 mA	10 V	21 mA	21 mA	10.5 V
D	20 mA	20 mA	10 V	0 mA	4 mA	0 V

	Underrange			Short circuit		
	0 ... 20 mA	4 ... 20 mA	0 ... 10 V	0 ... 20 mA	4 ... 20 mA	0 ... 10 V
A	0 mA	4 mA	0 V	0 mA	4 mA	0 V
B	0 mA	3.5 mA	0 V	0 mA	3 mA	0 V
C	0 mA	4 mA	0 V	21 mA	21 mA	10.5 V
D	0 mA	4 mA	0 V	0 mA	4 mA	0 V

1) For explanations, see adjacent text on the right; for further details, see data sheet: www.phoenixcontact.net/products

Temperature  
Temperature transducer for Pt 100

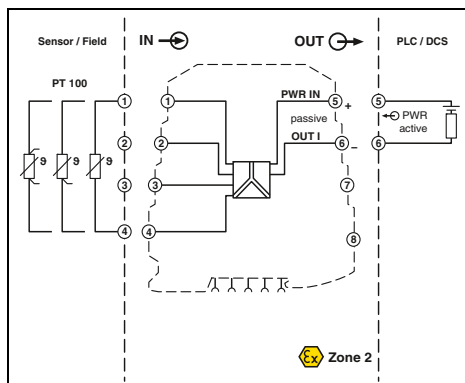
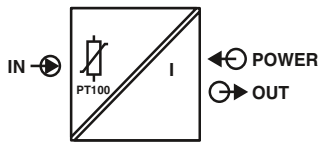

Ex n



Configurable,  
for temperature measuring range -150 ... 300°C,  
output loop-powered



Housing width 6.2 mm

Technical data

- Highly compact output loop-powered temperature transducer for electrical isolation, conversion, amplification, and filtering of Pt 100 signals to create standard signals
- Supplied by an output loop
- Does not require any additional auxiliary voltage
- Temperature measuring range of -150°C to +300°C
- 2, 3 or 4-wire Pt 100 sensors
- Input signals can be configured via DIP switches
- 2-way isolation
- Error signaling via diagnostics LED and analog signal

**Notes:**  
To order a product with an order configuration, please enter the desired configuration by referring to the order key; see below.  
Information about power bridging, system cabling, and marking components can be found from page 116

<b>Input data</b>	Input signal (can be configured using DIP switches) Temperature range Measuring range span
<b>Output data</b>	Output signal Maximum output signal Load $R_B$ Ripple
<b>General data</b>	Supply voltage $U_B$ Current consumption Power consumption Transmission error for the full/set measuring range
	Temperature coefficient Step response (0-99%) Electrical isolation Test voltage, input/output/supply Degree of protection Ambient temperature (operation) Mounting Housing material Dimensions W / H / D Screw connection solid / stranded / AWG Spring-cage connection solid / stranded / AWG EMC note
<b>Conformance / approvals</b>	Conformance ATEX UL, USA / Canada

Pt 100 (IEC 60751/EN 60751): 2, 3, 4-wire -150 °C ... 300 °C (configurable) min. 50 K
4 ... 20 mA / 20 ... 4 mA 23 mA ( $U_{supply} = 12 V$ ) / 22 mA < 20 mV <sub>pp</sub> (at 500 Ω)
12 V DC ... 30 V DC < 3.5 mA (without signal current) < 42 mW (without signal current) ≤ 0.25%; ((90 K / set measuring range [K]) + 0.05)%
< 0.02 %/K < 200 ms Basic insulation according to EN 61010 1.5 kV (50 Hz, 1 min.) IP20 -20 °C ... 65 °C any PBT 6.2 / 93.1 / 102.5 mm 0.2 ... 2.5 mm <sup>2</sup> / 0.2 ... 2.5 mm <sup>2</sup> / 26 - 12 0.2 ... 2.5 mm <sup>2</sup> / 0.2 ... 2.5 mm <sup>2</sup> / 24 - 12 Class A product, see page 625
CE-compliant Ex II 3 G Ex nA IIC T4 Gc X UL 508 Recognized Class I, Div. 2, Groups A, B, C, D T5 applied for

Ordering data

Description	Type	Order No.	Pcs. / Pkt.
<b>MCR temperature transducer</b> , for Pt 100 temperature sensors, output loop-powered			
Order configuration Screw connection	<b>MINI MCR-SL-PT100-LP</b>	<b>2810298</b>	1
Order configuration Spring-cage connection	<b>MINI MCR-SL-PT100-LP-SP</b>	<b>2810382</b>	1
Unconfigured Screw connection	<b>MINI MCR-SL-PT100-LP-NC</b>	<b>2810308</b>	1
Unconfigured Spring-cage connection	<b>MINI MCR-SL-PT100-LP-NC-SP</b>	<b>2810395</b>	1

Order key for MINI MCR-SL-PT100-LP-SP (standard configuration entered as an example)

Order No.	Connection technology	Measuring range [°C] Start End	Output	Failure information <sup>1)</sup>	Factory calibration certificate (FCC)
<b>2810298</b>	<b>3</b>	<b>0</b> / <b>100</b>	<b>OUT02</b>	<b>1</b>	<b>NONE</b>
2810298 ≙ MINI MCR_SL-PT100-LP	2 ≙ 2-wire 3 ≙ 3-wire 4 ≙ 4-wire	0 -10 -20 -30 -40 -50 -100 -150	<b>Range</b> (increment) 0 ... 300 (5 K)	1 2 3 4	NONE ≙ without FCC YES ≙ with FCC (a fee is charged)
2810382 ≙ MINI MCR_SL-PT100-LP-SP			OUT02 ≙ 4 ... 20 mA OUT08 ≙ 20 ... 4 mA		YESPLUS ≙ FCC with 5 measuring points (a fee is charged)

Failure information:	
Overrange	Open circuit
1 -	Start of range
2 21.5 mA	21.5 mA
3 3.5 mA	3.5 mA
4 21.5 mA	21.5 mA
Underrange	Short circuit
1 -	Start of range
2 21.5 mA	21.5 mA
3 3.5 mA	3.5 mA
4 3.5 mA	3.5 mA

<sup>1)</sup> For explanations, see adjacent text on the right; for further details, see data sheet: [www.phoenixcontact.net/products](http://www.phoenixcontact.net/products)

Temperature  
Temperature transducer  
for thermocouples

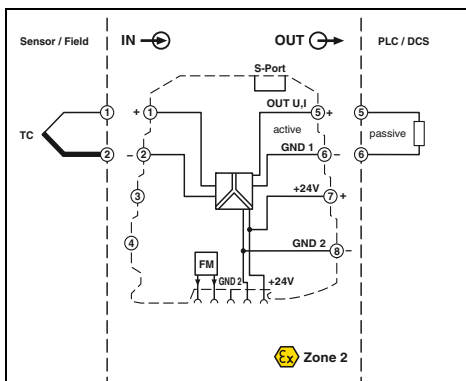
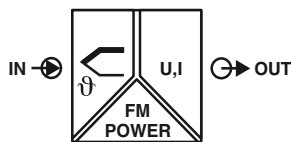

Ex n



Universal measuring transducer for thermocouples

Ex:

Housing width 6.2 mm

Technical data

B, E, J, K, N, R, S, T, L, U, A-1, A-2, A-3, M, L  
-250 °C ... 2500 °C (range depends on sensor type, range can be set freely via software or in increments via DIP switches)

U output	I output
0 ... 5 V / 1 ... 5 V	0 ... 20 mA / 4 ... 20 mA
0 ... 10 V / 10 ... 0 V	20 ... 0 mA / 20 ... 4 mA
approx. 12.3 V	24.6 mA
< 31.5 mA	< 17.5 V
≥ 10 kΩ	< 500 Ω (at 20 mA)
< 20 mV <sub>pp</sub>	< 20 mV <sub>pp</sub> (at 500 Ω)

9.6 V DC ... 30 V DC  
< 27 mA (at 24 V DC)  
≤ 700 mW (at I<sub>OUT</sub> = 20 mA, 9.6 V DC, load 500 Ω)  
0.1 % \* 600 K / set measuring range; 0.1 % > 600 K (E, J, K, N, T, L, U, M Gost, L Gost) 0.2 % \* 600 K / set measuring range; 0.2 % > 600 K (B, R, S, A1, A2, A3)

< 3 K (typ. < 2 K)  
≤ 0.01 %/K  
typ. 400 ms  
Basic insulation according to EN 61010  
1.5 kV (50 Hz, 1 min.)  
-20 °C ... 65 °C  
PBT  
6.2 / 93.1 / 102.5 mm  
0.2 ... 2.5 mm<sup>2</sup> / 0.2 ... 2.5 mm<sup>2</sup> / 26 - 12  
Class A product, see page 625

CE-compliant  
Ex II 3 G Ex nA IIC T4 Gc X  
UL 508 Listed  
Class I, Div. 2, Groups A, B, C, D T4  
Class I, Zone 2, Group IIC  
GL applied for

Ordering data

Type	Order No.	Pcs. / Pkt.
MINI MCR-TC-UI-NC	2902851	1

Accessories

IFS-USB-PROG-ADAPTER	2811271	1
----------------------	---------	---

Input data

Input signal (can be configured using DIP switches)  
Temperature range

Measuring range span

Output data  
Output signal (configurable using the DIP switch)

Maximum output signal

No-load voltage  
Short-circuit current  
Load R<sub>B</sub>  
Ripple

General data

Supply voltage U<sub>B</sub>  
Current consumption  
Power consumption  
Transmission error

Cold junction errors

Temperature coefficient  
Step response (0-99%)  
Electrical isolation  
Test voltage, input/output/supply  
Ambient temperature (operation)  
Housing material  
Dimensions W / H / D  
Screw connection solid / stranded / AWG  
EMC note

Conformance / approvals

Conformance  
ATEX  
UL, USA / Canada

GL

Description

Universal temperature transducer for thermocouples

Standard configuration Screw connection

Programming adapter for configuring modules with S-PORT interface

Highly compact temperature transducer for electrical isolation, conversion, amplification, and filtering of thermocouple signals.

- For thermocouples according to IEC 584 and GOST
- Internal cold junction compensation
- Configurable via DIP switches and software
- Software available free of charge on the Internet
- Power supply possible through the foot element (DIN rail connector)
- Supports fault monitoring
- Standard configuration: TC sensor type J IEC 584 TC; cold junction compensation "ON"; -200 ... 1200°C; 4 ... 20 mA output; error evaluation according to NE43 (downscale); fault monitoring contact responds on any error.

Notes:
Information on the programming adapters can be found on page 89
The configuration software can be downloaded from the Internet: phoenixcontact.net/products.
Information about power bridging, system cabling, and marking components can be found from page 116

Sensor type	Standard	Measuring range
B	IEC 584-1	+500°C ... +1820°C
E	IEC 584-1	-230°C ... +1000°C
J	IEC 584-1	-210°C ... +1200°C
K	IEC 584-1	-250°C ... +1372°C
N	IEC 584-1	-200°C ... +1300°C
R	IEC 584-1	-50°C ... +1768°C
S	IEC 584-1	-50°C ... +1768°C
T	IEC 584-1	-200°C ... +400°C

Sensor type	Standard	Measuring range
L	DIN 43710	-200°C ... +900°C
U	DIN 43710	-200°C ... +600°C
A-1	GOST 8.585	0°C ... +2500°C
A-2	GOST 8.585	0°C ... +1800°C
A-3	GOST 8.585	0°C ... +1800°C
M	GOST 8.585	-200°C ... +100°C
L	GOST 8.585	-200°C ... +800°C

Customer-specific characteristic curves



Temperature, temperature transducer for type J and K thermocouples

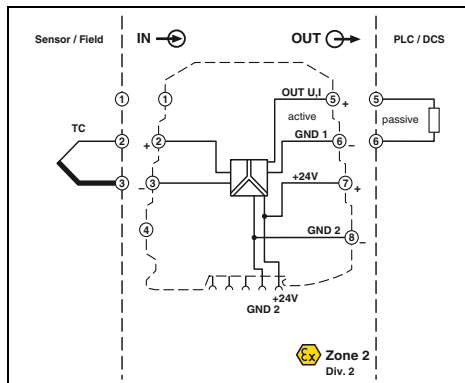
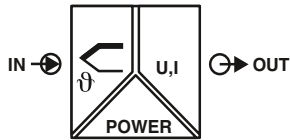

Ex n



Configurable, for a temperature measuring range of -150°C ... +1350°C



Housing width 6.2 mm

Technical data

- Highly compact temperature transducer for electrical isolation, conversion, amplification, and filtering of thermocouple signals to create standard signals
- Temperature measuring range of -150°C to +1350°C
- For J and K thermocouples according to IEC 584-1
- Internal cold junction compensation
- Input and output signals can be configured via DIP switches
- 3-way isolation
- Error signaling via diagnostics LED and analog signal
- Power supply possible through the foot element (DIN rail connector)

<b>Input data</b>	Input signal (can be configured using DIP switches) Temperature range
<b>Measuring range span</b>	
<b>Output data</b>	Output signal (configurable using the DIP switch)
<b>Maximum output signal</b>	No-load voltage Short-circuit current Load $R_B$ Ripple
<b>General data</b>	Supply voltage $U_B$ Current consumption Power consumption Transmission error for the full/set measuring range
<b>Cold junction errors</b>	Temperature coefficient Step response (0-99%) Electrical isolation Test voltage, input/output/supply Ambient temperature (operation) Housing material Dimensions W / H / D Screw connection solid / stranded / AWG EMC note
<b>Conformance / approvals</b>	Conformance ATEX UL, USA / Canada
<b>GL</b>	

Thermocouples, type J, K (IEC 584-1) Type J: -150 °C ... 1200 °C (configurable) Type K: -150 °C ... 1350 °C min. 50 K	
<b>U output</b>	<b>I output</b>
0 ... 5 V / 1 ... 5 V 0 ... 10 V / 10 ... 0 V approx. 12.5 V	0 ... 20 mA / 4 ... 20 mA 20 ... 0 mA / 20 ... 4 mA 23 mA approx. 12.5 V
approx. 10 mA $\geq 10 \text{ k}\Omega$ < 20 mV <sub>pp</sub> (at 10 k $\Omega$ )	< 500 $\Omega$ (at 20 mA) < 20 mV <sub>pp</sub> (at 500 $\Omega$ )
19.2 V DC ... 30 V DC < 25 mA (at 24 V DC) < 500 mW $\leq 0.2\%$ ; ((150 K / set measuring range [K]) + 0.1)%	
< 3 K (typ. < 2 K) < 0.02 %/K < 30 ms Basic insulation according to EN 61010 1.5 kV (50 Hz, 1 min.) -20 °C ... 65 °C PBT 6.2 / 93.1 / 102.5 mm 0.2 ... 2.5 mm <sup>2</sup> / 0.2 ... 2.5 mm <sup>2</sup> / 26 - 12 Class A product, see page 625	
CE-compliant Ex II 3 G Ex nA IIC T4 Gc X UL 508 Recognized Class I, Div. 2, Groups A, B, C, D T5 GL EMC 2 D	

**Notes:**  
To order a product with an order configuration, please enter the desired configuration by referring to the order key; see below.  
Information about power bridging, system cabling, and marking components can be found from page 116

Ordering data

<b>Description</b>	
<b>MCR temperature transducer, for thermocouples</b>	
Order configuration	Screw connection
Unconfigured	Screw connection

Type	Order No.	Pcs. / Pkt.
MINI MCR-SL-TC-UI	2864448	1
MINI MCR-SL-TC-UI-NC	2864299	1

Order key MINI MCR-SL-TC-UI (standard configuration entered as an example)

Order No.	Sensor type	Measuring range [°C]	Output	Failure information <sup>1)</sup>	Factory calibration certificate (FCC)
2864448	J	0 ... 1000	OUT01	A	NONE
	J $\hat{=}$ Type J	0	OUT01 $\hat{=}$ 0 ... 20 mA	A	NONE $\hat{=}$ without FCC
	-10	Range (increment)	OUT02 $\hat{=}$ 4 ... 20 mA	B	Yes $\hat{=}$ with FCC (a fee is charged)
	K $\hat{=}$ Type K	-20	OUT03 $\hat{=}$ 0 ... 10 V	C	
	-30	0 ... 300 (10 K)	OUT04 $\hat{=}$ 0 ... 5 V	D	YESPLUS $\hat{=}$ FCC with 5 measuring points (a fee is charged)
	-40	320 ... 700 (20 K)	OUT05 $\hat{=}$ 1 ... 5 V		
	-50	750 ... 1350 (50 K)	OUT06 $\hat{=}$ 1 ... 5 V		
	-100		OUT07 $\hat{=}$ 20 ... 0 mA		
	-150		OUT08 $\hat{=}$ 20 ... 4 mA		
			OUT09 $\hat{=}$ 10 ... 0 V		

Failure information (depends on the output signal range):					
Overrange			Open circuit		
0 ... 20 mA	4 ... 20 mA	0 ... 10 V	0 ... 20 mA	4 ... 20 mA	0 ... 10 V
A: 20.5 mA	20.5 mA	10.25 V	21 mA	21 mA	10.5 V
B: 20.5 mA	20.5 mA	10.25 V	21 mA	21 mA	10.5 V
C: 20 mA	20 mA	10 V	21 mA	21 mA	10.5 V
D: 20 mA	20 mA	10 V	0 mA	4 mA	0 V
Underrange					
0 ... 20 mA	4 ... 20 mA	0 ... 10 V			
A: 0 mA	4 mA	0 V			
B: 0 mA	3.5 mA	0 V			
C: 0 mA	4 mA	0 V			
D: 0 mA	4 mA	0 V			

<sup>1)</sup> For explanations, see adjacent text on the right; for further details, see data sheet: [www.phoenixcontact.net/products](http://www.phoenixcontact.net/products)

**Frequency  
Frequency transducer  
for up to 80 kHz**

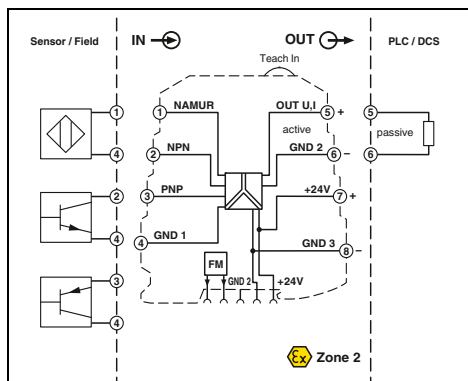
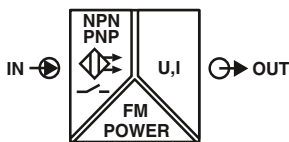

Ex n



Frequency transducer for up to 80 kHz



Ex:

Housing width 6.2 mm

Configurable 3-way isolated frequency transducer.

- Suitable for the connection of NAMUR proximity sensors (IEC 60947-5-6 and EN 50227) as well as for sensors with NPN and PNP outputs that generate a frequency signal
- The device is configured via DIP switches
- Frequency range is freely adjustable via a press/slide button (“teach-in wheel”)
- Supports fault monitoring
- Standard configuration:  
NAMUR sensor; mean-value generation “OFF”; 0.002 Hz ... 20 kHz frequency range; 4 ... 20 mA output; error evaluation NE43 (downscale); fault monitoring contact responds on any error

**Notes:**

Information about power bridging, system cabling, and marking components can be found from page 116

**Input data**

Input sources

Frequency measuring range

Maximum input signal

Output data

Output signal

Maximum output signal

Load  $R_B$

Ripple

General data

Supply voltage  $U_B$

Power consumption

Transmission error of the set measuring span

Temperature coefficient

Step response (0–99%)

Electrical isolation

Test voltage, input/output/supply

Degree of protection

Ambient temperature (operation)

Mounting

Housing material

Dimensions W / H / D

Screw connection solid / stranded / AWG

Spring-cage connection solid / stranded / AWG

EMC note

Conformance / approvals

Conformance

ATEX

UL, USA / Canada

GL

**Technical data**

NPN/PNP transistor outputs

NAMUR initiators

Floating relay contact (dry contact)

0.002 Hz ... 20 kHz (DIP switch)

0.002 Hz ... 80 kHz (teach-in wheel)

30 V (incl. DC voltage)

U output

0 ... 5 V / 1 ... 5 V

0 ... 10 V / 10 ... 0 V

approx. 12.3 V

$\geq 10 \text{ k}\Omega$

$< 20 \text{ mV}_{PP}$

I output

0 ... 20 mA / 4 ... 20 mA

20 ... 0 mA / 20 ... 4 mA

24.6 mA

500  $\Omega$  (at 20 mA)

$< 20 \text{ mV}_{PP}$  (at 500  $\Omega$ )

9.6 V DC ... 30 V DC

$< 800 \text{ mW}$  (at  $I_{OUT} = 20 \text{ mA}$ , 9.6 V DC, load 500  $\Omega$ )

0.1 %

0.01 %/K

$< 35 \text{ ms}$  (at  $f > 500 \text{ Hz}$ )

Basic insulation according to EN 61010

1.5 kV (50 Hz, 1 min.)

IP20

-20 °C ... 65 °C

any

PBT

6.2 / 93.1 / 102.5 mm

0.2 ... 2.5 mm<sup>2</sup> / 0.2 ... 2.5 mm<sup>2</sup> / 26 - 12

0.2 ... 2.5 mm<sup>2</sup> / 0.2 ... 2.5 mm<sup>2</sup> / 24 - 12

Class A product, see page 625

CE-compliant

II 3 G Ex nA IIC T4 Gc X

UL 508 Listed

Class I, Div. 2, Groups A, B, C, D T4

Class I, Zone 2, Group IIC

GL applied for

**Ordering data**

Description

**MCR frequency transducer**

Standard configuration

Screw connection

Standard configuration

Spring-cage connection

Type

**MINI MCR-SL-F-UI-NC**

**MINI MCR-SL-F-UI-SP-NC**

Order No.

**2902832**

**2902833**

Pcs. / Pkt.

1

1



Frequency  
Analog frequency transducer

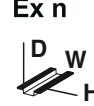
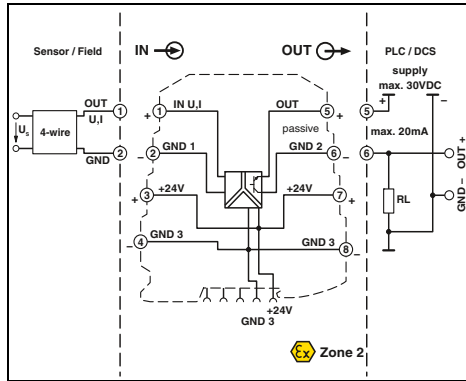
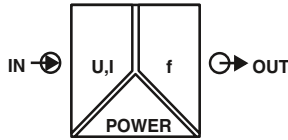

Configurable, frequency and PWM output



Housing width 6.2 mm

- Highly compact analog-to-frequency transducer for electrical isolation, amplification, conversion, and filtering of standard signals to create frequencies or PWM signals
- Configurable interference suppression filter
- Input and output signals can be configured via DIP switches
- 3-way isolation
- Error signaling via diagnostics LED and analog signal
- Power supply possible through the foot element (DIN rail connector)
- PWM output of 5 ... 95%

**Notes:**  
Information about power bridging, system cabling, and marking components can be found from page 116

<b>Input data</b>	Input signal (configurable using the DIP switch)
Maximum input signal	Input resistance
<b>Output data</b>	Output signal (can be configured using DIP switches)
Minimum load	Load current maximum
Maximum switching voltage	Overrange/underrange
Protective circuit	
<b>General data</b>	Supply voltage $U_B$
Nominal supply voltage	Current consumption
Power consumption	Maximum transmission error
Temperature coefficient	Step response (0-99%)
<b>Electrical isolation</b>	Test voltage, input/output/supply
Degree of protection	Ambient temperature (operation)
Mounting	Housing material
Dimensions W / H / D	Screw connection solid / stranded / AWG
Spring-cage connection solid / stranded / AWG	EMC note
<b>Conformance / approvals</b>	Conformance
ATEX	UL, USA / Canada
GL	

Technical data	
<b>U input</b>	<b>I input</b>
0 ... 5 V / 1 ... 5 V	0 ... 20 mA / 4 ... 20 mA
0 ... 10 V / 2 ... 10 V	0 ... 10 mA / 2 ... 10 mA -
30 V DC	100 mA
approx. 110 kΩ	approx. 50 Ω
<b>Frequency output</b>	<b>PWM output</b>
0 Hz ... 10 kHz / 0 Hz ... 5 kHz	7.8 kHz (10 bit) / 3.9 kHz (10 bit)
0 Hz ... 2.5 kHz / 0 Hz ... 1 kHz	1.9 kHz (12 bit) / 977 Hz (12 bit)
0 Hz ... 500 Hz / 0 Hz ... 250 Hz	488 Hz (14 bit) / 244 Hz (14 bit)
0 Hz ... 100 Hz / 0 Hz ... 50 Hz	122 Hz (16 bit) / 61 Hz (16 bit)
$4 \text{ mA} \leq (U_L / R_L) \leq 20 \text{ mA}$	$12 \text{ mA} \leq (U_L / R_L) \leq 20 \text{ mA}$
20 mA	30 V
Can be set (via DIP switch)	Short-circuit protection, polarity reversal protection
19.2 V DC ... 30 V DC	24 V DC
< 10 mA (at 24 V DC)	< 200 mW
$\leq 0.1 \% (> 7 \text{ kHz} \leq 0.2 \%)$	< 0.02 %/K
< 15 ms (+ (1/f) smallest filter)	< 1 s (+ (1/f) largest filter)
Basic insulation according to EN 61010	1.5 kV (50 Hz, 1 min.)
IP20	-20 °C ... 65 °C
any	PBT
6.2 / 93.1 / 102.5 mm	0.2 ... 2.5 mm <sup>2</sup> / 0.2 ... 2.5 mm <sup>2</sup> / 26 - 12
0.2 ... 2.5 mm <sup>2</sup> / 0.2 ... 2.5 mm <sup>2</sup> / 24 - 12	Class A product, see page 625
CE-compliant	Ex II 3 G Ex nA IIC T4 Gc X
UL 508 Recognized	Class I, Div. 2, Groups A, B, C, D T5 applied for
GL EMC 2 D	

<b>Description</b>	Screw connection
<b>MCR Analog frequency transducer</b>	Spring-cage connection

Ordering data		
Type	Order No.	Pcs. / Pkt.
MINI MCR-SL-UI-F	2864082	1
MINI MCR-SL-UI-F-SP	2810243	1

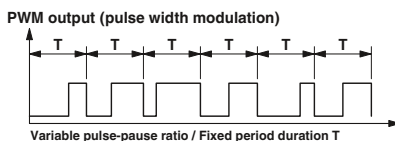
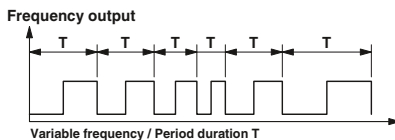

Potentiometers  
Potiposition transducer

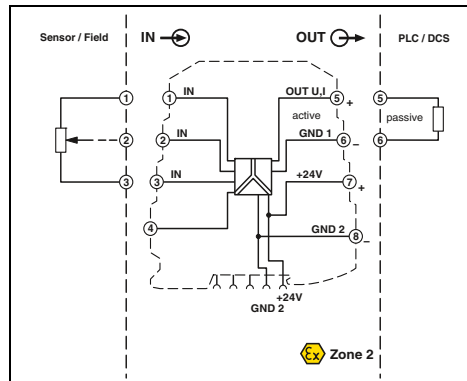
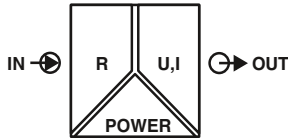

Configurable,  
automatic potentiometer detection



Housing width 6.2 mm

- Highly compact potiposition transducer for electrical isolation, conversion, amplification, and filtering of potentiometer positions to create standard signals
- Automatic potentiometer detection without manual adjustment
- For potentiometers from 100 Ω to 100 kΩ
- Configurable measuring range and output signals
- A potentiometer sub-range can be linearized via the “teach-in” switch on the device
- Input and output signals can be configured via DIP switches
- 3-way isolation
- Error signaling via diagnostics LED and analog signal
- Power supply possible through the foot element (DIN rail connector)

**Notes:**  
Information about power bridging, system cabling, and marking components can be found from page 116

<b>Input data</b>
Potentiometer
Reference voltage source
<b>Output data</b>
Output signal
Maximum output signal
No-load voltage
Short-circuit current
Load $R_B$
Ripple
Behavior in the event of a sensor error
<b>General data</b>
Supply voltage $U_B$
Nominal supply voltage
Current consumption
Power consumption
Maximum transmission error
Temperature coefficient
Step response (0–99%)
Electrical isolation
Test voltage, input/output/supply
Degree of protection
Ambient temperature (operation)
Mounting
Housing material
Dimensions W / H / D
Screw connection solid / stranded / AWG
Spring-cage connection solid / stranded / AWG
EMC note
<b>Conformance / approvals</b>
Conformance
ATEX
UL, USA / Canada
GL

Technical data	
100 Ω ... 100 kΩ	
< 3.6 V	
<b>U output</b>	<b>I output</b>
0 ... 5 V / 1 ... 5 V	0 ... 20 mA / 4 ... 20 mA
0 ... 10 V / 10 ... 0 V	20 ... 0 mA / 20 ... 4 mA
12.5 V	23 mA
	approx. 12.5 V
approx. 10 mA	
> 10 kΩ	< 500 Ω (20 mA)
< 20 mV <sub>PP</sub> (at 10 kΩ)	< 20 mV <sub>PP</sub> (at 500 Ω)
0 % ... 105 % (configurable)	
<b>19.2 V DC ... 30 V DC</b>	
24 V DC	
< 25 mA (at 24 V DC)	
< 500 mW	
< 0.2 %	
< 0.02 %/K	
< 30 ms	
Basic insulation according to EN 61010	
1.5 kV (50 Hz, 1 min.)	
IP20	
-20 °C ... 65 °C	
any	
PBT	
6.2 / 93.1 / 102.5 mm	
0.2 ... 2.5 mm <sup>2</sup> / 0.2 ... 2.5 mm <sup>2</sup> / 26 - 12	
0.2 ... 2.5 mm <sup>2</sup> / 0.2 ... 2.5 mm <sup>2</sup> / 24 - 12	
Class A product, see page 625	
<b>CE-compliant</b>	
Ex II 3 G Ex nA IIC T4 Gc X	
UL 508 Recognized	
Class I, Div. 2, Groups A, B, C, D T5 applied for	
GL EMC 2 D	

Description
<b>MCR potiposition transducer</b>
Screw connection
Spring-cage connection

Ordering data		
Type	Order No.	Pcs. / Pkt.
<b>MINI MCR-SL-R-UI</b>	<b>2864095</b>	1
<b>MINI MCR-SL-R-UI-SP</b>	<b>2810256</b>	1

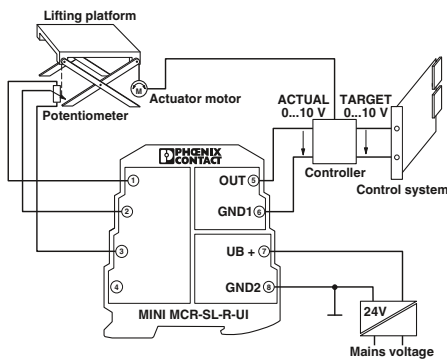

Height adjustment of a lifting platform with setpoint and actual value control

Digital IN  
NAMUR signal conditioner

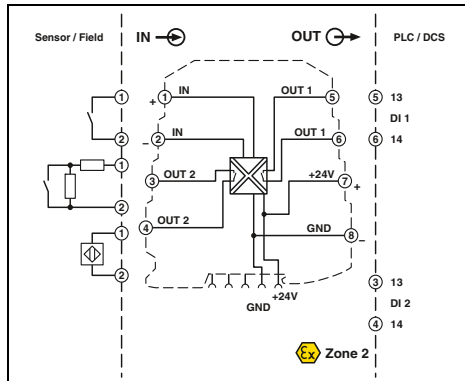
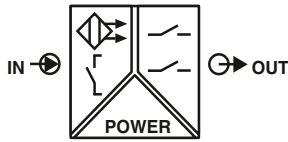

Ex n

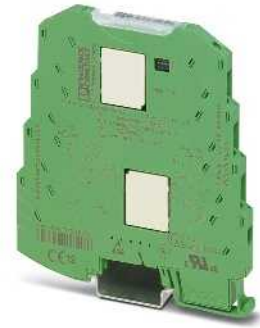

Configurable,  
for NAMUR sensors and  
floating contacts



Housing width 6.2 mm

- Highly compact signal conditioner for electrical isolation, amplification, and duplication of proximity sensor signals
- For proximity sensors in accordance with IEC 60947-5-6 and EN 50227
- Floating contacts and contacts with resistance circuit can be connected
- Input and output signals can be configured via DIP switches
- N/O contacts at output
- Second output can be used as a doubler or error signaling output
- 3-way isolation
- Switchover between operating current and quiescent current (inverted switching behavior)
- Error signaling via diagnostics LED and analog signal
- Power supply possible through the foot element (DIN rail connector)

**Notes:**  
Information about power bridging, system cabling, and marking components can be found from page 116

<b>Input data</b>	Input signal
<b>Control circuit</b>	No-load voltage Switching points (in acc. with IEC 60947-5-6)
<b>Line fault detection</b>	
<b>Switching output</b>	Relay output Contact material Max. switching voltage Max. switching current Min. contact current Switching frequency
<b>General data</b>	Supply voltage $U_B$ Nominal supply voltage Current consumption Power consumption Electrical isolation Test voltage, input/output/supply Degree of protection Ambient temperature (operation) Mounting Housing material Dimensions W / H / D Screw connection solid / stranded / AWG Spring-cage connection solid / stranded / AWG EMC note
<b>Conformance / approvals</b>	Conformance ATEX UL, USA / Canada
<b>GL</b>	

**Technical data**

NAMUR proximity sensors (EN 60947-5-6) open circuit switch contacts Switch contacts with resistance circuit
8.2 V DC $\pm 10\%$ < 1.2 mA (blocking) > 2.1 mA (conductive) > 6 mA (in the event of a short-circuit) < 0.35 mA (in the event of an open circuit)
2 N/O contacts Hard gold-plated AgNi 250 V AC 2 A 1 mA (at 5 V DC) 0.5 Hz (240 V AC / 30 V DC / 2 A) 10 Hz (without load)
19.2 V DC ... 30 V DC 24 V DC < 25 mA < 600 mW Basic insulation according to EN 61010 1.5 kV (50 Hz, 1 min.) IP20 -20 °C ... 65 °C any PBT 6.2 / 93.1 / 102.5 mm 0.2 ... 2.5 mm <sup>2</sup> / 0.2 ... 2.5 mm <sup>2</sup> / 26 - 12 0.2 ... 2.5 mm <sup>2</sup> / 0.2 ... 2.5 mm <sup>2</sup> / 24 - 12 Class A product, see page 625
CE-compliant Ex II 3 G Ex nA nC IIC T4 Gc X UL 508 Recognized Class I, Div. 2, Groups A, B, C, D T5 applied for GL EMC 2 D

**Ordering data**

Description	Type	Order No.	Pcs. / Pkt.
<b>MCR NAMUR signal conditioner</b>	Screw connection	<b>MINI MCR-SL-NAM-2RNO</b>	1
	Spring-cage connection	<b>MINI MCR-SL-NAM-2RNO-SP</b>	1

Limit values, threshold value switch

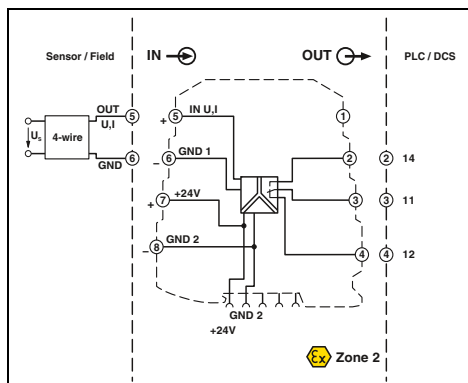
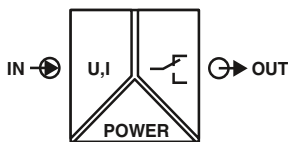

Ex n



Configurable, with relay PDT output



Housing width 6.2 mm

- Highly compact threshold value switch for switching analog limit values
- Input signal, hysteresis, and delay time can be configured via DIP switches
- Limit value can be freely adjusted via potentiometer on front
- 3-way isolation
- PDT relay at output
- Operating current/quiescent current switchover
- Status and error signaling via two diagnostics LEDs
- Power supply possible through the foot element (DIN rail connector)

**Notes:**  
Information about power bridging, system cabling, and marking components can be found from page 116

<b>Input data</b>	U input 0 ... 10 V	I input 0 ... 20 mA
Maximum input signal	30 V	100 mA
Input resistance	> 100 kΩ	50 Ω
Specification of the switching point	With 25-speed potentiometer	
<b>Switching output</b>	1 PDT AgSnO <sub>2</sub> , hard gold-plated 250 V AC 2 A 0.1 %; 1 %; 2.5 %; 5 %	
Relay output	Can be selected via DIP switch	
Contact material	0 s ... 10 s (0 s; 1 s; 2 s; 3 s; 4 s; 6 s; 8 s; 10 s)	
Max. switching voltage		
Limiting continuous current		
Hysteresis (configurable using the DIP switch)		
Operating and closed-circuit current behavior		
Setting range of the response delay (configurable using the DIP switch)		
<b>General data</b>	19.2 V DC ... 30 V DC 24 V DC ±15 % < 14 mA (at 24 V DC) < 330 mW (at 24 V DC) - < 0.02 %/K < 35 ms Basic insulation according to EN 61010 1.5 kV AC (50 Hz, 1 min.) IP20 -20 °C ... 65 °C any PBT 6.2 / 93.1 / 102.5 mm 0.2 ... 2.5 mm <sup>2</sup> / 0.2 ... 2.5 mm <sup>2</sup> / 26 - 12 0.2 ... 2.5 mm <sup>2</sup> / 0.2 ... 2.5 mm <sup>2</sup> / 24 - 12 Class A product, see page 625	
Supply voltage U <sub>B</sub>		
Nominal supply voltage		
Current consumption		
Power consumption		
Linearity error		
Temperature coefficient		
Step response (0-99%)		
Electrical isolation		
Test voltage input/power supply		
Degree of protection		
Ambient temperature (operation)		
Mounting		
Housing material		
Dimensions W / H / D		
Screw connection solid / stranded / AWG		
Spring-cage connection solid / stranded / AWG		
EMC note		
<b>Conformance / approvals</b>	CE-compliant Ex II 3 G Ex nA nC IIC T4 Gc X UL 508 Recognized Class I, Zone 2, AEx nA nC IIC T5 Class I, Zone 2, Ex nA nC IIC T5 Gc GL EMC 2 D	
Conformance		
ATEX		
UL, USA / Canada		
UL, USA		
UL, Canada		
GL		

Technical data

<b>Ordering data</b>			
<b>Description</b>	<b>Type</b>	<b>Order No.</b>	<b>Pcs. / Pkt.</b>
<b>MCR threshold value switch</b>			
Screw connection	MINI MCR-SL-UI-REL	2864480	1
Spring-cage connection	MINI MCR-SL-UI-REL-SP	2864493	1

Accessories,  
constant voltage source

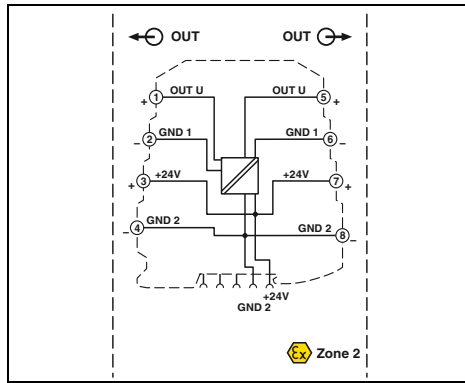
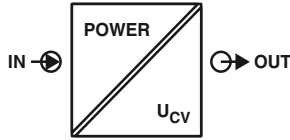

Ex n



Configurable,  
output signals: 2.5 V / 5 V / 7.5 V / 10 V



Ex:

Housing width 6.2 mm

- Constant voltage source for potentiometers, measuring bridges, encoders
- Highly precise
- Input signal corresponds to power supply
- Input signal and, in turn, the power supply can be provided via the foot element (DIN rail connector)
- Standard configuration: Output 10 V DC

<b>Input data</b>	
Input signal	9.6 ... 30 V
<b>Output data</b>	
Output signal (can be configured using DIP switches)	10 V DC 7.5 V DC 5 V DC 2.5 V DC approx. 32 mA < 20 mV <sub>pp</sub>
<b>Short-circuit current</b>	
Ripple	
<b>General data</b>	
Supply voltage U <sub>B</sub>	9.6 V DC ... 30 V DC
Power consumption	< 600 mW (at 24 V IN)
Maximum transmission error	≤ 0.1 % (of final value)
Temperature coefficient	< 0.01 %/K, typ. < 0.002 %/K
Electrical isolation	Basic insulation according to EN 61010
Test voltage input/output	1.5 kV (50 Hz, 1 min.)
Degree of protection	IP20
Ambient temperature (operation)	-20 °C ... 65 °C
Housing material	PBT
Dimensions W / H / D	6.2 / 93.1 / 102.5 mm
Screw connection solid / stranded / AWG	0.2 ... 2.5 mm <sup>2</sup> / 0.2 ... 2.5 mm <sup>2</sup> / 26 - 12
Spring-cage connection solid / stranded / AWG	0.2 ... 2.5 mm <sup>2</sup> / 0.2 ... 2.5 mm <sup>2</sup> / 24 - 12
EMC note	Class A product, see page 625
<b>Conformance / approvals</b>	
Conformance	CE-compliant
ATEX	II 3 G Ex nA IIC T4 Gc X
UL, USA / Canada	UL 508 Listed Class I, Div. 2, Groups A, B, C, D T6 Class I, Zone 2, Group IIC

Technical data

<b>Input data</b>	
Input signal	9.6 ... 30 V
<b>Output data</b>	
Output signal (can be configured using DIP switches)	10 V DC 7.5 V DC 5 V DC 2.5 V DC approx. 32 mA < 20 mV <sub>pp</sub>
<b>Short-circuit current</b>	
Ripple	
<b>General data</b>	
Supply voltage U <sub>B</sub>	9.6 V DC ... 30 V DC
Power consumption	< 600 mW (at 24 V IN)
Maximum transmission error	≤ 0.1 % (of final value)
Temperature coefficient	< 0.01 %/K, typ. < 0.002 %/K
Electrical isolation	Basic insulation according to EN 61010
Test voltage input/output	1.5 kV (50 Hz, 1 min.)
Degree of protection	IP20
Ambient temperature (operation)	-20 °C ... 65 °C
Housing material	PBT
Dimensions W / H / D	6.2 / 93.1 / 102.5 mm
Screw connection solid / stranded / AWG	0.2 ... 2.5 mm <sup>2</sup> / 0.2 ... 2.5 mm <sup>2</sup> / 26 - 12
Spring-cage connection solid / stranded / AWG	0.2 ... 2.5 mm <sup>2</sup> / 0.2 ... 2.5 mm <sup>2</sup> / 24 - 12
EMC note	Class A product, see page 625
<b>Conformance / approvals</b>	
Conformance	CE-compliant
ATEX	II 3 G Ex nA IIC T4 Gc X
UL, USA / Canada	UL 508 Listed Class I, Div. 2, Groups A, B, C, D T6 Class I, Zone 2, Group IIC

Ordering data

Type	Order No.	Pcs. / Pkt.
MINI MCR-SL-CVS-24-5-10-NC	2902822	1
MINI MCR-SL-CVS-24-5-10-SP-NC	2902823	1

Accessories

EMG 30-SP- 4K7LIN	2940252	10
EMG 30-SP-10K LIN	2942124	10

<b>Description</b>	
<b>MCR constant voltage source</b>	Screw connection Spring-cage connection
<b>Setpoint potentiometer</b> , for individual setpoint definition	
Resistance value 4.7 kΩ	
Resistance value 10 kΩ	

**Accessories**

**Programming adapter**

The IFS-USB-PROG-ADAPTER programming adapter is used for configuring Phoenix Contact INTERFACE modules with S-Port interface.

The adapter is used with FDT/DTM software or ANALOG-CONF software. For programming MACX Analog, MINI Analog Pro, and MINI Analog.



Ex:

General data
EMC note

Technical data	
Class A product, see page 625	

Description
<b>Programming adapter</b> for configuring modules with S-PORT interface

Ordering data		
Type	Order No.	Pcs. / Pkt.
IFS-USB-PROG-ADAPTER	2811271	1

Accessories

Feed-through terminal block

- Feed-through terminal block for 1:1 forwarding of signals in the MINI Analog group
- For plugging gaps in system cabling with the V8 system adapter, e.g., when there are fewer than eight signals
- Used in conjunction with the MINI Analog multiplexer
- For direct mounting in the case of applications without signal conversion and without electrical isolation

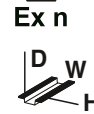
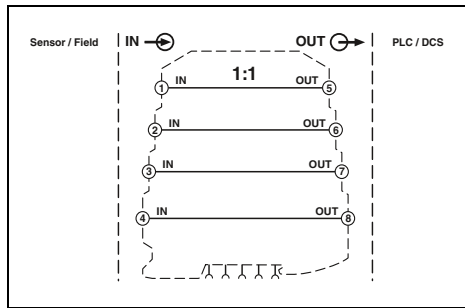

1:1 connection

General data	
Degree of protection	IP20
Ambient temperature (operation)	-20 °C ... 65 °C
Mounting	any
Housing material	PBT
Dimensions W / H / D	6.2 / 93.1 / 102.5 mm
Screw connection solid / stranded / AWG	0.2 ... 2.5 mm <sup>2</sup> / 0.2 ... 2.5 mm <sup>2</sup> / 24 - 12
Conformance / approvals	
ATEX	Ex II 3 G Ex nA IIC T4 Gc X
GL	GL EMC 2 D

Technical data		
Degree of protection	IP20	
Ambient temperature (operation)	-20 °C ... 65 °C	
Mounting	any	
Housing material	PBT	
Dimensions W / H / D	6.2 / 93.1 / 102.5 mm	
Screw connection solid / stranded / AWG	0.2 ... 2.5 mm <sup>2</sup> / 0.2 ... 2.5 mm <sup>2</sup> / 24 - 12	
Conformance / approvals		
ATEX	Ex II 3 G Ex nA IIC T4 Gc X	
GL	GL EMC 2 D	

Description	
<b>MINI Analog feed-through terminal block</b>	

Ordering data		
Type	Order No.	Pcs. / Pkt.
MINI MCR-SL-TB	2811420	1

Screw connection

Accessories

Fault signaling module

- Fault monitoring module for evaluating and reporting group errors from the fault monitoring system.
- Monitoring of supply voltages of MINI MCR-SL-PTB-FM(-SP) power terminals
  - Drawing off the supply is possible
  - The error is reported via an N/C contact
  - Standard configuration: group error detection "ON"; redundancy monitoring "ON"; relay "active"

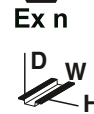
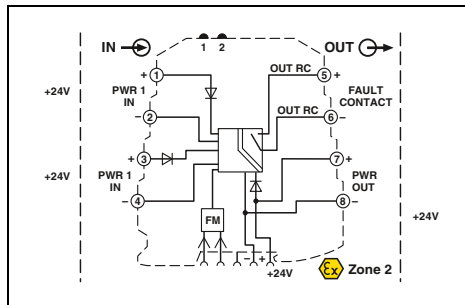

Group error indication and supply monitoring

Input data/output data	
Input signal	9.6 V DC ... 30 V DC
Output signal	8.8 V DC ... 29.2 V DC
Output signal maximum current	2 A
Switching output	
Max. switching voltage	30 V AC/DC
Max. switching current	50 mA
Test voltage input/output	1.5 kV AC (50 Hz, 1 min.)
EMC note	Class A product, see page 625
Conformance / approvals	
ATEX	Ex II 3 G Ex nA nC IIC T4 Gc X
UL, USA / Canada	UL 508 Listed Class I, Div. 2, Groups A, B, C, D T 4 Class I, Zone 2, Group IIC
GL	GL applied for

Technical data		
Input signal	9.6 V DC ... 30 V DC	
Output signal	8.8 V DC ... 29.2 V DC	
Output signal maximum current	2 A	
Switching output		
Max. switching voltage	30 V AC/DC	
Max. switching current	50 mA	
Test voltage input/output	1.5 kV AC (50 Hz, 1 min.)	
EMC note	Class A product, see page 625	
Conformance / approvals		
ATEX	Ex II 3 G Ex nA nC IIC T4 Gc X	
UL, USA / Canada	UL 508 Listed Class I, Div. 2, Groups A, B, C, D T 4 Class I, Zone 2, Group IIC	
GL	GL applied for	

Description	
<b>MINI Analog fault signaling module</b>	
Standard configuration	Screw connection
Standard configuration	Spring-cage connection

Ordering data		
Type	Order No.	Pcs. / Pkt.
MINI MCR-SL-FM-RC-NC	2902961	1
MINI MCR-SL-FM-RC-SP-NC	2902962	1



Accessories

Power terminal

- For up to 80 MINI Analog modules
- The MINI MCR-SL-PTB-FM(-SP) power terminal is used to supply the supply voltage to the DIN rail connector
- Monitoring of supplies in combination with the fault monitoring module
- Flexible redundant supply from one or both module sides
- Extended supply voltage range from 0 ... 30 V DC

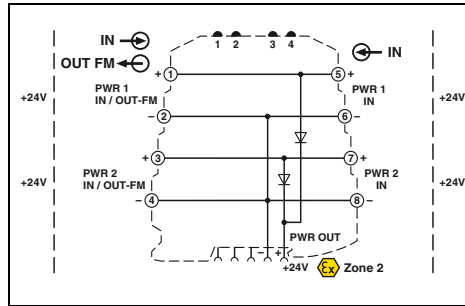

Power terminal, can be monitored

Input data/output data
Input voltage range
Output voltage
Output current
General data
EMC note
Conformance / approvals
Conformance
ATEX
UL, USA / Canada
GL

Technical data

0 V DC ... 30 V DC
Input voltage - 0.8 V
≤ 2 A
Class A product, see page 625
CE-compliant
Ex II 3 G Ex nA IIC T4 Gc X
UL 508 Listed
Class I, Div. 2, Groups A, B, C, D T4
Class I, Zone 2, Group IIC
GL applied for

Description
<b>MINI Analog power terminal</b>
Screw connection
Spring-cage connection

Ordering data

Type	Order No.	Pcs. / Pkt.
MINI MCR-SL-PTB-FM	2902958	1
MINI MCR-SL-PTB-FM-SP	2902959	1

Accessories

Marking material

- Flexible marking system with hinged transparent cover and matching insert strips
- Transparent cover that can be snapped onto the module instead of the standard cover
- Insert strips on pre-punched paper sheets
- Marking option for standard cover in the form of ZBF 6 zack marker strip marking labels



Transparent cover with insert strips

Description
<b>Hinged transparent cover</b> , for marking MINI Analog modules with insert strips

Ordering data

Type	Order No.	Pcs. / Pkt.
MINI MCR DKL	2308111	10

<b>Insert strips</b> , stamped, for transparent cover
---

Accessories

MINI MCR-DKL-LABEL	2810272	10
--------------------	---------	----

<b>Zack marker strip</b> , flat
UniCard sheets, for marker groove

ZBF 6 (see Catalog 5)
UC-TMF 6 (see Catalog 5)

### Accessories

#### ME 6,2 TBUS... DIN rail connector

- For bridging the supply voltage
- Reduces wiring costs
- Module replacement without interrupting the supply to the remaining modules (hot swappable)
- One DIN rail connector for two MINI Analog modules



For bridging the supply voltage

Description
<b>DIN rail connector (TBUS)</b> , for bridging the supply voltage, can be snapped onto 35 mm DIN rails as per EN 60715, with UL approval
Color: green

Ordering data		
Type	Order No.	Pcs. / Pkt.
ME 6,2 TBUS-2 1,5/5-ST-3,81 GN	2869728	10

### Accessories

#### Power terminal

- For supplying the supply voltage via the foot element (DIN rail connector) where DC voltages of up to 30 V are already available
- Option of redundant supply decoupled from diode
- For up to 80 MINI Analog modules
- For up to 2 A
- Status and error signaling via diagnostics LEDs

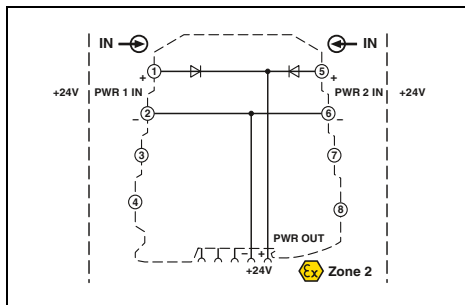

Redundant supply for existing 24 V

**Notes:**  
**Recommended fuse for power terminal:**  
 Fuse in acc. with IEC 60127-2/V  
 Nominal current: 2.5 A  
 Characteristics: slow-blow  
 (e.g., Wickmann 5 x 20 mm/No. 195 - glass fuse)

Input data
Input voltage range
Output data
Output voltage
Output current
General data
Ambient temperature (operation)
Housing material
EMC note
Conformance / approvals
Conformance
ATEX
UL, USA / Canada
GL

Technical data	
Input voltage range	20 V DC ... 30 V DC
Input voltage - 0.8 V	≤ 2 A
Ambient temperature (operation)	-20 °C ... 65 °C
Housing material	PBT
EMC note	Class A product, see page 625
Conformance / approvals	CE-compliant
Conformance	II 3 G Ex nA IIC T4 Gc X
ATEX	UL 508 Recognized
UL, USA / Canada	Class I, Div. 2, Groups A, B, C, D T5
GL	GL EMC 2 D

Description
<b>MCR power terminal</b>
Screw connection
Spring-cage connection

Ordering data		
Type	Order No.	Pcs. / Pkt.
MINI MCR-SL-PTB	2864134	1
MINI MCR-SL-PTB-SP	2864147	1

**Accessories****ME 17,5 TBUS-... DIN rail connector**

- For bridging the supply voltage when using a MINI POWER system power supply

**Notes:**

If the system power supply is used, two ME 17,5 TBUS DIN rail connectors are required. This allows you to establish the connection to the ME 6,2 TBUS DIN rail connector of the MINI Analog system and provide an effective power supply.



For system power supply

Description	Ordering data		
	Type	Order No.	Pcs. / Pkt.
<b>DIN rail connector</b> , for bridging the supply voltage, can be snapped onto 35 mm DIN rails as per EN 60715, with UL approval, two pieces are required per system power supply	ME 17,5 TBUS 1,5/ 5-ST-3,81 GN	2709561	10

**Accessories****System power supply**

- For supplying the supply voltage via the DIN rail connector where AC voltages are available
- Nominal input voltage range 100 ... 240 V AC
- 24 V DC output voltage
- For up to 60 MINI Analog modules
- For up to 1.5 A, secondary
- Status and error signaling via diagnostics LEDs



For applications with local voltages of over 100 V

Description	Ordering data		
	Type	Order No.	Pcs. / Pkt.
<b>System power supply</b> , primary-switched, with zone 2 approval. Further information can be found in Catalog 6, Surge protection and power supplies.	MINI-PS-100-240AC/24DC/1.5/EX	2866653	1
<b>System power supply</b> , primary-switched (not for zone 2) Further information can be found in Catalog 6, Surge protection and power supplies.	MINI-SYS-PS-100-240AC/24DC/1.5	2866983	1

### Accessories

#### System cabling

A high number of channels enables analog signal transmission across 6 mm in a confined space for many applications. In this kind of context, in particular, it is really important to have access to wiring solutions that avoid errors and are time-efficient, thereby cutting costs.

The MINI Analog system cabling solution allows you to wire up to eight channels quickly, easily, and without errors.

System cabling can take various forms.

#### System cabling with a front adapter

This includes:

- A 16-pos. FLK cable
- The V8 system adapter for MINI Analog modules
- A front adapter that needs to be specifically selected based on the analog card of the controller

With this solution, all you need to do is connect the components together. There is virtually no wiring effort involved. What's more, it completely rules out wiring errors, as the pre-assembled components ensure correct assignment by virtue of their design.

#### System cabling without a front adapter

The version that does not require the use of a front adapter is the ideal addition.

This solution involves using a 16-pos. FLK cable with open ends on one side. The open ends are fitted with ferrules and are numbered. This allows you to create a system cabling connection to virtually any module without having to fit a front adapter. The other advantage is that you can implement system cabling on the module side quickly, easily, and without errors.

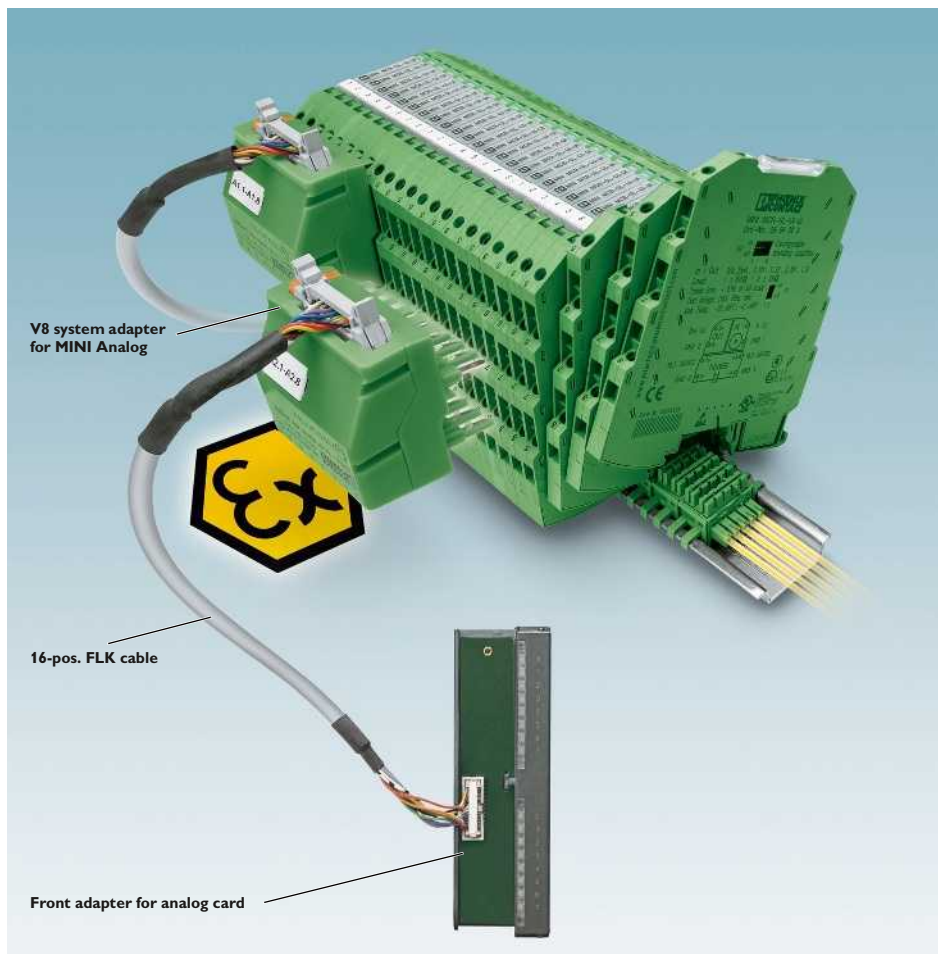

System cabling with a front adapter

The tables below are designed to serve as a configuration aid. Details of other solutions are available on the Internet or on request.

Configuration aid for MINI Analog system cabling				
Controller	Analog card	Front adapter	FLK cable	V8 system adapter for MINI Analog
Siemens SIMATIC S7-300 / ET 200 M	6ES7-331-7KF02-0AB0	FLKM 16-PA-S300/MINI-MCR (in the catalog on page 522)	FLK 16/EZ-DR/.../KONFEK (non-molded plugs, in the catalog on page 606)	MINI MCR-SL-V8-FLK 16-A (in the catalog on page 122)
	6ES7-331-7KB02-0AB0			
	6ES7-331-7KB81-0AB0			
	6ES7-331-7TF00-0AB0			
	6ES7-332-8TF01-0AB0			
	6ES7-331-1KF01-0AB0 (for current signals)	FLKM 16-PA-331-1KF//MINI-MCR (in the catalog on page 523)		
	6ES7-331-5HF00-0AB0 (for current signals)	FLKM 16-PA-332-5HF//MINI-MCR (in the catalog on page 523)		
Yokogawa Centum CS 3000 R3	AAI 141	Not required	CABLE-40/2/FLK16/.../YUC (non-molded plugs, in the catalog on page 535)	2 x MINI MCR-SL-V8-FLK 16-A (in the catalog on page 122)
	AAI 143			
Miscellaneous controllers / actuators / sensors	All cards	Not required	CABLE-FLK16/OE/0,14/...M (non-molded plugs, in the catalog on page 602)	MINI MCR-SL-V8-FLK 16-A (in the catalog on page 122)
			or alternatively VIP-CAB-FLK16/FR/OE/0,14/...M (molded plugs, in the catalog on page 602)	

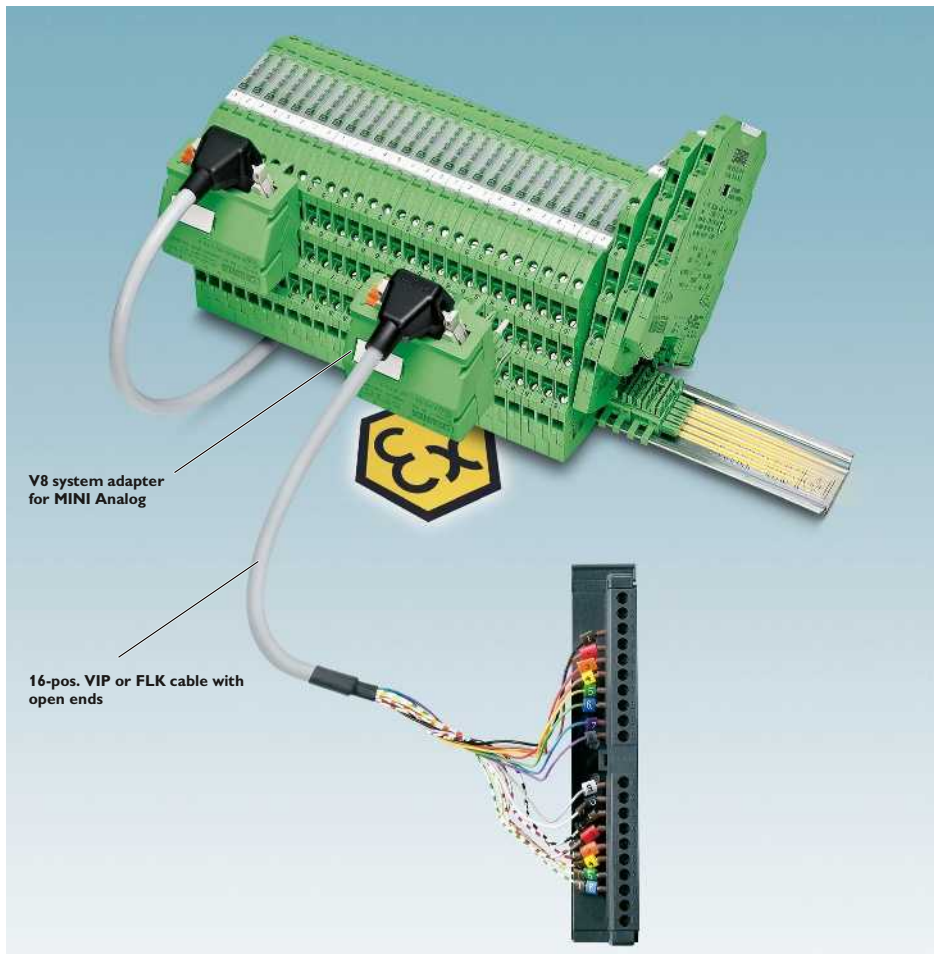

V8 system adapter  
for MINI Analog

16-pos. VIP or FLK cable with  
open ends

System cabling without a front adapter

### Innovative concept

Thanks to its innovative design concept, the MINI MCR-SL-V8-FLK 16 A MINI Analog system adapter can be used on both the input and output side. Consequently, there is nothing at all to prevent you from using the same components for system cabling on both output and input modules.

### Complete flexibility

The proven FLK cable series offers complete flexibility in terms of selection and is the ideal solution for system cabling with a front adapter. The flat and flexible plug connections mean that the products can be easily installed in any analog module.

### Increased protection

The new VIP cables with molded FLK plugs offer enhanced protection in harsh industrial environments. If you opt for system cabling without a front adapter, you can enjoy all the advantages of the new VIP cables on the system adapter side.

### Addition

If the application demands a form of system cabling with fewer than eight channels, the MINI MCR-SL-TB feed-through terminal block (page 116) represents the perfect addition.



Plug-in connection



Innovative concept



Complete flexibility



Increased protection



Addition



### Accessories

#### MINI Analog system adapter

- Time-saving wiring solution thanks to unique plug-in concept
- System cabling on PLC side
- Plug and Play
- For up to eight channels
- Reduces wiring costs and errors



System adapter



Housing width 50.4 mm

#### Technical data

<b>General data</b>	
Contact resistance	< 10 mΩ
Current carrying capacity	≤ 1 A
Test voltage	-
Vibration resistance	≤ 0,7 g
Surge voltage category / Pollution degree	III / 2
Ambient temperature (operation)	-20 °C ... 60 °C
Housing material	PBT
Dimensions W / H / D	50.4 / 46.2 / 45.5 mm
Connection to the signal level	Flat-ribbon cable connector in acc. with IEC 60603-13
Insertion/withdrawal cycles (system adapter / FLK 16)	10 / ≥ 200
<b>Conformance / approvals</b>	
ATEX	Ex II 3 G Ex nA IIC T4 Gc X
UL, USA / Canada	UL 508 Recognized Class I, Div. 2, Groups A, B, C, D T5 applied for
GL	GL EMC 2 D

#### Ordering data

<b>Description</b>		<b>Type</b>	<b>Order No.</b>	<b>Pcs. / Pkt.</b>
<b>System adapter</b> , for MINI Analog modules with screw connection		<b>MINI MCR-SL-V8-FLK 16-A</b>	<b>2811268</b>	<b>1</b>

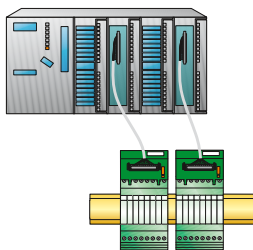

MINI Analog system cabling

Accessories,  
MINI Analog multiplexer

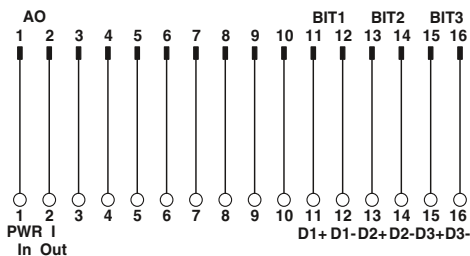
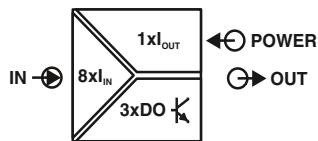
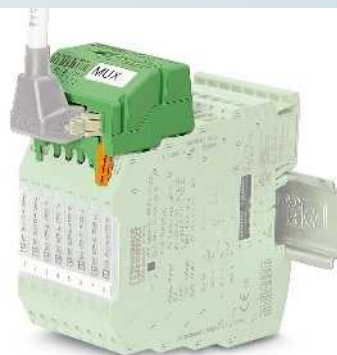

FLK pin strip assignment

Ex: Ex n

Housing width 50.4 mm

Technical data

Input data

Description  
Can be configured/parameterized  
Input signal  
Maximum input signal  
Switching cycles

Output data

Output signal  
Maximum output signal  
Load  $R_B$   
Status indication active input

Switching output

Maximum switching voltage

General data

Supply voltage  $U_B$   
Current consumption  
Power consumption  
Maximum transmission error  
Temperature coefficient  
Ambient temperature (operation)  
Housing material  
Dimensions W / H / D  
Connection to control level

Insertion/withdrawal cycles (system adapter / FLK 16)

EMC note

Conformance / approvals

Conformance  
ATEX  
UL, USA / Canada

2, 4, 6 or 8-channel (can be selected)  
Via DIP switches  
4 ... 20 mA  
< 30 mA  
2 or 1 sec. (can be selected)

4 ... 20 mA

< 30 mA

$(U_{supply} \sim 7 V) / I_{max}$

1, 2, 3-bit digital output (can be selected)

3 x PNP optocouplers

30 V DC

7 V DC ... 30 V DC (loop-powered)

< 3.5 mA (without signal current)

< 24 mW (without signal current)

0.3 % (0.1%, typical)

< 0.01 %/K

-20 °C ... 65 °C

PBT

50.4 / 45.5 / 46.2 mm

Flat-ribbon cable connector in acc. with IEC 60603-13

10 /  $\geq$  200

Class A product, see page 625

CE-compliant

Ex II 3 G Ex nA IIC T4 Gc X

UL 508 Recognized applied for

Class I, Div. 2, Groups A, B, C, D T5 applied for

Ordering data

Type	Order No.	Pcs. / Pkt.
MINI MCR-SL-MUX-V8-FLK 16	2811815	1

Accessories

MINI MCR-SL-TB	2811420	1
VIP-CAB-FLK16/FR/OE/0,14/...		
CABLE-FLK16/OE/0,14/...		

- Generates an analog output from up to eight analog input signals – parallel analog signals are transmitted serially via a cable
- The desired number of channels is selected via DIP switches (8, 6, 4 or 2 channels).
- The channel currently switched is indicated as a bit pattern via three digital outputs
- Two clock cycles for execution can be selected via DIP switches (one or two-second clock)
- Supplied by an output loop
- For 4 ... 20 mA current signals
- Can be easily snapped onto MINI Analog modules with screw connection technology
- Huge reduction in analog inputs at controllers
- System cabling on the output side using pre-assembled FLK cables with open ends.

Notes:

For six, four or two channels you will also need the corresponding number of feed-through terminal blocks (i.e., two, four or six).

Description

Multiplexer for MINI Analog modules with screw connection

MINI Analog feed-through terminal block

For round cable with one open end, see "System cabling for controllers" section

For round cable with one open end, see "System cabling for controllers" section

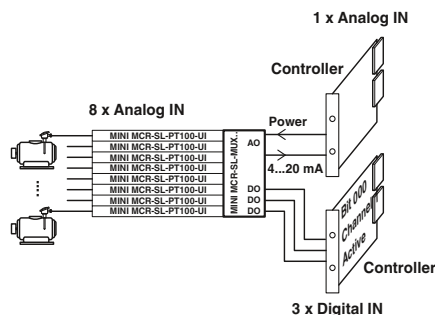

Monitoring of eight motor temperatures with just one analog control input



### Termination Carriers for MINI Analog signal conditioners



**TC... Termination Carriers** are compact solutions for conveniently and smoothly connecting standard DIN rail signal conditioners from the MINI Analog series to input/output cards of automation systems using system cables.

The most compact signal conditioners combined with the most compact and flexible module carriers on the market enable you to achieve a hitherto unparalleled packing density in your control cabinet together with professional system cabling.

#### Compact

- The compact design associated with MINI Analog saves up to 65% of space in the control cabinet

#### Robust and reliable

- Stable, vibration-resistant aluminum carrier device profile
- PCB is completely decoupled from signal conditioners
- PCB without active electronics
- Redundant supply via separate DIN rail module
- Horizontal or vertical DIN rail mounting

#### Flexible

- Profile sections without pitch markings
- Quick and safe module connection with plug-in cable sets
- Horizontal or vertical DIN rail mounting
- Can be flexibly adapted to suit any controller or higher-level control system
- Solutions tailored to your requirements on request
- Available pre-assembled with modules and wired, or for self-assembly



Select standard DIN rail device



Select module carrier



Select controller-specific front adapter and system cable



Solutions are also available for MACX Analog, MACX Analog Ex, and Safety

**Termination Carriers for MINI Analog signal conditioners**

The **TC-D37SUB-ADIO16-M-P-UNI** universal Termination Carrier is a compact solution which connects signal conditioners from the MINI Analog series to analog or binary input/output cards of automation systems.

- In conjunction with the MACX MCR-S-MUX HART multiplexer, the **TC-D37SUB-AIO16-M-PS-UNI** Termination Carrier version also allows communication between HART-capable field devices and a management system.
- Connection of up to 16 single-channel signal conditioners
- Universal 1:1 signal routing to a 37-pos. D-SUB connector
- For system cables with D-SUB socket and open ends for universal connection
- Redundant supply and monitoring via separate MINI MCR-SL-PTB-FM power terminal and MINI MCR-SL-FM-RC-NC fault signaling module

**Notes:**  
 Contact us: together, we can develop optimum solutions for your automation system with the Termination Carrier for MINI Analog.  
 TC-D37SUB-ADIO16-M-P-UNI (Order No. 2902933) is not a class A product.



ERC  
 Ex:   
 Housing width 136 mm

General data	
Connection to the control system level	
Number of positions	
Max. operating voltage	
Max. permissible current	
Rated insulation voltage	
Pollution degree	
Surge voltage category	
Rated surge voltage	
Clearance and creepage distances	
Ambient temperature range	
Shock	
Vibration (operation)	
Dimensions W / H / D	
EMC note	
Power supply via power module	
Input voltage range	
Redundant supply	
Polarization and surge protection	
Fuse	
Status indication	
Switching output	

Technical data	
D-SUB pin strip	
37	
< 50 V DC (per signal/channel)	
23 mA (signal/channel)	
50 V	
2	
II	
0.5 kV	
DIN EN 50178 (basic insulation)	
-20 °C ... 60 °C (please observe module specifications)	
15g, according to IEC 60068-2-27	
2g, according to IEC 60068-2-6	
136 / 170 / 160 mm	
Class A product, see page 625	
19.2 V DC ... 30 V DC	
yes, decoupled from diodes	
Yes	
2x 2.5 A on PCB, slow-blow (replaceable)	
2 x red LED (error)	
2x green LEDs (PWR1 and PWR2)	
1 N/C contact (alarm = open)	

**Description**  
**Module carrier** for 16 MINI Analog channels, power and feed-through module  
 - With connection for MACX MCR-S-MUX HART multiplexer

Ordering data		
Type	Order No.	Pcs. / Pkt.
TC-D37SUB-ADIO16-M-P-UNI	2902933	1
TC-D37SUB-AIO16-M-PS-UNI	2902934	1

**MINI Analog power terminal**  
**MINI Analog fault signaling module**  
**HART multiplexer**, 32-channel, including two 14-wire flat-ribbon cables

Accessories		
MINI MCR-SL-PTB-FM	2902958	1
MINI MCR-SL-FM-RC-NC	2902961	1
MACX MCR-S-MUX	2865599	1

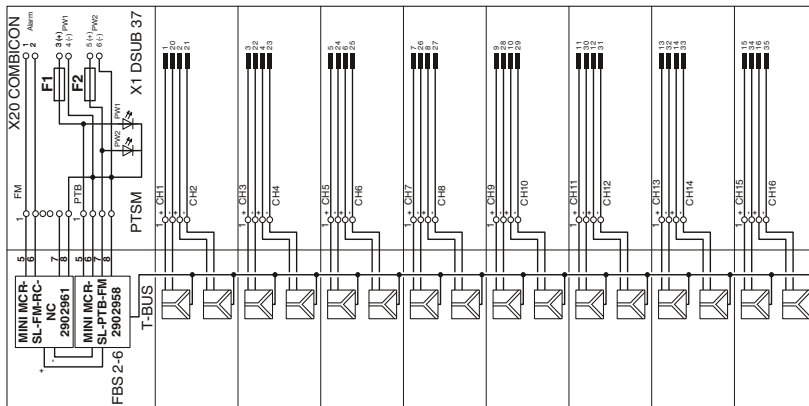

TC-D37SUB-ADIO16-M-P-UNI and TC-D37SUB-AIO16-M-PS-UNI connection scheme

### Accessories

#### Surge protection

#### LINETRAB LIT

The ideal addition to MINI Analog - the innovative surge protection solution in 6.2 mm housing.

Since the LINETRAB LIT and MINI Analog housing is the same shape, you can benefit from the numerous advantages of system cabling. The advantage of combining MINI Analog and LINETRAB LIT products is that it enables you to set up a space-saving, protected, and optimally coordinated signal chain from the sensor right up to the controller.

The tables below are designed to serve as configuration aids for combining MINI Analog and LINETRAB products.

On the left, you will find a list of the components and combination options for setting up system cabling between MINI Analog and LINETRAB.

For details of system cabling solutions that can be used between MINI Analog and the controller side, please refer to page 120.

For more detailed information on LINETRAB LIT surge protection modules, please see the TRABTECH catalog.

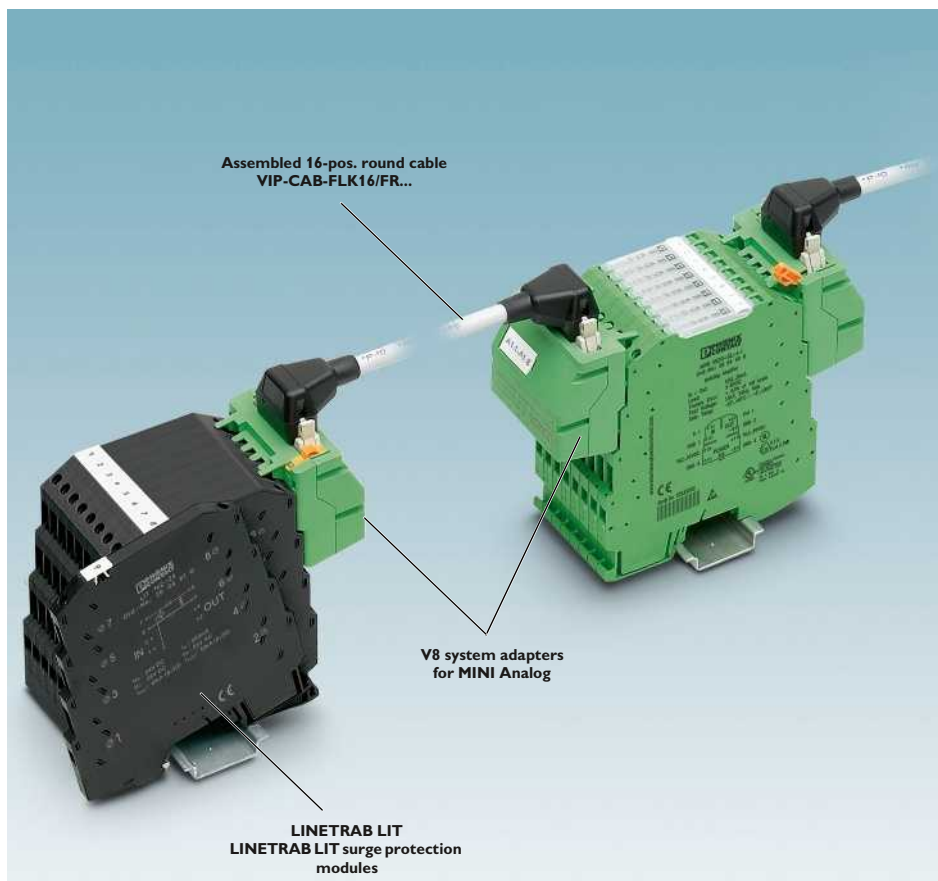

Reliable and systematic measurements - LINETRAB LIT and MINI Analog

### Configuration aid for LINETRAB LIT - MINI Analog

#### Cabling via MINI Analog system adapter (8 modules)

LINETRAB LIT (surge protection)		MINI Analog	
Type	Order No.	Type	Order No.
LIT 1X2-24	2804610	MINI MCR-SL-UI-UI	2864383
		MINI MCR-SL-UI-UI-NC	2864150
		MINI MCR-SL-U-UI-NC	2865007
		MINI MCR-SL-U-I-0	2813512
		MINI MCR-SL-U-I-4	2813525
		MINI MCR-SL-I-U-0	2813541
		MINI MCR-SL-I-U-4	2813538
		MINI MCR-SL-I-I	2864406
		MINI MCR-SL-IDS-I-I	2905577
		MINI MCR-SL-U-U	2864684
		MINI MCR-SL-UI-2I	2864794
		MINI MCR-SL-UI-2I-NC	2864176
		MINI MCR-SL-RPS-I-I	2864422
		MINI MCR-SL-RPSS-I-I	2864079
		MINI MCR-SL-1CP-I-I	2864419
		MINI MCR-SL-UI-F	2864082
		MINI MCR-SL-NAM-2RNO	2864105
		MINI MCR-SL-UI-REL	2864480
		MINI MCR-SL-SHUNT-UI	2810858
		MINI MCR-SL-SHUNT-UI-NC	2810780

#### Components required for system cabling

Available 16-pos. VIP... round cables			V8 system adapter for MINI Analog
Type	Length	Order No.	Type
VIP-CAB-FLK16/FR/FR/0,14/0,5M	0.5 m	2900154	2 x MINI MCR-SL-V8-FLK 16-A (in the catalog on page 122)
VIP-CAB-FLK16/FR/FR/0,14/1,0M	1.0 m	2900155	
VIP-CAB-FLK16/FR/FR/0,14/2,0M	2.0 m	2900156	

VIP... round cables are available in special lengths on request.

**VIP system cable**

The new VIP cables provide a way of setting up secure and robust connections, even in harsh industrial environments.

**Innovative concept**

The MINI Analog system adapter does not just support system cabling on the input and output sides. It also allows cabling to be installed with LINETRAB surge protection modules quickly, easily, and without errors.

**Increased protection**

In addition to all the advantages associated with electrical isolation, filtering, amplification, and the conversion of standard analog signals using MINI Analog, there is now also the option of effective surge protection.

**Surge protection**

Surge protection is a reliable means of actively preventing and protecting against system damage and downtimes. LINETRAB is able to limit transient surge voltages safely and without affecting the signal - all in a compact device with an overall width of just 6.2 mm.



VIP system cable



Innovative concept



Increased protection



Surge protection

Configuration aid for LINETRAB LIT - MINI Analog			
Manual cabling			
LINETRAB LIT (surge protection)		MINI Analog	
Type	Order No.	Type	Order No.
LIT 1X2-24	2804610	MINI MCR-SL-UI-UI	2864383
		MINI MCR-SL-UI-UI-NC	2864150
		MINI MCR-SL-UI-UI-SP	2864710
		MINI MCR-SL-UI-UI-SP-NC	2864163
		MINI MCR-SL-SHUNT-UI-SP	2810874
		MINI MCR-SL-SHUNT-UI-SP-NC	2810793
		MINI MCR-SL-U-UI-SP	2811213
		MINI MCR-SL-U-UI-SP-NC	2810078
		MINI MCR-SL-U-I-0-SP	2813570
		MINI MCR-SL-U-I-4-SP	2813583
		MINI MCR-SL-I-U-0-SP	2813554
		MINI MCR-SL-I-U-4-SP	2813567
		MINI MCR-SL-I-I-SP	2864723
		MINI MCR-SL-IDS-I-I-SP	2905578
		MINI MCR-SL-U-U-SP	2864697
		MINI MCR-SL-UI-2I-SP	2864804
		MINI MCR-SL-UI-2I-SP-NC	2864189
		MINI MCR-SL-RPS-I-I-SP	2864752
		MINI MCR-SL-RPSS-I-I-SP	2810230
		MINI MCR-SL-1CP-I-I-SP	2864749
LIT 2X2-24	2804623	MINI MCR-SL-2CP-I-I	2864655
		MINI MCR-SL-2CP-I-I-SP	2864781
LIT 2-12 (for 2-conductor connection technology)	2804665	MINI MCR-SL-PT100-UI-200	2864309
		MINI MCR-SL-PT100-UI-200-NC	2864370
		MINI MCR-SL-PT100-UI-200-SP	2864192
		MINI MCR-SL-PT100-UI-200-SP-NC	2864202
		MINI MCR-SL-PT100-UI	2864435
		MINI MCR-SL-PT100-UI-NC	2864273
		MINI MCR-SL-PT100-UI-SP	2864736
		MINI MCR-SL-PT100-UI-SP-NC	2864286
		MINI MCR-SL-PT100-UI-LP	2810298
		MINI MCR-SL-PT100-UI-LP-NC	2810308
		MINI MCR-SL-PT100-UI-LP-SP	2810382
		MINI MCR-SL-PT100-UI-LP-SP-NC	2810395
LIT 1X2-24	2804610	MINI MCR-SL-UI-F-SP	2810243
		MINI MCR-SL-NAM-2RNO-SP	2810269
		MINI MCR-SL-UI-REL-SP	2864493
LIT 4-24	2804678	MINI MCR-SL-R-UI	2864095
		MINI MCR-SL-R-UI-SP	2810256



### MCR signal conditioners, head transducers, and process indicators

The MCR signal conditioners in conjunction with proven DIN rail housings and plug-in connection technology offer you a large number of input signal types which can be converted to standard signals.

When using off the DIN rail, you can display or specify your process values with the process indicators and the head transducers convert your temperature values directly into a standard signal.

Choose the right MCR Analog signal conditioner for your application:

### Analog IN/Analog OUT

- Configurable signal multipliers to double standard analog signals

### Temperature

- Temperature relay for 2-wire Pt100
- Output loop-powered temperature transducer for thermocouples and resistance thermometers
- Head transducers for thermocouples and resistance thermometers

### Frequency

- Programmable frequency transducer for frequencies up to 120 kHz

### Limit values

- Universal threshold value switch for temperature sensors and standard signals

### Process indicators

- Programmable process indicators for standard signals
- Setpoint adjuster

### Accessories

- Setpoint potentiometers

### Your advantages:

- High operational reliability in the event of disturbances, thanks to electrical isolation
- Configuration via software, DIP switches or display keypad
- Process indicators including mounting accessories and IP65 protection
- Clearly legible LED 7-segment display



Signal conditioners, head transducers, and process indicators - MCR Analog



- High operational reliability in the event of disturbances, thanks to electrical isolation



- Configuration via software, DIP switches or display keypad



- Process indicators including mounting accessories and IP65 protection
- Convenient reading of process indicators thanks to LED 7-segment display
- Process indicator programming without software



- Convert temperature signals directly into standard analog signals with temperature head transmitters



Analog IN/Analog OUT, signal multiplier

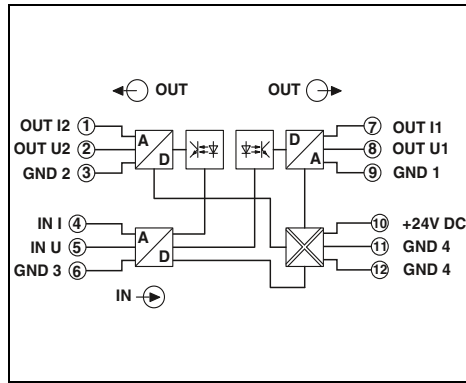
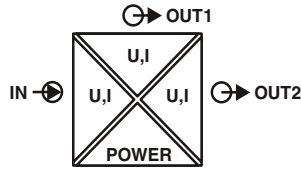

With freely configurable input and two outputs



Housing width 17.5 mm

- 4-way isolation
- Calibrated reversible input and output signals

**Notes:**  
To order a product with an order configuration, enter the required configuration by referring to the adjacent order key.

<b>Input data</b>	Input signal
Measuring range span	
Maximum input signal	
Input resistance	
<b>Output data</b>	Output signal (configurable using the DIP switch)
Maximum output signal	
Load $R_B$	
<b>General data</b>	Supply voltage $U_B$
Current consumption	
Maximum transmission error	
Temperature coefficient	
Test voltage, input/output/supply	
Degree of protection	
Ambient temperature (operation)	
Housing material	
Dimensions W / H / D	
Screw connection solid / stranded / AWG	
EMC note	
<b>Conformance / approvals</b>	Conformance
UL, USA / Canada	

Technical data	
<b>U input</b>	<b>I input</b>
0 V ... 12 V (freely selectable in 0.1 V increments)	0 mA ... 24 mA (freely selectable in 0.1 mA increments)
min. 4 V	min. 8 mA
30 V	50 mA
200 kΩ	50 Ω
<b>U output</b>	<b>I output</b>
refer to the order key	refer to the order key
15 V	35 mA
≥ 10 kΩ	≤ 600 Ω
<b>General data</b>	
20 V DC ... 30 V DC	
< 25 mA	
≤ 0.15 % (of final value), typ. 0.05 % (of final value)	
< 0.015 %/K, typ. 0.0075 %/K	
1.5 kV (50 Hz, 1 min.)	
IP20	
-25 °C ... 55 °C	
Polyamide PA non-reinforced	
17.5 / 99 / 114.5 mm	
0.2 ... 2.5 mm <sup>2</sup> / 0.2 ... 2.5 mm <sup>2</sup> / 24 - 14	
Class A product, see page 625	
<b>CE-compliant</b>	
Class I, Div. 2, Groups A, B, C, D or Non-Hazardous Locations	

<b>Description</b>
<b>MCR signal multiplier</b> , for multiplication and electrical isolation of analog signals
Order configuration
Standard configuration

Ordering data		
<b>Type</b>	<b>Order No.</b>	<b>Pcs. / Pkt.</b>
MCR-FL-C-UI-2UI-DCI	2814854	1
MCR-FL-C-UI-2UI-DCI-NC	2814867	1

Signal conditioners, head transducers, and process indicators - MCR Analog

Order key for MCR-FL-C-UI-2UI-DCI (standard configuration entered as an example)

Order No.	Input signal	Input signal (standard and special signals)		Output signal (standard signals)		Factory calibration certificate (FCC)
		Initial value	Final value	Output 1	Output 2	
2814854	I I ≙ Current U ≙ Voltage	0.0 0.0 ≙ 0.0 mA I : freely selectable between 0.0 ... 24.0 mA U : freely selectable between 0.0 ... 12.0 V	20.0 20.0 ≙ 20.0 mA I : freely selectable between 0.0 ... 24.0 mA U : freely selectable between 0.0 ... 12.0 V	OUT01 OUT01 ≙ 0...20 mA OUT02 ≙ 4...20 mA OUT03 ≙ 0...10 V OUT04 ≙ 2...10 V OUT05 ≙ 0...5 V OUT06 ≙ 1...5 V OUT16 ≙ 0...10 mA	OUT01 OUT01 ≙ 0...20 mA OUT02 ≙ 4...20 mA OUT03 ≙ 0...10 V OUT04 ≙ 2...10 V OUT05 ≙ 0...5 V OUT06 ≙ 1...5 V OUT16 ≙ 0...10 mA	NONE NONE ≙ without FCC YES ≙ with FCC (a fee is charged) YESPLUS ≙ FCC with 5 measuring points (a fee is charged)

8.0 mA/4.0 V min. measuring range span  
0.1 mA/0.1 V increment

Ordering examples:

Order No.	Input signal	Input signal (standard and special signals)		Output signal (standard signals)		Factory calibration certificate (FCC)
		Initial value	Final value	Output 1	Output 2	
2814854	I I ≙ Current	5.3 I ≙ 5.3 mA	13.3 I ≙ 13.3 mA	OUT01 OUT01 ≙ 0...20 mA	OUT01 OUT01 ≙ 0...20 mA	NONE NONE ≙ without FCC

8.0 mA measuring range span, i.e., can be ordered.

Order No.	Input signal	Input signal (standard and special signals)		Output signal (standard signals)		Factory calibration certificate (FCC)
		Initial value	Final value	Output 1	Output 2	
2814854	U U ≙ Voltage	7.8 U ≙ 7.8 V	11.8 U ≙ 11.8 V	OUT01 OUT01 ≙ 0...20 mA	OUT03 OUT03 ≙ 0...10 V	NONE NONE ≙ without FCC

4.0 V measuring range span, i.e., can be ordered.

Combination table for input and output signals that can be set via DIP switches

Input	Output 1							Output 2						
	0...20 mA	4...20 mA	0...10 mA	0...10 V	0...5 V	1...5 V	2...10 V	0...20 mA	4...20 mA	0...10 mA	0...10 V	0...5 V	1...5 V	2...10 V
0...20 mA	x	x	x	x	x	x	x	x	x	x	x	x	x	x
4...20 mA	x	x	x	x	x	x	x	x	x	x	x	x	x	x
0...10 mA	x	x	x	x	x	x	x	x	x	x	x	x	x	x
2...10 mA	x	x	x	x	x	x	x	x	x	x	x	x	x	x
0...10 V	x	x	x	x	x	x	x	x	x	x	x	x	x	x
2...10 V	x	x	x	x	x	x	x	x	x	x	x	x	x	x
0...5 V	x	x	x	x	x	x	x	x	x	x	x	x	x	x
1...5 V	x	x	x	x	x	x	x	x	x	x	x	x	x	x

Application example: level measurement with subsequent signal multiplication

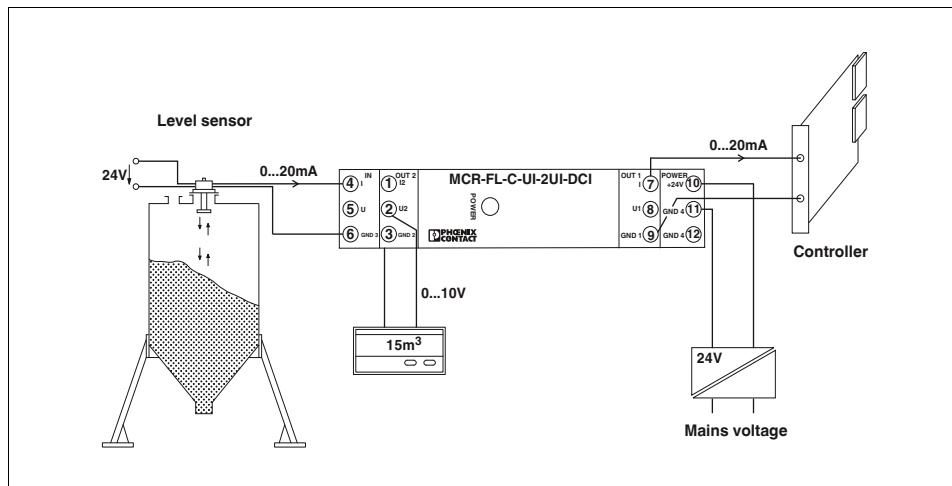

Temperature, temperature relay

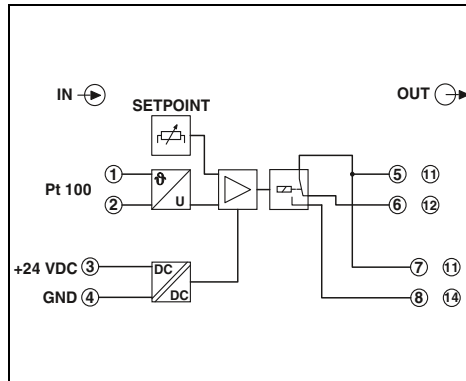
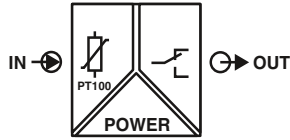

For Pt 100



Housing width 12.5 mm

Technical data

- Switching point in the temperature range from -100°C ... +700°C freely selectable
- Changeover relay output
- Electrically isolated
- Adjustable switch hysteresis

Input data

Resistance thermometers  
Temperature range  
Sensor input current

Switching output

Contact type  
Contact material  
Max. switching current

Operate delay time  
Off delay time  
Switching hysteresis

Error/status indicator

General data

Supply voltage  $U_B$   
Current consumption  
Linearity error  
Setting accuracy  
Temperature coefficient  
Test voltage, input/output/supply  
Ambient temperature (operation)  
Mounting  
Housing material  
Dimensions W / H / D  
Screw connection solid / stranded / AWG  
EMC note  
Conformance / approvals  
Conformance  
UL, USA / Canada

Pt 100 (IEC 60751/EN 60751): 2-wire

-100 °C ... 700 °C

approx. 1 mA

Relay output

1 PDT

AgSnO, hard gold-plated

50 mA (for gold layer, 30 V AC/ 36 V DC)

2 A (in case of a destroyed gold layer, 250 V AC)

approx. 6 ms

approx. 200 ms

Adjustable using DIP switches (0.5 K, 2 K, 3 K, 5 K)

Red LED (short-circuit/open circuit) / Yellow LED (relay active)

20 V DC ... 30 V DC

< 30 mA

< 0.1 %

< 1 %, typ. < 0.5 %

< 0.01 %/K, typ. 0.005 %/K

1.5 kV (50 Hz, 1 min.)

-20 °C ... 65 °C

any

Polyamide PA non-reinforced

12.5 / 99 / 114.5 mm

0.2 ... 2.5 mm<sup>2</sup> / 0.2 ... 2.5 mm<sup>2</sup> / 24 - 14

Class A product, see page 625

CE-compliant

UL 508 Recognized

Ordering data

Description

MCR temperature relay, for Pt 100 in 2-wire system

Type	Order No.	Pcs. / Pkt.
MCR-SL-PT100-SP	2814948	1

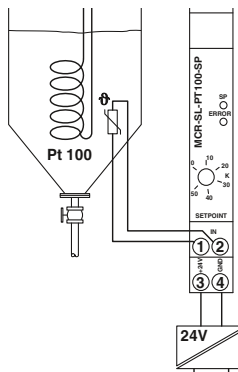

Application example - Temperature control of a heated medium  
1 = mains voltage

Temperature, temperature transducer

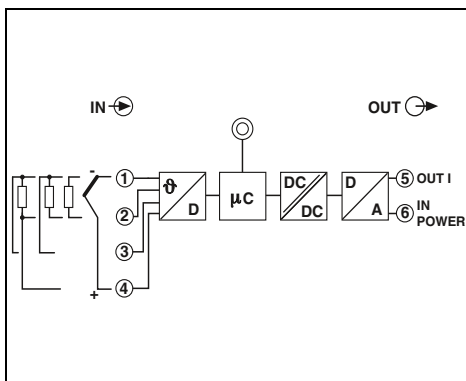
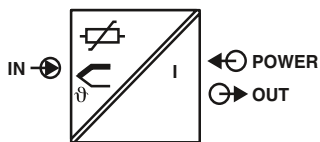

Loop-powered, programmable



Ex: Housing width 12.5 mm

- Output loop-powered temperature transducer
- Freely configurable
- Software available free of charge on the Internet

Notes:

The devices are supplied with the standard configuration: Pt 100 sensor, measuring range 0 ... 100°C, 3-wire connection.

The configuration software can be downloaded from the Internet: [phoenixcontact.net/products](http://phoenixcontact.net/products).

Technical data

<b>Input data</b>	
Resistance thermometers	Pt, Ni (100, 500, 1000); minimum measuring range 10 K : 2, 3, 4-wire
Thermocouple sensors	B, C, D, E, J, K, L, N, R, S, T, U; minimum measuring range 50 K/500 K
Resistor	Resistance-type sensor from 10 Ω to 400 Ω and from 10 Ω to 2000 Ω; minimum measuring range 10 Ω/100 Ω
Voltage	-10 mV ... 100 mV (min. measuring range 5 mV)
<b>Output data</b>	
Output signal	4 ... 20 mA / 20 ... 4 mA
Load $R_B$	Max ( $V_{supply} - 12 V$ ) / 0.023 A (current output)
Output signal with short-circuit	≤ 3.6 mA or ≥ 21 mA (adjustable, not for thermocouples)
Output signal with open circuit	≤ 3.6 mA or ≥ 21 mA (adjustable)
Measuring range overrange / underrange	≤ 20.5 mA / ≥ 3.8 mA (linear increase/decrease)
<b>General data</b>	
Supply voltage $U_B$	12 V DC ... 35 V DC
Current consumption	< 3.5 mA
Transmission error	Resistance thermometers: 0.2 K (Pt 100, Ni 100), 0.5 K (Pt 500, Ni 500), 0.3 K (Pt 1000, Ni 1000)
	Thermocouple sensors: Type 0.5 K (K, J, T, E, L, U), 1.0 K (N, C, D), 2.0 K (S, B, R)
	Resistance-type sensors: ± 0.1 Ω (10...400 Ω), ± 1.5 Ω (10...2000 Ω)
	Voltage sensor: ± 20 µV (-10...100 mV)
Step response (10-90%)	< 2 s
Pickup delay	4 s
Test voltage input/output	2 kV (50 Hz, 1 min.)
Degree of protection	IP20
Ambient temperature (operation)	-40 °C ... 85 °C
Mounting	any
Housing material	Polyamide PA non-reinforced
Dimensions W / H / D	12.5 / 99 / 114.5 mm
Screw connection solid / stranded / AWG	0.2 ... 2.5 mm <sup>2</sup> / 0.2 ... 2.5 mm <sup>2</sup> / 24 - 14
<b>Conformance / approvals</b>	
Conformance	CE-compliant
UL, USA / Canada	Class I, Div. 2, Groups A, B, C, D

Ordering data

Description	Type	Order No.	Pcs. / Pkt.
<b>MCR temperature transducer</b> , loop-powered for resistance thermometers, thermocouples, resistance-type and voltage sensors	<b>MCR-FL-T-LP-I</b>	<b>2864561</b>	1

Accessories

<b>Software adapter cable</b> , 2.4 m in length, with USB connection, for programming MCR-...-LP-... and MCR-...-HT-... modules	<b>MCR-PAC-T-USB</b>	<b>2309000</b>	1
---	----------------------	----------------	---

### Temperature, temperature head transmitter

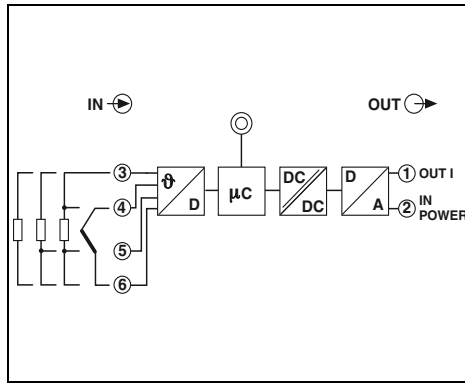
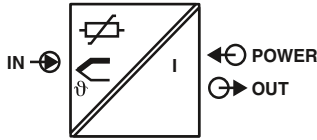

Loop-powered, programmable



- Output loop-powered temperature head transmitter
- Freely configurable
- Software available free of charge on the Internet
- For mounting in the connecting head, form B

**Notes:**  
 The devices are supplied with the standard configuration: Pt 100 sensor, measuring range 0 ... 100°C, 3-wire connection.  
 The configuration software can be downloaded from the Internet: phoenixcontact.net/products.

<b>Input data</b>	
Resistance thermometers	
Thermocouple sensors	
Resistor	
<b>Voltage</b>	
<b>Output data</b>	
Output signal	
Load $R_B$	
Output signal with short-circuit	
Output signal with open circuit	
Measuring range overrange / underrange	
<b>General data</b>	
Supply voltage $U_B$	
Current consumption	
Transmission error	Resistance thermometers
	Thermocouple sensors
	Resistance-type sensors
	Voltage sensor
Step response (10-90%)	
Pickup delay	
Test voltage input/output	
Degree of protection	
Ambient temperature (operation)	
Mounting	
Housing material	
Screw connection solid / stranded / AWG	
<b>Conformance / approvals</b>	
Conformance	
UL, USA / Canada	

<b>Technical data</b>	
Pt, Ni (100, 500, 1000); minimum measuring range 10 K : 2, 3, 4-wire	
B, C, D, E, J, K, L, N, R, S, T, U; minimum measuring range 50 K/500 K	
Resistance-type sensor from 10 Ω to 400 Ω and from 10 Ω to 2000 Ω; minimum measuring range 10 Ω/100 Ω	
-10 mV ... 75 mV (min. measuring range 5 mV)	
4 ... 20 mA / 20 ... 4 mA	
Max ( $V_{supply} - 8 V$ ) / 0.025 A (current output)	
≤ 3.6 mA or ≥ 21 mA (adjustable, not for thermocouples)	
≤ 3.6 mA or ≥ 21 mA (adjustable)	
≤ 20.5 mA / ≥ 3.8 mA (linear increase/decrease)	
<b>General data</b>	
8 V DC ... 35 V DC	
< 3.5 mA	
0.2 K (Pt 100, Ni 100), 0.5 K (Pt 500, Ni 500), 0.3 K (Pt 1000, Ni 1000)	
Type 0.5 K (K, J, T, E, L, U), 1.0 K (N, C, D), 2.0 K (S, B, R)	
± 0.1 Ω (10...400 Ω), ± 1.5 Ω (10...2000 Ω)	
± 20 µV (-10...100 mV)	
< 2 s	
6 s	
2 kV (50 Hz, 1 min.)	
IP00, IP66 (integrated in the connecting head)	
-40 °C ... 85 °C	
any	
Polycarbonate, PC	
0.2 ... 1.75 mm <sup>2</sup> / 0.2 ... 1.75 mm <sup>2</sup> / 24 - 15	
<b>Conformance / approvals</b>	
CE-compliant	
Class I, Div. 2, Groups A, B, C, D	

<b>Description</b>	
<b>MCR temperature head transmitter, loop-powered</b>	
for resistance thermometers, thermocouples, resistance-type and voltage sensors	
<b>Software adapter cable, 2.4 m in length, with USB connection, for programming MCR-...LP-... and MCR-...HT-... modules</b>	

<b>Ordering data</b>		
<b>Type</b>	<b>Order No.</b>	<b>Pcs. / Pkt.</b>
<b>MCR-FL-HT-T-1</b>	<b>2864529</b>	<b>1</b>

<b>Accessories</b>		
<b>MCR-PAC-T-USB</b>	<b>2309000</b>	<b>1</b>

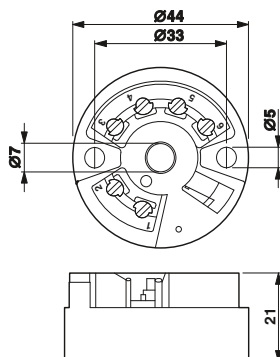

Temperature, temperature head transmitter

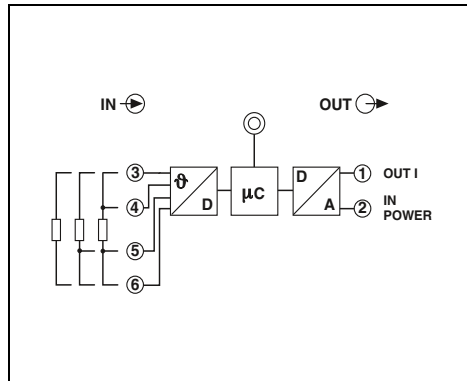
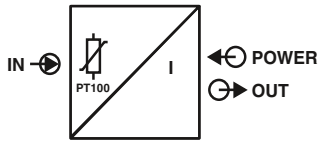

Loop-powered, programmable



- Output loop-powered temperature head transmitter for Pt 100 sensors
- Freely configurable
- Software available free of charge on the Internet
- For mounting in the connecting head, form B

**Notes:**  
 The devices are supplied with the standard configuration: Pt 100 sensor, measuring range 0 ... 100°C, 3-wire connection.  
 The configuration software can be downloaded from the Internet: phoenixcontact.net/products.

<b>Input data</b>	Resistance thermometers
<b>Output data</b>	Output signal Load R <sub>B</sub>
	Output signal with short-circuit Output signal with open circuit Measuring range overrange / underrange
<b>General data</b>	Supply voltage U <sub>B</sub> Current consumption Transmission error Step response (10-90%) Pickup delay Degree of protection Ambient temperature (operation) Mounting Housing material Conformance / approvals Conformance UL, USA / Canada

<b>Technical data</b>
Pt 100; minimum measuring range 10 K : 2, 3, 4-wire
4 ... 20 mA / 20 ... 4 mA Max (V <sub>supply</sub> - 10 V) / 0.023 A (current output)
≤ 3.6 mA or ≥ 21 mA (adjustable) ≤ 3.6 mA or ≥ 21 mA (adjustable) ≤ 20.5 mA / ≥ 3.8 mA (linear increase/decrease)
10 V DC ... 35 V DC < 3.5 mA Resistance thermometers 0.2 K < 2 s 4 s IP00, IP54 (integrated in the connecting head) -40 °C ... 85 °C any Polycarbonate, PC CE-compliant Class I, Div. 2, Groups A, B, C, D

<b>Description</b>
<b>MCR temperature head transmitter, loop-powered</b> for Pt 100 resistance thermometer
<b>Software adapter cable, 2.4 m in length, with USB connection, for programming MCR-...-LP-... and MCR-...-HT-... modules</b>

<b>Ordering data</b>		
<b>Type</b>	<b>Order No.</b>	<b>Pcs. / Pkt.</b>
MCR-SL-HT-PT 100-I	2864516	1
<b>Accessories</b>		
MCR-PAC-T-USB	2309000	1

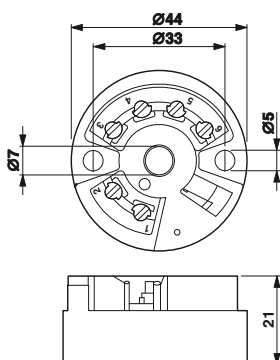



Frequency, frequency transducer

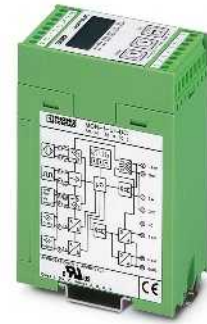
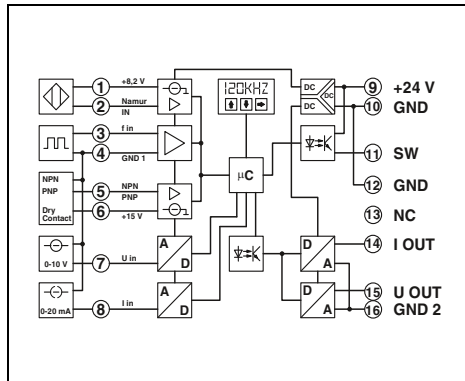
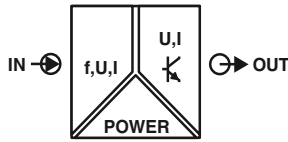

Frequencies up to 120 kHz, configurable



Housing width 45 mm

- Frequencies up to 120 kHz
- For NAMUR sensors, floating contacts, frequency generators, and NPN/PNP transistor outputs
- Analog and switching output
- 3-way isolation
- Configurable via membrane keypad or software
- Software available free of charge on the Internet
- Display of input or output signal

**Notes:**  
The configuration software can be downloaded from the Internet: [phoenixcontact.net/products](http://phoenixcontact.net/products).

<b>Input data</b>	Frequency range Input sources
<b>Transducer supply</b>	Signal level
<b>Maximum input signal</b>	Signal form Pulse length Resolution Signal conversion time
<b>Input data</b>	Input signal
<b>Output data</b>	Output signal Maximum output signal Load $R_B$ Ripple
<b>Switching output</b>	Transistor output, pnp Switches supply voltage to terminal block SW, can carry a load of 100 mA, not protected against short-circuit
<b>General data</b>	Supply voltage $U_B$ Current consumption Maximum transmission error Temperature coefficient ZERO / SPAN adjustment Step response (10-90%) Test voltage, input/output/supply Ambient temperature (operation) Status indication Operating elements Housing material Dimensions W / H / D Screw connection solid / stranded / AWG EMC note
<b>Conformance / approvals</b>	Conformance UL, USA / Canada GL

**Technical data**

<b>Frequency input</b>	0.1 Hz ... 120 kHz
<b>NPN/PNP transistor outputs</b>	NAMUR initiators Floating relay contact (dry contact) Frequency generator approx. 15 V DC / max. 25 mA (constant) 2 V <sub>pp</sub> (in case of square 0.1 Hz ... 120 kHz) 2 V <sub>pp</sub> (in case of sine 8 Hz ... 120 kHz) 13 V <sub>pp</sub> (in case of sine 1 Hz ... 120 kHz) 30 V (incl. DC voltage)
<b>Signal conditioner function</b>	0 V ... 10 V (freely adjustable)      0 mA ... 20 mA (freely adjustable)
<b>U output</b>	0 ... 5 V / 0 ... 10 V
<b>I output</b>	0 ... 20 mA
<b>Transistor output, pnp</b>	12 V      24 mA 95 kΩ      200 Ω 14 bit (full-scale)      14 bit (full-scale)
<b>Switches supply voltage to terminal block SW, can carry a load of 100 mA, not protected against short-circuit</b>	12.5 V      25 mA ≥ 500 Ω      ≤ 500 Ω < 20 mV <sub>pp</sub>
<b>Supply voltage <math>U_B</math></b>	20 V DC ... 30 V DC
<b>Current consumption</b>	< 60 mA (without load, without switching output)
<b>Maximum transmission error</b>	≤ 0.15 % (of measured value), typ. 0.1 %
<b>Temperature coefficient</b>	0.015 %/K, typ. 0.01 %/K
<b>ZERO / SPAN adjustment</b>	± 25 % / ± 25 %
<b>Step response (10-90%)</b>	< 25 ms
<b>Test voltage, input/output/supply</b>	1.5 kV (50 Hz, 1 min.)
<b>Ambient temperature (operation)</b>	-20 °C ... 65 °C (for specified data)
<b>Status indication</b>	LC display
<b>Operating elements</b>	Membrane keypad with 3 keys and LCD display
<b>Housing material</b>	ASA-PC (V0)
<b>Dimensions W / H / D</b>	45 / 75 / 110 mm
<b>Screw connection solid / stranded / AWG</b>	0.2 ... 2.5 mm <sup>2</sup> / 0.2 ... 2.5 mm <sup>2</sup> / 24 - 14
<b>EMC note</b>	Class A product, see page 625
<b>Conformance</b>	CE-compliant Class I, Div. 2, Groups A, B, C, D or Non-Hazardous Locations Germanischer Lloyd

**Ordering data**

Type	Order No.	Pcs. / Pkt.
MCR-F-UI-DC	2814605	1

**Accessories**

MCR-TTL-RS232-E	2814388	1
CM-KBL-RS232/USB	2881078	1

<b>Description</b>	MCR frequency transducer, for conversion of frequencies into analog signals 0(4)...20 mA, 0...(5)10 V and their inverse signals
<b>Software adapter cable</b> (stereo jack plug/25-pos. D-SUB), 1.2 m long, for programming MCR-T-..., MCR-S-..., and MCR-F-... modules	
<b>Connecting cable</b> , D-9-SUB to USB, with adapter D-9-SUB to D-25-SUB	

Example connections for common frequency transmitters

2-wire DC (mechanical contact)

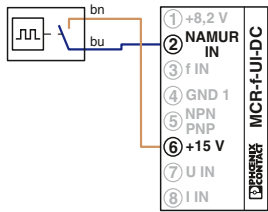

Alternatively instead of terminal block ⑥ terminal block ① possible.

2-wire DC NAMUR sensor

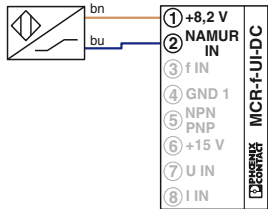

4-wire DC  
• With PNP transistor output

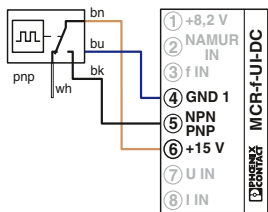

• With NPN transistor output

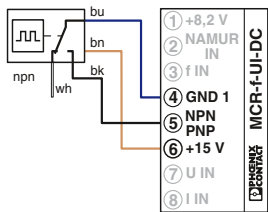

3-wire DC  
• With PNP transistor output

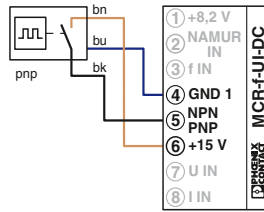

• With NPN transistor output

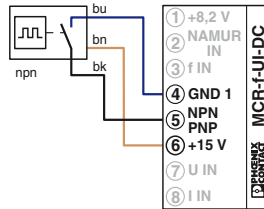

3-wire DC  
• PNP transistor with pull-down resistor

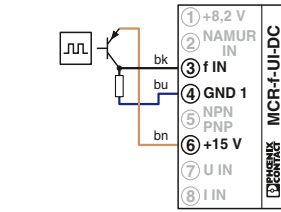

• NPN transistor with pull-up resistor

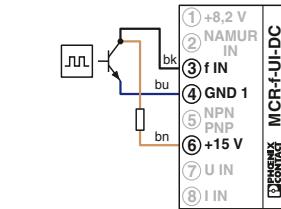

Incremental rotary transducer with push-pull:  
• External supply of signal generator

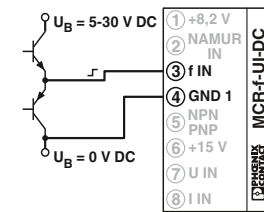

• Supply of signal generator from the module

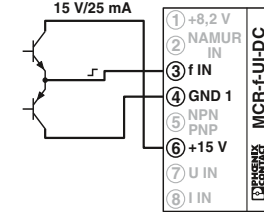

Incremental rotary transducer with HTL logic:  
• External supply of signal generator

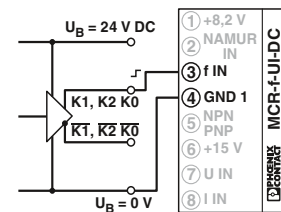

• Supply of signal generator from the module

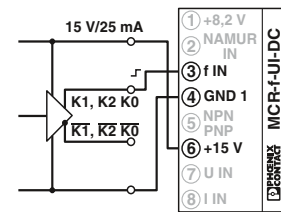

Application examples:

The MCR-F-UI-DC frequency transducer converts the pulse signal into a standard analog signal, which, for example, corresponds to the number of bottles filling systems recorded during a specified time unit.

For speed detection, it is possible to enter the measuring range in revolutions per minute (RPM) and display the current measured value on the unit.

The frequency transducer has an automatic measuring range selection function (autorange) to ensure the best possible resolution. This permits response times to be reduced to a minimum and the measured value is optimally adapted to the input value.

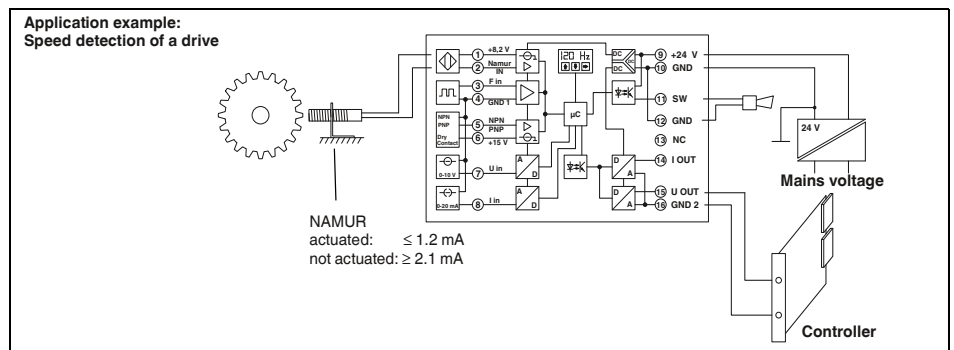
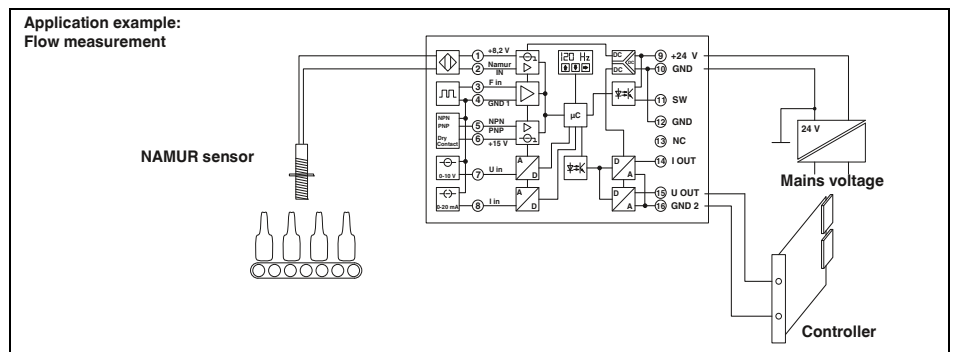

Threshold values

Programmable threshold value switch

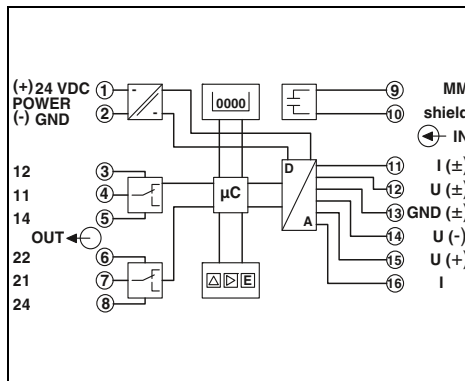
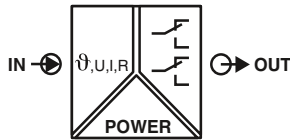

Configurable threshold value switch for standard and temperature signals

- For thermocouple sensors, resistance thermometers, and linear resistors
- For current or voltage signals
- Four independently adjustable switching thresholds
- With or without electrical isolation of input signals
- Configuration via membrane keypad or software
- Software available free of charge on the Internet
- Continuous measured value display

**Notes:**  
The configuration software can be downloaded from the Internet: phoenixcontact.net/products.

<b>Input data</b>	
Input sources	
Measuring rate	Current / voltage
Input resistance	
Discontinuous control resolution	
<b>Switching output</b>	
Contact type	
Contact material	
Max. switching voltage	
Max. switching current	
Response delay	
Mechanical service life	
Error/status indicator	
<b>General data</b>	
Supply voltage $U_B$	
Current consumption	
Maximum transmission error	
Temperature coefficient	
Test voltage input/power supply	
Ambient temperature (operation)	
Status indication	
Mounting	
Housing material	
Dimensions W / H / D	
Screw connection solid / stranded / AWG	
EMC note	
<b>Conformance / approvals</b>	
Conformance	
UL, USA / Canada	

Housing width 45 mm

**Technical data**

Resistance thermometer 2, 3 or 4-wire system (in acc. with DIN 43760/DIN IEC 751 or SAMA RC 21-4-1966), e.g. PT sensors, Ni sensors etc.  
Thermocouple sensors (in acc. with DIN IEC 584-1/DIN 43710): B, E, J, K, L, N, R, S, T, U  
Resistance: 0 kΩ ... 8 kΩ (only 2-wire connection)  
Current: - 30 mA...+ 30 mA  
Voltage: - 30 V...+ 30 V

2 Hz  
50 Ω / 200 kΩ  
0.1 °C / 0.01 V / 0.01 mA / 0.1 Ω

2 x PDT contact, / 2 switching points each, pick-up/drop-out (can be switched)  
AgNi 0.15 + HTV (hard gold-plated)  
250 V AC  
2 A AC  
0 s ... 2 s (adjustable)  
2 x 10<sup>7</sup> cycles  
LED display

20 V DC ... 30 V DC  
< 60 mA  
0.1 % (of final value)  
≤ 0.01 %/K  
1 kV AC (50 Hz, 1 min.)  
-20 °C ... 65 °C  
5-position 7-segment display and LEDs  
any  
ABS  
45 / 75 / 110 mm  
0.2 ... 2.5 mm<sup>2</sup> / 0.2 ... 2.5 mm<sup>2</sup> / 24 - 14  
Class A product, see page 625

CE-compliant  
cULus

**Ordering data**

Type	Order No.	Pcs. / Pkt.
MCR-PSP-DC	2811925	1
MCR-PSP	2811912	1

**Accessories**

MCR-TTL-RS232	2814391	1
CM-KBL-RS232/USB	2881078	1

<b>Description</b>
<b>MCR threshold value switch</b> , with two relay contacts
With electrically isolated input
<b>Software adapter cable</b> (6-pos./D-SUB 25-pos.), 1.5 m in length, for programming MCR-PSP modules
<b>Connecting cable</b> , D-9-SUB to USB, with adapter D-9-SUB to D-25-SUB

Accessories  
Setpoint potentiometer

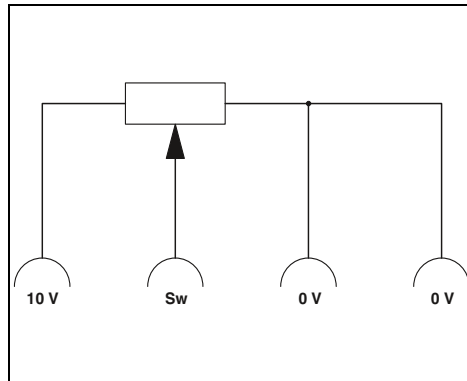
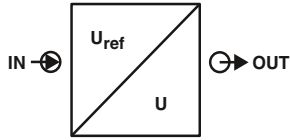

– For direct setpoint definition in combination with a constant voltage source

<b>Input data</b>
Resistance value
Linearity
Load capacity
<b>General data</b>
Ambient temperature (operation)
Mounting
Housing material
Dimensions W / H / D
Screw connection solid / stranded / AWG

ERC  
Housing width 30 mm

Technical data	
EMG 30-SP- 4K7LIN	EMG 30-SP-10K LIN
4.7 kΩ ±20 %	10 kΩ ±20 %
5 % (of final value)	5 % (of final value)
1 W	0.5 W
0 °C ... 40 °C	
any	
Polycarbonate fiber reinforced PC-F	
30 / 75 / 68 mm	
0.2 ... 4 mm <sup>2</sup> / 0.2 ... 2.5 mm <sup>2</sup> / 24 - 14	

<b>Description</b>
<b>Setpoint potentiometer</b> , for individual setpoint definition
Resistance value 4.7 kΩ
Resistance value 10 kΩ

Ordering data		
Type	Order No.	Pcs. / Pkt.
EMG 30-SP- 4K7LIN	2940252	10
EMG 30-SP-10K LIN	2942124	10

<b>MCR constant voltage source</b>
------------------------------------

Accessories		
Type	Order No.	Pcs. / Pkt.
MINI MCR-SL-CVS-24-5-10-NC	2902822	1
MINI MCR-SL-CVS-24-5-10-SP-NC	2902823	1

### Analog IN, standard signals

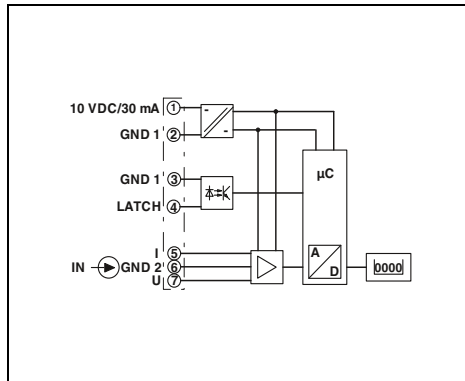
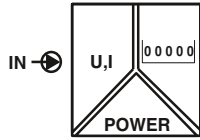

For standard analog signals, configurable

- For 0 ... 10 V and 0(4) ... 20 mA standard analog signals
- Configurable
- 5 positions displayed
- 8 mm LED, 7-segment
- Electrically isolated
- Min./max. value saved
- Latch/hold function for storing the display value
- Display 48 x 24 mm

Input data	
Input signal	
Maximum input signal	
Input resistance	
Resolution	
Measuring rate	
Input latch signal	
Switching level	1 signal ("H") 0 signal ("L")
Output data	
Display	
Number of positions displayed	
Accuracy	
General data	
Supply voltage $U_B$	
Current consumption	
Mass storage	
Resolution A/D	
System hum suppression	
Test voltage input/power supply	
Degree of protection	
Ambient temperature (operation)	
Housing material	
Dimensions W / H / D	
Control panel cutout	
Screw connection solid / stranded / AWG	
Conformance / approvals	
Conformance	
UL, USA / Canada	



Housing width 48 mm

#### Technical data

U input	I input
0 ... 10 V	0 ... 20 mA / 4 ... 20 mA
30 V DC	50 mA
> 1 MΩ	approx. 100 Ω with 5 mA / approx. 70 Ω with 20 mA
1 mV	2 μA
0.5 to 2 measurements/second	
Display stop	
4 V DC ... 30 V DC	
0 V DC ... 2 V DC	
7-segment LED; 8 mm; red	
5	
< 0.1 % ±1 digit (at an ambient temperature of 20°C)	
10 V DC ... 30 V DC	
50 mA	
EEPROM 1 mil. memory cycles or 10 years	
14 bit	
Digital filtering 50/60 Hz	
500 V <sub>rms</sub> (50/60 Hz, 1 min.)	
IP65 from the front	
-10 °C ... 50 °C	
Macrolon 2405	
48 / 24 / 68 mm	
22(+0.6)x45(+0.8) mm	
0.14 ... 1.5 mm <sup>2</sup> / 0.14 ... 1.5 mm <sup>2</sup> / 26 - 16	
CE-compliant	
UL 508 Recognized	

#### Ordering data

Type	Order No.	Pcs. / Pkt.
MCR-SL-D-U-I	2864011	1

#### Accessories

MCR-SL-D-RA	2810081	1
-------------	---------	---

Description
<b>MCR process display</b> , for measuring and displaying standard signals
<b>MCR DIN rail adapter</b> for digital displays in a 24 x 48 mm housing

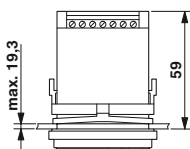
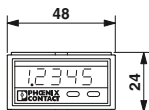

Analog OUT, setpoint adjuster

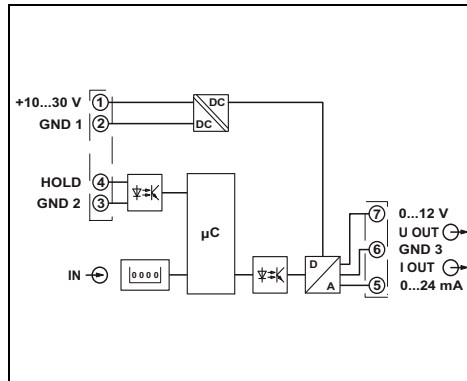
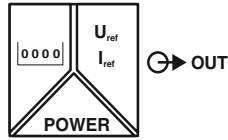

With manual and automatic ramp function

- Manual setpoint definition with increment setting
- Manual setpoint definition via direct input
- Automatic setpoint definition with hold function and 20 support points
- Flexibly adjustable 0 ... 12 V or 0 ... 24 mA signal ranges
- Data backup in case of a power failure
- Display value parameterization
- Electrical isolation between output and supply

Input data	
Display	7-segment, 8 mm, red
Number of positions displayed	4
Switching level	1 signal ("H") 0 signal ("L")
Output data	
Output signal	U output 0 ... 12 V
Length of step	10 mV
Load R <sub>B</sub>	≥ 2 kΩ
Ripple	≤ 10 mV <sub>PP</sub>
General data	
Supply voltage U <sub>B</sub>	10 V DC ... 30 V DC
Power consumption	1 W (with 24 mA/12 V)
Maximum transmission error	< 0.2 % ((full-scale) at rated voltage)
Test voltage output/power supply	500 V AC (50 Hz, 1 min.)
Degree of protection	IP65 from the front
Ambient temperature (operation)	-20 °C ... 65 °C
Housing material	Macrolon 2405
Dimensions W / H / D	48 / 24 / 68 mm
Control panel cutout	45(+0.6)x22.2(+0.3) mm
Screw connection solid / stranded / AWG	0.14 ... 1.5 mm <sup>2</sup> / 0.14 ... 1.5 mm <sup>2</sup> / 26 - 16
Conformance / approvals	
Conformance	CE-compliant
UL, USA / Canada	UL 508 Recognized

ERIC  
Housing width 48 mm

Technical data

U output	I output
0 ... 12 V	0 ... 24 mA
10 mV	10 µA
≥ 2 kΩ	≤ 500 Ω (up to 20 mA) ≤ 400 Ω (> 20 mA)

Description
MCR digital setpoint adjuster, for presetting current and voltage signals

MCR DIN rail adapter for digital displays in a 24 x 48 mm housing

Ordering data

Type	Order No.	Pcs. / Pkt.
MCR-SL-D-SPA-UI	2710314	1

Accessories

MCR-SL-D-RA	2810081	1
-------------	---------	---

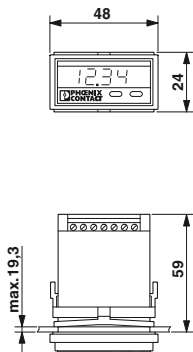







**Machine building/process industry**  
 EN ISO 13849-1  
 EN 62061  
 IEC 61508  
 EN 60511

**Process industry**  
 IEC 61508  
 EN 60511

 <p><b>PL</b>  <small>EN ISO 13849</small></p> <p><b>Signal conditioner with PL functional safety</b>          MACX Safety</p>	 <p><b>PL</b>  <small>EN ISO 13849</small></p> <p><b>Ex i signal conditioner with PL functional safety</b>          MACX Safety Ex</p>
 <p><b>SIL</b>  <small>IEC 61508</small></p> <p><b>Signal conditioner with SIL functional safety</b>          MACX Analog</p> <p><b>No intrinsic safety</b></p>	 <p><b>SIL</b>  <small>IEC 61508</small></p> <p><b>Ex i signal conditioner with SIL functional safety</b>          MACX Analog Ex</p> <p><b>Intrinsic safety</b>          ATEX/IECEX          EN 60079-11</p>

Signal conditioners with functional safety and explosion protection - the MACX ranges



**Reliable and safe**

Maximum safety for your machines and systems.

Phoenix Contact meets the requirements of functional safety according to IEC 61508 in a standardized development process. We take measures for fault avoidance and fault control into consideration, from the development and production of a device up to device operation.



**Tested quality and safety**

Independent test centers are involved throughout the entire development cycle and audit the measures as part of a full assessment. The certificates, technical information, and the safety manual are available for you to download.



**A solution for every type of signal**

Safely isolate, condition, filter, and amplify: MACX Analog offers comprehensive solutions for analog signal processing.



**Analog signals with performance level**

MACX Safety is also equipped with performance level PL d. This means that you can integrate analog signals easily into your safety application according to the Machinery Directive.



**Maximum explosion protection**

Highly compact and leading technology: with an overall width of just 12.5 mm, MACX Analog Ex offers single and two-channel signal isolators for intrinsically safe circuits in the hazardous area.



**Analog Ex i signals with performance level**

Also for intrinsically safe circuits in the hazardous area: in addition to PL d, MACX Safety Ex also has ATEX and IECEx approvals.

**Facts about explosion protection**

The chemical and petrochemical industries involve industrial processes which produce explosive atmospheres. They are caused, for example, by gases, fumes or vapors. Explosive atmospheres are also likely to occur in mills, silos, and sugar and fodder factories due to the dust present there.

Therefore, electrical devices in potentially explosive areas are subject to special directives.

**Devices and protective systems in potentially explosive areas**

European Parliament directive 94/9/EC of March 23, 1994 (ATEX manufacturer directive) is of particular importance within CENELEC (European Community and Western European EFTA states). It is designed to facilitate the harmonization of legal provisions in the member states of the European Union for devices and protective systems in terms of ensuring correct use in potentially explosive areas. Directive 94/9/EC must be applied to all explosion-protected devices and protective systems placed on the market in the European Union.

The scope of this directive also includes safety, monitoring, and control devices which are used outside of potentially explosive areas, but which are necessary for, or contribute towards, the safe operation of devices and protective systems with respect to explosion hazards.

The term **device** includes machines, equipment, stationary or mobile devices, control components, and system accessories. The directive also covers alarm and protection systems which are meant to be used, either individually or in combination, for the generation, transmission, storage, measurement, control, and conversion of energy as well as for processing materials and which have the potential to ignite and cause an explosion.

**Protective systems** are devices designed to stop an incipient explosion immediately and/or restrict the area affected by the explosion, and which are placed on the market separately as autonomous systems.



**Components** are defined as those parts that are necessary for ensuring the safe operation of devices and protective systems, but do not perform an autonomous function in themselves.

European directives are implemented in ordinances or laws at a national level.

**Systems in potentially explosive areas**

Directive 1999/92/EC (ATEX Operator Directive) was passed in Europe to regulate the operation of systems in potentially explosive areas.

Terminology associated with the Ex area	
<b>Explosive atmosphere</b>	A mixture of combustible gases, steam, vapors or dust and air in atmospheric conditions that allow the entire mixture to combust once ignited.
<b>Potentially explosive area</b>	An area where the atmosphere has the potential to explode due to local or operational conditions ("Ex area").
<b>Electrical equipment</b>	The entire set of components, electric circuits or parts of electric circuits that are usually located within a single housing.
<b>Intrinsically safe electrical equipment</b>	An electrical device in which all circuits are intrinsically safe. Note: these devices may be used directly in the Ex area.
<b>Associated equipment</b>	Electrical devices that contain both intrinsically safe and non-intrinsically safe circuits and that are designed in such a way that the non-intrinsically safe circuits cannot influence the intrinsically safe ones. Note: associated electrical equipment must not be used directly in potentially explosive areas without additional protection defined by a further protection type.

**Classification into groups**

The general stipulations of EN 60079-0 divide electrical devices for potentially explosive areas into three groups.

**Group I:**

Electrical devices for firedamp areas (mines) which are susceptible to pit gases (methane) and/or combustible dusts (coal dust).

**Group II:**

Electrical devices for operation in areas where explosive gas atmospheres are likely to occur, excluding mines susceptible to firedamp.

This also includes devices for the chemical, petrochemical, and pharmaceutical industries as well as for wastewater treatment.

Electrical devices are further divided into subcategories according to the properties of the explosive atmosphere.

In the case of the intrinsic safety protection type, classification is based on the minimum ignition energy of the gas or vapor.

Designation	Typical gas	Ignition energy/μJ Intrinsic safety
II A	Propane	> 180
II B	Ethylene	60 ... 180
II C	Hydrogen	< 60

**Group III:**

Electrical devices for operation in areas where explosive dust atmospheres are likely to occur, excluding mines susceptible to firedamp.

This includes devices for areas associated with the food industry (mills, silos), for example.

Electrical devices are further divided into subcategories according to the properties of the explosive atmosphere.

Designation	Dusts
III A	Combustible flyings
III B	Non-conductive dust
III C	Conductive dust



## Classification into temperature classes    Zone classification

Simply dividing the various gases into explosion or gas groups according to their minimum ignition energy is not sufficient to describe the gases adequately with regard to their explosive properties.

A gas may explode either when the ignition energy is exceeded or where there is an excessively high temperature caused by a hot surface. This ignition temperature is, however, not usually linked to the ignition energy, i.e., a gas with a low ignition energy does not necessarily explode at a low temperature. Consequently, devices that are used directly in potentially explosive atmospheres are divided into temperature classes. Temperature classes define the maximum surface temperature even in the event of errors. Parallel to this, the gases are classified according to their different ignition temperatures.

Temperature class	Maximum permissible surface temperature of equipment °C	Ignition temperatures of combustible substances °C
T 1	450	> 450
T 2	300	> 300 ≤ 450
T 3	200	> 200 ≤ 300
T 4	135	> 135 ≤ 200
T 5	100	> 100 ≤ 135
T 6	85	> 85 ≤ 100

The following table provides an overview of the ignition energies and ignition temperatures for certain gases:

Substance	T <sub>ign</sub>	Temperature class	E <sub>min</sub>	Group
Ethoxyethane	170	T 4	190	II B
Ethylene	425	T 2	82	II B
Ammonia	630	T 1	14000	II A
Butane	365	T 2	250	II A
Methane	595	T 1	280	I
Propane	470	T 1	250	II A
Carbon disulfide	95	T 6	9	II C
Hydrogen	560	T 1	16	II C

Potentially explosive areas are divided into zones according to the probability of their occurrence. The EN 60079-10-1 standard defines the zones containing **explosive atmospheres** as follows:

### Zone 0:

Area in which an explosive atmosphere is present for continuous or long periods.

These conditions are usually present inside containers, pipelines, apparatus, and tanks.

### Zone 1:

Area in which an explosive atmosphere is to be expected only occasionally during normal operation.

This includes the immediate area surrounding zone 0, as well as areas close to filling and emptying equipment.

### Zone 2:

Area in which an explosive atmosphere is not expected during normal operation; however, if it does occur, then it does so only rarely and for a short period.

Zone 2 includes areas that are used exclusively for storage, areas around pipe connections that can be disconnected, and generally the immediate area surrounding zone 1.

Areas that are potentially explosive as a result of **combustible dusts** are divided into the following zones according to EN 60079-10-2 (formerly: EN 61241-10):

### Zone 20:

Area in which an explosive atmosphere is present for continuous, frequent or long periods in the form of an airborne cloud of combustible dust.

### Zone 21:

Area in which an explosive atmosphere in the form of an airborne cloud of combustible dust is to be expected only occasionally during normal operation.

### Zone 22:

Area in which an explosive atmosphere in the form of an airborne cloud of combustible dust is not expected during normal operation. However, if it does occur, then it does so only for a short period.

## Categories

The ATEX Directive assigns devices for use in potentially explosive areas to categories. In IEC 60079-0, "Equipment Protection Level (EPL)" is the term used instead of "category".

In the same way that there are different zones, there are also different device categories. These consist of categories M1 and M2 for Group I and categories 1, 2, and 3 for Group II. The categories for **equipment group II** are described in more detail below:

### Category 1:

Devices constructed to guarantee a very high degree of safety.

Devices in this category must guarantee the required degree of safety even in the unlikely event of a device failure and therefore be provided with measures to protect against explosion, so that:

- In the event of one integrated protection measure failing, a second, independent protection measure is able to guarantee the necessary safety.
- In the event of two independent errors, the necessary safety is guaranteed.

### Category 2:

Devices constructed to guarantee a very high degree of safety.

The explosion protection measures associated with this category guarantee the required degree of safety, even in the case of frequent device failures or common error states.

### Category 3:





Devices constructed to guarantee a standard degree of safety.

Devices in this category guarantee an adequate degree of safety in normal operation.

The table below shows which categories are assigned to which zones:

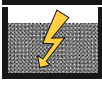
Category	For zone	Also possible
1	0 20	1 and 2 21 and 22
2	1 21	2 22
3	2 22	

### Protection types

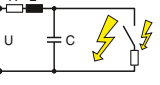
Protection principle	Protection type	Usage range (selection)	Standard
 Isolation	Oil immersion	o Transformers, relays, startup controls, switching devices	EN 60079-6
	Sand filling	q Transformers, relays, capacitors	EN 60079-5
	Molded encapsulation	m* Coils of relays and motors, electronics, solenoid valves, connection systems	EN 60079-18
 Exclusion	Pressurized enclosure	p Control cabinets, motors, measuring and analysis devices, computers	EN 60079-2
 Special mechanical design	Flameproof enclosure	d Motors, switching devices, power electronics	EN 60079-1
 Clearance from electrically conductive parts	Increased safety	e Terminal blocks, housing, lights, motors	EN 60079-7
 Energy limitation	Intrinsic safety	Electronics, measurement and control	EN 60079-11
	Intrinsically safe systems	i* Electronic systems	EN 60079-25
	Intrinsically safe fieldbus systems	Fieldbus systems	EN 60079-27
Improved industrial quality nA: non-sparking nC: sparking equipment nR: restricted breathing housing nL: energy-limited nP: simplified pressurized enclosures	Protection type "n"	n** Motors, housing, lights, electronics	EN 60079-15

\* ia, ma: application in zone 0, 1, 2 / ib, mb: application in zone 1, 2 / ic, mc: application in zone 2 only \*\* Application in zone 2 only

### Marking according to ATEX Directive

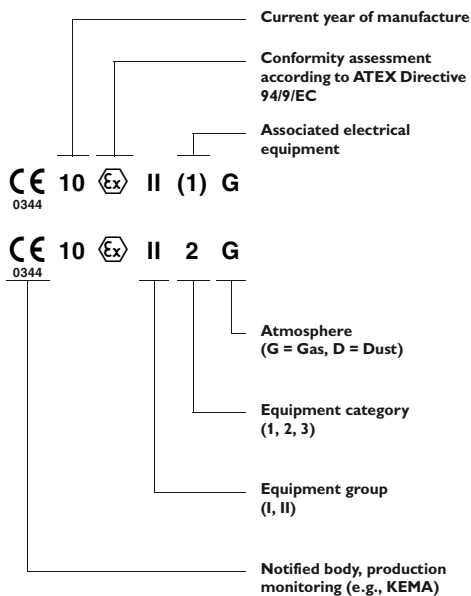

### Designation according to EN 60079-0

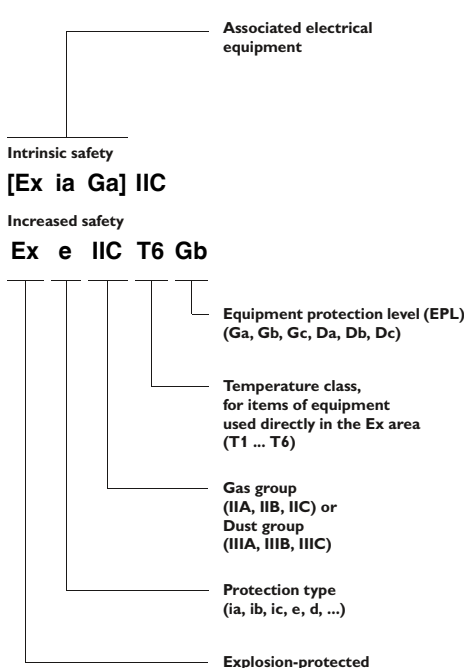

### EC-type examination certificate

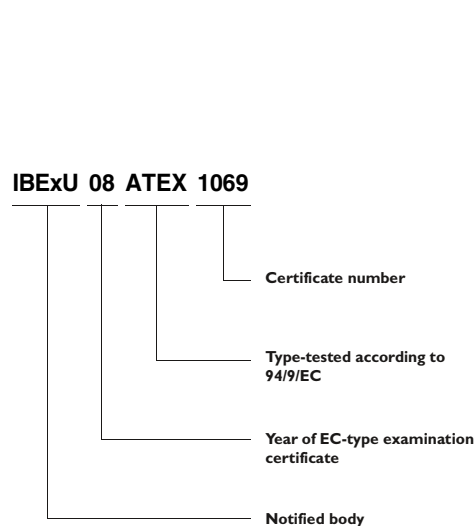

CE mark does not apply to components.





### Safety-related function for the hazardous area

The term SIL (safety integrity level) is becoming more and more significant in the field of process technology. It defines the requirements that a device or a system is expected to fulfill so that the probability of failure can be established. The aim is to achieve the maximum possible operational reliability. If a device or system fails, a defined state is attained. Standard-based inspections are carried out to determine statistical probability.

### Application of SIL on the basis of IEC 61508 and IEC 61511

The SIL standard is used for a wide range of industries within the process industry, including the chemical industry, refineries, oil and gas production, paper manufacturing, and conventional power generation. In addition to functional safety requirements, systems in potentially explosive areas are also subject to Ex standards EN 60079-0 ff.

### IEC 61508: “Functional safety of electrical/electronic/programmable electronic safety-related systems”

This standard describes the requirements that the manufacturer has to bear in mind when producing devices or systems.

### IEC 61511: “Functional safety - Safety instrumented systems for the process industry sector”

The IEC 61511 standard describes the requirements for achieving systems with functional safety

Compliance with the standard is determined by operators, owners, and planners on the basis of safety plans and national regulations. In addition, the standard also describes the requirements for using a device in an application on the basis of its proven effectiveness (proven in use).



### SIL marking on devices

The products in the MACX range from Phoenix Contact, which have been developed according to IEC 61508, are marked with the designation SIL 2 or SIL 3. This indicates clearly that the devices may be suitable for safety instrumented functions (SIF).

To determine whether they can actually

be used, you need to calculate the sum of the probability of failure values for all the devices in the signal circuit. The values required for this can be found in the safety user manual accompanying any SIL product.

### Overview of terms from SIL standards IEC 61508 and IEC 61511

<b>SIL</b>	<b>Safety Integrity Level</b> One of four discrete levels for the specification of requirements for the safety integrity of safety instrumented functions, which are assigned to the E/E/PE safety instrumented systems, where SIL 4 is the highest and SIL 1 the lowest level.	<b>E/E/PES</b>	<b>Electrical/electronic/programmable electronic systems</b> This term is used for all electrical devices or systems which can be used to execute a safety instrumented function. It includes simple electrical devices and all types of programmable logic controllers (PLCs).
<b>EUC</b>	<b>Equipment under control</b> Equipment, machines, devices or systems used in production, materials processing or transport.	<b>PFH</b>	<b>Probability of dangerous Failure per Hour</b> Describes the probability of dangerous failure occurring per hour.
<b>MTBF</b>	<b>Mean Time Between Failures</b> The expected mean time between failures.	<b>SFF</b>	<b>Safe failure fraction</b> Describes the proportion of harmless failures. This is the ratio of the rate of safe failures plus the rate of diagnosed or detected faults in relation to the total failure rate of the system.
<b>PFD</b>	<b>Probability of failure on demand</b> The probability of a failure on demand. Describes the probability of a safety instrumented system failing to perform its function when required.	<b>SIF</b>	<b>Safety Instrumented Function</b> Describes the safety instrumented functions of a system.
<b>PFDavg</b>	<b>Average Probability of Failure on Demand</b> The average probability of the function failing on demand.	<b>SIS</b>	<b>Safety Instrumented System</b> An SIS (safety instrumented system) consists of one or more safety instrumented functions. An SIL requirement is applicable for each of these safety instrumented functions.

**SIL inspection**

The complete signal path must be taken into account during the SIL inspection. The example shows how in a typical safety application the calculation is based on average failure probabilities of individual devices.

Table 2 of the IEC 61508-1 standard describes the relationship between the average failure probability and the attainable SIL. Here, the level required determines the overall budget for the sum of all PFD values.

A system with a single-channel structure with a low demand rate is used as an example; the average PFD value is between  $10^{-3}$  and  $< 10^{-2}$ .

The INTERFACE Analog and INTERFACE Ex product ranges include products that meet the requirements for explosion protection as well as functional safety.

Safety integrity level SIL	Operating mode with a low demand rate (average probability of the specified function failing on demand)
4	$\geq 10^{-5}$ to $< 10^{-4}$
3	$\geq 10^{-4}$ to $< 10^{-3}$
2	$\geq 10^{-3}$ to $< 10^{-2}$
1	$\geq 10^{-2}$ to $< 10^{-1}$

Safety integrity level: failure limit values for a safety function which is operated in an operating mode with a low demand rate.

**Example:**

A sensor and actuator are assembled in the field and are exposed to chemical and physical loads (process medium, pressure, temperature, vibration, etc.). Accordingly, these components have a high risk of failure:

- The sensor accounts for 25% of the overall PFD
- The actuator accounts for 40% of the overall PFD

Neither the failsafe controller nor the interface modules come into contact with the process medium and both are usually located in a protected control cabinet:

- The failsafe controller accounts for 15% of the overall PFD
- Each of the interface modules accounts for 10% of the overall PFD

Typically, the values form the basis for a calculation.

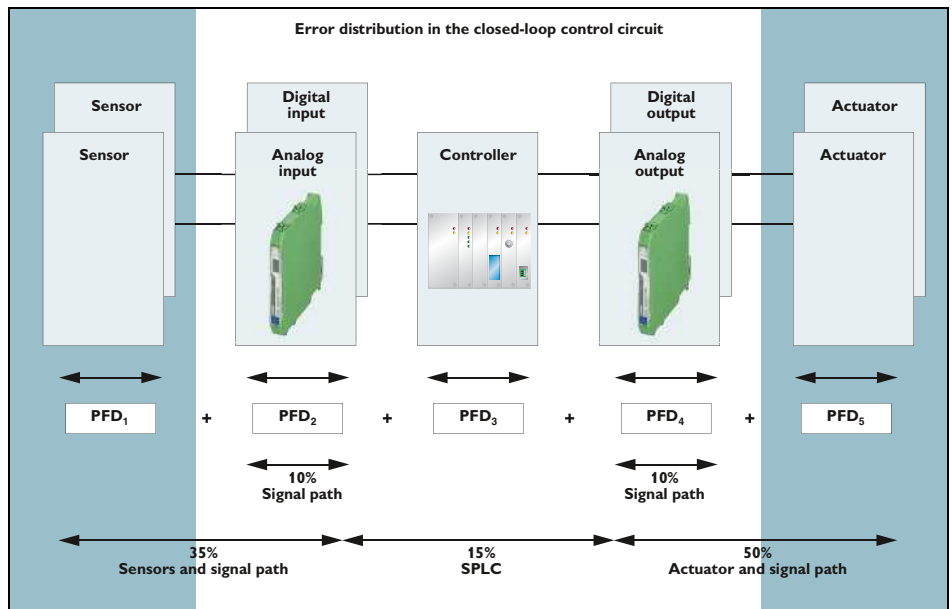

**Functional Safety Performance Level (PL) according to EN ISO 13849-1 and EN 62061**

**General**

In modern industrial systems, the amount of complex technical equipment used is constantly increasing. The purpose of safety technology is to reduce the risk as far as possible but at least to a reasonable degree. At the same time, the availability of production equipment should not be restricted any more than is absolutely necessary.

The Machinery Directive defines the requirements machinery must meet before it can be placed on the market and operated in the European Economic Area. It also contains essential health and safety requirements for the planning and construction of machinery and safety components.

However, the number of systems subject to the directive that do not belong to classical machine building is increasing continually. For example, this includes wind power plants. However, biogas systems, distributed energy generation in general and other process engineering systems also focus on the statutory requirements.

For this reason, analog signals are increasingly being handled according to the specifications of the Machinery Directive.

Every “machine” or system poses a risk. According to the requirements of the Machinery Directive, a risk assessment must be carried out for every machine. If the risk is greater than the level of risk that can be tolerated, risk reduction must be implemented.

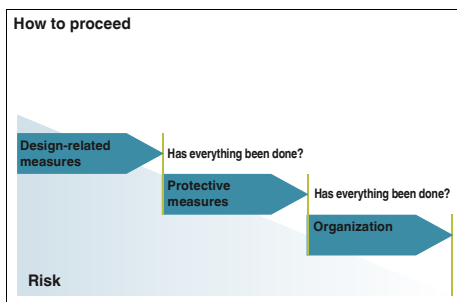

Figure 1: Risk reduction according to EN ISO 12100

**Functional Safety**

In order to achieve the necessary “functional safety” of a system, it is essential for the safety-related parts of the safety equipment and control devices to operate correctly and, in the event of failure, for the system to remain in the safe state or enter a safe state. The requirements for achieving functional safety are based on the following objectives:

- Avoidance of systematic errors
- Control of systematic errors
- Control of random faults or failures

The EN ISO 13849 (and EN 62061) standard specifies the various safety levels in the form of the Performance Level “PL” (and the Safety Integrity Level “SIL”) depending on the extent of the risk and describes the characteristics of the safety functions.

**Practical procedure according to EN ISO 13849**

In practice, the following steps have proved to be effective:

1. Definition of the safety function  
The information is derived from the risk assessment.
2. Determination of the required Performance Level (PL)  
For each safety function, the required performance level is estimated using the adjacent risk graph (Fig. 3).
3. Technical implementation  
This step involves the technical pre-planning of the safety function, taking possible technologies and components into account.
4. Dividing the safety function into subsystems  
Implementation takes place in block diagrams. As a rule, a safety function consists of a sensor-logic actuator.

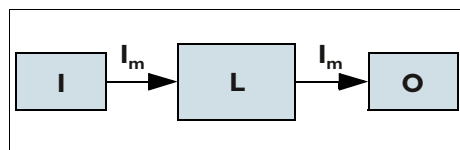

Figure 2: Safety technology block diagram (according to EN 13849-1)

5. Determination of the achieved PL for each subsystem

A characteristic value when determining the performance level is the so-called PFHd value, the statistical “probability of dangerous failure per hour”. The safety technology characteristics are in the product data sheet, the FUNCTIONAL SAFETY CHARACTERISTICS data sheet or

the SISTEMA library (Fig. 4).

Further safety technology characteristic data is in the category, the DC value, and the MTTFD value (Fig. 5).

6. Determination of the achieved PL

The manufacturer of subsystems states the category and makes the specifications on the achieved PFHd value and the PL available.

7. Verification of the achieved PL

Each individual subsystem and the entire safety chain must both meet the requirements of the necessary PL. This includes both the quantitative evaluation and the consideration of systematic aspects, such as proven components and safety principles.

8. Validation

Finally, it is necessary to check whether the selected measures achieve the required risk reduction and therefore, the protection objectives of the risk assessment. The result is included in the final risk assessment.

**Definitions:**

- PFH<sub>D</sub>: probability of dangerous failure per hour
- DC: diagnostic coverage
- MTTF<sub>d</sub>: mean time to dangerous failure

**Category:**

- B10<sub>d</sub>: number of operating cycles, after which 10% of the devices have failed
- CCF: common cause failure

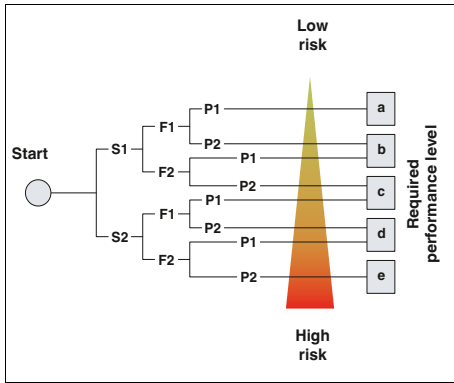

Figure 3: Risk graph

Meaning of individual parameters:

S: severity of injury

– S1: slight (reversible) injuries

– S2: severe (irreversible) injuries

F: frequency and duration of exposure to the hazard

– F1: seldom to not very frequent

– F2: frequent to continuous or long

P: possibility of avoiding or limiting damage

– P1: possible under certain conditions

– P2: hardly possible



Figure 4: SISTEMA library

SISTEMA is a product library with which safety functions can be easily calculated. The products from MACX Safety and MACX Safety Ex are included in a SISTEMA library. It is available from the product download area on the Phoenix Contact homepage.

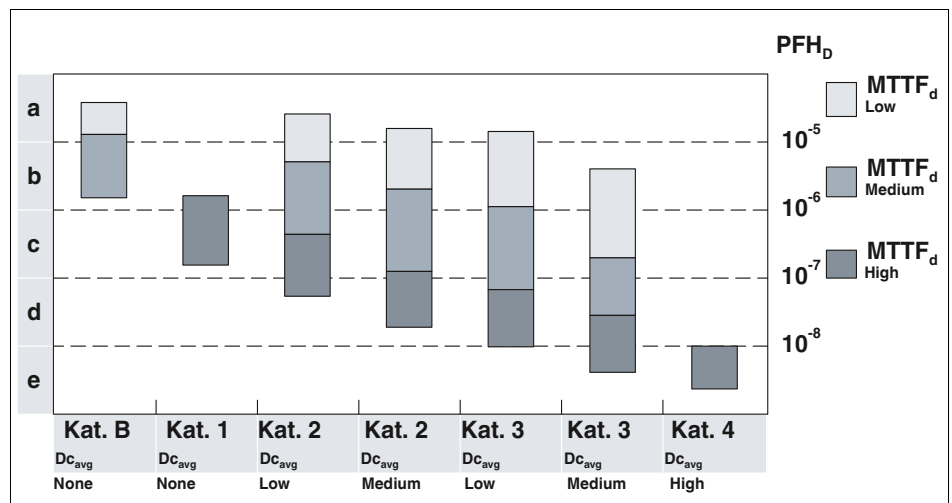
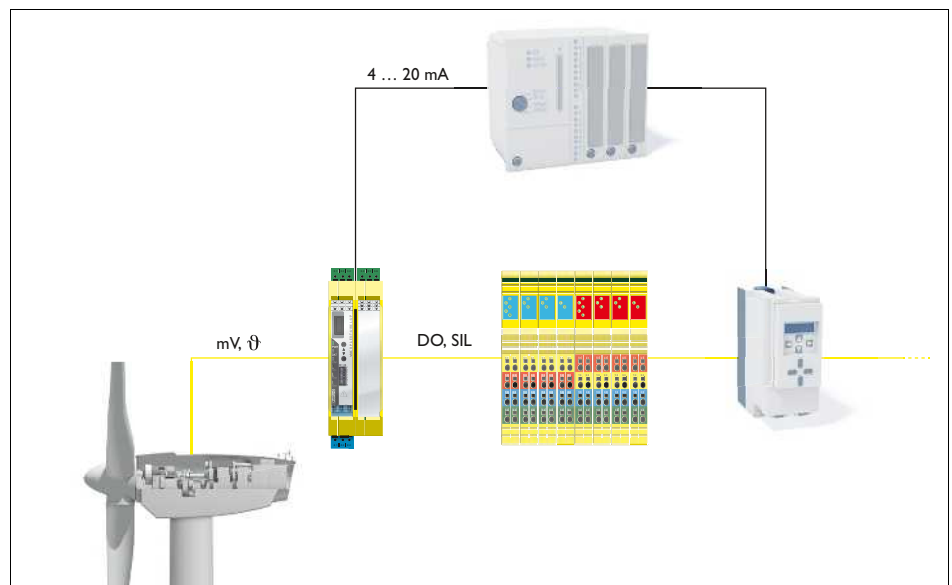

Figure 5: Relationship between PL, category, DC, and MTTFd (according to EN 13849-1)

Phoenix Contact offers a series of services surrounding the topic of functional safety.

It covers everything from initial planning and startup to the modernization of the safety lifecycle. There is also a training concept. Dates are published on the homepage.

In addition, all questions are answered via the free safety hotline.



Application example: safety-related temperature monitoring in a wind power plant

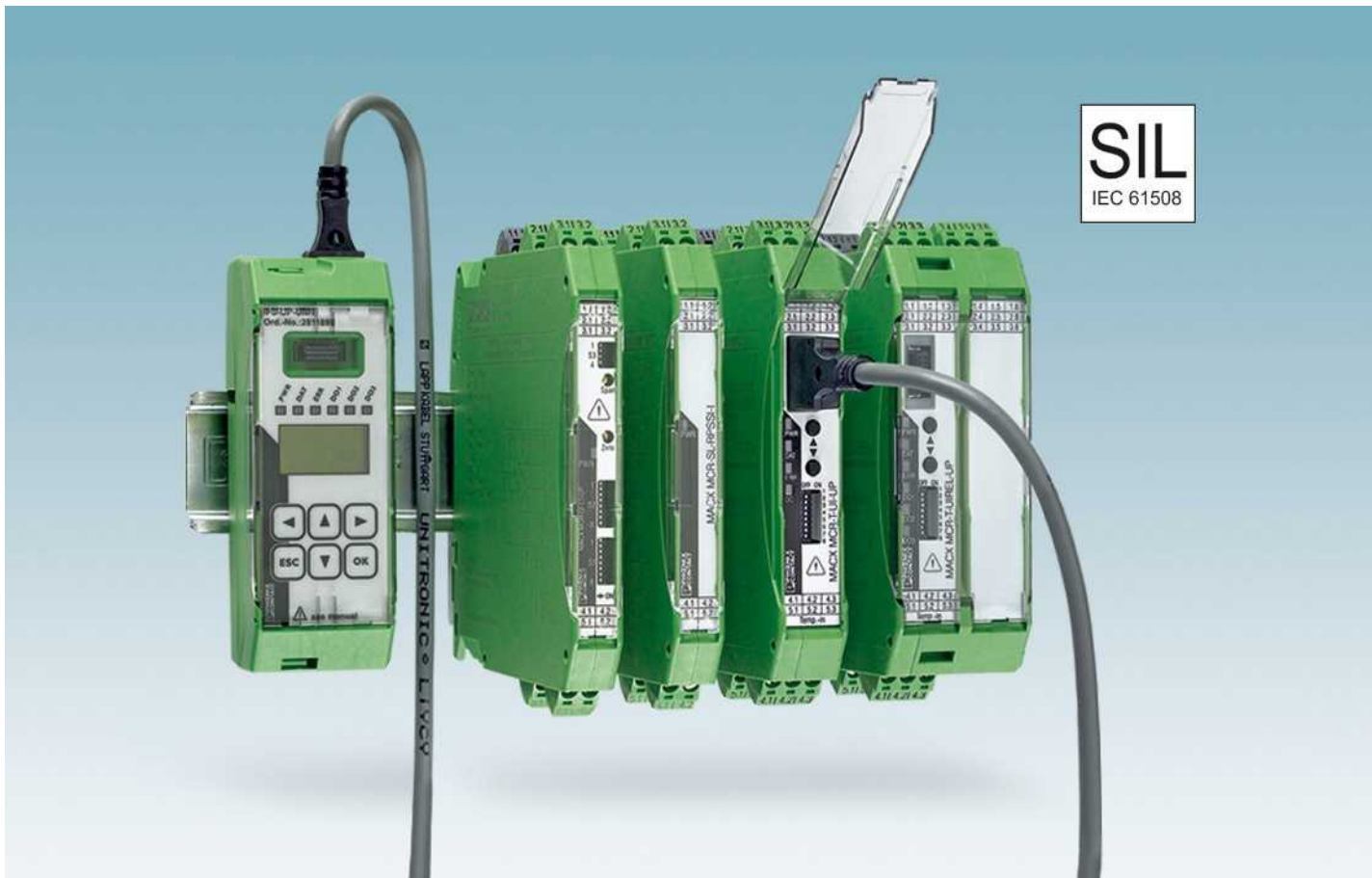

**Reliable and safe**

MACX Analog - safe and high-performance signal conditioners. This product range enables you to safely isolate, condition, filter, and amplify all the signals of your system.

In all phases of the product life cycle, the MACX Analog range has been consistently developed and produced according to standards for functional safety. Save planning and operating costs – by combining high signal flexibility with safe isolation and SIL evaluation.

**Even for the hazardous area**

The devices of the MACX Analog range are approved according to the Ex n protection type for use in Ex zone 2.

**Choose the right MACX Analog signal conditioner for your application:**

The universal nature of the product range provides you with a solution for all applications using analog signal transmission. You are free to choose between either multifunctional high-end devices or reasonably-priced standard modules with exactly the right functions.

**Analog IN/OUT**

- Universal configurable 3-way signal conditioners
- Repeater power supply and signal duplicator with HART signal transmission
- Output signal conditioners with HART signal transmission

**Temperature**

- Universal temperature transducers for resistance thermometers, resistance-type sensors, potentiometers, thermocouples, and mV sources – also with safe limit value relays as an option
- Configurable temperature transducer for resistance thermometers and resistance-type sensors
- Configurable temperature transducer for thermocouples and mV sources

**Digital IN**

- NAMUR signal conditioner with input for NAMUR proximity sensors or switches.
- Different versions in single or two-channel design, with relay or transistor output or for signal duplication.

**Flexible energy supply**



**DIN rail connector-compatible**  
The DIN rail connector enables modular bridging of the 24 V supply voltage.



**Wide range supply**  
The modules featuring a wide range supply (...-UP) can be used in all power supply networks the world over without the need for additional power supply units.



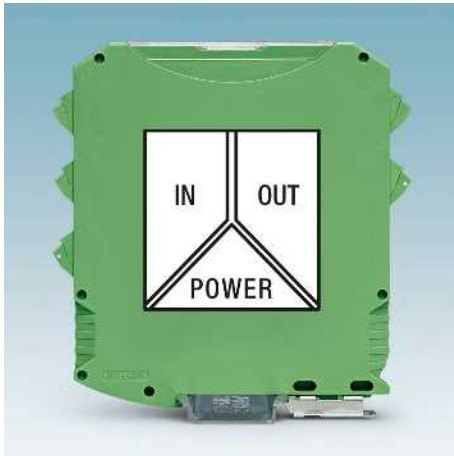

### Precise, interference-free signal transmission

- Precise and interference-free signal transmission due to a patented transmission concept with safe electrical isolation.

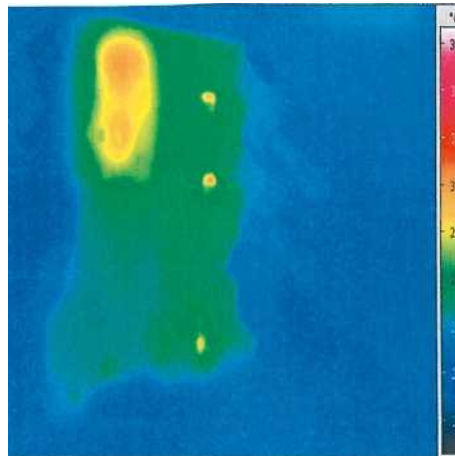

### Long service life and high operational reliability

- Long service life and high operational reliability over the entire operating temperature range, thanks to low power consumption and self-heating



### Easy configuration

- Without software via DIP switches on the device front or with the operator interface and display unit.

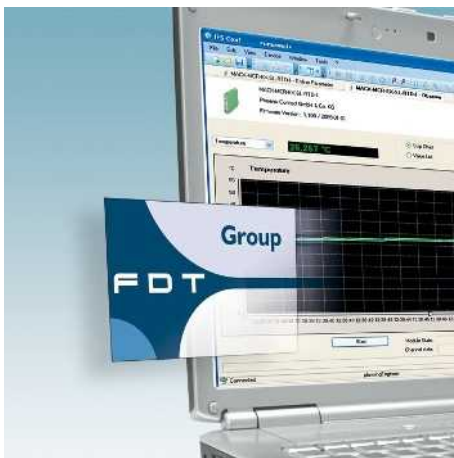

### Easy configuration and monitoring

- Either via FDT/DTM or user-friendly stand-alone software – with integrated monitoring function



### Easy installation, power bridging, and diagnostics

- Flexible supply voltage bridging and the option of redundant, diode-decoupled supply and error indication.
- Plug-in, coded connection terminal blocks with test sockets; with screw connection or with fast push-in connection technology as an option



### Fast and error-free signal connection

- Compact Termination Carriers connect MACX Analog devices to the automation system – Plug and Play



Analog IN/Analog OUT  
3-way signal conditioner

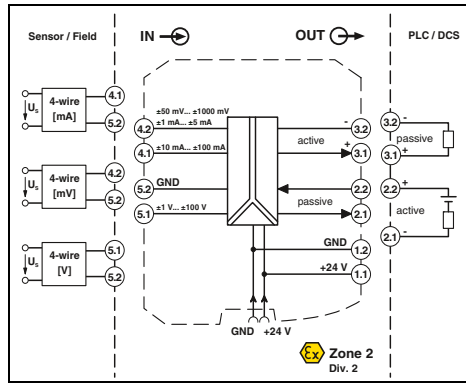
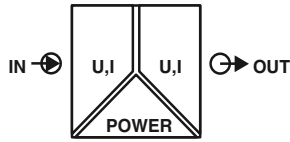

Ex n



Universal,  
more than 1600 signal combinations

Functional Safety

Ex:

Housing width 12.5 mm

Technical data

U input I input  
0 ... 10 V, please indicate if different setting when ordering 0 ... 1 mA, configurable via DIP switches

± 100 V approx. 1 MΩ (± 1 V DC ... ± 100 V DC) ± 100 mA approx. 10 Ω (± 10 mA DC ... ± 100 mA DC)

U output I output  
0 ... 10 V, configurable via DIP switches 0 ... 20 mA, please indicate if different setting when ordering

≥ 1 kΩ (10 V) ≤ 600 Ω (20 mA; active) passive: ≤ (UB-2 V) / I<sub>outmax</sub>

12 V DC ... 24 V DC (-20% / +25%)  
< 0.7 W (at 24 V DC / 20 mA)  
≤ 0.1 % (compared to the final value)  
0.0075 %/K  
± 4 % / ± 4 %  
10 kHz (can be switched to 30 Hz)  
35 μs (at 10 kHz)  
11 ms (at 30 Hz)

2.5 kV (50 Hz, 1 min., test voltage)  
300 V<sub>rms</sub> (rated insulation voltage (surge voltage category II; pollution degree 2, safe isolation as per EN 61010-1))

2.5 kV (50 Hz, 1 min.)  
IP20  
-20 °C ... 70 °C  
any  
PA 66-FR  
12.5 / 99 / 114.5 mm  
0.2 ... 2.5 mm<sup>2</sup> / 0.2 ... 2.5 mm<sup>2</sup> / 24 - 14  
0.2 ... 1.5 mm<sup>2</sup> / 0.2 ... 1.5 mm<sup>2</sup> / 24 - 16  
Class A product, see page 625

CE-compliant  
 II 3 G Ex nA IIC T4 Gc  
Ex nA IIC T4 Gc  
UL 61010 Listed  
Class I, Div. 2, Groups A, B, C, D T6  
Class I, Zone 2, Group IIC  
2

Ordering data

Type	Order No.	Pcs. / Pkt.
MACX MCR-UI-UI	2811284	1
MACX MCR-UI-UI-SP	2811572	1
MACX MCR-UI-UI-NC	2811446	1
MACX MCR-UI-UI-SP-NC	2811556	1

Universal signal conditioner for operating 4-wire measuring transducers

- Analog signal conditioner for isolating, filtering, amplifying, and converting standard analog signals
- Configurable input and output signals, including bipolar current and voltage signals
- 3-way electrical isolation
- Over 1600 signal conversions can be set via DIP switches on the front
- 10 kHz cut-off frequency for time-critical applications
- Output active or passive
- Plug-in screw or push-in connection technology
- Power supply via DIN rail connector possible
- Status indicator for supply voltage
- Up to SIL 2 according to IEC 61508
- Installation in zone 2 permitted

**Notes:**  
To order a product with an order configuration, enter the required configuration by referring to the adjacent order key.  
Information about the power and fault signaling module as well as about the DIN rail connectors and marking material can be found from page 178

Input data  
Input signal (configurable using the DIP switch)

Maximum input signal  
Input resistance

Output data  
Output signal (configurable using the DIP switch)

Load R<sub>B</sub>

General data  
Supply voltage U<sub>B</sub>  
Power dissipation  
Maximum transmission error  
Temperature coefficient  
ZERO / SPAN adjustment  
Cut-off frequency (3 dB)  
Step response (10-90%)

Electrical isolation  
Input/output/power supply

Test voltage, input/output/supply  
Degree of protection  
Ambient temperature (operation)  
Mounting  
Housing material  
Dimensions W / H / D  
Screw connection solid / stranded / AWG  
Push-in connection solid / stranded / AWG  
EMC note

Conformance / approvals  
Conformance  
ATEX  
IECEX  
UL, USA / Canada

SIL in accordance with IEC 61508

Description	Order configuration	Connection
3-way signal conditioner, for electrical isolation of analog signals		
Order configuration	Screw connection	MACX MCR-UI-UI
Order configuration	Push-in connection	MACX MCR-UI-UI-SP
Standard configuration	Screw connection	MACX MCR-UI-UI-NC
Standard configuration	Push-in connection	MACX MCR-UI-UI-SP-NC

Order key for MACX MCR-UI-UI(-SP) (standard configuration entered as an example)

Order No.	Input	Output	Cut-off frequency	Factory calibration certificate (FCC)		
2811284	IN03	OUT01	10K	NONE		
2811284 ≙ MACX MCR-UI-UI	IN40 ≙ 0..50 mV IN24 ≙ 0..60 mV IN41 ≙ 0..75 mV IN25 ≙ 0..100 mV IN43 ≙ 0..120 mV IN44 ≙ 0..150 mV IN26 ≙ 0..200 mV IN27 ≙ 0..300 mV IN28 ≙ 0..500 mV IN66 ≙ 0..1000 mV IN29 ≙ 0 ... 1.0 V IN50 ≙ 0 ... 1.5 V IN30 ≙ 0 ... 2.0 V IN52 ≙ 0 ... 3.0 V IN05 ≙ 0 ... 5 V IN03 ≙ 0 ... 10 V IN67 ≙ 0 ... 15 V IN32 ≙ 0 ... 20 V IN39 ≙ 0 ... 30 V IN68 ≙ 0 ... 50 V IN69 ≙ 0 ... 100 V  IN06 ≙ 1 ... 5 V IN04 ≙ 2 ... 10 V	IN53 ≙ -50..+50 mV IN13 ≙ -60..+60 mV IN54 ≙ -75..+75 mV IN14 ≙ -100..+100 mV IN56 ≙ -120..+120 mV IN57 ≙ -150..+150 mV IN15 ≙ -200..+200 mV IN16 ≙ -300..+300 mV IN17 ≙ -500..+500 mV IN78 ≙ -1000..+1000 mV IN18 ≙ -1.0 ... +1.0 V IN63 ≙ -1.5 ... +1.5 V IN19 ≙ -2.0 ... +2.0 V IN65 ≙ -3.0 ... +3.0 V IN21 ≙ -5 ... +5 V IN22 ≙ -10 ... +10 V IN79 ≙ -15 ... +15 V IN23 ≙ -20 ... +20 V IN80 ≙ -30 ... +30 V IN81 ≙ -50 ... +50 V IN82 ≙ -100 ... +100 V  IN70 ≙ 0 ... 1.0 mA IN71 ≙ 0 ... 1.5 mA IN72 ≙ 0 ... 2.0 mA IN73 ≙ 0 ... 3.0 mA IN36 ≙ 0 ... 5 mA IN37 ≙ 0 ... 10 mA IN74 ≙ 0 ... 15 mA IN01 ≙ 0 ... 20 mA IN75 ≙ 0 ... 30 mA IN76 ≙ 0 ... 50 mA IN77 ≙ 0 ... 100 mA  IN83 ≙ -1.0 ... +1.0 mA IN84 ≙ -1.5 ... +1.5 mA IN85 ≙ -2.0 ... +2.0 mA IN86 ≙ -3.0 ... +3.0 mA IN33 ≙ -5 ... +5 mA IN34 ≙ -10 ... +10 mA IN87 ≙ -15 ... +15 mA IN35 ≙ -20 ... +20 mA IN88 ≙ -30 ... +30 mA IN89 ≙ -50 ... +50 mA IN90 ≙ -100 ... +100 mA  IN91 ≙ 1 ... 5 mA IN92 ≙ 2 ... 10 mA IN02 ≙ 4 ... 20 mA	OUT19 ≙ 0 ... 2.5 V OUT05 ≙ 0 ... 5 V OUT03 ≙ 0 ... 10 V  OUT20 ≙ -2.5 ... +2.5 V OUT13 ≙ -5 ... +5 V OUT14 ≙ -10 ... +10 V  OUT24 ≙ 0.5 ... +2.5 V OUT06 ≙ 1 ... 5 V OUT04 ≙ 2 ... 10 V  OUT27 ≙ 2.5 ... 0 V OUT11 ≙ 5 ... 0 V OUT09 ≙ 10 ... 0 V	OUT15 ≙ 0 ... 5 mA OUT16 ≙ 0 ... 10 mA OUT01 ≙ 0 ... 20 mA  OUT21 ≙ -5 ... +5 mA OUT22 ≙ -10 ... +10 mA OUT23 ≙ -20 ... +20 mA  OUT25 ≙ 1 ... 5 mA OUT26 ≙ 2 ... 10 mA OUT02 ≙ 4 ... 20 mA  OUT28 ≙ 5 ... 0 mA OUT29 ≙ 10 ... 0 mA OUT07 ≙ 20 ... 0 mA	30 ≙ 30 Hz 10K ≙ 10 kHz	NONE ≙ without FCC YES ≙ with FCC (a fee is charged)  YESPLUS ≙ FCC with 5 measuring points (a fee is charged)

Application example: level measurement and active analog input card

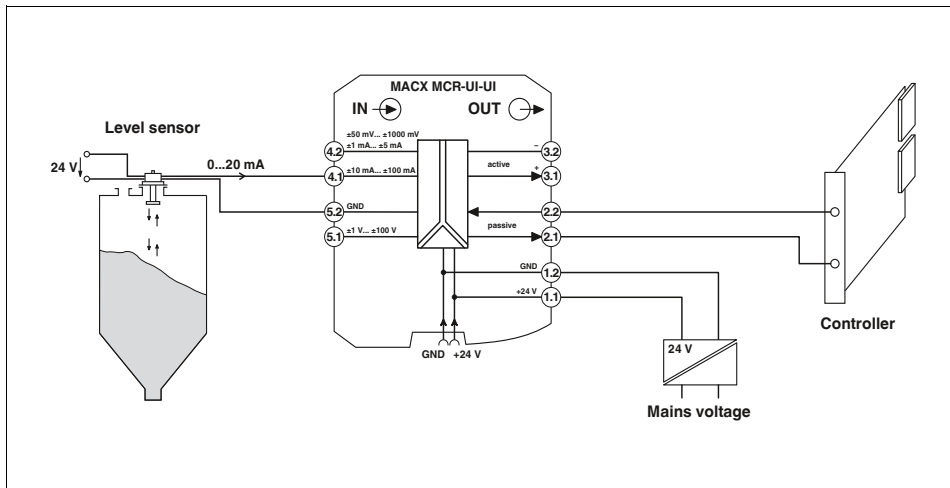

Application example: shunt measurement and Inline terminal with passive analog input channels within an Inline station

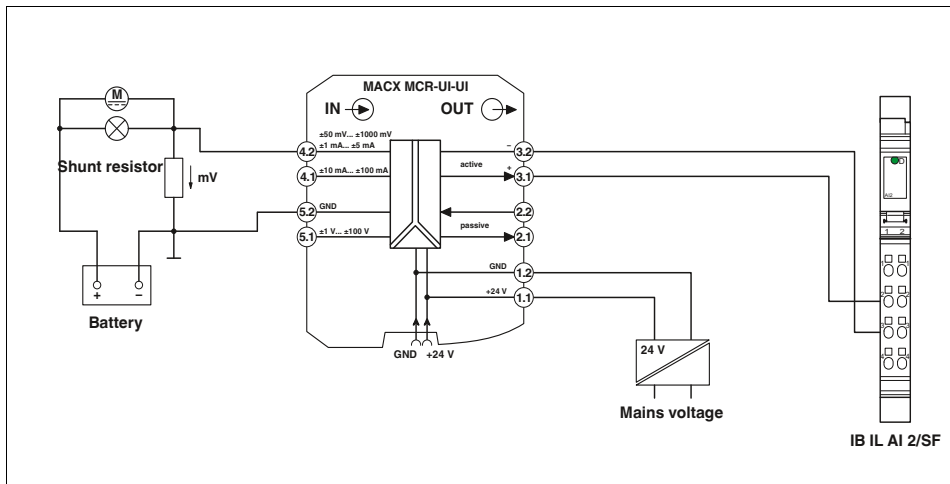

(Information on automation solutions from Phoenix Contact can be found in Catalog 8 or at [www.phoenixcontact.net/products](http://www.phoenixcontact.net/products))

Analog IN/Analog OUT  
3-way signal conditioner

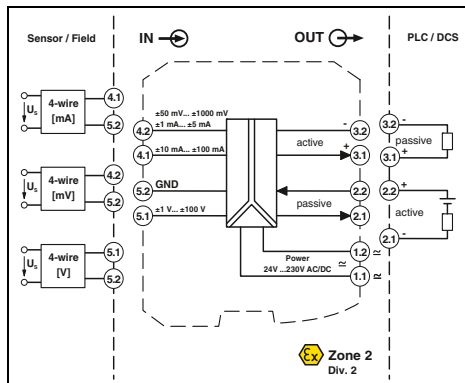
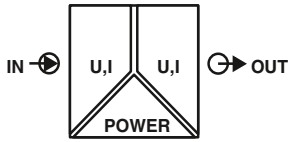

Ex n



Universal,  
more than 1600 signal combinations,  
wide range power supply

Functional Safety

Ex: Ex n

Housing width 12.5 mm

Technical data

U input	I input
0 ... 10 V, please indicate if different setting when ordering	
± 100 V	± 100 mA
approx. 1 MΩ	approx. 10 Ω
(± 1 V DC ... ± 100 V DC)	(± 10 mA DC ... ± 100 mA DC)
U output	I output
0 ... 20 mA, configurable via DIP switches	
15 V	35 mA
≥ 1 kΩ (10 V)	≤ 600 Ω (20 mA; active)
	passive: ≤ (UB-2 V) / I <sub>outmax</sub>
24 V ... 230 V AC/DC (-20%/+10%, 50/60 Hz)	
< 0.8 W (at 24 V DC / 20 mA)	
< 0.9 W (at 230 V AC / 20 mA)	
≤ 0.1 % (compared to the final value)	
0.0075 %/K	
± 4 % / ± 4 %	
2.5 kV (50 Hz, 1 min., test voltage)	
300 V <sub>rms</sub> (rated insulation voltage (surge voltage category II; pollution degree 2, safe isolation as per EN 61010-1))	
IP20	
-20 °C ... 70 °C	
PA 66-FR	
12.5 / 99 / 114.5 mm	
0.2 ... 2.5 mm <sup>2</sup> / 0.2 ... 2.5 mm <sup>2</sup> / 24 - 14	
0.2 ... 1.5 mm <sup>2</sup> / 0.2 ... 1.5 mm <sup>2</sup> / 24 - 16	
Class A product, see page 625	
CE-compliant	
Ex II 3 G Ex nA IIC T4 Gc	
2	

- Analog signal conditioner for isolating, filtering, amplifying, and converting standard analog signals
- Configurable input and output signals, including bipolar current and voltage signals
- 3-way electrical isolation
- Over 1600 signal conversions can be set via DIP switches on the front
- Output active or passive
- Plug-in screw or push-in connection technology
- Wide range power supply: 19.2 ... 253 V AC/DC
- Status indicator for supply voltage
- Up to SIL 2 according to IEC 61508
- Installation in zone 2 permitted

Notes:

To order a product with an order configuration, enter the required configuration by referring to the adjacent order key.

<b>Input data</b>	Input signal (configurable using the DIP switch)
Maximum input signal	
Input resistance	
<b>Output data</b>	Output signal (configurable using the DIP switch)
Maximum output signal	
Load R <sub>B</sub>	
<b>General data</b>	Supply voltage U <sub>B</sub>
	Power dissipation
Maximum transmission error	
Temperature coefficient	
ZERO / SPAN adjustment	
Electrical isolation	Input/output/power supply
Degree of protection	
Ambient temperature (operation)	
Housing material	
Dimensions W / H / D	
Screw connection solid / stranded / AWG	
Push-in connection solid / stranded / AWG	
EMC note	
<b>Conformance / approvals</b>	
Conformance	
ATEX	
SIL in accordance with IEC 61508	

Description	
<b>3-way signal conditioner</b> , for electrical isolation of analog signals with long-range power supply	
Order configuration	Screw connection
Order configuration	Push-in connection
Standard configuration	Screw connection
Standard configuration	Push-in connection

Ordering data

Type	Order No.	Pcs. / Pkt.
MACX MCR-UI-UI-UP	2811459	1
MACX MCR-UI-UI-UP-SP	2811585	1
MACX MCR-UI-UI-UP-NC	2811297	1
MACX MCR-UI-UI-UP-SP-NC	2811569	1

Signal conditioners with SIL functional safety - MACX Analog

Order key for MACX MCR-UI-UI(-SP) (standard configuration entered as an example)

Order No.	Input	Output	Cut-off frequency	Factory calibration certificate (FCC)		
2811459	IN03	OUT01	10K	NONE		
2811459 ≙ MACX MCR-UI-UI-UP	IN40 ≙ 0..50 mV IN24 ≙ 0..60 mV IN41 ≙ 0..75 mV IN25 ≙ 0..100 mV IN43 ≙ 0..120 mV IN44 ≙ 0..150 mV IN26 ≙ 0..200 mV IN27 ≙ 0..300 mV IN28 ≙ 0..500 mV IN66 ≙ 0..1000 mV IN29 ≙ 0 ... 1.0 V IN50 ≙ 0 ... 1.5 V IN30 ≙ 0 ... 2.0 V IN52 ≙ 0 ... 3.0 V IN05 ≙ 0 ... 5 V IN03 ≙ 0 ... 10 V IN67 ≙ 0 ... 15 V IN32 ≙ 0 ... 20 V IN39 ≙ 0 ... 30 V IN68 ≙ 0 ... 50 V IN69 ≙ 0 ... 100 V  IN06 ≙ 1...5 V IN04 ≙ 2...10 V	IN70 ≙ 0 ... 1.0 mA IN71 ≙ 0 ... 1.5 mA IN72 ≙ 0 ... 2.0 mA IN73 ≙ 0 ... 3.0 mA IN36 ≙ 0 ... 5 mA IN37 ≙ 0 ... 10 mA IN74 ≙ 0 ... 15 mA IN01 ≙ 0 ... 20 mA IN75 ≙ 0 ... 30 mA IN76 ≙ 0 ... 50 mA IN77 ≙ 0 ... 100 mA  IN83 ≙ -1.0 ... +1.0 mA IN84 ≙ -1.5...+1.5 mA IN85 ≙ -2.0 ... +2.0 mA IN86 ≙ -3.0 ... +3.0 mA IN33 ≙ -5...+5 mA IN34 ≙ -10 ... +10 mA IN87 ≙ -15 ... +15 mA IN35 ≙ -20 ... +20 mA IN88 ≙ -30 ... +30 mA IN89 ≙ -50 ... +50 mA IN90 ≙ -100 ... +100 mA  IN91 ≙ 1 ... 5 mA IN92 ≙ 2 ... 10 mA IN02 ≙ 4 ... 20 mA	OUT19 ≙ 0 ... 2.5 V OUT05 ≙ 0 ... 5 V OUT03 ≙ 0 ... 10 V  OUT20 ≙ -2.5...+2.5 V OUT13 ≙ -5...+5 V OUT14 ≙ -10 ... +10 V  OUT24 ≙ 0.5...+2.5 V OUT06 ≙ 1...5 V OUT04 ≙ 2...10 V  OUT27 ≙ 2.5...0 V OUT11 ≙ 5...0 V OUT09 ≙ 10 ... 0 V	OUT15 ≙ 0 ... 5 mA OUT16 ≙ 0 ... 10 mA OUT01 ≙ 0 ... 20 mA  OUT21 ≙ -5 ... +5 mA OUT22 ≙ -10...+10 mA OUT23 ≙ -20 ... +20 mA  OUT25 ≙ 1 ... 5 mA OUT26 ≙ 2 ... 10 mA OUT02 ≙ 4 ... 20 mA  OUT28 ≙ 5 ... 0 mA OUT29 ≙ 10 ... 0 mA OUT07 ≙ 20 ... 0 mA	30 ≙ 30 Hz 10K ≙ 10 kHz	NONE ≙ without FCC YES ≙ with FCC (a fee is charged)  YESPLUS ≙ FCC with 5 measuring points (a fee is charged)

Application example: level measurement and active analog input card

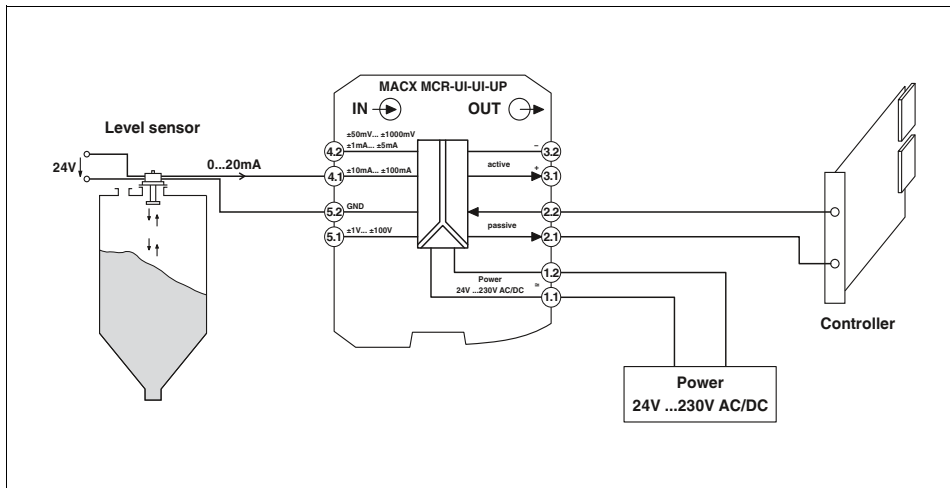

Application example: shunt measurement and Inline terminal with analog input channels within an Inline station

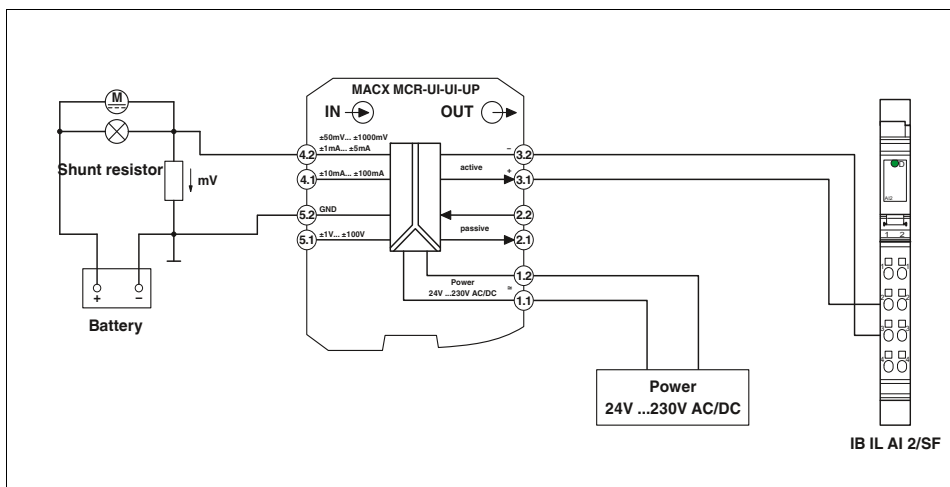

(Information on automation solutions from Phoenix Contact can be found in Catalog 8 or at [www.phoenixcontact.net/products](http://www.phoenixcontact.net/products))

Analog IN/Analog OUT  
repeater power supply

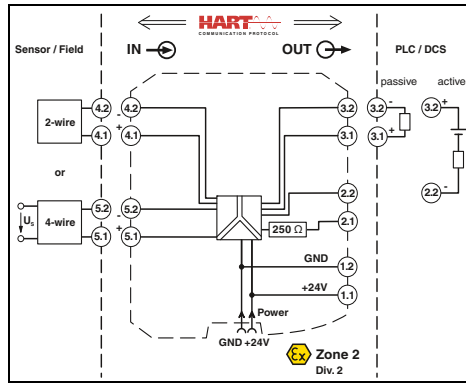
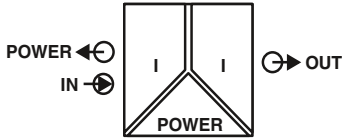

Ex n



Repeater power supply and input signal conditioner

Functional Safety  
Ex: Ex n  
Housing width 12.5 mm

Repeater power supply and input signal conditioner for the operation of 2-wire measuring transducers, 4-wire measuring transducers, and mA current sources

- Input 0/4...20 mA (powered or not powered)
- 0/4...20 mA output (active or passive)
- Bidirectional transmission of digital HART communication signals
- Plug-in screw or push-in connection technology, with integrated sockets for HART communicators
- Terminal point with 250 Ω resistor to increase the HART impedance in the case of low-impedance systems
- 3-way electrical isolation
- Power supply via DIN rail connector possible
- Up to SIL 2 according to IEC 61508
- Installation in zone 2 permitted

<b>Notes:</b>
Information about the power and fault signaling module as well as about the DIN rail connectors and marking material can be found from page 178
Test plugs for test sockets can be found on page 180
Information on Plug and Play connection using system cabling can be found from page 182

<b>Input data</b>	
Input signal	4 mA ... 20 mA
Transmitter supply voltage	> 21.5 V (20 mA)
Voltage drop	< 3.5 V
<b>Output data</b>	
Output signal	4 mA ... 20 mA (active) 4 mA ... 20 mA (14 ... 26 V ext. source voltage)
Load	< 1000 Ω (20 mA)
Output ripple	< 20 mV <sub>rms</sub>
<b>General data</b>	
Supply voltage range	19.2 V DC ... 30 V DC (24 V DC (-20% ... +25%))
Current consumption	< 76 mA (24 V DC / 20 mA / 1000 Ω); < 55 mA (24 V DC / 20 mA / 250 Ω)
Power dissipation	< 1.1 W (24 V DC / 20 mA) < 0.95 W (24 V DC / 20 mA / 250 Ω) < 1.2 W (24 V DC / 20 mA / 0 Ω)
Temperature coefficient	< 0.01 %/K
Step response (10-90%)	< 200 μs (for 4 mA ... 20 mA step, load 600)
Transmission error, typical	< 0.05 % (of final value)
Maximum transmission error	< 0.1 % (of final value)
Underload/overload range	according to NE 43
Electrical isolation	
Input/output/power supply	300 V <sub>rms</sub> (rated insulation voltage (surge voltage category II; pollution degree 2, safe isolation as per EN 61010-1)) 2.5 kV (50 Hz, 1 min., test voltage)
Ambient temperature range	-20 °C ... 60 °C (any mounting position)
Status indication	Green LED (supply voltage)
SMART communication	Yes
Signal bandwidth	as per HART specifications
Protocols supported	HART
Housing material	PA 66-FR
Dimensions W / H / D	12.5 / 112.5 / 114.5 mm
Screw connection solid / stranded / AWG	0.2 ... 2.5 mm <sup>2</sup> / 0.2 ... 2.5 mm <sup>2</sup> / 24 - 14
Push-in connection solid / stranded / AWG	0.2 ... 1.5 mm <sup>2</sup> / 0.2 ... 1.5 mm <sup>2</sup> / 24 - 16
EMC note	Class A product, see page 625
<b>Conformance / approvals</b>	
Conformance	CE-compliant, additionally EN 61326
ATEX	Ex II 3 G Ex nA IIC T4 Gc
UL, USA / Canada	UL 61010 Listed Class I, Div. 2, Groups A, B, C, D T4 Class I, Zone 2, Group IIC T4
SIL in accordance with IEC 61508	2

**Technical data**

<b>Technical data</b>	
Input signal	4 mA ... 20 mA
Transmitter supply voltage	> 21.5 V (20 mA)
Voltage drop	< 3.5 V
Output signal	4 mA ... 20 mA (active) 4 mA ... 20 mA (14 ... 26 V ext. source voltage)
Load	< 1000 Ω (20 mA)
Output ripple	< 20 mV <sub>rms</sub>
Supply voltage range	19.2 V DC ... 30 V DC (24 V DC (-20% ... +25%))
Current consumption	< 76 mA (24 V DC / 20 mA / 1000 Ω); < 55 mA (24 V DC / 20 mA / 250 Ω)
Power dissipation	< 1.1 W (24 V DC / 20 mA) < 0.95 W (24 V DC / 20 mA / 250 Ω) < 1.2 W (24 V DC / 20 mA / 0 Ω)
Temperature coefficient	< 0.01 %/K
Step response (10-90%)	< 200 μs (for 4 mA ... 20 mA step, load 600)
Transmission error, typical	< 0.05 % (of final value)
Maximum transmission error	< 0.1 % (of final value)
Underload/overload range	according to NE 43
Electrical isolation	
Input/output/power supply	300 V <sub>rms</sub> (rated insulation voltage (surge voltage category II; pollution degree 2, safe isolation as per EN 61010-1)) 2.5 kV (50 Hz, 1 min., test voltage)
Ambient temperature range	-20 °C ... 60 °C (any mounting position)
Status indication	Green LED (supply voltage)
SMART communication	Yes
Signal bandwidth	as per HART specifications
Protocols supported	HART
Housing material	PA 66-FR
Dimensions W / H / D	12.5 / 112.5 / 114.5 mm
Screw connection solid / stranded / AWG	0.2 ... 2.5 mm <sup>2</sup> / 0.2 ... 2.5 mm <sup>2</sup> / 24 - 14
Push-in connection solid / stranded / AWG	0.2 ... 1.5 mm <sup>2</sup> / 0.2 ... 1.5 mm <sup>2</sup> / 24 - 16
EMC note	Class A product, see page 625
<b>Conformance / approvals</b>	
Conformance	CE-compliant, additionally EN 61326
ATEX	Ex II 3 G Ex nA IIC T4 Gc
UL, USA / Canada	UL 61010 Listed Class I, Div. 2, Groups A, B, C, D T4 Class I, Zone 2, Group IIC T4
SIL in accordance with IEC 61508	2

**Ordering data**

Description	Type	Order No.	Pcs. / Pkt.
<b>Repeater power supply, with HART® protocol</b>			
Screw connection	MACX MCR-SL-RPSSI-I	2865955	1
Push-in connection	MACX MCR-SL-RPSSI-I-SP	2924207	1

Analog IN/Analog OUT  
repeater power supply

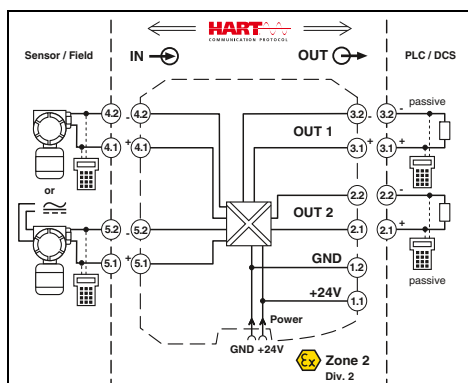
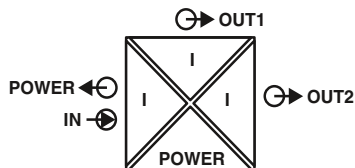

Repeater power supply and input signal conditioner, with two electrically isolated outputs

Functional Safety

Ex: Ex n

Housing width 12.5 mm

Repeater power supply and input signal conditioner for the operation of 2-wire measuring transducers, 4-wire measuring transducers, and mA current sources

- Input 0/4...20 mA (powered or not powered)
- Two electrically isolated 0/4 ... 20 mA (active) outputs
- Bidirectional transmission of digital HART communication signals (both outputs)
- Plug-in screw or push-in connection technology, with integrated sockets for HART communicators
- 4-way electrical isolation
- Power supply via DIN rail connector possible
- Up to SIL 2 according to IEC 61508
- Installation in zone 2 permitted

Input data

Input signal  
Transmitter supply voltage  
Voltage drop

Output data

Output signal (per output)

Load

Output ripple

General data

Supply voltage range  
Current consumption  
Power dissipation  
Temperature coefficient  
Step response (10-90%)  
Transmission error, typical  
Maximum transmission error  
Underload/overload range  
Electrical isolation

Input/output/power supply

Output 1/output 2

Ambient temperature range  
Status indication  
SMART communication (per output)  
Protocols supported  
Housing material  
Dimensions W / H / D  
Screw connection solid / stranded / AWG  
Push-in connection solid / stranded / AWG  
EMC note

Conformance / approvals

Conformance  
ATEX  
SIL in accordance with IEC 61508

Technical data

4 mA ... 20 mA / 0 mA ... 20 mA  
> 21.5 V (at 20 mA)  
< 3.9 V (in input signal conditioner operation)

0 mA ... 20 mA (active)  
4 mA ... 20 mA (active)  
< 450 Ω (at 20 mA)  
< 20 mV<sub>rms</sub>

19.2 V DC ... 30 V DC (24 V DC (-20% ... +25%))  
< 75 mA (at 24 V DC)  
< 1.45 W (at 24 V DC / 20 mA)  
< 0.01 %/K  
< 1.3 ms (for 4 mA ... 20 mA step)  
< 0.05 % (of final value)  
< 0.1 % (of final value)  
according to NE 43

300 V<sub>rms</sub> (rated insulation voltage (surge voltage category II; pollution degree 2, safe isolation as per EN 61010-1))  
2.5 kV (50 Hz, 1 min., test voltage)

1.5 kV AC (50 Hz, 1 min., test voltage)  
-20 °C ... 60 °C (any mounting position)  
Green LED (PWR supply voltage)  
Yes  
HART  
PA 66-FR  
12.5 / 99 / 114.5 mm  
0.2 ... 2.5 mm<sup>2</sup> / 0.2 ... 2.5 mm<sup>2</sup> / 24 - 14  
0.2 ... 1.5 mm<sup>2</sup> / 0.2 ... 1.5 mm<sup>2</sup> / 24 - 16  
Class A product, see page 625

CE-compliant, additionally EN 61326  
Ex II 3 G Ex nA IIC T4 Gc X  
2

**Notes:**

Information about the power and fault signaling module as well as about the DIN rail connectors and marking material can be found from page 178

Test plugs for test sockets can be found on page 180

Information on Plug and Play connection using system cabling can be found from page 182

Ordering data

Description	Type	Order No.	Pcs. / Pkt.	
Repeater power supply, with HART® protocol	Screw connection	MACX MCR-SL-RPSSI-2I	2924825	1
	Push-in connection	MACX MCR-SL-RPSSI-2I-SP	2924838	1



Analog IN/Analog OUT  
repeater power supply

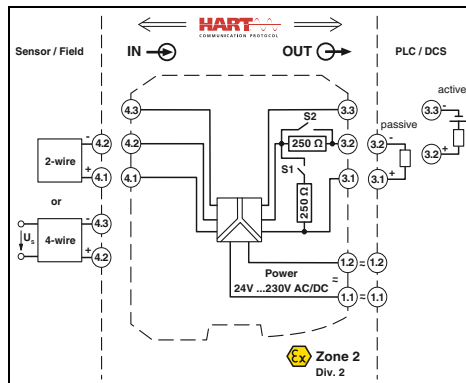
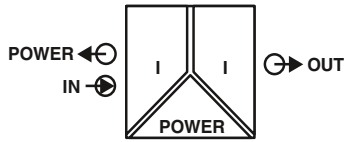

Ex n



Functional Safety

Ex: Ex n

Housing width 17.5 mm



Repeater power supply and input signal conditioner, wide range power supply

Repeater power supply and input signal conditioner for the operation of 2-wire measuring transducers, 4-wire measuring transducers, and mA current sources

- Input 0/4...20 mA (powered or not powered)
- Output 0/4...20 mA (active or passive), 0/1...5 V, can be switched via the DIP switch
- Bidirectional transmission of digital HART communication signals
- Plug-in screw or push-in connection technology, with integrated sockets for HART communicators
- 250 Ω resistor that can be activated via DIP switches to increase the HART impedance in the case of low-impedance systems
- 3-way electrical isolation
- Wide range power supply: 19.2 ... 253 V AC/DC
- Up to SIL 2 according to IEC 61508
- Installation in zone 2 permitted

**Notes:**  
Information about the power and fault signaling module as well as about the DIN rail connectors and marking material can be found from page 178  
Test plugs for test sockets can be found on page 180

<b>Input data</b>	Input signal Transmitter supply voltage Voltage drop
<b>Output data</b>	Output signal
<b>Load</b>	Output ripple
<b>General data</b>	Supply voltage range Current consumption Power dissipation Temperature coefficient Step response (10-90%) Transmission error, typical Maximum transmission error Underload/overload range Electrical isolation
<b>Input/output/power supply</b>	Ambient temperature range Status indication SMART communication Signal bandwidth Protocols supported Housing material Dimensions W / H / D Screw connection solid / stranded / AWG Push-in connection solid / stranded / AWG EMC note
<b>Conformance / approvals</b>	Conformance ATEX UL, USA / Canada
SIL in accordance with IEC 61508	

**Technical data**

4 mA ... 20 mA > 16 V (20 mA) < 3.5 V (in input signal conditioner operation)
4 mA ... 20 mA (active) 4 mA ... 20 mA (14 ... 26 V ext. source voltage) 1 V ... 5 V (internal resistance, 250 Ω, 0.1%) < 600 Ω (20 mA) < 20 mV <sub>rms</sub>
24 V ... 230 V AC/DC (-20%/+10%, 50/60 Hz) < 80 mA (24 V DC/ 20 mA) < 1.6 W (24 V DC/ 20 mA) < 0.01 %/K < 600 μs (for 4 mA ... 20 mA step) < 0.05 % (of final value) < 0.1 % (of final value) according to NE 43
300 V <sub>rms</sub> (rated insulation voltage (surge voltage category II; pollution degree 2, safe isolation as per EN 61010-1)) 2.5 kV (50 Hz, 1 min., test voltage)
-20 °C ... 60 °C (any mounting position) Green LED (supply voltage) Yes as per HART specifications HART PA 66-FR 17.5 / 99 / 114.5 mm 0.2 ... 2.5 mm <sup>2</sup> / 0.2 ... 2.5 mm <sup>2</sup> / 24 - 14 0.2 ... 1.5 mm <sup>2</sup> / 0.2 ... 1.5 mm <sup>2</sup> / 24 - 16 Class A product, see page 625
CE-compliant, additionally EN 61326 Ex II 3 G Ex nA IIC T4 Gc X UL 508 Listed UL 61010 Listed Class I, Div. 2, Groups A, B, C, D T4 Class I, Zone 2, Group IIC T4 2

**Ordering data**

Description
Repeater power supply, with HART® protocol
Screw connection Push-in connection

Type	Order No.	Pcs. / Pkt.
MACX MCR-SL-RPSSI-I-UP	2865968	1
MACX MCR-SL-RPSSI-I-UP-SP	2924210	1

Analog IN/Analog OUT  
repeater power supply

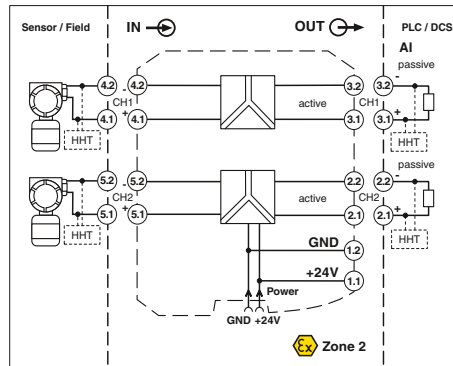
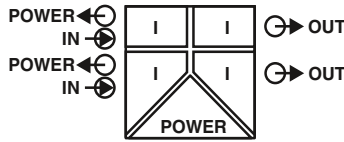

2-channel repeater power supply

Repeater power supply for the operation of 2-wire measuring transducers.

- 2-channel
- Input: 4 ... 20 mA (powered)
- Output: 4 ... 20 mA (active)
- Bidirectional transmission of digital HART communication signals
- Plug-in screw or push-in connection technology, with integrated sockets for HART communicators
- Safe 3-way electrical isolation
- Power supply via DIN rail connector possible
- Up to SIL 3 according to IEC 61508
- Installation in zone 2 permitted

**Notes:**

Information about the power and fault signaling module as well as about the DIN rail connectors and marking material can be found from page 178
Test plugs for test sockets can be found on page 180
Information on Plug and Play connection using system cabling can be found from page 182

<b>Input data</b>	Input signal Transmitter supply voltage Underload/overload signal range
<b>Output data</b>	Output signal Load Underload/overload signal range
<b>General data</b>	Supply voltage range Current consumption Power dissipation Temperature coefficient Step response (10-90%) Transmission error, typical Maximum transmission error Electrical isolation
<b>Ambient temperature range</b>	
<b>Status indication</b>	
<b>SMART communication</b>	
<b>Signal bandwidth</b>	
<b>Protocols supported</b>	
<b>Housing material</b>	
<b>Dimensions W / H / D</b>	
<b>Screw connection solid / stranded / AWG</b>	
<b>Push-in connection solid / stranded / AWG</b>	
<b>Conformance / approvals</b>	
<b>Conformance</b>	
<b>ATEX</b>	
<b>IECEX</b>	
<b>UL, USA / Canada</b>	
<b>SIL in accordance with IEC 61508</b>	

Housing width 12.5 mm

**Technical data**

<b>per channel</b>	4 mA ... 20 mA > 16 V (at 20 mA) 0 mA ... 24 mA
<b>per channel</b>	4 mA ... 20 mA (active) ≤ 450 Ω (20 mA) 0 mA ... 24 mA
<b>Supply voltage range</b>	19.2 V DC ... 30 V DC (24 V DC (-20% ... +25%)) < 100 mA (24 V / 20 mA) < 1.4 W (at 24 V DC / 20 mA) < 0.01 %/K < 1.3 ms (for 4 mA ... 20 mA step) < 0.05 % (of final value) < 0.1 % (of final value)
<b>Input/output, power supply</b>	300 V <sub>rms</sub> (rated insulation voltage (surge voltage category II; pollution degree 2, safe isolation as per EN 61010-1)) 2.5 kV (50 Hz, 1 min., test voltage)
<b>Input/output</b>	375 V (peak value in accordance with EN 60079-11)
<b>Input/power supply</b>	375 V (peak value in accordance with EN 60079-11)
<b>Output 1/output 2/ power supply</b>	1.5 kV (50 Hz, 1 min., test voltage) -20 °C ... 60 °C (any mounting position) Green LED (supply voltage) Yes as per HART specifications HART PA 66-FR 12.5 / 99 / 114.5 mm 0.2 ... 1.5 mm <sup>2</sup> / 0.2 ... 1.5 mm <sup>2</sup> / 24 - 16 0.2 ... 1.5 mm <sup>2</sup> / 0.2 ... 1.5 mm <sup>2</sup> / 24 - 16
<b>CE-compliant, additionally EN 61326</b>	CE-compliant, additionally EN 61326 Ex II 3 G Ex nA IIC T4 Gc
<b>UL 61010 Listed</b>	UL 61010 Listed Class I, Div. 2, Groups A, B, C, D T4 Class I, Zone 2, Group IIC T4 3

**Ordering data**

Description	Type	Order No.	Pcs. / Pkt.	
Repeater power supply, 2-channel	Screw connection	MACX MCR-SL-RPSS-2I-2I	2904089	1
	Push-in connection	MACX MCR-SL-RPSS-2I-2I-SP	2904090	1

Analog OUT  
Output signal conditioner

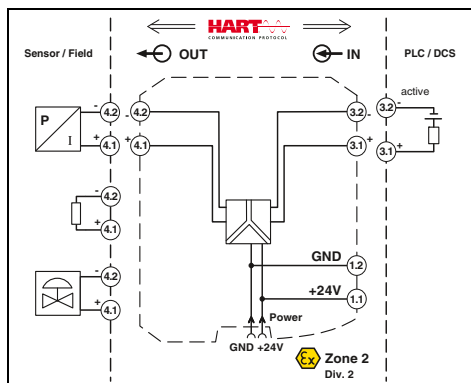
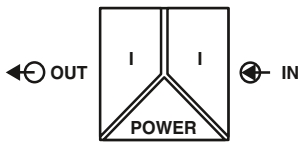

Functional Safety  
Ex: Ex n  
Housing width 12.5 mm

Output signal conditioner for controlling I/P transducers, control valves, and displays

- 0/4...20 mA input
- 0/4 ... 20 mA output
- Bidirectional transmission of digital HART communication signals
- Plug-in screw or push-in connection technology, with integrated sockets for HART communicators
- Line fault detection (LF)
- 3-way electrical isolation
- Power supply via DIN rail connector possible
- Up to SIL 2 according to IEC 61508
- Installation in zone 2 permitted

<b>Notes:</b>
Information about the power and fault signaling module as well as about the DIN rail connectors and marking material can be found from page 178
Test plugs for test sockets can be found on page 180
Information on Plug and Play connection using system cabling can be found from page 182

<b>Input data</b>	
Input signal	
Input voltage	
Input impedance in the event of a cable break at the output	
<b>Output data</b>	
Output signal	
Load	
Output ripple	
<b>General data</b>	
Supply voltage range	
Current consumption	
Power dissipation	
Temperature coefficient	
Step response (10-90%)	
Maximum transmission error	
Electrical isolation	Input/output/power supply
Ambient temperature range	
Humidity	
SMART communication	
Signal bandwidth	
Protocols supported	
Housing material	
Inflammability class in acc. with UL 94	
Dimensions W / H / D	
Screw connection solid / stranded / AWG	
Push-in connection solid / stranded / AWG	
EMC note	
<b>Conformance / approvals</b>	
Conformance	
ATEX	
UL, USA / Canada	
SIL in accordance with IEC 61508	

Technical data	
0 mA ... 20 mA / 4 mA ... 20 mA	
5.4 V (at 20 mA)	
> 100 kΩ (if there is a line fault)	
0 mA ... 20 mA / 4 mA ... 20 mA	
< 800 Ω (20 mA)	
< 20 mV <sub>rms</sub>	
19.2 V DC ... 30 V DC (24 V DC (-20% ... +25%))	
< 46 mA (24 V DC / 20 mA)	
< 1.1 W (24 V DC / 20 mA)	
< 0.01 %/K	
< 140 μs (for 4 mA ... 20 mA step)	
< 0.1 % (of final value)	
1.5 kV (50 Hz, 1 min., test voltage)	
300 V <sub>rms</sub> (rated insulation voltage (surge voltage category II, pollution degree 2))	
-20 °C ... 60 °C (any mounting position)	
10 % ... 95 % (non-condensing)	
Yes	
as per HART specifications	
HART	
PA 66-FR	
V0	
12.5 / 99 / 114.5 mm	
0.2 ... 2.5 mm <sup>2</sup> / 0.2 ... 2.5 mm <sup>2</sup> / 24 - 14	
0.2 ... 1.5 mm <sup>2</sup> / 0.2 ... 1.5 mm <sup>2</sup> / 24 - 16	
Class A product, see page 625	
CE-compliant, additionally EN 61326	
Ex II 3 G Ex nA IIC T4 Gc X	
UL 508 Listed	
UL 61010 Listed	
Class I, Div. 2, Groups A, B, C, D T4	
Class I, Zone 2, Group IIC T4	
2	

Ordering data			
Description	Type	Order No.	Pcs. / Pkt.
Output signal conditioner			
	Screw connection	MACX MCR-SL-IDSI-I	2865971 1
	Push-in connection	MACX MCR-SL-IDSI-I-SP	2924223 1

Temperature, temperature transducer

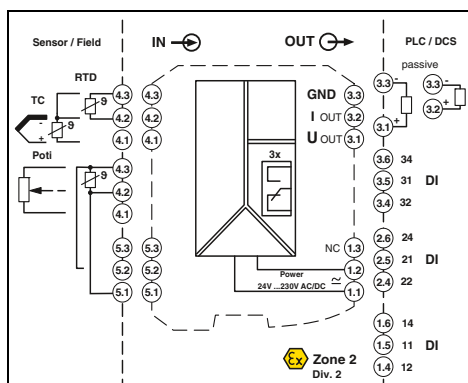
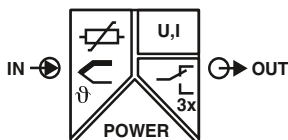

Universal, with three limit value relays, wide range power supply

Functional Safety

Ex: Ex n

Housing width 35 mm

Technical data

Input data

Resistance thermometers  
Thermocouple sensors

Resistor  
Potentiometer  
Voltage

Output data

Output signal

Maximum output signal  
Load  $R_B$   
Behavior in the event of a sensor error

Switching output

Contact type  
Contact material  
Max. switching voltage  
Max. switching current

General data

Supply voltage range  
Power consumption  
Temperature coefficient  
Transmission error, total  
Electrical isolation

Input/output/power supply

Input/output  
Input/power supply  
Input/switching output

Ambient temperature range  
Humidity  
Housing material  
Inflammability class in acc. with UL 94  
Dimensions W / H / D  
Screw connection solid / stranded / AWG  
Push-in connection solid / stranded / AWG  
EMC note

Conformance / approvals

Conformance  
ATEX  
IECEX  
UL, USA / Canada

SIL in accordance with IEC 61508

Pt, Ni, Cu sensors: 2, 3, 4-wire  
B, E, J, K, N, R, S, T, L, U, CA, DA, A1G, A2G, A3G, MG, LG

0  $\Omega$  ... 50 k $\Omega$   
0  $\Omega$  ... 50 k $\Omega$   
-1000 mV ... 1000 mV

U output  
0 mA ... 20 mA  $\pm$ 10 V  
(in the case of SIL; further free configuration without SIL)  
 $\pm$  11 V  
 $\geq$  10 k $\Omega$   
22 mA  
 $\leq$  600  $\Omega$  (at 20 mA)  
according to NE 43 or freely configurable

Relay output  
3 PDTs  
AgSnO<sub>2</sub>, hard gold-plated  
250 V AC (250 V DC)  
2 A (250 V AC) / 2 A (28 V DC)

24 V ... 230 V AC/DC (-20%/+10%, 50/60 Hz)  
< 2.4 W  
0.01 %/K

300 V<sub>rms</sub> (rated insulation voltage (surge voltage category II; pollution degree 2, safe isolation as per EN 61010-1))  
2.5 kV (50 Hz, 1 min., test voltage)

375 V (peak value in accordance with EN 60079-11)  
375 V (peak value in accordance with EN 60079-11)  
375 V (peak value in accordance with EN 60079-11)  
-20 °C ... 65 °C  
typ. 5% ... 95% (non-condensing)  
PA 66-FR  
V0  
35 / 99 / 114.5 mm  
0.2 ... 2.5 mm<sup>2</sup> / 0.2 ... 2.5 mm<sup>2</sup> / 24 - 14  
0.2 ... 1.5 mm<sup>2</sup> / 0.2 ... 1.5 mm<sup>2</sup> / 24 - 16  
Class A product, see page 625

CE-compliant  
Ex II 3 G Ex nA nC ic IIC T4 Gc X  
Ex nA nC ic IIC T4 Gc X  
UL 508 Listed  
Class I, Div. 2, Groups A, B, C, D T6  
Class I, Zone 2, Group IIC T6  
2

Universal temperature transducer with freely configurable properties

- Input for resistance thermometers, thermocouples, resistance-type sensors, potentiometers, and mV sources
- Measure differential temperatures
- Freely programmable input and output
- Option of inverse output signal ranges
- Three limit value relays, can be used in combination as a safe limit value relay
- Configuration via software (FDT-DTM) or IFS-OP-UNIT operating and display unit
- Programming during operation and also voltage-free using IFS-USB-PROG-ADAPTER programming adapter
- Plug-in screw or push-in connection technology
- Cold junction compensation with separate connector
- Wide range power supply: 19.2 ... 253 V AC/DC
- Status indicator for supply voltage, cable, sensor, and module errors
- Up to SIL 2 according to IEC 61508
- Installation in zone 2 permitted

<b>Notes:</b>
To order a product with an order configuration, enter the required configuration by referring to the adjacent order key.
The configuration software can be downloaded from the Internet (phoenixcontact.net/products).
Information on the IFS-OP-UNIT operating and display unit and the associated IFS-OP-CRADLE DIN rail cradle can be found on page 170
For information on the programming adapter, refer to page 89

Description	
<b>Temperature transducer</b>	
Standard configuration	Screw connection
Standard configuration	Push-in connection
<b>Programming adapter</b> for configuring modules with S-PORT interface	
<b>Cold junction compensation connector</b> for thermocouples	

Ordering data

Type	Order No.	Pcs. / Pkt.
MACX MCR-T-UIREL-UP	2811378	1
MACX MCR-T-UIREL-UP-SP	2811828	1

Accessories

IFS-USB-PROG-ADAPTER	2811271	1
MACX MCR-CJC	2924993	1

Temperature, temperature transducer

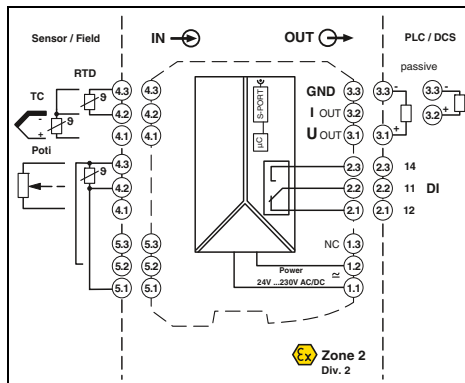
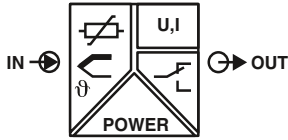

Ex n



SIL IEC 61508



Universal, with switching output, wide range power supply

Functional Safety

Ex: Ex n

Housing width 17.5 mm

Universal temperature transducer with freely configurable properties

- Input for resistance thermometers, thermocouples, resistance-type sensors, potentiometers, and mV sources
- Measure differential temperatures
- Freely programmable input and output
- Option of inverse output signal ranges
- Relay switching output
- Configuration via software (FDT-DTM) or IFS-OP-UNIT operating and display unit
- Programming during operation and also voltage-free using IFS-USB-PROG-ADAPTER programming adapter
- Plug-in screw or push-in connection technology
- Cold junction compensation with separate connector
- Wide range power supply: 19.2 ... 253 V AC/DC
- Status indicator for supply voltage, cable, sensor, and module errors
- Up to SIL 2 according to IEC 61508
- Installation in zone 2 permitted

Input data

Resistance thermometers  
Thermocouple sensors

Resistor  
Potentiometer  
Voltage

Output data  
Output signal

Maximum output signal  
Load  $R_B$   
Behavior in the event of a sensor error

Switching output

Contact type  
Contact material  
Max. switching voltage  
Max. switching current

General data

Supply voltage range  
Power consumption  
Temperature coefficient  
Transmission error, total  
Electrical isolation

Input/output/power supply

Input/output  
Input/power supply  
Input/switching output

Ambient temperature range  
Humidity  
Housing material  
Inflammability class in acc. with UL 94  
Dimensions W / H / D  
Screw connection solid / stranded / AWG  
Push-in connection solid / stranded / AWG  
EMC note

Conformance / approvals

Conformance  
ATEX  
IECEX  
SIL in accordance with IEC 61508

Technical data

Pt, Ni, Cu sensors: 2, 3, 4-wire  
B, E, J, K, N, R, S, T, L, U, CA, DA, A1G, A2G, A3G, MG, LG

0  $\Omega$  ... 50 k $\Omega$   
0  $\Omega$  ... 50 k $\Omega$   
-1000 mV ... 1000 mV

U output I output  
0 mA ... 20 mA  $\pm$ 10 V  
(in the case of SIL; further free configuration without SIL)

$\pm$  11 V 22 mA  
 $\geq$  10 k $\Omega$   $\leq$  600  $\Omega$  (20 mA)  
according to NE 43 or freely configurable

Relay output

1 PDT  
AgSnO<sub>2</sub>, hard gold-plated  
30 V AC (30 V DC)  
0.5 A (30 V AC) / 1 A (30 V DC)

24 V ... 230 V AC/DC (-20%/+10%, 50/60 Hz)  
< 1.5 W  
0.01 %/K  
< 0.1 % (e.g., for Pt 100, 300 K span, 4 ... 20 mA)

300 V<sub>rms</sub> (rated insulation voltage (surge voltage category II; pollution degree 2, safe isolation as per EN 61010-1))  
2.5 kV (50 Hz, 1 min., test voltage)

375 V (peak value in accordance with EN 60079-11)  
375 V (peak value in accordance with EN 60079-11)  
375 V (peak value in accordance with EN 60079-11)

-20 °C ... 65 °C  
typ. 5 % ... 95 % (non-condensing)  
PA 66-FR  
V0

17.5 / 99 / 114.5 mm  
0.2 ... 2.5 mm<sup>2</sup> / 0.2 ... 2.5 mm<sup>2</sup> / 24 - 14  
0.2 ... 1.5 mm<sup>2</sup> / 0.2 ... 1.5 mm<sup>2</sup> / 24 - 16  
Class A product, see page 625

CE-compliant  
Ex II 3 G Ex nA nC IIC T4 Gc X  
Ex nA nC ic IIC T4 Gc X  
2

Ordering data

Type	Order No.	Pcs. / Pkt.
MACX MCR-T-UI-UP	2811394	1
MACX MCR-T-UI-UP-SP	2811860	1
MACX MCR-T-UI-UP-C	2811873	1
MACX MCR-T-UI-UP-SP-C	2811970	1

Accessories

IFS-USB-PROG-ADAPTER	2811271	1
MACX MCR-CJC	2924993	1

**Notes:**

To order a product with an order configuration, enter the required configuration by referring to the adjacent order key.

The configuration software can be downloaded from the Internet ([phoenixcontact.net/products](http://phoenixcontact.net/products)).

Information on the IFS-OP-UNIT operating and display unit and the associated IFS-OP-CRADLE DIN rail cradle can be found on page 170

For information on the programming adapter, refer to page 89

Description	
<b>Temperature transducer</b>	
Standard configuration	Screw connection
Standard configuration	Push-in connection
Order configuration	Screw connection
Order configuration	Push-in connection

<b>Programming adapter</b> for configuring modules with S-PORT interface
<b>Cold junction compensation connector</b> for thermocouples

Signal conditioners with SIL functional safety - MACX Analog

Order key for MACX MCR-T-UI-UP(-SP)-C temperature transducer (standard configuration entered as an example)

Order No.	Safety integrity level (SIL)	Sensor type	Connection technology	Cold junction compensation	Measuring range:		Measuring unit	Output range	Factory calibration certificate = FCC												
					Start	End															
2811873	ON	PT100	4	0	-50	150	C	OUT02	NONE												
2811873 ≙ MACX MCR-T-UI-UP-C	ON ≙ active NONE ≙ not active	See below	2 ≙ 2-wire 3 ≙ 3-wire 4 ≙ 4-wire	0 ≙ off, e.g., with RTD, R, potentiometer, mV 1 ≙ on, e.g., with TC	see below	see below	C ≙ °C F ≙ °F Ω ≙ Ω P ≙ % V ≙ mV	OUT15 ≙ 0 ... 5 mA OUT16 ≙ 0 ... 10 mA OUT01 ≙ 0 ... 20 mA OUT15 ≙ 0 ... 5 mA OUT25 ≙ 1 ... 5 mA OUT26 ≙ 2 ... 10 mA OUT02 ≙ 4 ... 20 mA OUT05 ≙ 0 ... 5 V OUT03 ≙ 0 ... 10 V OUT06 ≙ 1 ... 5 V OUT04 ≙ 2 ... 10 V OUT13 ≙ -5 ... +5 V OUT14 ≙ -10 ... +10 V Others can be freely configured in the software	NONE ≙ without FCC YES ≙ with FCC (a fee is charged) YESPLUS ≙ FCC with 5 measuring points (a fee is charged)												
<b>Resistance thermometers (RTD)</b> Others can be selected or freely configured in the software.								<table border="1"> <tr> <th>Smallest measuring range span</th> <th>Other setting options can be configured with the IFS-CONF software:</th> </tr> <tr> <td>20 K</td> <td>- Freely configurable user characteristic curve with 30 interpolation points</td> </tr> <tr> <td>20 K</td> <td>- Output behavior in the event of a short circuit, sensor break or overrange/underrange can be freely configured or set acc. to NE43 (standard configuration: NE43 upscale)</td> </tr> <tr> <td>20 K</td> <td>- Filter setting (standard configuration: 1)</td> </tr> <tr> <td>20 K</td> <td>- Restart after failsafe (standard configuration: ON)</td> </tr> <tr> <td>20 K</td> <td>- Switching behavior: switching output (limit values, times, etc.) (standard configuration: OFF)</td> </tr> </table>	Smallest measuring range span	Other setting options can be configured with the IFS-CONF software:	20 K	- Freely configurable user characteristic curve with 30 interpolation points	20 K	- Output behavior in the event of a short circuit, sensor break or overrange/underrange can be freely configured or set acc. to NE43 (standard configuration: NE43 upscale)	20 K	- Filter setting (standard configuration: 1)	20 K	- Restart after failsafe (standard configuration: ON)	20 K	- Switching behavior: switching output (limit values, times, etc.) (standard configuration: OFF)	
Smallest measuring range span	Other setting options can be configured with the IFS-CONF software:																				
20 K	- Freely configurable user characteristic curve with 30 interpolation points																				
20 K	- Output behavior in the event of a short circuit, sensor break or overrange/underrange can be freely configured or set acc. to NE43 (standard configuration: NE43 upscale)																				
20 K	- Filter setting (standard configuration: 1)																				
20 K	- Restart after failsafe (standard configuration: ON)																				
20 K	- Switching behavior: switching output (limit values, times, etc.) (standard configuration: OFF)																				
		PT100 ≙ Pt 100 acc. to IEC 751			-200	850	°C	20 K													
		PT200 ≙ Pt 200 acc. to IEC 751			-200	850	°C	20 K													
		PT500 ≙ Pt 500 acc. to IEC 751			-200	850	°C	20 K													
		PT1000 ≙ Pt 1000 acc. to IEC 751			-200	850	°C	20 K													
		PT100S ≙ Pt 100 acc. to Sama RC21-4-1966			-200	850	°C	20 K													
		PT1000S ≙ Pt 1000 acc. to Sama RC21-4-1966			-200	850	°C	20 K													
		PT100G ≙ Pt 100 acc. to GOST 6651-2009 (α = 0.00385)			-200	850	°C	20 K													
		PT1000G ≙ Pt 1000 acc. to GOST 6651-2009 (α = 0.00385)			-200	850	°C	20 K													
		PT100J ≙ Pt 100 acc. to JIS C1604/1997			-200	850	°C	20 K													
		PT1000J ≙ Pt 1000 acc. to JIS C1604/1997			-200	850	°C	20 K													
		NI100 ≙ Ni 100 acc. to DIN 43760/DIN IEC 60751			-60	250	°C	20 K													
		NI1000 ≙ Ni 1000 acc. to DIN 43760/DIN IEC 60751			-60	250	°C	20 K													
		NI100S ≙ Ni 100 acc. to Sama RC21-4-1966			-60	180	°C	20 K													
		NI1000S ≙ Ni 1000 acc. to Sama RC21-4-1966			-60	180	°C	20 K													
		NI1000L ≙ Ni 1000 (Landis & Gyr)			-50	160	°C	20 K													
		CU10 ≙ Cu 10 acc. to Sama RC21-4-1966			-70	500	°C	100 K													
		CU50 ≙ Cu50 acc. to GOST 6651-2009 (α = 0.00428)			-50	200	°C	100 K													
		CU100 ≙ Cu100 acc. to GOST 6651-2009 (α = 0.00428)			-50	200	°C	100 K													
		CU53 ≙ Cu53 acc. to GOST 6651-2009 (α = 0.00426)			-50	180	°C	100 K													
		KTY81 ≙ KTY81-110 (Philips)			-55	150	°C	20 K													
		KTY84 ≙ KTY84-130 (Philips)			-40	300	°C	20 K													
<b>Thermocouples (TC)</b> Others can be selected in the software.																					
		B ≙ acc. to IEC 584-1 (Pt30Rh-Pt6Rh)			500	1820	°C	50 K													
		E ≙ acc. to IEC 584-1 (NiCr-CuNi)			-230	1000	°C	50 K													
		J ≙ acc. to IEC 584-1 (Fe-CuNi)			-210	1200	°C	50 K													
		K ≙ acc. to IEC 584-1 (NiCr-Ni)			-250	1372	°C	50 K													
		N ≙ acc. to IEC 584-1 (NiCrSi-NiSi)			-250	1300	°C	50 K													
		R ≙ acc. to IEC 584-1 (Pt13Rh-Pt)			-50	1768	°C	50 K													
		S ≙ acc. to IEC 584-1 (Pt10Rh-Pt)			-50	1768	°C	50 K													
		T ≙ acc. to IEC 584-1 (Cu-CuNi)			-200	400	°C	50 K													
		L ≙ acc. to DIN 43760 (Fe-CuNi)			-200	900	°C	50 K													
		U ≙ acc. to DIN 43760 (Cu-CuNi)			-200	600	°C	50 K													
		CA ≙ C ASTM JE988 (2002)			0	2315	°C	50 K													
		DA ≙ D ASTM JE988 (2002)			0	2315	°C	50 K													
		A1G ≙ A-1 GOST 8.585-2001			0	2500	°C	50 K													
		A2G ≙ A-2 GOST 8.585-2001			0	1800	°C	50 K													
		A3G ≙ A-3 GOST 8.585-2001			0	1800	°C	50 K													
		MG ≙ M GOST 8.585-2001			-200	100	°C	50 K													
		LG ≙ L GOST 8.585-2001			-200	800	°C	50 K													
<b>Remote resistance-type sensors (R)</b> (2, 3, 4-wire) Others can be selected in the software.																					
		RES03 ≙ 0 ... 150 Ω resistor			0	150	Ω	10% of the selected measuring range													
		RES05 ≙ 0 ... 600 Ω resistor			0	600	Ω														
		RES06 ≙ 0 ... 1200 Ω resistor			0	1200	Ω														
		RES09 ≙ 0 ... 6250 Ω resistor			0	6250	Ω														
		RES10 ≙ 0 ... 12500 Ω resistor			0	12500	Ω														
		RES12 ≙ 0 ... 50000 Ω resistor			0	50000	Ω														
<b>Potentiometers</b> (3-wire) Others can be selected in the software.																					
		POT03 ≙ 0 ... 150 Ω potentiometer			0	100	%	10% of the selected measuring range													
		POT05 ≙ 0 ... 600 Ω potentiometer			0	100	%														
		POT06 ≙ 0 ... 1200 Ω potentiometer			0	100	%														
		POT09 ≙ 0 ... 6250 Ω potentiometer			0	100	%														
		POT10 ≙ 0 ... 12500 Ω potentiometer			0	100	%														
		POT12 ≙ 0 ... 50000 Ω potentiometer			0	100	%														
<b>Voltage signals (mV)</b> Others can be selected in the software.																					
		V04 ≙ Voltage (mV)			-1000	+1000	mV	10% of nominal span													

Temperature conversion guide for °C to °F:

$$T [°F] = \frac{9}{5} T [°C] + 32$$



Temperature, temperature transducer

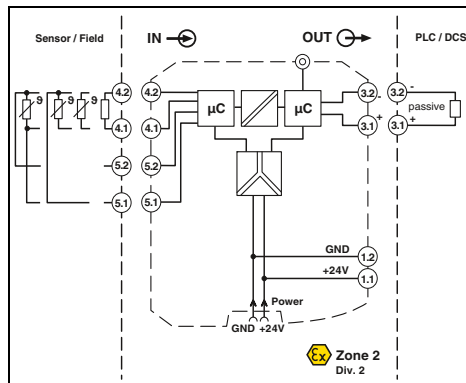
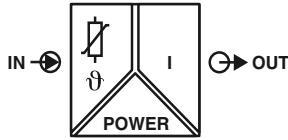

Ex n



For resistance thermometers and resistance-type sensors



Housing width 12.5 mm

Technical data

Programmable temperature transducer for operating resistance thermometers and resistance-type sensors. The measured values are converted into a linear 0 ... 20 mA or 4 ... 20 mA signal.

- Input for resistance thermometers and resistance-type sensors
- 0 ... 20 mA or 4 ... 20 mA output
- Configuration via software (FDT/DTM): Sensor type, connection method, measuring range, measuring unit, filter, alarm signal, and output range
- Programming during operation and also voltage-free using IFS-USB-PROG-ADAPTER programming adapter
- Status indicator for supply voltage, cable, sensor, and module errors
- 3-way electrical isolation
- Power supply via DIN rail connector possible
- Up to SIL 2 according to IEC 61508
- Installation in zone 2 permitted

<b>Input data</b>	Resistance thermometers Resistor Cable resistance Sensor input current Measuring range span
<b>Output data</b>	Output signal Load Behavior in the event of a sensor error Output ripple
<b>General data</b>	Supply voltage range Current consumption Power dissipation Temperature coefficient Step response (0-99%)
	Transmission error, total ZERO / SPAN adjustment Electrical isolation
	Input/output/power supply
	Input/output Input/power supply
	Ambient temperature range Humidity Housing material Inflammability class in acc. with UL 94 Dimensions W / H / D Screw connection solid / stranded / AWG Push-in connection solid / stranded / AWG EMC note
<b>Conformance / approvals</b>	Conformance ATEX UL, USA / Canada
	SIL in accordance with IEC 61508

Pt, Ni, Cu sensors: 2, 3, 4-wire 0 Ω ... 2000 Ω 50 Ω per line 200 µA ... 1 mA > 50 K
0 mA ... 20 mA / 4 mA ... 20 mA ≤ 500 Ω As per NE 43 or can be freely defined < 50 µA <sub>PP</sub>
19.2 V DC ... 30 V DC (24 V DC (-20% ... +25%)) < 40 mA (24 V DC) < 1 W 0.01 %/K typ. 800 ms (with SIL) max. 1200 ms (with SIL) typ. 700 ms (without SIL) max. 1100 ms (without SIL) 0.05 % x 100 [K] / measuring range span [K] + 0.05 % ± 5 % / ± 5 %
2.5 kV (50 Hz, 1 min., test voltage) 300 V <sub>rms</sub> (rated insulation voltage (surge voltage category II; pollution degree 2, safe isolation as per EN 61010-1))
375 V (peak value in accordance with EN 60079-11) 375 V (peak value in accordance with EN 60079-11) -20 °C ... 60 °C (any mounting position) 5 % ... 95 % (non-condensing) PA 66-FR V0 12.5 / 99 / 114.5 mm 0.2 ... 2.5 mm <sup>2</sup> / 0.2 ... 2.5 mm <sup>2</sup> / 24 - 14 0.2 ... 1.5 mm <sup>2</sup> / 0.2 ... 1.5 mm <sup>2</sup> / 24 - 16 Class A product, see page 625
CE-compliant, additionally EN 61326 Ex II 3G Ex nA ic IIC T4 Gc X UL 508 Listed UL 61010 Listed Class I, Div. 2, Groups A, B, C, D T4 Class I, Zone 2, Group IIC T4 2

<b>Notes:</b>
To order a product with an order configuration, enter the required configuration by referring to the adjacent order key.
The configuration software can be downloaded from the Internet (phoenixcontact.net/products).
Information about the power and fault signaling module as well as about the DIN rail connectors and marking material can be found from page 178
For information on the programming adapter, refer to page 89
Test plugs for test sockets can be found on page 180
Information on Plug and Play connection using system cabling can be found from page 182

<b>Description</b>	
<b>Temperature transducer</b>	
Order configuration	Screw connection
Order configuration	Push-in connection
Standard configuration	Screw connection
Standard configuration	Push-in connection

Ordering data		
Type	Order No.	Pcs. / Pkt.
MACX MCR-SL-RTD-I	2865065	1
MACX MCR-SL-RTD-I-SP	2924317	1
MACX MCR-SL-RTD-I-NC	2865078	1
MACX MCR-SL-RTD-I-SP-NC	2924320	1

<b>Programming adapter</b> for configuring modules with S-PORT interface	
--	--

Accessories		
IFS-USB-PROG-ADAPTER	2811271	1

**Order key and temperature ranges for the MACX MCR-SL-RTD-I(-SP) temperature transducer**

Order key for MACX MCR-SL-RTD-I(-SP) temperature transducer (standard configuration entered as an example)

Order No.	Sensor type	Safety integrity level (SIL)	Connection technology	Measuring range:		Measuring unit	Output range	Filter Oversampling	Filter Moving mean value
				Start	End				
<b>2865065</b>	<b>Pt100</b>	<b>ON</b>	<b>3</b>	<b>0</b>	<b>100</b>	<b>C</b>	<b>OUT02</b>	<b>10</b>	<b>1</b>
2865065 ≙ MACX MCR-SL-RTD-I	See below	ON ≙ Active NONE ≙ not active	2 ≙ 2-wire 3 ≙ 3-wire 4 ≙ 4-wire	see below	see below	C ≙ °C F ≙ °F O ≙ Ω	OUT01 ≙ 0 ... 20 mA OUT02 ≙ 4...20 mA	1 ≙ 1 value 3 ≙ 3 values 5 ≙ 5 values 7 ≙ 7 values 10 ≙ 10 values 20 ≙ 20 values	1 ≙ 1 value 2 ≙ 2 values 3 ≙ 3 values 4 ≙ 4 values
2924317 ≙ MACX MCR-SL-RTD-I-SP		ON only with output range = OUT02							
							<b>Smallest measuring range span</b>		
	RES01	≙ Resistor		0	2000	Ω	25 Ω		
	PT50	≙ Pt 50 acc. to IEC 751		-200	850	°C	50 K		
	PT100	≙ Pt 100 acc. to IEC 751		-200	850	°C	50 K		
	Pt200	≙ Pt 200 acc. to IEC 751		-200	850	°C	50 K		
	Pt500	≙ Pt 500 acc. to IEC 751		-200	850	°C	50 K		
	PT100S	≙ Pt 100 acc. to Sama RC21-4-1966		-200	600	°C	50 K		
	PT500S	≙ Pt 500 acc. to Sama RC21-4-1966		-200	600	°C	50 K		
	NI100DIN	≙ Ni 100 acc. to DIN 43760		-60	250	°C	50 K		
	NI500DIN	≙ Ni 500 acc. to DIN 43760		-60	250	°C	50 K		
	CU50	≙ Cu 50 acc. to GOST 6651-2009 (α = 0.00428)		-50	200	°C	50 K		
	CU53	≙ Cu 53 acc. to GOST 6651-2009 (α = 0.00426)		-50	180	°C	50 K		

**Alarm signal**  
Short circuit/  
Overrange

**Alarm signal**  
Sensor break/  
Underrange

**Factory calibration certificate = FCC**

<b>I035</b>	<b>I215</b>	<b>NONE</b>	<b>Temperature conversion guide for °C to °F:</b> $T [°F] = \frac{9}{5} T [°C] + 32$
I000 ≙ 0 mA I035 ≙ 3.5 mA I215 ≙ 21.5 mA  I035 only with output range = OUT02  Alarm signals can also be configured individually using software.	I000 ≙ 0 mA I035 ≙ 3.5 mA I215 ≙ 21.5 mA	NONE ≙ without FCC YES ≙ with FCC (a fee is charged) YESPLUS ≙ FCC with 5 measuring points (a fee is charged)	

Temperature, temperature transducer

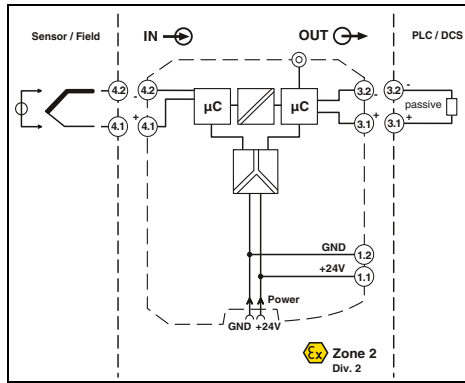
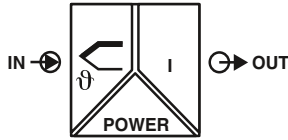

Ex n



For thermocouples and mV sources



Housing width 12.5 mm

Programmable temperature transducer for operating thermocouples and mV sources. The measured values are converted into a linear 0 ... 20 or 4 ... 20 mA signal.

- Input for thermocouples and mV sources
- 0 ... 20 mA or 4 ... 20 mA output
- Configuration via software (FDT/DTM): Sensor type, connection method, measuring range, measuring unit, filter, alarm signal, and output range
- Programming during operation and also voltage-free using IFS-USB-PROG-ADAPTER programming adapter
- Status indicator for supply voltage, cable, sensor, and module errors
- 3-way electrical isolation
- Power supply via DIN rail connector possible
- Up to SIL 2 according to IEC 61508
- Installation in zone 2 permitted

<b>Input data</b>	Thermocouple sensors
<b>Voltage</b>	
<b>Measuring range span</b>	
<b>Output data</b>	Output signal
	Load
	Behavior in the event of a sensor error
	Output ripple
<b>General data</b>	Supply voltage range
	Current consumption
	Power dissipation
	Temperature coefficient
	Step response (0-99%)
	Transmission error, total
	Cold junction errors
	ZERO / SPAN adjustment
	Electrical isolation
	Ambient temperature range
	Humidity
	Housing material
	Inflammability class in acc. with UL 94
	Dimensions W / H / D
	Screw connection solid / stranded / AWG
	EMC note
<b>Conformance / approvals</b>	Conformance
	ATEX
	UL, USA / Canada
	SIL in accordance with IEC 61508

**Technical data**

E, J, K, N as per IEC / EN 60584, L as per DIN 43760

-20 mV ... 70 mV  
Min. 50 K for thermocouples, 3 mV for mV sources

0 mA ... 20 mA / 4 mA ... 20 mA  
max. 500 Ω  
As per NE 43 or can be freely defined  
< 50 µA<sub>pp</sub>

19.2 V DC ... 30 V DC (24 V DC (-20% ... +25%))  
< 40 mA (24 V DC)  
< 1 W  
0.01 %/K  
typ. 800 ms (with SIL)  
max. 1200 ms (with SIL)  
typ. 700 ms (without SIL)  
max. 1100 ms (without SIL)  
0.05% x 200 [K]/Measuring range span [K] + 0.05%  
± 1 K  
± 5 % / ± 5 %

**Input/output/power supply**  
300 V<sub>rms</sub> (rated insulation voltage (surge voltage category II; pollution degree 2, safe isolation as per EN 61010-1))  
2.5 kV (50 Hz, 1 min., test voltage)

**Input/output**  
375 V (peak value in accordance with EN 60079-11)  
**Input/power supply**  
375 V (peak value in accordance with EN 60079-11)

-20 °C ... 60 °C (any mounting position)  
5 % ... 95 % (non-condensing)  
PA 66-FR  
V0  
12.5 / 99 / 114.5 mm  
0.2 ... 2.5 mm<sup>2</sup> / 0.2 ... 2.5 mm<sup>2</sup> / 24 - 14  
Class A product, see page 625

CE-compliant, additionally EN 61326  
Ex II 3G Ex nA ic IIC T4 Gc X  
UL 508 Listed  
UL 61010 Listed  
Class I, Div. 2, Groups A, B, C, D T4  
Class I, Zone 2, Group IIC T4  
2

<b>Notes:</b>
To order a product with an order configuration, enter the required configuration by referring to the adjacent order key.
The configuration software can be downloaded from the Internet (phoenixcontact.net/products).
Information about the power and fault signaling module as well as about the DIN rail connectors and marking material can be found from page 178
For information on the programming adapter, refer to page 89
Information on Plug and Play connection using system cabling can be found from page 182

**Ordering data**

<b>Description</b>	
<b>Temperature transducer</b>	
Order configuration	Screw connection
Standard configuration	Screw connection

Type	Order No.	Pcs. / Pkt.
MACX MCR-SL-TC-I	2924333	1
MACX MCR-SL-TC-I-NC	2924346	1

**Accessories**

<b>Programming adapter</b> for configuring modules with S-PORT interface
--

IFS-USB-PROG-ADAPTER	2811271	1
----------------------	---------	---

**Order key and temperature ranges for the MACX MCR-SL-TC-I temperature transducer**

Order key for MACX MCR-SL-TC-I temperature transducer (standard configuration entered as an example)

Order No.	Sensor type	Safety integrity level (SIL)	Cold junction compensation	Measuring range:		Measuring unit	Output range	Filter Oversampling	Filter Moving mean value
				Start	End				
2924333	J	ON	1	0	1000	C	OUT02	10	1
MACX MCR-SL-TC-I	see below	ON ≙ active NONE ≙ not active  ON only with output range = OUT02	1 ≙ switched on 0 ≙ switched off (e.g., for mV voltage measurement)	see below	see below	C ≙ °C F ≙ °F V ≙ mV	OUT01 ≙ 0 ... 20 mA OUT02 ≙ 4 ... 20 mA	1 ≙ 1 value 3 ≙ 3 values 5 ≙ 5 values 7 ≙ 7 values 10 ≙ 10 values 20 ≙ 20 values	1 ≙ 1 value 2 ≙ 2 values 3 ≙ 3 values 4 ≙ 4 values
							<b>Smallest measuring range span</b>		
V03 ≙ Voltage (mV)				-20	+70	mV	3 mV		
E ≙ acc. to IEC 584-1 (NiCr-CuNi)				-250	1000	°C	50 K		
J ≙ acc. to IEC 584-1 (Fe-CuNi)				-210	1200	°C	50 K		
K ≙ acc. to IEC 584-1 (NiCr-Ni)				-250	1372	°C	50 K		
N ≙ acc. to IEC 584-1 (NiCrSi-NiSi)				-250	1300	°C	50 K		
L ≙ acc. to DIN 43760 (Fe-CuNi)				-200	900	°C	50 K		

**Alarm signal**  
Overrange

**Alarm signal**  
Sensor break/  
Underrange

Factory calibration certificate = FCC

I035	I215	NONE
I000 ≙ 0 mA I035 ≙ 3.5 mA I215 ≙ 21.5 mA	I000 ≙ 0 mA I035 ≙ 3.5 mA I215 ≙ 21.5 mA	NONE ≙ without FCC YES ≙ with FCC (a fee is charged) YESPLUS ≙ FCC with 5 measuring points (a fee is charged)
I035 only with output range = OUT02		
Alarm signals can also be configured individually using software.		

Temperature conversion guide for °C to °F:

$$T [°F] = \frac{9}{5} T [°C] + 32$$

**Accessories,  
operating and display unit**

- Local display of actual values
- Copy function
- Easy guided operation
- Easy configuration without PC software
- Operating and display unit can be snapped directly onto compatible devices with a housing width of 35 mm
- DIN rail mounting possible for thinner devices in conjunction with cradle unit
- Backlighting
- Installation in zone 2 permitted



Can be snapped directly onto compatible 35 mm devices

General data	
Ambient temperature range	-20 °C ... 65 °C (-4°F ... 149°F)
Humidity	90 % (at 25 °C, non-condensing)
Housing material	PA 6.6
Dimensions W / H / D	35 / 99 / 20 mm
Connection method	PC side Measuring transducer side
EMC note	
Conformance / approvals	
Conformance	CE-compliant
ATEX	Ex II 3G Ex nA ic IIC T4 Gc X
IECEX	Ex nA ic IIC T4 X

**Technical data**

Ambient temperature range	-20 °C ... 65 °C (-4°F ... 149°F)
Humidity	90 % (at 25 °C, non-condensing)
Housing material	PA 6.6
Dimensions W / H / D	35 / 99 / 20 mm
Connection method	PC side Measuring transducer side
EMC note	
Conformance / approvals	
Conformance	CE-compliant
ATEX	Ex II 3G Ex nA ic IIC T4 Gc X
IECEX	Ex nA ic IIC T4 X

Description	
<b>Operating and display unit</b>	

**Ordering data**

Type	Order No.	Pcs. / Pkt.
IFS-OP-UNIT	2811899	1

**Accessories,  
cradle unit**

- For snapping onto the DIN rail
- For control cabinet mounting of the operating and display unit



Cradle for operating and display unit

General data	
Ambient temperature range	-20 °C ... 65 °C (-4°F ... 149°F)
Humidity	90 % (at 25 °C, non-condensing)
Housing material	PA 6.6
Dimensions W / H / D	35.2 / 29 / 99 mm
Connection method	IFS-OP-UNIT operator interface Measuring transducer side
EMC note	
Conformance / approvals	
Conformance	CE-compliant
ATEX	Ex II 3G Ex nA ic IIC T4 Gc X
IECEX	Ex nA ic IIC T4 X

**Technical data**

Ambient temperature range	-20 °C ... 65 °C (-4°F ... 149°F)
Humidity	90 % (at 25 °C, non-condensing)
Housing material	PA 6.6
Dimensions W / H / D	35.2 / 29 / 99 mm
Connection method	IFS-OP-UNIT operator interface Measuring transducer side
EMC note	
Conformance / approvals	
Conformance	CE-compliant
ATEX	Ex II 3G Ex nA ic IIC T4 Gc X
IECEX	Ex nA ic IIC T4 X

Description	
<b>Cradle unit</b> , for snapping the operating and display unit onto the DIN rail	

**Ordering data**

Type	Order No.	Pcs. / Pkt.
IFS-OP-CRADLE	2811886	1

**Accessories**

**Programming adapter**

The IFS-USB-PROG-ADAPTER programming adapter is used for configuring Phoenix Contact INTERFACE modules with S-Port interface.

The adapter is used with FDT/DTM software or ANALOG-CONF software. For programming MACX Analog, MINI Analog Pro, and MINI Analog.



Ex: 

Description
<b>Programming adapter</b> for configuring modules with S-PORT interface

Ordering data		
Type	Order No.	Pcs. / Pkt.
IFS-USB-PROG-ADAPTER	2811271	1



Digital IN  
NAMUR signal conditioner

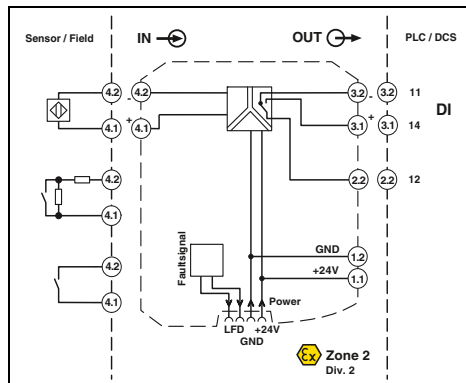
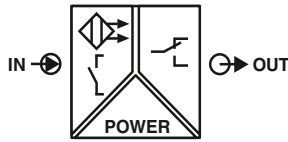

Ex n



Signal output: PDT relay

Functional Safety

Ex: Ex n

Housing width 12.5 mm

Technical data

NAMUR signal conditioner for operating proximity sensors and mechanical contacts

- Input for NAMUR proximity sensors (EN 60947-5-6), floating contacts or contacts with resistance circuit
- Relay signal output (PDT)
- Reversible direction of action (operating current or closed-circuit current behavior)
- Line fault detection (LFD), can be activated/deactivated, error message signaled by red flashing LED with de-activation of output relay
- Power supply and error indication possible via the DIN rail connector
- LED displays for indicating supply voltage, circuit state, and malfunctions to NAMUR NE 44
- 3-way electrical isolation
- Up to SIL 2 according to IEC 61508
- Installation in zone 2 permitted

Input data

Input signal

No-load voltage  
Switching points  
Switching hysteresis  
Line fault detection

Switching output

Contact type  
Contact material  
Max. switching voltage  
Max. switching capacity  
Recommended minimum load  
Mechanical service life  
Switching behavior  
Max. switching frequency

General data

Supply voltage range  
Current consumption  
Power dissipation  
Electrical isolation

Input/output

Input/output/supply, DIN rail connector

Output/input, supply, TBUS

Input/supply, DIN rail connector

NAMUR proximity sensors (EN 60947-5-6)

Floating switch contacts

Switch contacts with resistance circuit

~ 8 V DC

> 2.1 mA (conductive) / < 1.2 mA (blocking)

< 0.2 mA

Break 0.05 mA < I<sub>IN</sub> < 0.35 mA

Short circuit 100 Ω < R<sub>Sensor</sub> < 360 Ω

Relay output

1 PDT

AgSnO<sub>2</sub>, hard gold-plated

250 V AC (2 A) / 120 V DC (0.2 A) / 30 V DC (2 A)

500 VA

5 V / 10 mA

10<sup>7</sup> cycles

Can be inverted via slide switch

20 Hz (without load)

19.2 V DC ... 30 V DC

21 mA (24 V DC)

< 650 mW

375 V (peak value in accordance with EN 60079-11)

300 V<sub>rms</sub> (rated insulation voltage (surge voltage category II; pollution degree 2, safe isolation as per EN 61010-1))

2.5 kV (50 Hz, 1 min., test voltage)

300 V<sub>rms</sub> (rated insulation voltage (surge voltage category III; pollution degree 2, safe isolation as per EN 61010-1))

2.5 kV (50 Hz, 1 min., test voltage)

375 V (peak value in accordance with EN 60079-11)

-20 °C ... 60 °C (any mounting position)

10 % ... 95 % (non-condensing)

PA 66-FR

V0

12.5 / 99 / 114.5 mm

0.2 ... 2.5 mm<sup>2</sup> / 0.2 ... 2.5 mm<sup>2</sup> / 24 - 14

0.2 ... 1.5 mm<sup>2</sup> / 0.2 ... 1.5 mm<sup>2</sup> / 24 - 16

Class A product, see page 625

CE-compliant, additionally EN 61326

Ex II 3 G Ex nA nC IIC T4 Gc X

UL 508 Listed

UL 61010 Listed

Class I, Div. 2, Groups A, B, C, D T4

Class I, Zone 2, Group IIC T4

2

SIL in accordance with IEC 61508

**Notes:**

Information about the power and fault signaling module as well as about the DIN rail connectors and marking material can be found from page 178

Information about resistance circuits is given on page 180

Information on Plug and Play connection using system cabling can be found from page 182

Ordering data

Description	Type	Order No.	Pcs. / Pkt.	
NAMUR signal conditioner	Screw connection	MACX MCR-SL-NAM-R	2865997	1
	Push-in connection	MACX MCR-SL-NAM-R-SP	2924252	1

Digital IN  
NAMUR signal conditioner

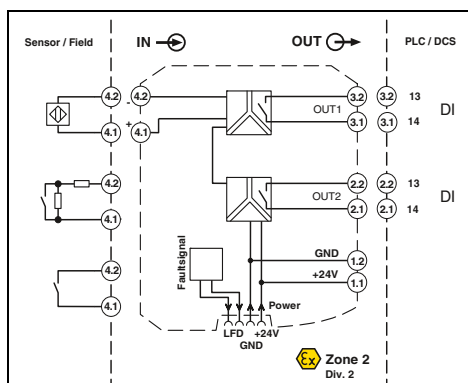
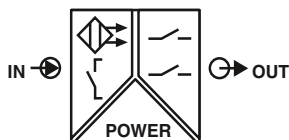

2 signal outputs: N/O contact relay

Functional Safety

EX: Ex n

Housing width 12.5 mm

NAMUR signal conditioner for operating proximity sensors and mechanical contacts

- Input for NAMUR proximity sensors (EN 60947-5-6), floating contacts or contacts with resistance circuit
- Two relay signal outputs (N/O contact); output 2 can be used as an error message output
- Reversible direction of action (operating current or closed-circuit current behavior)
- Line fault detection (LFD), can be activated/deactivated, error message signaled by red flashing LED with de-excitation of output relay
- Power supply and error indication possible via the DIN rail connector
- LED displays for indicating supply voltage, circuit state, and malfunctions to NAMUR NE 44
- 4-way electrical isolation
- Up to SIL 2 according to IEC 61508
- Installation in zone 2 permitted

Input data

Input signal

- No-load voltage
- Switching points
- Switching hysteresis
- Line fault detection

Switching output

- Contact type
- Contact material
- Max. switching voltage
- Max. switching capacity
- Recommended minimum load
- Mechanical service life
- Switching behavior
- Max. switching frequency

General data

- Supply voltage range
- Current consumption
- Power dissipation
- Electrical isolation

Input/output/supply, DIN rail connector

Output 1/output 2/input, power supply, DIN rail connector

- Ambient temperature range
- Humidity
- Housing material
- Inflammability class in acc. with UL 94
- Dimensions W / H / D
- Screw connection solid / stranded / AWG
- Push-in connection solid / stranded / AWG
- EMC note

Conformance / approvals

- Conformance
- ATEX
- UL, USA / Canada

SIL in accordance with IEC 61508

Technical data

NAMUR proximity sensors (EN 60947-5-6)  
 Floating switch contacts  
 Switch contacts with resistance circuit  
 ~ 8 V DC  
 > 2.1 mA (conductive) / < 1.2 mA (blocking)  
 < 0.2 mA  
 Break 0.05 mA < I<sub>IN</sub> < 0.35 mA  
 Short circuit 100 Ω < R<sub>Sensor</sub> < 360 Ω  
 Relay output  
 2 N/O contacts  
 AgSnO<sub>2</sub>, hard gold-plated  
 250 V AC (2 A) / 120 V DC (0.2 A) / 30 V DC (2 A)  
 500 VA  
 5 V / 10 mA  
 10<sup>7</sup> cycles  
 Can be inverted via slide switch  
 20 Hz (without load)

19.2 V DC ... 30 V DC  
 30 mA (24 V DC)  
 < 950 mW

300 V<sub>rms</sub> (rated insulation voltage (surge voltage category II);  
 pollution degree 2, safe isolation as per EN 61010-1)  
 2.5 kV (50 Hz, 1 min., test voltage)

300 V<sub>rms</sub> (rated insulation voltage (surge voltage category III);  
 pollution degree 2, safe isolation as per EN 61010-1)  
 2.5 kV (50 Hz, 1 min., test voltage)

-20 °C ... 60 °C (any mounting position)

10 % ... 95 % (non-condensing)

PA 66-FR

V0

12.5 / 99 / 114.5 mm

0.2 ... 2.5 mm<sup>2</sup> / 0.2 ... 2.5 mm<sup>2</sup> / 24 - 14

0.2 ... 1.5 mm<sup>2</sup> / 0.2 ... 1.5 mm<sup>2</sup> / 24 - 16

Class A product, see page 625

CE-compliant, additionally EN 61326

Ex II 3 G Ex nA nC IIC T4 Gc X

UL 508 Listed

UL 61010 Listed

Class I, Div. 2, Groups A, B, C, D T4

Class I, Zone 2, Group IIC T4

2

Ordering data

Description

NAMUR signal conditioner

- Screw connection
- Push-in connection

Type

MACX MCR-SL-NAM-2RO  
 MACX MCR-SL-NAM-2RO-SP

Order No.

2865010  
 2924265

Pcs. / Pkt.

1  
 1

Digital IN  
NAMUR signal conditioner

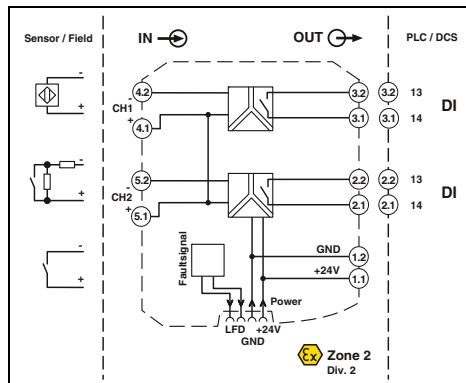
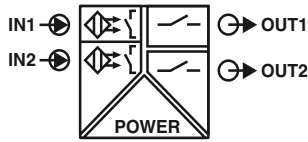

Ex n



SIL IEC 61508



2-channel, signal output: N/O contact relay

Functional Safety

Ex: Ex n Ex

Housing width 12.5 mm

Technical data

NAMUR signal conditioner for intrinsically safe operation of proximity sensors and mechanical contacts installed in Ex areas.

- 2-channel
- Input for NAMUR proximity sensors (EN 60947-5-6), floating contacts or contacts with resistance circuit
- Relay signal output (N/O contact)
- Reversible direction of action (operating current or closed-circuit current behavior)
- Line fault detection (LFD), can be activated/deactivated, error message signaled by red flashing LED with de-excitation of output relay
- Power supply and error indication possible via the DIN rail connector
- LED displays for indicating supply voltage, circuit state, and malfunctions to NAMUR NE 44
- 3-way electrical isolation
- Up to SIL 2 according to IEC 61508
- Installation in zone 2 permitted

Input data

Input signal

No-load voltage  
Switching points  
Switching hysteresis  
Line fault detection

Switching output

Contact type  
Contact material  
Max. switching voltage  
Max. switching capacity  
Recommended minimum load  
Mechanical service life  
Switching behavior  
Max. switching frequency

General data

Supply voltage range  
Current consumption  
Power dissipation  
Electrical isolation

Input/supply, DIN rail connector

Output 1/output 2/input, power supply, DIN rail connector

Ambient temperature range  
Humidity  
Housing material  
Inflammability class in acc. with UL 94  
Dimensions W / H / D  
Screw connection solid / stranded / AWG  
Push-in connection solid / stranded / AWG  
EMC note

Conformance / approvals

Conformance  
ATEX  
UL, USA / Canada

SIL in accordance with IEC 61508

NAMUR proximity sensors (EN 60947-5-6)

Floating switch contacts  
Switch contacts with resistance circuit  
~ 8 V DC  
> 2.1 mA (conductive) / < 1.2 mA (blocking)  
< 0.2 mA

Break 0.05 mA < I<sub>IN</sub> < 0.35 mA  
Short circuit 100 Ω < R<sub>Sensor</sub> < 360 Ω

Relay output

1 N/O contact per channel  
AgSnO<sub>2</sub>, hard gold-plated  
250 V AC (2 A) / 120 V DC (0.2 A) / 30 V DC (2 A)  
500 VA  
5 V / 10 mA  
10<sup>7</sup> cycles  
Can be inverted via slide switch  
20 Hz (without load)

19.2 V DC ... 30 V DC

35 mA (24 V DC)  
< 1 W

300 V<sub>rms</sub> (rated insulation voltage (surge voltage category II; pollution degree 2, safe isolation as per EN 61010-1))  
2.5 kV (50 Hz, 1 min., test voltage)

300 V<sub>rms</sub> (rated insulation voltage (surge voltage category III; pollution degree 2, safe isolation as per EN 61010-1))  
2.5 kV (50 Hz, 1 min., test voltage)

-20 °C ... 60 °C (any mounting position)

5 % ... 95 % (non-condensing)

PA 66-FR

V0

12.5 / 99 / 114.5 mm

0.2 ... 2.5 mm<sup>2</sup> / 0.2 ... 2.5 mm<sup>2</sup> / 24 - 14

0.2 ... 1.5 mm<sup>2</sup> / 0.2 ... 1.5 mm<sup>2</sup> / 24 - 16

Class A product, see page 625

CE-compliant, additionally EN 61326

Ex II 3 G Ex nA nC IIC T4 Gc X

UL 508 Listed

UL 61010 Listed

Class I, Div. 2, Groups A, B, C, D T4

Class I, Zone 2, Group IIC T4

2

Ordering data

Description

NAMUR signal conditioner

Screw connection

Push-in connection

Type

MACX MCR-SL-2NAM-RO

MACX MCR-SL-2NAM-RO-SP

Order No.

2865049

2924294

Pcs. / Pkt.

1

1

Digital IN  
NAMUR signal conditioner

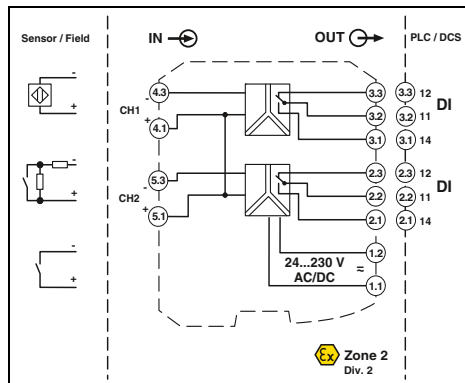
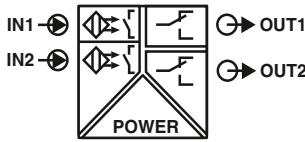

2-channel, signal output: PDT relay, wide range power supply

Functional Safety

EX:

Housing width 17.5 mm

Technical data

Input data

Input signal

- No-load voltage
- Switching points
- Switching hysteresis
- Line fault detection

Switching output

- Contact type
- Contact material
- Max. switching voltage
- Max. switching capacity
- Recommended minimum load
- Mechanical service life
- Switching behavior
- Max. switching frequency

General data

Supply voltage range

- Current consumption
- Power dissipation
- Electrical isolation

Input/power supply

Output 1/output 2/input, power supply

- Ambient temperature range
- Humidity
- Housing material
- Inflammability class in acc. with UL 94
- Dimensions W / H / D
- Screw connection solid / stranded / AWG
- Push-in connection solid / stranded / AWG
- EMC note

Conformance / approvals

- Conformance
- ATEX
- UL, USA / Canada

SIL in accordance with IEC 61508

NAMUR proximity sensors (EN 60947-5-6)

open circuit switch contacts

Switch contacts with resistance circuit

~ 8 V DC

> 2.1 mA (conductive) / < 1.2 mA (blocking)

approx. 0.2 mA

Break 0.05 mA < I<sub>IN</sub> < 0.35 mA

Short circuit 100 Ω < R<sub>Sensor</sub> < 360 Ω

Relay output

1 PDT per channel

AgSnO<sub>2</sub>, hard gold-plated

250 V AC (2 A, 60 Hz) / 120 V DC (0.2 A) / 30 V DC (2 A)

500 VA

5 V / 10 mA

10<sup>7</sup> cycles

can be inverted using DIP switch

≤ 20 Hz (load-dependent)

24 V ... 230 V AC/DC (-20 % ... +10 %, 50 Hz ... 60 Hz)

< 80 mA ; < 42 mA (24 V DC)

≤ 1.3 W

300 V<sub>rms</sub> (rated insulation voltage (surge voltage category II);

pollution degree 2, safe isolation as per EN 61010-1)

2.5 kV (50 Hz, 1 min., test voltage)

300 V<sub>rms</sub> (rated insulation voltage (surge voltage category III);

pollution degree 2, safe isolation as per EN 61010-1)

2.5 kV (50 Hz, 1 min., test voltage)

-20 °C ... 60 °C

10 % ... 95 % (non-condensing)

PA 66-FR

V0

17.5 / 99 / 114.5 mm

0.2 ... 2.5 mm<sup>2</sup> / 0.2 ... 2.5 mm<sup>2</sup> / 24 - 14

0.2 ... 1.5 mm<sup>2</sup> / 0.2 ... 1.5 mm<sup>2</sup> / 24 - 16

Class A product, see page 625

CE-compliant, additionally EN 61326

II 3 G Ex nA nC IIC T4 Gc X

UL 508 Listed

UL 61010 Listed

Class I, Div. 2, Groups A, B, C, D T4

Class I, Zone 2, Group IIC T4

2

Ordering data

Description

NAMUR signal conditioner

- Screw connection
- Push-in connection

Type

- MACX MCR-SL-2NAM-R-UP
- MACX MCR-SL-2NAM-R-UP-SP

Order No.

- 2865052
- 2924304

Pcs. / Pkt.

- 1
- 1

Notes:

Information on resistance circuits and marking material can be found on page 180

Digital IN  
NAMUR signal conditioner

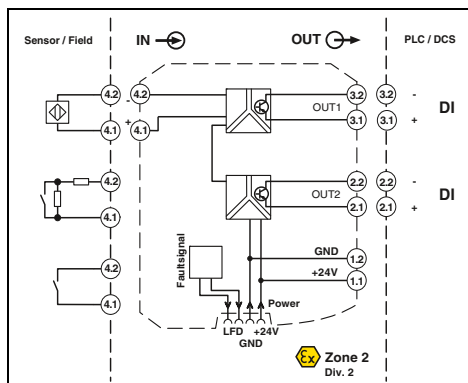
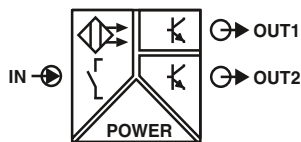

2 signal outputs: transistor (passive)

Functional Safety

Ex: Ex n

Housing width 12.5 mm

Technical data

NAMUR signal conditioner for operating proximity sensors and mechanical contacts

- Input for NAMUR proximity sensors (EN 60947-5-6), floating contacts or contacts with resistance circuit
- 2 signal outputs: transistor (passive); up to 5 kHz
- Signal output 2 can also be used as a fault signaling output
- Reversible direction of action (operating current or closed-circuit current behavior)
- Line fault detection (LFD), can be activated/deactivated, error message signaled by red flashing LED with inhibiting of transistor output
- Power supply and error indication possible via the DIN rail connector
- LED displays for indicating supply voltage, circuit state, and malfunctions to NAMUR NE 44
- 4-way electrical isolation
- Up to SIL 2 according to IEC 61508
- Installation in zone 2 permitted

<b>Input data</b>	
Input signal	
No-load voltage	
Switching points	
Line fault detection	
<b>Switching output</b>	
Max. switching voltage	
Max. switching current	
Drop (ΔU)	
Switching behavior	
Max. switching frequency	
<b>General data</b>	
Supply voltage range	
Current consumption	
Power dissipation	
Electrical isolation	
Input/output	375 V (peak value in accordance with EN 60079-11)
Input/output/supply, DIN rail connector	300 V <sub>rms</sub> (rated insulation voltage (surge voltage category II; pollution degree 2, safe isolation as per EN 61010-1)) 2.5 kV (50 Hz, 1 min., test voltage)
Input/supply, DIN rail connector	375 V (peak value in accordance with EN 60079-11)
Output 1/output 2	50 V <sub>rms</sub> (rated insulation voltage (surge voltage category II; pollution degree 2, safe isolation as per EN 61010-1)) 1 kV (50 Hz, 1 min., test voltage)
Ambient temperature range	-20 °C ... 60 °C (any mounting position)
Humidity	10 % ... 95 % (non-condensing)
Housing material	PA 66-FR
Inflammability class in acc. with UL 94	V0
Dimensions W / H / D	12.5 / 99 / 114.5 mm
Screw connection solid / stranded / AWG	0.2 ... 2.5 mm <sup>2</sup> / 0.2 ... 2.5 mm <sup>2</sup> / 24 - 14
Push-in connection solid / stranded / AWG	0.2 ... 1.5 mm <sup>2</sup> / 0.2 ... 1.5 mm <sup>2</sup> / 24 - 16
EMC note	Class A product, see page 625
<b>Conformance / approvals</b>	
Conformance	
ATEX	
UL, USA / Canada	
SIL in accordance with IEC 61508	

NAMUR proximity sensors (EN 60947-5-6)

Floating switch contacts

Switch contacts with resistance circuit

~ 8 V DC

> 2.1 mA (conductive) / < 1.2 mA (blocking)

Break 0.05 mA < I<sub>IN</sub> < 0.35 mA

Short circuit 100 Ω < R<sub>Sensor</sub> < 360 Ω

2 transistor outputs, passive

30 V DC (per output)

50 mA (short-circuit resistant)

< 1.4 V

can be inverted using DIP switch

5 kHz

19.2 V DC ... 30 V DC (24 V DC (-20% ... +25%))

< 28 mA (24 V DC)

800 mW

<b>Notes:</b>
Information about the power and fault signaling module as well as about the DIN rail connectors and marking material can be found from page 178
Information about resistance circuits is given on page 180
Information on Plug and Play connection using system cabling can be found from page 182

Ordering data

Description	
NAMUR signal conditioner	
	Screw connection
	Push-in connection

Type	Order No.	Pcs. / Pkt.
MACX MCR-SL-NAM-2T	2865023	1
MACX MCR-SL-NAM-2T-SP	2924278	1

Digital IN  
NAMUR signal conditioner

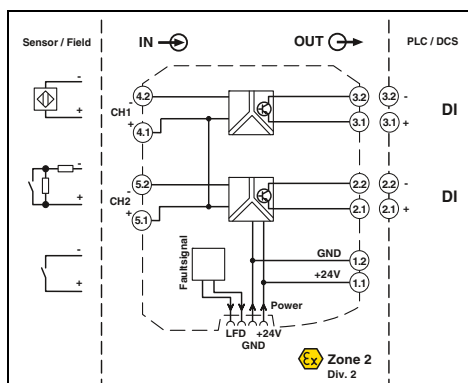
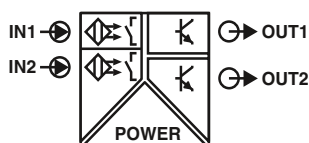

2-channel, signal output transistor (passive)

Functional Safety

Ex: Ex n Ex

Housing width 12.5 mm

Technical data

Input data

Input signal

No-load voltage  
Switching points  
Line fault detection

Switching output

Max. switching voltage  
Max. switching current  
Drop ( $\Delta U$ )  
Switching behavior  
Max. switching frequency

General data

Supply voltage range  
Current consumption  
Power dissipation  
Electrical isolation

Input/output  
Input/output/supply, DIN rail connector

Input/supply, DIN rail connector  
Output 1/output 2

Ambient temperature range  
Humidity  
Housing material  
Inflammability class in acc. with UL 94  
Dimensions W / H / D  
Screw connection solid / stranded / AWG  
Push-in connection solid / stranded / AWG  
EMC note

Conformance / approvals

Conformance  
ATEX  
UL, USA / Canada

SIL in accordance with IEC 61508

NAMUR proximity sensors (EN 60947-5-6)  
Floating switch contacts  
Switch contacts with resistance circuit  
~ 8 V DC  
> 2.1 mA (conductive) / < 1.2 mA (blocking)  
Break 0.05 mA < IIN < 0.35 mA  
Short circuit 100  $\Omega$  < RSensor < 360  $\Omega$

Transistor output, passive  
30 V DC (per output)  
50 mA (short-circuit resistant)  
< 1.4 V  
can be inverted using DIP switch  
5 kHz

19.2 V DC ... 30 V DC  
< 34 mA (24 V DC)  
1000 mW

375 V (peak value in accordance with EN 60079-11)  
300 V<sub>rms</sub> (rated insulation voltage (surge voltage category II; pollution degree 2, safe isolation as per EN 61010-1))  
2.5 kV (50 Hz, 1 min., test voltage)

375 V (peak value in accordance with EN 60079-11)  
50 V<sub>rms</sub> (rated insulation voltage (surge voltage category II; pollution degree 2, safe isolation as per EN 61010-1))  
1 kV (50 Hz, 1 min., test voltage)

-20 °C ... 60 °C (any mounting position)  
10 % ... 95 % (non-condensing)  
PA 66-FR  
V0  
12.5 / 99 / 114.5 mm  
0.2 ... 2.5 mm<sup>2</sup> / 0.2 ... 2.5 mm<sup>2</sup> / 24 - 14  
0.2 ... 1.5 mm<sup>2</sup> / 0.2 ... 1.5 mm<sup>2</sup> / 24 - 16  
Class A product, see page 625

CE-compliant, additionally EN 61326  
Ex II 3 G Ex nA IIC T4 Gc X  
UL 508 Listed  
UL 61010 Listed  
Class I, Div. 2, Groups A, B, C, D T4  
Class I, Zone 2, Group IIC T4  
2

Ordering data

Description

NAMUR signal conditioner

Screw connection  
Push-in connection

Type

MACX MCR-SL-2NAM-T  
MACX MCR-SL-2NAM-T-SP

Order No.

2865036  
2924281

Pcs. / Pkt.

1  
1

NAMUR signal conditioner for operating proximity sensors and mechanical contacts

- 2-channel
- Input for NAMUR proximity sensors (EN 60947-5-6), floating contacts or contacts with resistance circuit
- Signal output transistor (passive); up to 5 kHz
- Reversible direction of action (operating current or closed-circuit current behavior)
- Line fault detection (LFD), can be activated/deactivated, error message signaled by red flashing LED with inhibiting of transistor output
- Power supply and error indication possible via the DIN rail connector
- LED displays for indicating supply voltage, circuit state, and malfunctions to NAMUR NE 44
- 3-way electrical isolation
- Up to SIL 2 according to IEC 61508
- Installation in zone 2 permitted

Notes:

Information about the power and fault signaling module as well as about the DIN rail connectors and marking material can be found from page 178

Information about resistance circuits is given on page 180

Information on Plug and Play connection using system cabling can be found from page 182



Accessories

Power and fault signaling module

Power and fault signaling module for feeding the 24 V supply voltage to the DIN rail connectors and signaling line faults and power supply failures.

- One-time or redundant supply, decoupled from diode, protected against polarization
- Supply current up to 3.75 A
- Relay output (PDT) and flashing LED for error messages
- Error message in the event of a power supply failure or fuse fault
- Bus cable fault message for MACX MCR-...(2)NAM... devices connected via DIN rail connectors
- Replaceable fuse
- Installation in zone 2 permitted

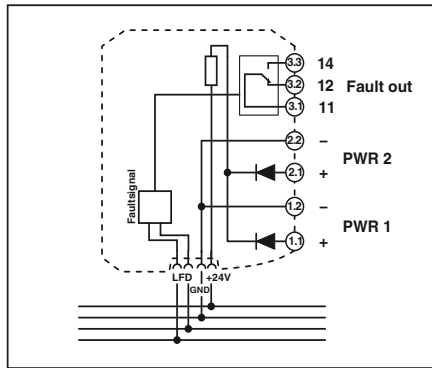

Ex n



Housing width 17.5 mm

Technical data

<b>Input data</b>	
Input signal	19.2 V DC ... 30 V DC (24 V DC (-20% ... +25%))
Redundant supply	yes, decoupled from diodes
Polarization and surge protection	Yes
<b>Output data</b>	
Maximum output signal	3.75 A
Output voltage	Input voltage - max 0.8 V at 3.75 A
<b>Switching output</b>	
Relay output	Relay
Contact type	1 PDT
Contact material	Gold (Au)
Max. switching voltage	50 V AC (50 V DC (0.3 A) / 50 V DC (2 A) / 33 V AC (2 A))
<b>General data</b>	
Ambient temperature range	-20 °C ... 60 °C (any mounting position)
Humidity	5% ... 95% (non-condensing)
Fuse	5 A (replaceable), slow-blow 250 V AC
Status indication	1 x red LED (error) 2 x green LEDs (PWR1 and PWR2)
Housing material	Polyamide (PA 6.6)
Inflammability class in acc. with UL 94	V0
Dimensions W / H / D	17.5 / 99 / 114.5 mm
Screw connection solid / stranded / AWG	0.2 ... 2.5 mm <sup>2</sup> / 0.2 ... 2.5 mm <sup>2</sup> / 24 - 14
Push-in connection solid / stranded / AWG	0.2 ... 1.5 mm <sup>2</sup> / 0.2 ... 1.5 mm <sup>2</sup> / 24 - 16
<b>Conformance / approvals</b>	
Conformance	CE-compliant
ATEX	Ex n IIC T4 Gc X
IECEX	Ex nA nC IIC T4 Gc X
UL, USA / Canada	UL 61010 Listed Class I, Div. 2, Groups A, B, C, D T5 Class I, Zone 2, Group IIC

<b>Technical data</b>		
Input signal	19.2 V DC ... 30 V DC (24 V DC (-20% ... +25%))	
Redundant supply	yes, decoupled from diodes	
Polarization and surge protection	Yes	
<b>Output data</b>		
Maximum output signal	3.75 A	
Output voltage	Input voltage - max 0.8 V at 3.75 A	
<b>Switching output</b>		
Relay output	Relay	
Contact type	1 PDT	
Contact material	Gold (Au)	
Max. switching voltage	50 V AC (50 V DC (0.3 A) / 50 V DC (2 A) / 33 V AC (2 A))	
<b>General data</b>		
Ambient temperature range	-20 °C ... 60 °C (any mounting position)	
Humidity	5% ... 95% (non-condensing)	
Fuse	5 A (replaceable), slow-blow 250 V AC	
Status indication	1 x red LED (error) 2 x green LEDs (PWR1 and PWR2)	
Housing material	Polyamide (PA 6.6)	
Inflammability class in acc. with UL 94	V0	
Dimensions W / H / D	17.5 / 99 / 114.5 mm	
Screw connection solid / stranded / AWG	0.2 ... 2.5 mm <sup>2</sup> / 0.2 ... 2.5 mm <sup>2</sup> / 24 - 14	
Push-in connection solid / stranded / AWG	0.2 ... 1.5 mm <sup>2</sup> / 0.2 ... 1.5 mm <sup>2</sup> / 24 - 16	
<b>Conformance / approvals</b>		
Conformance	CE-compliant	
ATEX	Ex n IIC T4 Gc X	
IECEX	Ex nA nC IIC T4 Gc X	
UL, USA / Canada	UL 61010 Listed Class I, Div. 2, Groups A, B, C, D T5 Class I, Zone 2, Group IIC	

Ordering data

<b>Description</b>	
<b>Power and fault signaling module</b> , including the relevant DIN rail connector ME 17,5 TBUS 1,5/5-ST-3,81 GN	
	Screw connection
	Push-in connection

Type	Order No.	Pcs. / Pkt.
MACX MCR-PTB	2865625	1
MACX MCR-PTB-SP	2924184	1

## Accessories

**ME 6,2 TBUS... DIN rail connector**

DIN rail connector (5-pos.) for bridging the supply voltage of 12.5 mm wide MACX Analog modules

- Reduces wiring costs
- System can be extended or module replaced even while process is active
- Inter-extendable



		Ordering data		
Description		Type	Order No.	Pcs. / Pkt.
	<b>DIN rail connector (TBUS)</b> , for bridging the supply voltage, can be snapped onto 35 mm DIN rails as per EN 60715, with UL approval			
Color: green		<b>ME 6,2 TBUS-2 1,5/5-ST-3,81 GN</b>	<b>2869728</b>	10

## Accessories

**Marking material for device marking**

- For device marking inside the control cabinet and in the field
- Self-adhesive with high adhesive strengths
- Large temperature range



		Ordering data		
Description	Color	Type	Order No.	Pcs. / Pkt.
	<b>UniCard</b> , with self-adhesive plastic labels			
10-part, lettering field size: 11 x 9 mm	white	<b>UC-EMLP (11X9)</b>	<b>0819291</b>	10
<b>UniCard</b> , with self-adhesive plastic labels, <b>marked according to customer specifications</b> For ordering details, see Catalog 5 or phoenixcontact.net/product.				
10-part, lettering field size: 11 x 9 mm	white	<b>UC-EMLP (11X9) CUS</b>	<b>0824547</b>	1

### Accessories

#### Resistance circuit

Double-level terminal block with resistance circuit according to NAMUR for line fault detection in the case of mechanical contacts

#### Important:

- For intrinsically safe circuits, only in combination with D-UKK 3/5 cover



		Ordering data		
Description	Color	Type	Order No.	Pcs. / Pkt.
<b>Double-level terminal block</b> , with pre-assembled resistors		<b>UKK 5-2R/NAMUR</b>	<b>2941662</b>	50
With screw connection		<b>D-UKK 3/5</b>	<b>2770024</b>	50
<b>Cover</b> , width 2.5 mm	gray blue	<b>D-UKK 3/5 BU</b>	<b>2770105</b>	50

### Accessories

#### Test plug



		Ordering data		
Description	Color	Type	Order No.	Pcs. / Pkt.
<b>Test plug</b> , consisting of:				
<b>Metal part</b> for 2.3 mm Ø socket hole and	silver	<b>MPS-MT</b>	<b>0201744</b>	10
<b>Insulating sleeve</b> , for MPS metal part	red	<b>MPS-IH RD</b>	<b>0201676</b>	10
	black	<b>MPS-IH BK</b>	<b>0201731</b>	10
	gray	<b>MPS-IH GY</b>	<b>0201728</b>	10
	green	<b>MPS-IH GN</b>	<b>0201702</b>	10
	yellow	<b>MPS-IH YE</b>	<b>0201692</b>	10
	blue	<b>MPS-IH BU</b>	<b>0201689</b>	10
	white	<b>MPS-IH WH</b>	<b>0201663</b>	10



### Termination Carriers for MACX Analog Ex signal conditioners



Select standard DIN rail device



Select module carrier

**TC... Termination Carriers** are compact solutions for quickly and smoothly connecting DIN rail devices from the MACX Analog Ex series to input/output cards of automation systems using system cabling.

The Termination Carriers combine the advantages of modular DIN rail devices with those offered by Plug and Play rapid cabling solutions to provide a consistent solution for system technology.

#### Compact

- Saves up to 30% of space due to compact design

#### Robust and reliable

- Stable, vibration-resistant aluminum carrier device profile
- PCB is completely decoupled from modules
- PCB without active components
- Redundant supply and monitoring in separate DIN rail module

#### Easy maintenance

- Use of standard DIN rail devices
- Easy access to connection points
- Quick and safe module connection with plug-in and coded cable sets

#### Flexible

- Horizontal or vertical DIN rail mounting
- Profile section without pitch markings for I/O cards with specific number of channels
- Can be specifically adapted for I/O cards of various automation systems with different system plug types



Select controller-specific front adapter and system cable



Solutions are also available for MINI Analog, MACX Analog Ex, and Safety

**Termination Carriers for MACX Analog Ex signal conditioners**

The **TC-D37SUB-ADIO16-EX-P-UNI** universal Termination Carrier is a compact solution which connects signal conditioners from the MACX Analog series to analog or binary input/output cards of automation systems.

The **TC-D37SUB-AIO16-EX-PS-UNI** Termination Carrier design, when combined with the MACX MCR-S-MUX HART multiplexer, also enables communication between HART-capable field devices and a management system.

- Connection of up to 16 single-channel (Ex i) signal conditioners
- Universal 1:1 signal routing to a 37-pos. D-SUB connector
- For system cables with D-SUB socket and open ends for universal connection
- Redundant supply and monitoring in separate DIN rail module

**Notes:**  
Contact us: specific Termination Carrier designs for I/O modules of various automation systems are available, planned or can be implemented according to your specifications.



ERC  
Ex: Housing width 242 mm

**Technical data**

<b>General data</b>	
Connection to the control system level	D-SUB pin strip
Number of positions	37
Max. operating voltage	< 50 V DC (per signal/channel)
Max. permissible current	23 mA (signal/channel)
Rated insulation voltage	50 V
Pollution degree	2
Surge voltage category	II
Rated surge voltage	0.5 kV (basic insulation)
Clearance and creepage distances	DIN EN 50178
Ambient temperature range	-20 °C ... 60 °C (please observe module specifications)
Shock	
Vibration (operation)	15g, according to IEC 60068-2-27
Dimensions W / H / D	2g, according to IEC 60068-2-6
EMC note	242 / 170 / 160 mm
<b>Power supply via power module</b>	
Input voltage range	Class A product, see page 625
Redundant supply	19.2 V DC ... 30 V DC
Polarization and surge protection	yes, decoupled from diodes
Fuse	Yes
Status indication	
Switching output	2x 2.5 A on PCB, slow-blow (replaceable)
Maximum switching voltage	1 x red LED (error)
	2x green LEDs (PWR1 and PWR2)
	1 N/C contact (alarm = open)
	50 V DC (0.3 A) / 30 V DC (2 A) / 33 V AC (2 A)

<b>Ordering data</b>		
<b>Type</b>	<b>Order No.</b>	<b>Pcs. / Pkt.</b>
TC-D37SUB-ADIO16-EX-P-UNI	2924854	1
TC-D37SUB-AIO16-EX-PS-UNI	2902932	1
<b>Accessories</b>		
TC-MACX-MCR-PTB	2904673	1
MACX MCR-S-MUX	2865599	1

<b>Description</b>
<b>Universal Termination Carrier</b> for 16 MACX MCR-EX isolators
- With connection for MACX MCR-S-MUX HART multiplexer

<b>Power and fault signaling module</b>
<b>HART multiplexer</b> , 32-channel, including two 14-wire flat-ribbon cables

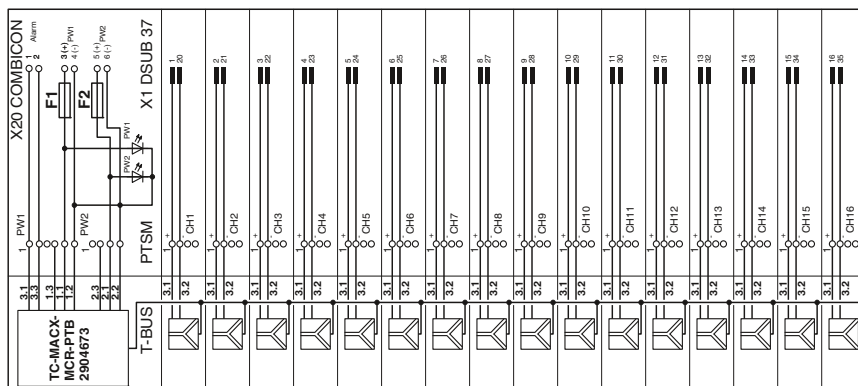

TC-D37SUB-ADIO16-EX-P-UNI and TC-D37SUB-AIO16-EX-PS-UNI connection scheme





**Integrate analog signals safely**

Integrate analog signals easily into your safety application according to the Machinery Directive. The MACX Safety analog signal conditioners are certified according to EN ISO 13849-1 with performance level PL d.

**Choose the right MACX Safety signal conditioner for your application:**

**Analog IN**

- 4...20 mA repeater power supplies and input signal conditioners with 2 electrically isolated outputs

**Temperature**

- Universal temperature transducers



**Direct switching of limit values possible without an additional safety controller**

- Cost savings: direct, safe switching of limit values possible without an additional safety controller
- Easy to combine active or passive analog signals with other safety modules

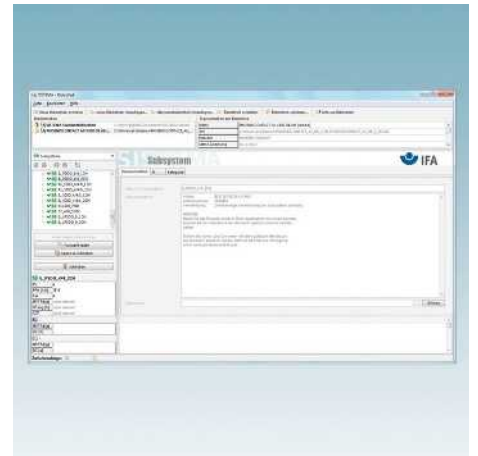

**Easy planning of the safety application with SISTEMA**

- Easy planning of the safety application with SISTEMA: the required data is already stored there



**DIN rail connector-compatible**

The DIN rail connector enables the modular bridging of the 24 V supply voltage.

Analog IN  
Repeater power supply

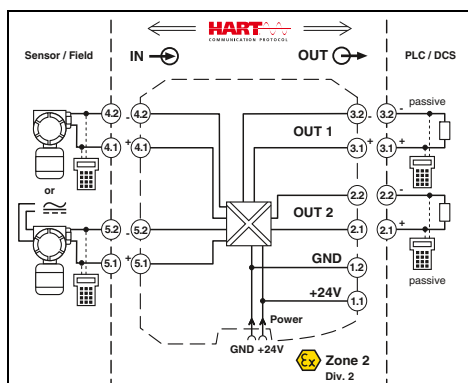
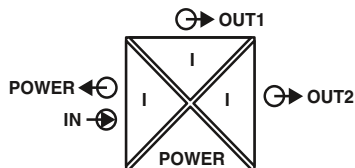

Repeater power supply and input signal conditioner, with two electrically isolated outputs



Housing width 12.5 mm

Technical data

<b>Input data</b>	
Input signal	4 mA ... 20 mA / 4 mA ... 20 mA
Transmitter supply voltage	> 21.5 V (20 mA)
Voltage drop	-
<b>Output data</b>	
Output signal (per output)	4 mA ... 20 mA (active)
Load	< 450 Ω (20 mA)
Output ripple	< 20 mV <sub>rms</sub>
<b>General data</b>	
Supply voltage range	19.2 V DC ... 30 V DC (24 V DC (-20% ... +25%))
Current consumption	< 75 mA (24 V DC)
Power dissipation	< 1.45 W (24 V DC/ 20 mA)
Temperature coefficient	< 0.01 %/K
Step response (10-90%)	< 1.3 ms (for 4 mA ... 20 mA step)
Transmission error, typical	< 0.05 % (of final value)
Maximum transmission error	< 0.1 % (of final value)
Underload/overload range	according to NE 43
Electrical isolation	
	Input/output/power supply 300 V <sub>rms</sub> (rated insulation voltage (surge voltage category II; pollution degree 2, safe isolation as per EN 61010-1)) 2.5 kV (50 Hz, 1 min., test voltage)
	Output 1/output 2 1.5 kV AC (50 Hz, 1 min., test voltage)
Ambient temperature range	-20 °C ... 60 °C (any mounting position)
Status indication	Green LED (PWR supply voltage)
SMART communication (per output)	Yes
Protocols supported	HART
Housing material	PA 66-FR
Dimensions W / H / D	12.5 / 99 / 114.5 mm
Screw connection solid / stranded / AWG	0.2 ... 2.5 mm <sup>2</sup> / 0.2 ... 2.5 mm <sup>2</sup> / 24 - 14
Push-in connection solid / stranded / AWG	0.2 ... 1.5 mm <sup>2</sup> / 0.2 ... 1.5 mm <sup>2</sup> / 24 - 16
EMC note	Class A product, see page 625
<b>Conformance / approvals</b>	
Conformance	CE-compliant, additionally EN 61326
ATEX	Ex II 3 G Ex nA IIC T4 Gc X
SIL in accordance with IEC 61508	2
Performance level according to ISO 13849	PLd

- 4...20 mA input, powered and not powered
- Two electrically isolated 4...20 mA (active) outputs
- PL d according to EN ISO 13849-1
- Up to SIL 2 according to IEC 61508
- Installation in zone 2 possible
- Plug-in screw and push-in connection technology
- 4-way electrical isolation
- Bidirectional HART communication possible
- Power supply via DIN rail connector possible

Ordering data				
Description	Type	Order No.	Pcs. / Pkt.	
Repeater power supply and input signal conditioner, signal duplicator, with performance level	Screw connection	MACX PL-RPSSI-2I	2904961	1
	Push-in connection	MACX PL-RPSSI-2I-SP	2904962	1

Temperature, temperature transducer

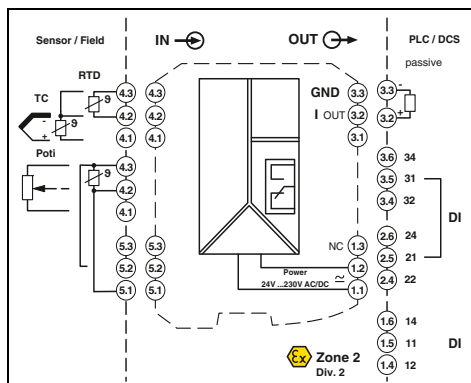
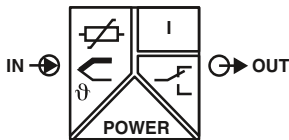

Universal, with limit value relay, wide range power supply

Functional Safety

Ex: Ex n, Ex ic, Ex tc, Ex mb

Housing width 35 mm

Technical data

- Input for resistance thermometers, thermocouples, resistance-type sensors, potentiometers, mV sources
- A safety-related limit value relay, by bridging two relays
- Differential measurement possible with Pt 100
- An additional limit value relay for non-safety-related function
- PL d according to EN ISO 13849-1
- Up to SIL 2 according to IEC 61508
- Configuration via software (ANALOG-CONF or FDT/DTM)
- Cold junction compensation with separate connector
- Wide range power supply 19.2...253 V AC/DC
- Status indicators for supply voltage, cable, sensor, and module errors
- Installation in zone 2 possible
- Plug-in screw and push-in connection technology

<b>Input data</b>	Resistance thermometers Thermocouple sensors
Resistor	Potentiometer
Voltage	
<b>Output data</b>	
Output signal	
Maximum output signal	
Load $R_B$	
Behavior in the event of a sensor error	
<b>Switching output</b>	
Contact type	
Contact material	
Max. switching voltage	
Max. switching current	
<b>General data</b>	
Supply voltage range	
Power consumption	
Temperature coefficient	
Maximum transmission error	
Electrical isolation	
Input/output/power supply	
Input/output	
Input/power supply	
Input/switching output	
Ambient temperature range	
Humidity	
Housing material	
Inflammability class in acc. with UL 94	
Dimensions W / H / D	
Screw connection solid / stranded / AWG	
Push-in connection solid / stranded / AWG	
EMC note	
<b>Conformance / approvals</b>	
Conformance	
ATEX	
IECEX	
SIL in accordance with IEC 61508	
Performance level according to ISO 13849	

Pt, Ni, Cu sensors: 2, 3, 4-wire  
B, E, J, K, N, R, S, T, L, U, CA, DA, A1G, A2G, A3G, MG, LG

0 Ω ... 50 kΩ  
0 Ω ... 50 kΩ  
-1000 mV ... 1000 mV

4 mA ... 20 mA  
22 mA  
≤ 600 Ω (at 20 mA)  
according to NE 43 or freely configurable

Relay output  
2 PDT  
AgSnO<sub>2</sub>, hard gold-plated  
250 V AC (250 V DC)  
2 A (250 V AC) / 2 A (28 V DC)

24 V ... 230 V AC/DC (-20%/+10%, 50/60 Hz)  
< 2.4 W  
0.01 %/K  
0.1 % (e.g. for Pt 100, 300 K span, 4 ... 20 mA)

300 V<sub>ins</sub> (rated insulation voltage (surge voltage category II; pollution degree 2, safe isolation as per EN 61010-1))  
2.5 kV (50 Hz, 1 min., test voltage)

375 V (peak value in accordance with EN 60079-11)  
375 V (peak value in accordance with EN 60079-11)  
375 V (peak value in accordance with EN 60079-11)  
-20 °C ... 65 °C  
typ. 5 % ... 95 % (non-condensing)  
PA 66-FR  
V0  
35 / 99 / 114.5 mm  
0.2 ... 2.5 mm<sup>2</sup> / 0.2 ... 2.5 mm<sup>2</sup> / 24 - 14  
0.2 ... 1.5 mm<sup>2</sup> / 0.2 ... 1.5 mm<sup>2</sup> / 24 - 16  
Class A product, see page 625

CE-compliant  
Ex n A nC ic IIC T4 Gc X  
Ex n A nC ic IIC T4 Gc X  
2  
PLd

Ordering data

Description	
Temperature transducer and threshold value switch with performance level	
Screw connection	
Push-in connection	

Type	Order No.	Pcs. / Pkt.
MACX PL-T-UIREL-UP	2904901	1
MACX PL-T-UIREL-UP-SP	2904903	1

Accessories

Programming adapter for configuring modules with S-PORT interface	
Connector, for current signals between +20 mA and -20 mA	

IFS-USB-PROG-ADAPTER	2811271	1
MACX MCR-I20	2905680	1

**Configuration software  
ANALOG-CONF and FDT/DTM**

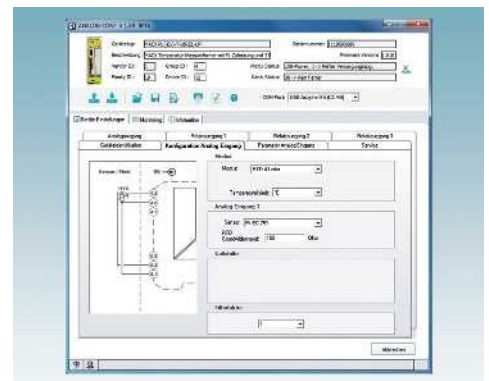
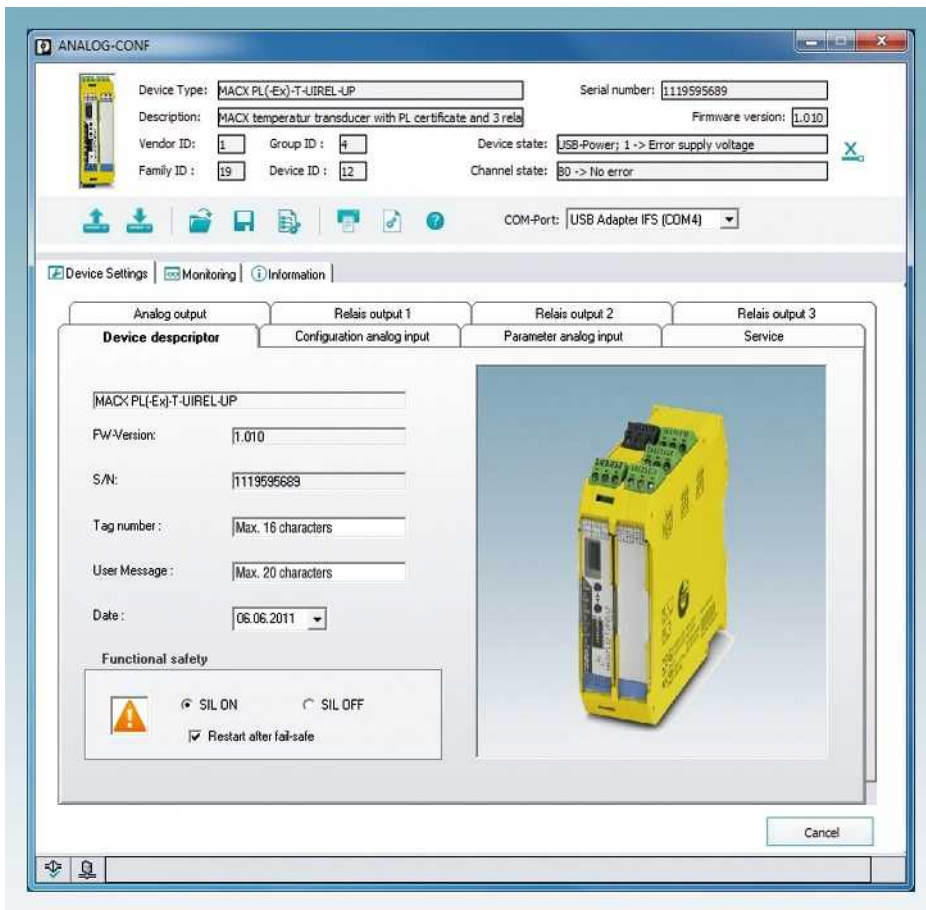

Input configuration with indication of the pin assignment

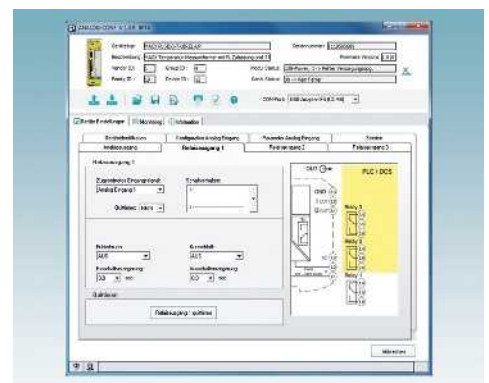

Relay configuration

**ANALOG-CONF**

The user-friendly ANALOG-CONF software allows you to quickly and clearly configure the temperature modules. The pin assignment for the input and output is directly displayed. You have access to the complete range of configurable parameters. You have the option to pre-configure parameters and then import them into any number of temperature transducers or read the data from the device and directly display the settings and measured values.

**FDT/DTM**

Configuration is also possible via the FDT/DTM universal configuration tool. The DTM files can simply be downloaded in the download area for the item.

**The following parameters can be configured:**

- Restart following failsafe

**Input:**

- Resistance thermometer
- Thermocouples
- Potentiometer
- Remote resistance-type sensor
- Voltage signals  $\pm 1$  V
- User characteristic curve
- Additional analog signals
- Filter
- Cold junction

**Analog output:**

- Type of fault signaling

**Switching outputs:**

- Acknowledgment, switching behavior
- Switch-on/off delay

**Monitoring:**

- Representation in diagram or value list, recording possible

**Service:**

- Reset, password protection, display DIP switch position
- And much more

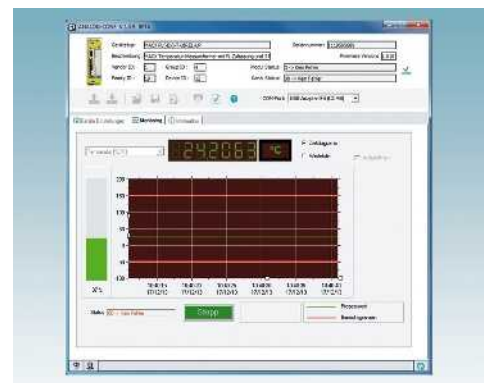

Monitoring function

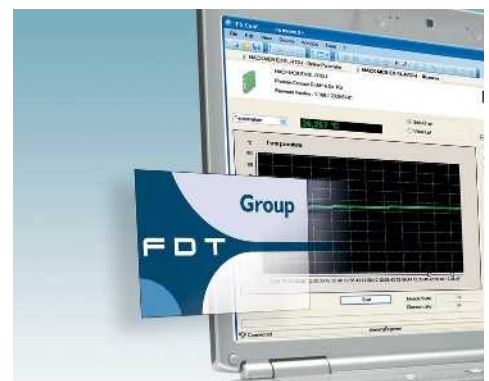

Configuration with FDT/DTM



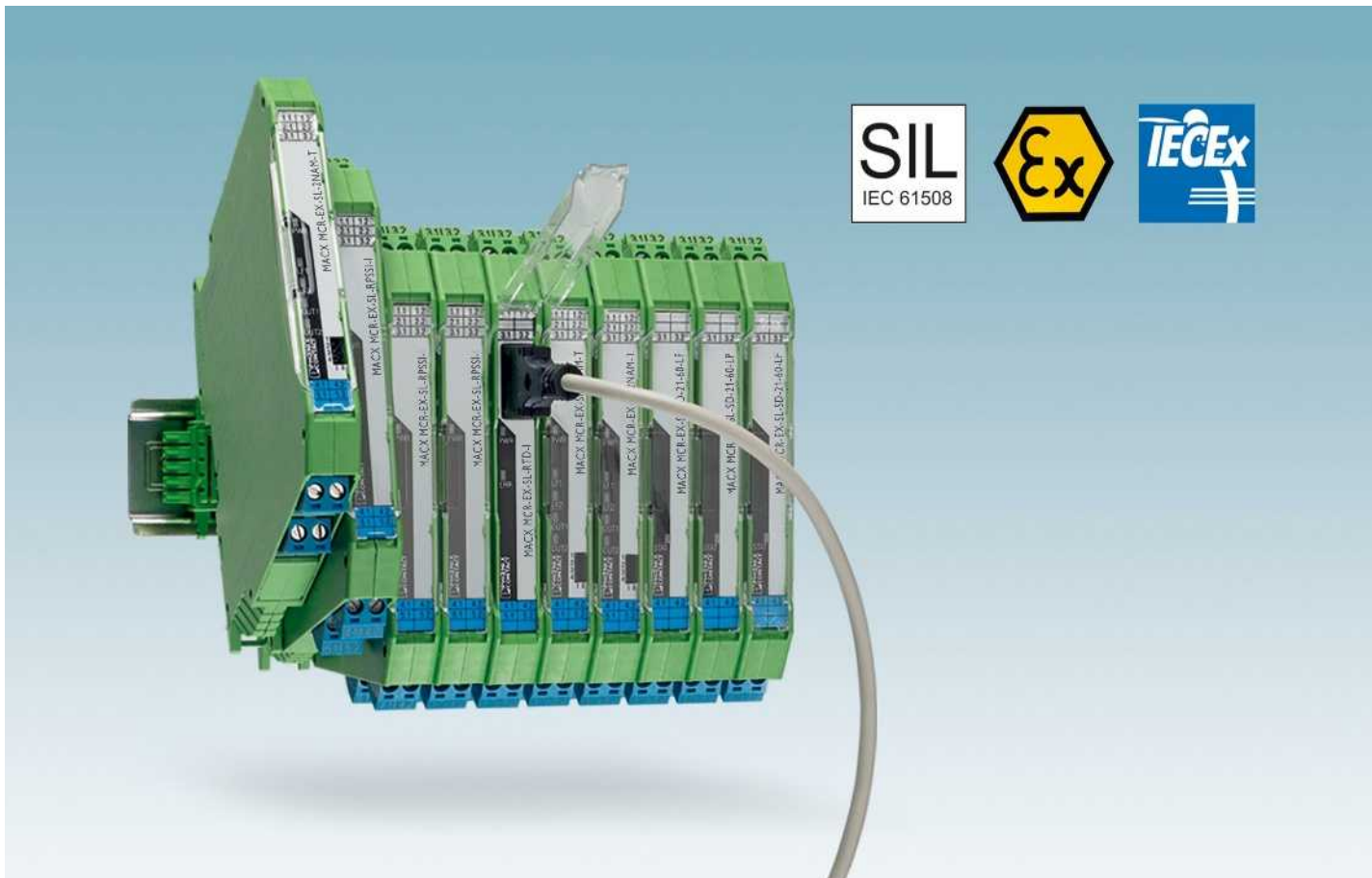

**Highly compact – leading technology**

MACX Analog Ex – single and two-channel signal conditioners for intrinsically safe circuits in the Ex area. The MACX Analog Ex signal conditioners ensure maximum system safety and explosion protection within a minimum amount of space. With an overall width of just 12.5 mm, this comprehensive range for analog signal conditioning is approved according to ATEX and IECEx and consistently SIL-certified.

**Safe and reliable functions**

Consistent SIL certification. The MACX Analog Ex signal conditioners are developed and produced according to functional safety and IEC 61508 standards. This ensures the highest level of reliability and safety for your systems.

**Maximum explosion protection for all Ex zones and gas groups**

As associated equipment according to the intrinsic safety (Ex i) protection type, the MACX Analog Ex signal conditioners isolate intrinsically safe circuits from non-intrinsically safe circuits and ensure safe limitation of the energy supplied to the Ex area. Furthermore, they handle extensive signal conditioning tasks.

All MACX Analog Ex signal conditioners are approved in accordance with the applicable ATEX/IECEx standards:

- [Ex ia] – for intrinsically safe circuits up to Ex zone 0 and Ex zone 20
- Ex n – for installing devices in Ex zone 2
- In addition, relevant national approvals such as UL and GOST are available

**Choose the right MACX Analog Ex signal conditioner for your application:**

**Analog IN**

Measuring transducer repeater power supply and input signal conditioner for the intrinsically safe operation of 2-wire transmitters, 4-wire measuring transducers, and current sources.

**Analog OUT**

Output signal conditioners for the intrinsically safe operation of control valves, I/P converters, and displays.

**Temperature**

Configurable temperature transducers for the intrinsically safe operation of resistance thermometers, remote resistance-type sensors, thermocouples, and mV sources – with safe limit value relays as an option.

**Digital IN**

NAMUR signal conditioners for the intrinsically safe operation of proximity sensors and switches.

**Digital OUT**

Solenoid drivers for the intrinsically safe operation of solenoid valves and alarm transmitters.

**Flexible energy supply**



**DIN rail connector-compatible**  
The DIN rail connector enables the modular bridging of the 24 V supply voltage.



**Wide range supply**  
The modules featuring a wide range supply (...UP) can be used in all power supply networks the world over without the need for additional power supply units.

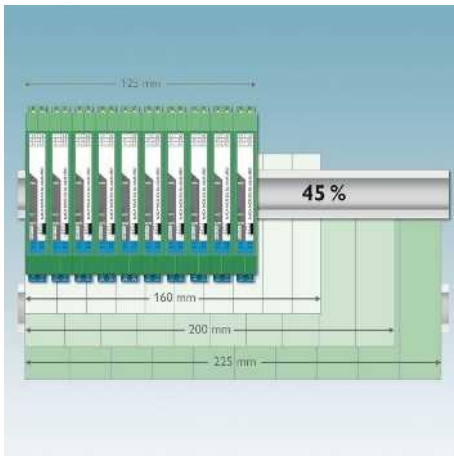

### Significant space savings

- Housing width of just 12.5 mm for all single and two-channel devices with DIN rail connector connection
- Space saving of up to 45% compared to other Ex i signal conditioners on the market

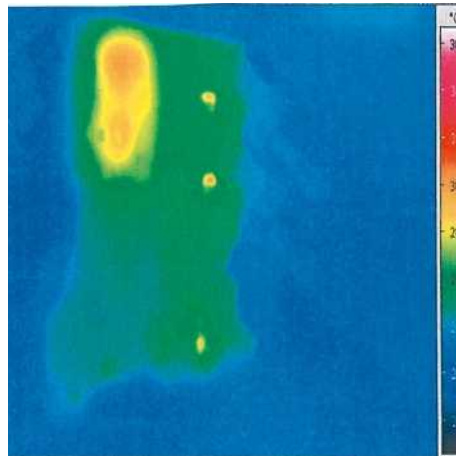

### Long service life and high operational reliability

- Long service life and high operational reliability over the entire operating temperature range, thanks to low power consumption and self-heating

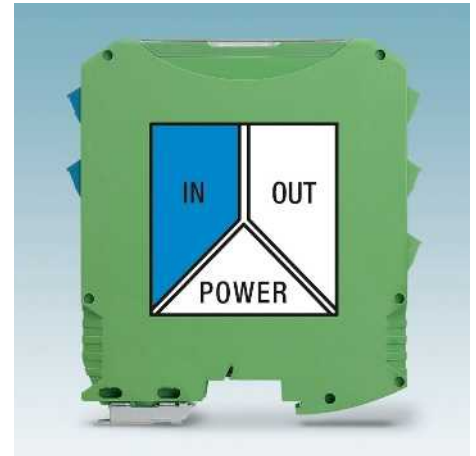

### Precise, interference-free signal transmission

- Precise and interference-free signal transmission due to a patented transmission concept with safe electrical isolation.



### Easy installation, power bridging, and diagnostics

- Flexible supply voltage bridging and the option of redundant, diode-decoupled supply and error indication.
- Plug-in, coded connection terminal blocks with test sockets; with screw connection or with fast push-in connection technology as an option



### Easy configuration and monitoring

- Either via FDT/DTM or alternatively via user-friendly stand-alone software – with integrated monitoring function
- Or without software via DIP switches on the housing front or with the operator interface and display unit



### Fast and error-free signal connection

- Compact Termination Carriers connect MACX Analog Ex devices to the automation system – Plug and Play



Analog IN

Repeater power supply, Ex i

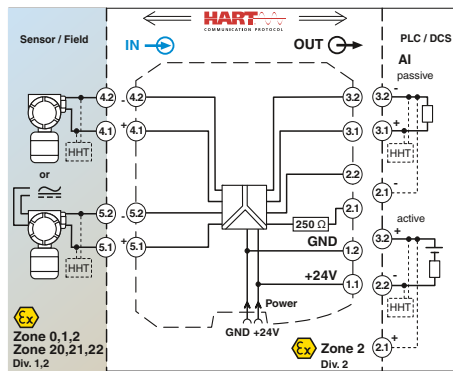
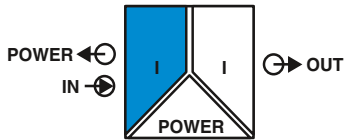

Repeater power supply and input signal conditioner

Functional Safety  
 Ex: Ex EAC Ex  
 Housing width 12.5 mm

Repeater power supply and input signal conditioner for the operation of intrinsically safe (Ex i) 2-wire measuring transducers, 4-wire measuring transducers, and mA current sources installed in Ex areas.

- 0/4 ... 20 mA input, [Ex ia] (powered or not powered)
- 0/4...20 mA output (active or passive)
- Bidirectional transmission of digital HART communication signals
- Plug-in screw or push-in connection technology, with integrated sockets for HART communicators
- Terminal point with 250 Ω resistor to increase the HART impedance in the case of low-impedance systems
- 3-way electrical isolation
- Power supply via DIN rail connector possible
- Up to SIL 2 according to IEC 61508
- Installation in zone 2 permitted

<b>Notes:</b>
Information about the power and fault signaling module as well as about the DIN rail connectors and marking material can be found from page 213
Test plugs for test sockets can be found on page 180
Information on Plug and Play connection using system cabling can be found from page 216

<b>Input data</b>	
Input signal	
Transmitter supply voltage	
Voltage drop	
<b>Output data</b>	
Output signal	
<b>Load</b>	
Output ripple	
<b>General data</b>	
Supply voltage range	
Current consumption	
<b>Power dissipation</b>	
Temperature coefficient	
Step response (10-90%)	
<b>Transmission error, typical</b>	
Maximum transmission error	
Underload/overload range	
Electrical isolation	
<b>Input/output/power supply</b>	
Ambient temperature range	
Humidity	
Status indication	
SMART communication	
Signal bandwidth	
Protocols supported	
Housing material	
Inflammability class in acc. with UL 94	
Dimensions W / H / D	
Screw connection solid / stranded / AWG	
Push-in connection solid / stranded / AWG	
EMC note	
<b>Safety data as per ATEX</b>	
Max. output voltage $U_o$	
Max. output current $I_o$	
Max. output power $P_o$	
Maximum voltage $U_m$	
<b>Conformance / approvals</b>	
Conformance	
ATEX	
IECEX	
UL, USA / Canada	
SIL in accordance with IEC 61508	

**Technical data**

4 mA ... 20 mA
> 16 V (20 mA)
-
4 mA ... 20 mA (active)
4 mA ... 20 mA (14 ... 26 V ext. source voltage)
< 1000 Ω (20 mA)
< 20 mV <sub>rms</sub>
19.2 V DC ... 30 V DC (24 V DC (-20% ... +25%))
< 76 mA (24 V DC / 20 mA / 1000 Ω);
< 55 mA (24 V DC / 20 mA / 250 Ω)
< 1.1 W (24 V DC / 20 mA / 1000 Ω)
< 0.95 W (24 V DC / 20 mA / 250 Ω)
< 1.2 W (24 V DC / 20 mA / 0 Ω)
< 0.01 %/K
< 200 μs (for 4 mA ... 20 mA step, load 600)
< 0.05 % (of final value)
< 0.1 % (of final value)
according to NE 43
300 V <sub>rms</sub> (rated insulation voltage (surge voltage category II; pollution degree 2, safe isolation as per EN 61010-1))
2.5 kV (50 Hz, 1 min., test voltage)
375 V (peak value in accordance with EN 60079-11)
375 V (peak value in accordance with EN 60079-11)
-20 °C ... 60 °C (any mounting position)
10 % ... 95 % (non-condensing)
Green LED (supply voltage)
Yes
as per HART specifications
HART
PA 66-FR
V0
12.5 / 112.5 / 114.5 mm
0.2 ... 2.5 mm <sup>2</sup> / 0.2 ... 2.5 mm <sup>2</sup> / 24 - 14
0.2 ... 1.5 mm <sup>2</sup> / 0.2 ... 1.5 mm <sup>2</sup> / 24 - 16
Class A product, see page 625
25.2 V
93 mA
587 mW
253 V AC (125 V DC)
CE-compliant, additionally EN 61326
Ex II (1) G [Ex ia Ga] IIC/IIB
Ex II (1) D [Ex ia Da] IIIC
Ex II 3 (1) G Ex nA [ia Ga] IIC/IIB T4 Gc
Ex I (M1) [Ex ia Ma] I
[Ex ia Ga] IIC/IIB, [Ex ia Da] IIIC, Ex nA [ia Ga] IIC/IIB T4 Gc
UL 61010 Listed
Class I Div 2; IS for Class I, II, III Div 1
2

**Ordering data**

Description	Type	Order No.	Pcs. / Pkt.
Repeater power supply, smart, intrinsically safe input			
Screw connection	MACX MCR-EX-SL-PPSSI-I	2865340	1
Push-in connection	MACX MCR-EX-SL-PPSSI-I-SP	2924016	1

Analog IN

Repeater power supply, Ex i

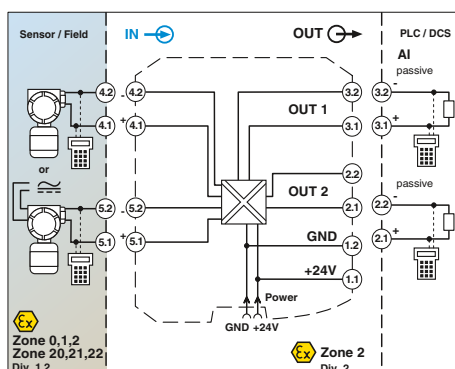
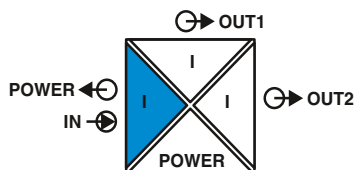

Repeater power supply and input signal conditioner, with two electrically isolated outputs

Functional Safety  
 Ex: EAC Ex  
 Housing width 12.5 mm

Repeater power supply and input signal conditioner for the operation of intrinsically safe (Ex i) 2-wire measuring transducers, 4-wire measuring transducers, and mA current sources installed in Ex areas.

- 0/4 ... 20 mA input, [Ex ia] (powered or not powered)
- Two electrically isolated 0/4 ... 20 mA (active) outputs
- Bidirectional transmission of digital HART communication signals (both outputs)
- Plug-in screw or push-in connection technology, with integrated sockets for HART communicators
- 4-way electrical isolation
- Power supply via DIN rail connector possible
- Up to SIL 2 according to IEC 61508
- Installation in zone 2 permitted

Input data

Input signal  
 Transmitter supply voltage  
 Voltage drop

Output data

Output signal (per output)

Load

Output ripple

General data

Supply voltage range  
 Current consumption  
 Power dissipation  
 Temperature coefficient  
 Step response (10-90%)  
 Transmission error, typical  
 Maximum transmission error  
 Underload/overload range  
 Electrical isolation

Input/output/power supply

Input/output  
 Input/power supply  
 Output 1/output 2

Ambient temperature range  
 Status indication  
 SMART communication (per output)

Protocols supported  
 Housing material  
 Dimensions W / H / D  
 Screw connection solid / stranded / AWG  
 Push-in connection solid / stranded / AWG  
 EMC note

Safety data as per ATEX

Max. output voltage  $U_o$   
 Max. output current  $I_o$   
 Max. output power  $P_o$   
 Maximum voltage  $U_m$

Conformance / approvals

Conformance  
 ATEX

IECEX  
 UL, USA / Canada

SIL in accordance with IEC 61508

Technical data

4 mA ... 20 mA / 0 mA ... 20 mA  
 > 16 V (at 20 mA)  
 < 3.9 V (in input signal conditioner)

4 mA ... 20 mA (active)

< 450  $\Omega$  (at 20 mA)  
 < 20 mV<sub>rms</sub>

19.2 V DC ... 30 V DC (24 V DC (-20% ... +25%))  
 < 75 mA (24 V DC / 20 mA)  
 < 1.45 W (24 V DC / 20 mA)  
 < 0.01 %/K  
 < 1.3 ms (for 4 mA ... 20 mA step)  
 < 0.05 % (of final value)  
 < 0.1 % (of final value)  
 according to NE 43

300 V<sub>rms</sub> (rated insulation voltage (surge voltage category II; pollution degree 2, safe isolation as per EN 61010-1))  
 2.5 kV (50 Hz, 1 min., test voltage)

375 V (peak value in accordance with EN 60079-11)  
 375 V (peak value in accordance with EN 60079-11)  
 1.5 kV AC (50 Hz, 1 min., test voltage)  
 -20 °C ... 60 °C (any mounting position)  
 Green LED (PWR supply voltage)

Yes  
 HART  
 PA 66-FR  
 12.5 / 99 / 114.5 mm  
 0.2 ... 2.5 mm<sup>2</sup> / 0.2 ... 2.5 mm<sup>2</sup> / 24 - 14  
 0.2 ... 1.5 mm<sup>2</sup> / 0.2 ... 1.5 mm<sup>2</sup> / 24 - 16  
 Class A product, see page 625

25.2 V  
 93 mA  
 587 mW  
 253 V AC (125 V DC)

CE-compliant, additionally EN 61326  
 Ex II (1) G [Ex ia Ga] IIC/IIB  
 Ex II (1) D [Ex ia Da] IIIC  
 Ex II 3 (1) G Ex nA [ia Ga] IIC/IIB T4 Gc  
 [Ex ia Ga] IIC/IIB, [Ex ia Da] IIIC, Ex nA [ia Ga] IIC/IIB T4 Gc  
 Class I Div 2; IS for Class I, II, III Div 1  
 2

Notes:

Information about the power and fault signaling module as well as about the DIN rail connectors and marking material can be found from page 213

Test plugs for test sockets can be found on page 180

Information on Plug and Play connection using system cabling can be found from page 216

Ordering data

Description

Repeater power supply, smart, intrinsically safe input

Screw connection  
 Push-in connection

Type	Order No.	Pcs. / Pkt.
MACX MCR-EX-SL-RPSSI-2I	2865366	1
MACX MCR-EX-SL-RPSSI-2I-SP	2924236	1

Analog IN

Repeater power supply, Ex i

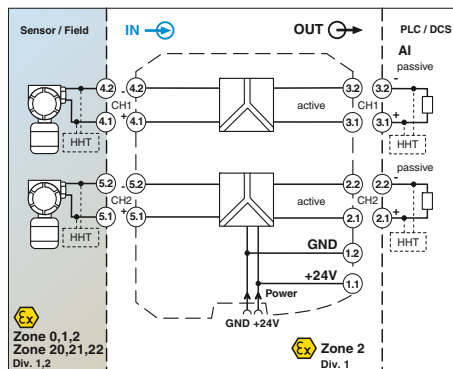
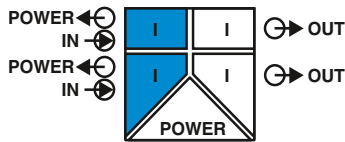

2-channel repeater power supply

Functional Safety

Ex: Ex i

Housing width 12.5 mm

Technical data

per channel	4 mA ... 20 mA
Transmitter supply voltage	> 16 V (at 20 mA)
Underload/overload signal range	0 mA ... 24 mA
per channel	4 mA ... 20 mA (active)
Load	≤ 450 Ω (20 mA)
Underload/overload signal range	0 mA ... 24 mA

Input data

Input signal	4 ... 20 mA
Transmitter supply voltage	> 16 V (at 20 mA)
Underload/overload signal range	0 mA ... 24 mA

Output data

Output signal	4 ... 20 mA (active)
Load	≤ 450 Ω (20 mA)
Underload/overload signal range	0 mA ... 24 mA

General data

Supply voltage range	19.2 V DC ... 30 V DC (24 V DC (-20% ... +25%))
Current consumption	< 100 mA (24 V / 20 mA)
Power dissipation	< 1.4 W (at 24 V DC / 20 mA)
Temperature coefficient	< 0.01 %/K
Step response (10-90%)	< 1.3 ms (for 4 mA ... 20 mA step)
Transmission error, typical	< 0.05 % (of final value)
Maximum transmission error	< 0.1 % (of final value)
Electrical isolation	300 V <sub>rms</sub> (rated insulation voltage (surge voltage category II; pollution degree 2, safe isolation as per EN 61010-1)) 2.5 kV (50 Hz, 1 min., test voltage)

Input/output, power supply

Input/output  
Input/power supply  
Output 1/output 2/ power supply

Ambient temperature range	-20 °C ... 60 °C (any mounting position)
Status indication	Green LED (supply voltage)
SMART communication	Yes
Signal bandwidth	as per HART specifications
Protocols supported	HART
Housing material	PA 66-FR
Dimensions W / H / D	12.5 / 99 / 114.5 mm
Screw connection solid / stranded / AWG	0.2 ... 2.5 mm <sup>2</sup> / 0.2 ... 2.5 mm <sup>2</sup> / 24 - 14
Push-in connection solid / stranded / AWG	0.2 ... 1.5 mm <sup>2</sup> / 0.2 ... 1.5 mm <sup>2</sup> / 24 - 16
EMC note	Class A product, see page 625

Safety data as per ATEX

Max. output voltage U <sub>o</sub>	25.2 V
Max. output current I <sub>o</sub>	93 mA
Max. output power P <sub>o</sub>	587 mW
Maximum voltage U <sub>m</sub>	253 V AC (125 V DC)

Conformance / approvals

Conformance  
ATEX

IECEX  
UL, USA / Canada  
SIL in accordance with IEC 61508

300 V<sub>rms</sub> (rated insulation voltage (surge voltage category II; pollution degree 2, safe isolation as per EN 61010-1))  
2.5 kV (50 Hz, 1 min., test voltage)

375 V (peak value in accordance with EN 60079-11)  
375 V (peak value in accordance with EN 60079-11)

1.5 kV (50 Hz, 1 min., test voltage)  
-20 °C ... 60 °C (any mounting position)  
Green LED (supply voltage)

Yes  
as per HART specifications

HART  
PA 66-FR  
12.5 / 99 / 114.5 mm  
0.2 ... 2.5 mm<sup>2</sup> / 0.2 ... 2.5 mm<sup>2</sup> / 24 - 14  
0.2 ... 1.5 mm<sup>2</sup> / 0.2 ... 1.5 mm<sup>2</sup> / 24 - 16  
Class A product, see page 625

25.2 V  
93 mA  
587 mW  
253 V AC (125 V DC)

CE-compliant, additionally EN 61326  
Ex II (1) G [Ex ia Ga] IIC/IIB  
Ex II (1) D [Ex ia Da] IIIC  
Ex II 3(1) G Ex nA [ia Ga] IIC T4 Gc  
[Ex ia Ga] IIC/IIB, [Ex ia Da] IIIC, Ex nA [ia Ga] IIC T4 Gc  
Class I Div 2; IS for Class I, II, III Div 1  
3

Ordering data

Description

Repeater power supply, 2-channel, smart, intrinsically safe input

Screw connection  
Push-in connection

Type	Order No.	Pcs. / Pkt.
MACX MCR-EX-SL-RPSS-2I-2I	2865382	1
MACX MCR-EX-SL-RPSS-2I-2I-SP	2924676	1

Repeater power supply for the operation of intrinsically safe (Ex i) 2-wire measuring transducers installed in the Ex area.

- 2-channel
- 4 ... 20 mA input, [Ex ia] (powered)
- 4 ... 20 mA output (active)
- Bidirectional transmission of digital HART communication signals
- Plug-in screw or push-in connection technology, with integrated sockets for HART communicators
- Safe 3-way electrical isolation
- Power supply via DIN rail connector possible
- Up to SIL 3 according to IEC 61508
- Installation in zone 2 permitted

<b>Notes:</b>
Information on the power and fault signaling module, DIN rail connectors, system cabling, and marking material can be found from page 213
Test plugs for test sockets can be found on page 180
Information on Plug and Play connection using system cabling can be found from page 216

Analog IN

Repeater power supply with wide range power supply, Ex i

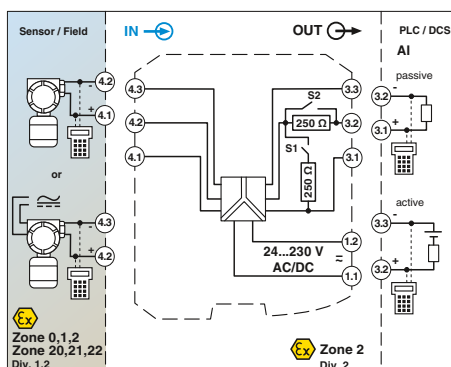
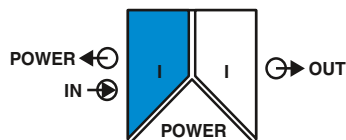

Repeater power supply and input signal conditioner, wide range power supply

Functional Safety  
 Ex: Ex i EAC Ex // Applied for: GL  
 Housing width 17.5 mm

Repeater power supply and input signal conditioner for the operation of intrinsically safe (Ex i) 2-wire measuring transducers, 4-wire measuring transducers, and mA current sources installed in Ex areas.

- 0/4 ... 20 mA input, [Ex ia] (powered or not powered)
- Output 0/4...20 mA (active or passive), 0/1...5 V, can be switched via the DIP switch
- Bidirectional transmission of digital HART communication signals
- Plug-in screw or push-in connection technology, with integrated sockets for HART communicators
- 250 Ω resistor that can be activated via DIP switches to increase the HART impedance in the case of low-impedance systems
- 3-way electrical isolation
- Wide range power supply: 19.2 ... 253 V AC/DC
- Up to SIL 2 according to IEC 61508
- Installation in zone 2 permitted

<b>Input data</b>	Input signal Transmitter supply voltage Voltage drop
<b>Output data</b>	Output signal (configurable using the DIP switch)
<b>Load</b>	Output ripple
<b>General data</b>	Supply voltage range Current consumption Power dissipation Temperature coefficient Step response (10-90%) Transmission error, typical Maximum transmission error Underload/overload range Electrical isolation
<b>Ambient temperature range</b>	Input/output/power supply
<b>Humidity</b>	Input/output
<b>Status indication</b>	Input/power supply
<b>SMART communication</b>	
<b>Signal bandwidth</b>	
<b>Protocols supported</b>	
<b>Housing material</b>	
<b>Inflammability class in acc. with UL 94</b>	
<b>Dimensions W / H / D</b>	
<b>Screw connection solid / stranded / AWG</b>	
<b>Push-in connection solid / stranded / AWG</b>	
<b>EMC note</b>	
<b>Safety data as per ATEX</b>	
<b>Max. output voltage U<sub>o</sub></b>	
<b>Max. output current I<sub>o</sub></b>	
<b>Max. output power P<sub>o</sub></b>	
<b>Maximum voltage U<sub>m</sub></b>	
<b>Conformance / approvals</b>	
<b>Conformance</b>	
<b>ATEX</b>	
<b>IECEX</b>	
<b>UL, USA / Canada</b>	
<b>SIL in accordance with IEC 61508</b>	

Technical data

0 mA ... 20 mA / 4 mA ... 20 mA
> 16 V (at 20 mA)
< 3.5 V (in input signal conditioner operation)
0 mA ... 20 mA (active)
4 mA ... 20 mA (active)
0 mA ... 20 mA (14 ... 26 V ext. source voltage)
4 mA ... 20 mA (14 ... 26 V ext. source voltage)
0 V ... 5 V (internal resistance, 250 Ω, 0.1%)
1 V ... 5 V (internal resistance, 250 Ω, 0.1%)
< 600 Ω (I output)
< 20 mV <sub>rms</sub>
24 V ... 230 V AC/DC (-20%/+10%, 50/60 Hz)
< 80 mA (at 24 V DC)
< 1.6 W
< 0.01 %/K
< 600 μs (for 4 mA ... 20 mA step)
< 0.05 % (of final value)
< 0.1 % (of final value)
according to NE 43
300 V <sub>rms</sub> (rated insulation voltage (surge voltage category II; pollution degree 2, safe isolation as per EN 61010-1))
2.5 kV (50 Hz, 1 min., test voltage)
375 V (peak value in accordance with EN 60079-11)
375 V (peak value in accordance with EN 60079-11)
-20 °C ... 60 °C (any mounting position)
10 % ... 95 % (non-condensing)
Green LED (supply voltage)
Yes
as per HART specifications
HART
PA 66-FR
V0
17.5 / 99 / 114.5 mm
0.2 ... 2.5 mm <sup>2</sup> / 0.2 ... 2.5 mm <sup>2</sup> / 24 - 14
0.2 ... 1.5 mm <sup>2</sup> / 0.2 ... 1.5 mm <sup>2</sup> / 24 - 16
Class A product, see page 625
25.2 V
93 mA
587 mW
253 V AC (125 V DC)
CE-compliant, additionally EN 61326
Ex II (1) G [Ex ia Ga] IIC/IIB
Ex II (1) D [Ex ia Da] IIIC
Ex II 3(1) G Ex nA [ia Ga] IIC/IIB T4 Gc
[Ex ia Ga] IIC/IIB, [Ex ia Da] IIIC, Ex nA [ia Ga] IIC/IIB T4 Gc
Class I Div 2; IS for Class I, II, III Div 1
2

<b>Notes:</b>
Information on marking material can be found on page 179
Test plugs for test sockets can be found on page 180

Ordering data

Description	Type	Order No.	Pcs. / Pkt.	
<b>Repeater power supply, smart, intrinsically safe input</b>	Screw connection	<b>MACX MCR-EX-SL-RPSSI-I-UP</b>	2865793	1
	Push-in connection	<b>MACX MCR-EX-SL-RPSSI-I-UP-SP</b>	2924029	1

Analog OUT  
Output signal conditioner, Ex i

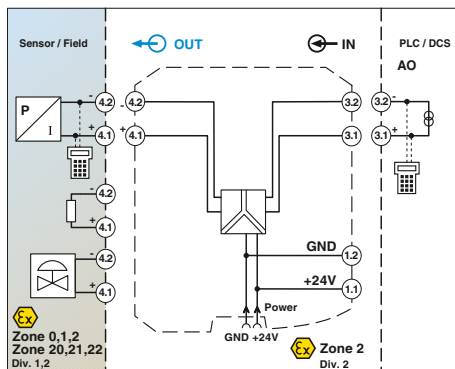
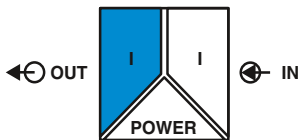

Functional Safety

Ex: Ex i

Housing width 12.5 mm

Technical data

Output signal conditioner for controlling intrinsically safe (Ex i) I/P converters, control valves, and indicators installed in Ex areas.

- 0/4...20 mA input
- 0/4...20 mA output, [Ex ia] IIC
- Bidirectional transmission of digital HART communication signals
- Plug-in screw or push-in connection technology, with integrated sockets for HART communicators
- Line fault detection (LFD)
- 3-way electrical isolation
- Power supply via DIN rail connector possible
- Up to SIL 2 according to IEC 61508
- Installation in zone 2 permitted

**Notes:**

Information about the power and fault signaling module as well as about the DIN rail connectors and marking material can be found from page 213
Test plugs for test sockets can be found on page 180
Information on Plug and Play connection using system cabling can be found from page 216

<b>Input data</b>	
Input signal	
Input voltage	
Input impedance in the event of a cable break at the output	
<b>Output data</b>	
Output signal	
<b>Load</b>	
Output ripple	
<b>General data</b>	
Supply voltage range	
Current consumption	
Power dissipation	
Temperature coefficient	
Step response (10-90%)	
Maximum transmission error	
Electrical isolation	
<b>Ambient temperature range</b>	
Humidity	
Status indication	
SMART communication	
Signal bandwidth	
Protocols supported	
Housing material	
Inflammability class in acc. with UL 94	
Dimensions W / H / D	
Screw connection solid / stranded / AWG	
Push-in connection solid / stranded / AWG	
EMC note	
<b>Safety data as per ATEX</b>	
Max. output voltage $U_o$	
Max. output current $I_o$	
Max. output power $P_o$	
Maximum voltage $U_m$	
<b>Conformance / approvals</b>	
Conformance	
ATEX	
IECEX	
UL, USA / Canada	
SIL in accordance with IEC 61508	

Input/output/power supply

Output/input  
Output/supply

0 mA ... 20 mA / 4 mA ... 20 mA
5.4 V (at 20 mA)
> 100 kΩ (if there is a line fault)
0 mA ... 20 mA (intrinsically safe) / 4 mA ... 20 mA (intrinsically safe)
< 800 Ω (at 20 mA)
< 20 mV <sub>rms</sub>
19.2 V DC ... 30 V DC (24 V DC (-20% ... +25%))
< 46 mA (at 24 V DC / 20 mA)
< 1.1 W (at 24 V DC / 20 mA)
< 0.01 %/K
< 140 μs (for 4 mA ... 20 mA step)
< 0.1 % (of final value)
1.5 kV (50 Hz, 1 min., test voltage)
300 V <sub>rms</sub> (rated insulation voltage (surge voltage category II, pollution degree 2))
375 V (peak value in accordance with EN 60079-11)
375 V (peak value in accordance with EN 60079-11)
-20 °C ... 60 °C (any mounting position)
10 % ... 95 % (non-condensing)
Green LED (supply voltage)
Yes
as per HART specifications
HART
PA 66-FR
V0
12.5 / 99 / 114.5 mm
0.2 ... 2.5 mm <sup>2</sup> / 0.2 ... 2.5 mm <sup>2</sup> / 24 - 14
0.2 ... 1.5 mm <sup>2</sup> / 0.2 ... 1.5 mm <sup>2</sup> / 24 - 16
Class A product, see page 625
27.7 V
92 mA
633 mW
253 V AC (125 V DC)
CE-compliant, additionally EN 61326
Ex II (1) G [Ex ia Ga] IIC/IIB
Ex II (1) D [Ex ia Da] IIIC
Ex II 3(1) G Ex nA [ia Ga] IIC/IIB T4 Gc
[Ex ia Ga] IIC/IIB, [Ex ia Da] IIIC, Ex nA [ia Ga] IIC/IIB T4 Gc
Class I Div 2; IS for Class I, II, III Div 1
2

Ordering data

Description	Type	Order No.	Pcs. / Pkt.
Output signal conditioner, smart, intrinsically safe output			
Screw connection	MACX MCR-EX-SL-IDSI-I	2865405	1
Push-in connection	MACX MCR-EX-SL-IDSI-I-SP	2924032	1



Temperature

Temperature transducer, Ex i

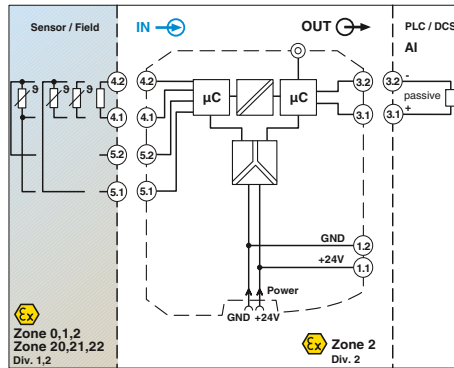
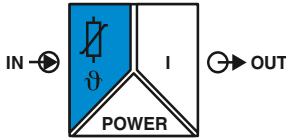

For resistance thermometers and resistance-type sensors



Housing width 12.5 mm

Technical data

<b>Input data</b>	Resistance thermometers Resistor Cable resistance Sensor input current Measuring range span	
<b>Output data</b>	Output signal Load Behavior in the event of a sensor error Output ripple	
<b>General data</b>	Supply voltage range Current draw Power dissipation Temperature coefficient Step response (0–99%)	
	Transmission error, total ZERO / SPAN adjustment Electrical isolation	
	Ambient temperature range Humidity Status indication	
	Inflammability class in acc. with UL 94 Dimensions W / H / D Screw connection solid / stranded / AWG Push-in connection solid / stranded / AWG EMC note	
	<b>Safety data as per ATEX</b> Max. output voltage $U_o$ Max. output current $I_o$ Max. output power $P_o$	
	<b>Conformance / approvals</b> Conformance ATEX	
	IECEX UL, USA / Canada SIL in accordance with IEC 61508	
	<b>Input/output power supply</b>	300 V <sub>rms</sub> (rated insulation voltage (surge voltage category II); pollution degree 2, safe isolation as per EN 61010-1) 2.5 kV (50 Hz, 1 min., test voltage)
	<b>Input/output power supply</b>	375 V (peak value in accordance with EN 60079-11) 375 V (peak value in accordance with EN 60079-11) -20 °C ... 60 °C (any mounting position) 5% ... 95% (non-condensing) Green LED (supply voltage, PWR) Red LED, flashing (line, sensor error, ERR) Red LED (module error, ERR) V0 12.5 / 99 / 114.5 mm 0.2 ... 2.5 mm <sup>2</sup> / 0.2 ... 2.5 mm <sup>2</sup> / 24 - 14 0.2 ... 1.5 mm <sup>2</sup> / 0.2 ... 1.5 mm <sup>2</sup> / 24 - 16 Class A product, see page 625
	<b>Safety data as per ATEX</b> Max. output voltage $U_o$ Max. output current $I_o$ Max. output power $P_o$	6 V 6.3 mA 9.4 mW
	<b>Conformance / approvals</b> Conformance ATEX	CE-compliant, additionally EN 61326 Ex II (1) G [Ex ia Ga] IIC Ex II (1) D [Ex ia Da] IIIC Ex II 3(1) G Ex nA ic [ia Ga] IIC T4 Gc X [Ex ia Ga] IIC, [Ex ia Da] IIIC, Ex nA ic [ia Ga] IIC T4 Gc Class I Div 2; IS for Class I, II, III Div 1 2

Programmable temperature transducer for intrinsically safe operation of resistance thermometers and resistance-type sensors installed in Ex areas. The measured values are converted into a linear 0 ... 20 mA or 4 ... 20 mA signal.

- Input for resistance thermometers and resistance-type sensors, [Ex ia]
- 0 ... 20 mA or 4 ... 20 mA output
- Configuration via software (FDT/DTM): Sensor type, connection method, measuring range, measuring unit, filter, alarm signal, and output range
- Programming during operation with Ex measuring circuit connected and also voltage-free using IFS-USB-PROG-ADAPTER programming adapter
- Status indicator for supply voltage, cable, sensor, and module errors
- 3-way electrical isolation
- Power supply via DIN rail connector possible
- Up to SIL 2 according to IEC 61508
- Installation in zone 2 permitted

<b>Notes:</b>
To order a product with an order configuration, please enter the desired configuration by referring to the order key, see page 197
The configuration software can be downloaded from the Internet (phoenixcontact.net/products).
Information about the power and fault signaling module as well as about the DIN rail connectors and marking material can be found from page 213
For information on the programming adapter, refer to page 89
Information on Plug and Play connection using system cabling can be found from page 216

Description	
<b>Temperature transducer for resistance thermometers, intrinsically safe input</b>	
Order configuration	Screw connection
Order configuration	Push-in connection
Standard configuration	Screw connection
Standard configuration	Push-in connection

<b>Programming adapter</b> for configuring modules with S-PORT interface	
--	--

Ordering data

Type	Order No.	Pcs. / Pkt.
MACX MCR-EX-SL-RTD-I	2865939	1
MACX MCR-EX-SL-RTD-I-SP	2924142	1
MACX MCR-EX-SL-RTD-I-NC	2865573	1
MACX MCR-EX-SL-RTD-I-SP-NC	2924168	1

Accessories

IFS-USB-PROG-ADAPTER	2811271	1
----------------------	---------	---



Temperature  
Temperature transducer, Ex i

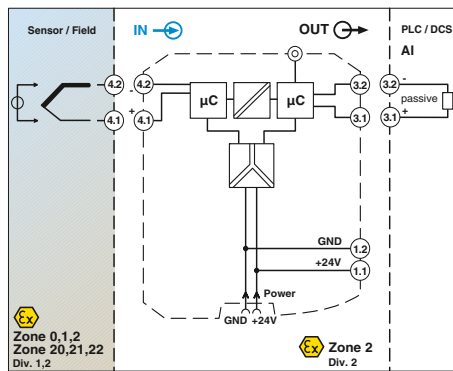
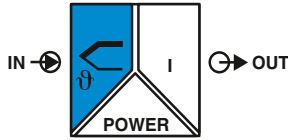

For thermocouples and mV sources

Housing width 12.5 mm

Programmable temperature transducer for intrinsically safe operation of thermocouples and mV sources installed in Ex areas. The measured values are converted into a linear 0 ... 20 mA or 4 ... 20 mA signal.

- Input for thermocouples and mV sources, [Ex ia]
- 0 ... 20 mA or 4 ... 20 mA output
- Configuration via software (FDT/DTM): Sensor type, connection method, measuring range, measuring unit, filter, alarm signal, and output range
- Programming during operation with Ex measuring circuit connected and also voltage-free using IFS-USB-PROG-ADAPTER programming adapter
- Status indicator for supply voltage, cable, sensor, and module errors
- 3-way electrical isolation
- Power supply via DIN rail connector possible
- Up to SIL 2 according to IEC 61508
- Installation in zone 2 permitted

Notes:
To order a product with an order configuration, please enter the desired configuration by referring to the order key, see page 197
The configuration software can be downloaded from the Internet ( <a href="http://phoenixcontact.net/products">phoenixcontact.net/products</a> ).
Information about the power and fault signaling module as well as about the DIN rail connectors and marking material can be found from page 213
For information on the programming adapter, refer to page 89
Information on Plug and Play connection using system cabling can be found from page 216

<b>Input data</b>	Thermocouple sensors
<b>Voltage</b>	Measuring range span
<b>Output data</b>	Output signal Load Behavior in the event of a sensor error Output ripple
<b>General data</b>	Supply voltage range Current consumption Power dissipation Temperature coefficient Step response (0-99%)
<b>Transmission error, total</b>	Cold junction errors ZERO / SPAN adjustment Electrical isolation
<b>Ambient temperature range</b>	Humidity Status indication
<b>Housing material</b>	Inflammability class in acc. with UL 94 Dimensions W / H / D Screw connection solid / stranded / AWG EMC note
<b>Safety data as per ATEX</b>	Max. output voltage $U_o$ Max. output current $I_o$ Max. output power $P_o$ Maximum voltage $U_m$
<b>Conformance / approvals</b>	Conformance / approvals ATEX
<b>IECEX</b>	IECEX UL, USA / Canada SIL in accordance with IEC 61508

Technical data	
E, J, K, N as per IEC / EN 60584, L as per DIN 43760	
-20 mV ... 70 mV Min. 50 K for thermocouples, 3 mV for mV sources	
0 mA ... 20 mA / 4 mA ... 20 mA $\leq 500 \Omega$ As per NE 43 or can be freely defined $< 50 \mu A_{pp}$	
19.2 V DC ... 30 V DC (24 V DC (-20% ... +25%)) $< 40 \text{ mA}$ (24 V DC) $< 1 \text{ W}$ 0.01 %/K typ. 800 ms (with SIL) max. 1200 ms (with SIL) typ. 700 ms (without SIL) max. 1100 ms (without SIL)	
0.05% x 200 [K]/Measuring range span [K] + 0.05% $\pm 1 \text{ K}$ $\pm 5 \% / \pm 5 \%$	
300 V $U_{rms}$ (rated insulation voltage (surge voltage category II; pollution degree 2, safe isolation as per EN 61010-1)) 2.5 kV (50 Hz, 1 min., test voltage)	
375 V (peak value in accordance with EN 60079-11) 375 V (peak value in accordance with EN 60079-11) -20 °C ... 60 °C (any mounting position) 5% ... 95% (non-condensing) Green LED (supply voltage, PWR) Red LED, flashing (line, sensor error, ERR) Red LED (module error, ERR) PA 66-FR V0 12.5 / 99 / 114.5 mm 0.2 ... 2.5 mm <sup>2</sup> / 0.2 ... 2.5 mm <sup>2</sup> / 24 - 14 Class A product, see page 625	
6 V 4.7 mA 7 mW 253 V AC (125 V DC)	
CE-compliant, additionally EN 61326 Ex II (1) G [Ex ia Ga] IIC Ex II (1) D [Ex ia Da] IIIC Ex II 3(1) G Ex nA ic [ia Ga] IIC T4 Gc X [Ex ia Ga] IIC, [Ex ia Da] IIIC, Ex nA ic [ia Ga] IIC T4 Gc Class I Div 2; IS for Class I, II, III Div 1 2	

Description	Order configuration	Standard configuration
Temperature transducer for thermocouples, intrinsically safe input	Screw connection	Screw connection

Programming adapter for configuring modules with S-PORT interface

Ordering data		
Type	Order No.	Pcs. / Pkt.
MACX MCR-EX-SL-TC-I	2865942	1
MACX MCR-EX-SL-TC-I-NC	2865586	1
Accessories		
IFS-USB-PROG-ADAPTER	2811271	1

**Order key and temperature ranges for the MACX MCR-EX-SL-RTD-I(-SP) temperature transducer**

Order key for MACX MCR-EX-SL-RTD-I(-SP) temperature transducer (standard configuration entered as an example)

Order No.	Sensor type	Safety integrity level (SIL)	Connection technology	Measuring range:		Measuring unit	Output range	Filter Oversampling	Filter Moving average value
				Start	End				
<b>2865939</b>	<b>PT100</b>	<b>ON</b>	<b>3</b>	<b>0</b>	<b>100</b>	<b>C</b>	<b>OUT02</b>	<b>10</b>	<b>1</b>
2865939 ≙ MACX MCR-EX-SL-RTD-I	See below	ON ≙ active NONE ≙ not active	2 ≙ 2-wire 3 ≙ 3-wire 4 ≙ 4-wire	see below	see below	C ≙ °C F ≙ °F O ≙ Ω	OUT01 ≙ 0 ... 20 mA OUT02 ≙ 4 ... 20 mA	1 ≙ 1 value 3 ≙ 3 values 5 ≙ 5 values 7 ≙ 7 values 10 ≙ 10 values 20 ≙ 20 values	1 ≙ 1 value 2 ≙ 2 values 3 ≙ 3 values 4 ≙ 4 values
2924142 ≙ MACX MCR-EX-SL-RTD-I-SP		ON only with output range = OUT02							
				<b>Smallest measuring range span</b>					
RES01 ≙ Resistor				0	2000	Ω	25 Ω		
PT50 ≙ Pt 50 acc. to IEC 751				-200	850	°C	50 K		
PT100 ≙ Pt 100 acc. to IEC 751				-200	850	°C	50 K		
PT200 ≙ Pt 200 acc. to IEC 751				-200	850	°C	50 K		
PT500 ≙ Pt 500 acc. to IEC 751				-200	850	°C	50 K		
PT100S ≙ Pt 100 acc. to Sama RC21-4-1966				-200	600	°C	50 K		
PT500S ≙ Pt 500 acc. to Sama RC21-4-1966				-200	600	°C	50 K		
NI100DIN ≙ Ni 100 acc. to DIN 43760				-60	250	°C	50 K		
NI500DIN ≙ Ni 500 acc. to DIN 43760				-60	250	°C	50 K		
CU50 ≙ CU50 acc. to GOST 6651 (α = 1.428)				-50	200	°C	50 K		
CU53 ≙ CU53 acc. to GOST 6651 (α = 1.426)				-50	180	°C	50 K		
<b>Alarm signal</b>		<b>Alarm signal</b>		<b>Factory calibration certificate = FCC</b>					
Short circuit/overrange		Sensor break/underrange							
...	<b>I035</b>	<b>I215</b>	<b>NONE</b>	<b>Temperature conversion guide for °C to °F:</b>					
	I000 ≙ 0 mA I035 ≙ 3.5 mA I215 ≙ 21.5 mA	I000 ≙ 0 mA I035 ≙ 3.5 mA I215 ≙ 21.5 mA	NONE ≙ without FCC Yes ≙ with FCC (a fee is charged) YESPLUS ≙ FCC with 5 measuring points (a fee is charged)	$T [°F] = \frac{9}{5} T [°C] + 32$					
	I035 only with output range = OUT02								
	Alarm signals can also be configured individually using software.								

**Order key and temperature ranges for the MACX MCR-EX-SL-TC-I temperature transducer**

Order key for MACX MCR-EX-SL-TC-I temperature transducer (standard configuration entered as an example)

Order No.	Sensor type	Safety integrity level (SIL)	Cold junction compensation	Measuring range:		Measuring unit	Output range	Filter Oversampling	Filter Moving average value
				Start	End				
<b>2924942</b>	<b>J</b>	<b>ON</b>	<b>1</b>	<b>0</b>	<b>1000</b>	<b>C</b>	<b>OUT02</b>	<b>10</b>	<b>1</b>
MACX MCR-EX-SL-TC-I	see below	ON ≙ active NONE ≙ Not active	1 ≙ Enabled 0 ≙ switched off (e.g., for mV voltage measurement)	see below	see below	C ≙ °C F ≙ °F V ≙ mV	OUT01 ≙ 0 ... 20 mA OUT02 ≙ 4 ... 20 mA	1 ≙ 1 value 3 ≙ 3 values 5 ≙ 5 values 7 ≙ 7 values 10 ≙ 10 values 20 ≙ 20 values	1 ≙ 1 value 2 ≙ 2 values 3 ≙ 3 values 4 ≙ 4 values
				<b>Smallest measuring range span</b>					
V03 ≙ Voltage (mV)				-20	+70	mV	3 mV		
E ≙ acc. to IEC 584-1 (NiCr-CuNi)				-250	1000	°C	50 K		
J ≙ acc. to IEC 584-1 (Fe-CuNi)				-210	1200	°C	50 K		
K ≙ acc. to IEC 584-1 (NiCr-Ni)				-250	1372	°C	50 K		
N ≙ acc. to IEC 584-1 (NiCrSi-NiSi)				-250	1300	°C	50 K		
L ≙ acc. to DIN 43760 (Fe-CuNi)				-200	900	°C	50 K		
<b>Alarm signal</b>		<b>Alarm signal</b>		<b>Factory calibration certificate = FCC</b>					
Overrange		Sensor break/underrange							
...	<b>I035</b>	<b>I215</b>	<b>NONE</b>	<b>Temperature conversion guide for °C to °F:</b>					
	I000 ≙ 0 mA I035 ≙ 3.5 mA I215 ≙ 21.5 mA	I000 ≙ 0 mA I035 ≙ 3.5 mA I215 ≙ 21.5 mA	NONE ≙ without FCC Yes ≙ with FCC (a fee is charged) YESPLUS ≙ FCC with 5 measuring points (a fee is charged)	$T [°F] = \frac{9}{5} T [°C] + 32$					
	I035 only with output range = OUT02								
	Alarm signals can also be configured individually using software.								

Temperature  
Temperature transducer, Ex i

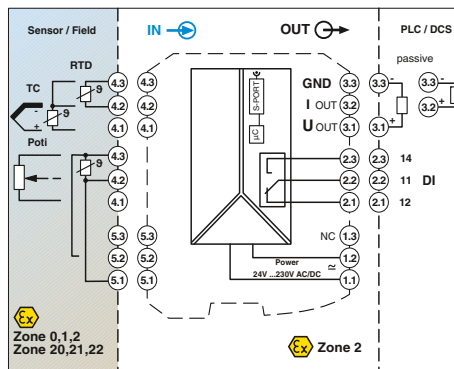
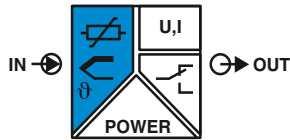

Universal, with switching output, wide range power supply

Functional Safety  
Ex: Ex, Ex, Ex  
Housing width 17.5 mm

Technical data

Universal temperature transducer with freely configurable properties for intrinsically safe operation of resistance thermometers, thermocouples, resistance-type sensors, and potentiometers installed in Ex areas

- Input for resistance thermometers, thermocouples, resistance-type sensors, potentiometers, and mV sources, [Ex ia]
- Measure differential temperatures
- Freely programmable input and output
- Option of inverse output signal ranges
- Relay switching output
- Configuration via software (FDT-DTM) or IFS-OP-UNIT operating and display unit
- Programming during operation with Ex measuring circuit connected and also voltage-free using IFS-USB-PROG-ADAPTER programming adapter
- Plug-in screw or push-in connection technology
- Cold junction compensation with separate connector
- Wide range power supply: 19.2 ... 253 V AC/DC
- Status indicator for supply voltage, cable, sensor, and module errors
- Up to SIL 2 according to IEC 61508
- Installation in zone 2 permitted

<b>Input data</b>	Resistance thermometers Thermocouple sensors
Resistor Potentiometer Voltage	0 Ω ... 50 kΩ 0 Ω ... 50 kΩ -1000 mV ... 1000 mV
<b>Output data</b>	U output I output
Output signal	4 mA ... 20 mA (in the case of SIL; further free configuration without SIL)
Maximum output signal Load R <sub>B</sub>	± 11 V ≥ 10 kΩ
Behavior in the event of a sensor error	22 mA ≤ 600 Ω (20 mA)
<b>Switching output</b>	according to NE 43 or freely configurable
Contact type Contact material	Switching output 1 PDT AgSnO <sub>2</sub> , hard gold-plated
Max. switching voltage Max. switching current	30 V AC (30 V DC) 0.5 A (30 V AC) / 1 A (30 V DC)
<b>General data</b>	
Supply voltage range Power consumption Temperature coefficient Transmission error, total Electrical isolation	24 V ... 230 V AC/DC (-20%/+10%, 50/60 Hz) < 1.5 W 0.01 %/K < 0.1 % (e.g., for Pt 100, 300 K span, 4 ... 20 mA)
Ambient temperature range Humidity Housing material Inflammability class in acc. with UL 94 Dimensions W / H / D Screw connection solid / stranded / AWG Push-in connection solid / stranded / AWG	2.5 kV (50 Hz, 1 min., test voltage) 375 V (peak value in accordance with EN 60079-11) 375 V (peak value in accordance with EN 60079-11) 375 V (peak value in accordance with EN 60079-11) 300 V <sub>rms</sub> (rated insulation voltage (surge voltage category II; pollution degree 2, safe isolation as per EN 61010-1))
EMC note	-20 °C ... 65 °C typ. 5 % ... 95 % (non-condensing) PA 66-FR V0 17.5 / 99 / 114.5 mm 0.2 ... 2.5 mm <sup>2</sup> / 0.2 ... 2.5 mm <sup>2</sup> / 24 - 14 0.2 ... 1.5 mm <sup>2</sup> / 0.2 ... 1.5 mm <sup>2</sup> / 24 - 16 Class A product, see page 625
<b>Safety data as per ATEX</b>	
Max. output voltage U <sub>o</sub> Max. output current I <sub>o</sub> Max. output power P <sub>o</sub>	6 V 7.4 mA 11 mW
<b>Conformance / approvals</b>	
Conformance ATEX	CE-compliant Ex II (1) G [Ex ia Ga] IIC Ex II (1) D [Ex ia Da] IIIC Ex II 3 G Ex nA nC ic IIC T4 Gc X [Ex ia Ga] IIC, [Ex ia Da] IIIC, Ex nA nC ic IIC T4 Gc X 2
IECEX SIL in accordance with IEC 61508	

<b>Notes:</b>
To order a product with an order configuration, enter the required configuration by referring to the adjacent order key.
The configuration software can be downloaded from the Internet (phoenixcontact.net/products).
Information on the IFS-OP-UNIT operating and display unit and the associated IFS-OP-CRADLE DIN rail cradle can be found on page 170
For information on the programming adapter, refer to page 89

<b>Description</b>	
<b>Temperature transducer, intrinsically safe input</b>	
Standard configuration	Screw connection
Standard configuration	Push-in connection
Order configuration	Screw connection
Order configuration	Push-in connection

**Programming adapter** for configuring modules with S-PORT interface

<b>Ordering data</b>		
<b>Type</b>	<b>Order No.</b>	<b>Pcs. / Pkt.</b>
MACX MCR-EX-T-UI-UP	2865654	1
MACX MCR-EX-T-UI-UP-SP	2924689	1
MACX MCR-EX-T-UI-UP-C	2811763	1
MACX MCR-EX-T-UI-UP-SP-C	2924692	1
<b>Accessories</b>		
IFS-USB-PROG-ADAPTER	2811271	1

Ex i signal conditioners with SIL functional safety - MACX Analog Ex

Order key for MACX MCR-EX-T-UI-UP(-SP)-C temperature transducer (standard configuration entered as an example)

Order No.	Safety integrity level (SIL)	Sensor type	Connection technology	Cold junction compensation	Measuring range:		Measuring unit	Output range	Factory calibration certificate = FCC
					Start	End			
2811763	ON	PT100	4	0	-50	150	C	OUT02	NONE
2811763 ≙ MACX MCR-EX-T-UI-UP-C	ON ≙ Active NONE ≙ not active	See below	2 ≙ 2-wire 3 ≙ 3-wire 4 ≙ 4-wire	0 ≙ off, e.g., with RTD, R, potentiometer, mV 1 ≙ on, e.g., with TC	see below	see below	C ≙ °C F ≙ °F O ≙ Ω P ≙ % V ≙ mV	OUT15 ≙ 0 ... 5 mA OUT16 ≙ 0 ... 10 mA OUT01 ≙ 0 ... 20 mA OUT15 ≙ 0 ... 5 mA OUT25 ≙ 1 ... 5 mA OUT26 ≙ 2 ... 10 mA OUT02 ≙ 4 ... 20 mA OUT05 ≙ 0 - 5 V DC OUT03 ≙ 0...10 V OUT06 ≙ 1...5 V OUT04 ≙ 2...10 V OUT13 ≙ -5...+5 V OUT14 ≙ -10...+10 V Others can be freely configured in the software	NONE ≙ without FCC YES ≙ with FCC (a fee is charged) YESPLUS ≙ FCC with 5 measuring points (a fee is charged)
2924692 ≙ MACX MCR-EX-T-UI-UP-SP-C	ON only with output range = OUT02								
<b>Resistance thermometers (RTD)</b> Others can be selected or freely configured in the software.		PT100 ≙ Pt 100 acc. to IEC 751			-200	850	°C	20 K	<b>Other setting options can be configured with the IFS-CONF software:</b> - Freely configurable user characteristic curve with 30 interpolation points - Output behavior in the event of a short circuit, sensor break or overrange/underrange can be freely configured or set acc. to NE43 (standard configuration: NE43 upscale) - Filter setting (standard configuration: 1) - Restart after failsafe (standard configuration: ON) - Switching behavior: switching output (limit values, times, etc.) (standard configuration: OFF)
	PT200 ≙ Pt 200 acc. to IEC 751			-200	850	°C	20 K		
	PT500 ≙ Pt 500 acc. to IEC 751			-200	850	°C	20 K		
	PT1000 ≙ Pt 1000 acc. to IEC 751			-200	850	°C	20 K		
	PT100S ≙ Pt 100 acc. to Sama RC21-4-1966			-200	850	°C	20 K		
	PT1000S ≙ Pt 1000 acc. to Sama RC21-4-1966			-200	850	°C	20 K		
	PT100G ≙ Pt 100 acc. to GOST 6651-2009 (α = 0.00385)			-200	850	°C	20 K		
	PT1000G ≙ Pt 1000 acc. to GOST 6651-2009 (α = 0.00385)			-200	850	°C	20 K		
	PT100J ≙ Pt 100 acc. to JIS C1604/1997			-200	850	°C	20 K		
	PT1000J ≙ Pt 1000 acc. to JIS C1604/1997			-200	850	°C	20 K		
	NI100 ≙ Ni 100 acc. to DIN 43760/DIN IEC 60751			-60	250	°C	20 K		
	NI1000 ≙ Ni 1000 acc. to DIN 43760/DIN IEC 60751			-60	250	°C	20 K		
	NI100S ≙ Ni 100 acc. to Sama RC21-4-1966			-60	180	°C	20 K		
	NI1000S ≙ Ni 1000 acc. to Sama RC21-4-1966			-60	180	°C	20 K		
	NI1000L ≙ Ni 1000 (Landis & Gyr)			-50	160	°C	20 K		
	CU10 ≙ Cu 10 acc. to Sama RC21-4-1966			-70	500	°C	100 K		
	CU50 ≙ Cu 50 acc. to GOST 6651-2009 (α = 0.00428)			-50	200	°C	100 K		
	CU100 ≙ Cu 100 acc. to GOST 6651-20091 (α = 0.00428)			-50	200	°C	100 K		
	CU53 ≙ Cu 53 acc. to GOST 6651-2009 (α = 0.00426)			-50	180	°C	100 K		
	KTY81 ≙ KTY81-110 (Philips)			-55	150	°C	20 K		
	KTY84 ≙ KTY84-130 (Philips)			-40	300	°C	20 K		
<b>Thermocouples (TC)</b> Others can be selected in the software.		B ≙ acc. to IEC 584-1 (Pt30Rh-Pt6Rh)			500	1820	°C	50 K	
	E ≙ acc. to IEC 584-1 (NiCr-CuNi)			-230	1000	°C	50 K		
	J ≙ acc. to IEC 584-1 (Fe-CuNi)			-210	1200	°C	50 K		
	K ≙ acc. to IEC 584-1 (NiCr-Ni)			-250	1372	°C	50 K		
	N ≙ acc. to IEC 584-1 (NiCrSi-NiSi)			-250	1300	°C	50 K		
	R ≙ acc. to IEC 584-1 (Pt13Rh-Pt)			-50	1768	°C	50 K		
	S ≙ acc. to IEC 584-1 (Pt10Rh-Pt)			-50	1768	°C	50 K		
	T ≙ acc. to IEC 584-1 (Cu-CuNi)			-200	400	°C	50 K		
	L ≙ acc. to DIN 43760 (Fe-CuNi)			-200	900	°C	50 K		
	U ≙ acc. to DIN 43760 (Cu-CuNi)			-200	600	°C	50 K		
	CA ≙ C ASTM JE988 (2002)			0	2315	°C	50 K		
	DA ≙ D ASTM JE988 (2002)			0	2315	°C	50 K		
	A1G ≙ A-1 GOST 8.585-2001			0	2500	°C	50 K		
	A2G ≙ A-2 GOST 8.585-2001			0	1800	°C	50 K		
	A3G ≙ A-3 GOST 8.585-2001			0	1800	°C	50 K		
	MG ≙ M GOST 8.585-2001			-200	100	°C	50 K		
	LG ≙ L GOST 8.585-2001			-200	800	°C	50 K		
<b>Remote resistance-type sensors (R) (2, 3, 4-wire)</b> Others can be selected in the software.		RES03 ≙ 0...150 Ω resistor			0	150	Ω	10% of the selected measuring range	
	RES05 ≙ 0...600 Ω resistor			0	600	Ω			
	RES06 ≙ 0...1200 Ω resistor			0	1200	Ω			
	RES09 ≙ 0...6250 Ω resistor			0	6250	Ω			
	RES10 ≙ 0...12500 Ω resistor			0	12500	Ω			
	RES12 ≙ 0...50000 Ω resistor			0	50000	Ω			
<b>Potentiometers (3-wire)</b> Others can be selected in the software.		POT03 ≙ 0...150 Ω potentiometer			0	100	%	10% of the selected measuring range	
	POT05 ≙ 0...600 Ω potentiometer			0	100	%			
	POT06 ≙ 0...1200 Ω potentiometer			0	100	%			
	POT09 ≙ 0...6250 Ω potentiometer			0	100	%			
	POT10 ≙ 0...12500 Ω potentiometer			0	100	%			
	POT12 ≙ 0...50000 Ω potentiometer			0	100	%			
<b>Voltage signals (mV)</b> Others can be selected in the software.		V04 ≙ Voltage (mV)			-1000	+1000	mV	10% of nominal span	

Temperature conversion guide for °C to °F:

$$T [°F] = \frac{9}{5} T [°C] + 32$$

Temperature  
Temperature transducer, Ex i

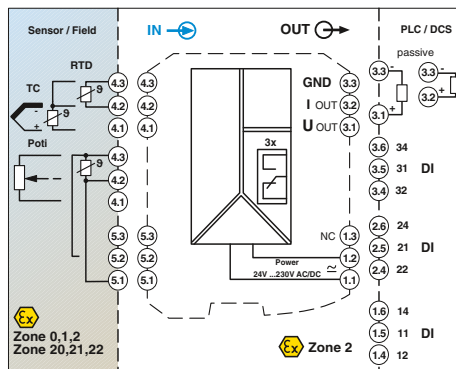
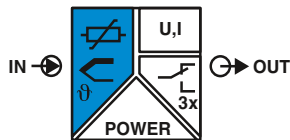

Universal, with three limit value relays,  
wide range power supply

Functional Safety  
Ex: Ex, IEC 61508  
Housing width 35 mm

Universal temperature transducer with freely configurable properties for intrinsically safe operation of resistance thermometers, thermocouples, resistance-type sensors, and potentiometers installed in Ex areas

- Input for resistance thermometers, thermocouples, resistance-type sensors, potentiometers, and mV sources, [Ex ia]
- Measure differential temperatures
- Freely programmable input and output
- Option of inverse output signal ranges
- Three limit value relays, can be used in combination as a safe limit value relay
- Configuration via software (FDT-DTM) or IFS-OP-UNIT operating and display unit
- Programming during operation with Ex measuring circuit connected and also voltage-free using IFS-USB-PROG-ADAPTER programming adapter
- Plug-in screw or push-in connection technology
- Cold junction compensation with separate connector
- Wide range power supply: 19.2 ... 253 V AC/DC
- Status indicator for supply voltage, cable, sensor, and module errors
- Up to SIL 2 according to IEC 61508
- Installation in zone 2 permitted

<b>Input data</b>	Resistance thermometers Thermocouple sensors
Resistor Potentiometer Voltage	
<b>Output data</b>	Output signal
Maximum output signal Load $R_B$ Behavior in the event of a sensor error	
<b>Switching output</b>	Contact type Contact material Max. switching voltage Max. switching current
<b>General data</b>	Supply voltage range Power consumption Temperature coefficient Maximum transmission error Electrical isolation
<b>Input/output/power supply</b>	Input/output Input/power supply Input/switching output Output/supply
Ambient temperature range Humidity Housing material Inflammability class in acc. with UL 94 Dimensions W / H / D Screw connection solid / stranded / AWG Push-in connection solid / stranded / AWG EMC note	
<b>Safety data as per ATEX</b>	Max. output voltage $U_o$ Max. output current $I_o$ Max. output power $P_o$
<b>Conformance / approvals</b>	Conformance ATEX
IECEX SIL in accordance with IEC 61508	

**Technical data**

Pt, Ni, Cu sensors: 2, 3, 4-wire  
B, E, J, K, N, R, S, T, L, U, CA, DA, A1G, A2G, A3G, MG, LG

0  $\Omega$  ... 50 k $\Omega$   
0  $\Omega$  ... 50 k $\Omega$   
-1000 mV ... 1000 mV  
U output I output  
0 mA ... 20 mA  $\pm$ 10 V  
(in the case of SIL; further free configuration without SIL)  
 $\pm$  11 V 22 mA  
 $\geq$  10 k $\Omega$   $\leq$  600  $\Omega$  (20 mA)  
according to NE 43 or freely configurable

**Relay output**  
3 PDTs  
AgSnO<sub>2</sub>, hard gold-plated  
250 V AC (250 V DC)  
2 A (250 V AC) / 2 A (28 V DC)

24 V ... 230 V AC/DC (-20%/+10%, 50/60 Hz)  
< 2.4 W  
0.01 %/K  
0.1 % (e.g. for Pt 100, 300 K span, 4 ... 20 mA)

2.5 kV (50 Hz, 1 min., test voltage)  
375 V (peak value in accordance with EN 60079-11)  
375 V (peak value in accordance with EN 60079-11)  
375 V (peak value in accordance with EN 60079-11)  
300 V<sub>rms</sub> (rated insulation voltage (surge voltage category II; pollution degree 2, safe isolation as per EN 61010-1))

-20 °C ... 65 °C  
typ. 5 % ... 95 % (non-condensing)  
PA 66-FR  
V0  
35 / 99 / 114.5 mm  
0.2 ... 2.5 mm<sup>2</sup> / 0.2 ... 2.5 mm<sup>2</sup> / 24 - 14  
0.2 ... 1.5 mm<sup>2</sup> / 0.2 ... 1.5 mm<sup>2</sup> / 24 - 16  
Class A product, see page 625

6 V  
7.4 mA  
11 mW

CE-compliant  
Ex II (1) G [Ex ia Ga] IIC  
Ex II (1) D [Ex ia Da] IIIC  
Ex II 3 G Ex nA nC ic IIC T4 Gc X  
[Ex ia Ga] IIC, [Ex ia Da] IIIC, Ex nA nC ic IIC T4 Gc X  
2

<b>Notes:</b>
To order a product with an order configuration, enter the required configuration by referring to the adjacent order key.
The configuration software can be downloaded from the Internet (phoenixcontact.net/products).
Information on the IFS-OP-UNIT operating and display unit and the associated IFS-OP-CRADLE DIN rail cradle can be found on page 170
For information on the programming adapter, refer to page 89

Description	<b>Temperature transducer</b> , intrinsically safe input
Standard configuration	Screw connection
Standard configuration	Push-in connection

**Programming adapter** for configuring modules with S-PORT interface

**Ordering data**

Type	Order No.	Pcs. / Pkt.
MACX MCR-EX-T-UIREL-UP	2865751	1
MACX MCR-EX-T-UIREL-UP-SP	2924799	1

**Accessories**

IFS-USB-PROG-ADAPTER	2811271	1
----------------------	---------	---



Digital IN  
NAMUR signal conditioner, Ex i

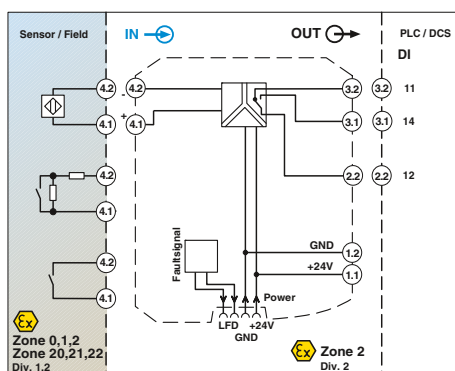
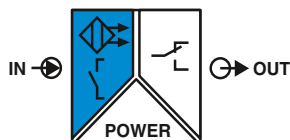

Signal output: PDT relay

Functional Safety

Ex: Ex i

Housing width 12.5 mm

Technical data

Input data  
Input signal

No-load voltage  
Switching points  
Switching hysteresis  
Line fault detection

Switching output

Contact type  
Contact material  
Max. switching voltage  
Max. switching capacity  
Recommended minimum load  
Mechanical service life  
Switching behavior  
Max. switching frequency

General data

Supply voltage range  
Current consumption  
Power dissipation  
Number of channels  
Electrical isolation

Input/output  
Input/output/supply, DIN rail connector

Ambient temperature range  
Humidity  
Status indication

Housing material  
Inflammability class in acc. with UL 94  
Dimensions W / H / D  
Screw connection solid / stranded / AWG  
Push-in connection solid / stranded / AWG  
EMC note

Safety data as per ATEX

Max. output voltage  $U_o$   
Max. output current  $I_o$   
Max. output power  $P_o$   
Maximum voltage  $U_m$

Conformance / approvals

Conformance  
ATEX

IECEX  
UL, USA / Canada  
SIL in accordance with IEC 61508

NAMUR proximity sensors (EN 60947-5-6)  
Floating switch contacts  
Switch contacts with resistance circuit  
~ 8 V DC  
> 2.1 mA (conductive) / < 1.2 mA (blocking)  
< 0.2 mA  
Break 0.05 mA < I<sub>IN</sub> < 0.35 mA  
Short circuit 100 Ω < R<sub>Sensor</sub> < 360 Ω  
Relay output  
1 PDT  
AgSnO<sub>2</sub>, hard gold-plated  
250 V AC (2 A) / 120 V DC (0.2 A) / 30 V DC (2 A)  
500 VA  
5 V / 10 mA  
10<sup>7</sup> cycles  
Can be inverted via slide switch  
≤ 20 Hz (without load)

19.2 V DC ... 30 V DC (24 V DC (-20% ... +25%))  
21 mA (24 V DC)  
< 650 mW  
1

375 V (peak value in accordance with EN 60079-11)  
300 V<sub>rms</sub> (rated insulation voltage (surge voltage category II; pollution degree 2, safe isolation as per EN 61010-1))  
2.5 kV (50 Hz, 1 min., test voltage)

Input/supply, DIN rail connector  
375 V (peak value in accordance with EN 60079-11)  
-20 °C ... 60 °C (any mounting position)  
10 % ... 95 % (non-condensing)

Green LED (supply voltage)  
Yellow LED (switching state)  
Red LED (line fault)  
PA 66-FR  
V0  
12.5 / 99 / 114.5 mm  
0.2 ... 2.5 mm<sup>2</sup> / 0.2 ... 2.5 mm<sup>2</sup> / 24 - 14  
0.2 ... 1.5 mm<sup>2</sup> / 0.2 ... 1.5 mm<sup>2</sup> / 24 - 16  
Class A product, see page 625

9.6 V  
10 mA  
25 mW  
253 V AC (125 V DC)

CE-compliant, additionally EN 61326  
Ex II (1) G [Ex ia Ga] IIC  
Ex II (1) D [Ex ia Da] IIIC  
[Ex ia Ga] IIC, [Ex ia Da] IIIC, Ex nA nC IIC T4 Gc  
Class I Div 2; IS for Class I, II, III Div 1  
2

Ordering data

Description

NAMUR signal conditioner, 1-channel, intrinsically safe input, output: PDT contact

Screw connection  
Push-in connection

Type	Order No.	Pcs. / Pkt.
MACX MCR-EX-SL-NAM-R	2865434	1
MACX MCR-EX-SL-NAM-R-SP	2924045	1

Notes:

Information about the power and fault signaling module as well as about the DIN rail connectors and marking material can be found from page 213

Information about resistance circuits is given on page 180

Information on Plug and Play connection using system cabling can be found from page 216



Digital IN  
NAMUR signal conditioner, Ex i

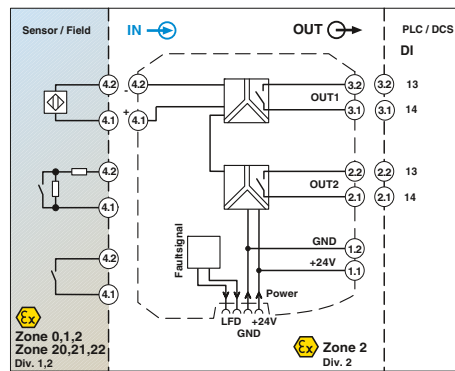
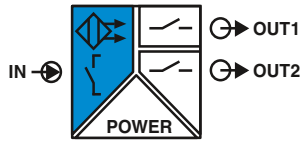

2 signal outputs: N/O contact relay

Functional Safety  
Ex: i, [Ex ia] IIC  
Housing width 12.5 mm

Technical data

NAMUR signal conditioner for intrinsically safe operation of proximity sensors and mechanical contacts installed in Ex areas.

- Input for NAMUR proximity sensors (EN 60947-5-6), floating contacts or contacts with resistance circuit, [Ex ia]
- Two relay signal outputs (N/O contact); output 2 can be used as an error message output
- Reversible direction of action (operating current or closed-circuit current behavior)
- Line fault detection (LFD), can be activated/deactivated, error message signaled by red flashing LED with de-excitation of output relay
- Power supply and error indication possible via the DIN rail connector
- LED displays for indicating supply voltage, circuit state, and malfunctions to NAMUR NE 44
- 4-way electrical isolation
- Up to SIL 2 according to IEC 61508
- Installation in zone 2 permitted

<b>Notes:</b>
Information about the power and fault signaling module as well as about the DIN rail connectors and marking material can be found from page 213
Information about resistance circuits is given on page 180
Information on Plug and Play connection using system cabling can be found from page 216

<b>Input data</b>	Input signal
No-load voltage	
Switching points	
Switching hysteresis	
Line fault detection	
<b>Switching output</b>	
Contact type	
Contact material	
Max. switching voltage	
Max. switching capacity	
Recommended minimum load	
Mechanical service life	
Switching behavior	
Max. switching frequency	
<b>General data</b>	
Supply voltage range	
Current consumption	
Power dissipation	
Number of channels	
Electrical isolation	
	Input/output
	Input/supply, DIN rail connector
	Output 1/output 2/input, power supply, DIN rail connector
	Output 1/output 2/input/power supply, DIN rail connector
Ambient temperature range	
Humidity	
Status indication	
Housing material	
Inflammability class in acc. with UL 94	
Dimensions W / H / D	
Screw connection solid / stranded / AWG	
Push-in connection solid / stranded / AWG	
EMC note	
<b>Safety data as per ATEX</b>	
Max. output voltage $U_o$	
Max. output current $I_o$	
Max. output power $P_o$	
Maximum voltage $U_m$	
<b>Conformance / approvals</b>	
Conformance	
ATEX	
IECEX	
UL, USA / Canada	
SIL in accordance with IEC 61508	

NAMUR proximity sensors (EN 60947-5-6)
Floating switch contacts
Switch contacts with resistance circuit
~ 8 V DC
> 2.1 mA (conductive) / < 1.2 mA (blocking)
< 0.2 mA
Break 0.05 mA < I <sub>IN</sub> < 0.35 mA
Short circuit 100 Ω < R <sub>Sensor</sub> < 360 Ω
<b>Relay output</b>
2 N/O contacts
AgSnO <sub>2</sub> , hard gold-plated
250 V AC (2 A) / 120 V DC (0.2 A) / 30 V DC (2 A)
500 VA
5 V / 10 mA
10 <sup>7</sup> cycles
Can be inverted via slide switch
≤ 20 Hz (without load)
19.2 V DC ... 30 V DC (24 V DC (-20% ... +25%))
30 mA (24 V DC)
< 950 mW
1
375 V (peak value in accordance with EN 60079-11)
375 V (peak value in accordance with EN 60079-11)
300 V <sub>rms</sub> (rated insulation voltage (surge voltage category II; pollution degree 2, safe isolation as per EN 61010-1))
300 V <sub>rms</sub> (rated insulation voltage (surge voltage category III; pollution degree 2, safe isolation as per EN 61010-1))
2.5 kV (50 Hz, 1 min., test voltage)
-20 °C ... 60 °C (any mounting position)
10 % ... 95 % (non-condensing)
Green LED (supply voltage)
Yellow LED (switching state)
Red LED (line fault)
PA 66-FR
V0
12.5 / 99 / 114.5 mm
0.2 ... 2.5 mm <sup>2</sup> / 0.2 ... 2.5 mm <sup>2</sup> / 24 - 14
0.2 ... 1.5 mm <sup>2</sup> / 0.2 ... 1.5 mm <sup>2</sup> / 24 - 16
Class A product, see page 625
9.6 V
10 mA
25 mW
253 V AC (125 V DC)
CE-compliant, additionally EN 61326
[Ex] II (1) G [Ex ia Ga] IIC
[Ex] II (1) D [Ex ia Da] IIIC
[Ex ia Ga] IIC, [Ex ia Da] IIIC, Ex nA nC IIC T4 Gc
Class I Div 2; IS for Class I, II, III Div 1
2

Ordering data

Description	Type	Order No.	Pcs. / Pkt.
NAMUR signal conditioner, 1-channel, intrinsically safe input, output: 2 N/O contacts	MACX MCR-EX-SL-NAM-2RO	2865450	1
	MACX MCR-EX-SL-NAM-2RO-SP	2924061	1

Digital IN  
NAMUR signal conditioner, Ex i

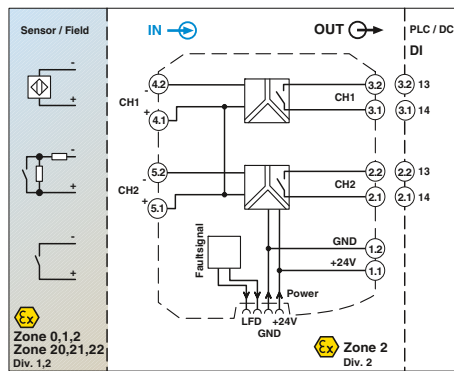
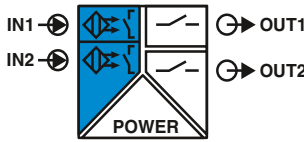

2-channel, signal output: N/O contact relay

Functional Safety  
Ex: Ex i Ex ia Ex ia Ex ia  
Housing width 12.5 mm

Technical data

Input data		Switching output		General data	
Input signal		Contact type		Supply voltage range	
No-load voltage		Contact material		Current consumption	
Switching points		Max. switching voltage		Power dissipation	
Switching hysteresis		Max. switching capacity		Number of channels	
Line fault detection		Recommended minimum load		Electrical isolation	
		Mechanical service life		Input/output	
		Switching behavior		Input/supply, DIN rail connector	
		Max. switching frequency		Output 1/output 2/input, power supply, DIN rail connector	
		General data		Output 1/output 2/input/power supply, DIN rail connector	
		Supply voltage range		Ambient temperature range	
		Current consumption		Humidity	
		Power dissipation		Status indication	
		Number of channels		Housing material	
		Electrical isolation		Inflammability class in acc. with UL 94	
				Dimensions W / H / D	
				Screw connection solid / stranded / AWG	
				Push-in connection solid / stranded / AWG	
				EMC note	
				Safety data as per ATEX	
				Max. output voltage U <sub>o</sub>	
				Max. output current I <sub>o</sub>	
				Max. output power P <sub>o</sub>	
				Maximum voltage U <sub>m</sub>	
				Conformance / approvals	
				Conformance	
				ATEX	
				IECEX	
				UL, USA / Canada	
				SIL in accordance with IEC 61508	
				Relay output	
				1 N/O contact per channel	
				AgSnO <sub>2</sub> , hard gold-plated	
				250 V AC (2 A) / 120 V DC (0.2 A) / 30 V DC (2 A)	
				500 VA	
				5 V / 10 mA	
				10 <sup>7</sup> cycles	
				Can be inverted via slide switch	
				≤ 20 Hz (without load)	
				19.2 V DC ... 30 V DC (24 V DC (-20% ... +25%))	
				35 mA (24 V DC)	
				< 1 W	
				2	
				375 V (peak value in accordance with EN 60079-11)	
				375 V (peak value in accordance with EN 60079-11)	
				300 V <sub>rms</sub> (rated insulation voltage (surge voltage category II; pollution degree 2, safe isolation as per EN 61010-1))	
				300 V <sub>rms</sub> (rated insulation voltage (surge voltage category III; pollution degree 2, safe isolation as per EN 61010-1))	
				2.5 kV (50 Hz, 1 min., test voltage)	
				-20 °C ... 60 °C (any mounting position)	
				5% ... 95% (non-condensing)	
				Green LED (supply voltage)	
				Yellow LED (switching state)	
				Red LED (line fault)	
				PA 66-FR	
				V0	
				12.5 / 99 / 114.5 mm	
				0.2 ... 2.5 mm <sup>2</sup> / 0.2 ... 2.5 mm <sup>2</sup> / 24 - 14	
				0.2 ... 1.5 mm <sup>2</sup> / 0.2 ... 1.5 mm <sup>2</sup> / 24 - 16	
				Class A product, see page 625	
				9.6 V	
				10.3 mA	
				25 mW	
				253 V AC (125 V DC)	
				CE-compliant, additionally EN 61326	
				Ex II (1) G [Ex ia Ga] IIC	
				Ex II (1) D [Ex ia Da] IIIC	
				[Ex ia Ga] IIC, [Ex ia Da] IIIC, Ex nA nC IIC T4 Gc	
				Class I Div 2; IS for Class I, II, III Div 1	
				2	

**Notes:**  
Information about the power and fault signaling module as well as about the DIN rail connectors and marking material can be found from page 213  
Information about resistance circuits is given on page 180  
Information on Plug and Play connection using system cabling can be found from page 216

Ordering data

Description	Type	Order No.	Pcs. / Pkt.
NAMUR signal conditioner, 2-channel, intrinsically safe input, output: N/O contact			
Screw connection	MACX MCR-EX-SL-2NAM-RO	2865476	1
Push-in connection	MACX MCR-EX-SL-2NAM-RO-SP	2924087	1

Digital IN  
NAMUR signal conditioner, Ex i

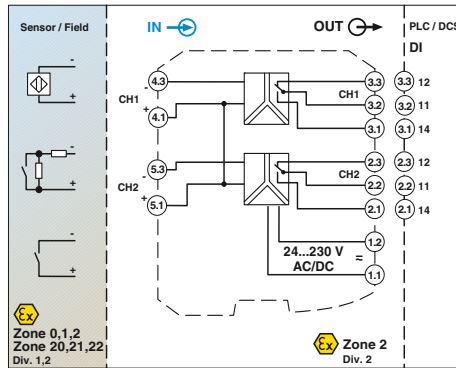
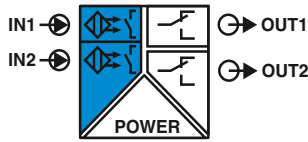

2-channel, signal output: PDT relay, wide range power supply

Functional Safety  
Ex: Ex i EAC Ex  
Housing width 17.5 mm

NAMUR signal conditioner for intrinsically safe operation of proximity sensors and mechanical contacts installed in Ex areas.

- 2-channel
- Input for NAMUR proximity sensors (EN 60947-5-6), floating contacts or contacts with resistance circuit, [Ex ia]
- Relay signal output (PDT)
- Reversible direction of action (operating current or closed-circuit current behavior)
- Line fault detection (LFD), can be activated/deactivated, error message signaled by red flashing LED with de-excitation of output relay
- Wide range power supply: 19.2 ... 253 V AC/DC
- LED displays for indicating supply voltage, circuit state, and malfunctions to NAMUR NE 44
- 3-way electrical isolation
- Up to SIL 2 according to IEC 61508
- Installation in zone 2 permitted

**Notes:**  
Information on resistance circuits and marking material can be found on page 180

<b>Input data</b>	Input signal
	No-load voltage Switching points Switching hysteresis Line fault detection
<b>Switching output</b>	Contact type Contact material Max. switching voltage Max. switching capacity Recommended minimum load Mechanical service life Switching behavior Max. switching frequency
<b>General data</b>	Supply voltage range
	Current consumption Power dissipation Electrical isolation
	Input/output Input/power supply
	Output 1/output 2/input, power supply
<b>Ambient temperature range</b>	-20 °C ... 60 °C
<b>Humidity</b>	10 % ... 95 % (non-condensing)
<b>Housing material</b>	PA 66-FR
<b>Inflammability class in acc. with UL 94</b>	V0
<b>Dimensions W / H / D</b>	17.5 / 99 / 114.5 mm
<b>Screw connection solid / stranded / AWG</b>	0.2 ... 2.5 mm <sup>2</sup> / 0.2 ... 2.5 mm <sup>2</sup> / 24 - 14
<b>Push-in connection solid / stranded / AWG</b>	0.2 ... 1.5 mm <sup>2</sup> / 0.2 ... 1.5 mm <sup>2</sup> / 24 - 16
<b>EMC note</b>	Class A product, see page 625
<b>Safety data as per ATEX</b>	9.6 V 10.3 mA 25 mW 253 V AC/DC (supply terminals) 250 V AC (output terminals) 120 V DC (output terminals)
<b>Max. output voltage U<sub>o</sub></b>	
<b>Max. output current I<sub>o</sub></b>	
<b>Max. output power P<sub>o</sub></b>	
<b>Maximum voltage U<sub>m</sub></b>	
<b>Conformance / approvals</b>	CE-compliant, additionally EN 61326
<b>Conformance</b>	Ex i IIC Ex ia IIC Ex ia Da IIC Ex nA nC [ia Ga] IIC T4 Gc X [Ex ia Ga] IIC, [Ex ia Da] IIC, Ex nA nC [ia Ga] IIC T4 Gc Class I Div 2; IS for Class I, II, III Div 1
<b>ATEX</b>	2
<b>IECEX</b>	
<b>UL, USA / Canada</b>	
<b>SIL in accordance with IEC 61508</b>	

Technical data

<b>NAMUR proximity sensors (EN 60947-5-6)</b>	open circuit switch contacts Switch contacts with resistance circuit ~ 8 V DC > 2.1 mA (conductive) / < 1.2 mA (blocking) approx. 0.2 mA Break 0.05 mA < I <sub>IN</sub> < 0.35 mA Short circuit 100 Ω < R <sub>Sensor</sub> < 360 Ω
<b>Relay output</b>	1 PDT per channel AgSnO <sub>2</sub> , hard gold-plated 250 V AC (2 A, 60 Hz) / 120 V DC (0.2 A) / 30 V DC (2 A) 500 VA 5 V / 10 mA 10 <sup>7</sup> cycles can be inverted using DIP switch ≤ 20 Hz (load-dependent)
<b>Supply voltage range</b>	24 V ... 230 V AC/DC (-20 % ... +10 %, 50 Hz ... 60 Hz)
<b>Current consumption</b>	< 80 mA ; < 42 mA (24 V DC) ≤ 1.3 W
<b>Input/output</b>	375 V (peak value in accordance with EN 60079-11) 375 V (peak value in accordance with EN 60079-11) 300 V <sub>rms</sub> (rated insulation voltage (surge voltage category II; pollution degree 2, safe isolation as per EN 61010-1)) 2.5 kV AC (50 Hz, 1 min., test voltage)
<b>Input/power supply</b>	300 V <sub>rms</sub> (rated insulation voltage (surge voltage category III; pollution degree 2, safe isolation as per EN 61010-1)) 2.5 kV AC (50 Hz, 1 min., test voltage)
<b>Output 1/output 2/input, power supply</b>	300 V <sub>rms</sub> (rated insulation voltage (surge voltage category III; pollution degree 2, safe isolation as per EN 61010-1)) 2.5 kV AC (50 Hz, 1 min., test voltage)
<b>Ambient temperature range</b>	-20 °C ... 60 °C
<b>Humidity</b>	10 % ... 95 % (non-condensing)
<b>Housing material</b>	PA 66-FR
<b>Inflammability class in acc. with UL 94</b>	V0
<b>Dimensions W / H / D</b>	17.5 / 99 / 114.5 mm
<b>Screw connection solid / stranded / AWG</b>	0.2 ... 2.5 mm <sup>2</sup> / 0.2 ... 2.5 mm <sup>2</sup> / 24 - 14
<b>Push-in connection solid / stranded / AWG</b>	0.2 ... 1.5 mm <sup>2</sup> / 0.2 ... 1.5 mm <sup>2</sup> / 24 - 16
<b>EMC note</b>	Class A product, see page 625
<b>Safety data as per ATEX</b>	9.6 V 10.3 mA 25 mW 253 V AC/DC (supply terminals) 250 V AC (output terminals) 120 V DC (output terminals)
<b>Max. output voltage U<sub>o</sub></b>	
<b>Max. output current I<sub>o</sub></b>	
<b>Max. output power P<sub>o</sub></b>	
<b>Maximum voltage U<sub>m</sub></b>	
<b>Conformance / approvals</b>	CE-compliant, additionally EN 61326
<b>Conformance</b>	Ex i IIC Ex ia IIC Ex ia Da IIC Ex nA nC [ia Ga] IIC T4 Gc X [Ex ia Ga] IIC, [Ex ia Da] IIC, Ex nA nC [ia Ga] IIC T4 Gc Class I Div 2; IS for Class I, II, III Div 1
<b>ATEX</b>	2
<b>IECEX</b>	
<b>UL, USA / Canada</b>	
<b>SIL in accordance with IEC 61508</b>	

Ordering data

Description	Type	Order No.	Pcs. / Pkt.
<b>NAMUR signal conditioner, 2-channel, intrinsically safe input, output: PDT</b>			
Screw connection	MACX MCR-EX-SL-2NAM-R-UP	2865984	1
Push-in connection	MACX MCR-EX-SL-2NAM-R-UP-SP	2924249	1

Digital IN  
NAMUR signal conditioner, Ex i

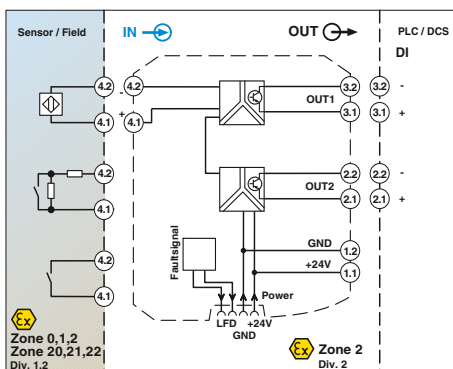
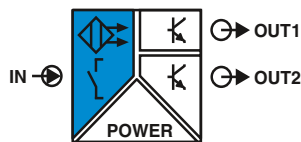

2 signal outputs: transistor (passive)

Functional Safety

Ex: Ex i

Housing width 12.5 mm

Technical data

Input data	
Input signal	
No-load voltage	
Switching points	
Line fault detection	
Switching output	
Max. switching voltage	
Max. switching current	
Drop ( $\Delta U$ )	
Switching behavior	
Max. switching frequency	
General data	
Supply voltage range	
Current consumption	
Power dissipation	
Number of channels	
Electrical isolation	
Input/output	375 V (peak value in accordance with EN 60079-11)
Input/output/supply, DIN rail connector	300 V <sub>rms</sub> (rated insulation voltage (surge voltage category II; pollution degree 2, safe isolation as per EN 61010-1)) 2.5 kV (50 Hz, 1 min., test voltage)
Input/supply, DIN rail connector	375 V (peak value in accordance with EN 60079-11)
Output 1/output 2	50 V <sub>rms</sub> (rated insulation voltage (surge voltage category II; pollution degree 2, basic insulation as per EN 61010-1)) 1 kV (50 Hz, 1 min., test voltage)
Ambient temperature range	-20 °C ... 60 °C (any mounting position)
Humidity	10 % ... 95 % (non-condensing)
Status indication	Green LED (supply voltage) Yellow LED (switching state) Red LED (line fault)
Housing material	PA 66-FR
Inflammability class in acc. with UL 94	V0
Dimensions W / H / D	12.5 / 99 / 114.5 mm
Screw connection solid / stranded / AWG	0.2 ... 2.5 mm <sup>2</sup> / 0.2 ... 2.5 mm <sup>2</sup> / 24 - 14
Push-in connection solid / stranded / AWG	0.2 ... 1.5 mm <sup>2</sup> / 0.2 ... 1.5 mm <sup>2</sup> / 24 - 16
EMC note	Class A product, see page 625
Safety data as per ATEX	
Max. output voltage U <sub>o</sub>	
Max. output current I <sub>o</sub>	
Max. output power P <sub>o</sub>	
Maximum voltage U <sub>m</sub>	
Conformance / approvals	
Conformance	
ATEX	
IECEX	
UL, USA / Canada	
SIL in accordance with IEC 61508	

NAMUR proximity sensors (EN 60947-5-6)		
Floating switch contacts		
Switch contacts with resistance circuit		
~ 8 V DC		
> 2.1 mA (conductive) / < 1.2 mA (blocking)		
Break 0.05 mA < I <sub>IN</sub> < 0.35 mA		
Short circuit 100 Ω < R <sub>Sensor</sub> < 360 Ω		
2 transistor outputs, passive		
30 V DC		
50 mA (short-circuit resistant)		
< 1.4 V		
can be inverted using DIP switch		
≤ 5 kHz		
19.2 V DC ... 30 V DC (24 V DC (-20% ... +25%))		
< 28 mA (24 V DC)		
≤ 800 mW		
1		
375 V (peak value in accordance with EN 60079-11)		
300 V <sub>rms</sub> (rated insulation voltage (surge voltage category II; pollution degree 2, safe isolation as per EN 61010-1))		
2.5 kV (50 Hz, 1 min., test voltage)		
375 V (peak value in accordance with EN 60079-11)		
50 V <sub>rms</sub> (rated insulation voltage (surge voltage category II; pollution degree 2, basic insulation as per EN 61010-1))		
1 kV (50 Hz, 1 min., test voltage)		
-20 °C ... 60 °C (any mounting position)		
10 % ... 95 % (non-condensing)		
Green LED (supply voltage)		
Yellow LED (switching state)		
Red LED (line fault)		
PA 66-FR		
V0		
12.5 / 99 / 114.5 mm		
0.2 ... 2.5 mm <sup>2</sup> / 0.2 ... 2.5 mm <sup>2</sup> / 24 - 14		
0.2 ... 1.5 mm <sup>2</sup> / 0.2 ... 1.5 mm <sup>2</sup> / 24 - 16		
Class A product, see page 625		
9.6 V		
10.3 mA		
25 mW		
253 V AC (125 V DC)		
CE-compliant, additionally EN 61326		
Ex II (1) G [Ex ia Ga] IIC		
Ex II (1) D [Ex ia Da] IIIC		
Ex II 3 G Ex nA IIC T4 Gc X		
[Ex ia Ga] IIC, [Ex ia Da] IIIC, Ex nA IIC T4 Gc		
Class I Div 2; IS for Class I, II, III Div 1		
2		

**Notes:**  
Information about the power and fault signaling module as well as about the DIN rail connectors and marking material can be found from page 213  
Information about resistance circuits is given on page 180  
Information on Plug and Play connection using system cabling can be found from page 216

Ordering data

Description	Type	Order No.	Pcs. / Pkt.	
NAMUR signal conditioner, intrinsically safe input, output: transistor, passive	Screw connection	MACX MCR-EX-SL-NAM-2T	2865463	1
	Push-in connection	MACX MCR-EX-SL-NAM-2T-SP	2924074	1

Digital IN  
NAMUR signal conditioner, Ex i

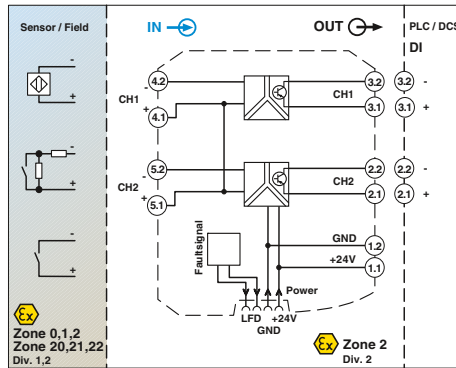
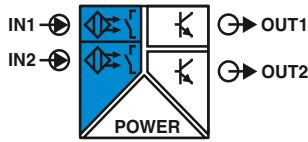

2-channel, signal output transistor (passive)

Functional Safety  
Ex: Ex i  
Housing width 12.5 mm

Technical data

NAMUR signal conditioner for intrinsically safe operation of proximity sensors and mechanical contacts installed in Ex areas.

- 2-channel
- Input for NAMUR proximity sensors (EN 60947-5-6), floating contacts or contacts with resistance circuit, [Ex ia]
- Signal output transistor (passive); up to 5 kHz
- Reversible direction of action (operating current or closed-circuit current behavior)
- Line fault detection (LFD), can be activated/deactivated, error message signaled by red flashing LED with inhibiting of transistor output
- Power supply and error indication possible via the DIN rail connector
- LED displays for indicating supply voltage, circuit state, and malfunctions to NAMUR NE 44
- 3-way electrical isolation
- Up to SIL 2 according to IEC 61508
- Installation in zone 2 permitted

Notes:
Information about the power and fault signaling module as well as about the DIN rail connectors and marking material can be found from page 213
Information about resistance circuits is given on page 180
Information on Plug and Play connection using system cabling can be found from page 216

<b>Input data</b>	Input signal
No-load voltage	
Switching points	
Line fault detection	
<b>Switching output</b>	
Max. switching voltage	
Max. switching current	
Drop ( $\Delta U$ )	
Switching behavior	
Max. switching frequency	
<b>General data</b>	
Supply voltage range	
Current consumption	
Power dissipation	
Number of channels	
Electrical isolation	
	Input/output Input/output/supply, DIN rail connector
	Input/supply, DIN rail connector
	Output 1/output 2
Ambient temperature range	
Humidity	
Status indication	
Housing material	
Inflammability class in acc. with UL 94	
Dimensions W / H / D	
Screw connection solid / stranded / AWG	
Push-in connection solid / stranded / AWG	
EMC note	
<b>Safety data as per ATEX</b>	
Max. output voltage $U_o$	
Max. output current $I_o$	
Max. output power $P_o$	
Maximum voltage $U_m$	
<b>Conformance / approvals</b>	
Conformance	
ATEX	
IECEX	
UL, USA / Canada	
SIL in accordance with IEC 61508	

NAMUR proximity sensors (EN 60947-5-6)
Floating switch contacts
Switch contacts with resistance circuit
~ 8 V DC
> 2.1 mA (conductive) / < 1.2 mA (blocking)
Break 0.05 mA < $I_{IN}$ < 0.35 mA
Short circuit 100 $\Omega$ < $R_{Sensor}$ < 360 $\Omega$
1 transistor output, passive (per channel)
30 V DC
50 mA (short-circuit resistant)
< 1.4 V
can be inverted using DIP switch
$\leq$ 5 kHz
19.2 V DC ... 30 V DC (24 V DC (-20% ... +25%))
< 34 mA (24 V DC)
$\leq$ 1000 mW
2
375 V (peak value in accordance with EN 60079-11)
300 $V_{rms}$ (rated insulation voltage (surge voltage category II; pollution degree 2, safe isolation as per EN 61010-1))
2.5 kV (50 Hz, 1 min., test voltage)
375 V (peak value in accordance with EN 60079-11)
50 $V_{rms}$ (rated insulation voltage (surge voltage category II; pollution degree 2, basic insulation as per EN 61010-1))
1 kV (50 Hz, 1 min., test voltage)
-20 $^{\circ}$ C ... 60 $^{\circ}$ C (any mounting position)
10% ... 95% (non-condensing)
Green LED (supply voltage)
Yellow LED (switching state)
Red LED (line fault)
PA 66-FR
V0
12.5 / 99 / 114.5 mm
0.2 ... 2.5 mm <sup>2</sup> / 0.2 ... 2.5 mm <sup>2</sup> / 24 - 14
0.2 ... 1.5 mm <sup>2</sup> / 0.2 ... 1.5 mm <sup>2</sup> / 24 - 16
Class A product, see page 625
9.6 V
10.3 mA
25 mW
253 V AC (125 V DC)
CE-compliant, additionally EN 61326
Ex II (1) G [Ex ia Ga] IIC
Ex II (1) D [Ex ia Da] IIIC
Ex II 3 G Ex nA IIC T4 Gc X
[Ex ia Ga] IIC, [Ex ia Da] IIIC, Ex nA IIC T4 Gc
Class I Div 2; IS for Class I, II, III Div 1
2

Ordering data

Description	Type	Order No.	Pcs. / Pkt.
NAMUR signal conditioner, 2-channel, intrinsically safe input, output: transistor, passive			
Screw connection	MACX MCR-EX-SL-2NAM-T	2865489	1
Push-in connection	MACX MCR-EX-SL-2NAM-T-SP	2924090	1



Digital IN  
NAMUR signal conditioner, Ex i

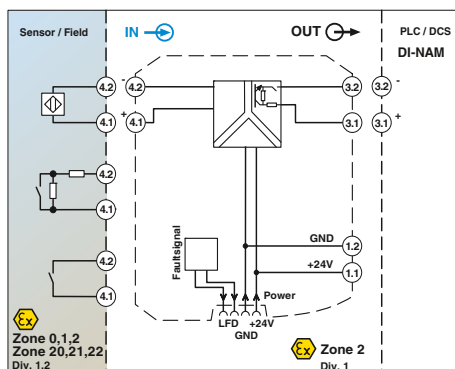
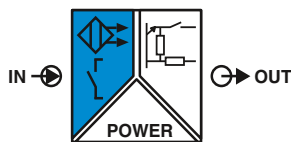

With line fault transparency



Housing width 12.5 mm

Technical data

<b>Input data</b>	
Input signal	
No-load voltage	
Switching points	
Line fault detection	
<b>Switching output</b>	
Switching voltage	
Switching frequency	
Impedance 0-signal	
Impedance 1-signal	
Impedance fault	
Switching behavior	
<b>General data</b>	
Supply voltage range	
Current draw	
Power dissipation	
Electrical isolation	
	Input/output
	Input/output/supply, DIN rail connector
	Input/supply, DIN rail connector
Ambient temperature range	
Humidity	
Status indication	
Housing material	
Inflammability class in acc. with UL 94	
Dimensions W / H / D	
Screw connection solid / stranded / AWG	
Push-in connection solid / stranded / AWG	
EMC note	
<b>Safety data as per ATEX</b>	
Max. output voltage $U_o$	
Max. output current $I_o$	
Max. output power $P_o$	
Maximum voltage $U_m$	
<b>Conformance / approvals</b>	
Conformance	
ATEX	
IECEX	
SIL in accordance with IEC 61508	

NAMUR proximity sensors (EN 60947-5-6)
Floating switch contacts
Switch contacts with resistance circuit
~ 8 V DC
> 2.1 mA (conductive) / < 1.2 mA (blocking)
Break 0.05 mA < I <sub>IN</sub> < 0.35 mA
Short circuit 100 Ω < R <sub>Sensor</sub> < 360 Ω
Resistive (transistor, passive)
typ. 8.2 V DC ±10 % (according to EN 60947-5-6)
≤ 5 kHz (ohmic load)
11 kΩ ±5 %
1.4 kΩ ±5 %
> 100 kΩ
can be inverted using DIP switch
12 V DC ... 24 V DC -20 % ... +25 %
25 mA (24 V DC)
< 0.6 W
375 V (peak value in accordance with EN 60079-11)
300 V <sub>rms</sub> (rated insulation voltage (surge voltage category II; pollution degree 2, safe isolation as per EN 61010-1))
2.5 kV (50 Hz, 1 min., test voltage)
375 V (peak value in accordance with EN 60079-11)
-20 °C ... 60 °C (any mounting position)
10 % ... 95 % (non-condensing)
Green LED (supply voltage)
Yellow LED (switching state)
Red LED (line fault)
PA 66-FR
V0
12.5 / 99 / 114.5 mm
0.2 ... 2.5 mm <sup>2</sup> / 0.2 ... 2.5 mm <sup>2</sup> / 24 - 14
0.2 ... 1.5 mm <sup>2</sup> / 0.2 ... 1.5 mm <sup>2</sup> / 24 - 16
Class A product, see page 625
9.6 V
10 mA
25 mW
253 V
CE-compliant, additionally EN 61326
Ex II (1) G [Ex ia Ga] IIC
Ex II (1) D [Ex ia Da] IIC
Ex II 3G Ex nA IIC T4 Gc X
[Ex ia Ga] IIC, [Ex ia Da] IIC, Ex nA IIC T4 Gc
2

**Notes:**  
Information on the power and fault signaling module, DIN rail connectors, system cabling, and marking material can be found from page 213  
Information about resistance circuits is given on page 180

Ordering data

Description	Type	Order No.	Pcs. / Pkt.
NAMUR signal conditioner, intrinsically safe input, output with line fault transparency			
Screw connection	MACX MCR-EX-SL-NAM-NAM	2866006	1
Push-in connection	MACX MCR-EX-SL-NAM-NAM-SP	2924883	1



**Solenoid drivers for controlling solenoid valves**

In order to control intrinsically safe Ex i solenoid valves, you have to have an intrinsically safe control circuit. This is provided by the solenoid drivers that are available from Phoenix Contact.

The following must be taken into account when dimensioning your intrinsically safe control circuit:

- Valve
- Cable with corresponding resistance
- Solenoid driver

As a result, it may be the case that not all valves are compatible with the solenoid drivers.

Below is an extract from a table showing possible combinations of valves and solenoid drivers.

A complete and updated list (along with details of the technical data of suitable valves, the maximum cable lengths, and the maximum cable resistances of the individual combinations) can be found on the Internet at:

[www.phoenixcontact.net/products](http://www.phoenixcontact.net/products)

**Example circuit**

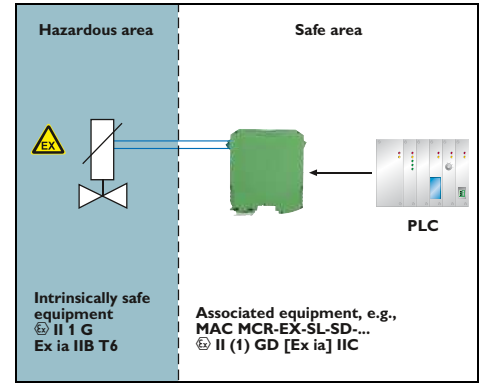

**Overview of valves**

Manufacturer	Type designation	Ex certificate	Condition	INTERFACE Ex solenoid driver			
				MACX MCR-EX-SL-SD-21-25-LP	MACX MCR-EX-SL-SD-21-40-LP	MACX MCR-EX-SL-SD-24-48-LP	MACX MCR-EX-SL-SD-21-60-LP
ASCO	Coil 195	LCIE 08 ATEX 6083			✓	✓	
	Coil 302 (12 V)	INERIS 03 ATEX 0249X				✓	✓
	Coil 302 (24 V)	INERIS 03 ATEX 0249X					✓
Bürkert	Coil AC 10, standard	PTB 01 ATEX 2101			✓	✓	
	Coil AC 10, high-resistance	PTB 01 ATEX 2101			✓	✓	
	Coil AC 21, standard	PTB 01 ATEX 2175	700 mW/65°C		✓	✓	
	Coil AC 21, high-resistance	PTB 01 ATEX 2175	700 mW/65°C		✓	✓	
	Coil AC 21, standard	PTB 01 ATEX 2175	900 mW/45°C		✓	✓	
	Coil AC 21, high-resistance	PTB 01 ATEX 2175	900 mW/45°C		✓	✓	
	Coil AC 21, standard	PTB 01 ATEX 2175	900 mW/60°C		✓	✓	
	Coil AC 21, high-resistance	PTB 01 ATEX 2175	900 mW/60°C		✓	✓	
	Coil G1 642735, standard		600 mW/50°C		✓		
	Coil G1 642735, high-resistance		600 mW/50°C		✓		
FESTO	Coil MFH...IA-SA-EX GBXE022AIAD03	PTB 03 ATEX 2097				✓	✓
	Coil (J)MFH...BIA-SA-EX GBXE022AIAD03	PTB 03 ATEX 2097				✓	✓
	Coil 2050	PTB 07 ATEX 2019			✓	✓	✓
	Coil 2051	PTB 07 ATEX 2019			✓	✓	✓
	Coil 2052	PTB 07 ATEX 2019			✓	✓	✓
	Coil 2053	PTB 07 ATEX 2019			✓	✓	✓
	Coil 2085	PTB 06 ATEX 2001 U		✓		✓	
	Coil 2086	PTB 06 ATEX 2001 U		✓		✓	✓
	Coil 3039	PTB 03 ATEX 2134				✓	
	Coil 2003	PTB 04 ATEX 2010				✓	✓
Hörbiger	Piezo P8 38x RF-Nx-SPN65	DMT 01 ATEX E026X	30 V type	✓	✓		
	Piezo P20 381RF-NG-CPN61	DMT 01 ATEX E025X	30 V type	✓	✓		
Parker	Coil VZ07 488650.01	LCIE 02 ATEX 6024X			✓	✓	
	Coil VZ33 494035.10	LCIE 02 ATEX 6024X			✓	✓	
	Coil VZ08 488660.01	LCIE 02 ATEX 6024X			✓	✓	
	Coil VZ09 488670.01	LCIE 02 ATEX 6024X			✓	✓	
	Coil VZ95 482160.01	LCIE 02 ATEX 6024X	EEx ia IIB T6		✓	✓	✓
	Coil VZ23 482870.01	LCIE 02 ATEX 6024X			✓	✓	
Samson	Coil 3701-11 (6 V)	PTB 02 ATEX 2178		✓	✓	✓	
	Coil 3701-12 (12 V)	PTB 02 ATEX 2178		✓	✓	✓	
	Coil 3701-13 (24 V)	PTB 02 ATEX 2178		✓	✓	✓	
	Coil 3963-11 (6 V)	PTB 01 ATEX 2085		✓	✓	✓	
	Coil 3963-12 (12 V)	PTB 01 ATEX 2085		✓	✓	✓	
	Coil 3963-13 (24 V)	PTB 01 ATEX 2085		✓	✓	✓	
	Coil 3964-11 (6 V)	PTB 02 ATEX 2047		✓	✓	✓	
	Coil 3964-12 (12 V)	PTB 02 ATEX 2047		✓	✓	✓	
	Coil 3964-13 (24 V)	PTB 02 ATEX 2047		✓	✓	✓	
	Coil 3965-11 (6 V)	PTB 05 ATEX 2044X		✓	✓	✓	
	Coil 3965-12 (12 V)	PTB 05 ATEX 2044X		✓	✓	✓	
	Coil 3965-13 (24 V)	PTB 05 ATEX 2044X		✓	✓	✓	
	Coil 3967-11 (6 V)	PTB 06 ATEX 2027		✓	✓	✓	
	Coil 3967-12 (12 V)	PTB 06 ATEX 2027		✓	✓	✓	
	Coil 3967-13 (24 V)	PTB 06 ATEX 2027		✓	✓	✓	
Seitz	Pilot valve PV 12F73 Ci oH	PTB 99 ATEX 2146		✓	✓	✓	
	Pilot valve PV 12F73 Xi oH	PTB 00 ATEX 2030		✓	✓	✓	
	Pilot valve PV 12F73 Xi oH-2	PTB 00 ATEX 2030		✓	✓	✓	
	Solenoid 11 G 52	PTB 01 ATEX 2020		✓	✓	✓	

**Digital OUT**  
**Solenoid driver, Ex i**

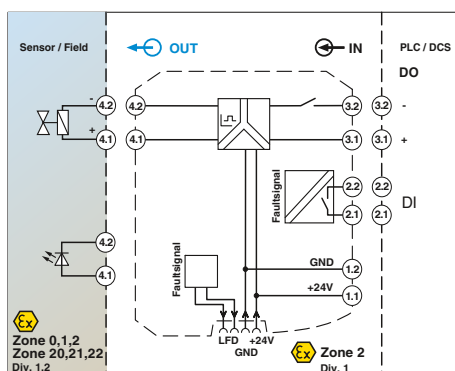
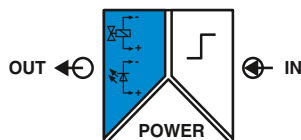

**Current limitation 48 mA,  
with line fault detection**

Functional Safety  
Ex: Ex i Ex ia Ex iaD  
Housing width 12.5 mm

**Technical data**

<b>Input data</b>	Switching level 0 signal ("L") Switching level 1 signal ("H") Input current Input impedance in the event of a line fault at the output	0 V DC ... 5 V DC (Open) 15 V DC ... 30 V DC < 12 mA 3 MΩ (high resistance (Mega Ω))
<b>Output data</b>	Transparent for test pulses Output voltage Current limitation No-load voltage Internal resistance Immunity to short-circuiting Response time $t_A$ Line fault detection	Yes ≥ 9.5 V DC (at 48 mA) > 48 mA (with line fault detection) > 23.3 V DC ≥ 269 Ω (internal resistance $R_i$ ) Yes < 30 ms < 50 Ω (short circuit on the line) > 10 kΩ (line break)
<b>Error message output</b>	Switch contact Max. switching voltage Max. switching current Short-circuit-proof	N/C contact 30 V DC 50 mA Yes
<b>General data</b>	Supply voltage range Current draw Power dissipation Electrical isolation	19.2 V DC ... 30 V DC (24 V DC (-20% ... +25%)) < 90 mA < 1.5 W
	Input/output, supply, error message output	375 V (peak value in accordance with EN 60079-11) 300 V <sub>rms</sub> (rated insulation voltage (surge voltage category II; pollution degree 2, safe isolation as per EN 61010-1)) 2.5 kV (50 Hz, 1 min., test voltage)
<b>Ambient temperature range</b>		-20 °C ... 60 °C (any mounting position)
<b>Humidity</b>		10 % ... 95 % (non-condensing)
<b>Status indication</b>		Green LED (supply voltage) Yellow LED (switching state) Red LED (line fault)
<b>Degree of protection</b>		IP20
<b>Housing material</b>		PA 66-FR
<b>Inflammability class in acc. with UL 94</b>		V0
<b>Dimensions W / H / D</b>		12.5 / 99 / 114.5 mm
<b>Screw connection solid / stranded / AWG</b>		0.2 ... 2.5 mm <sup>2</sup> / 0.2 ... 2.5 mm <sup>2</sup> / 24 - 14
<b>Push-in connection solid / stranded / AWG</b>		0.2 ... 1.5 mm <sup>2</sup> / 0.2 ... 1.5 mm <sup>2</sup> / 24 - 16
<b>EMC note</b>		Class A product, see page 625
<b>Safety data as per ATEX</b>		25.3 V 94 mA 595 mW 253 V
<b>Conformance / approvals</b>		CE-compliant, additionally EN 61326 Ex II (1) G [Ex ia Ga] IIC Ex II (1) D [Ex ia Da] IIIC Ex II 3(1) G Ex nA [ia Ga] IIC T4 Gc X [Ex ia Ga] IIC, [Ex ia Da] IIIC, Ex nA IIC T4 Gc 2
<b>IECEX</b>		
<b>SIL in accordance with IEC 61508</b>		

**Notes:**  
Information on the power and fault signaling module, DIN rail connectors, system cabling, and marking material can be found from page 213

Ordering data				
Description	Type	Order No.	Pcs. / Pkt.	
<b>Solenoid driver</b> , logic input, intrinsically safe output, line fault detection	Screw connection	<b>MACX MCR-EX-SL-SD-23-48-LFD</b>	2924867	1
	Push-in connection	<b>MACX MCR-EX-SL-SD-23-48-LFD-SP</b>	2924870	1

Digital OUT  
Solenoid driver, Ex i

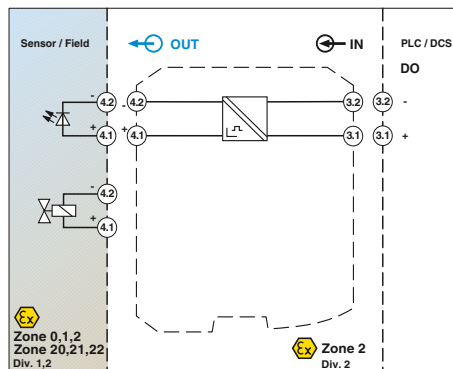
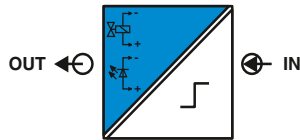

Current limitation 25 mA

Functional Safety  
Ex: [Ex i] [Ex ia] [Ex ia] [Ex ia]  
Housing width 12.5 mm

Solenoid drivers for controlling intrinsically safe solenoid valves, alarm transmitters, and indicators installed in Ex areas.

- 20 ... 30 V DC input
- Output [Ex ia]
- Various output characteristic curves compatible with standard solenoid valves
- Loop-powered: the required power is supplied via the control signal on the input side.
- Mechanically compatible with DIN rail connector
- 2-way electrical isolation
- Up to SIL 3 as per EN 61508
- Installation in zone 2 permitted

<b>Notes:</b>
A list of suitable valves and notes for calculating a valve circuit are available from the download center at <a href="http://phoenixcontact.net/products">phoenixcontact.net/products</a> .
Information on marking material can be found on page 179
Information on Plug and Play connection using system cabling can be found from page 216

<b>Input data</b>	
Input signal	20 V DC ... 30 V DC
Input current	10 mA DC ... 70 mA DC (45 mA for $U_o = 24$ V DC)
<b>Output data</b>	
Output voltage	5,5 V DC (at 25 mA)
Current limitation	25 mA
No-load voltage	21.9 V DC
Internal resistance	641 $\Omega$ (internal resistance $R_i$ )
Immunity to short-circuiting	Yes
Response time $t_A$	20 ms
<b>General data</b>	
Power dissipation	< 1 W
Temperature coefficient	0.01 %/K
Electrical isolation	Output/input
Ambient temperature range	375 V (peak value in accordance with EN 60079-11)
Status indication	300 V <sub>rms</sub> (rated insulation voltage (surge voltage category II; pollution degree 2, safe isolation as per EN 61010-1))
Degree of protection	2.5 kV (50 Hz, 1 min., test voltage)
Inflammability class in acc. with UL 94	-20 °C ... 60 °C (any mounting position)
Dimensions W / H / D	Yellow LED (switching state / status, lights up when output circuit is active)
Screw connection solid / stranded / AWG	IP20
Push-in connection solid / stranded / AWG	V0
EMC note	12.5 / 99 / 114.5 mm
<b>Safety data as per ATEX</b>	0.2 ... 2.5 mm <sup>2</sup> / 0.2 ... 2.5 mm <sup>2</sup> / 24 - 14
Max. output voltage $U_o$	0.2 ... 1.5 mm <sup>2</sup> / 0.2 ... 1.5 mm <sup>2</sup> / 24 - 16
Max. output current $I_o$	Class A product, see page 625
Max. output power $P_o$	
Maximum voltage $U_m$	25.1 V
<b>Conformance / approvals</b>	39 mA
Conformance	245 mW
ATEX	253 V AC (125 V DC)
IECEX	CE-compliant, additionally EN 61326
UL, USA / Canada	[Ex] II 3 G Ex nA IIC T4 Gc X
SIL in accordance with IEC 61508	[Ex] II (1) G [Ex ia Ga] IIC/IIB/IIA
	[Ex] II (1) D [Ex ia Da] IIC
	[Ex ia Ga] IIC/IIB/IIA, [Ex ia Da] IIC, Ex nA IIC T4 Gc X
	Class I Div 2; IS for Class I, II, III Div 1
	3

**Technical data**

<b>Technical data</b>	
20 V DC ... 30 V DC	
10 mA DC ... 70 mA DC (45 mA for $U_o = 24$ V DC)	
5,5 V DC (at 25 mA)	
25 mA	
21.9 V DC	
641 $\Omega$ (internal resistance $R_i$ )	
Yes	
20 ms	
< 1 W	
0.01 %/K	
Output/input	
375 V (peak value in accordance with EN 60079-11)	
300 V <sub>rms</sub> (rated insulation voltage (surge voltage category II; pollution degree 2, safe isolation as per EN 61010-1))	
2.5 kV (50 Hz, 1 min., test voltage)	
-20 °C ... 60 °C (any mounting position)	
Yellow LED (switching state / status, lights up when output circuit is active)	
IP20	
V0	
12.5 / 99 / 114.5 mm	
0.2 ... 2.5 mm <sup>2</sup> / 0.2 ... 2.5 mm <sup>2</sup> / 24 - 14	
0.2 ... 1.5 mm <sup>2</sup> / 0.2 ... 1.5 mm <sup>2</sup> / 24 - 16	
Class A product, see page 625	
25.1 V	
39 mA	
245 mW	
253 V AC (125 V DC)	
CE-compliant, additionally EN 61326	
[Ex] II 3 G Ex nA IIC T4 Gc X	
[Ex] II (1) G [Ex ia Ga] IIC/IIB/IIA	
[Ex] II (1) D [Ex ia Da] IIC	
[Ex ia Ga] IIC/IIB/IIA, [Ex ia Da] IIC, Ex nA IIC T4 Gc X	
Class I Div 2; IS for Class I, II, III Div 1	
3	

**Ordering data**

<b>Description</b>	
<b>Solenoid driver, loop-powered, intrinsically safe output</b>	
Screw connection	MACX MCR-EX-SL-SD-21-25-LP
Push-in connection	MACX MCR-EX-SL-SD-21-25-LP-SP

Type	Order No.	Pcs. / Pkt.
MACX MCR-EX-SL-SD-21-25-LP	2865492	1
MACX MCR-EX-SL-SD-21-25-LP-SP	2924113	1

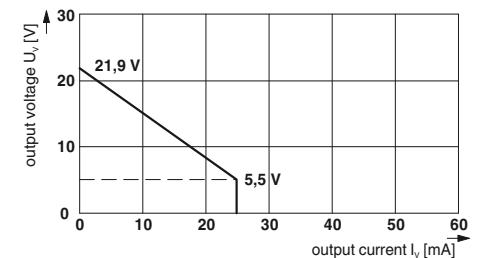

Ex i signal conditioners with SIL functional safety - MACX Analog Ex



Current limitation 40 mA



Current limitation 48 mA



Current limitation 58 mA, [Ex ia] IIB

Functional Safety  
Ex:

Housing width 12.5 mm

Functional Safety  
Ex:

Housing width 12.5 mm

Functional Safety  
Ex:

Housing width 12.5 mm

Technical data
20 V DC ... 30 V DC 10 mA ... 95 mA (65 mA for $U_o = 24$ V DC)
10 V DC (at 40 mA) 40 mA 21.9 V DC 287 $\Omega$ (internal resistance $R_i$ ) Yes 20 ms
< 1.2 W 0.01 %/K
375 V (peak value in accordance with EN 60079-11) 300 $V_{rms}$ (rated insulation voltage (surge voltage category II; pollution degree 2, safe isolation as per EN 61010-1)) 2.5 kV (50 Hz, 1 min., test voltage)
-20 °C ... 60 °C (any mounting position) Yellow LED (switching state / status, lights up when output circuit is active) IP20 V0 12.5 / 99 / 114.5 mm 0.2 ... 2.5 mm <sup>2</sup> / 0.2 ... 2.5 mm <sup>2</sup> / 24 - 14 0.2 ... 1.5 mm <sup>2</sup> / 0.2 ... 1.5 mm <sup>2</sup> / 24 - 16 Class A product, see page 625
25.1 V 87 mA 550 mW 253 V AC (125 V DC)
CE-compliant, additionally EN 61326 II 3 G Ex nA IIC T4 Gc X II (1) G [Ex ia Ga] IIC/IIB/IIA II (1) D [Ex ia Da] IIIC [Ex ia Ga] IIC/IIB/IIA Class I Div 2; IS for Class I, II, III Div 1 3

Technical data
20 V DC ... 30 V DC 10 mA ... 95 mA (75 mA for $U_o = 24$ V DC)
10.5 V DC (at 48 mA) 48 mA 24 V DC 276 $\Omega$ (internal resistance $R_i$ ) Yes 30 ms
< 1.4 W 0.01 %/K
375 V (peak value in accordance with EN 60079-11) 300 $V_{rms}$ (rated insulation voltage (surge voltage category II; pollution degree 2, safe isolation as per EN 61010-1)) 2.5 kV (50 Hz, 1 min., test voltage)
-20 °C ... 60 °C (any mounting position) Yellow LED (switching state / status, lights up when output circuit is active) IP20 V0 12.5 / 99 / 114.5 mm 0.2 ... 2.5 mm <sup>2</sup> / 0.2 ... 2.5 mm <sup>2</sup> / 24 - 14 0.2 ... 1.5 mm <sup>2</sup> / 0.2 ... 1.5 mm <sup>2</sup> / 24 - 16 Class A product, see page 625
27.7 V 101 mA 697 mW 253 V AC (125 V DC)
CE-compliant, additionally EN 61326 II 3 G Ex nA IIC T4 Gc X II (1) G [Ex ia Ga] IIC/IIB/IIA II (1) D [Ex ia Da] IIIC [Ex ia Ga] IIC/IIB/IIA Class I Div 2; IS for Class I, II, III Div 1 3

Technical data
20 V DC ... 30 V DC 10 mA ... 105 mA (95 mA for $U_o = 24$ V DC)
12.9 V DC (at 58 mA) 58 mA 21.9 V DC 133 $\Omega$ (internal resistance $R_i$ ) Yes 30 ms
< 1.4 W 0.01 %/K
375 V (peak value in accordance with EN 60079-11) 300 $V_{rms}$ (rated insulation voltage (surge voltage category II; pollution degree 2, safe isolation as per EN 61010-1)) 2.5 kV (50 Hz, 1 min., test voltage)
-20 °C ... 60 °C (any mounting position) Yellow LED (switching state / status, lights up when output circuit is active) IP20 V0 12.5 / 99 / 114.5 mm 0.2 ... 2.5 mm <sup>2</sup> / 0.2 ... 2.5 mm <sup>2</sup> / 24 - 14 0.2 ... 1.5 mm <sup>2</sup> / 0.2 ... 1.5 mm <sup>2</sup> / 24 - 16 Class A product, see page 625
25.1 V 188 mA 1.18 W 253 V AC (125 V DC)
CE-compliant, additionally EN 61326 II 3 G Ex nA IIC T4 Gc X II (1) G [Ex ia Ga] IIB/IIA II (1) D [Ex ia Da] IIIC [Ex ia Ga] IIB/IIA Class I Div 2; IS for Class I, II, III Div 1 3

Ordering data		
Type	Order No.	Pcs. / Pkt.
MACX MCR-EX-SL-SD-21-40-LP	2865764	1
MACX MCR-EX-SL-SD-21-40-LP-SP	2924139	1

Ordering data		
Type	Order No.	Pcs. / Pkt.
MACX MCR-EX-SL-SD-24-48-LP	2865609	1
MACX MCR-EX-SL-SD-24-48-LP-SP	2924126	1

Ordering data		
Type	Order No.	Pcs. / Pkt.
MACX MCR-EX-SL-SD-21-60-LP	2865515	1
MACX MCR-EX-SL-SD-21-60-LP-SP	2924100	1

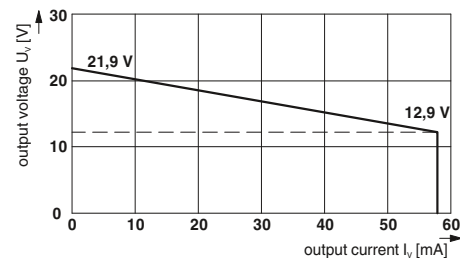
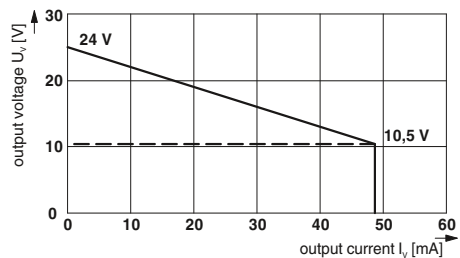
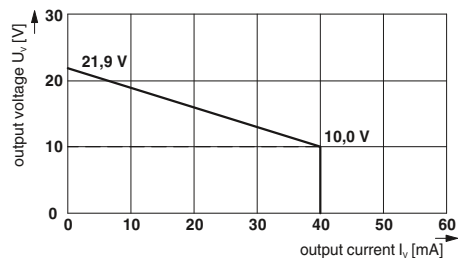

Accessories

Programming adapter

The IFS-USB-PROG-ADAPTER programming adapter is used for configuring Phoenix Contact INTERFACE modules with S-Port interface.

The adapter is used with FDT/DTM software or ANALOG-CONF software. For programming MACX Analog, MINI Analog Pro, and MINI Analog.



General data
EMC note

Technical data	
Class A product, see page 625	

Description
<b>Programming adapter</b> for configuring modules with S-PORT interface

Ordering data		
Type	Order No.	Pcs. / Pkt.
IFS-USB-PROG-ADAPTER	2811271	1

Accessories

**Power and fault signaling module**

Power and fault signaling module for feeding the 24 V supply voltage to the DIN rail connectors and signaling line faults and power supply failures.

- One-time or redundant supply, decoupled from diode, protected against polarization
- Supply current up to 3.75 A
- Relay output (PDT) and flashing LED for error messages
- Error message in the event of a power supply failure or fuse fault
- Bus cable fault message for MACX MCR-...(2)NAM... devices connected via DIN rail connectors
- Replaceable fuse
- Installation in zone 2 permitted

**ME 6,2 TBUS... DIN rail connector**

DIN rail connector (5-pos.) for bridging the supply voltage of 12.5 mm wide MACX Analog Ex modules.

- Reduces wiring costs
- System can be extended or module replaced even while process is active
- Inter-extendable

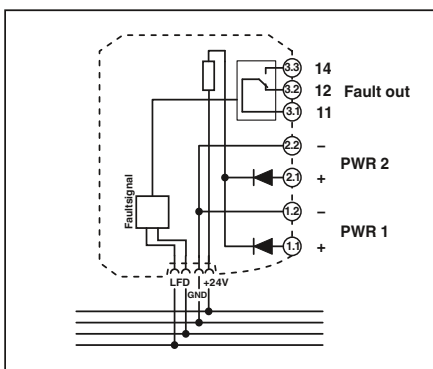

Ex n



Power and fault signaling module

Housing width 17.5 mm

**Technical data**

<b>Input data</b>	
Input signal	19.2 V DC ... 30 V DC (24 V DC (-20% ... +25%))
Redundant supply	yes, decoupled from diodes
Polarization and surge protection	Yes
<b>Output data</b>	
Maximum output signal	3.75 A
Output voltage	Input voltage - max 0.8 V at 3.75 A
<b>Switching output</b>	
Contact type	Relay
Contact material	1 PDT
Max. switching voltage	Gold (Au)
<b>General data</b>	
Ambient temperature range	50 V AC (50 V DC (0.3 A) / 50 V DC (2 A) / 33 V AC (2 A))
Humidity	-20 °C ... 60 °C (any mounting position)
Fuse	5 % ... 95 % (non-condensing)
Status indication	5 A (replaceable), slow-blow 250 V AC
Housing material	1 x red LED (error)
Inflammability class in acc. with UL 94	2 x green LEDs (PWR1 and PWR2)
Dimensions W / H / D	Polyamide (PA 6.6)
Screw connection solid / stranded / AWG	V0
Push-in connection solid / stranded / AWG	17.5 / 99 / 114.5 mm
<b>Conformance / approvals</b>	
Conformance	0.2 ... 2.5 mm <sup>2</sup> / 0.2 ... 2.5 mm <sup>2</sup> / 24 - 14
ATEX	0.2 ... 1.5 mm <sup>2</sup> / 0.2 ... 1.5 mm <sup>2</sup> / 24 - 16
IECEX	CE-compliant
UL, USA / Canada	Ex II 3 G Ex nA nC IIC T4 Gc X
	Ex nA nC IIC T4 Gc X
	UL 61010 Listed
	Class I, Div. 2, Groups A, B, C, D T5
	Class I, Zone 2, Group IIC

**Ordering data**

Description	Type	Order No.	Pcs. / Pkt.	
<b>Power and fault signaling module</b> , including the relevant DIN rail connector ME 17,5 TBUS 1,5/5-ST-3,81 GN	Screw connection	<b>MACX MCR-PTB</b>	2865625	1
	Push-in connection	<b>MACX MCR-PTB-SP</b>	2924184	1

**Accessories**

<b>DIN rail connector (TBUS)</b> , for bridging the supply voltage, can be snapped onto 35 mm DIN rails as per EN 60715, with UL approval	<b>ME 6,2 TBUS-2 1,5/5-ST-3,81 GN</b>	2869728	10
---	---------------------------------------	---------	----



Accessories

Marking material for device marking

- For device marking inside the control cabinet and in the field
- Self-adhesive with high adhesive strengths
- Large temperature range



		Ordering data		
Description	Color	Type	Order No.	Pcs. / Pkt.
UniCard, with self-adhesive plastic labels				
10-part, lettering field size: 11 x 9 mm	white	UC-EMLP (11X9)	0819291	10
UniCard, with self-adhesive plastic labels, marked according to customer specifications For ordering details, see Catalog 5 or phoenixcontact.net/product.				
10-part, lettering field size: 11 x 9 mm	white	UC-EMLP (11X9) CUS	0824547	1

Accessories

Resistance circuit

Double-level terminal block with resistance circuit according to NAMUR for line fault detection in the case of mechanical contacts

Important:

- For intrinsically safe circuits, only in combination with D-UKK 3/5 cover



		Ordering data		
Description	Color	Type	Order No.	Pcs. / Pkt.
Double-level terminal block, with pre-assembled resistors				
With screw connection		UKK 5-2R/NAMUR	2941662	50
Cover, width 2.5 mm	gray blue	D-UKK 3/5	2770024	50
		D-UKK 3/5 BU	2770105	50



### Termination Carriers for MACX Analog Ex signal conditioners



Select standard DIN rail device



Select module carrier

**TC... Termination Carriers** are compact solutions for quickly and smoothly connecting DIN rail devices from the MACX Analog Ex series to input/output cards of automation systems using system cables.

The Termination Carriers combine the advantages of modular DIN rail devices with those offered by Plug and Play rapid cabling solutions to provide a consistent solution for system technology.

#### Compact

- Saves up to 30% of space due to compact design

#### Robust and reliable

- Stable, vibration-resistant aluminum carrier device profile
- PCB is completely decoupled from modules
- PCB without active components
- Redundant supply and monitoring in separate DIN rail module

#### Easy maintenance

- Use of standard DIN rail devices
- Easy access to connection points
- Quick and safe module connection with plug-in and coded cable sets

#### Flexible

- Horizontal or vertical DIN rail mounting
- Profile section without pitch markings for I/O cards with specific number of channels
- Can be specifically adapted for I/O cards of various automation systems with different system plug types



Select controller-specific front adapter and system cable



Solutions are also available for MINI Analog, MACX Analog Ex, and Safety

**Termination Carriers for MACX Analog Ex signal conditioners**

The **TC-D37SUB-ADIO16-EX-P-UNI** universal Termination Carrier is a compact solution which connects signal conditioners from the MACX Analog Ex series to analog or binary input/output cards of automation systems.

- The **TC-D37SUB-AIO16-EX-PS-UNI** Termination Carrier design, when combined with the MACX MCR-S-MUX HART multiplexer, also enables communication between HART-capable field devices and a management system.
- Connection of up to 16 single-channel (Ex i) signal conditioners
  - Universal 1:1 signal routing to a 37-pos. D-SUB connector
  - For system cables with D-SUB socket and open ends for universal connection
  - Redundant supply and monitoring in separate DIN rail module

**Notes:**  
Contact us: specific Termination Carrier designs for I/O modules of various automation systems are available, planned or can be implemented according to your specifications.



ERC  
Ex:   
Housing width 242 mm

Technical data	
D-SUB pin strip	37
< 50 V DC (per signal/channel)	23 mA (signal/channel)
Rated insulation voltage	50 V
Pollution degree	2
Surge voltage category	II
Rated surge voltage	0.5 kV (basic insulation)
Clearance and creepage distances	DIN EN 50178
Ambient temperature range	-20 °C ... 60 °C (please observe module specifications)
Shock	15g, according to IEC 60068-2-27
Vibration (operation)	2g, according to IEC 60068-2-6
Dimensions W / H / D	242 / 170 / 160 mm
EMC note	Class A product, see page 625
Power supply via power module	
Input voltage range	19.2 V DC ... 30 V DC
Redundant supply	yes, decoupled from diodes
Polarization and surge protection	Yes
Fuse	2x 2.5 A on PCB, slow-blow (replaceable)
Status indication	1 x red LED (error) 2x green LEDs (PWR1 and PWR2)
Switching output	1 N/C contact (alarm = open)
Maximum switching voltage	50 V DC (0.3 A) / 30 V DC (2 A) / 33 V AC (2 A)

General data	
Connection to the control system level	
Number of positions	
Max. operating voltage	
Max. permissible current	
Rated insulation voltage	
Pollution degree	
Surge voltage category	
Rated surge voltage	
Clearance and creepage distances	
Ambient temperature range	
Shock	
Vibration (operation)	
Dimensions W / H / D	
EMC note	
Power supply via power module	
Input voltage range	
Redundant supply	
Polarization and surge protection	
Fuse	
Status indication	
Switching output	
Maximum switching voltage	

Description	
<b>Universal Termination Carrier</b> for 16 MACX MCR-EX isolators	
- With connection for MACX MCR-S-MUX HART multiplexer	

Ordering data		
Type	Order No.	Pcs. / Pkt.
TC-D37SUB-ADIO16-EX-P-UNI	2924854	1
TC-D37SUB-AIO16-EX-PS-UNI	2902932	1

Power and fault signaling module	
<b>HART multiplexer</b> , 32-channel, including two 14-wire flat-ribbon cables	

Accessories		
TC-MACX-MCR-PTB	2904673	1
MACX MCR-S-MUX	2865599	1

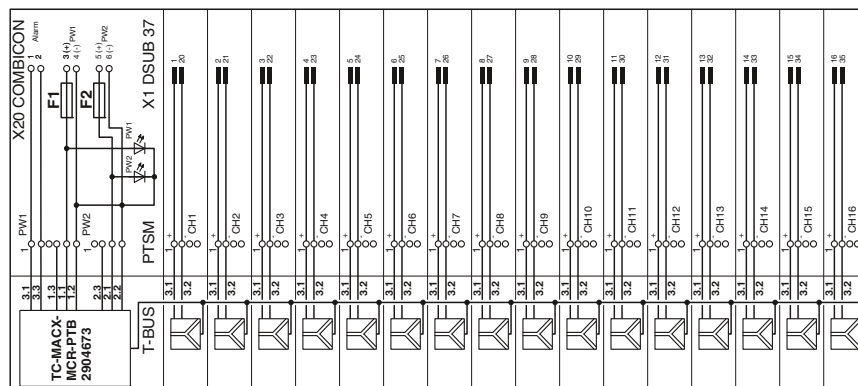

TC-D37SUB-ADIO16-EX-P-UNI and TC-D37SUB-AIO16-EX-PS-UNI connection scheme

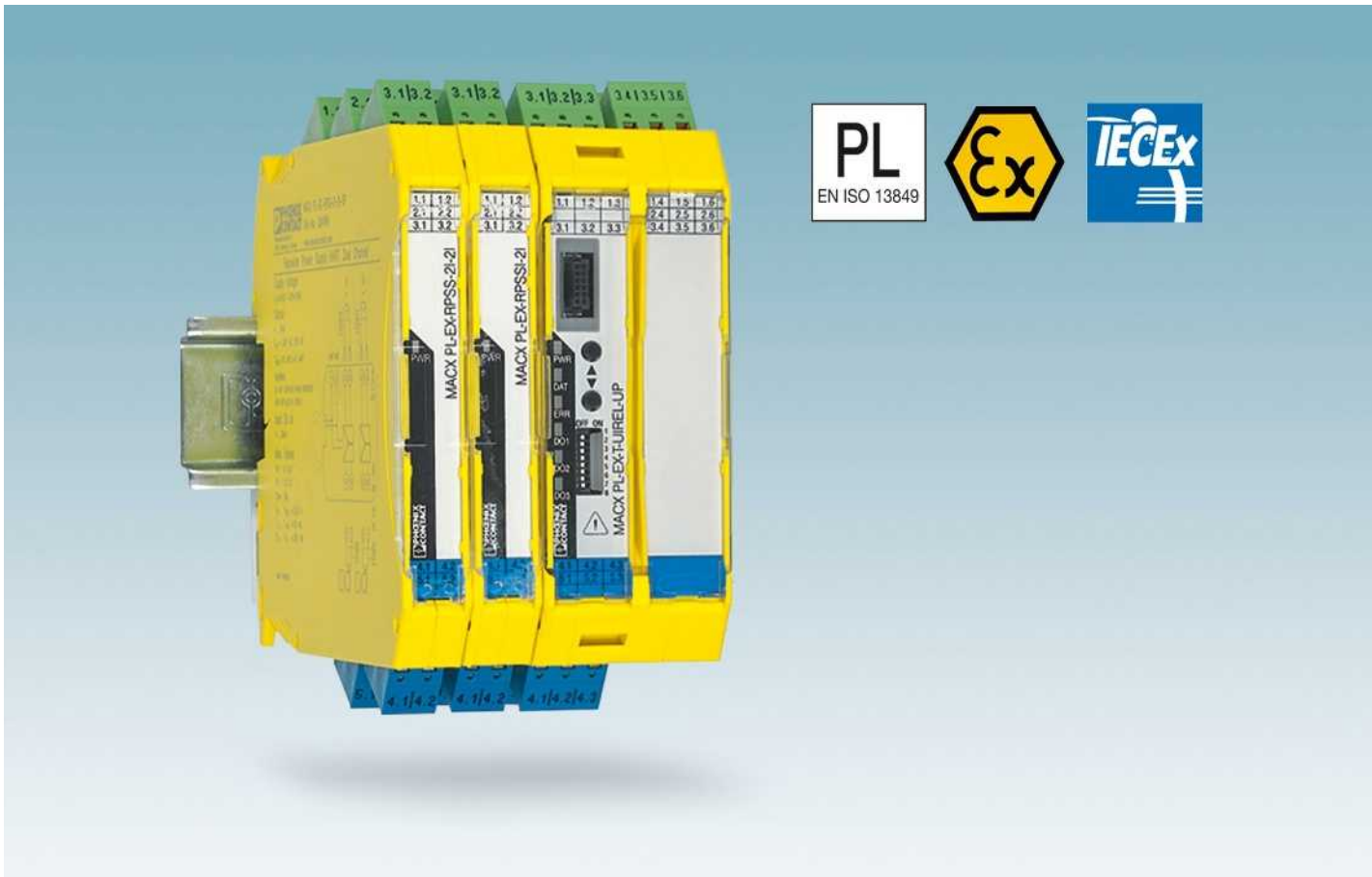

**Integrate analog signals safely**

Integrate analog signals easily into your safety application according to the Machinery Directive. The MACX Safety Ex analog signal conditioners are certified according to EN ISO 13849-1 with performance level PL d.

Universal use for intrinsically safe circuits in all Ex zones and for all gas and dust groups, thanks to international approval package.

**Choose the right MACX Safety Ex signal conditioner for your application:**

**Analog IN**

- 4...20 mA repeater power supplies and input signal conditioners with 2 electrically isolated outputs

**Temperature**

- Universal temperature transducers

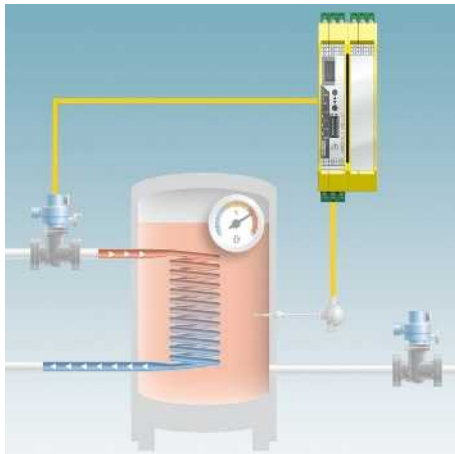

**Direct switching of limit values possible without an additional safety controller**

- Cost savings: direct, safe switching of limit values possible without an additional safety controller
- Easy to combine active or passive analog signals with other safety modules

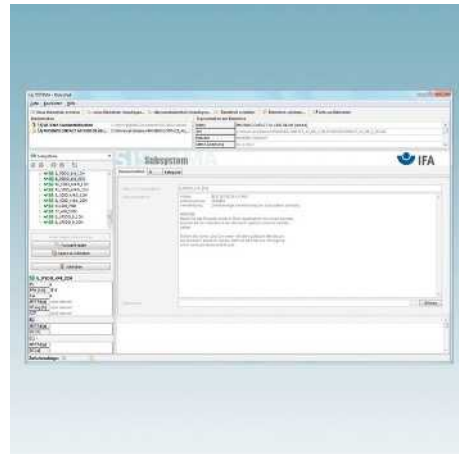

**Easy planning of the safety application with SISTEMA**

- Easy planning of the safety application with SISTEMA: the required data is already stored there



**DIN rail connector-compatible**

The DIN rail connector enables the modular bridging of the 24 V supply voltage.

Analog IN

Repeater power supply, Ex i

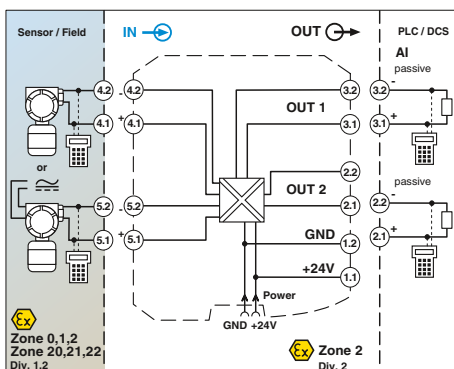
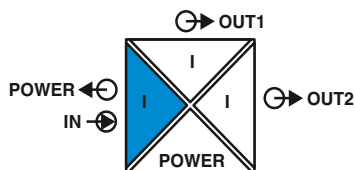

Repeater power supply and input signal conditioner, with two electrically isolated outputs

Housing width 12.5 mm

- 4...20 mA input, [Ex ia], powered and not powered
- Two electrically isolated 4...20 mA (active) outputs
- PL d according to EN ISO 13849-1
- Up to SIL 2 according to IEC 61508
- Installation in zone 2 possible
- Plug-in screw and push-in connection technology
- 4-way electrical isolation
- Bidirectional HART communication possible
- Power supply via DIN rail connector possible

<b>Input data</b>	
Input signal	4 mA ... 20 mA / 4 mA ... 20 mA
Transmitter supply voltage	> 16 V (at 20 mA)
Voltage drop	approx. 3.9 V
<b>Output data</b>	
Output signal (per output)	4 mA ... 20 mA (active)
Load	< 450 Ω (at 20 mA)
Output ripple	< 20 mV <sub>rms</sub>
<b>General data</b>	
Supply voltage range	19.2 V DC ... 30 V DC (24 V DC (-20% ... +25%))
Current consumption	< 75 mA (24 V DC/ 20 mA)
Power dissipation	< 1.45 W (24 V DC/ 20 mA)
Temperature coefficient	< 0.01 %/K
Step response (10-90%)	< 1.3 ms (for 4 mA ... 20 mA step)
Transmission error, typical	< 0.05 % (of final value)
Maximum transmission error	< 0.1 % (of final value)
Underload/overload range	according to NE 43
Electrical isolation	300 V <sub>rms</sub> (rated insulation voltage (surge voltage category II); pollution degree 2, safe isolation as per EN 61010-1) 2.5 kV (50 Hz, 1 min., test voltage)
Ambient temperature range	-20 °C ... 60 °C (any mounting position)
Status indication	Green LED (PWR supply voltage)
SMART communication (per output)	Yes
Protocols supported	HART
Housing material	PA 66-FR
Dimensions W / H / D	12.5 / 99 / 114.5 mm
Screw connection solid / stranded / AWG	0.2 ... 2.5 mm <sup>2</sup> / 0.2 ... 2.5 mm <sup>2</sup> / 24 - 14
Push-in connection solid / stranded / AWG	0.2 ... 1.5 mm <sup>2</sup> / 0.2 ... 1.5 mm <sup>2</sup> / 24 - 16
EMC note	Class A product, see page 625
<b>Safety data as per ATEX</b>	
Max. output voltage U <sub>o</sub>	25.2 V
Max. output current I <sub>o</sub>	93 mA
Max. output power P <sub>o</sub>	587 mW
Maximum voltage U <sub>m</sub>	253 V AC (125 V DC)
<b>Conformance / approvals</b>	
Conformance	CE-compliant, additionally EN 61326
ATEX	[Ex] II (1) G [Ex ia Ga] IIC/IIB [Ex] II (1) D [Ex ia Da] IIIC [Ex] II 3 (1) G Ex nA [ia Ga] IIC/IIB T4 Gc
IECEx	[Ex ia Ga] IIC/IIB, [Ex ia Da], Ex nA [ia Ga] IIC/IIB T4 Gc
SIL in accordance with IEC 61508	2
Performance level according to ISO 13849	PLd

Technical data

<b>Technical data</b>			
Input/output/power supply	300 V <sub>rms</sub> (rated insulation voltage (surge voltage category II); pollution degree 2, safe isolation as per EN 61010-1) 2.5 kV (50 Hz, 1 min., test voltage)		
Input/output	375 V (peak value in accordance with EN 60079-11)		
Input/power supply	375 V (peak value in accordance with EN 60079-11)		
Output 1/output 2	1.5 kV AC (50 Hz, 1 min., test voltage)		
<b>Ordering data</b>			
Type	Order No.	Pcs. / Pkt.	
Repeater power supply and input signal conditioner, signal duplicator, with performance level, intrinsically safe input			
Screw connection	MACX PL-EX-RPSSI-2I	2904959	1
Push-in connection	MACX PL-EX-RPSSI-2I-SP	2904960	1



Analog IN

Repeater power supply, Ex i

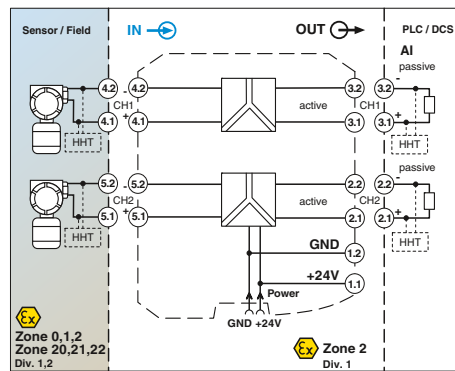
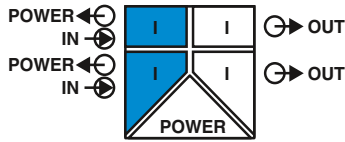

2-channel repeater power supply

Functional Safety  
 Ex: Ex i  
 Housing width 12.5 mm

- 2-channel
- 4...20 mA input, [Ex ia], powered
- 4 ... 20 mA output (active)
- PL d according to EN ISO 13849-1
- Up to SIL 3 according to IEC 61508
- Installation in zone 2 possible
- Plug-in screw and push-in connection technology
- 3-way electrical isolation, per channel
- Bidirectional HART communication possible
- Power supply via DIN rail connector possible

Technical data

<b>Input data</b>	per channel		
Input signal	4 mA ... 20 mA		
Transmitter supply voltage	> 16 V (at 20 mA)		
Underload/overload signal range	0 mA ... 24 mA		
<b>Output data</b>	per channel		
Output signal	4 mA ... 20 mA (active)		
Load	≤ 450 Ω (20 mA)		
Underload/overload signal range	0 mA ... 24 mA		
<b>General data</b>			
Supply voltage range	19.2 V DC ... 30 V DC (24 V DC (-20% ... +25%))		
Current consumption	< 100 mA (24 V / 20 mA)		
Power dissipation	< 1.4 W (at 24 V DC / 20 mA)		
Temperature coefficient	< 0.01 %/K		
Step response (10-90%)	< 1.3 ms (for 4 mA ... 20 mA step)		
Transmission error, typical	< 0.05 % (of final value)		
Maximum transmission error	< 0.1 % (of final value)		
Electrical isolation			
Input/output, power supply	300 V <sub>rms</sub> (rated insulation voltage (surge voltage category II; pollution degree 2, safe isolation as per EN 61010-1)) 2.5 kV (50 Hz, 1 min., test voltage)		
Input/output	375 V (peak value in accordance with EN 60079-11)		
Input/power supply	375 V (peak value in accordance with EN 60079-11)		
Output 1/output 2/ power supply	1.5 kV (50 Hz, 1 min., test voltage)		
Ambient temperature range	-20 °C ... 60 °C (any mounting position)		
Status indication	Green LED (supply voltage)		
SMART communication	Yes		
Signal bandwidth	as per HART specifications		
Protocols supported	HART		
Housing material	PA 66-FR		
Dimensions W / H / D	12.5 / 99 / 114.5 mm		
Screw connection solid / stranded / AWG	0.2 ... 2.5 mm <sup>2</sup> / 0.2 ... 2.5 mm <sup>2</sup> / 24 - 14		
Push-in connection solid / stranded / AWG	0.2 ... 1.5 mm <sup>2</sup> / 0.2 ... 1.5 mm <sup>2</sup> / 24 - 16		
EMC note	Class A product, see page 625		
<b>Safety data as per ATEX</b>			
Max. output voltage U <sub>o</sub>	25.2 V		
Max. output current I <sub>o</sub>	93 mA		
Max. output power P <sub>o</sub>	587 mW		
Maximum voltage U <sub>m</sub>	253 V AC (125 V DC)		
<b>Conformance / approvals</b>			
Conformance	CE-compliant, additionally EN 61326		
ATEX	Ex II (1) G [Ex ia Ga] IIC/IIB Ex II (1) D [Ex ia Da] IIIC Ex II 3(1) G Ex nA [ia Ga] IIC T4 Gc [Ex ia Ga] IIC/IIB, [Ex ia Da] IIIC, Ex nA [ia Ga] IIC T4 Gc		
IECEX	3		
SIL in accordance with IEC 61508	PLd		
Performance level according to ISO 13849			
<b>Ordering data</b>			
<b>Description</b>			
Repeater power supply, two-channel, with performance level, intrinsically safe input			
Screw connection	MACX PL-EX-RPSS-2I-2I	2904963	1
Push-in connection	MACX PL-EX-RPSS-2I-2I-SP	2904964	1

Temperature

Temperature transducer, Ex i

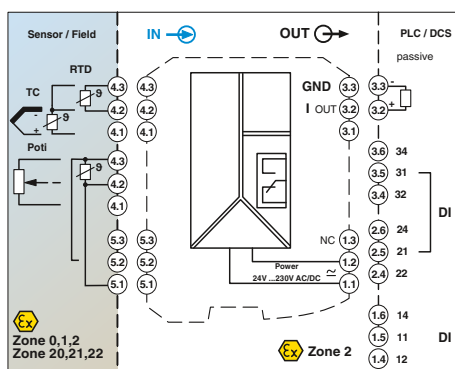
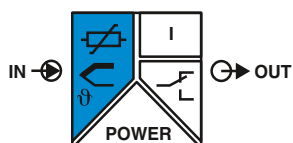

Universal, with limit value relay, wide range power supply

Functional Safety

Ex: Ex i

Housing width 35 mm

Technical data

<b>Input data</b>	Resistance thermometers Thermocouple sensors	Pt, Ni, Cu sensors: 2, 3, 4-wire B, E, J, K, N, R, S, T, L, U, CA, DA, A1G, A2G, A3G, MG, LG
Resistor Potentiometer Voltage	0 Ω ... 50 kΩ 0 Ω ... 50 kΩ -1000 mV ... 1000 mV	
<b>Output data</b>	Output signal Maximum output signal Load R <sub>B</sub> Behavior in the event of a sensor error	4 mA ... 20 mA 22 mA ≤ 600 Ω (20 mA) according to NE 43 or freely configurable
<b>Switching output</b>	Contact type Contact material Max. switching voltage Max. switching current	Relay output 2 PDT AgSnO <sub>2</sub> , hard gold-plated 250 V AC (250 V DC) 2 A (250 V AC) / 2 A (28 V DC)
<b>General data</b>	Supply voltage range Power consumption Temperature coefficient Maximum transmission error Electrical isolation	24 V ... 230 V AC/DC (-20%/+10%, 50/60 Hz) < 2.4 W 0.01 %/K 0.1 % (e.g. for Pt 100, 300 K span, 4 ... 20 mA)
	Input/output/power supply Input/output Input/power supply Input/switching output Output/supply	2.5 kV (50 Hz, 1 min., test voltage) 375 V (peak value in accordance with EN 60079-11) 375 V (peak value in accordance with EN 60079-11) 375 V (peak value in accordance with EN 60079-11) 300 V <sub>rms</sub> (rated insulation voltage (surge voltage category II; pollution degree 2, safe isolation as per EN 61010-1))
Ambient temperature range Humidity Housing material Inflammability class in acc. with UL 94 Dimensions W / H / D Screw connection solid / stranded / AWG Push-in connection solid / stranded / AWG EMC note		-20 °C ... 65 °C typ. 5 % ... 95 % (non-condensing) PA 66-FR V0 35 / 99 / 114.5 mm 0.2 ... 2.5 mm <sup>2</sup> / 0.2 ... 2.5 mm <sup>2</sup> / 24 - 14 0.2 ... 1.5 mm <sup>2</sup> / 0.2 ... 1.5 mm <sup>2</sup> / 24 - 16 Class A product, see page 625
<b>Safety data as per ATEX</b>	Max. output voltage U <sub>o</sub> Max. output current I <sub>o</sub> Max. output power P <sub>o</sub>	6 V 7.4 mA 11 mW
<b>Conformance / approvals</b>	Conformance ATEX	CE-compliant Ex II (1) G [Ex ia Ga] IIC Ex II (1) D [Ex ia Da] IIIC Ex II 3 G Ex nA nC ic IIC T4 Gc X
IECEX SIL in accordance with IEC 61508 Performance level according to ISO 13849		[Ex ia Ga] IIC, [Ex ia Da] IIIC, Ex nA nC ic IIC T4 Gc X 2 PLd

- Input for resistance thermometers, thermocouples, resistance-type sensors, potentiometers, mV sources, [Ex ia]
- Differential measurement possible with Pt 100
- A safety-related limit value relay, by bridging two relays
- An additional limit value relay for non-safety-related function
- PL d according to EN ISO 13849-1
- Up to SIL 2 according to IEC 61508
- Configuration via software (ANALOG-CONF or FDT/DTM)
- Cold junction compensation with separate connector
- Wide range power supply 19.2...253 V AC/DC
- Status indicators for supply voltage, cable, sensor, and module errors
- Installation in zone 2 possible
- Plug-in screw and push-in connection technology

**Notes:**  
You can find the ANALOG-CONF and FDT/DTM configuration software on page 187

Description
<b>Temperature transducer with threshold value switch</b> , with performance level, intrinsically safe input
Screw connection Push-in connection

**Programming adapter** for configuring modules with S-PORT interface

Ordering data		
Type	Order No.	Pcs. / Pkt.
<b>MACX PL-EX-T-UIREL-UP</b>	2904910	1
<b>MACX PL-EX-T-UIREL-UP-SP</b>	2904912	1

Accessories		
<b>IFS-USB-PROG-ADAPTER</b>	2811271	1

Multiplexers for HART signals

Multiplexer for digital connection of HART-capable field devices (such as measuring transducers or control valves) to a PC or management system.

- Supports online configuration and diagnostics for the connected HART-capable field devices
- Constant documentation of process variables and states
- 32 HART channels per multiplexer
- Up to 128 HART multiplexers at one PC interface
- Communication via software tool (e.g. HART OPC Server) using RS-485 interface
- Electrical isolation between auxiliary energy, RS-485 bus, and the HART channels
- HART field devices are accessed at the same time that the measurement signal is transmitted without affecting measured value processing
- HART field devices connected via universal HART connection boards; direct connection if processing non-Ex signals, with separate Ex i signal isolator connected upstream if processing Ex signals
- Power supplied via HART connection board



Housing width 35.2 mm

<b>Field devices interface (HART)</b>	
Channels	16 or 32; adjustable using a switch
Connection method	Flat-ribbon cable, 14-pos. (inclusive)
Signal	HART FSK
HART specification	HART Field Communication Protocol Rev. 6.0 (downward compatible up to Rev 4.0); FSK Physical Layer Specification (Rev. 8.1)
<b>Data transmission display</b>	
Display error	Two yellow "Tx" and "Rx" "HART" LEDs Red "ERR" LED (flashes in case of an error in the HART bus)
<b>RS-485 interface</b>	
Connection method	D-SUB-9 socket
Signal	RS-485
Data flow control/protocols	Compatible with OPC HART server, PDM, PRM, and FDT/DTM
<b>Number of HART multiplexers per bus segment</b>	
Address setting	Max 31
Data rate	0...127; using a rotary switch at the front 9600 / 19200 / 38400 / 57600 [bps]; via rotary switch at the front
<b>Transmission length</b>	
Display	≤ 1200 m Two yellow "Tx" and "Rx" "RS-485" LEDs
<b>General data</b>	
Supply voltage range	18 V ... 31.2 V
Nominal supply voltage	24 V DC
Current consumption	55 mA
Power consumption	1.35 W
Operating voltage display	Green "PWR" LED
Undervoltage monitoring	Yes (no faulty devices / output states)
<b>Electrical isolation between HART signal/RS-485</b>	
Electrical isolation between HART signals	350 V AC
Electrical isolation between HART signal/supply	100 V DC (capacitive)
Electrical isolation between RS-485/supply	350 V AC
Error monitoring	350 V AC Processor error: "PWR" LED flashes; HART communication error: "ERR" LED flashes
<b>Ambient temperature range</b>	
Humidity	-20 °C ... 60 °C
Dimensions W / H / D	≤ 95 % (non-condensing)
Conformance / approvals	35.2 / 99 / 114.5 mm
Conformance	CE-compliant

Technical data		
Housing width 35.2 mm		
<b>Field devices interface (HART)</b>		
Channels	16 or 32; adjustable using a switch	
Connection method	Flat-ribbon cable, 14-pos. (inclusive)	
Signal	HART FSK	
HART specification	HART Field Communication Protocol Rev. 6.0 (downward compatible up to Rev 4.0); FSK Physical Layer Specification (Rev. 8.1)	
<b>Data transmission display</b>		
Display error	Two yellow "Tx" and "Rx" "HART" LEDs Red "ERR" LED (flashes in case of an error in the HART bus)	
<b>RS-485 interface</b>		
Connection method	D-SUB-9 socket	
Signal	RS-485	
Data flow control/protocols	Compatible with OPC HART server, PDM, PRM, and FDT/DTM	
<b>Number of HART multiplexers per bus segment</b>		
Address setting	Max 31	
Data rate	0...127; using a rotary switch at the front 9600 / 19200 / 38400 / 57600 [bps]; via rotary switch at the front	
<b>Transmission length</b>		
Display	≤ 1200 m Two yellow "Tx" and "Rx" "RS-485" LEDs	
<b>General data</b>		
Supply voltage range	18 V ... 31.2 V	
Nominal supply voltage	24 V DC	
Current consumption	55 mA	
Power consumption	1.35 W	
Operating voltage display	Green "PWR" LED	
Undervoltage monitoring	Yes (no faulty devices / output states)	
<b>Electrical isolation between HART signal/RS-485</b>		
Electrical isolation between HART signals	350 V AC	
Electrical isolation between HART signal/supply	100 V DC (capacitive)	
Electrical isolation between RS-485/supply	350 V AC	
Error monitoring	350 V AC Processor error: "PWR" LED flashes; HART communication error: "ERR" LED flashes	
<b>Ambient temperature range</b>		
Humidity	-20 °C ... 60 °C	
Dimensions W / H / D	≤ 95 % (non-condensing)	
Conformance / approvals	35.2 / 99 / 114.5 mm	
Conformance	CE-compliant	

Description
<b>HART multiplexer</b> , 32-channel, including two 14-wire flat-ribbon cables
<b>Universal Termination Carrier</b> for 16 MACX MCR-EX isolators - With connection for MACX MCR-S-MUX HART multiplexer
<b>Module carrier</b> for 16 MINI Analog channels, power and feed-through module - With connection for MACX MCR-S-MUX HART multiplexer
<b>HART connection board</b> <b>Interface converter</b> , for conversion from RS-232 (V.24) to RS-485, with electrical isolation, DIN-rail-mountable, changeover of data direction self-controlling or through RTS/CTS
<b>Repeater</b> , for electrical isolation and increased range

Ordering data		
Type	Order No.	Pcs. / Pkt.
MACX MCR-S-MUX	2865599	1

Accessories		
Type	Order No.	Pcs. / Pkt.
TC-D37SUB-AIO16-EX-PS-UNI	2902932	1
TC-D37SUB-AIO16-M-PS-UNI	2902934	1
MACX MCR-S-MUX-TB	2308124	1
PSM-ME-RS232/RS485-P	2744416	1
PSM-ME-RS485/RS485-P	2744429	1

**Programmable loop-powered temperature transducer, Ex i**

- 1-channel
- Loop-powered
- Input for resistance thermometers, thermocouples, and linear mV signals, Ex ia IIC
- Output 4...20 mA/20...4 mA
- Can be installed in zone 1
- 2-way electrical isolation
- HART-capable (MCR-FL-TS-LP-I-EX)
- Configuration using software

**Notes:**  
 The devices are supplied with the standard configuration: Pt 100 sensor, measuring range 0 ... 100°C, 3-wire connection.  
 To configure the MCR-FL-TS-LP-I-EX HART-capable device (2864587), you need a HART modem.  
 To configure the MCR-FL-T-LP-EX device (2864574), you need the MCR-PAC-T-USB programming adapter and the MCR/PI-CONF-WIN software, see page 226

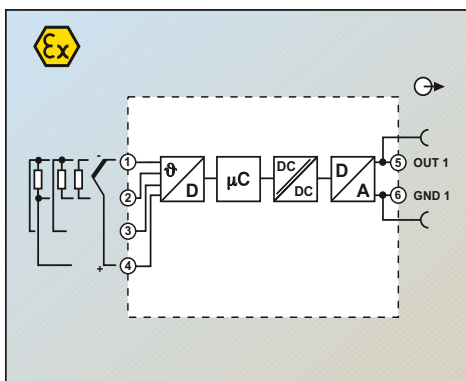

Block diagram MCR-FL-TS-LP-I-EX



Loop-powered, programmable

ERAC  
 Ex:   
 Housing width 12.5 mm

**Technical data**

<b>Measuring input</b>	Resistance thermometers Thermocouple sensors	
<b>Resistor</b>		
<b>Voltage</b>		
<b>Configuration</b>		
<b>Measuring output</b>		
<b>Output signal range</b>	4 mA ... 20 mA / 20 mA ... 4 mA	
<b>Maximum output signal</b>	≤ 23 mA	
<b>Load</b>	≤ 520 Ω (at U <sub>V</sub> = 24 V; U <sub>supply</sub> - 12 V / 0.023 A)	
<b>Line monitoring</b>	NE 43	
<b>Short-circuit current</b>	≤ 3.6 mA or ≥ 21 mA (adjustable, not for thermocouples)	
<b>Output current with open circuit</b>	≤ 3.6 mA or ≥ 21 mA (adjustable)	
<b>Output current, measuring range overrange/underrange</b>	3.8 mA ... 20.5 mA	
<b>General data</b>		
<b>Supply voltage range</b>	12 V DC ... 30 V DC	
<b>Current consumption</b>	< 3.5 mA	
<b>Step response (10-90%)</b>	< 2 s	
<b>Transmission error</b>	Resistance thermometers 0.2 K (Pt 100, Ni 100), 0.5 K (Pt 500, Ni 500), 0.3 K (Pt 1000, Ni 1000)	
	Thermocouple sensors Type 0.5 K (K, J, T, E, L, U), 1.0 K (N, C, D), 2.0 K (S, B, R)	
	Resistance-type sensors ± 0.1 Ω (10...400 Ω), ± 1.5 Ω (10...2000 Ω)	
	Voltage sensor ± 20 µV (-10...100 mV) 2 kV AC (50 Hz, 1 min.) 4 s	
<b>Test voltage input/output</b>		
<b>Switch on delay time</b>		
<b>Standards/regulations</b>	NAMUR recommendation NE 21	
<b>Housing material</b>	Polyamide PA non-reinforced	
<b>Inflammability class in acc. with UL 94</b>	V0	
<b>Dimensions W / H / D</b>	12.5 / 99 / 114.5 mm	
<b>Connection method</b>	Screw connection	
<b>Screw connection solid / stranded / AWG</b>	0.2 ... 2.5 mm <sup>2</sup> / 0.2 ... 2.5 mm <sup>2</sup> / 24 - 14	
<b>Safety data as per ATEX</b>	MCR-FL-TS-LP-I-EX      MCR-FL-T-LP-I-EX	
<b>Max. voltage U<sub>i</sub></b>	30 V      30 V	
<b>Max. current I<sub>i</sub></b>	100 mA      100 mA	
<b>Max. power P<sub>i</sub></b>	750 mW      750 mW	
<b>Max. voltage U<sub>o</sub></b>	5 V DC      4.4 V DC	
<b>Max. current I<sub>o</sub></b>	5.9 mA      9.6 mA	
<b>Max. power P<sub>o</sub></b>	7.2 mW      10.6 mW	
<b>Gas group</b>	IIA    IIB    IIC      IIA    IIB    IIC	
<b>- Max. external inductance L<sub>o</sub></b> [mH]	100   100   100      100   100   100	
<b>- Max. external capacitance C<sub>o</sub></b> [µF]	10    10    2      12    12    2.4	
<b>Max. ambient temperature</b>	T4 = 85 °C, T5 = 70 °C, T6 = 55 °C      T4 = 85 °C, T5 = 65 °C, T6 = 50 °C	
<b>Conformance / approvals</b>		
<b>Conformance</b>	CE-compliant      CE-compliant	
<b>ATEX</b>	II 2(1) G Ex ia IIC T6       II 2(1) G Ex ia IIC T4...T6	
<b>UL, USA / Canada</b>	cULus      cULus	
<b>Functional Safety (SIL)</b>	SIL 2      -	
<b>Description</b>		
<b>MCR temperature transducer</b> , for resistance thermometers, thermocouples, resistance-type sensors, and voltage sensors		
<b>HART-compatible</b>		
<b>Ordering data</b>		
<b>Type</b>	<b>Order No.</b>	<b>Pcs. / Pkt.</b>
<b>MCR-FL-TS-LP-I-EX</b>	<b>2864587</b>	<b>1</b>
<b>MCR-FL-T-LP-I-EX</b>	<b>2864574</b>	<b>1</b>

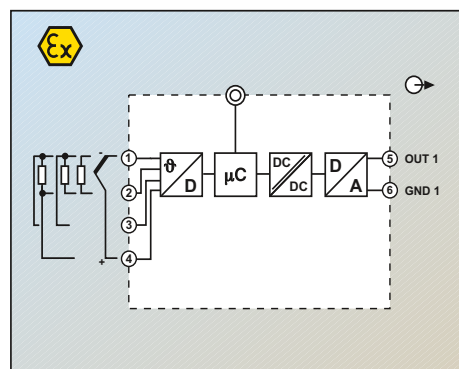

Block diagram MCR-FL-T-LP-I-EX

## Ex i 2-wire field devices

### Programmable loop-powered temperature transducer with connection heads, Ex i

- 1-channel
- Loop-powered
- Input for resistance thermometers, thermocouples, and linear mV signals, Ex ia IIC
- Output 4...20 mA/20...4 mA
- Can be installed in zone 0
- 2-way electrical isolation
- HART-compatible

**Notes:**  
 The devices are supplied with the standard configuration: Pt 100 sensor, measuring range 0 ... 100°C, 3-wire connection.  
 To configure the MCR-FL-TS-LPI-EX HART-capable device, you need a HART modem.

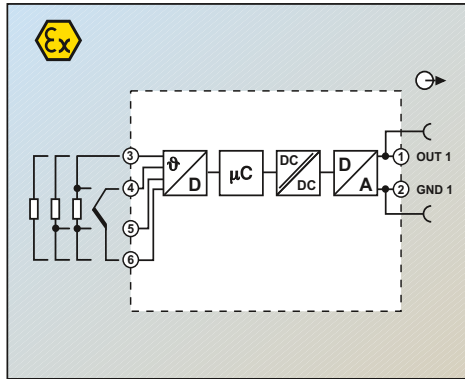

Block diagram MCR-FL-HT-TS-I-EX



Loop-powered, programmable



### Technical data

<b>Measuring input</b>	
Resistance thermometers	
Thermocouple sensors	
<b>Resistor</b>	
Voltage	
Configuration	
<b>Measuring output</b>	
Output signal range	
Maximum output signal	
Load	
Line monitoring	
Short-circuit current	
Output current with open circuit	
Output current, measuring range overrange/underrange	
<b>General data</b>	
Supply voltage range	
Current consumption	
Step response (10-90%)	
Transmission error	
	Resistance thermometers
	Thermocouple sensors
	Resistance-type sensors
	Voltage sensor
Test voltage input/output	
Switch on delay time	
Degree of protection	
Mounting position	
Connection	
Standards/regulations	
Housing material	
Inflammability class in acc. with UL 94	
Screw connection solid / stranded / AWG	
<b>Safety data as per ATEX</b>	
Max. voltage $U_i$	
Max. current $I_i$	
Max. power $P_i$	
Max. voltage $U_o$	
Max. current $I_o$	
Max. power $P_o$	
Gas group	
- Max. external inductance $L_o$	[mH]
- Max. external capacitance $C_o$	[µF]
Max. ambient temperature	
<b>Conformance / approvals</b>	
Conformance	
ATEX	
UL, USA / Canada	
Functional Safety (SIL)	

Pt, Ni (100, 500, 1000); min. measuring range 10 K
B, C, D, E, J, K, L, N, R, S, T, U; min. measuring range 50 K/500 K
10 Ω ... 400 Ω (min. measuring range 10 Ω)
10 Ω ... 2000 Ω (min. measuring range 100 Ω)
-10 mV ... 75 mV (min. measuring range 5 mV)
Yes, programmable
4 mA ... 20 mA / 20 mA ... 4 mA
≤ 23 mA
≤ 630 Ω (at $U_V = 24 V$ ; $U_{supply} = 10 V / 0.023 A$ )
NE 43
≤ 3.6 mA or ≥ 21 mA (adjustable, not for thermocouples)
≤ 3.6 mA or ≥ 21 mA (adjustable)
3.8 mA ... 20.5 mA (linear increase/decrease)
12 V DC ... 30 V DC
< 3.5 mA
< 2 s
0.2 K (Pt 100, Ni 100), 0.5 K (Pt 500, Ni 500), 0.3 K (Pt 1000, Ni 1000)
Type 0.5 K (K, J, T, E, L, U), 1.0 K (N, C, D), 2.0 K (S, B, R)
± 0.1 Ω (10...400 Ω), ± 1.5 Ω (10...2000 Ω)
± 20 µV (-10...75 mV)
2 kV AC (50 Hz, 1 min.)
6 s
IP00, IP66 (integrated in the connecting head)
Connecting head in acc. with DIN 43729 form B
Installation in connection head according to DIN 43729 form B
NAMUR recommendation NE 21
Polycarbonate, PC
V0
0.2 ... 1.75 mm <sup>2</sup> / 0.2 ... 1.75 mm <sup>2</sup> / 24 - 15
30 V
100 mA
750 mW
5 V DC
5.4 mA
6.6 mW
IIA IIB IIC
100 100 100
9.9 9.9 2
Category 1: T4 = 60°C, T5 = 50°C, T6 = 40°C
Category 2: T4 = 85°C, T5 = 70°C, T6 = 55°C

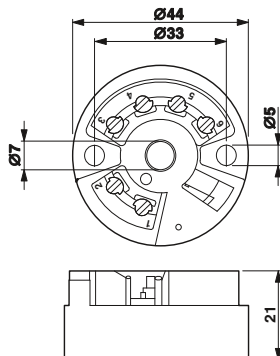

<b>Description</b>
MCR temperature transducer, smart, for resistance thermometers, thermocouples, resistance-type sensors and voltage sensors

### Ordering data

Type	Order No.	Pcs. / Pkt.
MCR-FL-HT-TS-I-EX	2864545	1

**Programmable loop-powered temperature transducer with connection heads, Ex i**

- 1-channel
- Loop-powered
- Input for resistance thermometers, thermocouples, and linear mV signals, Ex ia IIC
- Output 4...20 mA/20...4 mA
- Can be installed in zone 0
- 2-way electrical isolation
- Configuration using software

**Notes:**  
 The devices are supplied with the standard configuration: Pt 100 sensor, measuring range 0 ... 100°C, 3-wire connection.  
 You can implement your own measuring range settings, linearization, and characteristic curve adjustments. For this purpose, you need the MCR-PAC-T-USB programming adapter and the MCR/PI-CONF-WIN configuration software, see page 226

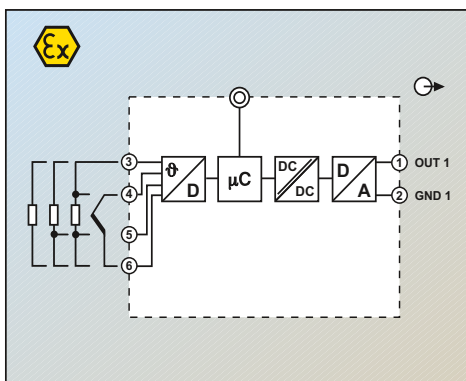

Block diagram MCR-FL-HT-T-I-EX



Loop-powered, programmable

ERC

Ex:

**Technical data**

<b>Measuring input</b>	Resistance thermometers Thermocouple sensors	Pt, Ni (100, 500, 1000); min. measuring range 10 K B, C, D, E, J, K, L, N, R, S, T, U; min. measuring range 50 K/500 K
Resistor		10 Ω ... 400 Ω (min. measuring range 10 Ω) 10 Ω ... 2000 Ω (min. measuring range 100 Ω) -10 mV ... 100 mV (min. measuring range 5 mV) Yes, programmable
<b>Measuring output</b>	Output signal range Maximum output signal Load Line monitoring Short-circuit current	4 mA ... 20 mA / 20 mA ... 4 mA ≤ 25 mA ≤ 720 Ω (For U <sub>v</sub> = 24 V; U <sub>supply</sub> = 8 V / 0.025 A) NE 43 ≤ 3.6 mA or ≥ 21 mA (adjustable, not for thermocouples)
Output current with open circuit		≤ 3.6 mA or ≥ 21 mA (adjustable)
Output current, measuring range overrange/underrange		3.8 mA ... 20.5 mA (linear increase/decrease)
<b>General data</b>	Supply voltage range Current consumption Step response (10-90%) Transmission error	8 V DC ... 30 V DC < 3.5 mA < 2 s Resistance thermometers: 0.2 K (Pt 100, Ni 100), 0.5 K (Pt 500, Ni 500), 0.3 K (Pt 1000, Ni 1000) Thermocouple sensors: Type 0.5 K (K, J, T, E, L, U), 1.0 K (N, C, D), 2.0 K (S, B, R)
Test voltage input/output		Resistance-type sensors: ± 0.1 Ω (10...400 Ω), ± 1.5 Ω (10...2000 Ω) Voltage sensor: ± 20 µV (-10...100 mV) 2 kV AC (50 Hz, 1 min.)
Switch on delay time		6 s
Degree of protection		IP00, IP66 (integrated in the connecting head)
Mounting position		Connecting head in acc. with DIN 43729 form B
Connection		Installation in connection head according to DIN 43729 form B
Standards/regulations		NAMUR recommendation NE 21
Housing material		Polycarbonate, PC
Inflammability class in acc. with UL 94		V0
Screw connection solid / stranded / AWG		0.2 ... 1.75 mm <sup>2</sup> / 0.2 ... 1.75 mm <sup>2</sup> / 24 - 15
<b>Safety data as per ATEX</b>	Max. voltage U <sub>i</sub> Max. current I <sub>i</sub> Max. power P <sub>i</sub> Max. voltage U <sub>o</sub> Max. current I <sub>o</sub> Max. power P <sub>o</sub> Gas group - Max. external inductance L <sub>o</sub> [mH] - Max. external capacitance C <sub>o</sub> [µF] Max. ambient temperature	30 V 100 mA 750 mW 8.2 V DC 4.6 mA 9.35 mW IIB IIC 8.5 4.5 1.9 0.974 Category 1: T4 = 60°C, T5 = 50°C, T6 = 40°C Category 2: T4 = 85°C, T5 = 70°C, T6 = 55°C
<b>Conformance / approvals</b>	Conformance ATEX UL, USA / Canada	CE-compliant II 1 G Ex ia IIC T6/T5/T4 cULus

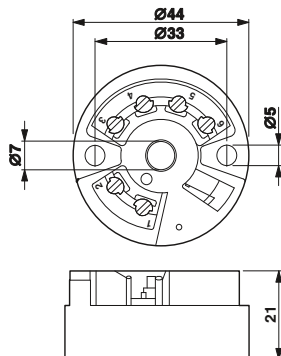

**Description**  
 MCR temperature transducer, for resistance thermometers, thermocouples, resistance-type sensors and voltage sensors

**Ordering data**

Type	Order No.	Pcs. / Pkt.
MCR-FL-HT-T-I-EX	2864532	1



### Accessories

#### Configuration software package

The **MCR/PI-CONF-WIN** configuration software package is used to configure and visualize all parameters for the programmable loop-powered temperature transducers.

- For temperature transducers:
  - MCR-FL-T(S)-LP-I-EX and
  - MCR-FL-HT-T(S)-I-EX
- Electrically isolated
- Configuration possible during operation
- Straightforward menu interface
- Rapid programming

The computer and the measuring transducer communicate with one another via a software adapter cable and a serial interface.

**Notes:**  
The software runs under the following operating systems: Windows NT™, 2000™, and XP™.



Description
<b>MCR configuration software</b> , for programming MCR-T-..., MCR-...-LP-..., MCR-...-HT-..., MCR-S-..., MCR-F-..., and MCR-PSP-... modules; CD-ROM

Ordering data		
Type	Order No.	Pcs. / Pkt.
MCR/PI-CONF-WIN	2814799	1

### Accessories

#### USB adapter cable

##### Software adapter cable

For connecting the programmable MCR-/PI modules to the USB interface of a computer, the USB adapter cable **CM-KBL-RS232/USB** can be used together with the relevant adapter cables. Programming with the MCR/PI-CONF-WIN software is supported under Windows 98™, Windows 2000™ and Windows XP™.

The following modules are supported:

- MCR-FL-T-LP-I-EX
- MCR-FL-HT-T-I-EX



Description
<b>USB adapter cable</b> , D-9-SUB to USB, with adapter D-9-SUB to D-25-SUB
<b>Software adapter cable</b> , 2.4 m in length, with USB connection, for programming MCR-...-LP-... and MCR-...-HT-... modules

Ordering data		
Type	Order No.	Pcs. / Pkt.
CM-KBL-RS232/USB	2881078	1
MCR-PAC-T-USB	2309000	1

<b>Adapter cable</b> , flexible, 9-pos. D-SUB socket to 25-pos. D-SUB pin
---

Accessories		
Type	Order No.	Pcs. / Pkt.
PSM-KAD 9 SUB 25/BS	2761295	1

## Accessories

**Shield fast connection**

- For connecting cable shielding to cable terminal points
- Can be connected to PLUGTRAB PT
- Easy assembly



Description	Ordering data		
	Type	Order No.	Pcs. / Pkt.
<b>Shield fast connection</b> , for connection to PLUGTRAB PT			
For Ø 3-6 mm	<b>SSA 3-6</b>	<b>2839295</b>	10
For Ø 5-10 mm	<b>SSA 5-10</b>	<b>2839512</b>	10

## Accessories

**Test plug**

Description	Color	Ordering data		
		Type	Order No.	Pcs. / Pkt.
<b>Test plug</b> , consisting of:				
<b>Metal part</b> for 2.3 mm Ø socket hole and	silver	<b>MPS-MT</b>	<b>0201744</b>	10
<b>Insulating sleeve</b> , for MPS metal part	red	<b>MPS-IH RD</b>	<b>0201676</b>	10
	white	<b>MPS-IH WH</b>	<b>0201663</b>	10
	blue	<b>MPS-IH BU</b>	<b>0201689</b>	10
	yellow	<b>MPS-IH YE</b>	<b>0201692</b>	10
	green	<b>MPS-IH GN</b>	<b>0201702</b>	10
	gray	<b>MPS-IH GY</b>	<b>0201728</b>	10
	black	<b>MPS-IH BK</b>	<b>0201731</b>	10



# Monitoring

## Measuring power and energy

EMpro energy meters measure, analyze, and communicate electrical system parameters.

Monitoring software ensures efficient energy and power measurement.

Stand-alone data loggers are the complete package for decentralized data acquisition.

PSK sensors acquire the operating pressure of gaseous media.

PSK meters record compressed air consumption.

## Current measurement

PACT current transformers convert currents up to 4000 A into secondary currents of 1 and 5 A.

MCR current transducers convert currents into standard analog signals.

## Monitoring and diagnostics

The SOLARCHECK modular monitoring system is used for string monitoring in photovoltaic systems.

RCM devices provide residual current monitoring in grounded power supply systems. They detect residual currents at an early stage before they result in forced shutdown.

EV Charge Control is the charging controller used to charge electric vehicles on the AC mains according to IEC 61851-1.

EMD monitoring relays detect and indicate deviations in important system parameters at an early stage.

ETD timer relays are used for straightforward time control functions.

Diode modules, lamp testing modules, and EMG display modules allow industrial use of simple components such as diodes - with professional housing and connection technology.

## Product range overview

<b>Product overview</b>	<b>230</b>
<b>Measuring power and energy</b>	<b>232</b>
EMpro energy meters	238
EMpro function and communication modules	240
Accessories	243
Software for usage data acquisition	244
Complete packages for data logging	245
Pressure sensors and compressed air meters	246
<b>Current measurement</b>	
Current transformers	250
Current transformer selection guide	252
PACT current transformers	253
Accessories for PACT current transformers	263
PACT RCP current transformers for retrofitting	266
Current transducers	272
Accessories for current transducers	280
<b>Monitoring and diagnostics</b>	
Solar system monitoring	282
Residual current monitoring	286
Components for E-Mobility	290
EMD electronic monitoring relays	296
ETD electronic timer relays	308
Diode modules, lamp testing modules, EMG display modules	312

# Monitoring

## Product overview

### Measuring power and energy



EMpro energy meters for front-panel installation Page 238



EMpro energy meters for DIN rail mounting Page 239



Function and communication modules for EMpro Page 240



DIN rail adapter for EMpro Page 243

### Current transformers



PACT bus-bar current transformers Page 252  
Can be calibrated Page 264



PACT window-type current transformers Page 254  
Can be calibrated Page 264



PACT winding current transformer Page 262



PACT RCP... current transformers for retrofitting Page 268

### Solar system monitoring



Accessories Page 226  
Configuration software and USB adapter cable



SOLARCHECK PV string monitoring Communication module Page 282



SOLARCHECK PV string monitoring Current measuring module Page 285



SOLARCHECK PV string monitoring Voltage measuring module Page 285

### Timer relays



EMD Multifunctional monitoring relays Page 300



ETD-BL Ultra-narrow timer relays Page 308



ETD Multifunctional timer relays Page 310

### Function modules



EMG Diode modules, lamp testing modules, display modules Page 312





Software for usage data acquisition  
Page 244



Complete packages for data logging  
Page 245



Pressure sensor with IO-Link  
Page 248



Compressed air meters  
Page 246

### Current measurement



Mounting accessories, shock protection  
Page 263



MCR current transducers for AC/DC and distorted currents  
Page 272



MCR current transducers for sinusoidal and distorted AC currents  
Passive, up to 5 A  
Page 276  
Page 278



MCR current protector for AC currents, sinusoidal up to 16 A  
Page 279

### Residual current monitoring



RCM residual current monitoring for DC residual currents and pulsating DC and AC residual currents  
Page 288

### Components for E-Mobility



EV Charge Control  
Charging controller  
Page 292



EV Charge Lock Release  
Mains failure plug release  
Page 292

### Monitoring relays



EMD-BL  
Compact monitoring relays  
Page 298

### Lightning monitoring system



Lightning monitoring system  
See Catalog 6

### HMIs



HMIs  
See Catalog 8

### Signal towers



Signal towers  
See Catalog 8





### Energy costs at a glance

Within industry, energy is viewed as a variable cost factor. As a result, lower energy costs are becoming increasingly important in terms of providing companies with a major competitive advantage in the areas of production, process, and industrial engineering.

Alongside energy consumption, the quality of the energy supplied, the reliability of supply, and effective system utilization also play an important role in ensuring profitability. This calls for continuous measurement and analysis of all sources of energy.

### Advantages of energy data acquisition

Continuously recorded energy flow provides the basis for a target-oriented energy management system.

Access comprehensive information regarding the characteristic electrical data of your machinery and benefit from the advantages of this:

- Reduce your energy costs by identifying potential energy savings.
- Optimize your system capacity: through intelligent switching of system parts, uniform network load, and reduced harmonics.
- Reduce peak loads using forward-looking trend calculation and load management.
- Safeguard your production processes and minimize downtimes by continuously monitoring important system parameters.

### Measurement – monitoring – communication

Efficient energy management – network-capable EMpro energy meters can be used to acquire and monitor the characteristic electrical data of your machines and systems.

They can be freely extended with communication modules and function modules, enabling your energy meters to keep pace with your growing requirements. Future-proof planning and investment is therefore ensured.



### The communication expert

The EMpro MA600 is capable of performing all measurement tasks associated with power supply applications up to 700 V AC.

- From simple current and power measurement to the detection of harmonics including spectral analysis
- Flexible integration into Ethernet, PROFIBUS or RS-485 networks
- Remote access via web server
- Optional DIN rail adapter for DIN rail mounting
- Can be extended with communication modules and function modules



### The universal solution on the front panel

The EMpro MA400 performs standard measuring tasks up to 519 V AC.

- Optional DIN rail adapter for DIN rail mounting
- Communication module for integration into RS-485 networks (Modbus/RTU)
- Function module for pulse or alarm output



### The measuring device with RS-485 communication

The EMpro MA250 performs standard measuring tasks up to 519 V AC.

- DIN rail device
- With pulse or alarm output
- Integrated RS-485 communication (Modbus/RTU)

### The measuring device with pulse output

The EMpro MA200 is ideal for simple measuring tasks up to 519 V AC.

- DIN rail device
- With pulse or alarm output



### Software for usage data acquisition

In conjunction with a 100-series modular controller, the EMwise software from Phoenix Contact is the efficient solution for recording energy data related to heat, cold, air, or electricity. You can therefore keep an eye on your resources at all times and efficiently manage their use in your machines and systems.



### Sensors and meters

Use of resources at a glance - determine all relevant states using sensors and meters.

- Detailed procurement measurement, thanks to precise sensor and meter technology
- Intelligent sensor communication, thanks to IO-Link technology



### Inline power measurement terminal

The Inline power measurement terminal enables analysis of AC networks.

- For measuring current, voltage, and power, as well as identifying distortion and harmonics
- The power measurement terminal can be found in Catalog 8, Control technology, I/O systems, and network structure.

# Monitoring

## Measuring power and energy

### Energy meters

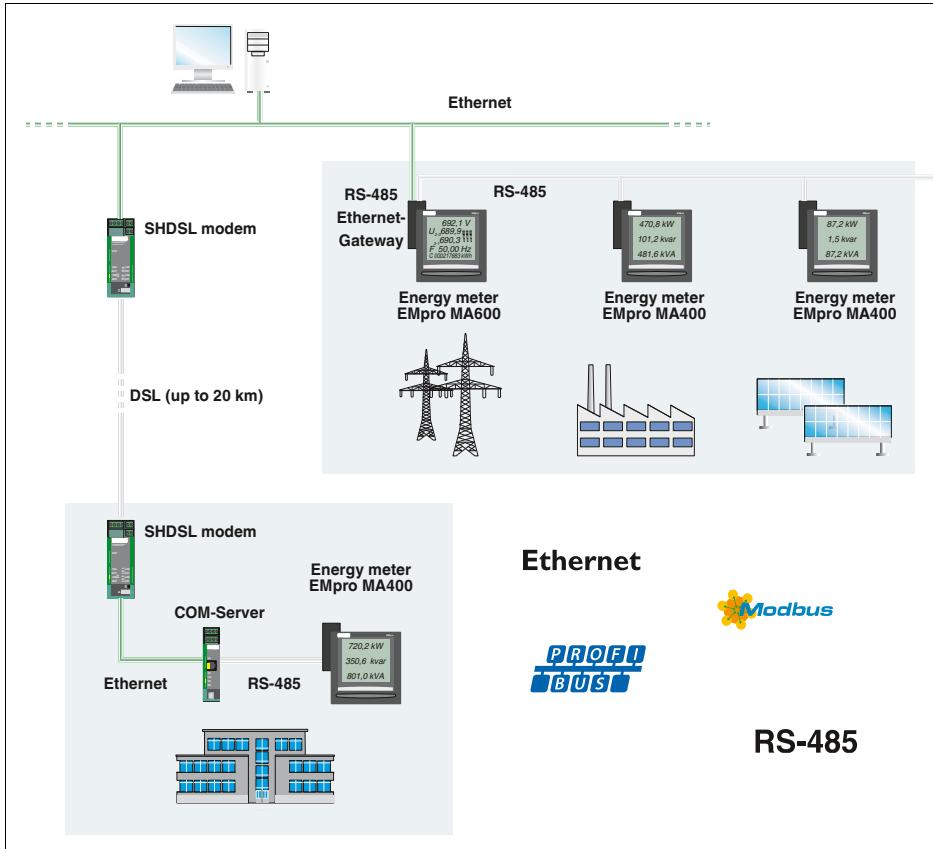

### Measurement – monitoring – communication

In order to achieve efficient energy management, all energy data that has been determined is acquired and analyzed centrally in the control center.

For data transmission, integrate the EMpro measuring devices flexibly into your network structures.

The network components from Phoenix Contact offer interference-free and high-performance communication of energy data, even in harsh industrial environments:

- Copper-based and fiber optic data transmission
- Ethernet and modem communication
- Industrial wireless transmission



#### Direct access to measured values

Analyze your system parameters quickly on site. At the touch of a button, you can access precisely those measured values that are of relevance.

You can also use the user-friendly web server function to request measured values directly from the control center.



#### Planning reliability and investment security

EMpro extension modules, function modules, and communication modules enable you to remain flexible and extend your EMpro measuring devices at any time:

- Digital inputs and outputs
- Pulse outputs
- Analog outputs
- Communication interfaces
- Measured mass storage
- Temperature measurement



#### Remote access to multiple meters - with just one IP address

The web server that has been integrated into the Ethernet communication modules allows you to conveniently configure key parameters online. It also allows remote access to key electrical characteristics such as current, voltage, power, energy, and harmonics.

## Selection guide

You can easily select the right device for your application by referring to the table below:



Product type	EMpro MA600	EMpro MA400	EMpro MA200/250
	2901366 EEM-MA600	2901364 EEM-MA400	2901362 EEM-MA200
	2902352 EEM-MA600-24DC		2901363 EEM-MA250
<b>Voltages</b>			
Voltage measurement direct	up to 700 V	up to 519 V	up to 519 V
Voltage converter	up to 500 kV		
Voltages U12, U23, U31, V1, V2, V3	•	•	•
Maximum mean value	•		
Mean value	•		
<b>Currents</b>			
Current measurement	direct up to 6 A or current transformer	Current transformer	Current transformer
Currents I1, I2, I3	•	•	•
Neutral conductor current IN (calculation)	•	•	•
Maximum mean value	•	•	•
Mean value	•		
<b>Frequency</b>			
F	•	•	•
Maximum mean value	•		
Mean value	•		
<b>Power</b>			
Real power, reactive power, apparent power: $\Sigma P$ (+/-), $\Sigma Q$ (+/-), $\Sigma S$ (+/-)	•	•	•
P, Q, S per phase	•	•	•
Maximum mean value	•	•	•
Mean value	•		
Trend performances	•		
<b>Power factor</b>			
$\Sigma PF$	•	•	•
PF per phase	•	•	•
<b>Metering</b>			
Real energy (kWh)	kWh+/kWh-	kWh+	kWh+
Reactive power (kvarh)	kvarh+/kvarh-	kvarh+	kvarh+
Apparent energy (kVAh)	kVAh		
Multi-tariff meter			2
Operating hours	•	•	•
<b>Accuracy class (EN62053-22)</b>	0.5 S	0.5 S	0.5 S
<b>Harmonics analysis</b>			
Distortion factor THD I/U/V	up to 63rd	up to 51st	up to 51st
Spectral analysis	up to 63rd		
<b>Functions</b>			
Temperature recording			•
Digital input			•
<b>Function modules (optional)</b>			
1 pulse or alarm output		2904314 EEM-IMP-MA400	Integrated
2 pulse outputs	2904313 EEM-IMP-MA600		
2 digital inputs, 2 digital outputs	2901371 EEM-2DIO-MA600		
2 analog outputs	2901475 EEM-2AO-MA600		
3 Pt100 inputs and 1 internal temperature measurement	2901949 EEM-TEMP-MA600		
Memory	2901370 EEM-MEMO-MA600		
<b>Communication modules (optional)</b>			
RS-485 (Modbus/RTU)	2901367 EEM-RS485-MA600	2901365 EEM-RS485-MA400	integrated (MA250 only)
D-SUB (PROFIBUS)	2901418 EEM-PB12-MA600		
Ethernet gateway (Modbus/TCP/RTU) with integrated web server	2901374 EEM-ETH-RS485-MA600		
Ethernet (Modbus/TCP) with integrated web server	2901373 EEM-ETH-MA600		

### Key

I1, I2, I3 Conductor currents  
 IN Neutral conductor current  
 U12, U23, U31 Phase conductor voltages  
 V1, V2, V3 Phase/N conductor voltages

P Real power  
 Q Reactive power  
 S Apparent power  
 PF Power factor

THD Total harmonic distortion  
 $\Sigma$  Total values

# Monitoring

## Measuring power and energy

Transmit electrical characteristics wirelessly and easily

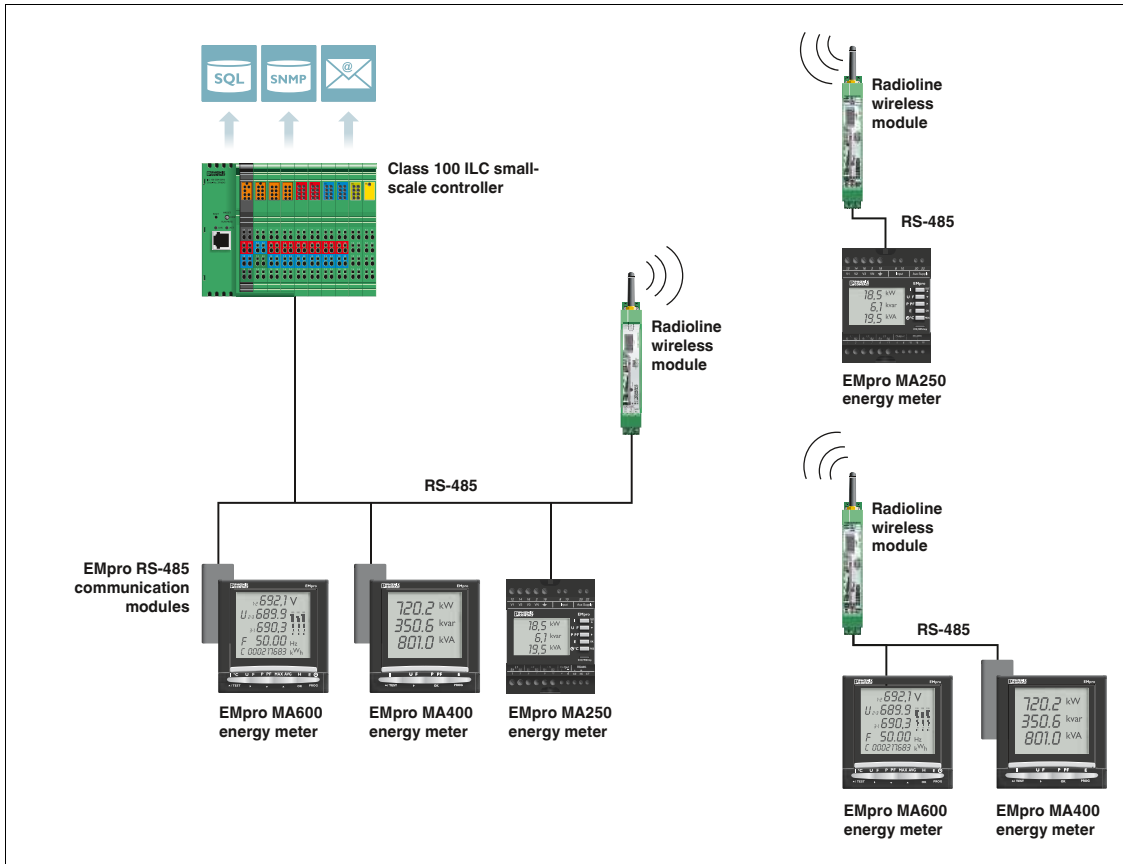

## Direct connection from the PC to the EMpro MA600

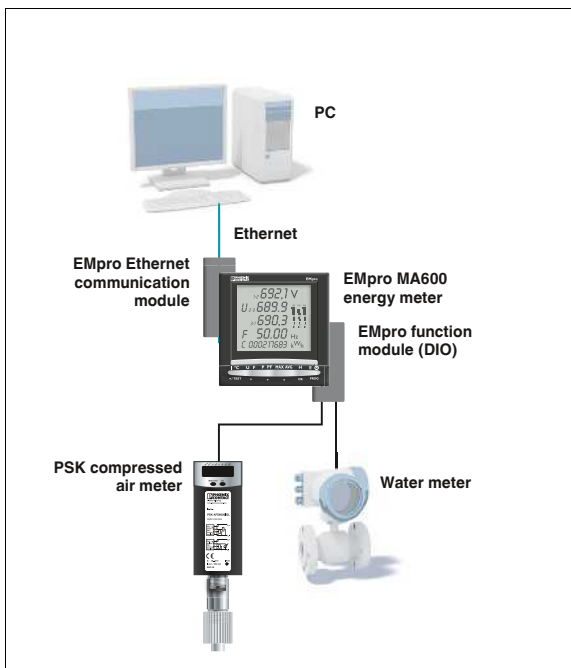

Connect up to six external meters to one EMpro MA600

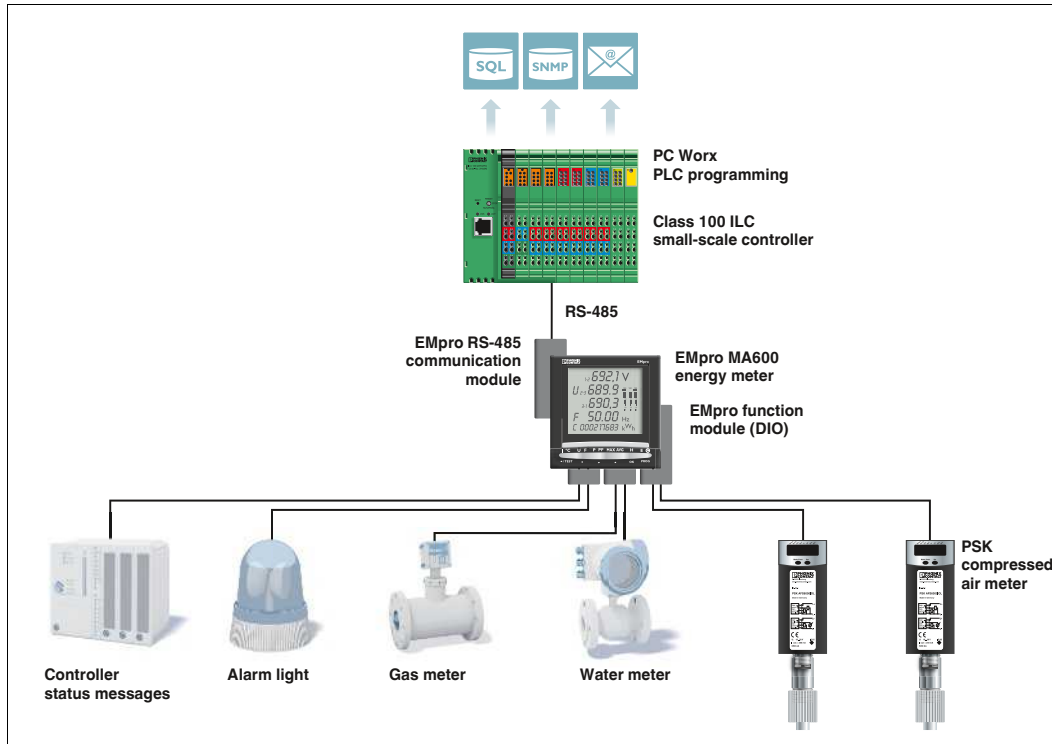

Easy machine monitoring - communicate electrical characteristics via Modbus/RTU

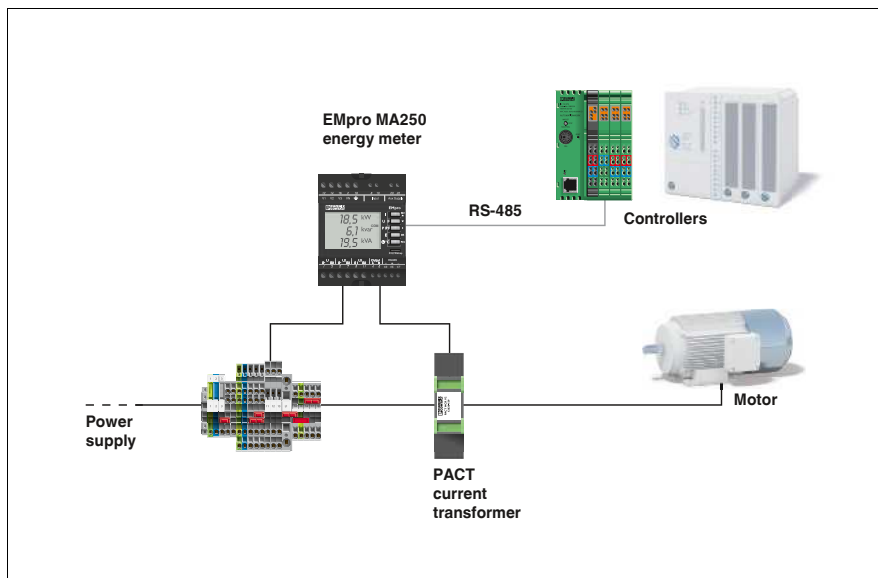



# Monitoring

## Measuring power and energy

### Energy meters

EMpro energy meters are capable of acquiring, monitoring, and displaying all electrical system and machine parameters locally.

#### EEM-MA600

- Can be extended with function and communication modules
- Remote access via web server, integrated into Ethernet communication module
- Acquisition of individual harmonic components up to 63rd order
- Trend calculation for real and reactive power

#### EEM-MA400

- Can be extended with output module
- Can be extended with RS-485 communication module (JBUS/MODBUS)
- Acquisition of total harmonic content up to 51st order

#### EEM-MA250

- Two-tariff measurement via digital input
- Pulse or alarm output
- RS-485 interface (JBUS/MODBUS)

#### EEM-MA200

- Two-tariff measurement via digital input
- Pulse or alarm output

#### EEM-MKT-DRA

- DIN rail adapter for the EEM-MA600 and EEM-MA400 front panel devices see page 243.

#### Notes:

The EEM-MA600-24DC energy meter (Order No. 2902352) is not CE-compliant.



Measuring voltage up to 700 V AC, can be extended with function and communication modules



<b>Input data</b>	Measuring principle Acquisition of harmonics Measured value Voltage measuring input V1, V2, V3 Input voltage range
<b>Accuracy</b>	Current measuring input I1, I2, I3 Input current range (via external transformers)
<b>Overload capacity</b>	Operate threshold Accuracy
<b>Power measurement</b>	Measuring range
<b>Accuracy</b>	Real power (IEC 62053-22) Reactive power (IEC 62053-23)
<b>Digital input</b>	Voltage input signal
<b>Switching output</b>	Output description Maximum switching voltage Current carrying capacity
<b>Serial port</b>	Output description Serial transmission speed
<b>Display</b>	Type Measuring rate
<b>General data</b>	Supply voltage Nominal power consumption
<b>Degree of protection</b>	Ambient temperature range Dimensions W / H / D Installation depth with extension module Connection cross section (solid / stranded / AWG)
<b>EMC note</b>	Voltage and other connections Current connection
<b>Conformance / approvals</b>	CE-compliant

Technical data	
True r.m.s. value measurement up to 63rd harmonic AC sine (50/60 Hz)	
18 V AC ... 700 V AC (phase/phase) 11 V AC ... 404 V AC (phase/neutral conductor) 500 kV AC (Primary, via external voltage transducers) Secondary: 60, 100, 110, 115, 120, 173, 190 V AC	
0.2 %	
9999 A (primary) 1 A and 5 A, secondary 6 A (permanent) 10 mA	
0.2 %	
0 MW ... 8000 MW / 0 Mvar ... 8000 Mvar / 0 MVA ... 8000 MVA	
0.5 % Class 0.5 S Class 2	
Via function module	
Via function module - -	
Via communication module -	
LCD display, backlighting 1 s	
10 VA 20 VA (with maximum number of extension modules) IP52 (front), IP30 (back) -10 °C ... 55 °C (14 °F to 131 °F) 96 / 96 / 82 mm 80 mm	
0.5 ... 2.5 mm <sup>2</sup> / 0.5 ... 2.5 mm <sup>2</sup> / 20 - 14 0.5 ... 6 mm <sup>2</sup> / 0.5 ... 6 mm <sup>2</sup> / 20 - 8 Class A product, see page 625	
CE-compliant	

Description
<b>Energy meter</b> , for front-panel installation
<b>Energy meter</b> , for front-panel installation, 24 V DC
<b>Energy meter</b> , for mounting on a DIN rail

Ordering data		
Type	Order No.	Pcs. / Pkt.
EEM-MA600	2901366	1
EEM-MA600-24DC	2902352	1



Measuring voltage up to 519 V AC, can be extended with RS-485 interface and output module



Measuring voltage up to 519 V AC, DIN rail installation, also with RS-485 interface



Technical data
True r.m.s. value measurement up to 51st harmonic AC sine (50/60 Hz)
50 V AC ... 500 V AC (phase/phase) 28 V AC ... 289 V AC (phase/neutral conductor)
0.2 %
9999 A (primary) 5 A (secondary) 6 A (permanent) 5 mA 0.2 %
0 MW ... 11 MW / 0 Mvar ... 11 Mvar / 0 MVA ... 11 MVA
0.5 % Class 0.5 S Class 2
-
Via function module -
Via communication module -
LCD display, backlighting 1 s
5 VA 10 VA (with maximum number of extension modules) IP52 (front), IP30 (back) -10 °C ... 55 °C (14 °F to 131 °F) 96 / 96 / 82 mm 80 mm
0.5 ... 2.5 mm <sup>2</sup> / 0.5 ... 2.5 mm <sup>2</sup> / 20 - 14 0.5 ... 6 mm <sup>2</sup> / 0.5 ... 6 mm <sup>2</sup> / 20 - 8 Class A product, see page 625
CE-compliant

Technical data
True r.m.s. value measurement up to 51st harmonic AC sine (50/60 Hz)
50 V AC ... 519 V AC (phase/phase) 28 V AC ... 300 V AC (phase/neutral conductor)
0.2 %
9999 A (primary) 5 A (secondary) 6 A (permanent) 5 mA 0.2 %
0 kW ... 9999 kW / 0 kvar ... 9999 kvar / 0 kVA ... 9999 kVA
0.5 % Class 0.5 S Class 2
230 V AC ±10 % (tariff switchover: e.g., day/nighttime tariff)
Transistor output, active 30 V DC 27 mA
EEM-MA250                      EEM-MA200 Modbus RTU/JBUS RS-485      None 2.4 ... 38.4 kbps
LCD display, backlighting 1 s
5 VA IP51 (front), IP20 (back) -10 °C ... 55 °C (14 °F to 131 °F) 72 / 90 / 64 mm
0.5 ... 2.5 mm <sup>2</sup> / 0.5 ... 2.5 mm <sup>2</sup> / 20 - 14 0.5 ... 4 mm <sup>2</sup> / 0.5 ... 4 mm <sup>2</sup> / 20 - 10 Class A product, see page 625
CE-compliant

Ordering data		
Type	Order No.	Pcs. / Pkt.
EEM-MA400	2901364	1

Ordering data		
Type	Order No.	Pcs. / Pkt.
EEM-MA250	2901363	1
EEM-MA200	2901362	1

# Monitoring

## Measuring power and energy

### Function modules

Plug-in function modules for the EEM-MA600 energy meter.

#### EEM-2DIO-MA600

- Two digital inputs and outputs
- Configurable threshold values

#### EEM-2AO-MA600

- Two 0 ... 20 mA/4 ... 20 mA analog outputs, configurable



Two digital inputs, two digital outputs



Two analog outputs

	Technical data			Technical data		
Digital input						
Voltage input signal	10 V DC ... 30 V DC			-		
Input pulse length	10 ms			-		
Output						
Output description	Relay output			Current output		
Maximum switching voltage	250 V AC/DC			-		
General data						
Supply voltage	9 V (via EEM-MA600)			9 V (via EEM-MA600)		
Degree of protection	IP20			IP20		
Ambient temperature range	-10 °C ... 55 °C (14 °F to 131 °F)			-10 °C ... 55 °C (14 °F to 131 °F)		
EMC note	Class A product, see page 625			Class A product, see page 625		
Conformance / approvals						
Conformance	CE-compliant			CE-compliant		
UL, USA / Canada	UL 61010-1			UL 61010-1		
	Ordering data			Ordering data		
Description	Type	Order No.	Pcs. / Pkt.	Type	Order No.	Pcs. / Pkt.
Function module (for EEM-MA600)	EEM-2DIO-MA600	2901371	1	EEM-2AO-MA600	2901475	1

### Function module

Plug-in function module for the EEM-MA600 energy meter.

#### EEM-MEMO-MA600

- Stores P (+/-) and Q (+/-) with an internal or external synchronization pulse of 5, 8, 10, 20, 30 or 60 minutes, e.g., synchronization pulse of 15 minutes over 45 days
- Stores the last ten alarms with time stamp (2DIO function module necessary)
- Stores the last smallest and largest instantaneous values for voltages, currents, frequency, actual power, reactive power, entire harmonic distortion
- Stores the mean values of the cable voltage, line to line voltage and frequency (maximum 60 days)
- Stores undervoltage, surge voltage, and phase failure
- Cannot be combined with PROFIBUS communication module



Memory module

	Technical data		
Digital input			
Voltage input signal	10 V DC ... 30 V DC		
General data			
Supply voltage	9 V (via EEM-MA600)		
Memory size	512 kByte		
Degree of protection	IP20		
Ambient temperature range	-10 °C ... 55 °C (14 °F to 131 °F)		
EMC note	Class A product, see page 625		
Conformance / approvals			
Conformance	CE-compliant		
UL, USA / Canada	UL 61010-1		
	Ordering data		
Description	Type	Order No.	Pcs. / Pkt.
Function module (for EEM-MA600) Memory module	EEM-MEMO-MA600	2901370	1

## Communication modules

**EEM-PB 12-MA600**

- PROFIBUS DP, with transmission speeds of 12 Mbps

**EEM-RS485-MA...**

- JBUS/Modbus/RTU



Modbus/RTU (RS-485)



PROFIBUS

	Technical data			Technical data		
Serial port						
Output description	Modbus RTU/JBUS RS-485			PROFIBUS DP		
Serial transmission speed	2.4 ... 38.4 kbps			12 Mbps		
General data						
Supply voltage	9 V (Via EEM-MA600/EEM-MA400)			9 V (via EEM-MA600)		
Degree of protection	IP20			IP20		
Ambient temperature range	-10 °C ... 55 °C (14 °F to 131 °F)			-10 °C ... 55 °C (14 °F to 131 °F)		
EMC note	Class A product, see page 625			Class A product, see page 625		
Conformance / approvals						
Conformance	CE-compliant			CE-compliant		
UL, USA / Canada	UL 61010-1			UL 61010-1		
	Ordering data			Ordering data		
Description	Type	Order No.	Pcs. / Pkt.	Type	Order No.	Pcs. / Pkt.
<b>Communication module</b> (for EEM-MA400) RS-485 (JBUS/Modbus/RTU)	<b>EEM-RS485-MA400</b>	<b>2901365</b>	1			
<b>Communication module</b> (for EEM-MA600) RS-485 (JBUS/Modbus/RTU)	<b>EEM-RS485-MA600</b>	<b>2901367</b>	1			
D-SUB (PROFIBUS DP)				<b>EEM-PB 12-MA600</b>	<b>2901418</b>	1

## Communication modules

**EEM-ETH-MA600**

- Ethernet
- Modbus/TCP
- Integrated web server

**EEM-ETH-RS485-MA600**

- Ethernet gateway to RS-485
- Modbus/TCP / Modbus/RTU
- Integrated web server



Ethernet with integrated web server



Ethernet gateway with integrated web server

	Technical data			Technical data		
Serial port						
Output description	Modbus/TCP Ethernet (RJ45)			Modbus/TCP Ethernet (RJ45)		
Serial transmission speed	10/100 Mbps			10/100 Mbps		
General data						
Supply voltage	9 V (via EEM-MA600)			9 V (via EEM-MA600)		
Degree of protection	IP20			IP20		
Ambient temperature range	-10 °C ... 55 °C (14 °F to 131 °F)			-10 °C ... 55 °C (14 °F to 131 °F)		
EMC note	Class A product, see page 625			Class A product, see page 625		
Conformance / approvals						
Conformance	CE-compliant			CE-compliant		
UL, USA / Canada	UL 61010-1			UL 61010-1		
	Ordering data			Ordering data		
Description	Type	Order No.	Pcs. / Pkt.	Type	Order No.	Pcs. / Pkt.
<b>Communication module</b> (for EEM-MA600) Ethernet	<b>EEM-ETH-MA600</b>	<b>2901373</b>	1			
Ethernet gateway				<b>EEM-ETH-RS485-MA600</b>	<b>2901374</b>	1

# Monitoring

## Measuring power and energy

### Function modules

Plug-in function module for the EEM-MA400 energy meter.

#### EEM-IMP-MA400

- One configurable pulse output or one configurable threshold value



Pulse module

Technical data	
Output	Relay output
Output description	100 V DC
Maximum switching voltage	
General data	
Supply voltage	9 V (via EEM-MA400)
Degree of protection	IP20
Ambient temperature range	-10 °C ... 55 °C (14 °F to 131 °F)
Conformance / approvals	
Conformance	CE-compliant
UL, USA / Canada	UL 61010-1

Ordering data		
Type	Order No.	Pcs. / Pkt.
EEM-IMP-MA400	2904314	1

Description
<b>Function module</b> (for EEM-MA400) with one pulse or alarm output

### Function module

Plug-in function module for the EEM-MA600 energy meter.

#### EEM-IMP-MA600

- Two configurable pulse outputs



Pulse module

Technical data	
Output	Relay output
Output description	100 V DC
Maximum switching voltage	
General data	
Supply voltage	9 V (via EEM-MA600)
Degree of protection	IP20
Ambient temperature range	-10 °C ... 55 °C (14 °F to 131 °F)
Conformance / approvals	
Conformance	CE-compliant
UL, USA / Canada	UL 61010-1

Ordering data		
Type	Order No.	Pcs. / Pkt.
EEM-IMP-MA600	2904313	1

Description
<b>Function module</b> (for EEM-MA600) with two configurable pulse outputs

## Function module

Plug-in function module for the EEM-MA600 energy meter.

### EEM-TEMP-MA600

- Temperature recording for up to three Pt 100 temperature sensors
- Temperature measuring range  $-20^{\circ}\text{C} \dots +150^{\circ}\text{C}$
- Internal temperature recording of the ambient temperature  $-10^{\circ}\text{C} \dots +55^{\circ}\text{C}$
- CE-compliant



Temperature module

**Input data**  
Description of the input  
Temperature range

Transmission error

Basic accuracy

**General data**

Supply voltage

Degree of protection

Ambient temperature range

EMC note

#### Technical data

Pt 100 input: 2, 3, 4-wire  
 $-20^{\circ}\text{C} \dots 150^{\circ}\text{C}$  (connected sensors)  
 $-10^{\circ}\text{C} \dots 55^{\circ}\text{C}$  (in the immediate vicinity)  
 0.5 K/m (2-wire)  
 0.25 K/m (3-wire)  
 0 K/m (4-wire)  
 $\pm 1 \text{ K}$

9 V (via EEM-MA600)

IP20

$-10^{\circ}\text{C} \dots 55^{\circ}\text{C}$  ( $14^{\circ}\text{F}$  to  $131^{\circ}\text{F}$ )

Class A product, see page 625

#### Ordering data

Description

**Function module** (for EEM-MA600)  
for temperature recording

Type

Order No.

Pcs. /  
Pkt.

EEM-TEMP-MA600

2901949

1

## Accessories

### DIN rail adapter

- For mounting the EEM-MA600 or EEM-MA400 energy meters on a 35-mm DIN rail according to EN 60715



For mounting on DIN rails

**General data**

Vibration resistance

Weight

DIN rail clip material

Fixing sheet material

Dimensions W / H / D

#### Technical data

57 Hz ... 150 Hz (2 g)

265 g

Aluminum, natural anodized

Stainless steel VA

116 / 112 / 115 mm

#### Ordering data

Description

**DIN rail adapter** for EEM-MA600 and EEM-MA400

Type

Order No.

Pcs. /  
Pkt.

EEM-MKT-DRA

2902078

1



# Monitoring

## Measuring power and energy

### Software for usage data acquisition

The EMwise software from Phoenix Contact is the efficient solution for acquiring energy data regarding heat, cold, air or electricity in conjunction with a compact controller.

Integrate up to 24 digital inputs, 8 analog channels, 50 EMpro energy meters, 30 M-bus counters, and 4 IO-Link measuring sensors.

A web-based interface is available for system parameterization. Each device/channel can be configured individually, without any programming knowledge. The configuration is saved to a file and can be reused for identical systems.

#### Your advantages:

- Startup without programming knowledge
- Direct parameterization of predefined sensors

#### Three software versions, suitable for every application:

- EMWISE IMPULS: for up to 16 digital signals
- EMWISE IMP ANALOG: for up to 16 digital and 6 analog signals
- EMWISE EXTENDED: for up to 24 digital and 8 analog signals, EMpro energy meters, M-bus counters, M-bus level converters, IO-Link sensors



Monitoring software

#### Technical data

See [phoenixcontact.net/products](http://phoenixcontact.net/products)

#### Ordering data

Type	Order No.	Pcs. / Pkt.
SD FLASH 2GB EMWISE IMPULS	2701745	1
SD FLASH 2GB EMWISE IMP ANALOG	2701746	1
SD FLASH 2GB EMWISE EXTENDED	2701747	1

#### Description

**Program and configuration memory**, plug-in, 2 GB with license key and application program for reading from measuring devices via pulses

**Program and configuration memory**, plug-in, 2 GB with license key and application program for reading from measuring devices via pulses and analog values

**Program and configuration memory**, plug-in, 2 GB with license key and application program for reading from measuring devices via pulses, analog values, M-bus, Modbus RTU, and IO-Link

## Complete packages for data logging

The PSK RTU 50 is a multifunctional RTU (Remote Telemetry Unit), which combines the functions of a data logger, gateway, and alarm manager. The PSK RTU 50 offers various communication options, was developed with low power technology and allows independent operation, e.g., with batteries or solar cells.

**Your advantages:**

- GSM/GPRS modem
- Ethernet interface
- IEC 60870-5-101
- IEC 60870-5-104
- Modbus/RTU



Multifunctional data logger

Technical data			
Interfaces	RS-232 RS-232/-485 Serial Ethernet		
Digital inputs/outputs	4		
Number of inputs	2 (relay output)		
Analog inputs	2		
Number of inputs	2		
IEC-61131 runtime system			
Program memory	832 kByte		
Retentive mass storage	1 Mbyte		
Realtime clock	Yes (battery-backed)		
Power supply			
Supply voltage	24 V DC		
Typical current consumption	5 mA		
General data			
Weight	475 g		
Width	210 mm		
Height	110 mm		
Depth	45 mm		
Degree of protection	IP20		
Ambient temperature (operation)	-20 °C ... 65 °C		
Ordering data			
Description	Type	Order No.	Pcs. / Pkt.
Multifunctional data logger	PSK RTU 50	2400018	1

#### Compressed air meters

Use meters from Phoenix Contact to monitor the use of compressed air, an expensive production resource. By using compressed air efficiently, you can decrease compressor usage and therefore reduce energy costs. The calorimetric measuring procedure records even the smallest consumption rates. You can therefore detect wear or leaks based on the amount of air consumed.

#### Use compressed air meters to acquire the following values:

- The current volumetric flow according to ISO 2533 and DIN 1343
- The total volume used
- The temperature of the compressed air in the monitored operating processes

#### The compressed air meters impress thanks to their:

- Detailed reference measurement with flow rate, total volume, and temperature display
- Intelligent sensor communication, thanks to IO-Link technology
- A measuring range from 0.06 Nm<sup>3</sup>/h to 700.0 Nm<sup>3</sup>/h
- Flexible use, thanks to IP65 protection: resistant to dust and splash water

IO-Link



Compressed air meter up to 75 Nm<sup>3</sup>/h



Flow monitoring	
Measuring range	
Display range	
Repeatability	
Response time	
Measured value error	
Temperature monitoring	
Measuring range	
Display range	
Response time	
Resolution	
Accuracy	
Supply for module electronics	
Connection method	
No. of pos.	
Supply voltage range	
Current draw	
Digital outputs	
Pulse value	
Pulse length	
Delay time	
Analog outputs	
Type of protection	
Current output signal	
Load/output load current output	
General data	
Weight	
Width	
Height	
Depth	
Degree of protection	
Protection class	
Ambient temperature (operation)	
Ambient temperature (storage/transport)	
Vibration resistance in acc. with EN 60068-2-6/IEC 60068-2-6	

Technical data		
PSK AFS6050IOL	PSK AFS6000IOL	
	0.20 Nm <sup>3</sup> /h ... 75 Nm <sup>3</sup> /h	
	0.00 Nm <sup>3</sup> /h ... 90 Nm <sup>3</sup> /h	
	±1.5% of the measured value	
	< 0.1 s ((dAP = 0))	
±15 % of the measured value	Depending on the air quality:	
+1.5 % of the measuring range	±3% of the measured value +	
final value	0.3% of the measuring range	
	final value; ±6% of the measured	
	value + 0.6% of the measuring	
	range final value	
	0 °C ... 60 °C	
	-12 °C ... 72 °C	
	30 s (Q > 0.1 Nm <sup>3</sup> /h)	
	0.5 °C	
	± 2.5 °C (Q > 0.1 Nm <sup>3</sup> /h)	
	M12 connector	
	4	
	19 V DC ... 30 V DC	
	< 100 mA	
	0.0010 m <sup>3</sup> ... 1000000 m <sup>3</sup>	
	min. 0.04 s	
	0.5 s (operational readiness)	
	Short-circuit protection, polarity reversal protection	
	4 mA ... 20 mA	
	≤ 500 Ω	
	581 g	961 g
	45 mm	
	111 mm	300 mm
	79.5 mm	76.8 mm
	IP65	
	III	
	0 °C ... 60 °C	
	-20 °C ... 85 °C	
	5g (55 ... 2000 Hz)	

Description
<b>Compressed air meter:</b> G1/2 process connection, measuring range up to 75 Nm <sup>3</sup> /h
<b>Compressed air meter:</b> G1/2 process connection, measuring range up to 75 Nm <sup>3</sup> /h
<b>Compressed air meter:</b> R1/4 process connection, measuring range up to 15 Nm <sup>3</sup> /h
<b>Compressed air meter:</b> R1 process connection, measuring range up to 225 Nm <sup>3</sup> /h
<b>Compressed air meter:</b> R2 process connection, measuring range up to 700 Nm <sup>3</sup> /h

Ordering data		
Type	Order No.	Pcs. / Pkt.
PSK AFS6050IOL	2700704	1
PSK AFS6000IOL	2700707	1

IO-Link



Compressed air meter up to 15 Nm³/h

IO-Link



Compressed air meter up to 225 Nm³/h

IO-Link



Compressed air meter up to 700 Nm³/h



Technical data

Technical data

Technical data

0.04 Nm³/h ... 15 Nm³/h  
 0.00 Nm³/h ... 18 Nm³/h  
 ±1.5% of the measured value  
 < 0.1 s ((dAP = 0))  
 Depending on the air quality: ±3% of the measured value + 0.3% of the measuring range final value; ±6% of the measured value + 0.6% of the measuring range final value

0.70 Nm³/h ... 225 Nm³/h  
 0.00 Nm³/h ... 270 Nm³/h  
 ±1.5% of the measured value  
 < 0.1 s ((dAP = 0))  
 Depending on the air quality: ±3% of the measured value + 0.3% of the measuring range final value; ±6% of the measured value + 0.6% of the measuring range final value

2.30 Nm³/h ... 700 Nm³/h  
 0.00 Nm³/h ... 840 Nm³/h  
 ±1.5% of the measured value  
 < 0.1 s ((dAP = 0))  
 Depending on the air quality: ±3% of the measured value + 0.3% of the measuring range final value; ±6% of the measured value + 0.6% of the measuring range final value

0 °C ... 60 °C  
 -12 °C ... 72 °C  
 30 s (Q > 0.1 Nm³/h)  
 0.5 °C  
 ± 2.5 °C (Q > 0.1 Nm³/h)

0 °C ... 60 °C  
 -12 °C ... 72 °C  
 30 s (Q > 0.1 Nm³/h)  
 0.5 °C  
 ± 2.5 °C (Q > 0.1 Nm³/h)

0 °C ... 60 °C  
 -12 °C ... 72 °C  
 30 s (Q > 0.1 Nm³/h)  
 0.5 °C  
 ± 2.5 °C (Q > 0.1 Nm³/h)

M12 connector  
 4  
 19 V DC ... 30 V DC  
 < 100 mA

M12 connector  
 4  
 19 V DC ... 30 V DC  
 < 100 mA

M12 connector  
 4  
 19 V DC ... 30 V DC  
 < 100 mA

0.0010 m³ ... 1000000 m³  
 min. 0.2 s  
 0.5 s (operational readiness)

0.0030 m³ ... 3000000 m³  
 min. 0.02 s  
 1 s (operational readiness)

0.0100 m³ ... 4000000 m³  
 min. 0.043 s  
 0.5 s (operational readiness)

Short-circuit protection, polarity reversal protection  
 4 mA ... 20 mA  
 ≤ 500 Ω

Short-circuit protection, polarity reversal protection  
 4 mA ... 20 mA  
 ≤ 500 Ω

Short-circuit protection, polarity reversal protection  
 4 mA ... 20 mA  
 ≤ 500 Ω

887 g  
 45 mm  
 193.3 mm  
 74.5 mm  
 IP65  
 III  
 0 °C ... 60 °C  
 -20 °C ... 85 °C  
 5g (55 ... 2000 Hz)

2.053 kg  
 45 mm  
 475 mm  
 88.5 mm  
 IP65  
 III  
 0 °C ... 60 °C  
 -20 °C ... 85 °C  
 5g (55 ... 2000 Hz)

4.332 kg  
 133 mm  
 475 mm  
 -  
 IP65  
 III  
 0 °C ... 60 °C  
 -20 °C ... 85 °C  
 5g (55 ... 2000 Hz)

Ordering data

Ordering data

Ordering data

Type	Order No.	Pcs. / Pkt.
PSK AFS5000IOL	2700705	1

Type	Order No.	Pcs. / Pkt.
PSK AFS8000IOL	2700708	1

Type	Order No.	Pcs. / Pkt.
PSK AFS2000IOL	2700709	1

### Pressure sensor

#### Pressure sensor with IO-Link

Pressure sensors from Phoenix Contact detect the operating pressure of gas media in a range from -1 to 10 bar. The overload-proof ceramic measuring cell is designed for in excess of 100 million cycles and enables a high switching point accuracy. The pressure switch offers the option of using the set switching points via two switching outputs or reading all process data via the IO-Link interface.

#### Your advantages:

- IO-Link communication
- Parameterization, diagnostics, and process value monitoring via IO-Link
- Programmable function
- 4-character alphanumeric display

 IO-Link



Pressure sensor up to 10 bar



Pressure monitoring	
Measuring range	-1 bar ... 10 bar (minimum burst pressure 150 bar)
Pressure resistance	75 bar
Process connection	G1/4 I
Supply for module electronics	
Connection method	M12 connector
No. of pos.	4
Supply voltage range	18 V DC ... 36 V DC
Current draw	< 35 mA
Digital outputs	
Number of outputs	2 (OUT1 = switching output, OUT2 = switching output or diagnostic output)
Connection method	M12 connectors, assigned four times
Delay time	0.3 s (operational readiness)
IO-Link	
Specification	V1.1
Transmission speed	38.4 kbaud
General data	
Weight	263 g
Width	34 mm
Height	91.5 mm
Depth	48 mm
Degree of protection	IP65
Protection class	III
Ambient temperature (operation)	-25 °C ... 80 °C
Ambient temperature (storage/transport)	-40 °C ... 100 °C
Vibration resistance in acc. with EN 60068-2-6/IEC 60068-2-6	20g (10 Hz ... 2000 Hz)

Technical data	
Measuring range	-1 bar ... 10 bar (minimum burst pressure 150 bar)
Pressure resistance	75 bar
Process connection	G1/4 I
Supply for module electronics	
Connection method	M12 connector
No. of pos.	4
Supply voltage range	18 V DC ... 36 V DC
Current draw	< 35 mA
Digital outputs	
Number of outputs	2 (OUT1 = switching output, OUT2 = switching output or diagnostic output)
Connection method	M12 connectors, assigned four times
Delay time	0.3 s (operational readiness)
IO-Link	
Specification	V1.1
Transmission speed	38.4 kbaud
General data	
Weight	263 g
Width	34 mm
Height	91.5 mm
Depth	48 mm
Degree of protection	IP65
Protection class	III
Ambient temperature (operation)	-25 °C ... 80 °C
Ambient temperature (storage/transport)	-40 °C ... 100 °C
Vibration resistance in acc. with EN 60068-2-6/IEC 60068-2-6	20g (10 Hz ... 2000 Hz)

Description	
<b>Pressure sensor with indicator,</b> G1/4 I process connection, IO-Link communication	

Ordering data		
Type	Order No.	Pcs. / Pkt.
PSK APS7004IOL	2700710	1







### Extremely versatile

PACT current transformers offer a complete product range for converting alternating currents up to 4000 A into secondary currents of 1 A and 5 A. Depending on requirements, bus-bar, plug-in, and winding current transformers are available. PACT current transformers are available in different transformation ratios, accuracy classes, and rated powers - in 3000 versions, for your current measurement requirements.

### Also available for higher accuracy classes

For standard applications, such as in machine building or systems manufacturing, Phoenix Contact offers current transformers with accuracy classes 0.5 and 1 in a version that cannot be calibrated.

For higher accuracy or for billing purposes in energy supply, type-tested transformers that can be calibrated as well as calibrated transformers are available - with classes 0.2/0.2S/0.5 and 0.5S.



### Fast and secure installation

The current transformer quick-action mechanism offers the following advantages:

- Tool-free mounting
- Considerable reduction in installation time
- Easy handling and secure fastening by pressing with finger
- Current transformers align themselves – no need for subsequent alignment



### Variable and space-saving mounting

In addition to the vertical and horizontal mounting position, the optional accessories offer further installation options such as mounting on the DIN rail or on the control cabinet panel.

All PACT current transformers are just 30 mm wide. This saves space – for example flat mounting when measuring branch outlets.

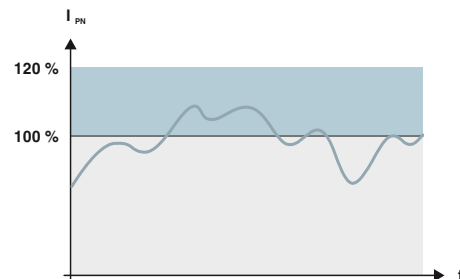

### Safe detection of current peaks

PACT current transformers can be used to safely detect current peaks greater than the rated nominal current strength – without resulting in any damage: the transformers are designed for a continuous thermal nominal current that is 120% of the primary rated current strength.

Example: a PACT transformer with a specified rated power of 10 VA does indeed deliver 14.4 VA on a continual basis.

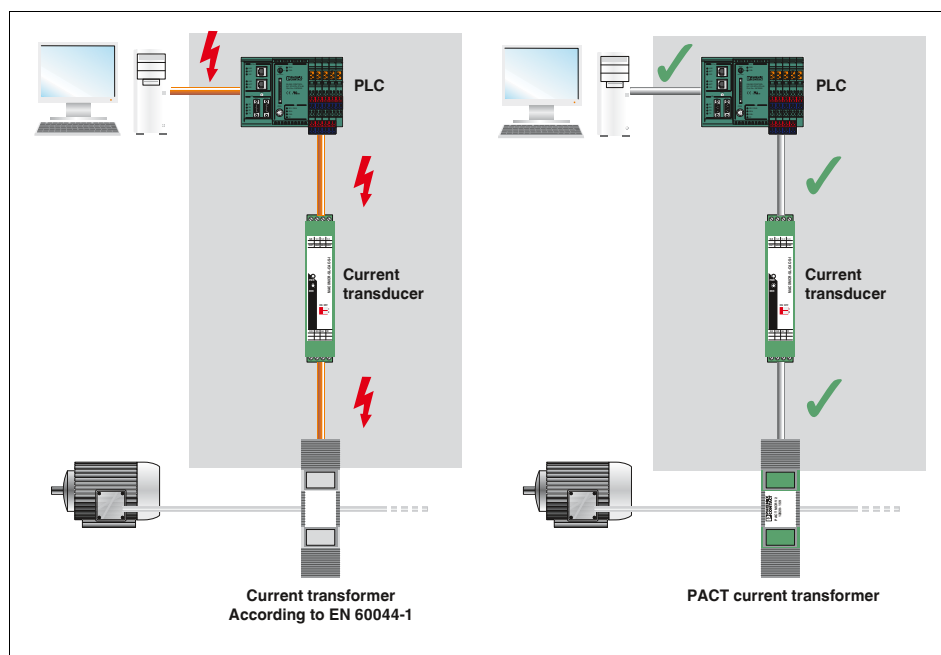

### Safe isolation

PACT current transformers are manufactured in accordance with EN 50178. This is relevant for electronic equipment for use in power installations.

EN 50178 differs considerably from EN 60044, the usual standard for transformers, with regard to safety.

Your advantages:

- PACT current transformers offer safe isolation, thanks to greater clearance and creepage distances.
- PACT current transformers ensure that there is no sparkover on the secondary side of the transformer and human life is protected inside and outside the control cabinet.
- Up to 1000 V (L-N) operating voltage possible
- Routine testing with 12 kV (1.2/50  $\mu$ s)
- Surge voltage category 3 is met

# Monitoring

## Current measurement

### Current transformer selection guide

- Complete range consisting of winding, bus-bar, and window-type current transformers
- Popular types available from stock; alternatively, order key can be used for custom dimensioning
- Versions available to support official calibration



### Selection

- Select your transformer in accordance with the dimensions of the copper rail
- Specify the four electrical characteristics of the transformer:

- 1. The primary rated current strength  $I_{pn}$**  - the maximum amperage occurring in the path to be measured
- 2. The secondary rated current  $I_{sn}$**  - supplied to the downstream measuring devices
- 3. Class** - accuracy for adherence to the specified tolerances
- 4. Rated power  $S_n$  [VA]** - takes account of all the loads occurring in the measuring circuit

#### Input data

Thermal rated short-time current  
 Rated surge current  
 Rated frequency  
 Surge current limitation factor

#### General data

Rated insulation voltage  
 Test voltage  
 Impulse withstand voltage  
 Insulating material class  
 Connection capacity of secondary terminals  
 Ambient temperature (operation)  
 Standards/regulations  
 Housing material

#### Technical data

$I_{th} = 60 \cdot I_n$   
 $I_{dyn} = 2.5 \cdot I_{th}$   
 50 Hz ... 60 Hz  
 FS 5

1 kV  
 3 kV (50 Hz, 1 min.)  
 12 kV (1.2 / 50 μs)  
 E  
 2 x (2.5 x 4) mm  
 -25 °C ... 40 °C  
 IEC 60044-1, EN 50178  
 Polyamide PA fiberglass reinforced

## Calculation guide

### Determination of the secondary side rated power $S_n$

All the occurring loads must be added:

- Calculate the power requirement of the copper cable (forward and return line)
- Take into account the power requirement of the connected devices (measuring devices)
- Add a reserve requirement

$$S_{n \text{ total}} = S_n \text{ copper cable} + S_n \text{ measuring device} + S_n \text{ reserve}$$

### Power requirement of copper cables with a different diameter

Conductor cross section in mm <sup>2</sup>	Rated power in VA/m (consider the forward and return line)	
	Secondary current $I_{sn}$ 5 A	Secondary current $I_{sn}$ 1 A
1.5	0.2917	0.0117
2.5	0.1750	0.0070
4	0.1094	0.0044
6	0.0729	0.0029

Example:

$S_n$  copper cable = cable length x 2 x rated power  
 $S_n$  copper cable = 10 m x 2 x 0.1750 VA/m = 3.50 VA

$S_n$  measuring device = 2 VA

$S_n$  reserve < 0.5 x ( $S_n$  copper cable +  $S_n$  measuring device)

$S_n$  reserve = 2 VA

$S_n$  total =  $S_n$  copper cable +  $S_n$  measuring device +  $S_n$  reserve  
 $S_n$  total = 3.5 VA + 2 VA + 2 VA = 7.5 VA

## Order key - example for PACT MCR-V2-3015-60

Preferred types that can be ordered directly are marked in green in the selection table.

Order No.	Primary current $I_{pn}$	Secondary current $I_{sn}$	Class	Rated power $S_n$
2277271	IP02000	IS05	C10	P750
	IP00600 ≅ 60 A IP00750 ≅ 75 A IP00800 ≅ 80 A IP01000 ≅ 100 A IP01250 ≅ 125 A IP02000 ≅ 200 A IP02500 ≅ 250 A	IS01 ≅ 1 A IS05 ≅ 5 A	C02 ≅ 0.2 C05 ≅ 0.5 C10 ≅ 1	P125 ≅ 1.25 VA P250 ≅ 2.5 VA P375 ≅ 3.75 VA P500 ≅ 5.0 VA P750 ≅ 7.5 VA P1000 ≅ 10 VA

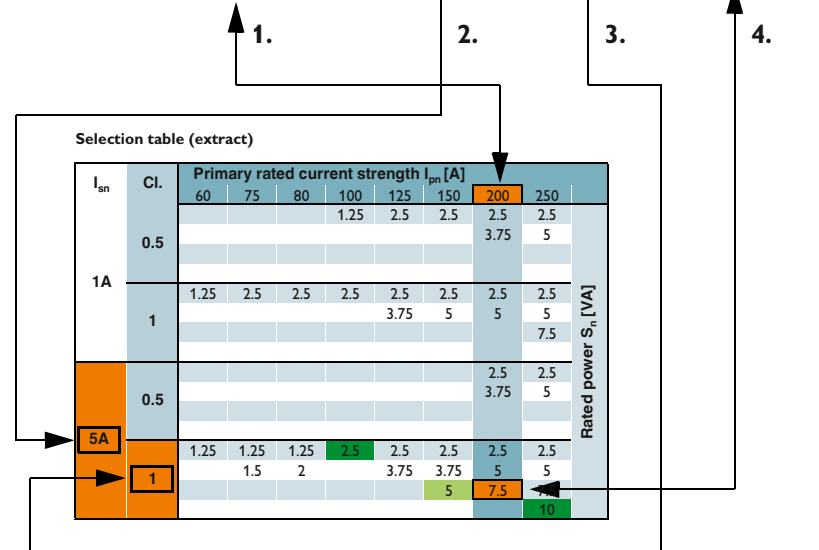

Current transformers

**PACT MCR-V1-21-44**

- Primary rated current  $I_{pn}$ : 0...(50...500) A
- Circular conductor dimensions:  $\varnothing$  21 mm

**Notes:**  
 Our configurator, which is available at [phoenixcontact.net/products](http://phoenixcontact.net/products), makes ordering easy.  
 Current transformers that support official calibration: to specify the type of current transformer you require, please use the order key on page 264  
 The relevant installation accessories can be found on page 263

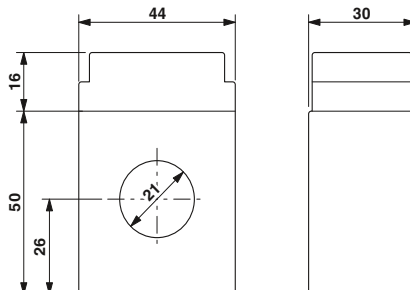

Bus-bar curr. transf., official calibration as an option

Description		Rated power $S_n$	Ordering data		
			Type	Order No.	Pcs. / Pkt.
<b>Preferred versions</b> available from stock (marked in green in the selection table)					
Primary rated current $I_{pn}$ :					
- 50 A		1.25 VA	PACT MCR-V1-21-44- 50-5A-1	2277019	1
- 75 A		2.5 VA	PACT MCR-V1-21-44- 75-5A-1	2277611	1
- 100 A		2.5 VA	PACT MCR-V1-21-44-100-5A-1	2277022	1
- 125 A		3.75 VA	PACT MCR-V1-21-44-125-5A-1	2277763	1
- 150 A		5 VA	PACT MCR-V1-21-44-150-5A-1	2277035	1
- 200 A		5 VA	PACT MCR-V1-21-44-200-5A-1	2277776	1
- 250 A		5 VA	PACT MCR-V1-21-44-250-5A-1	2277048	1
- 300 A		10 VA	PACT MCR-V1-21-44-300-5A-1	2277789	1
- 400 A		5 VA	PACT MCR-V1-21-44-400-5A-1	2277051	1
- 500 A		10 VA	PACT MCR-V1-21-44-500-5A-1	2277792	1
<b>Current transformer</b> , observe the order key below to determine the desired current transformer type					
			PACT MCR-V1-21-44	2277268	1

Add **order key** from the selection table (ordering example marked in orange)

Order No.	Primary current $I_{pn}$	Secondary current $I_{sn}$	Class	Rated power $S_n$
2277268	IP05000	IS01	C05	P1000

Selection table PACT MCR-V1-21-44 (Order No.: 2277268)

$I_{sn}$	Cl.	Primary rated current amperage $I_{pn}$ [A]												Rated power $S_n$ [VA]			
		50	60	75	80	100	125	150	200	250	300	400	500				
IS01 $\approx 1$ A	C05 $\approx 0.5$					1.25	2.5	2.5	2.5	2.5	2.5	2.5	2.5	2.5	2.5	2.5	2.5
	C10 $\approx 1$							3.75	5	5	5	5	5	5	5	5	5
IS05 $\approx 5$ A	C05 $\approx 0.5$					1.25	1.25	1.25	2.5	2.5	2.5	2.5	2.5	2.5	2.5	2.5	2.5
	C10 $\approx 1$	1.25	1.25	2.5	2.5	2.5	2.5	2.5	2.5	2.5	2.5	2.5	2.5	2.5	2.5	2.5	2.5

# Monitoring

## Current measurement

### Current transformers

#### PACT MCR-V2-3015-60

- Primary rated current  $I_{pn}$ : 0...(50...750) A
- Circular conductor dimensions:  $\varnothing$  28 mm
- Rail dimensions: 30x15 mm; 20x20 mm

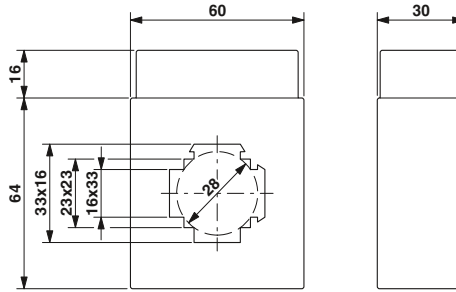

Window-type curr. transformer, official calibration as an option

Notes:
Our configurator, which is available at <a href="http://phoenixcontact.net/products">phoenixcontact.net/products</a> , makes ordering easy.
Current transformers that support official calibration: to specify the type of current transformer you require, please use the order key on page 264
The relevant installation accessories can be found on page 263

#### Ordering data

Description	Rated power $S_n$	Type	Order No.	Pcs. / Pkt.
<b>Preferred versions</b> available from stock (marked in green in the selection table)				
Primary rated current $I_{pn}$ :				
- 60 A	1.25 VA	PACT MCR-V2-3015- 60- 60-5A-1	2277815	1
- 75 A	1.25 VA	PACT MCR-V2-3015- 60- 75-5A-1	2277828	1
- 75 A	1.5 VA	PACT MCR-V2- 3015- 60- 75-5A-1	2276502	1
- 80 A	1.25 VA	PACT MCR-V2-3015- 60- 80-5A-1	2277831	1
- 100 A	2.5 VA	PACT MCR-V2-3015- 60- 100-5A-1	2277064	1
- 125 A	3.75 VA	PACT MCR-V2-3015- 60- 125-5A-1	2277624	1
- 150 A	3.75 VA	PACT MCR-V2-3015- 60- 150-5A-1	2277844	1
- 150 A	5 VA	PACT MCR-V2- 3015- 60-150-5A-1	2277077	1
- 200 A	5 VA	PACT MCR-V2-3015- 60- 200-5A-1	2277637	1
- 200 A	7.5 VA	PACT MCR-V2-3015- 60- 200-5A-1	2277857	1
- 250 A	5 VA	PACT MCR-V2- 3015- 60-250-5A-1	2276544	1
- 250 A	7.5 VA	PACT MCR-V2-3015- 60- 250-5A-1	2277860	1
- 250 A	10 VA	PACT MCR-V2- 3015- 60-250-5A-1	2277080	1
- 300 A	7.5 VA	PACT MCR-V2-3015- 60- 300-5A-1	2277640	1
- 400 A	10 VA	PACT MCR-V2- 3015- 60-400-5A-1	2277093	1
- 500 A	10 VA	PACT MCR-V2-3015- 60- 500-5A-1	2277653	1
- 600 A	10 VA	PACT MCR-V2-3015- 60- 600-5A-1	2277103	1
- 750 A	10 VA	PACT MCR-V2-3015- 60- 750-5A-1	2277666	1
<b>Current transformer</b> , observe the order key below to determine the desired current transformer type				
PACT MCR-V2- 3015- 60			2277271	1
<b>Accessories</b>				
<b>Quick-action mechanism</b> ; width of the holding latch 16 mm				
Fixing pin length 40 mm		PACT-FAST-MNT-W16-L40	2276638	1
<b>Quick-action mechanism</b> ; width of the holding latch 16 mm				
Fixing pin length 65 mm		PACT-FAST-MNT-W16-L65	2276641	1

Add **order key** from the selection table (ordering example marked in orange)

Order No.	Primary current $I_{pn}$	Secondary current $I_{sn}$	Class	Rated power $S_n$
2277271	IP07500	IS01	C05	P1500

Selection table PACT MCR-V2-3015-60 (Order No.: 2277271)

$I_{sn}$	Cl.	Primary rated current amperage $I_{pn}$ [A]													Rated power $S_n$ [VA]				
		50	60	75	80	100	125	150	200	250	300	400	500	600		750			
IS01 ≅ 1 A	C05 ≅ 0.5					1.25	2.5	2.5		2.5	2.5	2.5	5	5	5	5	5	5	15 15 15 20
													7.5	10	10	10	10	10	
	C10 ≅ 1		1.25	1.25	2.5	2.5	2.5	2.5	2.5	2.5	2.5	2.5	2.5	2.5	2.5	2.5	2.5	2.5	
IS05 ≅ 5 A	C05 ≅ 0.5																		10 10 15 15
	C10 ≅ 1		1.25	1.25	1.25	2.5	2.5	2.5	2.5	2.5	2.5	2.5	2.5	2.5	2.5	2.5	2.5	2.5	
				1.5	2		3.75	3.75	5	5	5	5	5	5	5	5	5	5	

Current transformers

**PACT MCR-V2-4012-70**

- Primary rated current  $I_{pn}$ : 0...(75...1000) A
- Circular conductor dimensions:  $\varnothing$  33 mm
- Rail dimensions: 40x12 mm; 2x 30x10 mm

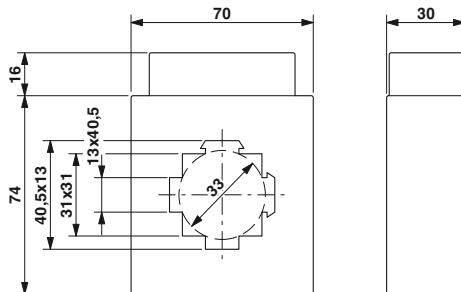

Window-type curr. transformer, official calibration as an option

**Notes:**

Our configurator, which is available at phoenixcontact.net/products, makes ordering easy.

Current transformers that support official calibration: to specify the type of current transformer you require, please use the order key on page 264

The relevant installation accessories can be found on page 263

Description	Rated power $S_n$
<b>Preferred versions</b> available from stock (marked in green in the selection table)	
Primary rated current $I_{pn}$ :	
- 250 A	5 VA
- 300 A	7.5 VA
- 400 A	7.5 VA
- 500 A	10 VA
- 600 A	10 VA
- 750 A	10 VA
- 800 A	10 VA
- 1000 A	10 VA
<b>Current transformer</b> , observe the order key below to determine the desired current transformer type	

Ordering data		
Type	Order No.	Pcs. / Pkt.
PACT MCR-V2-4012- 70- 250-5A-1	2277116	1
PACT MCR-V2-4012- 70- 300-5A-1	2277679	1
PACT MCR-V2-4012- 70- 400-5A-1	2277129	1
PACT MCR-V2-4012- 70- 500-5A-1	2277682	1
PACT MCR-V2-4012- 70- 600-5A-1	2277132	1
PACT MCR-V2-4012- 70- 750-5A-1	2277695	1
PACT MCR-V2-4012- 70- 800-5A-1	2277145	1
PACT MCR-V2-4012- 70-1000-5A-1	2277158	1
PACT MCR-V2- 4012- 70	2277284	1

<b>Quick-action mechanism</b> ; width of the holding latch 13 mm
Fixing pin length 40 mm
<b>Quick-action mechanism</b> ; width of the holding latch 13 mm
Fixing pin length 65 mm

Accessories		
Type	Order No.	Pcs. / Pkt.
PACT-FAST-MNT-W13-L40	2276612	1
PACT-FAST-MNT-W13-L65	2276625	1

Add to order key from the selection table (ordering example marked in orange)

Order No.	Primary current $I_{pn}$	Secondary current $I_{sn}$	Class	Rated power $S_n$
2277284	IP010000	IS05	C10	P250

Selection table PACT MCR-V2-4012-70 (Order No.: 2277284)

$I_{sn}$	Cl.	Primary rated current strength $I_{pn}$ [A]												Rated power $S_n$ [VA]				
		75	80	100	125	150	200	250	300	400	500	600	750		800	1000		
$\approx 1$ A	C05 $\approx 0.5$				1.25	2.5	3.75	5	5	5	5	5	5	5	5	5	5	
									7.5	10	10	10	10	10	10	10	10	
	C10 $\approx 1$		1.25	1.25	2.5	2.5	2.5	2.5	2.5	2.5	2.5	2.5	2.5	2.5	2.5	2.5	2.5	2.5
										7.5	10	10	10	10	10	10	10	10
$\approx 5$ A	C05 $\approx 0.5$				1.25	2.5	3.75	5	5	5	5	5	5	5	5	5	5	
										7.5	10	10	10	10	10	10	10	
	C10 $\approx 1$		1.25	1.25	2.5	2.5	2.5	2.5	2.5	2.5	2.5	2.5	2.5	2.5	2.5	2.5	2.5	2.5
										7.5	7.5	7.5	10	10	10	10	10	10



# Monitoring

## Current measurement

### Current transformers

#### PACT MCR-V2-5012-85

- Primary rated current  $I_{pn}$ : 0...(100...1500) A
- Circular conductor dimensions:  $\varnothing$  42 mm
- Rail dimensions: 50x12 mm; 2x 40x10 mm

Notes:
Our configurator, which is available at <a href="http://phoenixcontact.net/products">phoenixcontact.net/products</a> , makes ordering easy.
Current transformers that support official calibration: to specify the type of current transformer you require, please use the order key on page 264
The relevant installation accessories can be found on page 263

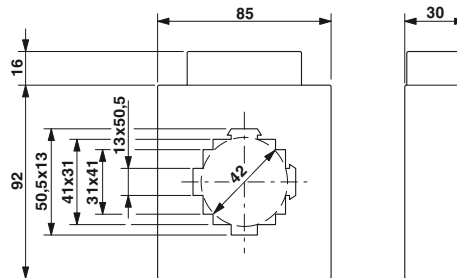

Window-type curr. transformer, official calibration as an option

Description		Rated power $S_n$	Ordering data		
			Type	Order No.	Pcs. / Pkt.
<b>Preferred versions</b> available from stock (marked in green in the selection table)					
Primary rated current $I_{pn}$ :					
- 150 A		3.75 VA	PACT MCR-V2-5012- 85- 150-5A-1	2276117	1
- 200 A		5 VA	PACT MCR-V2-5012- 85- 200-5A-1	2276120	1
- 250 A		7.5 VA	PACT MCR-V2-5012- 85- 250-5A-1	2276133	1
- 300 A		10 VA	PACT MCR-V2-5012- 85- 300-5A-1	2276146	1
- 400 A		10 VA	PACT MCR-V2-5012- 85- 400-5A-1	2277161	1
- 500 A		15 VA	PACT MCR-V2-5012- 85- 500-5A-1	2276159	1
- 600 A		10 VA	PACT MCR-V2-5012- 85- 600-5A-1	2277174	1
- 600 A		15 VA	PACT MCR-V2-5012- 85- 600-5A-1	2276162	1
- 750 A		10 VA	PACT MCR-V2-5012- 85- 750-5A-1	2276175	1
- 800 A		10 VA	PACT MCR-V2-5012- 85- 800-5A-1	2277187	1
- 1000 A		10 VA	PACT MCR-V2-5012- 85-1000-5A-1	2276463	1
- 1000 A		15 VA	PACT MCR-V2-5012- 85-1000-5A-1	2277190	1
- 1250 A		15 VA	PACT MCR-V2-5012- 85-1250-5A-1	2277200	1
- 1500 A		15 VA	PACT MCR-V2-5012- 85-1500-5A-1	2276188	1
<b>Current transformer</b> , observe the order key below to determine the desired current transformer type					
			PACT MCR-V2- 5012- 85	2277297	1

Quick-action mechanism; width of the holding latch 13 mm		Accessories		
		Type	Order No.	Pcs. / Pkt.
Fixing pin length 40 mm		PACT-FAST-MNT-W13-L40	2276612	1
Quick-action mechanism; width of the holding latch 13 mm				
Fixing pin length 65 mm		PACT-FAST-MNT-W13-L65	2276625	1

Add **order key** from the selection table (ordering example marked in orange)

Order No.	Primary current $I_{pn}$	Secondary current $I_{sn}$	Class	Rated power $S_n$
2277297	IP02500	IS01	C10	P750

Selection table PACT MCR-V2-5012-85 (Order No.: 2277297)

$I_{sn}$	Cl.	Primary rated current amperage $I_{pn}$ [A]													Rated power $S_n$ [VA]			
		100	125	150	200	250	300	400	500	600	750	800	1000	1250		1500		
$\cong 1$ A	C05 $\cong 0.5$			1.25	2.5	2.5	2.5	2.5	2.5	2.5	2.5	2.5	2.5	2.5	2.5	2.5	2.5	2.5
					5	5	5	5	5	5	5	5	5	5	5	5	5	5
	C10 $\cong 1$	1.25	2.5	2.5	2.5	2.5	2.5	2.5	2.5	2.5	2.5	2.5	2.5	2.5	2.5	2.5	2.5	2.5
$\cong 5$ A	C05 $\cong 0.5$			1.25	2.5	2.5	2.5	2.5	2.5	2.5	2.5	2.5	2.5	2.5	2.5	2.5	2.5	2.5
					5	5	5	5	5	5	5	5	5	5	5	5	5	5
	C10 $\cong 1$	1.25	2.5	2.5	2.5	2.5	2.5	2.5	2.5	2.5	2.5	2.5	2.5	2.5	2.5	2.5	2.5	2.5

Current transformers

**PACT MCR-V2-6015-85**

- Primary rated current  $I_{pn}$ : 0...(200...1600) A
- Circular conductor dimensions:  $\varnothing$  52 mm
- Rail dimensions: 60x15 mm; 2x 50x10 mm; 40x40 mm

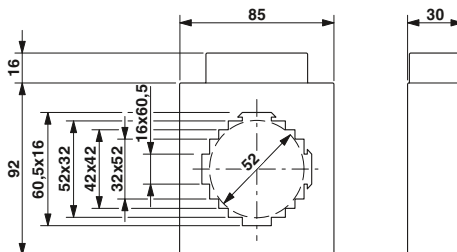

Window-type curr. transformer, official calibration as an option

**Notes:**  
 Our configurator, which is available at phoenixcontact.net/products, makes ordering easy.  
 Current transformers that support official calibration: to specify the type of current transformer you require, please use the order key on page 264  
 The relevant installation accessories can be found on page 263

Description		Rated power $S_n$	Ordering data		
Type		Order No.	Pcs. / Pkt.		
<b>Preferred versions</b> available from stock (marked in green in the selection table)					
Primary rated current $I_{pn}$ :					
- 200 A	2.5 VA	<b>PACT MCR-V2-6015- 85- 200-5A-1</b>	<b>2277873</b>	1	
- 250 A	2.5 VA	<b>PACT MCR-V2-6015- 85- 250-5A-1</b>	<b>2277886</b>	1	
- 300 A	2.5 VA	<b>PACT MCR-V2-6015- 85- 300-5A-1</b>	<b>2277899</b>	1	
- 400 A	2.5 VA	<b>PACT MCR-V2-6015- 85- 400-5A-1</b>	<b>2277909</b>	1	
- 500 A	5 VA	<b>PACT MCR-V2-6015- 85- 500-5A-1</b>	<b>2277912</b>	1	
- 600 A	10 VA	<b>PACT MCR-V2-6015- 85- 600-5A-1</b>	<b>2277925</b>	1	
- 750 A	10 VA	<b>PACT MCR-V2-6015- 85- 750-5A-1</b>	<b>2277938</b>	1	
- 800 A	10 VA	<b>PACT MCR-V2-6015- 85- 800-5A-1</b>	<b>2277941</b>	1	
- 1000 A	15 VA	<b>PACT MCR-V2-6015- 85-1000-5A-1</b>	<b>2277954</b>	1	
- 1250 A	15 VA	<b>PACT MCR-V2-6015- 85-1250-5A-1</b>	<b>2277967</b>	1	
- 1500 A	15 VA	<b>PACT MCR-V2-6015- 85-1500-5A-1</b>	<b>2277970</b>	1	
- 1600 A	15 VA	<b>PACT MCR-V2-6015- 85-1600-5A-1</b>	<b>2277983</b>	1	
<b>Current transformer</b> , observe the order key below to determine the desired current transformer type					
PACT MCR-V2- 6015- 85		2277336	1		
<b>Accessories</b>					
Quick-action mechanism; width of the holding latch 16 mm		PACT-FAST-MNT-W16-L40	2276638	1	
Fixing pin length 40 mm					
Quick-action mechanism; width of the holding latch 16 mm		PACT-FAST-MNT-W16-L65	2276641	1	
Fixing pin length 65 mm					

Add **order key** from the selection table (ordering example marked in orange)

Order No.	Primary current $I_{pn}$	Secondary current $I_{sn}$	Class	Rated power $S_n$
2277336	IP05000	IS01	C10	P375

Selection table PACT MCR-V2-6015-85 (Order No.: 2277336)

$I_{sn}$	Cl.	Primary rated current amperage $I_{pn}$ [A]											Rated power $S_n$ [VA]	
		200	250	300	400	500	600	750	800	1000	1250	1500		1600
IS01 $\cong$ 1 A	C05 $\cong$ 0.5		1.25	1.25	1.25	2.5	2.5	2.5	2.5	2.5	5	5	5	5
	C10 $\cong$ 1	2.5	2.5	2.5	2.5	3.75	2.5	2.5	2.5	2.5	2.5	5	5	5
IS05 $\cong$ 5 A	C05 $\cong$ 0.5		1.25	1.25	1.25	2.5	2.5	2.5	2.5	2.5	5	5	5	5
	C10 $\cong$ 1	2.5	2.5	2.5	2.5	5	5	5	5	5	10	10	10	10

# Monitoring

## Current measurement

### Current transformers

#### PACT MCR-V2-6315-95

- Primary rated current  $I_{pn}$ : 0...(200...2500) A
- Circular conductor dimensions:  $\varnothing$  53 mm
- Rail dimensions:  
63x15 mm  
2x 50x10 mm  
40x40 mm



Window-type curr. transformer, official calibration as an option

#### PACT MCR-V2-6040-96

- Primary rated current  $I_{pn}$ : 0...(200...2000) A
- Circular conductor dimensions:  $\varnothing$  61 mm
- Rail dimensions:  
60x40 mm; 50x50 mm



Window-type curr. transformer, official calibration as an option

**Notes:**  
Our configurator, which is available at [phoenixcontact.net/products](http://phoenixcontact.net/products), makes ordering easy.  
Current transformers that support official calibration: to specify the type of current transformer you require, please use the order key on page 265  
The relevant installation accessories can be found on page 263

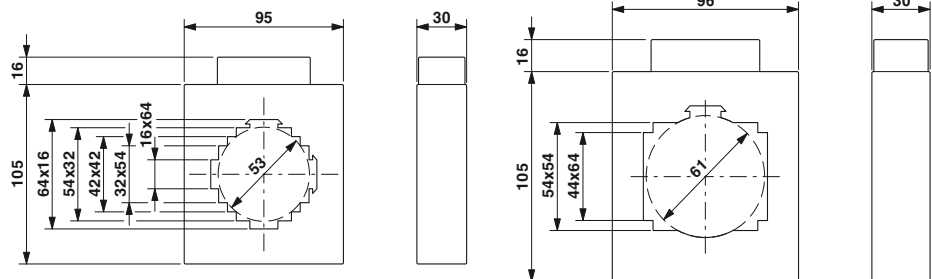

Description	Rated power $S_n$
<b>Preferred versions</b> available from stock (marked in green in the selection table) Primary rated current $I_{pn}$ :	
- 600 A	10 VA
- 750 A	10 VA
- 800 A	10 VA
- 1000 A	10 VA
- 1250 A	10 VA
- 1250 A	15 VA
- 1500 A	10 VA
- 1600 A	10 VA
- 1600 A	15 VA
- 2000 A	15 VA
<b>Current transformer</b> , observe the order key below to determine the desired current transformer type	

Ordering data			
Type	Order No.	Pcs. / Pkt.	
PACT MCR-V2-6315-95-800-5A-1	2277213	1	
PACT MCR-V2-6315-95-1000-5A-1	2277226	1	
PACT MCR-V2-6315-95-1250-5A-1	2277239	1	
PACT MCR-V2-6315-95-1500-5A-1	2277242	1	
PACT MCR-V2-6315-95-1600-5A-1	2277255	1	
<b>PACT MCR-V2- 6315- 95</b>	<b>2277307</b>	<b>1</b>	

Ordering data			
Type	Order No.	Pcs. / Pkt.	
PACT MCR-V2-6040-96-600-5A-1	2276191	1	
PACT MCR-V2-6040-96-750-5A-1	2276201	1	
PACT MCR-V2-6040-96-800-5A-1	2276214	1	
PACT MCR-V2-6040-96-1000-5A-1	2277705	1	
PACT MCR-V2-6040-96-1250-5A-1	2276227	1	
PACT MCR-V2-6040-96-1500-5A-1	2277718	1	
PACT MCR-V2-6040-96-1600-5A-1	2276230	1	
PACT MCR-V2-6040-96-2000-5A-1	2276243	1	
<b>PACT MCR-V2- 6040- 96</b>	<b>2277349</b>	<b>1</b>	

**Quick-action mechanism**; width of the holding latch 16 mm  
Fixing pin length 40 mm  
**Quick-action mechanism**; width of the holding latch 16 mm  
Fixing pin length 65 mm

Accessories			
Type	Order No.	Pcs. / Pkt.	
PACT-FAST-MNT-W16-L40	2276638	1	
PACT-FAST-MNT-W16-L65	2276641	1	

Accessories			
Type	Order No.	Pcs. / Pkt.	
PACT-FAST-MNT-W16-L40	2276638	1	
PACT-FAST-MNT-W16-L65	2276641	1	

Add **order key** from the selection table (ordering example marked in orange)

Order No.	Primary current $I_{pn}$	Secondary current $I_{sn}$	Class	Rated power $S_n$
2277307	IP25000	IS05	C05	P500

Selection table PACT MCR-V2-6315-95 (Order No.: 2277307)

$I_{sn}$	Cl.	Primary rated current amperage $I_{pn}$ [A]													Rated power $S_n$ [VA]		
		200	250	300	400	500	600	750	800	1000	1250	1500	1600	2000		2500	
IS01 $\cong$ 1 A	C05 $\cong$ 0.5	2.5	2.5	2.5	2.5	2.5	2.5	5	5	5	5	5	5	5	5	5	5
	C10 $\cong$ 1	3.75	5	5	5	5	5	10	10	10	10	10	10	10	10	15	15
																15	20
IS05 $\cong$ 5 A	C05 $\cong$ 0.5	2.5	2.5	2.5	2.5	2.5	2.5	5	5	5	5	5	5	5	5	5	5
	C10 $\cong$ 1	3.75	5	5	5	5	5	10	10	10	10	10	10	10	10	15	15
																15	20

Selection table PACT MCR-V2-6040-96 (Order No.: 2277349)

$I_{sn}$	Cl.	Primary rated current amperage $I_{pn}$ [A]													Rated power $S_n$ [VA]		
		200	250	300	400	500	600	750	800	1000	1250	1500	1600	2000			
IS01 $\cong$ 1 A	C05 $\cong$ 0.5	2.5	2.5	2.5	2.5	2.5	2.5	5	5	5	5	5	5	5	5	5	5
	C10 $\cong$ 1	3.75	5	5	5	5	5	10	10	10	10	10	10	10	10	15	15
																15	20
IS05 $\cong$ 5 A	C05 $\cong$ 0.5	2.5	2.5	2.5	2.5	2.5	2.5	5	5	5	5	5	5	5	5	5	5
	C10 $\cong$ 1	3.75	3.75	5	5	5	5	10	10	10	10	10	10	10	10	15	15
																15	20

Current transformers

**PACT MCR-V2-8015-105**

- Primary rated current  $I_{pn}$ : 0...(400...2500) A
- Circular conductor dimensions:  $\varnothing$  61 mm
- Rail dimensions: 80x15 mm; 2x 60x10 mm; 3x 50x10 mm

**PACT MCR-V2-8020-105**

- Primary rated current  $I_{pn}$ : 0...(500...2000) A
- Circular conductor dimensions:  $\varnothing$  70 mm
- Rail dimensions: 2x 80x10 mm; 60x60 mm



Window-type curr. transformer, official calibration as an option



Window-type curr. transformer, official calibration as an option

**Notes:**  
 Our configurator, which is available at phoenixcontact.net/products, makes ordering easy.  
 Current transformers that support official calibration: to specify the type of current transformer you require, please use the order key on page 265  
 The relevant installation accessories can be found on page 263

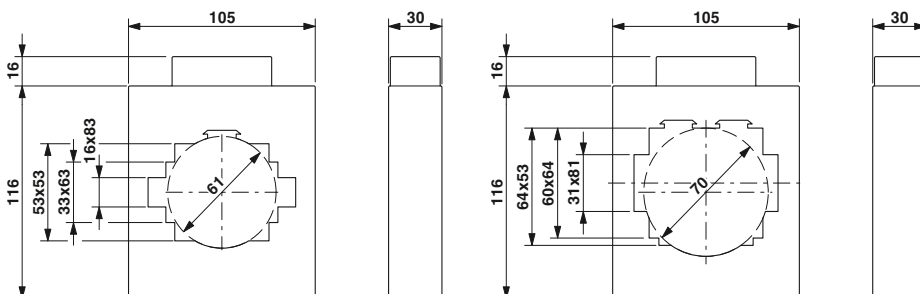

Description		Rated power $S_n$	Ordering data			Ordering data		
Description		Rated power $S_n$	Type	Order No.	Pcs. / Pkt.	Type	Order No.	Pcs. / Pkt.
<b>Preferred versions</b> available from stock (marked in green in the selection table) Primary rated current $I_{pn}$ :								
- 400 A	7.5 VA	PACT MCR-V2-8015-105- 400-5A-1	2276256	1				
- 500 A	10 VA	PACT MCR-V2-8015-105- 500-5A-1	2276269	1				
- 600 A	10 VA	PACT MCR-V2-8015-105- 600-5A-1	2276272	1				
- 750 A	10 VA	PACT MCR-V2-8015-105- 750-5A-1	2276285	1				
- 800 A	15 VA	PACT MCR-V2-8015-105- 800-5A-1	2276298	1				
- 1000 A	10 VA	PACT MCR-V2-8015-105-1000-5A-1	2277721	1	PACT MCR-V2-8020-105-1000-5A-1	2277747	1	
- 1000 A	15 VA	PACT MCR-V2-8015-105-1000-5A-1	2276308	1				
- 1250 A	10 VA	PACT MCR-V2-8015-105-1250-5A-1	2276311	1				
- 1500 A	15 VA	PACT MCR-V2-8015-105-1500-5A-1	2277734	1	PACT MCR-V2-8020-105-1500-5A-1	2277750	1	
- 1600 A	15 VA	PACT MCR-V2-8015-105-1600-5A-1	2276324	1				
- 2000 A	10 VA				PACT MCR-V2-8020-105-2000-5A-1	2276382	1	
- 2000 A	20 VA	PACT MCR-V2-8015-105-2000-5A-1	2276337	1				
- 2500 A	20 VA	PACT MCR-V2-8015-105-2500-5A-1	2276340	1				
<b>Current transformer</b> , observe the order key below to determine the desired current transformer type								
			PACT MCR-V2- 8015-105	2277352	1	PACT MCR-V2- 8020-105	2277365	1

Add order key from the selection table (ordering example marked in orange)

Order No.	Primary current $I_{pn}$	Secondary current $I_{sn}$	Class	Rated power $S_n$
2277352	IP25000	IS05	C10	P3000

Selection table PACT MCR-V2-8015-105 (Order No.: 2277352)

$I_{sn}$	Cl.	Primary rated current amperage $I_{pn}$ [A]										Rated power $S_n$ [VA]	
		400	500	600	750	800	1000	1250	1500	1600	2000		2500
IS01 ≅ 1 A	C05 ≅ 0.5	2.5	2.5	2.5	2.5	2.5	2.5	2.5	2.5	2.5	5	10	
	C10 ≅ 1	5	5	5	5	5	5	5	5	10	10	15	
		7.5	10	10	10	10	10	10	15	15	20	25	
IS05 ≅ 5 A	C05 ≅ 0.5	2.5	2.5	2.5	2.5	2.5	5	2.5	2.5	2.5	2.5	5	
	C10 ≅ 1	5	5	5	5	5	10	5	5	5	10	15	
		7.5	10	10	10	15	15	10	10	15	15	20	30

Selection table PACT MCR-V2-8020-105 (Order No.: 2277365)

$I_{sn}$	Cl.	Primary rated current amperage $I_{pn}$ [A]								Rated power $S_n$ [VA]			
		500	600	750	800	1000	1250	1500	1600		2000		
IS01 ≅ 1 A	C05 ≅ 0.5	2.5	2.5	2.5	2.5	2.5	2.5	2.5	2.5	5	5		
	C10 ≅ 1	5	5	5	5	5	5	5	5	10	10	15	
		7.5	7.5	7.5	7.5	10	10	10	10	15	15	20	
IS05 ≅ 5 A	C05 ≅ 0.5	2.5	2.5	2.5	2.5	2.5	2.5	2.5	2.5	2.5	2.5	2.5	2.5
	C10 ≅ 1	5	5	5	5	5	5	5	5	5	5	5	5
		7.5	7.5	7.5	7.5	10	10	10	10	10	10	10	15

# Monitoring

## Current measurement

### Current transformers

#### PACT MCR-V2-10020-129

- Primary rated current  $I_{pn}$ : 0...(400...4000) A
- Circular conductor dimensions:  $\varnothing$  85 mm
- Rail dimensions: 2x 100x10 mm; 80x64 mm

#### PACT MCR-V2-10036-129

- Primary rated current  $I_{pn}$ : 0...(400...4000) A
- Rail dimensions: 3x 100x12 mm



Window-type curr. transformer, official calibration as an option



Window-type curr. transformer, official calibration as an option

**Notes:**  
 Our configurator, which is available at phoenixcontact.net/products, makes ordering easy.  
 Current transformers that support official calibration: to specify the type of current transformer you require, please use the order key on page 265  
 The relevant installation accessories can be found on page 263

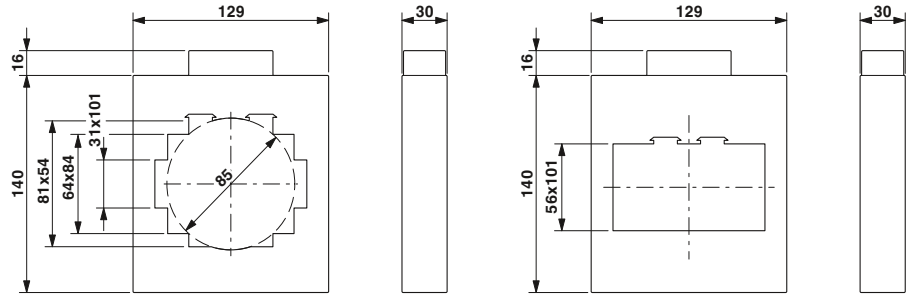

Ordering data			Ordering data				
Description	Rated power $S_n$	Type	Order No.	Pcs. / Pkt.	Type	Order No.	Pcs. / Pkt.
<b>Preferred versions</b> available from stock (marked in green in the selection table) Primary rated current $I_{pn}$ :							
- 2500 A	15 VA	<b>PACT MCR-V2-10020-129-2500-5A</b>	<b>2276395</b>	1	<b>PACT MCR-V2-10036-129-3000-5A</b>	<b>2276405</b>	1
- 3000 A	15 VA						
<b>Current transformer</b> , observe the order key below to determine the desired current transformer type		<b>PACT MCR-V2-10020-129</b>	<b>2277378</b>	1	<b>PACT MCR-V2-10036-129</b>	<b>2277381</b>	1

Add **order key** from the selection table (ordering example marked in orange)

Order No.	Primary current $I_{pn}$	Secondary current $I_{sn}$	Class	Rated power $S_n$
2277378	IP40000	IS05	C05	P2500

Selection table PACT MCR-V2-10020-129 (Order No.: 2277378)

$I_{sn}$	Cl.	Primary rated current amperage $I_{pn}$ [A]												Rated power $S_n$ [VA]								
		400	500	600	750	800	1000	1250	1500	1600	2000	2500	3000		4000							
IS01 $\geq 1$ A	C05 $\geq 0.5$		5	10	10	10	10	10	10	10	10	10	10	10	15	15	15	15	15	15	20	20
	C10 $\geq 1$	2.5	2.5	5	5	5	5	5	5	5	5	5	5	5	5	5	5	5	5	5	25	30
IS05 $\geq 5$ A	C05 $\geq 0.5$		5	5	10	10	10	10	10	10	10	10	10	10	10	10	10	10	10	10	20	20
	C10 $\geq 1$	2.5	2.5	5	5	5	5	5	5	5	5	5	5	5	5	5	5	5	5	5	25	30

Selection table PACT MCR-V2-10036-129 (Order No.: 2277381)

$I_{sn}$	Cl.	Primary rated current amperage $I_{pn}$ [A]												Rated power $S_n$ [VA]								
		400	500	600	750	800	1000	1250	1500	1600	2000	2500	3000		4000							
IS01 $\geq 1$ A	C05 $\geq 0.5$		5	10	10	10	10	10	10	10	10	10	10	10	10	10	10	10	10	10	15	15
	C10 $\geq 1$	2.5	2.5	5	5	5	5	5	5	5	5	5	5	5	5	5	5	5	5	5	25	30
IS05 $\geq 5$ A	C05 $\geq 0.5$		5	5	10	10	10	10	10	10	10	10	10	10	10	10	10	10	10	10	20	20
	C10 $\geq 1$	2.5	2.5	5	5	5	5	5	5	5	5	5	5	5	5	5	5	5	5	5	25	30

Current transformers

**PACT MCR-V2-12020-159**

- Primary rated current  $I_{pn}$ : 0...(400...4000) A
- Circular conductor dimensions:  $\varnothing$  96 mm
- Rail dimensions: 2x 120x10 mm; 3x 100x10 mm; 80x80 mm

**PACT MCR-V2-12040-159**

- Primary rated current  $I_{pn}$ : 0...(400...4000) A
- Rail dimensions: 4x 120x10 mm



Window-type current transformer



Window-type current transformer

**Notes:**  
 Our configurator, which is available at phoenixcontact.net/products, makes ordering easy.  
 The relevant installation accessories can be found on page 263

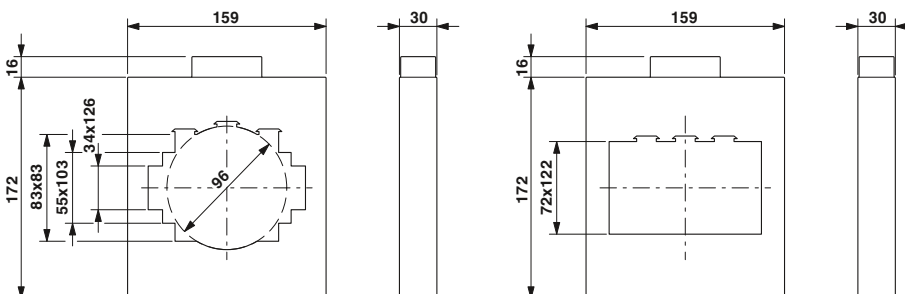

Description	Rated power $S_n$
<b>Preferred versions</b> available from stock (marked in green in the selection table) Primary rated current $I_{pn}$ : - 4000 A	15 VA
<b>Current transformer</b> , observe the order key below to determine the desired current transformer type	

Ordering data		
Type	Order No.	Pcs. / Pkt.
PACT MCR-V2-12020-159	2277394	1

Ordering data		
Type	Order No.	Pcs. / Pkt.
PACT MCR-V2-12040-159-4000-5A	2276418	1
PACT MCR-V2-12040-159	2277404	1

Add **order key** from the selection table (ordering example marked in orange)

Order No.	Primary current $I_{pn}$	Secondary current $I_{sn}$	Class	Rated power
2277404	IP08000	IS01	C05	P250

Selection table PACT MCR-V2-12020-159 (Order No.: 2277394)

$I_{sn}$	Cl.	Primary rated current amperage $I_{pn}$ [A]													Rated power $S_n$ [VA]
		400	500	600	750	800	1000	1250	1500	1600	2000	2500	3000	4000	
IS01 ≅ 1A	C05 ≅ 0.5	2.5	2.5	2.5	2.5	2.5	2.5	5	5	5	5	5	5	10	15 VA
		5	5	5	5	5	5	10	10	10	10	10	10	15	
	10	10	10	10	10	10	15	15	15	15	15	15	30		
	15	20	20	20	15	20	30	30	30	30	30	45	45		
C10 ≅ 1	C05 ≅ 0.5	2.5	5	5	2.5	2.5	5	5	5	5	5	5	10	10	15 VA
		5	10	10	5	5	10	10	10	10	10	10	10	15	
	10	15	15	10	10	15	15	15	15	15	15	30	30		
	15	20	20	15	20	30	30	30	30	30	30	45	45		
IS05 ≅ 5 A	C05 ≅ 0.5	2.5	2.5	2.5	2.5	2.5	5	5	10	5	5	5	10	10	15 VA
		5	5	5	5	5	10	10	15	10	10	10	15	15	
	10	10	10	10	10	15	15	30	15	15	15	30	30		
	15	15	30	30	45	30	30	45	30	30	45	45			
C10 ≅ 1	C05 ≅ 0.5	2.5	5	5	5	5	5	10	5	5	5	10	10	15 VA	
		5	10	10	10	10	10	15	10	10	10	15	15		
	10	15	15	15	15	15	30	15	15	15	30	30			
	15	20	20	20	30	30	45	30	45	45					

Selection table PACT MCR-V2-12040-159 (Order No.: 2277404)

$I_{sn}$	Cl.	Primary rated current amperage $I_{pn}$ [A]													Rated power $S_n$ [VA]
		400	500	600	750	800	1000	1250	1500	1600	2000	2500	3000	4000	
IS01 ≅ 1A	C05 ≅ 0.5	2.5	2.5	2.5	2.5	2.5	2.5	5	5	5	5	5	5	10	15 VA
		5	5	5	5	5	5	10	10	10	10	10	10	15	
	10	10	10	10	10	10	15	15	15	15	15	15	30		
	15	20	20	20	15	20	30	30	30	30	30	45	45		
C10 ≅ 1	C05 ≅ 0.5	2.5	5	5	2.5	2.5	5	5	5	5	5	5	10	10	15 VA
		5	10	10	5	5	10	10	10	10	10	10	10	15	
	10	15	15	10	10	15	15	15	15	15	15	30	30		
	15	20	20	15	20	30	30	30	30	30	30	45	45		
IS05 ≅ 5 A	C05 ≅ 0.5	2.5	2.5	2.5	2.5	2.5	5	5	10	5	5	5	10	10	15 VA
		5	5	5	5	5	10	10	15	10	10	10	15	15	
	10	10	10	10	10	15	15	30	15	15	15	30	30		
	15	15	30	30	45	30	30	45	30	30	45	45			
C10 ≅ 1	C05 ≅ 0.5	2.5	5	5	5	5	5	10	5	5	5	10	10	15 VA	
		5	10	10	10	10	10	15	10	10	10	15	15		
	10	15	15	15	15	15	30	15	15	15	30	30			
	15	20	20	20	30	30	45	30	45	45					



# Monitoring

## Current measurement

### Current transformers

#### PACT MCR-V3-60

– Primary rated current  $I_{pn}$ :  
0...(1...40) A

– Current-carrying copper lines connected directly to the screw terminal blocks on the primary side

**Notes:**  
Our configurator, which is available at [phoenixcontact.net/products](http://phoenixcontact.net/products), makes ordering easy.  
The relevant installation accessories can be found on page 263

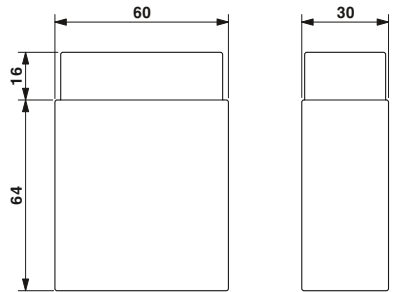

Winding current transformer

Description  
**Current transformer**, observe the order key below to determine the desired current transformer type

Ordering data		
Type	Order No.	Pcs. / Pkt.
PACT MCR-V3-60	2277417	1

Add to order key from the selection table (ordering example marked in orange)

Order No.	Primary current $I_{pn}$	Secondary current $I_{sn}$	Class	Rated power $S_n$
2277417	IP00025	IS01	C10	P250

Selection table PACT MCR-V3-60 (Order No.: 2277417)

$I_{sn}$	Cl.	Primary rated current strength $I_{pn}$ [A]														Rated power $S_n$ [VA]
		1	2	2.5	4	5	6	7.5	10	12.5	15	20	25	30	40	
IS01 ≅ 1 A	C05 ≅ 0.5	2.5	2.5	2.5	2.5	2.5	2.5	2.5	2.5	2.5	2.5	2.5	2.5	2.5	2.5	P250
	C10 ≅ 1	5	5	5	5	5	5	5	5	5	5	5	5	5	5	
IS05 ≅ 5 A	C05 ≅ 0.5	2.5	2.5	2.5	2.5	2.5	2.5	2.5	2.5	2.5	2.5	2.5	2.5	2.5	2.5	P250
	C10 ≅ 1	5	5	5	5	5	5	5	5	5	5	5	5	5	5	

## Accessories

## Quick-action mechanism for PACT current transformers

- No tools necessary for mounting
- Extremely easy handling, thanks to secure fastening by pressing with finger
- Set consisting of two fixing pins and a holding latch

## Notes:

The 16 mm wide quick-action mechanism can also be used for larger current transformers if the length of the fixing pins is sufficient.



for: ...V2-4012-70..., ...V2-5012-85...



for: ...V2-3015-60..., ...V2-6015-85..., ...V2-6315-95...

## General data

Material  
Ambient temperature (operation)

PA 6  
-25 °C ... 120 °C

## Description

**Quick-action mechanism**; width of the holding latch 13 mm

Fixing pin length 65 mm

Fixing pin length 40 mm

**Quick-action mechanism**; width of the holding latch 16 mm

Fixing pin length 65 mm

Fixing pin length 40 mm

## Technical data

## Ordering data

Type	Order No.	Pcs. / Pkt.
PACT-FAST-MNT-W13-L65	2276625	1
PACT-FAST-MNT-W13-L40	2276612	1

## Technical data

## Ordering data

Type	Order No.	Pcs. / Pkt.
PACT-FAST-MNT-W16-L65	2276641	1
PACT-FAST-MNT-W16-L40	2276638	1

## Accessories

- Copper sleeves
- DIN rail adapter
- Secondary terminal cover
- Insulating caps

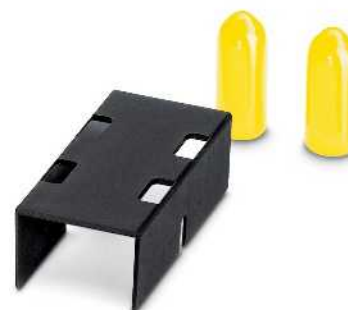
Copper sleeves  
DIN rail adapterSecondary terminal cover  
Insulating caps

## Ordering data

Type	Order No.	Pcs. / Pkt.
PACT MCR-CB-21-8	2277569	1
PACT MCR-CB-21-12	2277556	1
PACT MCR-CB-28-12	2277543	1
PACT MCR-CB-42-12	2277530	1
PACT MCR-RA	2277598	12

## Ordering data

Type	Order No.	Pcs. / Pkt.
PACT MCR-ETC-60	2277572	9
PACT MCR-ETC-75	2277585	9
PACT MCR-ICAP	2277608	18

## Description

**Copper sleeves**, for establishing a conductive connection during the horizontal assembly of PACT analog current transformers. The size of the copper sleeve depends on the diameter of the inner hole of the current transformer.

- for PACT MCR-V1-21-44-...      Ø 21/8 mm  
- for PACT MCR-V1-21-44-...      Ø 21/12 mm  
- for PACT MCR-V2-3015-60-...    Ø 28/12 mm  
- for PACT MCR-V2-5012-85-...    Ø 42/12 mm

## DIN rail adapter

**Secondary terminal cover**, for increasing the clearance and creepage distances

Length: 60 mm

Length: 75 mm

**Insulating caps**, for protection against unintended contact with mounting screws of the primary rail

# Monitoring

## Current measurement

### Current transformers that can be calibrated - order key

Add **order key** from the relevant selection table (ordering examples are marked in orange)

Order No.	Primary current $I_{pn}$	Secondary current $I_{sn}$	Class	Rated power $S_n$	Calibration	Calibration certificate
	IP01500 ≙ 150 A IP02000 ≙ 200 A IP02500 ≙ 250 A IP03000 ≙ 300 A IP04000 ≙ 400 A IP05000 ≙ 500 A IP06000 ≙ 600 A IP07500 ≙ 750 A IP08000 ≙ 800 A IP10000 ≙ 1000 A IP12000 ≙ 1200 A IP12500 ≙ 1250 A IP15000 ≙ 1500 A IP16000 ≙ 1600 A IP20000 ≙ 2000 A IP25000 ≙ 2500 A	IS05 ≙ 5 A	C02S ≙ 0.2S C02 ≙ 0.2 C05S ≙ 0.5S C05 ≙ 0.5	P250 ≙ 2.5 VA P500 ≙ 5.0 VA P1000 ≙ 10 VA P1500 ≙ 15 VA P2000 ≙ 20 VA P3000 ≙ 30 VA	NONE ≙ not calibrated YES ≙ calibrated	NONE ≙ no calibration certificate YES ≙ calibration certificate (a fee is charged)  YESPLUS ≙ Calibration certificate with catalog of errors (5 measuring points) (a fee is charged)

### PACT MCR-V1C-21-44 (Order No.: 2277420)

You will find information about the product on page 253.

Add **order key** from the selection table

2277420 / IP03000 / IS05 / C02 / P250 / NONE / NONE

Selection table

$I_{sn}$	Cl.	Primary rated current amperage $I_{pn}$ [A]					Rated power $S_n$ [VA]	
		150	200	250	300	400		500
IS05 ≙ 5 A	C02S ≙ 0.2S					2.5	2.5	5
	C02 ≙ 0.2			2.5	2.5	2.5	2.5	5
	C05S ≙ 0.5S	2.5	2.5	2.5	2.5	2.5	2.5	10
	C05 ≙ 0.5	2.5	2.5	2.5	2.5	2.5	2.5	10

### PACT MCR-V2C-3015-60 (Order No.: 2277433)

You will find information about the product on page 254.

Add **order key** from the selection table

2277433 / IP02000 / IS05 / C05 / P250 / NONE / NONE

Selection table

$I_{sn}$	Cl.	Primary rated current amperage $I_{pn}$ [A]							Rated power $S_n$ [VA]
		200	250	300	400	500	600	750	
IS05 ≙ 5 A	C02S ≙ 0.2S						2.5	2.5	5
	C02 ≙ 0.2				2.5	2.5	2.5	2.5	5
	C05S ≙ 0.5S	2.5	2.5	2.5	2.5	2.5	2.5	2.5	15
	C05 ≙ 0.5	2.5	2.5	2.5	2.5	2.5	2.5	2.5	15

### PACT MCR-V2C-5012-85 (Order No.: 2277459)

You will find information about the product on page 256.

Add **order key** from the selection table

2277459 / IP10000 / IS05 / C05 / P1500 / NONE / NONE

Selection table

$I_{sn}$	Cl.	Primary rated current amperage $I_{pn}$ [A]										Rated power $S_n$ [VA]			
		200	250	300	400	500	600	750	800	1000	1200				
IS05 ≙ 5 A	C02S ≙ 0.2S						2.5	2.5	2.5	5	5	5	5	10	10
	C02 ≙ 0.2				2.5	2.5	2.5	2.5	2.5	5	5	10	10	15	15
	C05S ≙ 0.5S	2.5	2.5	2.5	2.5	2.5	5	5	5	5	5	10	10	10	10
	C05 ≙ 0.5	2.5	2.5	2.5	2.5	2.5	5	5	5	5	5	10	10	10	10

### PACT MCR-V2C-4012-70 (Order No.: 2277446)

You will find information about the product on page 255.

Add **order key** from the selection table

2277446 / IP06000 / IS05 / C02 / P1000 / NONE / NONE

Selection table

$I_{sn}$	Cl.	Primary rated current amperage $I_{pn}$ [A]								Rated power $S_n$ [VA]				
		200	250	300	400	500	600	750	800		1000			
IS05 ≙ 5 A	C02S ≙ 0.2S						2.5	2.5	2.5	5	5	5	5	10
	C02 ≙ 0.2				2.5	2.5	2.5	5	5	10	5	5	10	10
	C05S ≙ 0.5S	2.5	2.5	2.5	2.5	2.5	5	5	5	5	2.5	5	5	10
	C05 ≙ 0.5	2.5	2.5	2.5	2.5	2.5	5	5	5	5	2.5	5	5	10

### PACT MCR-V2C-6015-85 (Order No.: 2277462)

You will find information about the product on page 257.

Add **order key** from the selection table

2277462 / IP02500 / IS05 / C05 / P250 / NONE / NONE

Selection table

$I_{sn}$	Cl.	Primary rated current amperage $I_{pn}$ [A]										Rated power $S_n$ [VA]		
		250	300	400	500	600	750	800	1000	1200				
IS05 ≙ 5 A	C02S ≙ 0.2S						2.5	2.5	2.5	2.5	2.5	5	5	5
	C02 ≙ 0.2				2.5	2.5	2.5	2.5	2.5	5	5	5	5	5
	C05S ≙ 0.5S	2.5	2.5	2.5	2.5	2.5	2.5	2.5	2.5	2.5	2.5	5	5	5
	C05 ≙ 0.5	2.5	2.5	2.5	2.5	2.5	2.5	2.5	2.5	2.5	2.5	5	5	5





### Fast installation in a confined space

PACT RCP current transformers for retrofitting can be conveniently mounted where there is not enough space for split core current transformers. System downtimes are reduced as system parts do not have to be removed for installation.

Your advantages:

- High system availability due to reduced downtimes: fast installation without removing system parts
- Safe installation and operation: no dangerous open circuit voltages
- No magnetic saturation
- High linearity, even at high currents
- Responds to fast current changes
- The coil is protected against electromagnetic interference
- The current can rise up to the short-circuit current without necessarily destroying the coil
- High nominal insulation voltage

### Professional holding device for busbars

The PACT RCP-CLAMP holding device offers the following advantages:

- Suitable for industrial applications
- Steel bracket ensures permanent fixed seating at high busbar temperatures
- Designed for rails with a thickness of 10 ... 15 mm
- Rogowski coil is snapped onto the fixing element
- Rogowski coil has a safe and defined place on the busbar
- Rogowski coil can be rotated in 15° increments for optimum alignment.
- PACT RCP avoids direct contact of the measuring coil with its own or adjacent busbar
- This allows installations on warm busbars to remain under control



### Easy and safe installation

Simply place the handy Rogowski coil quickly around power rails and circular conductors. The measuring transducer connected downstream supplies the same typical secondary currents as a standard current transformer.

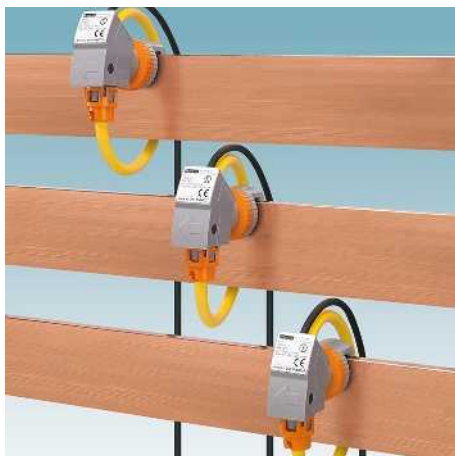

### Fast installation in a confined space

PACT RCP current transformers save space and are handy as the size and weight of the Rogowski coil are not dependent on the amperage and unlike split core current transformers, remain the same.



### One measuring system for all amperages

Acquire alternating currents up to 4000 A using a single coil type. Rogowski coils are available in three different lengths for optimum adjustment to the busbar and circular conductor dimensions.



### Eight current measuring ranges

The measuring transducer connected downstream supplies the same typical secondary currents as a standard current transformer. Choose between eight different current measuring ranges via DIP switches. For optimum measuring accuracy, compensate for the different coil lengths by simply using a potentiometer.

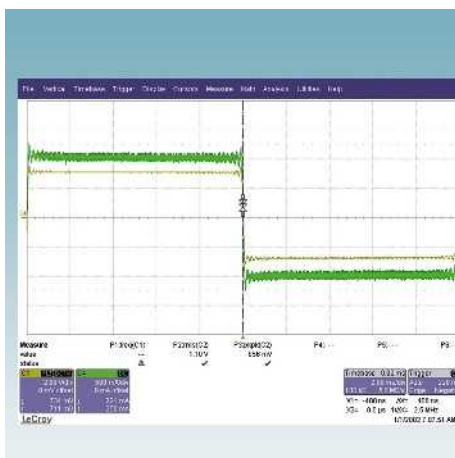

### Detect harmonics and transients

PACT RCP current transformers for retrofitting cover a large frequency range from 10 to 5000 Hz. You can therefore measure harmonics and transients with phase accuracy.



### Safe seating

The optional holding device ensures safe seating and optimal alignment of the coil even on very hot busbars. If the gap between the busbars is very small, simply turn the coil diagonally to avoid touching other rails.



### Current transformers for retrofitting

#### PACT RCP

- Practical handling due to the flexible measuring coil for opening
- Universal application possibilities through 8 different current measuring ranges in one device: (0 ... 100/ ... / ... /4000 A)
- The large bandwidth (10...5000 Hz) enables harmonics and transients to be detected
- It is not possible for dangerous open circuit voltages to occur
- The bracket ensures optimum alignment of the measuring coil to the power rail
- Low space requirement in the control cabinet



Current transformer for subsequent installation in the field

Technical data	
Measuring coil input data	
Frequency range	10 Hz ... 5000 Hz
Input signal	Sine
Position error	< 1 %
Measuring coil signal output	
Output signal (at 50 Hz)	100 mV (no load, at 1000 A)
General data, measuring coil	
Length of signal cable	3000 mm
Rated insulation voltage	1000 V AC (rms CAT III) 600 V AC (rms CAT IV)
Test voltage	10.45 kV (DC / 1 min.)
Ambient temperature (operation)	-30 °C ... 80 °C (measuring coil)
Ambient temperature (storage/transport)	-40 °C ... 90 °C (measuring coil)
Measuring transducer input data	
Measuring ranges (current) via DIP switch	100 A, 250 A, 400 A, 630 A, 1000 A, 1500 A, 2000 A, 4000 A
Phase angle	< 1 °
Measuring transducer signal input	
Input signal (at 50 Hz)	100 mV (1000 A)
Measuring transducer signal output	
Current output signal	0 A AC ... 1 A AC (effective at sine)
Miscellaneous data for measuring transducer	
Nominal supply voltage	24 V DC -20 % ... +25 %
Nominal supply voltage range	19.2 V DC ... 30 V DC
Transmission error, maximum	≤ 0.5 % (of range final value)
Linearity error	< 0.5 % (of range final value)
Frequency range	45 Hz ... 65 Hz
Degree of protection	IP20
Test voltage	1.5 kV AC (supply/input and output: 50 Hz, 1 min)
Dimensions W / H / D	22.5 / 70.4 / 85 mm
Ambient temperature (operation)	-20 °C ... 70 °C (measuring transducer)
Ambient temperature (storage/transport)	-25 °C ... 85 °C (measuring transducer)
General data for the set	
Altitude	< 2000 m
Permissible humidity (operation)	5 % ... 95 % (non-condensing)
Approvals / conformities	
Standards/specifications	IEC 61010-1 IEC 61010-031 IEC 61010-2-031 IEC 61010-2-032

Description
<b>Current transformer for retrofitting</b> , set consisting of Rogowski coil and measuring transducer, output signal: 1 A AC (effective for sine)
Length of measuring coil 300 mm
Length of measuring coil 450 mm
Length of measuring coil 600 mm

Holding device for power rail
PACT RCP-CLAMP

#### Recommendations for the use of coil lengths and power rail dimensions

Busbar	Dia- meter/ coil length	1 busbar per phase	2 busbars per phase	3 busbars per phase
[mm x mm]	[mm]			
30 x 10	95/300	X	X	
40 x 10	95/300	X	X	
40 x 10	140/450			X
50 x 10	95/300	X		
50 x 10	140/450		X	X
60 x 10	95/300	X		
60 x 10	140/450		X	X
60 x 10	140/450	X	X	X
100 x 10	140/450	X	X	
100 x 10	190/600			X
120 x 10	140/450	X		
120 x 10	190/600		X	X
160 x 10	190/600	X	X	X

Ordering data		
Type	Order No.	Pcs. / Pkt.
PACT RCP-4000A-1A-D95	2904921	1
PACT RCP-4000A-1A-D140	2904922	1
PACT RCP-4000A-1A-D190	2904923	1
Accessories		
PACT RCP-CLAMP	2904895	1

## Current transformers for retrofitting

## PACT RCP

- Universal application possibilities through 8 different current measuring ranges in one device: (0 ... 100/ ... / ... /4000 A)
- Detection of harmonics and transients in the frequency range from (16 ... 1000) Hz
- Large number of different standard signals on output side
- Freely configurable 4-way signal conditioner with switching output
- FASTCON Pro plug-in connection system
- Overall width of just 6.2 mm
- Easy configuration, e.g., via DIP switches, programmable software, via smartphone app or FDT/DTM

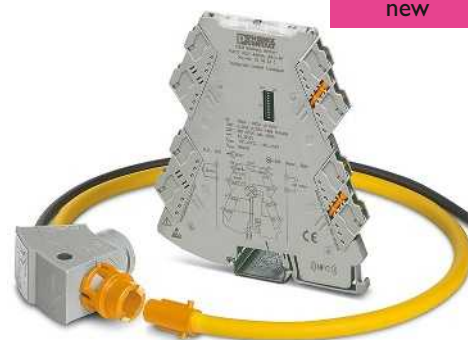

Current transformer for subsequent installation in the field

Technical data	
Measuring coil input data	
Frequency range	10 Hz ... 5000 Hz
Input signal	Sine
Position error	< 1 %
Measuring coil signal output	
Output signal (at 50 Hz)	100 mV (no load, at 1000 A)
General data, measuring coil	
Length of signal cable	3000 mm
Rated insulation voltage	1000 V AC (rms CAT III) 600 V AC (rms CAT IV) 10.45 kV (DC / 1 min.)
Test voltage	-30 °C ... 80 °C (measuring coil)
Ambient temperature (operation)	
Measuring transducer input data	
Measuring ranges (current) via DIP switch	100 A, 250 A, 400 A, 630 A, 1000 A, 1500 A, 2000 A, 4000 A
Measuring transducer signal input	
Input signal (at 50 Hz)	100 mV (1000 A)
Measuring transducer signal output	
Current output signal	0 mA ... 20 mA (via DIP switch) 4 mA ... 20 mA (via DIP switch) 0 mA ... 10 mA (via DIP switch) 2 mA ... 10 mA (via DIP switch) 0 mA ... 21 mA (can be set via software)
Output signal	0 V ... 10 V (via DIP switch) 2 V ... 10 V (via DIP switch) 0 V ... 5 V (via DIP switch) 1 V ... 5 V (via DIP switch) 0 V ... 10.5 V (can be set via software)
Voltage	
Miscellaneous data for measuring transducer	
Nominal supply voltage	24 V DC
Nominal supply voltage range	9.6 V DC ... 30 V DC
Transmission error, maximum	≤ 0.5 % (of range final value)
Frequency range	16 Hz ... 1000 Hz
Degree of protection	IP20
Test voltage	3 kV (50 Hz, 1 min.)
Dimensions W / H / D	6.2 / 110.5 / 120.5 mm
Ambient temperature (operation)	-40 °C ... 70 °C (measuring transducer)
General data for the set	
Altitude	> 4000 m
Permissible humidity (operation)	5 % ... 95 % (non-condensing)
Approvals / conformities	
Standards/specifications	IEC 61010-1 IEC 61010-031 IEC 61010-2-031 IEC 61010-2-032

Ordering data			
Description	Type	Order No.	Pcs. / Pkt.
<b>Current transformer with screw connection for retrofitting</b> , set consisting of Rogowski coil and 4-way signal conditioner with switching output			
Length of measuring coil 300 mm	PACT RCP-4000A-UIRO-D95	2906231	1
Length of measuring coil 450 mm	PACT RCP-4000A-UIRO-D140	2906232	1
Length of measuring coil 600 mm	PACT RCP-4000A-UIRO-D190	2906233	1
<b>Current transformer with push-in connection for retrofitting</b> , set consisting of Rogowski coil and 4-way signal conditioner with switching output			
Length of measuring coil 300 mm	PACT RCP-4000A-UIRO-PT-D95	2906234	1
Length of measuring coil 450 mm	PACT RCP-4000A-UIRO-PT-D140	2906235	1
Length of measuring coil 600 mm	PACT RCP-4000A-UIRO-PT-D190	2906236	1
Accessories			
<b>Holding device for power rail</b>	PACT RCP-CLAMP	2904895	1



### **With flexible power supply – current transducers up to 12 A AC**

Active current transducers convert sinusoidal alternating currents up to 12 A. The integrated wide range power supply unit enables use in various different countries.

### **With hinged Rogowski sensor – current transducers up to 200 A AC**

The AC current transducers measure sinusoidal and non-sinusoidal alternating currents up to 200 A. The hinged Rogowski sensor ensures very easy installation, as cables that are to be measured do not have to be isolated. This enables mounting to be carried out without interruptions.

### **Limit value monitoring with the current protector**

At the current protector, a desired amperage is specified at which a PDT contact switches a load on or off.

### **Flexible signal conditioning – current transducers up to 55 A AC/DC**

Current transducers up to 55 A offer an infinitely adjustable measuring range. This range is mapped over the entire output signal range. This ensures extremely accurate resolution of measured values. Basic configuration can be performed quickly via the DIP switches. Additional useful device functions can be set via the software.

### **For high currents – current transducers up to 600 A AC/DC**

The universal current transducers are the ideal solution for measuring high currents with any waveform up to 600 A AC/DC. The product range offers various different devices in graded measuring ranges with current or voltage output.



#### For sinusoidal alternating currents up to 12 A

- 3-way electrical isolation
- Wide range version from 19.2 ... 253 V AC/DC
- Voltage bridging with DIN rail connector
- Input/output can be configured via DIP switches
- Suitable for potentially explosive areas, thanks to ATEX approval for Ex zone 2



#### For sinusoidal and non-sinusoidal alternating currents up to 200 A

- Distorted alternating currents up to 6000 Hz can be also acquired, thanks to true r.m.s. value measurement (RMS)
- Uninterrupted installation and lossless current measurement thanks to hinged Rogowski sensor
- Measuring range selection with slide switch



#### Limit value monitoring

- The current protector converts sinusoidal alternating currents to binary switching signals.
- Switching point can be freely selected in the measuring range of 0 ... 16 A AC
  - Changeover relay output
  - Adjustable switch hysteresis
  - 3-way isolation
  - Operating current/quiescent current behavior can be set



#### With flexible measuring ranges for all waveforms up to 55 A

- Lossless true r.m.s. value measurement without shunt via Hall sensor (TRMS)
- Optimum mapping of the measuring range up to 55 A, thanks to software-programmable upper and lower limits
- Limit value alarm in the event of threshold value overrange or underrange up to 55 A
  - via relay or transistor output



#### For high currents – current transducers up to 600 A AC/DC

- Lossless true r.m.s. value measurement without shunt via Hall sensor (TRMS)
- Compact dimensions also enable distributed use
- Variable mounting on DIN rail and mounting plate
- COMBICON plug-in connection terminal blocks
- 3-way isolation
- For a conductor diameter of up to 32 mm

# Monitoring

## Current measurement

### Current transducers for AC/DC and distorted currents

- The **MCR-SL-CUC-...** current transducers measure DC, AC, and distorted currents of 0 ... 600 A.
- Universal current measurement, no shunt required
  - Compact dimensions also enable distributed use
  - Variable mounting on DIN rail and mounting plate
  - Simple connection method thanks to COMBICON plug-in connection terminal blocks
  - 3-way isolation



For DC, AC, and distorted currents of 0 ... 300 A, voltage output

Housing width 90 mm

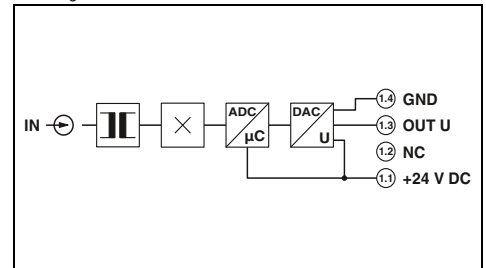

#### Technical data

<b>Input data</b>	
Frequency range	20 Hz ... 6000 Hz (0 Hz)
Curve type	AC, DC or distorted currents
Connection method	Cable design: 32 mm diameter
<b>Output data</b>	
Output signal	0 ... 10 V
Maximum output signal	
Load $R_B$	$\geq 10 \text{ k}\Omega$
<b>General data</b>	
Supply voltage $U_B$	20 V DC ... 30 V DC
Maximum transmission error	$< \pm 1 \%$ (of final value)
Temperature coefficient	typ. 0.02 %/K (0 ... 60°C) 0.04 %/K (-40 ... 65°C)
Step response (10-90%)	150 ms
Safe isolation	acc. to EN 61010
Rated insulation voltage	300 V AC
Surge voltage category / pollution degree	III / 2
Degree of protection	IP20
Ambient temperature range	-40 °C ... 65 °C
Dimensions W / H / D	90 / 33.8 / 85 mm
Spring-cage connection solid / stranded / AWG	0.25 ... 2.5 mm <sup>2</sup> / 0.2 ... 2.5 mm <sup>2</sup> / 24 - 12
<b>Conformance / approvals</b>	
Conformance	CE-compliant
UL, USA / Canada	UL/C-UL listed UL 508

#### Ordering data

Description	Overload capacity	Type	Order No.	Pcs. / Pkt.
<b>Universal current transducer</b>				
Input current range: 0 ... 100 A	$6 \times I_{IN}$	<b>MCR-SL-CUC-100-U</b>	<b>2308108</b>	1
Input current range: 0 ... 200 A	$3 \times I_{IN}$	<b>MCR-SL-CUC-200-U</b>	<b>2308205</b>	1
Input current range: 0 ... 300 A	$3.33 \times I_{IN}$	<b>MCR-SL-CUC-300-U</b>	<b>2308302</b>	1
Input current range: 0 ... 400 A	$2.5 \times I_{IN}$			
<b>Universal current transducer without UL approval</b>				
Input current range: 0 ... 500 A	$3.6 \times I_{IN}$			
Input current range: 0 ... 600 A	$3 \times I_{IN}$			



For DC, AC, and distorted currents of  
0 ... 600 A,  
current output



Housing width 90 mm

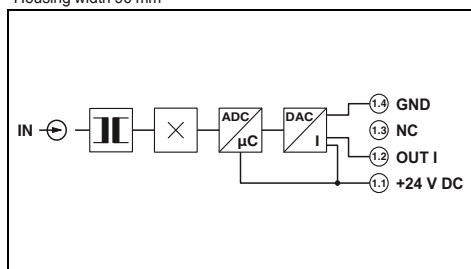

#### Technical data

20 Hz ... 6000 Hz (0 Hz)  
AC, DC or distorted currents  
Cable design: 32 mm diameter

4 ... 20 mA  
< 25 mA  
< 300 Ω

20 V DC ... 30 V DC  
<± 1 % (of final value)  
typ. 0.02 %/K (0 ... 60°C) 0.04 %/K (-40 ... 65°C)

150 ms  
acc. to EN 61010  
300 V AC  
III / 2  
IP20  
-40 °C ... 65 °C  
90 / 33.8 / 85 mm  
0.25 ... 2.5 mm<sup>2</sup> / 0.2 ... 2.5 mm<sup>2</sup> / 24 - 12

CE-compliant  
UL/C-UL listed UL 508

#### Ordering data

Type	Order No.	Pcs. / Pkt.
MCR-SL-CUC-100-I	2308027	1
MCR-SL-CUC-200-I	2308030	1
MCR-SL-CUC-300-I	2308043	1
MCR-SL-CUC-400-I	2308072	1
MCR-SL-CUC-500-I	2308085	1
MCR-SL-CUC-600-I	2308098	1



# Monitoring

## Current measurement

### Current transducers for AC/DC and distorted currents

The **MCR-S...-UI(-SW)-DCI** current transducers measure direct, alternating, and distorted currents.

- Device can be set via DIP switches or MCR/PI-CONF-WIN configuration software
- True r.m.s. value measurement
- 3-way isolation
- With optional relay and transistor output



For DC, AC, and distorted currents  
0 ... 11 A



For DC, AC, and distorted currents  
0 ... 55 A

**Notes:**  
To order a configurable product, enter the required configuration by referring to the adjacent order key.  
Further information about the configuration software can be found on page 280



Housing width 22.5 mm

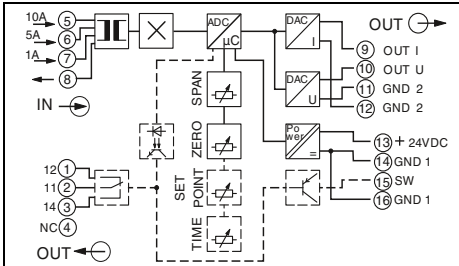

Housing width 22.5 mm

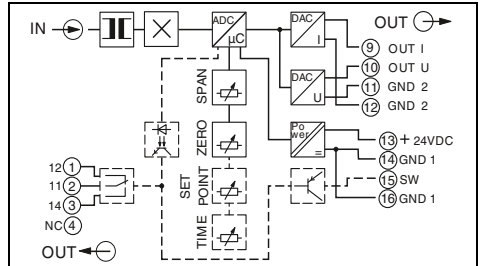

Input data	
Input current	0 A ... 11 A (AC/DC)
Operate threshold	2 % (of measuring range nominal value 1/5/10 A)
Frequency range	15 Hz ... 400 Hz
Curve type	AC, DC or distorted currents
Overload capacity	2 x I <sub>N</sub> (continuous)
Surge strength	20 x I <sub>N</sub> (1 s)
Connection method	Screw connection
Output data	
Output signal (normal and inverse)	U output: 0 ... 5 V / 1 ... 5 V / 0 ... 10 V I output: 0 ... 20 mA / 4 ... 20 mA
	2 ... 10 V / -5 ... 5 V / -10 ... 10 V
	> 10 kΩ
	< 500 Ω
Load R <sub>B</sub>	
Switching output	
Relay output	Contact material: 1 PDT / AgSnO, hard gold-plated Max. switching current: 50 mA (for gold layer, 30 V AC/36 V DC) 2 A (in case of a destroyed gold layer, 250 V AC) 19 V ... 29 V (supply voltage - 1 V) 80 mA (not short-circuit-proof)
Transistor output pnp	Output voltage: 1 % ... 110 % Continuous load current: 0.1 s ... 20 s
Setting range of the threshold value	Yellow LED
Response delay	
Status indication	
General data	
Supply voltage U <sub>B</sub>	20 V DC ... 30 V DC
Current consumption	< 50 mA (without load)
Maximum transmission error	< 0.5 % (of nominal range value under nominal conditions)
Temperature coefficient	typ. < 0.025 %/K
Step response (10-90%)	330 ms (with AC) 40 ms (with DC)
Safe isolation	acc. to EN 50178, EN 61010
Rated insulation voltage	300 V AC (to ground)
Surge voltage category / pollution degree	III / 2
Test voltage input/output	4 kV (50 Hz, 1 min.)
Test voltage input/power supply	4 kV (50 Hz, 1 min.)
Test voltage output/power supply	500 V (50 Hz, 1 min.)
Degree of protection	IP20
Dimensions W / H / D	22.5 / 99 / 114.5 mm
Screw connection solid / stranded / AWG	0.2 ... 2.5 mm <sup>2</sup> / 0.2 ... 2.5 mm <sup>2</sup> / 24 - 14
EMC note	Class A product, see page 625
Conformance / approvals	
Conformance	CE-compliant
UL, USA / Canada	Class I, Zone 2, AEx nC IIC T6, Ex nC IIC T6

Technical data	
0 A ... 11 A (AC/DC)	
2 % (of measuring range nominal value 1/5/10 A)	
15 Hz ... 400 Hz	
AC, DC or distorted currents	
2 x I <sub>N</sub> (continuous)	
20 x I <sub>N</sub> (1 s)	
Screw connection	
U output	I output
0 ... 5 V / 1 ... 5 V / 0 ... 10 V	0 ... 20 mA / 4 ... 20 mA
2 ... 10 V / -5 ... 5 V / -10 ... 10 V	
> 10 kΩ	< 500 Ω
Contact material: 1 PDT / AgSnO, hard gold-plated	
Max. switching current: 50 mA (for gold layer, 30 V AC/36 V DC) 2 A (in case of a destroyed gold layer, 250 V AC) 19 V ... 29 V (supply voltage - 1 V) 80 mA (not short-circuit-proof)	
Output voltage: 1 % ... 110 %	
Continuous load current: 0.1 s ... 20 s	
Yellow LED	
20 V DC ... 30 V DC	
< 50 mA (without load)	
< 0.5 % (of nominal range value under nominal conditions)	
typ. < 0.025 %/K	
330 ms (with AC) 40 ms (with DC)	
acc. to EN 50178, EN 61010	
300 V AC (to ground)	
III / 2	
4 kV (50 Hz, 1 min.)	
4 kV (50 Hz, 1 min.)	
500 V (50 Hz, 1 min.)	
IP20	
22.5 / 99 / 114.5 mm	
0.2 ... 2.5 mm <sup>2</sup> / 0.2 ... 2.5 mm <sup>2</sup> / 24 - 14	
Class A product, see page 625	
CE-compliant	
Class I, Zone 2, AEx nC IIC T6, Ex nC IIC T6	

Technical data	
0 A ... 55 A (AC/DC)	
0.8 % (of measuring range nominal value 50 A)	
15 Hz ... 400 Hz	
AC, DC or distorted currents	
Depending on through connected conductor	
Depending on through connected conductor	
Through connection, diameter 10.5 mm	
U output	I output
0 ... 5 V / 1 ... 5 V / 0 ... 10 V	0 ... 20 mA / 4 ... 20 mA
2 ... 10 V / -5 ... 5 V / -10 ... 10 V	
> 10 kΩ	< 500 Ω
Contact material: 1 PDT / AgSnO, hard gold-plated	
Max. switching current: 50 mA (for gold layer, 30 V AC/36 V DC) 2 A (in case of a destroyed gold layer, 250 V AC) 19 V ... 29 V (supply voltage - 1 V) 80 mA (not short-circuit-proof)	
Output voltage: 1 % ... 110 %	
Continuous load current: 0.1 s ... 20 s	
Yellow LED	
20 V DC ... 30 V DC	
< 50 mA (without load)	
< 0.5 % (of nominal range value under nominal conditions)	
typ. < 0.025 %/K	
330 ms (with AC) 40 ms (with DC)	
acc. to EN 50178, EN 61010	
300 V AC (to ground)	
III / 2	
4 kV (50 Hz, 1 min.)	
4 kV (50 Hz, 1 min.)	
500 V (50 Hz, 1 min.)	
IP20	
22.5 / 99 / 114.5 mm	
0.2 ... 2.5 mm <sup>2</sup> / 0.2 ... 2.5 mm <sup>2</sup> / 24 - 14	
Class A product, see page 625	
CE-compliant	
Class I, Zone 2, AEx nC IIC T6, Ex nC IIC T6	

Description
<b>MCR current transducer</b> for measuring AC, DC, and distorted currents with relay and transistor switching output
Configurable product
Standard product
Configurable product, without switching output
Standard product, without switching output

Ordering data		
Type	Order No.	Pcs. / Pkt.
MCR-S-1-5-UI-SW-DCI	2814650	1
MCR-S-1-5-UI-SW-DCI-NC	2814731	1
MCR-S-1-5-UI-DCI	2814634	1
MCR-S-1-5-UI-DCI-NC	2814715	1

Ordering data		
Type	Order No.	Pcs. / Pkt.
MCR-S-10-50-UI-SW-DCI	2814663	1
MCR-S-10-50-UI-SW-DCI-NC	2814744	1
MCR-S-10-50-UI-DCI	2814647	1
MCR-S-10-50-UI-DCI-NC	2814728	1

Order key for the current transducers (standard configuration entered as example)

Order No.	Measuring range:		Output	Threshold value	Suppression time	Switching behavior of relay and transistor	
	Start	End					
2814634	0.00	5.00	OUT01				
2814650	0.00	5.00	OUT01	50	3.0	A	O
2814634 ≙ MCR-S-1-5-UI-DCI	Measuring range start value between 0.00 ... 7.50 A	Measuring range end value between 0.2 ... 11 A	OUT01 ≙ 0 ... 20 mA OUT02 ≙ 4 ... 20 mA OUT03 ≙ 0 ... 10 V OUT04 ≙ 2 ... 10 V OUT05 ≙ 0 ... 5 V OUT06 ≙ 1 ... 5 V OUT07 ≙ 20 ... 0 mA OUT08 ≙ 20 ... 4 mA OUT09 ≙ 10 ... 0 V OUT10 ≙ 10 ... 2 V OUT11 ≙ 5 ... 0 V OUT12 ≙ 5 ... 1 V OUT13 ≙ -5 ... +5 V OUT14 ≙ -10 ... +10 V OUT17 ≙ +10 ... -10 V OUT18 ≙ +5 ... -5 V	Switching threshold between 1 ... 110%  50 ≙ 50% of set measuring range final value (here: 2.5 A)	between 0.1 ... 20 s  3.0 ≙ 3 s	A ≙ Operating current controlled  R ≙ Closed-circuit current controlled	O ≙ Overrun  U ≙ Underrun

Order No.	Measuring range:		Output	Threshold value	Suppression time	Switching behavior of relay and transistor	
	Start	End					
2814647	0.0	50.0	OUT01				
2814663	0.0	50.0	OUT01	50	3.0	A	O
2814647 ≙ MCR-S-10-50-UI-DCI	Measuring range start value between 0.0 ... 37.5 A	Measuring range end value between 9.5 ... 55 A	OUT01 ≙ 0 ... 20 mA OUT02 ≙ 4 ... 20 mA OUT03 ≙ 0 ... 10 V OUT04 ≙ 2 ... 10 V OUT05 ≙ 0 ... 5 V OUT06 ≙ 1 ... 5 V OUT07 ≙ 20 ... 0 mA OUT08 ≙ 20 ... 4 mA OUT09 ≙ 10 ... 0 V OUT10 ≙ 10 ... 2 V OUT11 ≙ 5 ... 0 V OUT12 ≙ 5 ... 1 V OUT13 ≙ -5 ... +5 V OUT14 ≙ -10 ... +10 V OUT17 ≙ +10 ... -10 V OUT18 ≙ +5 ... -5 V	Switching threshold between 1 ... 110%  50 ≙ 50% of set measuring range final value (here: 25 A)	between 0.1 ... 20 s  3.0 ≙ 3 s	A ≙ Operating current controlled  R ≙ Closed-circuit current controlled	O ≙ Overrun  U ≙ Underrun

Functional diagram: switching behavior of relay and transistor output:

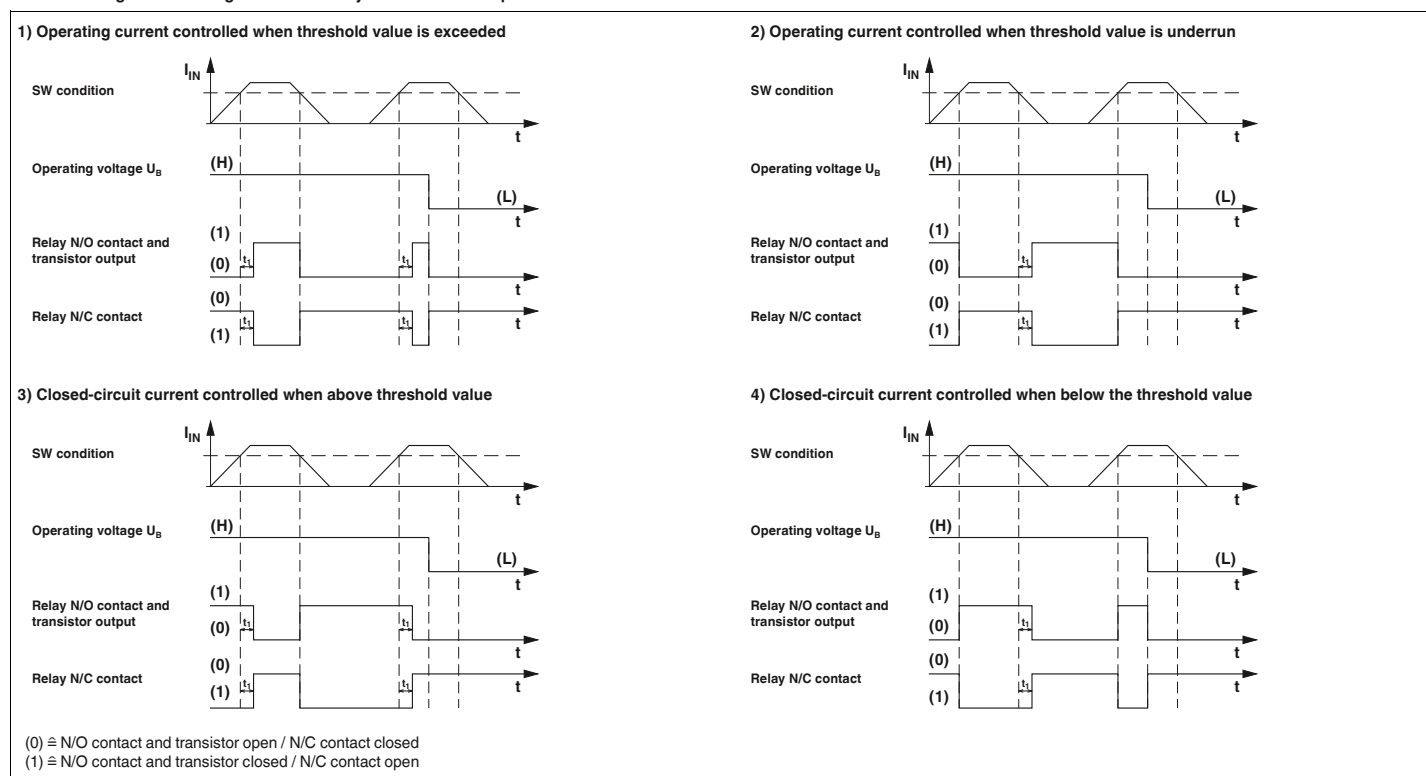

# Monitoring

## Current measurement

### AC current transducers, sinusoidal

The **MCR-SL-CAC-...** current transducers measure sinusoidal alternating currents within the range 0 ... 1/5/12 A.

- Wide range version from 19.2 ... 253 V AC/DC
- 3-way isolation
- Input/output can be configured using the DIP switch



For sinusoidal alternating currents  
0 ... 1 A/0 ... 5 A



For sinusoidal alternating currents  
0 ... 5 A/0 ... 12 A

Ex:   
Housing width 22.5 mm

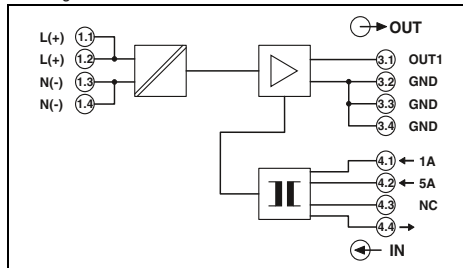

#### Technical data

Input data	0 A AC ... 1 A AC (configurable) / 0 A AC ... 5 A AC (configurable)	
Input current (configurable)		
Nominal frequency	50 Hz	
Frequency range	45 Hz ... 65 Hz	
Curve type	Sine	
Overload capacity	2 x I <sub>N</sub> (continuous)	
Surge strength	20 x I <sub>N</sub> (1 s)	
Connection method	Screw terminal block	
Output data	0 ... 20 mA / 4 ... 20 mA	
Output signal (configurable)	25 mA	
Maximum output signal	< 500 Ω (at 20 mA)	
Load R <sub>B</sub>	< 10 mV <sub>pp</sub> (for 500 Ω at 20 mA)	
Ripple		
General data	MACX MCR-SL-CAC-5-I	MACX MCR-SL-CAC-5-I-UP
Supply voltage U <sub>B</sub>	19.2 V DC ... 30 V DC	19.2 V AC/DC ... 253 V AC/DC
Current consumption	< 32 mA (at U <sub>B</sub> =24 V DC, I <sub>OUT</sub> =20 mA)	< 30 mA (at U <sub>B</sub> =24 V DC, I <sub>OUT</sub> =20 mA)
Maximum transmission error	≤ 0.5 % (of nominal range value under nominal conditions)	≤ 0.5 % (of nominal range value under nominal conditions)
Temperature coefficient	< 0.02 %/K	< 0.02 %/K
Step response (10-90%)	max. 300 ms typ. 200 ms	max. 300 ms typ. 200 ms
Safe isolation	acc. to EN 61010	acc. to EN 61010
Rated insulation voltage	-	-
Surge voltage category Input/output	-	-
Pollution degree	2	2
Test voltage input/output	4 kV (50 Hz, 1 min.)	4 kV (50 Hz, 1 min.)
Test voltage output/power supply	1.5 kV (50 Hz, 1 min.)	2 kV (50 Hz, 1 min.)
Degree of protection	IP20	IP20
Ambient temperature range	-20 °C ... 65 °C (-4°F ... 149°F)	-20 °C ... 65 °C (-4°F ... 149°F)
Dimensions W / H / D	22.5 / 104 / 114.5 mm	22.5 / 104 / 114.5 mm
Screw connection solid / stranded / AWG	0.2 ... 2.5 mm <sup>2</sup> / 0.2 ... 2.5 mm <sup>2</sup> / 24 - 14	0.2 ... 2.5 mm <sup>2</sup> / 0.2 ... 2.5 mm <sup>2</sup> / 24 - 14
Conformance / approvals	CE-compliant	
Conformance	II 3 G Ex nA IIC T4 Gc X	
ATEX	UL 508 Recognized	
UL, USA / Canada		

Ex:   
Housing width 22.5 mm

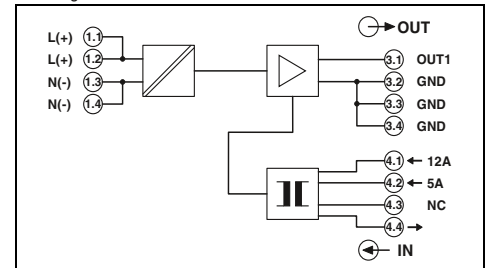

#### Technical data

Input data	0 A AC ... 5 A AC (configurable) / 0 A AC ... 12 A AC (configurable)	
Input current (configurable)		
Nominal frequency	50 Hz	
Frequency range	45 Hz ... 65 Hz	
Curve type	Sine	
Overload capacity	1 x I <sub>N</sub> (continuous)	
Surge strength	8 x I <sub>N</sub> (1 s)	
Connection method	Screw terminal block	
Output data	0 ... 20 mA / 4 ... 20 mA	
Output signal (configurable)	25 mA	
Maximum output signal	< 500 Ω (at 20 mA)	
Load R <sub>B</sub>	< 10 mV <sub>pp</sub> (for 500 Ω at 20 mA)	
Ripple		
General data	MACX MCR-SL-CAC-12-I	MACX MCR-SL-CAC-12-I-UP
Supply voltage U <sub>B</sub>	19.2 V AC/DC ... 253 V AC/DC	19.2 V AC/DC ... 253 V AC/DC
Current consumption	< 33 mA (at 24 V DC)	< 33 mA (at 24 V DC)
Maximum transmission error	≤ 0.5 % (of nominal range value under nominal conditions)	≤ 0.5 % (of nominal range value under nominal conditions)
Temperature coefficient	< 0.02 %/K	< 0.02 %/K
Step response (10-90%)	< 300 ms	< 300 ms
Safe isolation	acc. to EN 61010	acc. to EN 61010
Rated insulation voltage	300 V AC (to ground)	300 V AC (to ground)
Surge voltage category Input/output	III	III
Pollution degree	2	2
Test voltage input/output	4 kV (50 Hz, 1 min.)	4 kV (50 Hz, 1 min.)
Test voltage output/power supply	2 kV (50 Hz, 1 min.)	2 kV (50 Hz, 1 min.)
Degree of protection	IP20	IP20
Ambient temperature range	-20 °C ... 65 °C (-4°F ... 149°F)	-20 °C ... 65 °C (-4°F ... 149°F)
Dimensions W / H / D	22.5 / 104 / 114.5 mm	22.5 / 104 / 114.5 mm
Screw connection solid / stranded / AWG	0.2 ... 2.5 mm <sup>2</sup> / 0.2 ... 2.5 mm <sup>2</sup> / 24 - 14	0.2 ... 2.5 mm <sup>2</sup> / 0.2 ... 2.5 mm <sup>2</sup> / 24 - 14
Conformance / approvals	CE-compliant	
Conformance	II 3 G Ex nA IIC T4 Gc X	
ATEX	UL 508 Recognized	
UL, USA / Canada		

#### Ordering data

Description	Type	Order No.	Pcs. / Pkt.
<b>MCR current transducer</b> for sinusoidal alternating currents			
Supply voltage 19.2 ... 30 V DC	MACX MCR-SL-CAC-5-I	2810612	1
Supply voltage 19.2 ... 253 V AC/DC	MACX MCR-SL-CAC-5-I-UP	2810625	1

#### Accessories

Description	Type	Order No.	Pcs. / Pkt.
<b>DIN rail connector</b> , for bridging the supply voltage (19.2...30 V DC), can be snapped onto 35 mm DIN rails as per EN 60715	ME 22,5 TBUS 1,5/ 5-ST-3,81 GN	2707437	50

#### Ordering data

Description	Type	Order No.	Pcs. / Pkt.
<b>MCR current transducer</b> for sinusoidal alternating currents			
Supply voltage 19.2 ... 30 V DC	MACX MCR-SL-CAC-12-I	2810638	1
Supply voltage 19.2 ... 253 V AC/DC	MACX MCR-SL-CAC-12-I-UP	2810638	1

#### Accessories

Description	Type	Order No.	Pcs. / Pkt.
<b>DIN rail connector</b> , for bridging the supply voltage (19.2...30 V DC), can be snapped onto 35 mm DIN rails as per EN 60715	ME 22,5 TBUS 1,5/ 5-ST-3,81 GN	2707437	50

**AC current transducers, sinusoidal and distorted**

The **MCR-SL-S-...00-...** current transducers measure sinusoidal and non-sinusoidal alternating currents within the range 0 ... 200 A.

- True r.m.s. value measurement from 30...6000 Hz
- Measuring range selection with slide switch
- Loop-powered
- Can be retrofitted with the hinged Rogowski coil

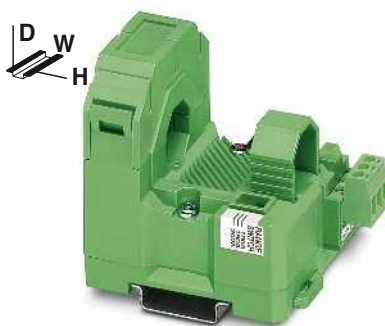

For sinusoidal and non-sinusoidal alternating currents, 0 ... 200 A, voltage output



For sinusoidal and non-sinusoidal alternating currents, 0 ... 200 A, current output (loop-powered)

Ex: Housing width 55 mm

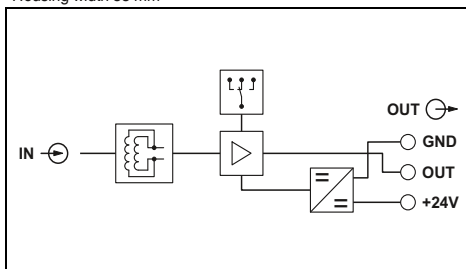

Ex: Housing width 55 mm

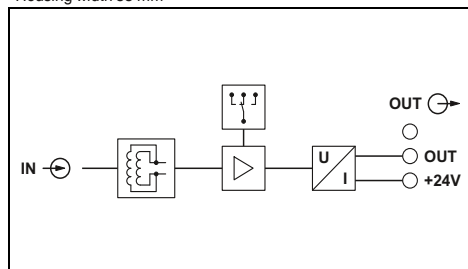

**Technical data**

Input data
Input current (configurable)
Operate threshold
Frequency range
Curve type
Overload capacity
Surge strength
Connection method
Output data
Output signal
Maximum output signal
Load $R_B$
General data
Supply voltage $U_B$
Current consumption
Maximum transmission error
Cable position error
Temperature coefficient
Step response (10-90%)
Safe isolation
Rated insulation voltage
Surge voltage category / pollution degree
Test voltage input/output
Degree of protection
Ambient temperature range
Dimensions W / H / D
Screw connection solid / stranded / AWG
Conformance / approvals
Conformance
UL, USA / Canada

...-S-100-U	...-S-200-U
0 A ... 100 A (0...50/75/100 A)	0 A ... 200 A (0...100/150/200 A)
1 % (of final value)	1 % (of final value)
30 Hz ... 6000 Hz	30 Hz ... 6000 Hz
Sinusoidal and non-sinusoidal	Sinusoidal and non-sinusoidal
Depending on laid conductor	Depending on through connected conductor
Depending on through connected conductor	Depending on through connected conductor
Clamp-on cable design, diameter 18.5 mm	Clamp-on cable design, diameter 18.5 mm
0 ... 5 V / 0 ... 10 V	0 ... 5 V / 0 ... 10 V
(0 V ... 10 V) 14 V, (0 V ... 5 V) 7 V	(0 V ... 10 V) 14 V, (0 V ... 5 V) 7 V
$\geq 10$ k $\Omega$	$\geq 10$ k $\Omega$
20 V DC ... 30 V DC	20 V DC ... 30 V DC
< 30 mA	< 30 mA
< 1 % (of final value)	< 1 % (of final value)
< 0.63 %	< 0.63 %
< 0.035 %/K	< 0.035 %/K
< 340 ms	< 340 ms
As per IEC 61010-1 and IEC 61326	As per IEC 61010-1 and IEC 61326
300 V AC (to ground)	300 V AC (to ground)
III / 2	III / 2
5 kV (50 Hz, 1 min.)	5 kV (50 Hz, 1 min.)
IP20	IP20
-20 °C ... 60 °C	-20 °C ... 60 °C
55 / 85 / 70.5 mm	55 / 85 / 70.5 mm
0.2 ... 2.5 mm <sup>2</sup> / 0.2 ... 2.5 mm <sup>2</sup> / 24 - 14	0.2 ... 2.5 mm <sup>2</sup> / 0.2 ... 2.5 mm <sup>2</sup> / 24 - 14
CE-compliant	CE-compliant
cULus	cULus

**Ordering data**

Description
<b>MCR current transducer</b> for sinusoidal and non-sinusoidal alternating currents
Input current range: 0...50/75/100 A
Input current range: 0...100/150/200 A

Type	Order No.	Pcs. / Pkt.
MCR-SL-S-100-U	2813457	1
MCR-SL-S-200-U	2813460	1

**Technical data**

...-S-100-I-LP	...-S-200-I-LP
0 A ... 100 A (0...50/75/100 A)	0 A ... 200 A (0...100/150/200 A)
1 % (of final value)	1 % (of final value)
30 Hz ... 6000 Hz	30 Hz ... 6000 Hz
Sinusoidal and non-sinusoidal	Sinusoidal and non-sinusoidal
Depending on laid conductor	Depending on laid conductor
Depending on through connected conductor	Depending on through connected conductor
Clamp-on cable design, diameter 18.5 mm	Clamp-on cable design, diameter 18.5 mm
4 ... 20 mA	4 ... 20 mA
< 25 mA	< 25 mA
( $U_B$ - 12 V) x 350 / 12 A	( $U_B$ - 12 V) x 350 / 12 A
20 V DC ... 30 V DC	20 V DC ... 30 V DC
< 1 % (of final value)	< 1 % (of final value)
< 0.63 %	< 0.63 %
< 0.025 %/K	< 0.025 %/K
< 340 ms	< 340 ms
As per IEC 61010-1 and IEC 61326	As per IEC 61010-1 and IEC 61326
300 V AC (to ground)	300 V AC (to ground)
III / 2	III / 2
5 kV (50 Hz, 1 min.)	5 kV (50 Hz, 1 min.)
IP20	IP20
-20 °C ... 60 °C	-20 °C ... 60 °C
55 / 85 / 70.5 mm	55 / 85 / 70.5 mm
0.2 ... 2.5 mm <sup>2</sup> / 0.2 ... 2.5 mm <sup>2</sup> / 24 - 14	0.2 ... 2.5 mm <sup>2</sup> / 0.2 ... 2.5 mm <sup>2</sup> / 24 - 14
CE-compliant	CE-compliant
cULus	cULus

**Ordering data**

Type	Order No.	Pcs. / Pkt.
MCR-SL-S-100-I-LP	2813486	1
MCR-SL-S-200-I-LP	2813499	1

# Monitoring

## Current measurement

### Passive AC current transducer, sinusoidal

The **MCR-SLP-1-5-UI-0** passive current transducer measures sinusoidal alternating currents within the range 0 ... 1 A/0 ... 5 A.

- Loop-powered
- Measuring ranges 1 A and 5 A AC, reconnectable



For sinusoidal alternating currents  
0 ... 1 A/0 ... 5 A



Housing width 22.5 mm

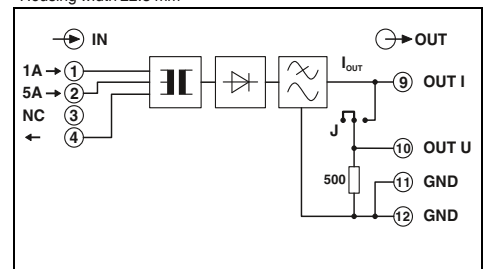

#### Technical data

Input data	1 A input	5 A input
Input current	0 A AC ... 1 A AC	0 A AC ... 5 A AC
Frequency range	45 Hz ... 60 Hz	45 Hz ... 60 Hz
Curve type	Sine	Sine
Overload capacity	2 x I <sub>N</sub> (5 min. at 60°C ambient temperature)	-
Surge strength	50 A (1 s)	100 A (1 s)
Permissible output range	1.2 x I <sub>N</sub>	1.2 x I <sub>N</sub>
Connection method	Screw connection	Screw connection
Output data	U output	I output
Output signal	0 ... 10 V	0 ... 20 mA
Maximum output signal	20 V	30 mA
Load R <sub>B</sub>	> 100 kΩ	< 750 Ω < 250 Ω (when current and voltage outputs are used simultaneously)
Ripple	< 50 mV <sub>PP</sub>	< 50 mV <sub>PP</sub>
General data	< 0.5 % (of final value) < 0.015 %/K < 200 ms acc. to EN 50178, EN 61010 300 V AC (to ground) III / 2 4 kV (50 Hz, 1 min.) IP20 -25 °C ... 60 °C 22.5 / 99 / 114.5 mm 0.2 ... 2.5 mm <sup>2</sup> / 0.2 ... 2.5 mm <sup>2</sup> / 24 - 14 Class A product, see page 625	
Conformance / approvals	CE-compliant	

#### Ordering data

Description	Type	Order No.	Pcs. / Pkt.
<b>MCR passive current transducer</b> for sinusoidal alternating currents	<b>MCR-SLP-1-5-UI-0</b>	<b>2814359</b>	<b>1</b>

### AC current protector, sinusoidal

The **MCR-SL-S-16-SP-24** current protector converts sinusoidal 50 Hz/60 Hz alternating currents into binary switching signals.

- Switching point can be freely selected in the measuring range of 0...16 A AC
- Changeover relay output
- Adjustable switch hysteresis
- 3-way isolation
- Operating current/quiescent current behavior can be set



For sinusoidal alternating currents, 0 ... 16 A AC



Housing width 22.5 mm

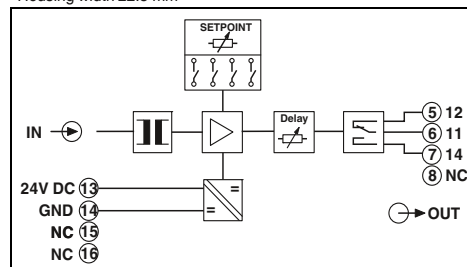

#### Technical data

<b>Input data</b>	0 A AC ... 16 A AC
Input current	45 Hz ... 65 Hz
Frequency range	Sine
Curve type	2 x I <sub>N</sub> (continuous)
Overload capacity	Through connection, diameter 4.2 mm
Connection method	<b>Switching output</b>
<b>Switching output</b>	Relay output
Contact type	1 PDT
Contact material	AgSnO, hard gold-plated
Max. switching current	50 mA (for gold layer, 30 V AC/ 36 V DC)
	2 A (in case of a destroyed gold layer, 250 V AC)
	Adjustable using a DIP switch (0.5 %, 5 %, 10 %, 15 %)
<b>Switching hysteresis</b>	typ. 0.1 s ... 10 s (adjustable using a potentiometer)
<b>Response delay</b>	Adjustable using a DIP switch
<b>Operating and closed-circuit current behavior</b>	Yellow LED (relay active)
Relay status display	
<b>General data</b>	20 V DC ... 30 V DC
Supply voltage U <sub>B</sub>	< 30 mA
Current consumption	< 0.5 %
Setting accuracy	< 0.02 %/K
Temperature coefficient	40 ms
Step response (10-90%)	acc. to EN 50178, EN 61010-1
Safe isolation	300 V AC (to ground)
Rated insulation voltage	III / 2
Surge voltage category / pollution degree	4 kV (50 Hz, 1 min.)
Test voltage input/output	4 kV (50 Hz, 1 min.)
Test voltage input/power supply	IP20
Degree of protection	-20 °C ... 65 °C
Ambient temperature range	22.5 / 99 / 114.5 mm
Dimensions W / H / D	0.2 ... 2.5 mm <sup>2</sup> / 0.2 ... 2.5 mm <sup>2</sup> / 24 - 14
Screw connection solid / stranded / AWG	Class A product, see page 625
EMC note	
<b>Conformance / approvals</b>	CE-compliant
Conformance	

#### Ordering data

<b>Description</b>	<b>Type</b>	<b>Order No.</b>	<b>Pcs. / Pkt.</b>
<b>MCR current protector</b> for sinusoidal alternating currents	<b>MCR-SL-S- 16-SP- 24</b>	<b>2864464</b>	<b>1</b>

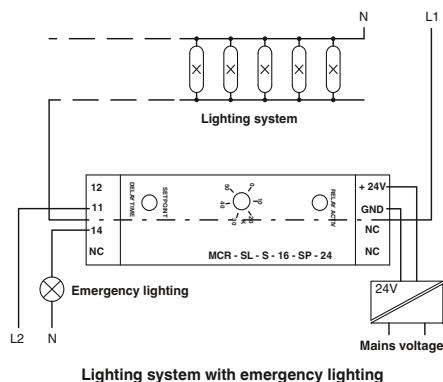



# Monitoring

## Current measurement

### Accessories

#### Configuration software package

The **MCR/PI-CONF-WIN** configuration software package is used to configure and visualize all parameters for the programmable MCR measuring transducers.

- Straightforward menu interface
- Rapid programming

**Notes:**  
The software runs under the following operating systems: Windows NT™, 2000™, and XP™.



For MCR-S-... current transducer

Description
<b>MCR configuration software</b> , for programming MCR-T-..., MCR-...-LP-..., MCR-...-HT-..., MCR-S-..., MCR-F-..., and MCR-PSP-... modules, CD-ROM
<b>Labels</b> , for marking MCR-T and MCR-S modules, four sheets DIN A4 marking labels (112 pieces.)

Ordering data		
Type	Order No.	Pcs. / Pkt.
MCR/PI-CONF-WIN	2814799	1
Accessories		
MCR-ET 38X35 WH	2814317	1

## USB adapter cable Software adapter cable

The following adapter cables are available for programming the MCR-S... current transducers:

- USB adapter cable
- Software adapter cable



For MCR-S-... current transducer

Description
<b>USB adapter cable</b> , D-9-SUB to USB, with adapter D-9-SUB to D-25-SUB
<b>Software adapter cable</b> (stereo jack plug/25-pos. D-SUB), 1.2 m long, for programming MCR-T-..., MCR-S-..., and MCR-F-... modules
<b>Adapter cable</b> , flexible, 9-pos. D-SUB socket to 25-pos. D-SUB pin

Ordering data		
Type	Order No.	Pcs. / Pkt.
CM-KBL-RS232/USB	2881078	1
MCR-TTL-RS232-E	2814388	1
Accessories		
PSM-KAD 9 SUB 25/BS	2761295	1



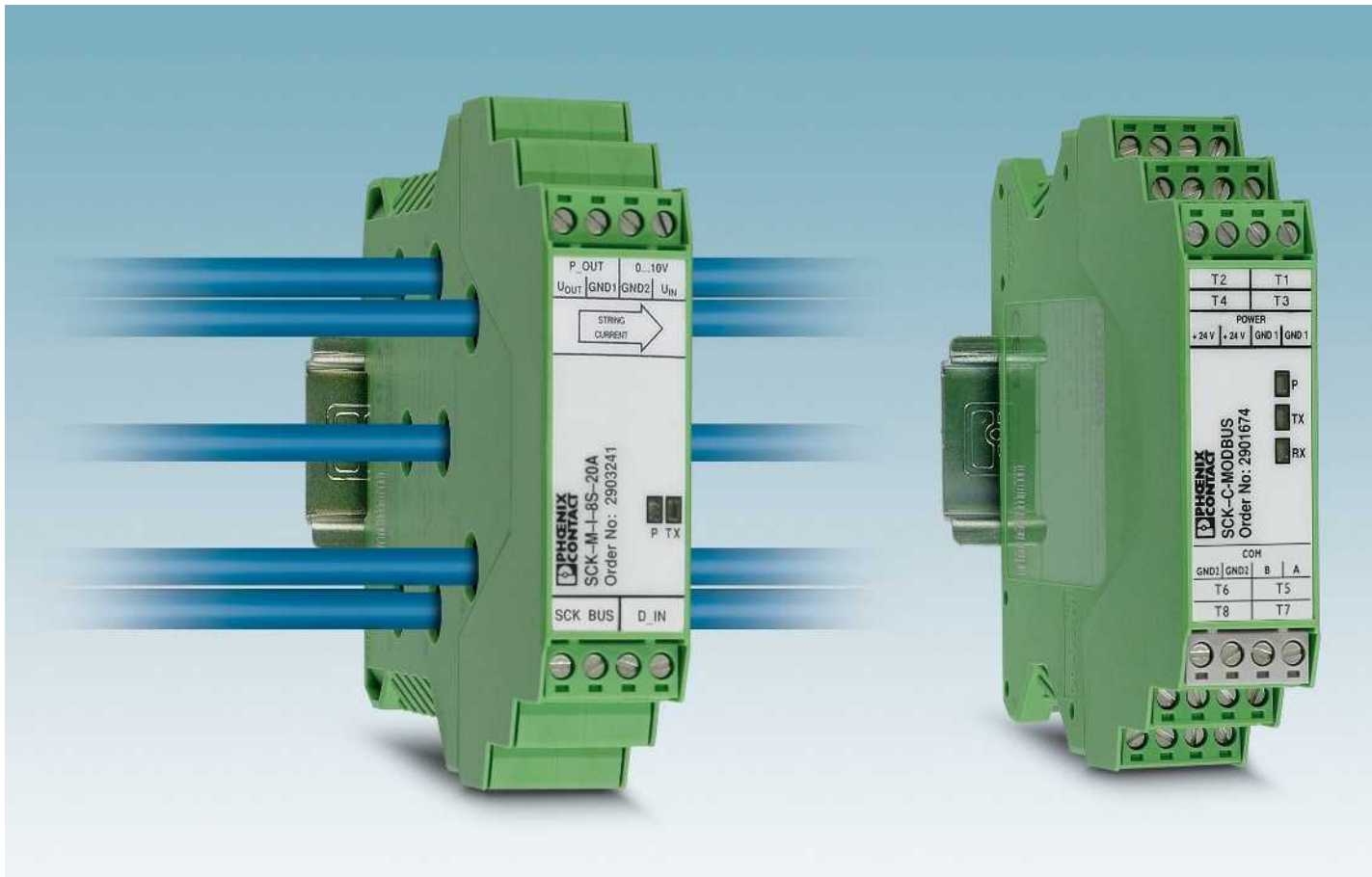

### Utilize solar electricity efficiently

Detect errors – increase efficiency: photovoltaic systems should achieve maximum energy yield within the shortest possible time.

SOLARCHECK provides reliable information regarding the performance of your photovoltaic system. It can be used to detect faults, which may be caused by damaged panels, defective contacts or damage in the cabling. This allows you to implement countermeasures quickly, thereby increasing the efficiency of your system.

### Current topic: reliable monitoring

Whether a small roof-top system on a family home or a megawatt outdoor system: for reliable operation, the photovoltaic market requires monitoring systems where status information is continuously available and visualization is easy. Phoenix Contact offers a comprehensive portfolio of hardware and software products specifically designed for this purpose.

### Energy of the future

From installation to monitoring - in the “Components and systems for photovoltaics” brochure you will find further innovative solutions for your photovoltaic system, such as:

- Connection technology
- Surge protection
- Hardware and software solutions
- Generator connection boxes
- Tools and marking

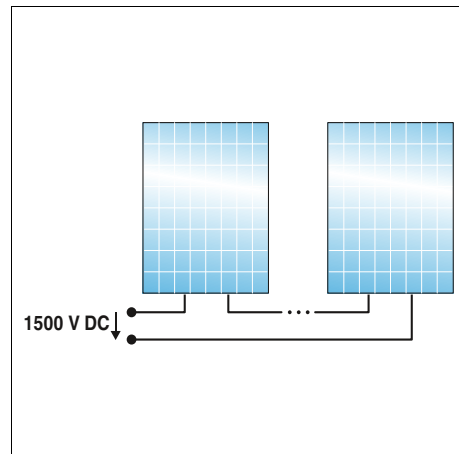
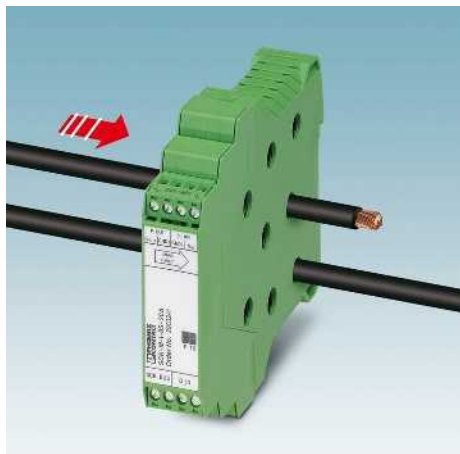

**Contact-free current measurement**

Contact-free measurement using Hall sensors offers many advantages:

- Safe isolation is already ensured by the cable insulation.
- No contact resistance due to additional contact points.
- The current is forwarded safely as the line circuit is not directly accessed.

**Space-saving installation without an additional power supply**

With a width of just 22.5 mm, the narrow measuring module bundles the cables in a confined space.

- The 2-wire communication cable is also used to supply the measuring modules.
- This means that one communication module supplies up to eight measuring modules – without an additional power supply.

**Flexible expansion**

Optional extension of voltage measurement up to 1500 V DC.

- Also suitable for grounded systems.
- Suitable for PV systems with extra high system voltages
- Flexible use, even outside the SOLARCHECK system

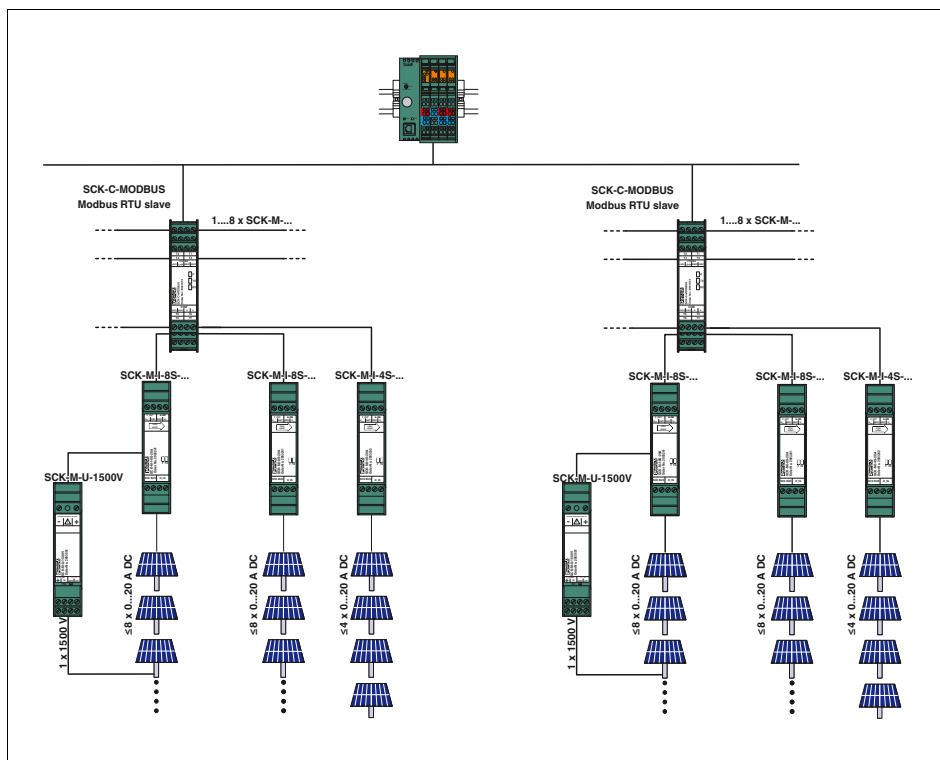

**Easy integration in monitoring systems**

The modular SOLARCHECK monitoring system consists of various measuring modules for current and voltage measurement and an associated communication module.

The communication module collects the measured values from the current measuring modules and forwards them to a higher-level controller. You can acquire up to eight or four string currents with one current measuring module each. A maximum of eight current measuring modules of any type can be connected to one communication module. The 2-wire communication cable is also used to supply the measuring modules with power. This means that no additional power supply is required in the field.

The voltage measuring module is usually connected to and also supplied via the analog input provided on the 8-channel current measuring modules.

# Monitoring

## Monitoring and diagnostics

### Solar system monitoring

#### PV string monitoring

##### SOLARCHECK

The modular SOLARCHECK monitoring system consists of various devices for current and voltage measurement and an associated communication module.

##### Communication module:

- For connecting and collecting measured values from up to eight measuring modules
- Provision of data for transfer to higher-level controllers

##### Current measuring modules:

- 8-channel current measurement up to 20 A DC
- Detection of reverse currents up to -1 A
- 4-channel extension modules for 20 A DC
- Internal temperature monitoring
- Digital input for monitoring, e.g., the remote indication contacts of surge protection modules
- Supply via the communication module

##### Voltage measuring module

- Voltage measurement up to 1500 V DC in any grounded PV system
- Connection and supply is usually via the analog input provided (0 ... 10 V) on the 8-channel SOLARCHECK current measuring module
- Output of the voltage measured value as a 2 ... 10 V analog signal
- As an option, can also be removed from the SOLARCHECK group and used separately



Communication module  
RS-485 (Modbus RTU)



Housing width 22.5 mm

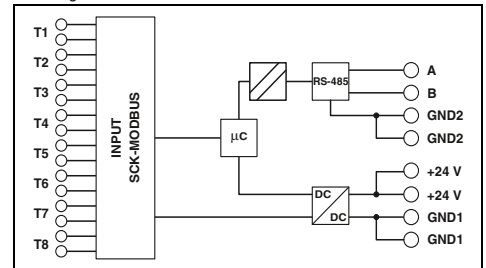

#### Technical data

Supply	
Supply voltage	24 V DC -10 % ... +25 %
Own current consumption	22 mA (typical)
Measuring input	
Current measuring range	-
Transmission error, maximum	-
Temperature coefficient	-
Reverse current detection	-
Number of measuring channels	-
Voltage measuring range	-
Connection method	-
Digital input	
Controlled by external floating contact	-
Analog input	
Input voltage range	-
Analog output	
Output voltage range	-
SCK-C-MODBUS data interface	
Cable length (for 0.15 mm <sup>2</sup> )	-
Communication protocol	Proprietary
Serial port	RS-485
Serial transmission speed	9.6/14.4/19.2/38.4 kbps
Cable length	≤ 1200 m
Communication protocol	Modbus/RTU
General data	
Degree of protection	IP20
Ambient temperature range	-20 °C ... 70 °C
Dimensions W / H / D	22.5 / 102 / 106 mm
Screw connection solid / stranded / AWG	0.2 ... 2.5 mm <sup>2</sup> / 0.2 ... 2.5 mm <sup>2</sup> / 24 - 12
EMC note	Class A product, see page 625
Conformance / approvals	
Conformance	CE-compliant
UL, USA	1741 Recognized
UL, USA / Canada	508 Listed

#### Ordering data

Description	Type	Order No.	Pcs. / Pkt.
Communication module	SCK-C-MODBUS	2901674	1
Current measuring module, 8-channel			
Current measuring module, 4-channel for extension			
Voltage measuring module			



Current measuring module, 20 A DC, 8-channel



Extension module, 4-channel Current measurement 20 A DC



Voltage measuring module, 0...1500 V DC

Housing width 22.5 mm

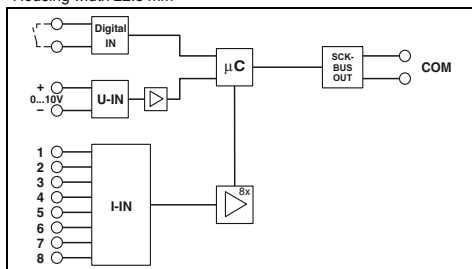

Housing width 22.5 mm

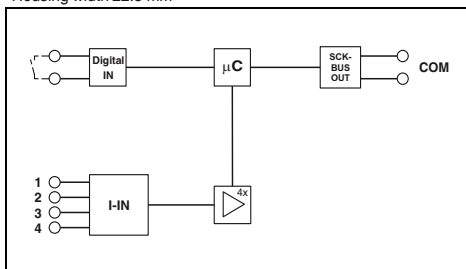

Housing width 22.5 mm

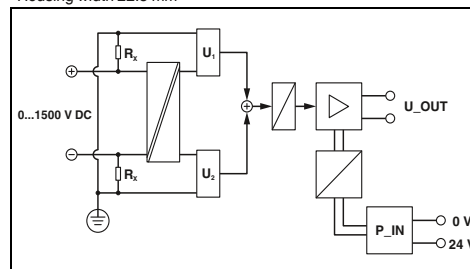

Technical data

Via SCK-C-MODBUS  
 43 mA (typical)  
 0 A DC ... 20 A DC (UL: 0 A DC...25 A DC)  
 ± 1 % (of measuring range final value)  
 0.02 %/K (T<sub>K20</sub>)  
 -1 A DC ... 0 A DC  
 8  
 Through connection, 9.5 mm diameter  
 Floating switch contacts  
 0 V ... 10 V  
 -  
 ≤ 300 m (0.14 mm<sup>2</sup>)  
 Proprietary  
 -  
 -  
 IP20  
 -20 °C ... 70 °C  
 22.5 / 102 / 128.5 mm  
 0.2 ... 2.5 mm<sup>2</sup> / 0.2 ... 2.5 mm<sup>2</sup> / 24 - 12  
 Class A product, see page 625

Technical data

Via SCK-C-MODBUS  
 43 mA (typical)  
 0 A DC ... 20 A DC (UL: 0 A DC...25 A DC)  
 ± 1 % (of measuring range final value)  
 0.02 %/K (T<sub>K20</sub>)  
 -1 A DC ... 0 A DC  
 4  
 Through connection, 9.5 mm diameter  
 Floating switch contacts  
 -  
 -  
 ≤ 300 m (0.14 mm<sup>2</sup>)  
 Proprietary  
 -  
 -  
 IP20  
 -20 °C ... 70 °C  
 22.5 / 102 / 128.5 mm  
 0.2 ... 2.5 mm<sup>2</sup> / 0.2 ... 2.5 mm<sup>2</sup> / 24 - 12  
 Class A product, see page 625

Technical data

24 V DC -10 % ... +25 % (or via SSCK-M-I-8S-20A)  
 8 mA (typical)  
 -  
 ± 1 % (after additional tuning (valid for 100 - 1500 V DC))  
 < 0.01 %/K  
 1  
 0 V DC ... 1500 V DC  
 Screw connection  
 -  
 -  
 2 V DC ... 10 V DC  
 -  
 -  
 IP20  
 -20 °C ... 70 °C  
 22.5 / 102 / 128.5 mm  
 0.2 ... 2.5 mm<sup>2</sup> / 0.2 ... 2.5 mm<sup>2</sup> / 24 - 12  
 Class A product, see page 625

Ordering data

Type	Order No.	Pcs. / Pkt.
SCK-M-I-8S-20A	2903241	1

Ordering data

Type	Order No.	Pcs. / Pkt.
SCK-M-I-4S-20A	2903242	1

Ordering data

Type	Order No.	Pcs. / Pkt.
SCK-M-U-1500V	2903591	1



# Monitoring

## Monitoring and diagnostics

Detect errors before they actually occur



RCM devices provide residual current monitoring in grounded power supply systems. They detect residual currents at an early stage such as those that occur as a result of insulation errors. They can therefore be used to prevent forced system shutdown. Plans can be made to remove errors outside of operating hours. RCM devices also act as a form of fire prevention.

Increasing use is being made of equipment such as frequency inverters. In the event of an error, residual currents with a frequency of up to 50 kHz can be generated. Type B+ RCM devices from Phoenix Contact are already able to detect residual currents with frequencies up to 100 kHz. This far exceeds present-day requirements of 20 kHz for type B+ devices.

	Single-phase	Single-phase with smoothing	Three-phase star circuit
<b>Circuit</b>			
<b>Correct load current</b>			
<b>Residual current to ground potential</b>			
<b>Solution</b>	Type A	-	-
	Type B	Type B	Type B

Residual currents can increase continually due to gradual processes. This can be attributed, for example, to humidity or conductive dirt on live parts. Residual current devices trip at different rated residual currents  $I_{\Delta n}$ , depending on their type. Additionally installed residual current monitoring devices prevent sudden system downtimes thanks to early warnings. The continuous supply of information about gradually increasing residual currents allows timely intervention. Unplanned system failures can be avoided.

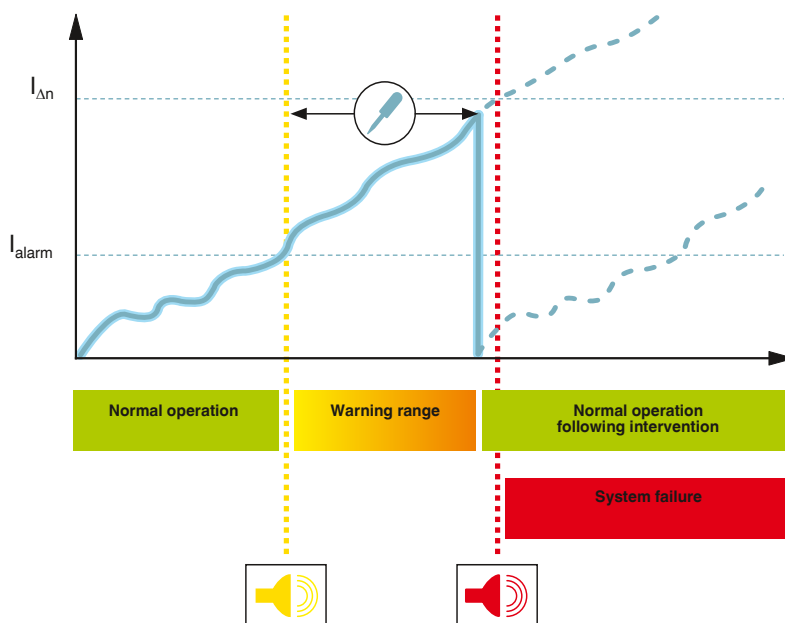

Full bridge circuit	Semi-controlled full bridge circuit	Full bridge circuit between outer conductors	Three-phase full bridge circuit	Phase-controlled modulator	Burst control
<b>Type A</b>	<b>Type A</b>	-	-	<b>Type A</b>	<b>Type A</b>
<b>Type B</b>	<b>Type B</b>	<b>Type B</b>	<b>Type B</b>	<b>Type B</b>	<b>Type B</b>

# Monitoring

## Monitoring and diagnostics

### Residual current monitoring - RCM

- Adjustable residual response current of 30 mA to 3 A
- Adjustable pre-alarm threshold and delay time
- Actual differential current can be read via LED display
- Remote signaling for main and pre-alarm

**Notes:**  
Cables for type B+ converter connection (RJ45, 4-pair, 1:1 line) can be found in the accessories section by entering the order number (RCM/converter) at: [phoenixcontact.net/products](http://phoenixcontact.net/products)



**RCM type B+ for smooth and pulsating DC and AC residual currents up to 100 kHz**



**Converter for RCM type B+**

Total width 71.6 mm

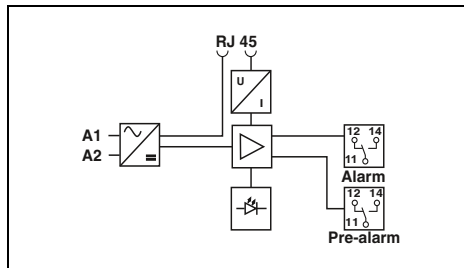

Total width 65.5 mm

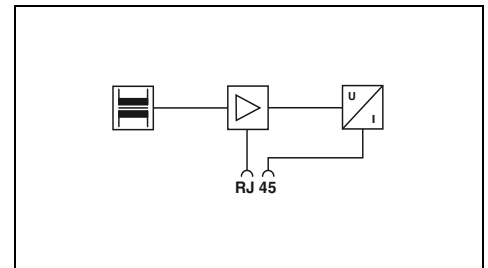

Electrical data	
Nominal voltage range	85 V AC ... 264 V AC
Nominal frequency $f_N$	50 Hz (60 Hz)
Rated current $I_n$	-
Max. required back-up fuse	16 A (B)
RCM data	
Rated response differential current $I_{dyn}$	3 A
Differential current acquisition characteristic	Type B+ (DC up to 100 kHz)
Response differential current $I_{dn}$	30, 100, 300, 1000, 3000 mA (adjustable)
Discrimination threshold main alarm	80 % ... 100 % (of the set response differential current $I_{dn}$ )
Discrimination threshold pre-alarm	10 % ... 90 % (of the main alarm threshold, adjustable)
Response time for 2 x $I_{dn}$	0.1 s ... 1 s (adjustable)
Thermal permanent differential current $I_{dth}$	-
Thermal rated short-time differential current $I_{dth}$	-
Rated surge voltage resistance $U_{imp}$	4 kV
General data	
Connection data solid / stranded / AWG	0.2 ... 4 mm <sup>2</sup> / 0.2 ... 2.5 mm <sup>2</sup> / 24 - 12
Maximum permissible outside diameter of cables	-
Housing material	Polycarbonate
Ambient temperature (operation)	-25 °C ... 65 °C
Degree of protection	IP20
Test standards	DIN EN 62020 / DIN EN 60664 / DIN VDE 0664-400
Test standards	-
Pollution degree	2
Surge voltage category	III
Mounting	
Mounting type	DIN rail: 35 mm
Remote indication contact	PDT contact
Connection data solid / stranded / AWG	0.2 ... 4 mm <sup>2</sup> / 0.2 ... 2.5 mm <sup>2</sup> / -
Max. operating voltage	230 V AC
Max. operating current	5 A (cos phi > 0.9)

Technical data	
...SCT-35	...SCT-70
125 A	200 A
3 A	3 A
Type B+ (DC up to 100 kHz)	Type B+ (DC up to 100 kHz)
0.03 A ... 3 A	0.03 A ... 3 A
-	-
150 A (50 Hz / 20 kHz)	150 A (50 Hz / 20 kHz)
3 kA for 1 s (50 Hz/20 kHz)	3 kA for 1 s (50 Hz/20 kHz)
8 kV	8 kV
0.2 ... 4 mm <sup>2</sup> / 0.2 ... 2.5 mm <sup>2</sup> / 24 - 12	-
Polycarbonate	Polycarbonate
-25 °C ... 65 °C	-20 °C ... 65 °C
IP20	IP20
DIN EN 62020 / DIN EN 60664 / DIN VDE 0664-400	DIN EN 62020 / VDE 0663 / DIN EN 60044-1 / VDE 0414 / DIN VDE 0664-400
-	-
2	2
III	IV
DIN rail: 35 mm	Screw mounting
PDT contact	-
0.2 ... 4 mm <sup>2</sup> / 0.2 ... 2.5 mm <sup>2</sup> / -	-
230 V AC	-
5 A (cos phi > 0.9)	-

Technical data		
...SCT-35	...SCT-70	...SCT-105
125 A	200 A	300 A
3 A	3 A	3 A
Type B+ (DC up to 100 kHz)	Type B+ (DC up to 100 kHz)	Type B+ (DC up to 100 kHz)
0.03 A ... 3 A	0.03 A ... 3 A	0.1 A ... 3 A
-	-	-
150 A (50 Hz / 20 kHz)	150 A (50 Hz / 20 kHz)	150 A (50 Hz / 20 kHz)
3 kA for 1 s (50 Hz/20 kHz)	3 kA for 1 s (50 Hz/20 kHz)	3 kA for 1 s (50 Hz/20 kHz)
8 kV	8 kV	8 kV
0.2 ... 4 mm <sup>2</sup> / 0.2 ... 2.5 mm <sup>2</sup> / 24 - 12	-	-
Polycarbonate	Polycarbonate	Polycarbonate
-25 °C ... 65 °C	-20 °C ... 65 °C	-20 °C ... 65 °C
IP20	IP20	IP20
DIN EN 62020 / DIN EN 60664 / DIN VDE 0664-400	DIN EN 62020 / VDE 0663 / DIN EN 60044-1 / VDE 0414 / DIN VDE 0664-400	DIN EN 62020 / VDE 0663 / DIN EN 60044-1 / VDE 0414 / DIN VDE 0664-400
-	-	-
2	2	2
III	IV	IV
DIN rail: 35 mm	Screw mounting	Screw mounting
PDT contact	-	-
0.2 ... 4 mm <sup>2</sup> / 0.2 ... 2.5 mm <sup>2</sup> / -	-	-
230 V AC	-	-
5 A (cos phi > 0.9)	-	-

Ordering data	
Description	
Evaluation unit	
Current transformer	
20 mm Ø	
30 mm Ø	
35 mm Ø	
70 mm Ø	
105 mm Ø	
140 mm Ø	
210 mm Ø	

Ordering data		
Type	Order No.	Pcs. / Pkt.
RCM-B/50/85-264V	2806210	1

Ordering data		
Type	Order No.	Pcs. / Pkt.
RCM-B-SCT-35	2806223	1
RCM-B-SCT-70	2806236	1
RCM-B-SCT-105	2806249	1



RCM type A for pulsating DC and AC residual currents with 50/60 Hz



Converter for RCM type A



Converter for RCM type A

Total width 71.6 mm

Total width 32 mm

Total width 33 mm

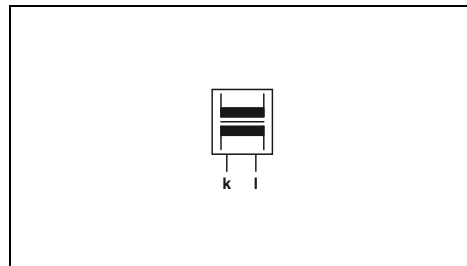
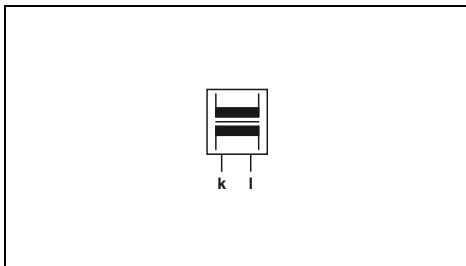
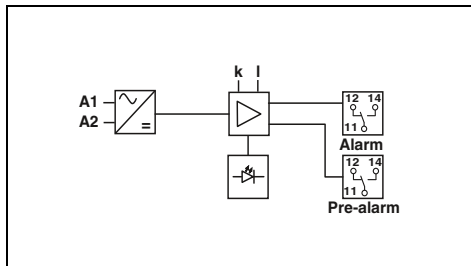

Technical data
85 V AC ... 264 V AC
50 Hz (60 Hz)
-
16 A (B)
3 A
Type A (50 / 60 Hz)
30, 100, 300, 1000, 3000 mA (adjustable)
80 % ... 100 % (of the set response differential current $I_{\Delta n}$ )
10 % ... 90 % (of the main alarm threshold, adjustable)
0.1 s ... 1 s (adjustable)
-
4 kV
0.2 ... 4 mm <sup>2</sup> / 0.2 ... 2.5 mm <sup>2</sup> / 24 - 12
-
Polycarbonate
-25 °C ... 65 °C
IP20
DIN EN 62020 / DIN EN 60664
-
2
III
DIN rail: 35 mm
PDT contact
0.2 ... 4 mm <sup>2</sup> / 0.2 ... 2.5 mm <sup>2</sup> / -
230 V AC
5 A (cos phi > 0.9)

Technical data			
...SCT-20	...SCT-30	...SCT-35	...SCT-70
-	-	-	-
50 A	100 A	125 A	200 A
-	-	-	-
3 A	3 A	3 A	3 A
Type A (50 / 60 Hz)	Type A (50 / 60 Hz)	Type A (50 / 60 Hz)	Type A (50 / 60 Hz)
0.03 A ... 3 A	0.03 A ... 3 A	0.03 A ... 3 A	0.03 A ... 3 A
-	-	-	-
-	-	-	-
1.5 x $I_n$	1.5 x $I_n$	1.5 x $I_n$	1.5 x $I_n$
10 x $I_n$ (for 1 s)	10 x $I_n$ (for 1 s)	10 x $I_n$ (for 1 s)	10 x $I_n$ (for 1 s)
8 kV	8 kV	8 kV	8 kV
0.2 ... 4 mm <sup>2</sup> / 0.2 ... 2.5 mm <sup>2</sup> / 24 - 12	0.2 ... 4 mm <sup>2</sup> / 0.2 ... 2.5 mm <sup>2</sup> / 24 - 12	0.2 ... 4 mm <sup>2</sup> / 0.2 ... 2.5 mm <sup>2</sup> / 24 - 12	0.2 ... 4 mm <sup>2</sup> / 0.2 ... 2.5 mm <sup>2</sup> / 24 - 12
13.00 mm	20.00 mm	23.00 mm	46.00 mm
-	-	-	-
-	-	-	-
-	-	-	-
2	2	2	2
IV	IV	IV	IV
DIN rail: 35 mm	DIN rail: 35 mm	Screw mounting	Screw mounting
-	-	-	-
-	-	-	-
-	-	-	-

Technical data		
...SCT-105	...SCT-140	...SCT-210
-	-	-
250 A	350 A	400 A
-	-	-
3 A	3 A	3 A
Type A (50 / 60 Hz)	Type A (50 / 60 Hz)	Type A (50 / 60 Hz)
0.03 A ... 3 A	0.03 A ... 3 A	0.03 A ... 3 A
-	-	-
-	-	-
1.5 x $I_n$	1.5 x $I_n$	1.5 x $I_n$
10 x $I_n$ (for 1 s)	10 x $I_n$ (for 1 s)	10 x $I_n$ (for 1 s)
8 kV	8 kV	8 kV
0.2 ... 4 mm <sup>2</sup> / 0.2 ... 2.5 mm <sup>2</sup> / 24 - 12	0.2 ... 4 mm <sup>2</sup> / 0.2 ... 2.5 mm <sup>2</sup> / 24 - 12	0.2 ... 4 mm <sup>2</sup> / 0.2 ... 2.5 mm <sup>2</sup> / 24 - 12
70.00 mm	93.00 mm	140.00 mm
-	-	-
-	-	-
-	-	-
2	2	2
IV	IV	IV
Screw mounting	Screw mounting	Screw mounting
-	-	-
-	-	-
-	-	-

Ordering data		
Type	Order No.	Pcs. / Pkt.
RCM-A/50/85-264V	2806016	1

Ordering data		
Type	Order No.	Pcs. / Pkt.
RCM-A-SCT- 20	2806045	1
RCM-A-SCT- 30	2806058	1
RCM-A-SCT- 35	2806061	1
RCM-A-SCT- 70	2806074	1

Ordering data		
Type	Order No.	Pcs. / Pkt.
RCM-A-SCT-105	2806087	1
RCM-A-SCT-140	2806090	1
RCM-A-SCT-210	2806100	1



### Control and monitor the charging process of electric vehicles

Sustainable E-Mobility requires safe and reliable charging infrastructure functions that can be intelligently integrated into energy systems if required. The controller and monitoring components from Phoenix Contact allow the setup of charging stations according to current standards and therefore ensure a high degree of safety and interoperability with electric vehicles.

### Charging controllers for AC charging

Charge electric vehicles according to the IEC 61851-1 standard with the E-Mobility **EV-CC-...** and **EM-CP-PP-ETH** charging controllers. The portfolio addresses the entire spectrum of charging stations, from simple autonomous charging points up to networked stations. Comprehensive configuration options in the devices are provided for the specific requirements of our customers.

### From the charging point to the networked charging infrastructure

Phoenix Contact charging controllers can be operated both autonomously and in networks. Status data can be acquired via the integrated communication interfaces and controlled intervention into the charging process. Here we rely on standardized communication interfaces and protocols and therefore offer easy connection options to various automation systems.

### Smart charging

Operating a charging infrastructure requires more than just the charging technology in the charging station. Intelligent charging infrastructures are integrated in management systems and communicate with billing and operator systems. Based on Phoenix Contact products, software function blocks for implementing charging and energy management, authorization routines, and interfaces to back-end systems are available, for example, via the Open Charge Point Protocol (OCPP).

### Residual current detection in the charging station

The E-Mobility residual current modules from the **EV-RCM** series detect AC and DC residual currents. In conjunction with existing residual current protection devices, the modules increase the voltage protection level during charging of electric vehicles according to DIN VDE 0100-722. Based on IEC 62752, residual current devices (e.g., RCD type A) are protected against DC components and can continue to be operated.



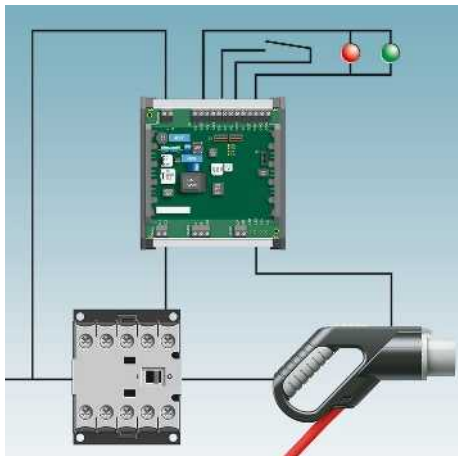

### All the necessary functions in one controller

The **EV-CC-...** charging controllers are specially designed for simple charging points. All functions required for this application are integrated. From the interface to the vehicle, the control of the connector locking and its release in case of mains failure or control of the charging contactor, all in one device.



### The optimum marking solution for every version

The versions of the **EV-CC-...** are conceived respectively for the possible charging station types. Corresponding versions are available, whether for charging stations with permanently connected Vehicle Connector or with an Infrastructure Socket Outlet, classical design with DIN rail or PCB for integration into the housing.

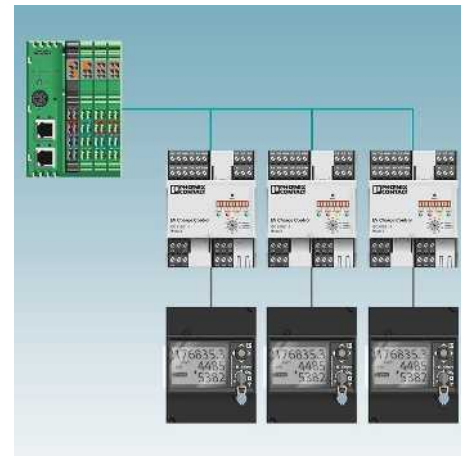

### Interface to power meters

Detection of the actual charging current and the charging power for each individual vehicle is necessary for efficient charging and energy management.

The **EM-CP-PP-ETH** charging controller is equipped with a configurable RS-485/Modbus/RTU interface, to which various meters can be connected.

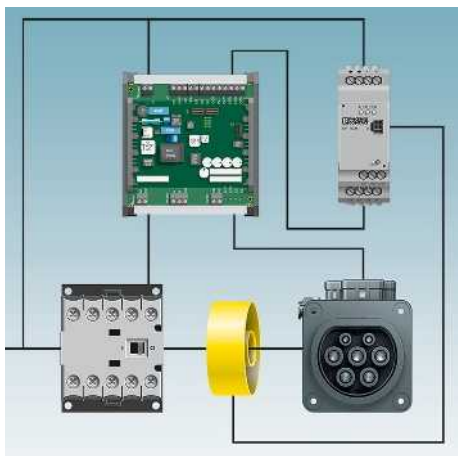

### Compatible with Phoenix Contact charging controllers

The universal **RCM modules** from Phoenix Contact detect DC and AC residual current and therefore offer additional protection during vehicle charging. Optional status monitoring and resetting of the RCM module is possible in conjunction with the charging controllers from Phoenix Contact.



### Vehicle Connectors and Infrastructure Socket Outlets

Phoenix Contact has a unique and wide range of Vehicle Connectors, charging cables, Infrastructure Socket Outlets, and vehicle inlets. Different standards for the European, American, and Chinese markets are covered. Solutions for both conventional AC and fast DC charging are available for all standards - in particular components of so-called "Combined Charging Systems" (CCS).

### Note:

Information on charging systems can be found in Catalog 4, Sensor/actuator cabling and industrial connectors.



# Monitoring

## Components for E-Mobility

### EV Charge Control charging controller

#### EM-CP-PP-ETH

- AC charging according to IEC 61851-1, Mode 3
- Comprehensive configuration options
- Ethernet/Modbus/TCP interface
- Charging and energy management
- Connection of power meters

#### EM-EV-CLR-12V

- Plug release in case of mains failure
- For 12 V actuators



Charging controller



Mains power failure plug release

**Notes:**  
For information on plug-in charging systems, see Catalog 2, Connection technology for field devices.

Housing width 71.6 mm

Housing width 35.6 mm

	Technical data	Technical data
<b>Input</b>		
Description of the input	Digital input	Signal input
Nominal input voltage $U_N$	24 V	12 V
Input current	8 mA (24 V)	approx. 5 mA (at 12 V)
Input voltage level digital I/O	-3 V ... 5 V (Off) 15 V ... 30 V (On)	-3 V ... 3 V (Off) -30 V ... -10 V (lock ON) 10 V ... 30 V (release ON)
<b>Switching output</b>		
Socket locking	Relay output $R_{1,3}$ and $R_{2,4}$	Relay output
Maximum switching voltage	30 V AC/DC	approx. 11.5 V (operating/capacitor voltage minus the diode voltage of ~ 0.5 V)
Max. switching current	6 A	4 A
Switching output		
Charging contactor output	Relay output $C_{1,2}$ and $V_{1,2}$	-
Maximum switching voltage	250 V AC	-
Max. switching current	6 A	-
Maximum switching capacity	1500 VA	-
Switching output		
Ventilation control	Digital output	-
Maximum output voltage	30 V	-
Maximum output current	0.6 A	-
Digital outputs		
Number of outputs	4	-
Output voltage	12 V ... 30 V	-
Output current	0.1 A (total current for all outputs; internally supplied) 0.6 A (per output; externally supplied)	-
<b>Ethernet interface</b>		
Designation	Ethernet interface, 100Base-TX according to IEEE 802.3u / 10Base-T according to IEEE 802.3	-
Connection method	RJ45 socket	-
Transmission speed	10/100 Mbps	-
Transmission length	100 m (with shielded, twisted-pair data cable)	-
<b>RS-485 interface</b>		
Designation	RS-485 interface, 2-wire + GND	-
Connection method	Screw connection	-
Transmission mode	8, N, 1	-
Transmission speed	9.6 kbps (standard) 2.4 kbps ... 19.2 kbps (adjustable)	-
Protocols	Modbus/RTU (master)	-
<b>General data</b>		
Supply voltage		12 V DC $\pm$ 5 %
Supply voltage range	110 V AC ... 240 V AC (nominal voltage range) 95 V AC ... 264 V AC	-
Max. current consumption	40 mA	-
Frequency range	45 Hz ... 65 Hz	-
Degree of protection	IP20	IP20
Ambient temperature range	-25 °C ... 60 °C	-25 °C ... 60 °C
Dimensions W / H / D	71.6 / 61 / 90 mm	35.6 / 61 / 90 mm
Conformance / approvals		
Conformance	CE-compliant	CE-compliant

	Ordering data			Ordering data		
Description	Type	Order No.	Pcs. / Pkt.	Type	Order No.	Pcs. / Pkt.
EV Charge Control charging controller	EM-CP-PP-ETH	2902802	1			
Mains failure plug release EV Charge Lock Release				EM-EV-CLR-12V	2903246	1

**EV CC Electrical Vehicle Charge Control**

**EV-CC-AC1-M3-CBC-SER-...**

- AC charging according to IEC 61851-1, Mode 3
- Comprehensive configuration options
- Adjustable amperage
- Integrated locking controller (12 V) and mains failure plug release
- RS-485 interface (Modbus/RTU slave)
- PCB version and DIN rail device

new

new

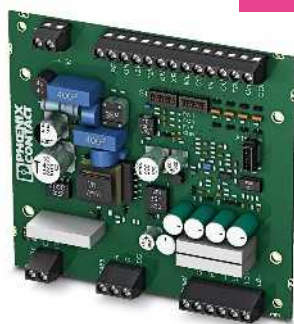

Charging controller on PCB

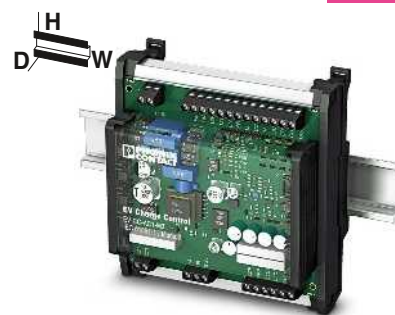

DIN rail housing charging controller

Housing width 120 mm

**Technical data**

<b>Input</b>	
Description of the input	Digital input
Nominal input voltage $U_N$	12 V
Input current	≤ 1 mA (12 V)
Input voltage level digital I/O	0 V ... 3 V (Off) 9 V ... 15 V (On)
<b>Switching output</b>	
Socket locking	Relay output
Maximum switching voltage	12 V (internal supply)
Max. switching current	2 A (internal supply)
<b>Switching output</b>	
Charging contactor output	Relay output
Maximum switching voltage	250 V AC (external supply)
Max. switching current	6 A (external supply)
Maximum switching capacity	1500 VA
<b>Digital outputs</b>	
Number of outputs	4
Output voltage	5 V ... 30 V
Output current	0.5 A (total current for all outputs; internally supplied) 0.6 A (per output; externally supplied)
<b>RS-485 interface</b>	
Designation	RS-485 interface, 2-wire + GND
Connection method	Screw connection
Transmission mode	8, N, 1
Transmission speed	9.6 kbps (standard) 9.6 kbps ... 19.2 kbps (adjustable)
<b>Protocols</b>	Modbus/RTU (slave)
<b>General data</b>	
Supply voltage range	100 V AC ... 240 V AC (nominal voltage range)
Power consumption	< 1 W (no-load)
Frequency range	50 Hz ... 60 Hz
Degree of protection	IP00
Ambient temperature range	-35 °C ... 70 °C (operation)
Dimensions W / H / D	120 / 108 / 20 mm
Conformance / approvals	
Conformance	CE-compliant

**Ordering data**

<b>Description</b>	
<b>Charging controller</b> for case B and C	

Type	Order No.	Pcs. / Pkt.
EV-CC-AC1-M3-CBC-SER-PCB	1622453	1

Housing width 124 mm

**Technical data**

<b>Input</b>	
Description of the input	Digital input
Nominal input voltage $U_N$	12 V
Input current	≤ 1 mA (12 V)
Input voltage level digital I/O	0 V ... 3 V (Off) 9 V ... 15 V (On)
<b>Switching output</b>	
Socket locking	Relay output
Maximum switching voltage	12 V (internal supply)
Max. switching current	2 A (internal supply)
<b>Switching output</b>	
Charging contactor output	Relay output
Maximum switching voltage	250 V AC (external supply)
Max. switching current	6 A (external supply)
Maximum switching capacity	1500 VA
<b>Digital outputs</b>	
Number of outputs	4
Output voltage	5 V ... 30 V
Output current	0.5 A (total current for all outputs; internally supplied) 0.6 A (per output; externally supplied)
<b>RS-485 interface</b>	
Designation	RS-485 interface, 2-wire + GND
Connection method	Screw connection
Transmission mode	8, N, 1
Transmission speed	9.6 kbps (standard) 9.6 kbps ... 19.2 kbps (adjustable)
<b>Protocols</b>	Modbus/RTU (slave)
<b>General data</b>	
Supply voltage range	100 V AC ... 240 V AC (nominal voltage range)
Power consumption	< 1 W (no-load)
Frequency range	50 Hz ... 60 Hz
Degree of protection	IP20
Ambient temperature range	-35 °C ... 70 °C (operation)
Dimensions W / H / D	124 / 128 / 64 mm
Conformance / approvals	
Conformance	CE-compliant

**Ordering data**

Type	Order No.	Pcs. / Pkt.
EV-CC-AC1-M3-CBC-SER-HS	1622452	1

## Components for E-Mobility

### EV CC Electrical Vehicle Charge Control

#### EV-CC-AC1-M3-CC-SER-...

- AC charging according to IEC 61851-1, Mode 3
- Comprehensive configuration options
- Adjustable amperage
- Optimized for charging stations with vehicle connector (case C)
- RS-485 interface (Modbus/RTU slave)
- PCB version and DIN rail device

new

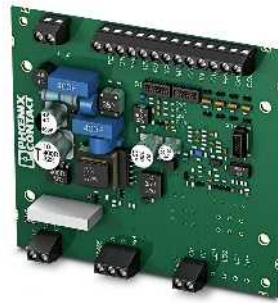

Charging controller on PCB

new

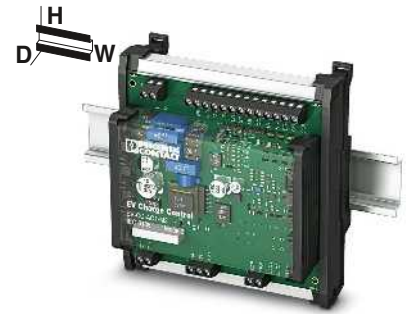

DIN rail housing charging controller

<b>Input</b>	
Description of the input	Digital input
Nominal input voltage $U_N$	12 V
Input current	$\leq 1$ mA (12 V)
Input voltage level digital I/O	0 V ... 3 V (Off) 9 V ... 15 V (On)
<b>Switching output</b>	
Charging contactor output	Relay output
Maximum switching voltage	250 V AC (external supply)
Max. switching current	6 A (external supply)
Maximum switching capacity	1500 VA
<b>Digital outputs</b>	
Number of outputs	4
Output voltage	5 V ... 30 V
Output current	0.5 A (total current for all outputs; internally supplied) 0.6 A (per output; externally supplied)
<b>RS-485 interface</b>	
Designation	RS-485 interface, 2-wire + GND
Connection method	Screw connection
Transmission mode	8, N, 1
Transmission speed	9.6 kbps (standard) 9.6 kbps ... 19.2 kbps (adjustable)
<b>Protocols</b>	
General data	Modbus/RTU (slave)
Supply voltage range	100 V AC ... 240 V AC (nominal voltage range)
Power consumption	< 1 W (no-load)
Frequency range	50 Hz ... 60 Hz
Degree of protection	IP00
Ambient temperature range	-35 °C ... 70 °C (operation)
Dimensions W / H / D	120 / 108 / 20 mm
<b>Conformance / approvals</b>	
Conformance	CE-compliant

Housing width 120 mm			
Technical data			
<b>Input</b>			
Description of the input	Digital input		
Nominal input voltage $U_N$	12 V		
Input current	$\leq 1$ mA (12 V)		
Input voltage level digital I/O	0 V ... 3 V (Off) 9 V ... 15 V (On)		
<b>Switching output</b>			
Charging contactor output	Relay output		
Maximum switching voltage	250 V AC (external supply)		
Max. switching current	6 A (external supply)		
Maximum switching capacity	1500 VA		
<b>Digital outputs</b>			
Number of outputs	4		
Output voltage	5 V ... 30 V		
Output current	0.5 A (total current for all outputs; internally supplied) 0.6 A (per output; externally supplied)		
<b>RS-485 interface</b>			
Designation	RS-485 interface, 2-wire + GND		
Connection method	Screw connection		
Transmission mode	8, N, 1		
Transmission speed	9.6 kbps (standard) 9.6 kbps ... 19.2 kbps (adjustable)		
<b>Protocols</b>			
General data	Modbus/RTU (slave)		
Supply voltage range	100 V AC ... 240 V AC (nominal voltage range)		
Power consumption	< 1 W (no-load)		
Frequency range	50 Hz ... 60 Hz		
Degree of protection	IP00		
Ambient temperature range	-35 °C ... 70 °C (operation)		
Dimensions W / H / D	120 / 108 / 20 mm		
<b>Conformance / approvals</b>			
Conformance	CE-compliant		
Ordering data			
<b>Description</b>	<b>Type</b>	<b>Order No.</b>	<b>Pcs. / Pkt.</b>
Charging controller for case C	EV-CC-AC1-M3-CC-SER-PCB	1622460	1

Housing width 124 mm			
Technical data			
<b>Input</b>			
Description of the input	Digital input		
Nominal input voltage $U_N$	12 V		
Input current	$\leq 1$ mA (12 V)		
Input voltage level digital I/O	0 V ... 3 V (Off) 9 V ... 15 V (On)		
<b>Switching output</b>			
Charging contactor output	Relay output		
Maximum switching voltage	250 V AC (external supply)		
Max. switching current	6 A (external supply)		
Maximum switching capacity	1500 VA		
<b>Digital outputs</b>			
Number of outputs	4		
Output voltage	5 V ... 30 V		
Output current	0.5 A (total current for all outputs; internally supplied) 0.6 A (per output; externally supplied)		
<b>RS-485 interface</b>			
Designation	RS-485 interface, 2-wire + GND		
Connection method	Screw connection		
Transmission mode	8, N, 1		
Transmission speed	9.6 kbps (standard) 9.6 kbps ... 19.2 kbps (adjustable)		
<b>Protocols</b>			
General data	Modbus/RTU (slave)		
Supply voltage range	100 V AC ... 240 V AC (nominal voltage range)		
Power consumption	< 1 W (no-load)		
Frequency range	50 Hz ... 60 Hz		
Degree of protection	IP20		
Ambient temperature range	-35 °C ... 70 °C (operation)		
Dimensions W / H / D	124 / 128 / 64 mm		
<b>Conformance / approvals</b>			
Conformance	CE-compliant		
Ordering data			
<b>Description</b>	<b>Type</b>	<b>Order No.</b>	<b>Pcs. / Pkt.</b>
Charging controller for case C	EV-CC-AC1-M3-CC-SER-HS	1622459	1

## EV RCM residual current monitoring

## EV RCM...

- Universal residual current monitoring for AC and DC residual current detection
- Operate values DC 6 mA and AC 30 mA
- Protection of higher-level safety equipment, such as type A residual current circuit breakers, against DC residual currents
- Single or two-channel version



RCM module for one charging point

new



RCM module for two separate charging points

new

Housing width 36 mm

## Technical data

Input	
Measuring transducer input	plug-in; front
Switching output	
Alarm relay K1	$I_{\Delta n}$ DC1
Maximum switching voltage	250 V
Max. switching current	5 A
Method of operation	Quiescent current
Contact type	1 N/O contact
Switching output	
Alarm relay K2	$I_{\Delta n}$ AC2
Maximum switching voltage	250 V
Max. switching current	5 A
Method of operation	Quiescent current
Contact type	1 N/O contact
Residual current measuring range	
Rated frequency	≤ 2000 Hz
Number of channels	1
Measuring range	± 300 mA (peak)
Current measuring range	50 A (45 Hz ... 50 Hz)
Residual current $I_{\Delta n1}$	30 mA
Residual current $I_{\Delta n2}$	6 mA
Load current	32 A
Response time at 1 x $I_{\Delta n}$	< 180 ms
Response time at 2 x $I_{\Delta n}$	< 70 ms
Response time at 5 x $I_{\Delta n}$	< 20 ms
Response time at $I_n$	< 500 ms
Measuring current transducer	
Cable feed-through diameter	15 mm
Supply	via RCM module
Connection method	Connector
General data	
Supply voltage range	100 V AC ... 240 V AC (nominal voltage range)
Max. current consumption	22 mA
Frequency range	45 Hz ... 60 Hz
Degree of protection	IP20
Ambient temperature range	-25 °C ... 80 °C (operation)
Reload function	3 switch-on attempts at intervals of 15 min.
Operating elements	Test/reset button; 2 status LEDs
Dimensions W / H / D	36 / 90 / 70.5 mm
Conformance / approvals	
Conformance	CE-compliant
Climatic class	According to IEC 60271-1/-2/-3

Housing width 36 mm

## Technical data

Input	
Measuring transducer input	plug-in; front
Switching output	
Alarm relay K1	$I_{\Delta n}$ AC1 and $I_{\Delta n}$ DC1
Maximum switching voltage	250 V
Max. switching current	5 A
Method of operation	Quiescent current
Contact type	1 N/O contact
Switching output	
Alarm relay K2	$I_{\Delta n}$ AC2 and $I_{\Delta n}$ DC2
Maximum switching voltage	250 V
Max. switching current	5 A
Method of operation	Quiescent current
Contact type	1 N/O contact
Residual current measuring range	
Rated frequency	≤ 2000 Hz
Number of channels	2
Measuring range	± 300 mA (peak)
Current measuring range	50 A (45 Hz ... 50 Hz)
Residual current $I_{\Delta n1}$	30 mA
Residual current $I_{\Delta n2}$	6 mA
Load current	32 A
Response time at 1 x $I_{\Delta n}$	< 180 ms
Response time at 2 x $I_{\Delta n}$	< 70 ms
Response time at 5 x $I_{\Delta n}$	< 20 ms
Response time at $I_n$	< 500 ms
Measuring current transducer	
Cable feed-through diameter	15 mm
Supply	via RCM module
Connection method	Connector
General data	
Supply voltage range	100 V AC ... 240 V AC (nominal voltage range)
Max. current consumption	22 mA
Frequency range	45 Hz ... 60 Hz
Degree of protection	IP20
Ambient temperature range	-25 °C ... 80 °C (operation)
Reload function	3 switch-on attempts at intervals of 15 min.
Operating elements	Test/reset button; 2 status LEDs
Dimensions W / H / D	36 / 90 / 70.5 mm
Conformance / approvals	
Conformance	CE-compliant
Climatic class	According to IEC 60271-1/-2/-3

## Ordering data

Description	Type	Order No.	Pcs. / Pkt.
EV RCM 1-channel	EV-RCM-C1-AC30-DC6	1622450	1
EV RCM 2-channel			

## Ordering data

Type	Order No.	Pcs. / Pkt.
EV-RCM-C2-AC30-DC6	1622451	1



### For high system availability

EMD monitoring relays can be used to detect deviations in important system parameters at an early stage. These can be indicated or system parts can be shut down selectively. EMD monitoring relays ensure error-free and cost-effective operation of your system. They are an inexpensive solution for numerous monitoring functions.

- Surge voltage and undervoltage
- Overcurrent and undercurrent
- Phase failure, phase sequence, and phase asymmetry
- Power factor and real power
- Motor winding temperature
- Levels

For system monitoring, choose from two product ranges: compact or multifunctional monitoring relays.

### Perfect timing

ETD timer relays ensure optimum time sequences.

The modules are the cost-effective alternative to a PLC: with easy configuration and fast wiring.

Choose from two product ranges for your ideal time control application:

- Ultra-narrow timer relays each with one time range and one function
- Multifunctional timer relays with selectable time ranges and functions

### Professionally packaged components

Function modules with professional housing and connection technology can be used to integrate electronic components in your system. They can be used to perform a variety of tasks:

- Diode modules provide protection against polarity reversal. In addition, they decouple messages in fault reporting systems.
- Lamp testing modules decouple signals in isolation in the field of fault reporting technology.
- Display modules simplify troubleshooting and provide help for monitoring processes.





### Compact monitoring relays

- Ideal for simple monitoring tasks – from series production to building installation.
- Compact installation housing
  - Quick and tool-free wiring with push-in technology
  - Parameters can be adjusted easily using rotary switches
  - Clear diagnostics, thanks to color status LED



### Multifunctional monitoring relays

- Parameters can be adjusted easily using rotary switches
- Fast error detection, thanks to fine tuning and short response times
- Worldwide use, thanks to wide range power supply unit or plug-in transformer
- Space saving – with two PDT outputs in 22.5 mm wide housing
- Electrically isolated measuring and supply circuits
- Clear diagnostics, thanks to color status LEDs



### Ultra-narrow timer relays

- The space-saving and inexpensive solution for simple time control applications.
- Each with one time range and one function
  - Overall width of just 6.2 mm - saves up to 70% space compared to conventional timer relays
  - Precise time setting using the illuminated thumbwheel
  - Fast wiring through the use of jumpers



### Multifunctional timer relays

- For universal use thanks to wide range of functions.
- Just three versions for all conventional time control applications.
  - Two floating PDT outputs on an overall width of just 22.5 mm
  - Supply voltage via wide range power supply unit
  - Optimum setting of times ranging from milliseconds to several days



### Function modules

- Function modules transform components such as diodes into a shock-proof and dust-proof electronics module.
- Easy installation, thanks to electronics housing with IP20 protection that can be installed in a control cabinet
  - Fast mounting on DIN rails, thanks to the foot catch
  - User-friendly wiring, thanks to practical connection technology



# Monitoring

## Monitoring and diagnostics

### Monitoring relays

#### Single-phase current monitoring

- The **EMD-BL-C-10** monitors AC currents from 0 ... 10 A.
- Adjustable response delay
  - 0 ... 5 A or 0 ... 10 A measuring range
  - Adjustable via rotary switch on the front

#### Single-phase voltage monitoring

- The **EMD-BL-V-230** monitors DC and AC voltages.
- 24 V AC/DC or 230 V AC
  - Separately adjustable response delay
  - Adjustable monitoring range
  - Adjustable via potentiometer on the front



**Current monitoring, 1-phase**  
Overcurrent, undercurrent, window



**Voltage monitoring, 1-phase**  
Undervoltage, window

Housing width 17.5 mm

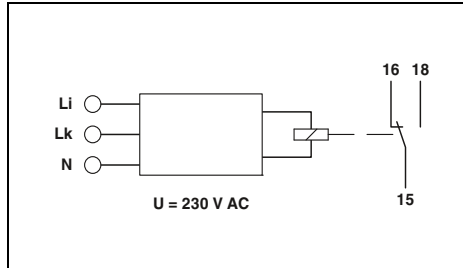

#### Technical data

Overcurrent, undercurrent, window

Housing width 17.5 mm

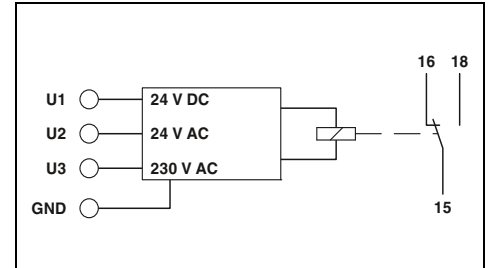

#### Technical data

Undervoltage, window

0 V DC ... 24 V DC (connection terminal blocks: U1 and GND)  
0 V AC ... 24 V AC (connection terminal blocks: U2 and GND)  
0 V AC ... 230 V AC (connection terminal blocks: U3 and GND)

Functions	
Input	
Input ranges	
Input resistance	3 mΩ
Min. setting range	5 % ... 95 % (of I <sub>N</sub> )
Max. setting range	10 % ... 100 % (of I <sub>N</sub> )
Setting range for response delay	0.1 s ... 10 s
Basic accuracy	± 5 % (of the nominal value)
Setting accuracy	± 5 % (of the nominal value)
Repeat accuracy	± 2 %
Relay output	
Contact type	1 floating PDT
Switching capacity	1250 VA (5 A/250 V AC)
Electrical service life	1 x 10 <sup>5</sup> cycles
Mechanical service life	15 x 10 <sup>6</sup> cycles
Output fuse	5 A (fast-blow)
General data	
Supply voltage	230 V AC ±15 %
Nominal power consumption	5 VA (0.8 W)
Degree of protection	IP40 (housing) / IP20 (connection terminal blocks)
Ambient temperature range	-25 °C ... 55 °C
Dimensions W / H / D	17.5 / 88 / 65.5 mm
Connection data solid / stranded / AWG	0.14 ... 2.5 mm <sup>2</sup> / 0.14 ... 2.5 mm <sup>2</sup> / 26 - 14
Conformance / approvals	
Conformance	CE-compliant
UL, USA / Canada	UL/C-UL listed UL 508

0 A ... 5 A AC  
0 A ... 10 A AC  
Configurable via rotary switch

1 floating PDT  
1250 VA (5 A/250 V AC)  
1 x 10<sup>5</sup> cycles  
15 x 10<sup>6</sup> cycles  
5 A (fast-blow)

230 V AC ±15 %  
5 VA (0.8 W)

IP40 (housing) / IP20 (connection terminal blocks)

-25 °C ... 55 °C  
17.5 / 88 / 65.5 mm  
0.14 ... 2.5 mm<sup>2</sup> / 0.14 ... 2.5 mm<sup>2</sup> / 26 - 14

CE-compliant  
UL/C-UL listed UL 508

#### Ordering data

Description	
<b>Compact monitoring relay</b> with push-in connection	
<b>Compact monitoring relay</b> with screw connection	

Type	Order No.	Pcs. / Pkt.
EMD-BL-C-10-PT	2903522	1
EMD-BL-C-10	2903521	1

-

75 % ... 115 % (of U<sub>N</sub>)  
80 % ... 120 % (of U<sub>N</sub>)  
0.1 s ... 10 s  
± 5 % (of scale end value)  
± 5 % (of scale end value)  
± 2 %

1 floating PDT  
1250 VA (5 A/250 V AC)  
1 x 10<sup>5</sup> cycles  
15 x 10<sup>6</sup> cycles  
5 A (fast-blow)

-25 % ... +20 % (= measuring voltage)  
10 VA (at 230 V AC (0.6 W))  
1.3 VA (at 24 V AC (0.8 W))  
0.6 W (at 24 V DC)

IP40 (housing) / IP20 (connection terminal blocks)

-25 °C ... 55 °C  
17.5 / 88 / 65.5 mm  
0.14 ... 2.5 mm<sup>2</sup> / 0.14 ... 2.5 mm<sup>2</sup> / 26 - 14

CE-compliant  
UL/C-UL listed UL 508

#### Ordering data

Type	Order No.	Pcs. / Pkt.
EMD-BL-V-230-PT	2903524	1
EMD-BL-V-230	2903523	1

Monitoring relays

Three-phase voltage monitoring

- The **EMD-BL-3V-400** monitors three-phase AC voltages.
- 3~ 400 V AC/230 V AC ±30%
- Separately adjustable response delay
- Adjustable monitoring range
- Adjustable via potentiometer on the front
- Supply from the measuring circuit

Phase monitoring

- The **EMD-BL-PH-400** monitors three-phase AC voltages.
- 3~ 208 ... 480 V AC/120 ... 277 V AC
- Adjustable response delay
- Adjustable asymmetry: 5 ... 25%/OFF
- Adjustable via potentiometer on the front
- Supply from the measuring circuit



Voltage monitoring, 3-phase  
Window, phase sequence



Phase monitoring  
Phase sequence, phase failure, asymmetry

Housing width 17.5 mm

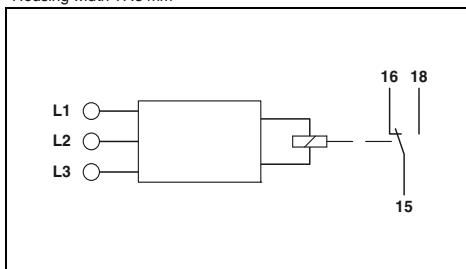

Housing width 17.5 mm

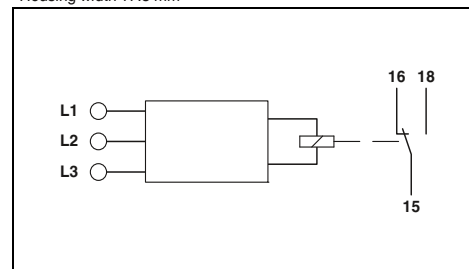

Functions

Input

Monitoring range	280 V AC ... 519 V AC
Input ranges	3~ 400/230 V
Input resistance	-
Min. setting range	70 % ... 120 % (of U <sub>N</sub> )
Max. setting range	80 % ... 130 % (of U <sub>N</sub> )
Setting range for response delay	0.1 s ... 10 s
Asymmetry	-
Basic accuracy	≤ 5 % (of the nominal value)
Setting accuracy	± 5 % (of scale end value)
Repeat accuracy	≤ 2 %

Degree of protection

Ambient temperature range	-25 °C ... 55 °C
Dimensions W / H / D	17.5 / 88 / 65.5 mm
Connection data solid / stranded / AWG	0.14 ... 2.5 mm <sup>2</sup> / 0.14 ... 2.5 mm <sup>2</sup> / 26 - 14
Conformance / approvals	CE-compliant
Conformance	UL, USA / Canada

Technical data

Window, phase sequence

Monitoring range	187 V AC ... 519 V AC
Input ranges	3~ 208 ... 480 V/120 ... 277 V
Input resistance	-
Min. setting range	-
Max. setting range	-
Setting range for response delay	0.1 s ... 10 s
Asymmetry	5 % ... 25% / OFF
Basic accuracy	≤ 5 % (of scale end value)
Setting accuracy	± 5 % (of scale end value)
Repeat accuracy	≤ 2 %

Degree of protection

Ambient temperature range	-25 °C ... 55 °C
Dimensions W / H / D	17.5 / 88 / 65.5 mm
Connection data solid / stranded / AWG	0.14 ... 2.5 mm <sup>2</sup> / 0.14 ... 2.5 mm <sup>2</sup> / 26 - 14
Conformance / approvals	CE-compliant
Conformance	UL/C-UL listed UL 508

Technical data

Phase sequence, phase failure, asymmetry

Monitoring range	187 V AC ... 519 V AC
Input ranges	3~ 208 ... 480 V/120 ... 277 V
Input resistance	-
Min. setting range	-
Max. setting range	-
Setting range for response delay	0.1 s ... 10 s
Asymmetry	5 % ... 25% / OFF
Basic accuracy	≤ 5 % (of scale end value)
Setting accuracy	± 5 % (of scale end value)
Repeat accuracy	≤ 2 %

Degree of protection

Ambient temperature range	-25 °C ... 55 °C
Dimensions W / H / D	17.5 / 88 / 65.5 mm
Connection data solid / stranded / AWG	0.14 ... 2.5 mm <sup>2</sup> / 0.14 ... 2.5 mm <sup>2</sup> / 26 - 14
Conformance / approvals	CE-compliant
Conformance	UL/C-UL listed UL 508

Description

<b>Compact monitoring relay with push-in connection</b>
<b>Compact monitoring relay with screw connection</b>

Ordering data

Type	Order No.	Pcs. / Pkt.
EMD-BL-3V-400-PT	2903526	1
EMD-BL-3V-400	2903525	1

Ordering data

Type	Order No.	Pcs. / Pkt.
EMD-BL-PH-480-PT	2903528	1
EMD-BL-PH-480	2903527	1

# Monitoring

## Monitoring and diagnostics

### Monitoring relays

#### Single-phase current monitoring

**EMD-...C...** monitoring relays monitor DC and AC currents within the range 0 ... 10 A.

- Separately adjustable startup and release delays
- Variable supply voltage range
- Adjustable via potentiometer on front



Overcurrent and undercurrent monitoring



Overcurrent or undercurrent monitoring



Housing width 22.5 mm

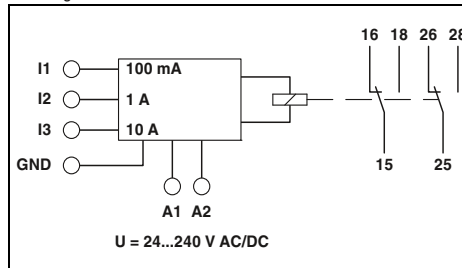

#### Technical data

Functions	Overcurrent, undercurrent, window, error memory
Input	
Input ranges	0 mA ... 100 mA AC/DC (connection terminal blocks: I1 and GND) 0 A ... 1 A AC/DC (connection terminal blocks: I2 and GND) 0 A ... 10 A AC/DC (connection terminal blocks: I3 and GND)
Input resistance	470 mΩ (at I <sub>N</sub> = 100 mA); 47 mΩ (at I <sub>N</sub> = 1 A); 5 mΩ (at I <sub>N</sub> = 10 A)
Min. setting range	5 % ... 95 % (of I <sub>N</sub> )
Max. setting range	10 % ... 100 % (of I <sub>N</sub> )
Setting range for response delay	0.1 s ... 10 s
Setting range for starting delay	0 s ... 10 s
Basic accuracy	± 5 % (of scale end value)
Setting accuracy	≤ 5 % (of scale end value)
Repeat accuracy	≤ 2 %
Relay output	2 floating PDT contacts
Contact type	750 VA (3 A/250 V AC, module aligned, ≤ 5 mm spacing) 1250 VA (5 A/250 V AC, module not aligned, ≥ 5 mm spacing)
Switching capacity	
Electrical service life	2 x 10 <sup>5</sup> cycles at ohmic load, 1000 VA
Mechanical service life	Approx. 2 x 10 <sup>7</sup> cycles
Output fuse	5 A (fast-blow)
General data	
Supply voltage	4.5 VA (1.5 W)
Nominal power consumption	IP40 (housing) / IP20 (connection terminal blocks)
Degree of protection	
Ambient temperature range	-25 °C ... 55 °C
Dimensions W / H / D	22.5 / 90 / 113 mm
Screw connection solid / stranded / AWG	0.5 ... 2.5 mm <sup>2</sup> / 0.25 ... 2.5 mm <sup>2</sup> / 20 - 14
EMC note	Class A product, see page 625
Conformance / approvals	
Conformance	CE-compliant
UL, USA / Canada	UL/C-UL listed UL 508

#### Ordering data

Type	Order No.	Pcs. / Pkt.
EMD-FL-C-10	2866022	1



Housing width 22.5 mm

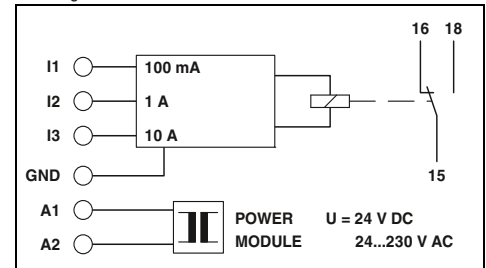

#### Technical data

EMD-SL-C-OC-10	EMD-SL-C-UC-10
Overcurrent	Undercurrent
0 mA ... 100 mA AC/DC (connection terminal blocks: I1 and GND)	0 A ... 1 A AC/DC (connection terminal blocks: I2 and GND)
0 A ... 10 A AC/DC (connection terminal blocks: I3 and GND)	0 A ... 10 A AC/DC (connection terminal blocks: I3 and GND)
470 mΩ (at I <sub>N</sub> = 100 mA); 47 mΩ (at I <sub>N</sub> = 1 A); 5 mΩ (at I <sub>N</sub> = 10 A)	470 mΩ (at I <sub>N</sub> = 100 mA); 47 mΩ (at I <sub>N</sub> = 1 A); 5 mΩ (at I <sub>N</sub> = 10 A)
5 % ... 95 % (of I <sub>N</sub> )	5 % ... 95 % (of I <sub>N</sub> )
10 % ... 100 % (of I <sub>N</sub> )	10 % ... 100 % (of I <sub>N</sub> )
0.2 s ... 10 s	0.2 s ... 10 s
-	-
± 5 % (of scale end value)	± 5 % (of scale end value)
≤ 5 % (of scale end value)	≤ 5 % (of scale end value)
≤ 2 %	≤ 2 %
1 floating PDT	1 floating PDT
750 VA (3 A/250 V AC, module aligned, ≤ 5 mm spacing)	750 VA (3 A/250 V AC, module aligned, ≤ 5 mm spacing)
1250 VA (5 A/250 V AC, module not aligned, ≥ 5 mm spacing)	1250 VA (5 A/250 V AC, module not aligned, ≥ 5 mm spacing)
2 x 10 <sup>5</sup> cycles at ohmic load, 1000 VA	2 x 10 <sup>5</sup> cycles at ohmic load, 1000 VA
Approx. 2 x 10 <sup>7</sup> cycles	Approx. 2 x 10 <sup>7</sup> cycles
5 A (fast-blow)	5 A (fast-blow)
2 VA (1.5 W)	2 VA (1.5 W)
IP40 (housing) / IP20 (connection terminal blocks)	IP40 (housing) / IP20 (connection terminal blocks)
-25 °C ... 55 °C	-25 °C ... 55 °C
22.5 / 90 / 113 mm	22.5 / 90 / 113 mm
0.5 ... 2.5 mm <sup>2</sup> / 0.25 ... 2.5 mm <sup>2</sup> / 20 - 14	0.5 ... 2.5 mm <sup>2</sup> / 0.25 ... 2.5 mm <sup>2</sup> / 20 - 14
CE-compliant	CE-compliant
UL/C-UL listed UL 508	UL/C-UL listed UL 508

#### Ordering data

Type	Order No.	Pcs. / Pkt.
EMD-SL-C-OC-10	2866019	1
EMD-SL-C-UC-10	2867937	1
EMD-SL-PS- 24DC	2885359	1
EMD-SL-PS- 24AC	2866103	1
EMD-SL-PS-110AC	2866116	1
EMD-SL-PS-120AC	2885731	1
EMD-SL-PS-230AC	2866129	1

Functions	
Input	
Input ranges	
Input resistance	
Min. setting range	
Max. setting range	
Setting range for response delay	
Setting range for starting delay	
Basic accuracy	
Setting accuracy	
Repeat accuracy	
Relay output	
Contact type	
Switching capacity	
Electrical service life	
Mechanical service life	
Output fuse	
General data	
Supply voltage	
Nominal power consumption	
Degree of protection	
Ambient temperature range	
Dimensions W / H / D	
Screw connection solid / stranded / AWG	
EMC note	
Conformance / approvals	
Conformance	
UL, USA / Canada	

Description	<b>Electronic monitoring relay</b>
<b>Power module</b> , plug-in, please order at the same time!	
Supply voltage 20 ... 30 V DC	
Supply voltage 20.2 ... 26.4 V AC	
Supply voltage 88 ... 121 V AC	
Supply voltage 108 ... 132 V AC	
Supply voltage 195 ... 264 V AC	

Monitoring relays

Single-phase voltage monitoring

EMD-...V... monitoring relays monitor DC and AC voltages within the range 0 ... 300 V.

- Separately adjustable startup and release delays
- Variable supply voltage range
- Adjustable via potentiometer on front

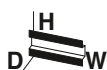

Undervoltage and overvoltage monitoring



Undervoltage monitoring

FRAC Housing width 22.5 mm

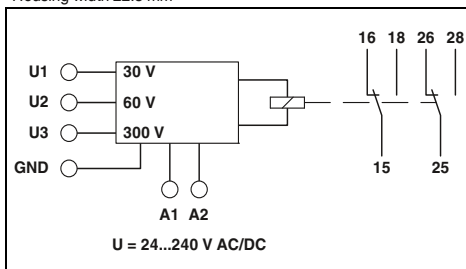

Technical data

Undervoltage, overvoltage, window, error memory

FRAC Housing width 22.5 mm

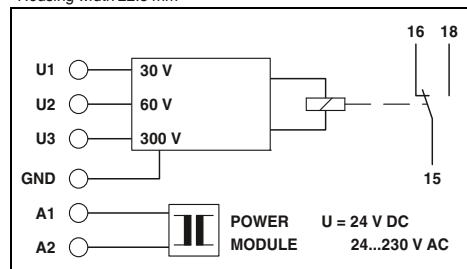

Technical data

Undervoltage

Functions

Input

Input ranges

Input resistance

Min. setting range

Max. setting range

Setting range for response delay

Setting range for starting delay

Basic accuracy

Setting accuracy

Repeat accuracy

Relay output

Contact type

Switching capacity

Electrical service life

Mechanical service life

Output fuse

General data

Supply voltage

Nominal power consumption

Degree of protection

Ambient temperature range

Dimensions W / H / D

Screw connection solid / stranded / AWG

EMC note

Conformance / approvals

Conformance

UL, USA / Canada

0 V ... 30 V AC/DC (connection terminal blocks: U1 and GND)  
0 V ... 60 V AC/DC (connection terminal blocks: U2 and GND)  
0 V ... 300 V AC/DC (connection terminal blocks: U3 and GND)  
47 kΩ (connection terminal blocks: U1 and GND)  
100 kΩ (connection terminal blocks: U2 and GND)  
470 kΩ (connection terminal blocks: U3 and GND)  
5 % ... 95 % (of U<sub>N</sub>)  
10 % ... 100 % (of U<sub>N</sub>)  
0.1 s ... 10 s  
0 s ... 10 s  
± 5 % (of scale end value)  
≤ 5 % (of scale end value)  
≤ 2 %

2 floating PDT contacts  
750 VA (3 A/250 V AC, module aligned, ≤ 5 mm spacing)  
1250 VA (5 A/250 V AC, module not aligned, ≥ 5 mm spacing)

2 x 10<sup>5</sup> cycles at ohmic load, 1000 VA

Approx. 2 x 10<sup>7</sup> cycles  
5 A (fast-blow)

4.5 VA (1.5 W)  
IP40 (housing) / IP20 (connection terminal blocks)

-25 °C ... 55 °C  
22.5 / 90 / 113 mm  
0.5 ... 2.5 mm<sup>2</sup> / 0.25 ... 2.5 mm<sup>2</sup> / 20 - 14  
Class A product, see page 625

CE-compliant  
UL/C-UL listed UL 508

Ordering data

Type Order No. Pcs. / Pkt.

EMD-FL-V-300 2866048 1

0 V ... 30 V AC/DC (connection terminal blocks: U1 and GND)  
0 V ... 60 V AC/DC (connection terminal blocks: U2 and GND)  
0 V ... 300 V AC/DC (connection terminal blocks: U3 and GND)  
47 kΩ (connection terminal blocks: U1 and GND)  
100 kΩ (connection terminal blocks: U2 and GND)  
470 kΩ (connection terminal blocks: U3 and GND)  
5 % ... 95 % (of U<sub>N</sub>)  
10 % ... 100 % (of U<sub>N</sub>)  
0.2 s ... 10 s  
-  
± 5 % (of scale end value)  
≤ 5 % (of scale end value)  
≤ 2 %

1 floating PDT  
750 VA (3 A/250 V AC, module aligned, ≤ 5 mm spacing)  
1250 VA (5 A/250 V AC, module not aligned, ≥ 5 mm spacing)

2 x 10<sup>5</sup> cycles at ohmic load, 1000 VA

Approx. 2 x 10<sup>7</sup> cycles  
5 A (fast-blow)

2 VA (1.5 W)  
IP40 (housing) / IP20 (connection terminal blocks)

-25 °C ... 55 °C  
22.5 / 90 / 113 mm  
0.5 ... 2.5 mm<sup>2</sup> / 0.25 ... 2.5 mm<sup>2</sup> / 20 - 14

CE-compliant  
UL/C-UL listed UL 508

Ordering data

Type Order No. Pcs. / Pkt.

EMD-SL-V-UV-300 2866035 1

EMD-SL-PS- 24DC 2885359 1

EMD-SL-PS- 24AC 2866103 1

EMD-SL-PS-110AC 2866116 1

EMD-SL-PS-120AC 2885731 1

EMD-SL-PS-230AC 2866129 1

Description

Electronic monitoring relay

Power module, plug-in, please order at the same time!

Supply voltage 20 ... 30 V DC

Supply voltage 20.2 ... 26.4 V AC

Supply voltage 88 ... 121 V AC

Supply voltage 108 ... 132 V AC

Supply voltage 195 ... 264 V AC

# Monitoring

## Monitoring and diagnostics

### Monitoring relays

#### Three-phase voltage monitoring

**EMD-...-3V...** monitoring relays monitor three-phase AC voltages of 160 ... 897 V AC (depending on the device concerned).

- Adjustable response delay
- Variable supply voltage range
- Adjustable via potentiometer on front
- Adjustable asymmetry



**Undervoltage and phase monitoring,  
400 V or 230 V**



**Undervoltage and phase monitoring,  
500 V or 690 V**

Housing width 22.5 mm

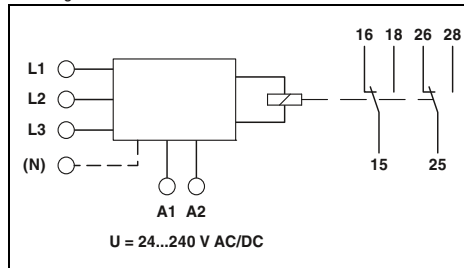

Housing width 45 mm

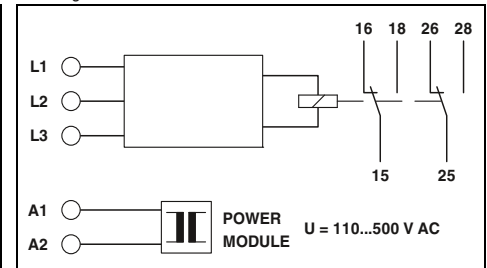

#### Technical data

Functions	EMD-FL-3V-400 Undervoltage, window, asymmetry, phase sequence, phase failure	EMD-FL-3V-230 Undervoltage, window, asymmetry, phase sequence, phase failure
Input	280 V AC ... 520 V AC 3 N ~ 400/230 V 1 MΩ	161 V AC ... 299 V AC 3 N ~ 230/132 V 470 kΩ
Monitoring range	-30 % ... 20 % (of $U_N$ )	-20 % ... 30 % (of $U_N$ )
Input ranges	0.1 s ... 10 s	5 % ... 25% / OFF
Input resistance	± 5 % (of scale end value)	± 5 % (of scale end value)
Min. setting range	≤ 5 % (of scale end value)	≤ 2 %
Max. setting range	0.1 s ... 10 s	5 % ... 25% / OFF
Setting range for response delay	2 floating PDT contacts	2 floating PDT contacts
Asymmetry	750 VA (3 A/250 V AC, module aligned, ≤ 5 mm spacing)	750 VA (3 A/250 V AC, module aligned, ≤ 5 mm spacing)
Basic accuracy	1250 VA (5 A/250 V AC, module not aligned, ≥ 5 mm spacing)	1250 VA (5 A/250 V AC, module not aligned, ≥ 5 mm spacing)
Setting accuracy	Electrical service life	Electrical service life
Repeat accuracy	2 × 10 <sup>5</sup> cycles at ohmic load, 1000 VA	2 × 10 <sup>5</sup> cycles at ohmic load, 1000 VA
Relay output	Mechanical service life	Mechanical service life
Contact type	Approx. 2 × 10 <sup>7</sup> cycles	Approx. 2 × 10 <sup>7</sup> cycles
Switching capacity	5 A (fast-blow)	5 A (fast-blow)
	General data	General data
	Supply voltage	Supply voltage
	Nominal power consumption	Nominal power consumption
	Degree of protection	Degree of protection
	Ambient temperature range	Ambient temperature range
	Dimensions W / H / D	Dimensions W / H / D
	Screw connection solid / stranded / AWG	Screw connection solid / stranded / AWG
	EMC note	EMC note
	Conformance / approvals	Conformance / approvals
	Conformance	Conformance
	UL, USA / Canada	UL, USA / Canada

#### Technical data

Functions	EMD-FL-3V-690 Undervoltage, window, asymmetry, phase sequence, phase failure	EMD-FL-3V-500 Undervoltage, window, asymmetry, phase sequence, phase failure
Input	483 V AC ... 897 V AC 3 ~ 690 V 1 MΩ	350 V AC ... 650 V AC 3 ~ 500 V 1 MΩ
Monitoring range	-30 % ... 20 % (of $U_N$ )	-20 % ... 30 % (of $U_N$ )
Input ranges	0.1 s ... 10 s	5 % ... 25% / OFF
Input resistance	± 5 % (of scale end value)	± 5 % (of scale end value)
Min. setting range	≤ 5 % (of scale end value)	≤ 2 %
Max. setting range	0.1 s ... 10 s	5 % ... 25% / OFF
Setting range for response delay	2 floating PDT contacts	2 floating PDT contacts
Asymmetry	750 VA (3 A/250 V AC, module aligned, ≤ 5 mm spacing)	750 VA (3 A/250 V AC, module aligned, ≤ 5 mm spacing)
Basic accuracy	1250 VA (5 A/250 V AC, module not aligned, ≥ 5 mm spacing)	1250 VA (5 A/250 V AC, module not aligned, ≥ 5 mm spacing)
Setting accuracy	Electrical service life	Electrical service life
Repeat accuracy	2 × 10 <sup>5</sup> cycles at ohmic load, 1000 VA	2 × 10 <sup>5</sup> cycles at ohmic load, 1000 VA
Relay output	Mechanical service life	Mechanical service life
Contact type	Approx. 2 × 10 <sup>7</sup> cycles	Approx. 2 × 10 <sup>7</sup> cycles
Switching capacity	5 A (fast-blow)	5 A (fast-blow)
	General data	General data
	Supply voltage	Supply voltage
	Nominal power consumption	Nominal power consumption
	Degree of protection	Degree of protection
	Ambient temperature range	Ambient temperature range
	Dimensions W / H / D	Dimensions W / H / D
	Screw connection solid / stranded / AWG	Screw connection solid / stranded / AWG
	EMC note	EMC note
	Conformance / approvals	Conformance / approvals
	Conformance	Conformance
	UL, USA / Canada	UL, USA / Canada

#### Ordering data

Description	Type	Order No.	Pcs. / Pkt.
<b>Electronic monitoring relay</b>	EMD-FL-3V-400	2866064	1
	EMD-FL-3V-230	2885773	1
<b>Power module, plug-in, please order at the same time!</b>			
Supply voltage 20 ... 30 V DC			
Supply voltage 20.2 ... 26.4 V AC			
Supply voltage 88 ... 121 V AC			
Supply voltage 108 ... 132 V AC			
Supply voltage 195 ... 264 V AC			
Supply voltage 323 ... 456 V AC			

#### Ordering data

Description	Type	Order No.	Pcs. / Pkt.
<b>Electronic monitoring relay</b>	EMD-FL-3V-690	2885249	1
	EMD-FL-3V-500	2867979	1
<b>Power module, plug-in, please order at the same time!</b>			
Supply voltage 20 ... 30 V DC			
Supply voltage 20.2 ... 26.4 V AC			
Supply voltage 88 ... 121 V AC			
Supply voltage 108 ... 132 V AC			
Supply voltage 195 ... 264 V AC			
Supply voltage 323 ... 456 V AC			

Description	Type	Order No.	Pcs. / Pkt.
<b>Electronic monitoring relay</b>	EMD-FL-3V-690	2885249	1
	EMD-FL-3V-500	2867979	1
<b>Power module, plug-in, please order at the same time!</b>			
Supply voltage 20 ... 30 V DC			
Supply voltage 20.2 ... 26.4 V AC			
Supply voltage 88 ... 121 V AC			
Supply voltage 108 ... 132 V AC			
Supply voltage 195 ... 264 V AC			
Supply voltage 323 ... 456 V AC			

new



**Undervoltage/overvoltage monitoring, 400 V with/without neutral conductor**



**Phase monitoring, 400 V**



**Phase monitoring, 690 V**

ERIE  
Housing width 22.5 mm

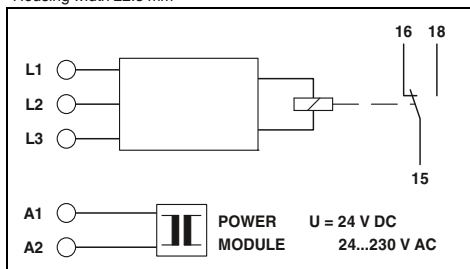

**Technical data**

EMD-SL-3V-400	EMD-SL-3V-400-N
Window, without neutral conductor connection	Window, with neutral conductor connection

280 V AC ... 520 V AC 3 ~ 400 V 1 MΩ -30 % ... 20 % (of U <sub>N</sub> ) -20 % ... 30 % (of U <sub>N</sub> ) 0.2 s ... 10 s	280 V AC ... 520 V AC 3 N ~ 400/230 V 1 MΩ
± 5 % (of scale end value) ≤ 5 % (of scale end value) ≤ 2 %	

1 floating PDT  
750 VA (3 A/250 V AC, module aligned, ≤ 5 mm spacing)  
1250 VA (5 A/250 V AC, module not aligned, ≥ 5 mm spacing)

2 x 10<sup>5</sup> cycles at ohmic load, 1000 VA  
Approx. 2 x 10<sup>7</sup> cycles  
5 A (fast-blow)

2 VA (1.5 W)  
IP40 (housing) / IP20 (connection terminal blocks)  
-25 °C ... 55 °C  
22.5 / 90 / 113 mm  
0.5 ... 2.5 mm<sup>2</sup> / 0.25 ... 2.5 mm<sup>2</sup> / 20 - 14

CE-compliant  
UL/C-UL listed UL 508

**Ordering data**

Type	Order No.	Pcs. / Pkt.
EMD-SL-3V-400	2866051	1
EMD-SL-3V-400-N	2885278	1
EMD-SL-PS- 24DC	2885359	1
EMD-SL-PS- 24AC	2866103	1
EMD-SL-PS-110AC	2866116	1
EMD-SL-PS-120AC	2885731	1
EMD-SL-PS-230AC	2866129	1

ERIE  
Housing width 22.5 mm

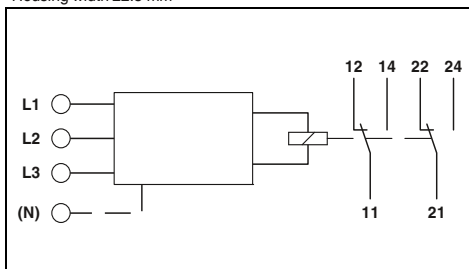

**Technical data**

Phase sequence, phase failure, asymmetry

342 V AC ... 457 V AC 3 N ~ 400/230 V 15 kΩ - - ≤ 350 ms (fixed setting) Fixed, approx. 30 % - -	
--	--

2 floating PDT contacts  
750 VA (3 A/250 V AC, module aligned, ≤ 5 mm spacing)  
1250 VA (5 A/250 V AC, module not aligned, ≥ 5 mm spacing)

2 x 10<sup>5</sup> cycles at ohmic load, 1000 VA  
Approx. 2 x 10<sup>7</sup> cycles  
5 A (fast-blow)

From the measured voltage  
9 VA  
IP40 (housing) / IP20 (connection terminal blocks)  
-25 °C ... 55 °C  
22.5 / 90 / 113 mm  
0.5 ... 2.5 mm<sup>2</sup> / 0.25 ... 2.5 mm<sup>2</sup> / 20 - 14

CE-compliant  
UL/C-UL listed UL 508

**Ordering data**

Type	Order No.	Pcs. / Pkt.
EMD-SL-PH-400	2866077	1

ERIE  
Housing width 22.5 mm

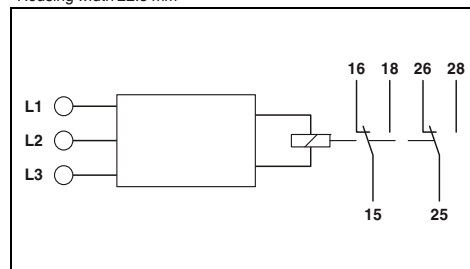

**Technical data**

Undervoltage, phase sequence, phase failure

177 V AC ... 794 V AC 3~ 208 V ... 690 V - - - 0.1 s ... 10 s 25 % ≤ 3 % (of scale end value) ≤ 5 % (of scale end value) ≤ 2 %	
---	--

2 floating PDT contacts  
1250 VA (5 A/250 V AC at +55 °C)  
150 VA (5 A/30 V DC at +55 °C)

2 x 10<sup>5</sup> cycles  
20 x 10<sup>6</sup> cycles  
5 A (fast-blow)

±15 % (= measuring voltage)  
2 VA (1.2 W)  
IP40 (housing) / IP20 (connection terminal blocks)  
-25 °C ... 70 °C (C300)  
22.5 / 90 / 113 mm  
0.5 ... 2.5 mm<sup>2</sup> / 0.5 ... 2.5 mm<sup>2</sup> / 20 - 14

CE-compliant  
UL/C-UL listed UL 508

**Ordering data**

Type	Order No.	Pcs. / Pkt.
EMD-SL-PH-690	2905597	1



# Monitoring

## Monitoring and diagnostics

### Monitoring relays

#### Real power monitoring

The real power in single and 3-phase networks can be monitored with the **EMD-FL-RP-480** real power monitoring relay.

- Monitoring range up to 7.2 kW
- Separately adjustable startup and release delays
- Temperature monitoring of the motor winding
- Variable supply voltage range
- Detection of switched off loads

#### Load monitoring (cos φ)

The **EMD-FL-PF-400** monitoring relay is a cos φ monitor for load monitoring in single or three-phase networks.



Real power monitoring



Load monitoring (cos φ)

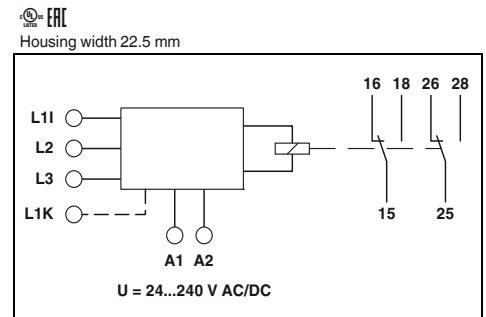
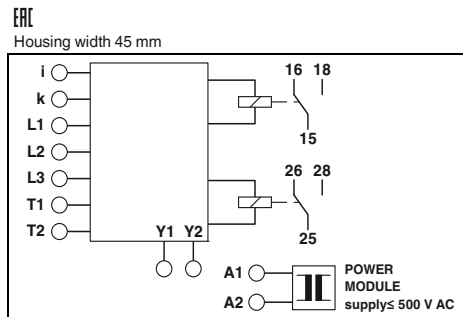

#### Technical data

#### Technical data

#### Functions

Underload, overload, window, winding temperature monitoring

Underload, overload, Window

#### Input

Description of the input  
Measured value  
Measuring ranges  $P_N$

Voltage input  
AC sine (10 Hz ... 400 Hz)  
Can be switched between 0.75 kW, 1.5 kW, 3 kW and 6 kW

-  
AC sine (10 ... 100 Hz)  
-

Nominal input voltage  $U_N$   
Input ranges

480 V (3 N ~ 480/277 V)  
0 V AC ... 480 V AC (1(N) ~, single-phase load)  
0 V AC ... 480 V AC (3(N) ~, 3-phase load)

3 N ~ 415/240 V  
40 V AC ... 415 V AC (1(N) ~, single-phase load)  
40 V AC ... 415 V AC (3(N) ~, 3-phase load)  
0.5 A ... 10 A (connection terminal blocks: L1i and L1k)

Input ranges

0.15 A ... 6 A (range: 0.75 kW and 1.5 kW)  
0.3 A ... 12 A (range: 3 kW and 6 kW)

-

Min. setting range  
Max. setting range  
Switching threshold cos φ

5 % ... 110 % (of  $P_N$ )  
10 % ... 120 % (of  $P_N$ )

0.1 ... 0.99  
0.2 ... 1

#### Relay output

Contact type  
Switching capacity

2 floating PDT contacts  
750 VA (3 A/250 V AC, module aligned, ≤ 5 mm spacing)  
1250 VA (5 A/250 V AC, module not aligned, ≥ 5 mm spacing)

2 floating PDT contacts  
750 VA (3 A/250 V AC, module aligned, ≤ 5 mm spacing)  
1250 VA (5 A/250 V AC, module not aligned, ≥ 5 mm spacing)

Electrical service life

2 x 10<sup>5</sup> cycles at ohmic load, 1000 VA

2 x 10<sup>5</sup> cycles at ohmic load, 1000 VA

Mechanical service life

Approx. 2 x 10<sup>7</sup> cycles  
5 A (fast-blow)

Approx. 2 x 10<sup>7</sup> cycles  
5 A (fast-blow)

#### General data

Supply voltage  
Nominal power consumption  
Rated insulation voltage  
Degree of protection  
Ambient temperature range  
Dimensions W / H / D  
Screw connection solid / stranded / AWG  
EMC note  
Conformance / approvals  
Conformance  
UL, USA / Canada

3.5 VA (3 W)  
300 V (according to EN 50178)  
IP40 (housing) / IP20 (connection terminal blocks)  
-25 °C ... 55 °C  
45 / 90 / 113 mm  
0.5 ... 2.5 mm<sup>2</sup> / 0.25 ... 2.5 mm<sup>2</sup> / 20 - 14

4.5 VA (1.5 W)  
300 V (according to EN 50178)  
IP40 (housing) / IP20 (connection terminal blocks)  
-25 °C ... 55 °C  
22.5 / 90 / 113 mm  
0.5 ... 2.5 mm<sup>2</sup> / 0.25 ... 2.5 mm<sup>2</sup> / 20 - 14  
Class A product, see page 625

CE-compliant  
UL applied for

CE-compliant  
UL/C-UL listed UL 508

#### Ordering data

#### Ordering data

Description

#### Electronic monitoring relay

Power module, plug-in, please order at the same time!

Supply voltage 88 ... 121 V AC  
Supply voltage 108 ... 132 V AC  
Supply voltage 195 ... 264 V AC  
Supply voltage 323 ... 456 V AC  
Supply voltage 425 ... 550 V AC

Type	Order No.	Pcs. / Pkt.
EMD-FL-RP-480	2900177	1
EMD-SL-PS45-110AC	2885281	1
EMD-SL-PS45-120AC	2885744	1
EMD-SL-PS45-230AC	2885294	1
EMD-SL-PS45-400AC	2885304	1
EMD-SL-PS45-500AC	2885317	1

Type	Order No.	Pcs. / Pkt.
EMD-FL-PF-400	2885809	1

### Filling level monitoring

The **EMD-SL-LL-...** monitoring relay monitors the level of electrically conductive liquids with the help of conductive probes (not supplied as standard).

- Adjustable response delay
- Adjustable via potentiometer on front

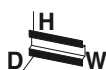

Temperature monitoring (motor windings)



Filling level monitoring

ERIE  
Housing width 22.5 mm

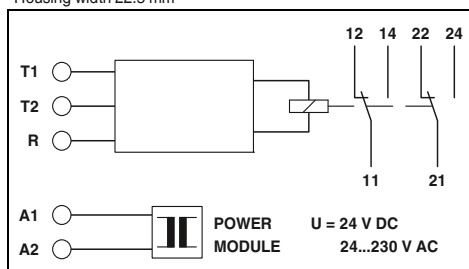

#### Technical data

Winding temperature monitoring

Total cold resistance	< 1.5 kΩ
Response value	≥ 3.6 kΩ (relay drops out)
Release value	≤ 1.8 kΩ (relay picks up)
Basic accuracy	± 10 % (of scale end value)
Repeat accuracy	≤ 2 %
Measuring input	-
Max. probe voltage	-
Max. probe current	-
Length of probe cable	-
Switching threshold	-
Relay output	2 floating PDT contacts
Contact type	750 VA (3 A/250 V AC, module aligned, ≤ 5 mm spacing)
Switching capacity	1250 VA (5 A/250 V AC, module not aligned, ≥ 5 mm spacing)
Electrical service life	2 x 10 <sup>5</sup> cycles at ohmic load, 1000 VA
Mechanical service life	Approx. 2 x 10 <sup>7</sup> cycles
Output fuse	5 A (fast-blow)
General data	
Supply voltage	2 VA (1.5 W)
Nominal power consumption	IP40 (housing) / IP20 (connection terminal blocks)
Degree of protection	
Ambient temperature range	-25 °C ... 55 °C
Dimensions W / H / D	22.5 / 90 / 113 mm
Screw connection solid / stranded / AWG	0.5 ... 2.5 mm <sup>2</sup> / 0.25 ... 2.5 mm <sup>2</sup> / 20 - 14
Conformance / approvals	CE-compliant
Conformance	UL/C-UL listed UL 508
UL, USA / Canada	

ERIE  
Housing width 22.5 mm

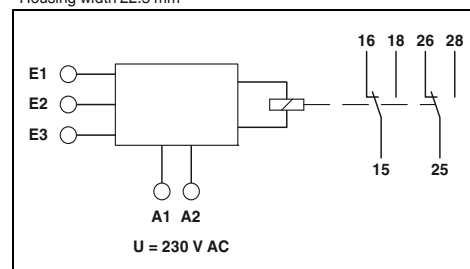

#### Technical data

Pumping up (minimum monitoring), pumping down (maximum monitoring)

Total cold resistance	-
Response value	-
Release value	-
Basic accuracy	-
Repeat accuracy	-
Measuring input	-
Max. probe voltage	Conductive probe, type: SK1, SK2, SK3
Max. probe current	16 V AC
Length of probe cable	7 mA
	< 1000 m (line capacity 100 nF/km; set value < 50%)
	< 100 m (line capacity 100 nF/km; set value 100%)
Switching threshold	0.25 kΩ ... 100 kΩ (4 mS ... 1 μS)
Relay output	2 floating PDT contacts
Contact type	750 VA (3 A/250 V AC, module aligned, ≤ 5 mm spacing)
Switching capacity	1250 VA (5 A/250 V AC, module not aligned, ≥ 5 mm spacing)
Electrical service life	2 x 10 <sup>5</sup> cycles at ohmic load, 1000 VA
Mechanical service life	Approx. 2 x 10 <sup>7</sup> cycles
Output fuse	5 A (fast-blow)
General data	
Supply voltage	EMD-SL-LL-230      EMD-SL-LL-110
Nominal power consumption	230 V AC -15 % ... +15% AC      110 V AC -10 % ... +15% AC
Degree of protection	2 VA (1.5 W)
	IP40 (housing) / IP20 (connection terminal blocks)
Ambient temperature range	-25 °C ... 55 °C
Dimensions W / H / D	22.5 / 90 / 113 mm
Screw connection solid / stranded / AWG	0.5 ... 2.5 mm <sup>2</sup> / 0.25 ... 2.5 mm <sup>2</sup> / 20 - 14
Conformance / approvals	CE-compliant
Conformance	UL/C-UL listed UL 508
UL, USA / Canada	

#### Functions

#### Input

Total cold resistance	< 1.5 kΩ
Response value	≥ 3.6 kΩ (relay drops out)
Release value	≤ 1.8 kΩ (relay picks up)
Basic accuracy	± 10 % (of scale end value)
Repeat accuracy	≤ 2 %
Measuring input	-
Max. probe voltage	-
Max. probe current	-
Length of probe cable	-

#### Switching threshold

#### Relay output

#### Contact type

#### Switching capacity

#### Electrical service life

#### Mechanical service life

#### Output fuse

#### General data

#### Supply voltage

#### Nominal power consumption

#### Degree of protection

#### Ambient temperature range

#### Dimensions W / H / D

#### Screw connection solid / stranded / AWG

#### Conformance / approvals

#### Conformance

#### UL, USA / Canada

#### Ordering data

#### Description

#### Electronic monitoring relay

#### Power module, plug-in, please order at the same time!

#### Supply voltage 20 ... 30 V DC

#### Supply voltage 20.2 ... 26.4 V AC

#### Supply voltage 88 ... 121 V AC

#### Supply voltage 108 ... 132 V AC

#### Supply voltage 195 ... 264 V AC

Type	Order No.	Pcs. / Pkt.
EMD-SL-PTC	2866093	1
EMD-SL-PS- 24DC	2885359	1
EMD-SL-PS- 24AC	2866103	1
EMD-SL-PS-110AC	2866116	1
EMD-SL-PS-120AC	2885731	1
EMD-SL-PS-230AC	2866129	1

#### Ordering data

Type	Order No.	Pcs. / Pkt.
EMD-SL-LL-230	2885906	1
EMD-SL-LL-110	2901137	1

### Compact time relay

The multifunctional time relay offers universal use thanks to a variety of functions and various time settings. The rotary switches on the front of the housing allow easy parameterization. The compact design also allows flexible use.

Main features:

- Adjustable time
- Time range: 50 ms to 1 h
- Non-floating control input
- Delay functions
- Wiper functions
- Output: one floating PDT
- Clear diagnostics via status LED



new

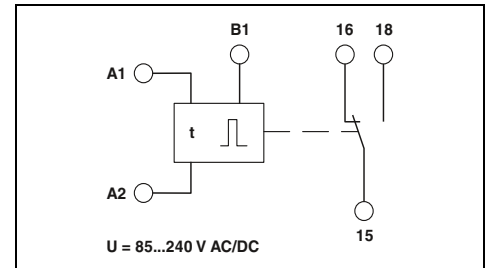

#### Technical data

E: With switch-on delay  
 R: With release delay and control contact  
 Es: With switch-on delay and control contact  
 Ws: With single shot leading edge and control contact

Functions	
Control contact	
Connection	Non-floating, terminals A1-B1
Control pulse length	≥ 50 ms (DC)
Relay output	
Contact type	1 floating PDT
Switching capacity	1250 VA (5 A/250 V AC)
Mechanical service life	15 x 10 <sup>6</sup> cycles
General data	
Supply voltage	85 V AC/DC ... 240 V AC/DC -15 % ... +10 %
Degree of protection	IP40 (housing) / IP20 (connection terminal blocks)
Ambient temperature range	-25 °C ... 55 °C
Housing material	-
Dimensions W / H / D	17.5 / 88 / 65.5 mm
Screw connection solid / stranded / AWG	0.5 ... 2.5 mm <sup>2</sup> / 0.5 ... 2.5 mm <sup>2</sup> / 20 - 14
Push-in connection solid / stranded / AWG	0.5 ... 2.5 mm <sup>2</sup> / 0.5 ... 2.5 mm <sup>2</sup> / 20 - 14
Conformance / approvals	
Conformance	CE-compliant
UL, USA / Canada	UL/C-UL listed UL 508

#### Ordering data

Description	Ordering data		
	Type	Order No.	Pcs. / Pkt.
Compact time relay, multifunctional, with screw connection	ETD-BL-1T-230	2905813	1
Compact time relay, multifunctional, with push-in connection	ETD-BL-1T-230-PT	2905814	1

Timer relay

Plug-in timer module for RIF-1, RIF-2, RIF-3, and RIF-4

The multifunctional plug-in timer module transforms the relay module into a timer relay. The RIF-1 to RIF-4 bases can be fitted with this module. Using DIP switches, you can choose from three time ranges and select four time functions. Fine adjustments to the time are made using a potentiometer. Relays can be operated with an input voltage of 24 V AC/DC.



Time module

Functions:

- With switch-on delay
- With passing make contact
- Flasher/pulse generator

Time ranges:

- 0.5 s - 10 s
- 5 s - 100 s
- 0.5 min - 10 min
- 5 min - 100 min

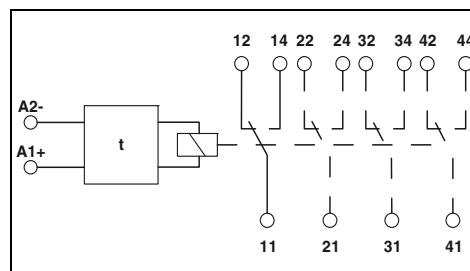

Technical data

<b>Input data</b>
Nominal input voltage $U_N$
Nominal input voltage range with reference to $U_N$
Input circuit
<b>Output data</b>
Limiting continuous current
<b>General data</b>
Mounting position
Repeat accuracy
Ambient temperature (operation)
<b>Standards/specifications</b>
Rated insulation voltage
Rated surge voltage

24 V DC (AC operation only permitted for RIF-1)
0.4 ... 1.2
Varistor, yellow LED
≤ 250 mA (relay coil current)
any
1 %
-25 °C ... 50 °C (RIF-1, AC coil, 2 PDTs at 6 A)
-25 °C ... 50 °C (RIF-1, DC coil, 2 PDTs at 5 A)
-25 °C ... 40 °C (RIF-2, DC coil, 2 PDTs at 8 A)
-25 °C ... 40 °C (RIF-2, DC coil, 4 PDTs at 5 A)
-25 °C ... 40 °C (RIF-3, DC coil, 3 PDTs at 6.75 A)
-25 °C ... 40 °C (RIF-3, DC coil, 2 PDTs at 8 A)
-25 °C ... 35 °C (RIF-4, DC coil, 3 PDTs at 8 A)
-25 °C ... 25 °C (RIF-4, DC coil, 3 N/O contacts at 8 A)
DIN EN 50178
50 V DC
0.4 kV

With switch-on delay

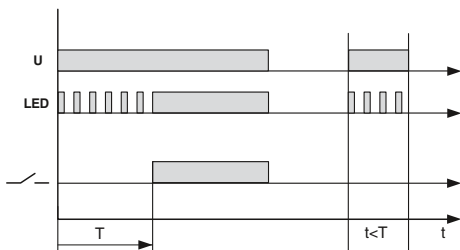

With passing make contact

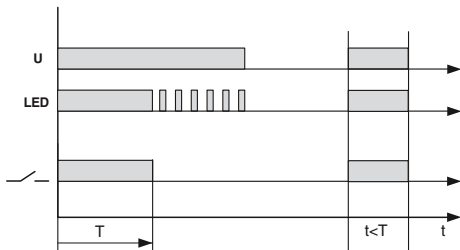

<b>Description</b>
<b>Timer module</b> , for mounting on RIF-1 to RIF-4, with LED status indicator for extending a relay module to create a timer relay with an input voltage of 24 V AC/DC

Ordering data

Type	Order No.	Pcs. / Pkt.
RIF-T3-24UC	2902647	1

Flasher/pulse generator

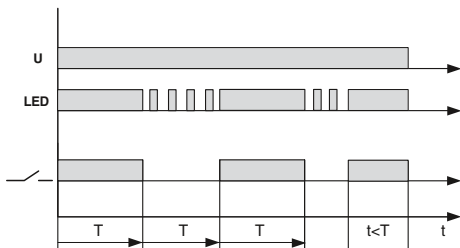

### Ultra-narrow timer relays

The **ETD-BL-1T...** ultra-narrow timer relays show their strengths in applications that involve set parameters for functionality and time range.

- Purposeful device selection: one function, one time range
- High level of setting accuracy thanks to labeled and illuminated thumbwheel
- Narrow overall width of just 6.2 mm

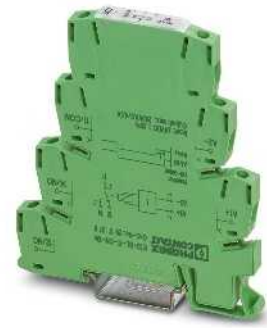

Timer relay with switch-on delay, voltage controlled

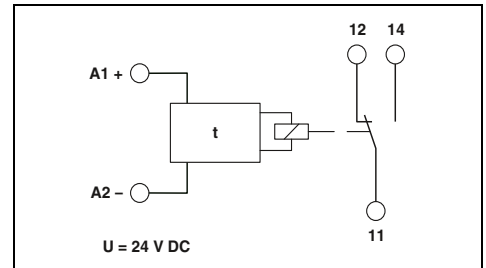

#### Technical data

ON: With switch-on delay

#### Functions

Control contact

Connection

Control pulse length

Relay output

Contact type

Switching capacity

Mechanical service life

General data

Supply voltage

Nominal current typ.

Impulse withstand voltage

Degree of protection

Ambient temperature range

Housing material

Dimensions W / H / D

Screw connection solid / stranded / AWG

Push-in connection solid / stranded / AWG

Conformance / approvals

Conformance

ATEX

UL, USA / Canada

-

min. 50 ms

1 floating PDT

1500 VA (6 A / 250 V AC)

Approx.  $2 \times 10^7$  cycles

24 V DC (19,2 V DC ... 30 V DC)

15 mA (relay ON)

7 mA (relay OFF)

6 kV (according to EN 50178)

IP20

-20 °C ... 65 °C

Polyamide PA, self-extinguishing

6,2 / 80 / 86 mm

0,14 ... 2,5 mm<sup>2</sup> / 0,14 ... 2,5 mm<sup>2</sup> / 30 - 12

0,14 ... 2,5 mm<sup>2</sup> / 0,14 ... 2,5 mm<sup>2</sup> / 26 - 14

CE-compliant

Ex II 3 G Ex nA nC IIC T4 Gc X

UL/C-UL listed UL 508

#### Ordering data

Type	Order No.	Pcs. / Pkt.
ETD-BL-1T-ON- 10S	2917379	1
ETD-BL-1T-ON-300S	2917382	1
ETD-BL-1T-ON- 30MIN	2917395	1
ETD-BL-1T-ON-300MIN	2917405	1
ETD-BL-1T-ON- 10S-PT	2901476	1
ETD-BL-1T-ON-300S-PT	2901477	1
ETD-BL-1T-ON- 30MIN-PT	2901478	1
ETD-BL-1T-ON-300MIN-PT	2901479	1

Description

**Compact timer relay, with screw connection**

Time range 0.1...10 s

Time range 3...300 s

Time range 0.3...30 min

Time range 3...300 min

**Compact timer relay, with push-in technology**

Time range 0.1...10 s

Time range 3...300 s

Time range 0.3...30 min

Time range 3...300 min

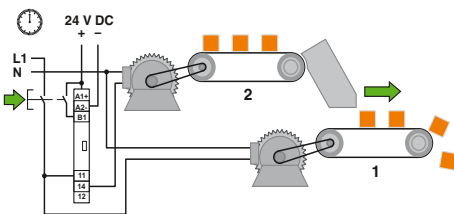

Conveyor belt 1 starts immediately

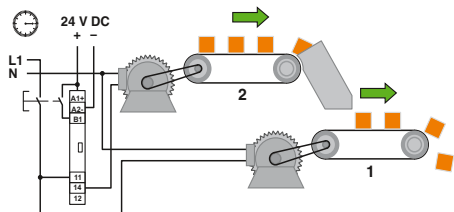

Conveyor belt 2 starts with a time delay

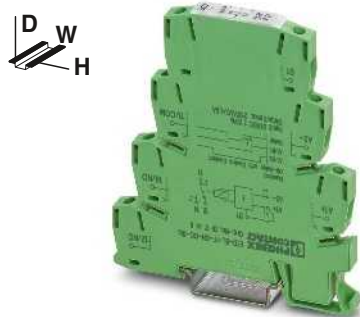

Timer relay with switch-on delay, with control contact

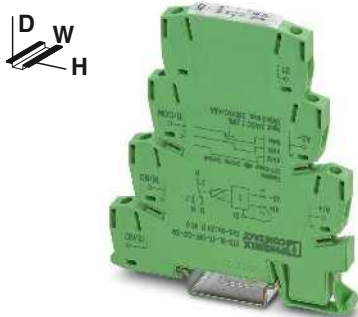

Timer relay with off delay, with control contact

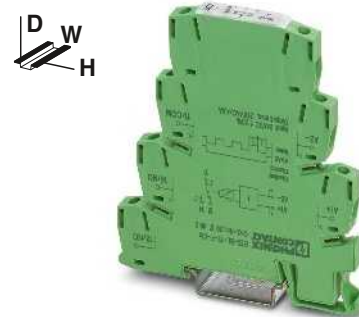

Timer relay with flashing indic. function, beginning with the pulse

Ex:

Ex:

Ex:

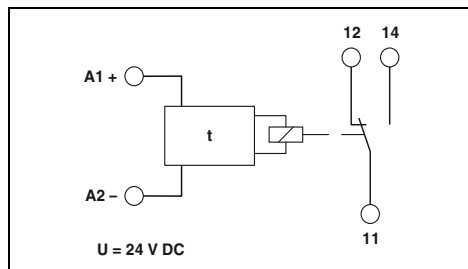
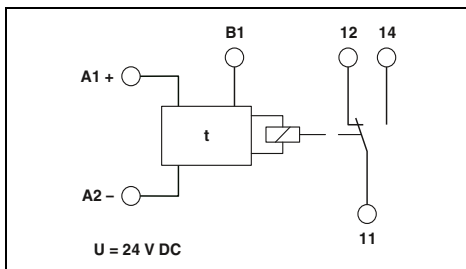
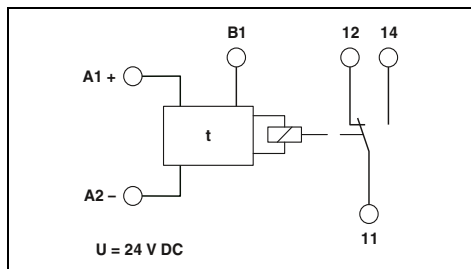

Technical data

Technical data

Technical data

ON-CC: With switch-on delay with control contact

OFF-CC: Off delay with control contact

F: Flashing beginning with pulse

Non-floating, terminals A1-B1  
min. 50 ms

Non-floating, terminals A1-B1  
min. 50 ms

-  
min. 50 ms

1 floating PDT  
1500 VA (6 A / 250 V AC)  
Approx.  $2 \times 10^7$  cycles

1 floating PDT  
1500 VA (6 A / 250 V AC)  
Approx.  $2 \times 10^7$  cycles

1 floating PDT  
1500 VA (6 A / 250 V AC)  
Approx.  $2 \times 10^7$  cycles

24 V DC (19,2 V DC ...30 V DC)  
15 mA (relay ON)  
7 mA (relay OFF)  
6 kV (according to EN 50178)  
IP20  
-20 °C ... 65 °C  
Polyamide PA, self-extinguishing  
6.2 / 80 / 86 mm  
0.14 ... 2.5 mm<sup>2</sup> / 0.14 ... 2.5 mm<sup>2</sup> / 30 - 12  
0.14 ... 2.5 mm<sup>2</sup> / 0.14 ... 2.5 mm<sup>2</sup> / 26 - 14

24 V DC (19,2 V DC ...30 V DC)  
15 mA (relay ON)  
7 mA (relay OFF)  
6 kV (according to EN 50178)  
IP20  
-20 °C ... 65 °C  
Polyamide PA, self-extinguishing  
6.2 / 80 / 86 mm  
0.14 ... 2.5 mm<sup>2</sup> / 0.14 ... 2.5 mm<sup>2</sup> / 30 - 12  
0.14 ... 2.5 mm<sup>2</sup> / 0.14 ... 2.5 mm<sup>2</sup> / 26 - 14

24 V DC (19,2 V DC ...30 V DC)  
15 mA (relay ON)  
7 mA (relay OFF)  
6 kV (according to EN 50178)  
IP20  
-20 °C ... 65 °C  
Polyamide PA, self-extinguishing  
6.2 / 80 / 86 mm  
0.14 ... 2.5 mm<sup>2</sup> / 0.14 ... 2.5 mm<sup>2</sup> / 30 - 12  
0.14 ... 2.5 mm<sup>2</sup> / 0.14 ... 2.5 mm<sup>2</sup> / 26 - 14

CE-compliant  
 II 3 G Ex nA nC IIC T4 Gc X  
UL/C-UL listed UL 508

CE-compliant  
 II 3 G Ex nA nC IIC T4 Gc X  
UL/C-UL listed UL 508

CE-compliant  
 II 3 G Ex nA nC IIC T4 Gc X  
UL/C-UL listed UL 508

Ordering data

Ordering data

Ordering data

Type	Order No.	Pcs. / Pkt.
ETD-BL-1T-ON-CC- 10S	2917418	1
ETD-BL-1T-ON-CC-300S	2917421	1
ETD-BL-1T-ON-CC- 30MIN	2917434	1
ETD-BL-1T-ON-CC-300MIN	2917447	1
ETD-BL-1T-ON-CC- 10S-PT	2901480	1
ETD-BL-1T-ON-CC-300S-PT	2901481	1
ETD-BL-1T-ON-CC- 30MIN-PT	2901483	1
ETD-BL-1T-ON-CC-300MIN-PT	2901484	1

Type	Order No.	Pcs. / Pkt.
ETD-BL-1T-OFF-CC- 10S	2917450	1
ETD-BL-1T-OFF-CC-300S	2917463	1
ETD-BL-1T-OFF-CC- 30MIN	2917467	1
ETD-BL-1T-OFF-CC-300MIN	2917489	1
ETD-BL-1T-OFF-CC- 10S-PT	2901485	1
ETD-BL-1T-OFF-CC-300S-PT	2901486	1
ETD-BL-1T-OFF-CC- 30MIN-PT	2901487	1
ETD-BL-1T-OFF-CC-300MIN-PT	2901488	1

Type	Order No.	Pcs. / Pkt.
ETD-BL-1T-F- 10S	2917492	1
ETD-BL-1T-F-300S	2917502	1
ETD-BL-1T-F- 30MIN	2917515	1
ETD-BL-1T-F-300MIN	2917528	1
ETD-BL-1T-F- 10S-PT	2901489	1
ETD-BL-1T-F-300S-PT	2901490	1
ETD-BL-1T-F- 30MIN-PT	2901491	1
ETD-BL-1T-F-300MIN-PT	2901492	1



# Monitoring

## Monitoring and diagnostics

### Multifunctional timer relays

The full range of conventional applications can be accommodated by the three versions of the **ETD** multifunctional timer relay.

- Suitable for universal use thanks to varied functions and selectable time ranges
- Time ranges from a few milliseconds to several days
- Variable supply voltage range
- 2 floating PDT outputs



**Multifunctional timer relay,  
two adjustable times**



Housing width 22.5 mm

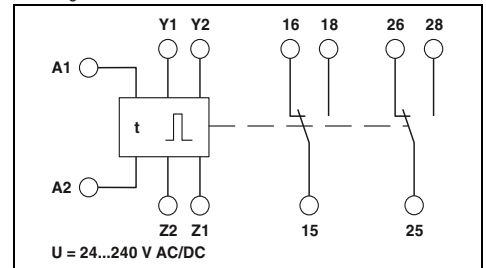

#### Technical data

- Ip: Switched-mode beginning with the pause
- li: Switched-mode beginning with the pulse
- ER: With switch-on and release delay with control contact
- EWu: With switch-on delay and single shot leading edge, voltage controlled
- EWS: With switch-on delay and single shot leading edge with control contact
- WsWa: With single shot leading edge and single shot trailing edge with control contact
- Wt: Pulse sequence evaluation (retriggerable release delay)

#### Functions

#### Time ranges

- Setting range
- Control contact
- Connection

#### Load capacity

- Cable length
- Control pulse length
- Relay output
- Contact type
- Switching capacity

50 ms ... 10 h (10 time end ranges)

Floating, basic insulation between connection and input/output/bridge Y1-Y2  
Cannot carry load

< 10 m  
min. 50 ms (only with Wt function: > 7 ms)

2 floating PDT contacts  
750 VA (3 A/250 V AC, module aligned, ≤ 5 mm spacing)  
1250 VA (5 A/250 V AC, module not aligned, ≥ 5 mm spacing)

#### Mechanical service life

- General data
- Supply voltage

- Nominal power consumption
- Degree of protection

- Ambient temperature range
- Housing material
- Dimensions W / H / D
- Screw connection solid / stranded / AWG
- EMC note

#### Conformance / approvals

- Conformance
- UL, USA / Canada

Approx.  $2 \times 10^7$  cycles

24 V DC ... 240 V DC -20 % ... +25 %  
24 V AC ... 240 V AC -15 % ... +10 %  
2.5 VA (1 W)  
IP40 (housing) / IP20 (connection terminal blocks)

-25 °C ... 55 °C  
Polyamide PA, self-extinguishing  
22.5 / 90 / 113 mm  
0.5 ... 2.5 mm<sup>2</sup> / 0.5 ... 2.5 mm<sup>2</sup> / 20 - 14  
Class A product, see page 625

CE-compliant  
UL/C-UL listed UL 508

#### Ordering data

Type	Order No.	Pcs. / Pkt.
ETD-FL-2T-DTI	2866187	1

#### Description

**Electronic timer relay with adjustable functions and times**

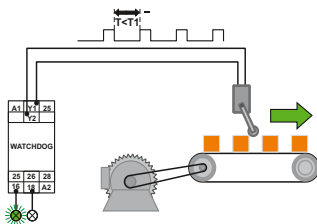

**Function: pulse sequence evaluation**

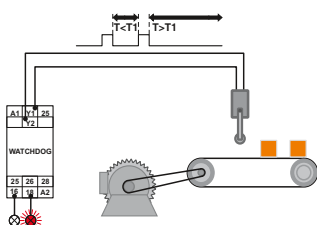

**Message for incorrect pulse**



**Multifunctional timer relay,  
one adjustable time**



**Impulse encoder,  
adjustable pulse and pause times**



Housing width 22.5 mm

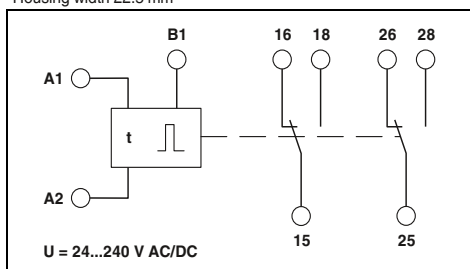

Housing width 22.5 mm

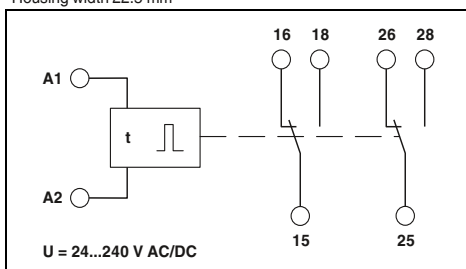

**Technical data**

- E: With switch-on delay
- R: With release delay and control contact
- Es: With switch-on delay and control contact
- Wu: With single shot leading edge, voltage controlled
- Ws: With single shot leading edge and control contact
- Wa: With single shot trailing edge and control contact
- Bi: Flashing beginning with pulse
- Bp: Flashing beginning with pause

50 ms ... 100 h (7 time end ranges)

Non-floating, terminals A1-B1

Parallel switched minimum load current 1 VA (0.5 W), terminals A2-B1

< 10 m  
min. 70 ms

2 floating PDT contacts  
750 VA (3 A/250 V AC, module aligned, ≤ 5 mm spacing)  
1250 VA (5 A/250 V AC, module not aligned, ≥ 5 mm spacing)

Approx. 2 x 10<sup>7</sup> cycles

24 V DC ... 240 V DC -20 % ... +25 %  
24 V AC ... 240 V AC -15 % ... +10 %  
2.5 VA (1 W)  
IP40 (housing) / IP20 (connection terminal blocks)

-25 °C ... 55 °C  
Polyamide PA, self-extinguishing  
22.5 / 90 / 113 mm  
0.5 ... 2.5 mm<sup>2</sup> / 0.5 ... 2.5 mm<sup>2</sup> / 20 - 14  
Class A product, see page 625

CE-compliant  
UL/C-UL listed UL 508

**Ordering data**

Type	Order No.	Pcs. / Pkt.
ETD-SL-1T-DTF	2866161	1

**Technical data**

- Ip: Switched-mode beginning with the pause
- Ii: Switched-mode beginning with the pulse

50 ms ... 100 h (7 time end ranges)

-

-

-

2 floating PDT contacts  
750 VA (3 A/250 V AC, module aligned, ≤ 5 mm spacing)  
1250 VA (5 A/250 V AC, module not aligned, ≥ 5 mm spacing)

Approx. 2 x 10<sup>7</sup> cycles

24 V DC ... 240 V DC -20 % ... +25 %  
24 V AC ... 240 V AC -15 % ... +10 %  
2.5 VA (1 W)  
IP40 (housing) / IP20 (connection terminal blocks)

-25 °C ... 55 °C  
Polyamide PA, self-extinguishing  
22.5 / 90 / 113 mm  
0.5 ... 2.5 mm<sup>2</sup> / 0.5 ... 2.5 mm<sup>2</sup> / 20 - 14  
Class A product, see page 625

CE-compliant  
UL/C-UL listed UL 508

**Ordering data**

Type	Order No.	Pcs. / Pkt.
ETD-SL-2T-I	2866174	1

### Diode modules

Diode circuits perform various tasks in electrical control systems, particularly in electronic ones:

- Electrical decoupling of messages in fault signaling systems
- Spark-suppression diodes for limiting surge voltages of inductive loads, (solenoid valves, DC relays or similar)
- Can be supplied as “diode gates” combined with anode or cathode or as freely assignable diodes



With diode type 1 N 4007



With diode type 1 N 5408

#### Notes:

Further circuit diagrams can be found in the data sheet at [phoenixcontact.net/products](http://phoenixcontact.net/products).

ERC

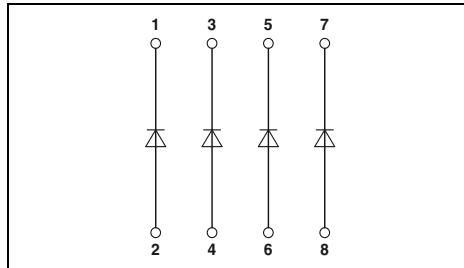

ERC

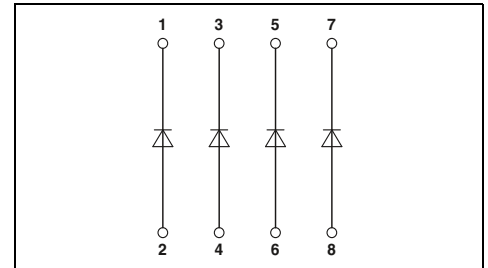

#### Technical data

Diodes	4E / 8E / 17E / 7P / 7M	14P / 14M / 32P / 32M
Max. operating voltage $U_{max}$	250 V AC	250 V AC
Peak reverse voltage per diode	1300 V	1300 V
Reverse current per diode	5 $\mu$ A	5 $\mu$ A
Conducting state voltage per diode	approx. 0.8 V	approx. 0.8 V
Conducting state current per diode		
	with single load	0.7 A
	with simultaneous loads	0.5 A

#### Technical data

4E-... / 4P-... / 4M-... / 8E-...	8P-... / 8M-...
250 V AC	250 V AC
1000 V	1000 V
10 $\mu$ A	10 $\mu$ A
approx. 0.8 V	approx. 0.8 V
1.5 A	1.5 A
1 A	0.3 A

General data	
Ambient temperature range	-20 °C ... 50 °C
Rated insulation voltage	300 V (according to EN 50178)
Pollution degree / Surge voltage category	III, basic insulation (as per EN 50178)
Pollution degree / Surge voltage category	2 (according to EN 50178)
Mounting position	any
Mounting	Can be aligned without spacing
Dimensions H / D	75 / 55 mm
Screw connection solid / stranded / AWG	0.2 ... 4 mm <sup>2</sup> / 0.2 ... 2.5 mm <sup>2</sup> / 24 - 12
Conformance / approvals	
Conformance	CE-compliant

General data	
Ambient temperature range	-20 °C ... 50 °C
Pollution degree / Surge voltage category	III, basic insulation (as per EN 50178)
Pollution degree / Surge voltage category	2 (according to EN 50178)
Mounting position	any
Mounting	Can be aligned without spacing
Dimensions H / D	75 / 55 mm
Screw connection solid / stranded / AWG	0.2 ... 4 mm <sup>2</sup> / 0.2 ... 2.5 mm <sup>2</sup> / 24 - 12
Conformance / approvals	
Conformance	CE-compliant

#### Ordering data

Description	Housing width	Type	Order No.	Pcs. / Pkt.
<b>Diode module</b> , can be individually wired	4 diodes	EMG 22-DIO 4E	2950048	10
	8 diodes	EMG 45-DIO 8E	2950103	5
	17 diodes	EMG 90-DIO 17E	2954895	5
<b>Diode module</b> , with P-polarity (common cathode)	4 diodes	EMG 22-DIO 7P	2950064	10
	7 diodes			
	8 diodes			
	14 diodes			
<b>Diode module</b> , with M polarity (common anode)	4 diodes	EMG 22-DIO 7M	2950077	10
	7 diodes			
	8 diodes	EMG 45-DIO 14M	2950129	5
	14 diodes			
	32 diodes			
	32 diodes			
	4 diodes	EMG 90-DIO 32M	2954934	5
	7 diodes			
	8 diodes			
	14 diodes			

#### Ordering data

Type	Order No.	Pcs. / Pkt.
EMG 22-DIO 4E-1N5408	2952790	10
EMG 45-DIO 8E-1N5408	2949389	5
EMG 22-DIO 4P-1N5408	2952198	10
EMG 45-DIO 8P-1N5408	2954879	5
EMG 22-DIO 4M-1N5408	2952211	10
EMG 45-DIO 8M-1N5408	2954882	5

#### Accessories

Equipment marker	Order No.	Pcs. / Pkt.
EMG-GKS 12	2947035	50

#### Accessories

Equipment marker	Order No.	Pcs. / Pkt.
EMG-GKS 12	2947035	50



Lamp testing module,  
groups of 2 diodes with common cathode



Light indicator module,  
with common return line

### Lamp testing modules

Lamp testing modules for checking lamps that are installed and ready for operation:

- Individual checking of separate lamps (EMG...-E/LP)
- Centrally controlled checking of lamps (EMG...-M/LP)

### Display modules

- Light indicator modules facilitate the monitoring of processes on electronic control systems during troubleshooting

#### Notes:

Further circuit diagrams can be found in the data sheet at [phoenixcontact.net/products](http://phoenixcontact.net/products).

ERC

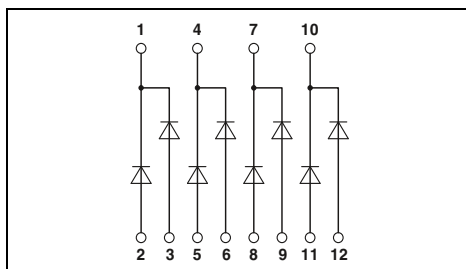

ERC

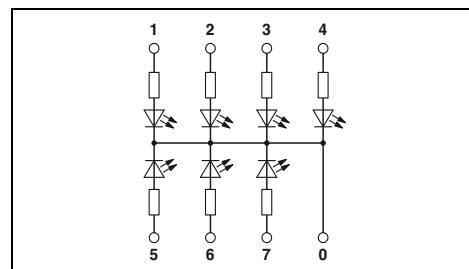

#### Technical data

Diodes	8E/16E	14M/32M
Max. operating voltage $U_{max}$	250 V AC	250 V AC
Peak reverse voltage per diode	1300 V	1300 V
Reverse current per diode	$\leq 5 \mu\text{A}$	$\leq 5 \mu\text{A}$
Conducting state voltage per diode	approx. 0.8 V	approx. 0.8 V

with single load  
with simultaneous loads

	0.7 A	0.7 A
	0.4 A	0.2 A

#### Technical data

LA 7S	LED 7S/LED 14S
-------	----------------

Input		
Current required per light indicator		approx. 1 mA

General data		approx. 3 mA
--------------	--	--------------

Ambient temperature range	-20 °C ... 50 °C	-20 °C ... 45 °C
---------------------------	------------------	------------------

Rated insulation voltage	300 V (according to EN 50178)	
--------------------------	-------------------------------	--

Pollution degree / Surge voltage category	III, basic insulation (as per EN 50178)	III, basic insulation (as per EN 50178)
---	---	---

Pollution degree / Surge voltage category	2 (according to EN 50178)	2 (according to EN 50178)
---	---------------------------	---------------------------

Mounting position	any	any
-------------------	-----	-----

Mounting	Can be aligned without spacing	Can be aligned without spacing
----------	--------------------------------	--------------------------------

Dimensions H / D	75 / 55 mm	75 / 47.5 mm
------------------	------------	--------------

Screw connection solid / stranded / AWG	0.2 ... 4 mm <sup>2</sup> / 0.2 ... 2.5 mm <sup>2</sup> / 24 - 12	0.2 ... 4 mm <sup>2</sup> / 0.2 ... 2.5 mm <sup>2</sup> / 24 - 12
---	---	---

Conformance / approvals		
-------------------------	--	--

Conformance	CE-compliant	CE-compliant
-------------	--------------	--------------

#### Ordering data

Type	Order No.	Pcs. / Pkt.
EMG 45-DIO 8E/LP	2954798	5
EMG 90-DIO 16E/LP	2954808	5
EMG 45-DIO14M/LP	2950132	5
EMG 90-DIO 32M/LP	2954785	5

#### Ordering data

Type	Order No.	Pcs. / Pkt.
EMG 22-LA 7S/230	2949677	10
EMG 22-LED 7S/24	2952305	10
EMG 45-LED 14S/24	2952334	5

#### Accessories

EMG-GKS 12	2947035	50
------------	---------	----

#### Accessories

EMG-GKS 12	2947035	50
------------	---------	----

Description	Housing width
Lamp testing module, for individual wiring	
4-pair	45 mm
8-pair	90 mm
Lamp testing module, with common control	
7-pair	45 mm
16-pair	90 mm
Light indicator module, 110 ... 230 V AC input voltage	
7 glow lamps	22.5 mm
Light indicator module, 24 V DC input voltage	
7 LEDs	22.5 mm
14 LEDs	45 mm

Equipment marker	
------------------	--



# Relay modules

The importance of the reliability of industrial automation equipment is growing with the increase in use of electronic modules.

Modern relay or solid-state relay interfaces perform a wide range of tasks. Whether in production engineering, for the electrical equipment of machines or in control engineering for energy distribution, building automation and materials processing – the main aim is to guarantee the exchange of signals between the process peripherals and the superior, central control systems. This exchange must provide reliable operation, be floating and electrically unambiguous. Safe electrical interface modules that meet the requirements of modern system concepts must include the following features:

- Coupling of different signal levels
- Safe electrical isolation between input and output
- High degree of resistance to interference

In practice, a relay interface comes into use when dealing with a flexible interface configuration with a large switching capacity range and the possibility of combining different types of contact. Further important features of relay interfaces are:

- Electrical isolation between open contacts
- Switching of independent switching current types
- High short-term overload resistance in the event of a short circuit or voltage peaks
- Practically impervious to electromagnetic fields
- Easy handling

Solid-state relay modules are used when an interface between the process peripherals and electronics is subject to the following requirements:

- Low control power
- High switching frequencies
- Wear-free switching with no contact bounce
- Resistance to vibration and impacts
- Long service life

## Product range overview

<b>Product overview</b>	<b>316</b>
<b>Basics of relay technology</b>	<b>318</b>
<b>Basics of solid-state relay technology</b>	<b>322</b>
<b>Sensor/actuator configuration aids and handling of interference signals</b>	<b>324</b>
<b>Industrial relay system with push-in connection - RIFLINE complete</b>	<b>326</b>
<b>Industrial relay system with screw connection - PR series</b>	<b>376</b>
<b>Highly compact relay modules - PLC-INTERFACE</b>	<b>398</b>
<b>Programmable logic relay system - PLC logic</b>	<b>452</b>
<b>Relay modules in terminal block design - DEK series</b>	<b>460</b>
<b>Special relay and solid-state relay modules</b>	<b>466</b>



# Relay modules

## Product overview

### RIFLINE complete



RIF-0 for miniature and solid-state relays  
Page 328



RIF-1 for miniature and solid-state relays  
Page 334



RIF-2 for industrial relays  
Page 342



RIF-3 for octal relays  
Page 346

### PR series



PR1 for miniature or solid-state relays  
As sensor/actuator version  
Page 378  
Page 404

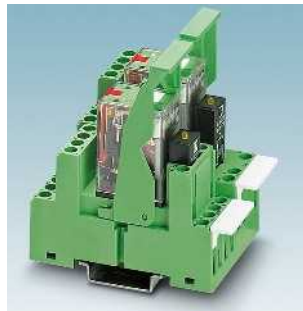

PR2 for industrial relays  
Resistant to interference currents/voltages  
Page 384  
Page 414



PR3 for octal relays  
For railway applications  
Page 388  
Page 441



Accessories  
Types of electronics  
Page 379  
Page 447

### PLC logic



Programmable logic relay system - PLC logic  
Page 454

### DEK series

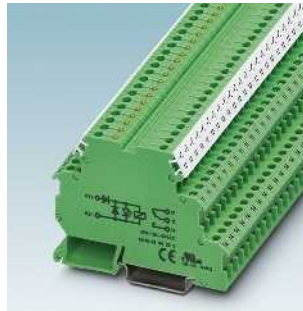

With miniature relay  
Page 461

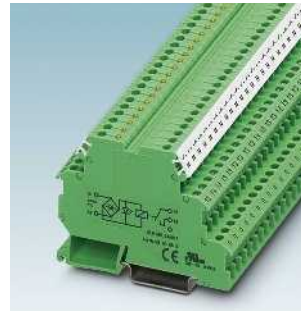

Actuator series with miniature relays  
Page 463



Sensor series with miniature relays  
Page 463

### Special relay and solid-state relay modules

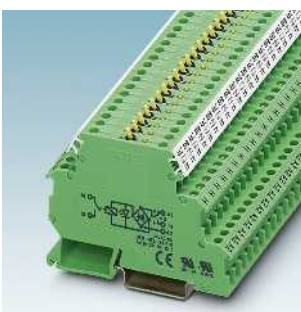

Relay terminal blocks with switch  
Page 467



Interference-free relays and solid-state relays  
Page 468



Relays for switching lamp loads  
Page 471

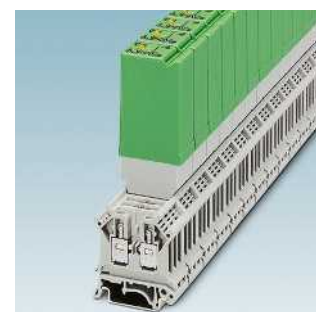

Solid-state power relays with 400 V AC/400 V AC/3 A output  
Page 472



RIF-4 for high-power relays  
Page 350



Accessories  
Page 356

**PLC-INTERFACE**



With relay/solid-state relay  
Page 400  
As sensor/actuator version  
Page 404



For high inrush/continuous currents  
Page 410  
Resistant to interference currents/voltages  
Page 414



With switch  
Page 430  
For railway applications  
Page 441

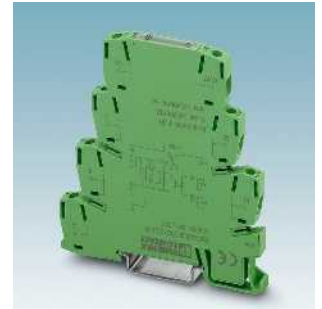

For NAMUR initiators  
Page 446  
Types of electronics  
Page 447

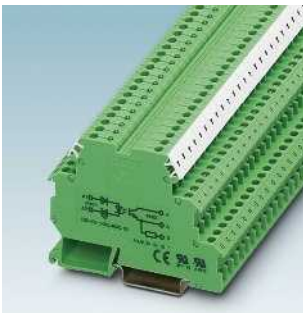

With solid-state relay  
Page 464

**Safety devices**



Safety devices  
See Catalog 8  
Page 378

**Monitoring relays**



Monitoring relays  
Page 298

**Timer relays**



Timer relays  
Page 308

## Basics of relay technology

### General

Electromechanical relays are used as interface modules between the process I/O devices, on the one hand, and the open-loop/closed-loop control and signaling equipment, on the other, for level and power adjustment purposes.

Essentially, electromechanical relays can be divided into two main groups: monostable and bistable relays.

With monostable DC or AC relays, the contacts automatically return to the release state as soon as they are de-energized.

In the case of bistable relays, the contacts remain in their present switch position when the excitation current is switched off.

### Coil side

#### Input circuits and voltage types

There are various kinds of input circuit depending on the type of relay used and the nature of the control voltage.

If pure AC relays are used (AC input), the input circuit is generally nothing more than a visual switching status indicator.

Unless otherwise specified, the frequency of the control voltage is 50/60 Hz.

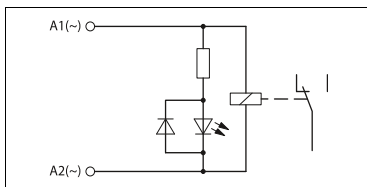

Basic construction of a relay with AC input

In the case of a pure DC input, the most important addition to the circuit is a freewheeling diode. This limits the voltages induced on the coil on circuit interruption to a value of approximately 0.7 V, which does not pose a danger to any connected control electronics.

As the freewheeling diode can only perform its required function if the polarity of the voltage connection is correct, a reverse polarity protection diode is also integrated into the input circuit.

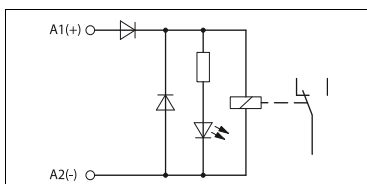

Basic construction of a relay with DC input

To allow DC or AC voltage operation, a bridge rectifier is connected in the input circuit. The diodes are simultaneously responsible for performing rectification, freewheeling, and polarity reversal protection functions. The interrupting voltage of the coil is limited to approximately 1.4 V.

To protect the input circuit against surge voltages, a varistor is also connected (depending on the type) upstream of the bridge rectifier.

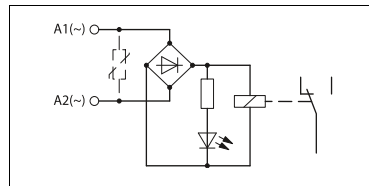

Basic construction of a relay with AC/DC input

Bistable latching relays with duplex winding are operated solely with DC voltage.

With these types of relay, there are three coil connections on the coil side. In addition to the common connection, there are separate connections for “setting” and “resetting”; these are controlled by short pulses only. As a result, the relays hardly heat up at all. Simultaneous control of both control inputs is not permitted.

A distinction is made between negative switching (M) and positive switching (P) types, depending on the polarity of the freewheeling and polarity protection diodes.

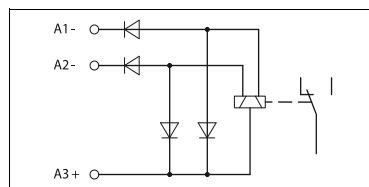

Block diagram of a bistable relay, negative switching type

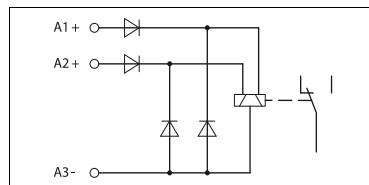

Block diagram of bistable relay, positive switching type

### Operating voltage range

The ambient temperature prevailing at the location of use has a major impact on certain relay operating parameters.

As the ambient temperature increases, the coil winding heats up, causing the response and release voltages to rise. At the same time, the maximum permitted coil voltage decreases, which means that the

usable working range becomes restricted as a result.

The diagram below illustrates how the operating voltage behaves as a function of the ambient temperature.

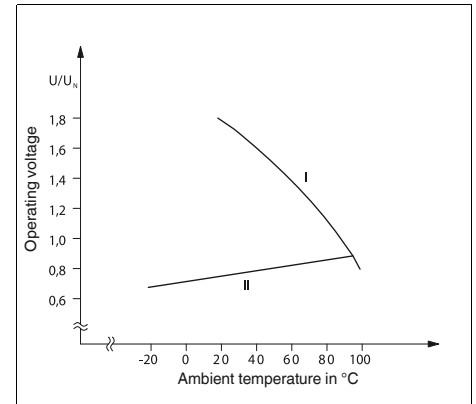

Basic curve of a relay operating voltage

- I: Maximum permitted voltage with 100% operating time (OT) and assuming compliance with the coil temperature limit
- II: Minimum response voltage

### Interference voltages and interference currents on the coil side

When inductive or capacitive interference voltages are coupled into the long supply lines of a relay, this can prevent the relay from operating safely.

If the coupled-in voltage exceeds the release voltage required by the IEC 61810-1 “relay standard”, in extreme cases the relay may fail to release. In the case of DC relays, this release voltage is  $\geq 0.05 \times U_n$ , and for purely AC relays, it is  $\geq 0.15 \times U_n$ .

The same disturbances can occur when a relay with a low input power is controlled by an electronics module with an AC voltage output featuring an RC circuit. The typical leakage current from RC elements of this kind (generally in the region of several mA) provides sufficient control power to prevent the downstream relay from releasing or even enough power to excite it.

The disturbance level of any interference voltages that are present can be reduced by connecting an RC element parallel to the relay coil. This measure also subjects the interference voltage to a capacitive load, causing it to collapse.

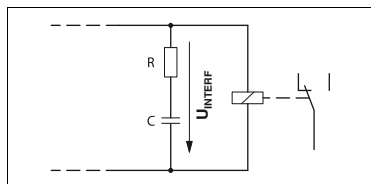

External RC interference suppressor to prevent interference voltage coupling

The following values are recommended for the purpose of dimensioning the RC element:

- R = 100 ... 220 Ω
- C = 220 ... 470 nF

The SO46 series have been developed to provide even higher levels of immunity to interference. These products already contain an integrated RCZ filter. See, for example, PLC...SO46.

### Contact side, contact materials

Given the wide variety of potential applications in the different industrial sectors, the relays used must be matched to the various tasks that need to be performed by selecting the right kind of contact material.

The voltage, current, and power values play an important role when determining the suitability of contact materials. Other criteria include:

- Contact resistance
- Erosion resistance
- Material migration
- Welding tendency
- Chemical influences

In this way, the various contact materials (generally noble metal alloys) can be matched to the relevant usage ranges.

The adjacent table provides details of some of the key materials.

### Contact protection circuit

Every electrical load constitutes a mixed load with ohmic, capacitive, and inductive components.

When these loads are switched, the switching contact is in turn subjected to a load, to either a lesser or greater extent. This load can be reduced by including a suitable contact protection circuit.

In view of the fact that loads with a large inductive component are predominantly used in practice (e.g., contactors, solenoid valves, motors, etc.), these application scenarios are worth considering in more detail.

On interruption, voltage peaks with values of up to several thousand volts occur due to the energy stored in the coil.

These high voltages cause an electric arc on the switching contact which can destroy the contact due to material vaporization and material migration. The electrical service life is reduced considerably as a result. In extreme cases, the relay may fail in

Contact material	Typ. properties	Typ. applications	Guide values for the usage range*
<b>Gold Au</b>	Largely insensitive to industrial atmospheres; low and constant contact resistances in the range of small switching capacities with nickel (AuNi) or silver (AuAg) alloys.	Dry measuring and switching circuits, control inputs	μA ... 0.2 A μV ... 30 V
<b>Silver Ag</b>	High electrical conductivity; sensitive to sulfur, therefore often gold-flashed (approximately 0.2 μm) as protection; nickel (AgNi) or copper (AgCu) alloys increase the mechanical resistance and erosion resistance and reduce the welding tendency.	Universal; suitable for medium loads; nickel alloys (AgNi 0.15) for DC circuits with medium to large loads.	≥ 12 V ≥ 10 mA
<b>Silver, hard gold-plated Ag+Au</b>	Properties similar to gold Au, when switching loads > 30 V/0.2 A, the hard gold plating (5 - 10 μm) is destroyed and the values and properties of the Ag contact are applicable. However, a reduction in the service life is then to be expected.	Suitable for control inputs and other small loads.	≥ 100 mV ≥ 1 mA
<b>Tungsten W</b>	Highest melting point; very high erosion resistance; greater contact resistances; very low welding tendency; susceptible to corrosion; often used as lead contact.	Loads with very high switch-on currents, e.g., glow lamps, fluorescent lamps.	≥ 60 V ≥ 1 A
<b>Silver nickel AgNi</b>	High erosion resistance; low welding tendency; higher contact resistances than with pure silver.	Universal; suitable for medium to high loads; DC circuits, and inductive loads.	≥ 12 V ≥ 10 mA
<b>Silver nickel AgNi+Au</b>	Properties similar to gold Au, when switching loads > 30 V/0.2 A, the hard gold plating (5-10 μm) is destroyed and the values and properties of the AgNi contact are applicable. However, a reduction in the service life is then to be expected.	Suitable for control inputs and other small loads.	≥ 100 mV ≥ 1 mA
<b>Silver tin oxide AgSnO</b>	Low welding tendency; very high erosion resistance for high switching capacities; low material migration	Application depends heavily on the relay type; switching circuits with high make and break loads, e.g. glow lamps and fluorescent lamps, AC and DC circuits. Due to different alloys and production procedures, partly also suitable for smaller loads.	≥ 12 V ≥ 100 mA (≥ 10 mA)
<b>Silver tin oxide, hard gold-plated AgSnO+Au</b>	Properties similar to gold Au, when switching loads > 30 V/0.2 A the hard gold plating (5 - 10 μm) is destroyed and the values and properties of the AgSnO contact are applicable. However, a reduction in the service life is then to be expected.	Suitable for control inputs and other small loads.	≥ 100 mV ≥ 1 mA

\* Values depend on the relay used and on further operating conditions.

the very first switching cycle with DC voltage and an electric arc.

A protective circuit must be used to suppress the formation of an electric arc. With optimum dimensioning, almost the same number of cycles can be achieved as with an ohmic load.



# Relay modules

## Basics of relay technology

In principle, there are a number of possible ways of achieving an effective circuit:

1. Contact wiring
2. Load wiring
3. Combination of both wiring methods

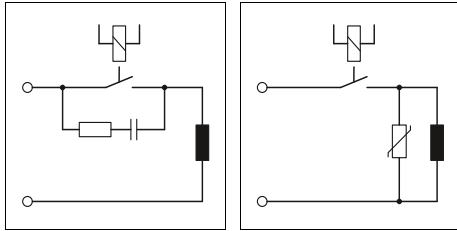

Contact wiring

Inductive load wiring

In principle, protective measures should intervene directly at the source of the interference.

Wiring a load should therefore be given priority over wiring the contact.

The following points are advantageous for the load circuit (image on right):

1. The circuit is only loaded with the induction voltage during interruption. By contrast, the sum of the operating voltage and the induction voltage is applied to the contact circuit.
2. When the contact is open, the load is electrically isolated from the operating voltage.
3. It is not possible for the load to be activated or to “stick” due to undesired operating currents, e.g., from RC elements.
4. Cut-off peaks of the load cannot be coupled into parallel control lines.

Nowadays, solenoid valves are usually connected using valve connectors that are also supplied with LEDs and components that limit the induction voltage. Valve connectors with an RC element, varistor or Zener diode often do not quench the arc and only serve to comply with legislation governing EMC. Only valve connectors with an integrated 1N4007 freewheeling diode quench the arc quickly and safely, thereby increasing the service life of the relay by a factor of 5 to 10. Valve connectors with LED, integrated 1N4007, and free cable end can be supplied on request as part of the SAC range.

Load wiring	Additional dropout delay	Defined induction voltage limitation	Effective bipolar attenuation	Advantages/disadvantages
<b>Diode</b> 	Large	Yes ( $U_D$ )	No	<b>Advantages:</b> <ul style="list-style-type: none"> <li>• Good effect in terms of extending the service life of contacts</li> <li>• Easy implementation</li> <li>• Inexpensive</li> <li>• Reliable</li> <li>• Dimensioning not critical</li> <li>• Low induction voltage</li> </ul> <b>Disadvantages:</b> <ul style="list-style-type: none"> <li>• Attenuation only via load resistor</li> <li>• Long dropout delay</li> </ul>
<b>Diode/Zener diode, series connection</b> 	Medium to small	Yes ( $U_{ZD}$ )	No	<b>Advantages:</b> <ul style="list-style-type: none"> <li>• Dimensioning not critical</li> </ul> <b>Disadvantages:</b> <ul style="list-style-type: none"> <li>• Attenuation only above <math>U_{ZD}</math></li> <li>• Minimal effect in terms of extending the service life of contacts</li> </ul>
<b>Suppressor diode</b> 	Medium to small	Yes ( $U_{ZD}$ )	Yes	<b>Advantages:</b> <ul style="list-style-type: none"> <li>• Inexpensive</li> <li>• Dimensioning not critical</li> <li>• Limitation of positive peaks</li> <li>• Suitable for AC voltages</li> </ul> <b>Disadvantages:</b> <ul style="list-style-type: none"> <li>• Attenuation only above <math>U_{ZD}</math></li> <li>• Minimal effect in terms of extending the service life of contacts</li> </ul>
<b>Varistor</b> 	Medium to small	Yes ( $U_{VDR}$ )	Yes	<b>Advantages:</b> <ul style="list-style-type: none"> <li>• High energy absorption</li> <li>• Dimensioning not critical</li> <li>• Suitable for AC voltages</li> </ul> <b>Disadvantages:</b> <ul style="list-style-type: none"> <li>• Attenuation only above <math>U_{VDR}</math></li> <li>• Minimal effect in terms of extending the service life of contacts</li> </ul>
<b>R/C combination</b> 	Medium to small	No	Yes	<b>Advantages:</b> <ul style="list-style-type: none"> <li>• HF attenuation due to energy storage</li> <li>• Suitable for AC voltages</li> <li>• Level-independent damping</li> </ul> <b>Disadvantages:</b> <ul style="list-style-type: none"> <li>• Precise dimensioning required</li> <li>• High inrush current surge</li> <li>• Minimal effect in terms of extending the service life of contacts</li> </ul>

### Switching small loads

Small loads must be processed mainly in applications where signals must be forwarded to control inputs (e.g., of a PLC).

With these loads, no switching sparks (electric arcs) occur on the contacts in the small load range.

In addition to the constant cleaning effect due to contact friction, this switching spark assumes the function of penetrating non-conductive contamination layers that are formed on the contact surfaces of power contacts.

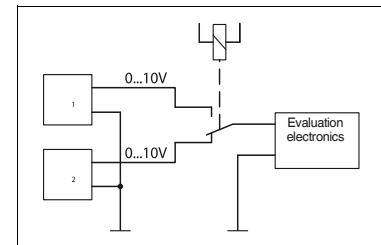

Application example: measurement point changeover

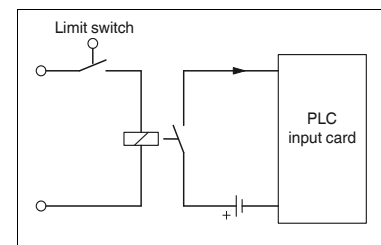

Application example: PLC input signal

These contamination layers are usually oxidation or sulfidation products of the contact materials silver (Ag) or silver alloys such as silver nickel (AgNi) or silver tin oxide (AgSnO). As a result, the contact resistance may rise so considerably within a short time that reliable switching is no longer possible in the case of small loads.

Due to these properties, the high-performance contact materials mentioned are not suitable for small load applications.

Gold (Au) has become accepted as the contact material of choice for these usage ranges mainly on account of its low and constant contact resistances even with small loads and its insensitivity to sulfurous atmospheres.

For the smallest of loads and even greater contact reliability, double contact relays with gold contacts are used.

The slotted contact spring in this design provides two parallel contact points with even lower contact resistances and considerably higher contact reliability.

### Switching large loads

A few important points also need to be considered with regard to switching operations in the large load range that involve power contacts made of either silver (Ag) or silver tin oxide (AgSnO).

A basic distinction must be made between switching DC and AC loads.

### Switching large AC loads

When switching large AC loads, the relay can be operated up to the corresponding maximum values for switching voltage, current, and power. The electric arc that occurs during interruption depends on the current, voltage, and phase relation. This cut-off arc usually disappears automatically the next time the load current passes through zero.

In applications with an inductive load, an effective protective circuit must be provided, otherwise the service life of the system will be reduced considerably.

### Switching large DC loads

Conventional switching relays can only switch off relatively small direct currents (which contrasts with their ability to switch off the maximum permitted AC current), since there is no zero crossing to extinguish the arc automatically. This maximum DC value is also dependent to a large extent on the switching voltage and is determined, among other things, by constructional features such as contact spacing and contact opening speed.

The corresponding current and voltage values are documented by relay manufacturers in electric arc or load limit curves.

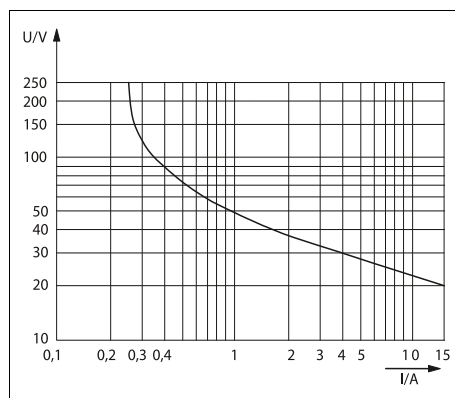

Example of a load limit curve (dependent on the type)

A non-attenuated inductive DC load further reduces the values given for switchable currents. The energy stored in the inductance can cause an electric arc to occur, which forwards the current through the open contacts.

With an effective contact protection circuit, preferably freewheeling diodes of the type 1N4007, the service life can be increased by a factor of 5 to 10 in relation to unprotected or unfavorably protected inductive loads (see also “Contact protection circuit” section).

If higher DC loads than those documented are to be switched or if the electrical service life is to be increased, several contacts of a relay can be connected in series. See, for example, REL-IR... industrial relays.

Alternatively, solid-state relays with DC voltage output can also be used.

### Switching lamps and capacitive loads

Regardless of the type of voltage, all kinds of lamps and loads with a capacitive component impose extreme requirements on the switching contacts. The moment it is switched on, in other words precisely in the dynamic chattering phase of the relay, extremely powerful current peaks occur. These are often in the region of several tens of amps, and not infrequently are known to exceed 100 A, which results in welding of the contact. This can be remedied by using specially optimized “lamp load relays” that can cope with these inrush peaks. See, for example, PLC...IC type.

### Switching capacity according to utilization categories AC15 and DC13 (IEC 60947)

In practice, both the maximum interrupting rating for AC loads and the DC cut-off values taken from the load limit curves provide only a rough guide for selecting a relay. In reality, this is insufficient, since real loads in the vast majority of industrial applications have inductive or capacitive components and the wiring of the loads can be totally different. As already described, this sometimes leads to considerable variations in terms of service life.

The IEC 60947 contactor standard seeks to avoid these disadvantages by dividing the loads into various utilization categories (DC13, AC15, etc.). This standard is also partly applied to relays. However, users must be aware of the fact that these values are only applicable in practice to a limited extent as well, since all DC13 and AC15 test loads are highly inductive and are also operated without any protective circuits at all (see “Contact protection circuit” section). Moreover, the switching capacity test according to IEC 60947 only requires 6060 cycles to be performed by way of a minimum requirement.

A much more reliable way to determine the switching capacity and the anticipated service life is to refer to the specific application data. Using a comprehensive data bank, the service life can be accurately estimated for most applications and, if necessary, suggestions for improvement can be made. In the case of critical applications, the user is advised to gather service life information based on empirical data.



## Basics of solid-state relay technology

### Control side

Solid-state relays for various voltage and power levels are available from Phoenix Contact for use as interface modules designed to match process I/O devices to control, signaling, and regulating devices. The solid-state relay element which is actually located in the module is limited to one defined voltage range by virtue of its design. The current consumption on the input side fluctuates depending on the circuit architecture and voltage level.

To accommodate all industrial voltages between 5 V and 230 V, an input circuit is provided. The inputs for DC voltage and AC voltage must always be differentiated.

### DC input

Adjustments are made in accordance with the various voltage levels by adding electronics which have been specially adapted to the desired voltage range. In the case of most modules, a polarity protection diode provides reliable protection against destruction in the event of a control voltage being connected incorrectly. Specially coordinated filters reliably suppress possible high-frequency noise emissions.

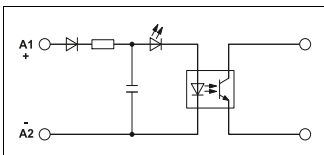

Figure 1: block diagram for DC input

### AC input

The solid-state relay element requires a stable control voltage to ensure reliable operation. In the case of the AC input, this is achieved by connecting a rectifier and filter capacitor upstream. Rectifying is followed, in principle, by the same circuit architecture as the DC input.

The switching frequency always lies below half the mains frequency. Due to the filter capacitor, a higher switching frequency cannot be achieved. This would result in

continuous through-switching.

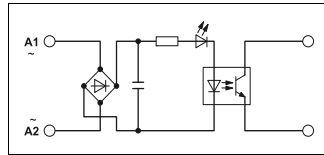

Figure 2: block diagram for AC input

### Load side

Depending on the application and the type of load, the solid-state relay output must meet various requirements. The following are crucial:

- Power amplification
- Matching the switching voltage and the switching current (AC/DC)
- Short-circuit protection

For these different applications, the solid-state relay element must also be processed using additional electronics on the output side.

### DC output

In order to achieve the necessary output power, the solid-state relay element is supplemented by one or more semiconductor components.

The on-site user should nevertheless simply regard the connection terminal blocks of the output as conventional switch connections. Observing the specified polarity is the only essential requirement.

For practical reasons, the following criteria should be taken into account when selecting a suitable solid-state relay:

1. Operating voltage range (e.g., 12 ... 60 V DC)  
This determines the minimum or maximum voltage to be switched. The lower value must be observed in order to ensure reliable operation. In order to protect the output transistor, the upper value must not be exceeded.
2. Maximum continuous current (e.g., 1 A)  
This value indicates the maximum continuous current. If this value is exceeded continuously, the output semiconductor will be destroyed. The dependence of the output current on the ambient temperature of the solid-state relay should also be taken into consideration. A derating curve is therefore generally specified for solid-

state power relays. This shows the maximum load current as a function of the ambient temperature.

### 3. Output circuit

The 2-wire output is similar to a mechanical contact. Only the polarity of the connections is specified and must be observed.

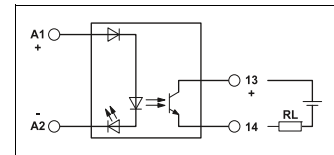

Figure 3: 2-wire output

The 3-wire output is non-isolated and requires both potentials from the voltage source on the output side to be connected if it is to operate reliably.

When switched off, a permanent reference to ground (negative potential) is established. In addition, this output circuit offers the advantage of an almost constant internal resistance.

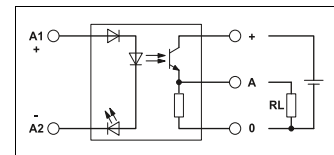

Figure 4: 3-wire output

### AC output

In order to control the switching and control devices for AC voltage, a semiconductor for AC voltage (TRIAC or thyristor) is connected downstream of the solid-state relay element.

As with the DC output, it is particularly important to consider the maximum operating voltage range and the maximum continuous load current as a function of the ambient temperature.

Basics of solid-state relay technology

In addition, the maximum peak reverse voltage of the TRIAC (e.g., 600 V) is crucial with AC outputs. This must not be exceeded even in the case of voltage fluctuations or interference voltage peaks in order to prevent destruction. That is why the AC outputs of all solid-state relays from Phoenix Contact have an internal RC protective circuit to protect against interference voltage peaks.

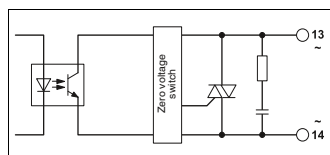

Figure 5: basic circuit diagram of AC output

Protective circuits

The moment inductive loads (contactors, solenoid valves, motors) are switched off, surge voltages occur and these can reach very high amplitudes. Electronic components and switching elements are particularly susceptible to these. A protective circuit should therefore always be provided to prevent destruction.

A parallel connection to the load effectively reduces the switching surge voltage to a harmless level. Depending on the solid-state relay output and type of load:

- A freewheeling diode/suppressor diode (DC only)
  - A varistor (AC and DC)
  - Or an RC element (AC only)
- can provide the necessary protection.

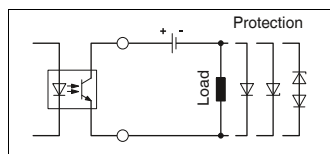

Figure 6: protective circuit with DC voltage output

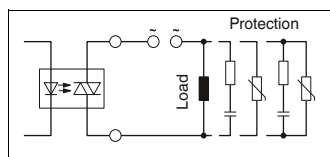

Figure 7: protective circuit with AC voltage output

Application notes

Input solid-state relays acting in the direction from the I/O devices to the controller (signaling, controlling, monitoring)

Plug-in version:

- PLC-O...

Modular version:

- DEK-OE...
- EMG 10-OE...
- SIM-EI...
- OPT...

Output (power) solid-state relays acting in the direction from the controller to the I/O devices (switching, amplifying, controlling)

Plug-in version:

- PLC-O...

Modular version:

- DEK-OV...
- EMG 10-OV
- EMG 12-OV
- EMG 17-OV
- OV...
- OPT...

Example: load contactor monitoring (DC contactor)

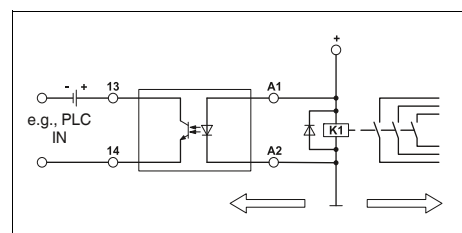

Example: load contactor monitoring (AC contactor)

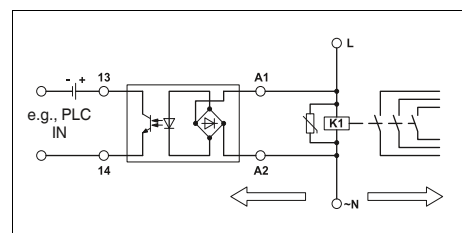

Example: position indication with limit stop contact or initiator

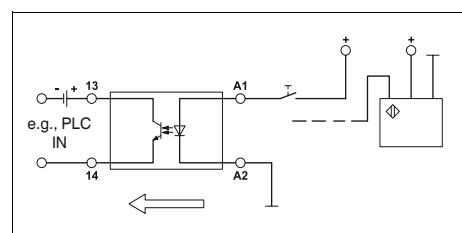

Example: switching the contactor, solenoid valve or motor (DC load)

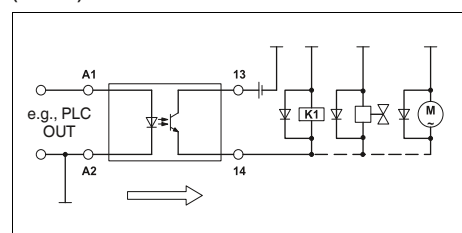

Example: switching the contactor, solenoid valve or motor (AC load)

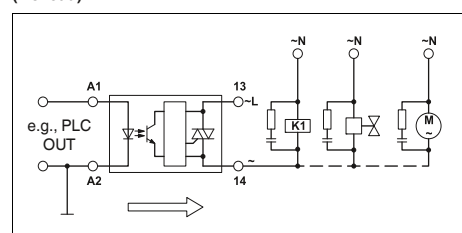

Remarks:

- 1) Ground (negative) potential from the input and output of the solid-state relay must not be connected.
- 2) DC loads must be provided with an effective protective circuit (e.g., diode).
- 3) AC loads must be protected with a varistor or an RC element.

# Relay modules

## Sensor/actuator configuration aids and handling of interference signals

### Configuration aid for connecting sensors and actuators

Electromechanical relays or solid-state relays are used as a coupling element between the controller and the sensors or actuators in the field. This interface ensures appropriate signal conditioning with respect to current and voltage between the controller and field level.

### Conventional connection of actuators

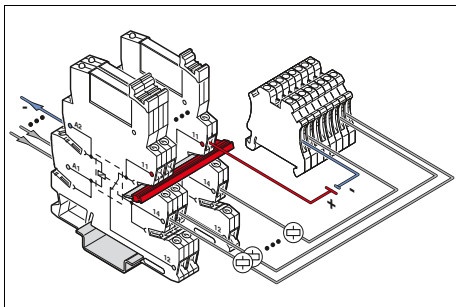

If actuators such as solenoid valves are connected to the controller via a universal relay with PDT contact, an additional terminal block strip must be used for the common load return line. The positive potential of the loads is applied to connection terminal block 11 (PDT contact) at the relay modules. This can be distributed over all relay modules using jumpers. This means only the direct connection of the potential to a relay is necessary. The loads are connected to connection terminal blocks 14 (N/O contact). The negative potential required is supplied at a terminal block. This is then distributed to further terminal blocks by means of jumpers. However, load return lines for the individual actuators are applied to every terminal block. This results in a common load return line potential for all actuators via the additional terminal block.

Due to increased space requirements and additional wiring to the terminal block, the use of additional terminal blocks for distributing potential is extremely time-consuming.

### Easy wiring of actuators

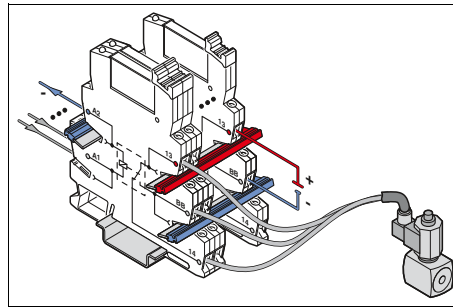

The PLC...ACT relay modules enable fast and easy connection of actuators. The positive potential of the loads is applied to connection terminal block 13. This can be distributed over all relay modules using jumpers. This only makes direct connection to a module necessary. The actuators are connected to contact 14 (N/O contact). In the case of PLC...ACT relay modules, an N/C contact is not required. Instead, the BB connection serves as an option for connecting the load return line. Here the common negative potential is supplied and distributed by means of jumpers. Conventional wiring of the terminal block is not necessary due to direct connection of the load return line potential to the relay module. This means that no additional space is required in the control cabinet and simpler wiring minimizes the risk of error.

### Conventional connection of sensors

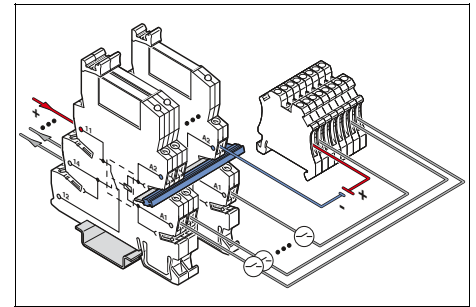

If sensors such as proximity switches are connected via a universal relay to a controller with a PDT contact, an additional terminal block strip must be used for the common sensor supply voltage. It must also be observed that either the wiring in the control cabinet must be the other way round since control of the relay is now from the field level and not via the controller. Or the relay module is installed in the control cabinet rotated at 180°. The negative potential of the sensors is applied at connection terminal block A2 on the relay module. This can be distributed over all relay modules using jumpers. This means only the direct connection to a relay is necessary. The sensors are connected to connection terminal block A1. The necessary positive potential is supplied to a terminal block and distributed to further terminal blocks by means of jumpers. However, the supply for the individual sensors is applied to every terminal block. This results in a common supply signal for all sensors via the additional terminal blocks.

Due to increased space requirements and additional wiring to the terminal block, the use of additional terminal blocks for distributing potential is extremely time-consuming.

### Configuration aid for handling interference signals

#### Easy wiring of sensors

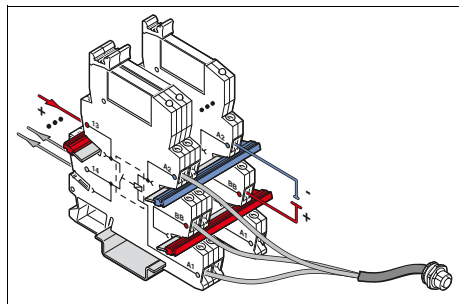

Sensors can be efficiently coupled with the controller with the PLC...SEN relay modules. The input and output side at the module are already interchanged so that the signal direction from the field to the controller can be ideally represented. Therefore, three connection terminal blocks A1, A2, and BB are located on the control side of the relay. The common negative potential of the sensors is then connected to A2 and distributed to further relay modules by means of jumpers. The sensors are connected directly to the A1 connections. Connection BB is used for the common supply potential of the sensors. The potential is distributed to all connected sensors by means of the jumpers. However, only connections 13 and 14 for the N/O contact are located on the contact side. Signal feedback to the controller takes place via these connections. The terminal block for conventional wiring can be saved by connecting the sensor supply voltage directly to the relay module. This means that no additional space is required in the control cabinet and simpler wiring minimizes the risk of error.

According to IEC 61810-1, the standard release voltage of a relay is 5% of the nominal voltage for DC coils and 15% for AC coils. That means that a relay with a nominal voltage of 230 V AC is switched off only when the control voltage is  $\leq 0.15 \times 230 \text{ V AC} = 34.5 \text{ V AC}$ . If interference signals occur on the control side of a relay that are greater than the release voltage, defined switch-off is no longer possible. In the worst case, the interference is large enough to energize the relay. The application is still in a switched-on state although no signal is applied by the controller. There can be various reasons for this.

#### Coupling of interference signals from parallel lines

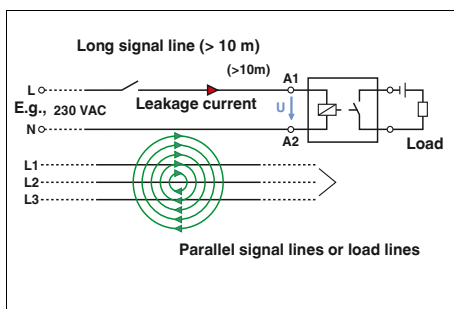

If the control lines to the relay are very long, interference can occur from parallel-running cables. These influence the actual control line and couple the signals to them. This interference voltage can be measured on the control side, even if no signal is applied by the controller.

#### Leakage current with AC voltage output card

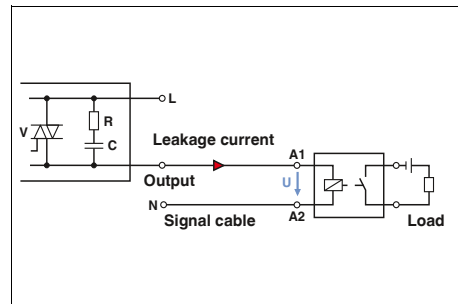

Leakage current on the signal line occurs if control of a relay takes place via an output card with AC voltage. This is caused by the RC wiring of the AC voltage output. Typically, the leakage current has a control power that is large enough not to switch off the relay reliably.

#### Safe shutdown even with interference signals

The PLC...SO46 series is equipped with RCZ wiring in the base. The release voltage of the relay is increased by this circuit of resistor, capacitor, and Zener diode so that the relay is resistant to interference voltage. In the case of a 230 V AC relay, the standard release voltage is 34.5 V AC. The PLC...230UC...SO46 modules have a release voltage of 80 V AC. This enables the relay to switch off reliably at interference voltages of  $\leq 80 \text{ V AC}$ . The PLC...SO46 bases are also available with further voltages. Fitting is possible with both electromechanical relays or solid-state relays. Screw connection or push-in connection is available as connection technology.

## Relay modules

### Industrial relay system with push-in connection - RIFLINE complete

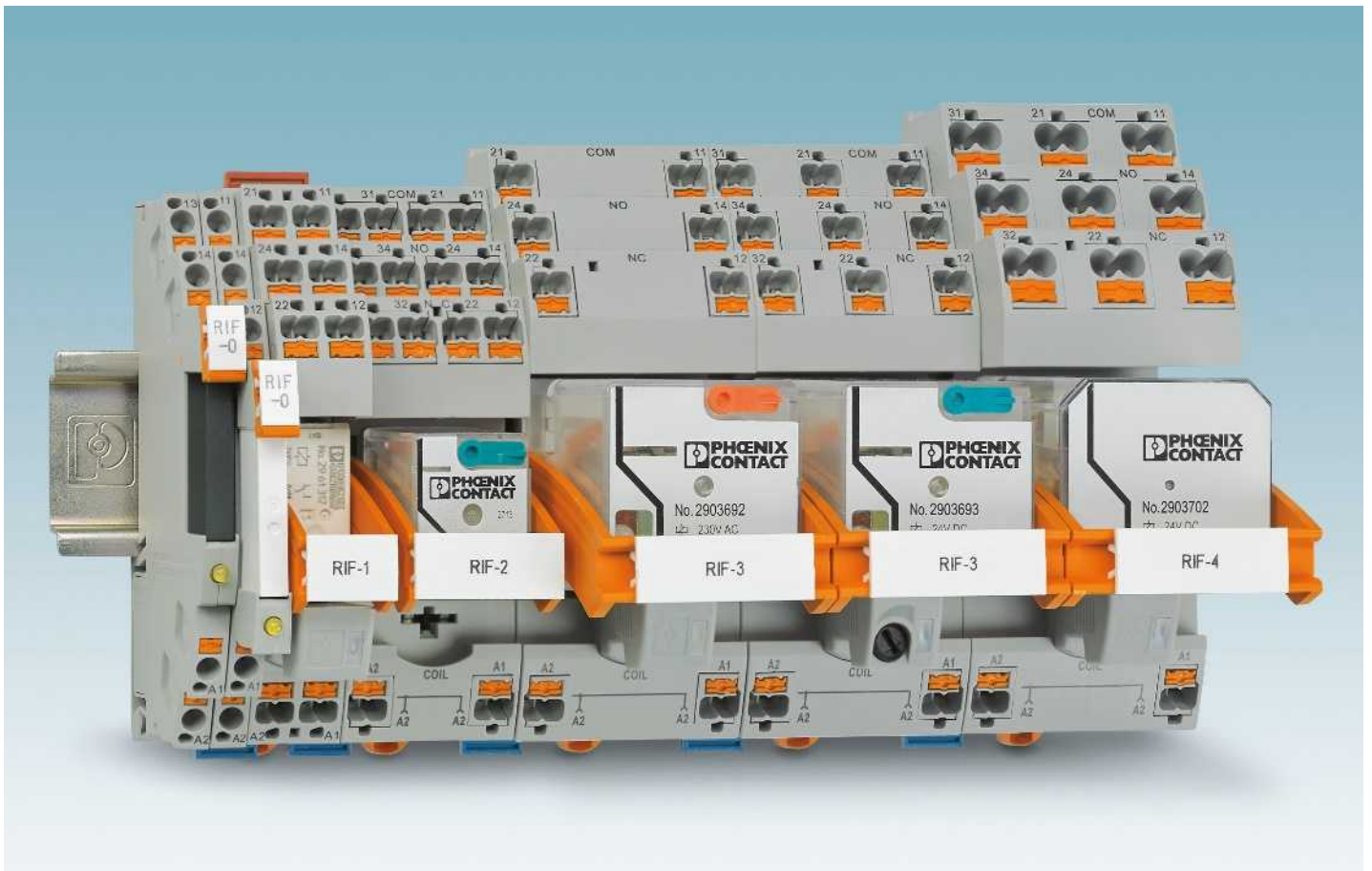

RIFLINE complete is an inexpensive relay system with various accessories. It consists of DIN rail bases, electromechanical or solid-state relays, plug-in input/interference suppression modules, marking material, and bridging material. The range of accessories is rounded off with a timer module. This can be used to transform a basic relay into a timer relay with three different functions.

The RIFLINE complete relay range consists of seven different base versions from RIF-0 to RIF-4 – these range from one N/O contact up to four PDT contacts. The field of application of this product group ranges from coupling relay applications with switching currents of one milliamp to replacement for miniature contactors with currents up to 16 A.

The relay bases feature push-in connection technology, which enables quick and tool-free conductor contacting. The RIF-1 to RIF-4 bases offer double the contact options on both the input and output side.

On the input side of all bases, the negative potential (A2) can be bridged – regardless of the base size. On the output side, the grouped contact (11) can be bridged within the RIF-0 base version. This connection can also be bridged within the RIF-1 base size.

To offer diverse marking options, the engagement lever can be fitted with a zack marker strip. In addition, marker carriers

can be mounted on the bases so that additional marking surfaces are available.

RIFLINE complete can be extended using many elements from the CLIPLINE complete accessories range. This includes marking material, bridges, and test adapters.

To make ordering and management easy, RIFLINE complete modules are provided in the most popular voltages as complete modules with relay and input/interference suppression module. For individual assembly, tailored to the requirements of the application, additional voltage levels are offered in the modular system.



**RIF-0**

The narrow 6.2 mm RIF-0 base series is designed for miniature relays with one contact. Switching currents up to 6 A are implemented here. Two base versions are available: 1 N/O contact and 1 PDT contact. RIF-0 is therefore a good choice for all coupling applications.

**RIF-1**

The narrow 16 mm RIF-1 base series is designed for miniature relays with 2 contacts. Currents up to 13 A can be switched when using the FBS 2-8 jumper. This is the ideal relay for applications that require coupling, power switching, and signal duplication.

**RIF-2**

The 31 mm wide RIF-2 base series is designed for industrial relays with up to 4 contacts. Currents up to 12 A are no problem for these bases. This relay is ideal for applications that require power and signal multiplication.

**RIF-3**

The 40 mm wide RIF-3 base series is designed for octal relays with up to 3 contacts. Switching currents up to 10 A can be implemented here. Two base versions are available: 2 PDT contacts and 3 PDT contacts. RIF-3 bases are ideal for all applications that require power and signal multiplication.

**RIF-4**

The 43 mm wide RIF-4 base series is designed for power relays with up to 3 contacts. Currents up to 16 A can be switched. RIF-4 bases are a good choice for applications that require power and signal multiplication, e.g., in miniature contactor applications.

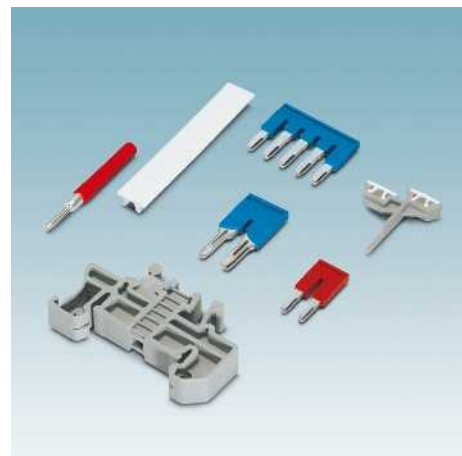
**Accessories**

A wide range of accessories are available for the RIFLINE complete relay system that round off the range. These include bridges, professional marking material, function modules, test plugs, and end brackets.



# Relay modules

## Industrial relay system with push-in connection - RIFLINE complete

### Modular RIF-0 relay base

Relay base that can be fitted with miniature power relays or solid-state relays with a nominal voltage of 12 to 24 V DC.

The advantages:

- Integrated freewheeling diode for input circuit and interference suppression circuit
- LED for status display
- Safe isolation according to DIN EN 50178 between coil and contact
- Professional marking material
- Holders for test plugs
- Professional bridging of adjacent modules saves wiring time (A2 and 11/13)
- FBS 2-6 jumpers for the input and output side

Notes:
Type of insulating housing: Polyamide PA non-reinforced, color: gray.
For further marking systems and mounting material, see Catalog 5.

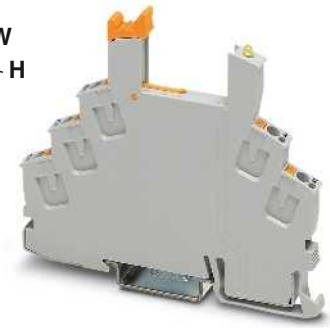

1 PDT relay base for miniature power relay



#### Technical data

250 V AC/DC (contact side)  
max. 8 A (depending on application/assembly)

Nominal voltage  $U_N$   
Nominal current at  $U_N$

#### General data

Ambient temperature (operation)

-40 °C ... 85 °C (depending on application/assembly)

Connection data solid / stranded / AWG

0.14 ... 1.5 mm<sup>2</sup> / 0.14 ... 1.5 mm<sup>2</sup> / 26 - 18

Dimensions

Width

6.2 mm

Depth

78 mm

Height

93 mm

#### Ordering data

Description
<b>RIF-0 relay base</b> , PDT version, safe isolation I/O With push-in connection
<b>RIF-0 relay base</b> , N/O contact version, safe isolation I/O With push-in connection

Type	Order No.	Pcs. / Pkt.
RIF-0-BPT/21	2900958	10

#### Accessories

<b>Jumper</b>	
2-pos. red, 24 A	
2-pos. red, 32 A	
2-pos. blue, 32 A	
2-pos. gray, 32 A	
3-pos. red, 24 A	
4-pos. red, 24 A	
5-pos. red, 24 A	
5-pos. red, 32 A	
10-pos. red, 32 A	
20-pos. red, 32 A	
50-pos. red, 32 A	
<b>End bracket</b> , for snapping onto NS 35, 9.5 mm wide, can be marked with ZB 6, ZB 8/27, KLM...	
<b>Test plug</b> , consisting of:	
<b>Metal part</b> for 2.3 mm Ø socket hole and	silver
<b>Insulating sleeve</b> , for MPS metal part	
	red
	white
	blue
	yellow
	green
	gray
	black
<b>Zack marker strip</b> , 10-section, unprinted: pack contains enough to mark 100 terminal blocks	
10-section	

<b>FBSR 2-6</b>	3033715	50
<b>FBS 2-6</b>	3030336	50
<b>FBS 2-6 BU</b>	3036932	50
<b>FBS 2-6 GY</b>	3032237	50
<b>FBSR 3-6</b>	3001594	50
<b>FBSR 4-6</b>	3001595	50
<b>FBSR 5-6</b>	3001596	50
<b>FBS 5-6</b>	3030349	50
<b>FBS 10-6</b>	3030271	10
<b>FBS 20-6</b>	3030365	10
<b>FBS 50-6</b>	3032224	10
<b>CLIPFIX 35</b>	3022218	50
<b>MPS-MT</b>	0201744	10
<b>MPS-IH RD</b>	0201676	10
<b>MPS-IH WH</b>	0201663	10
<b>MPS-IH BU</b>	0201689	10
<b>MPS-IH YE</b>	0201692	10
<b>MPS-IH GN</b>	0201702	10
<b>MPS-IH GY</b>	0201728	10
<b>MPS-IH BK</b>	0201731	10
<b>ZB 6:UNBEDRUCKT</b>	1051003	10

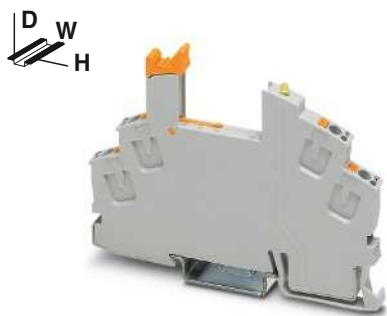

1 N/O contact relay base for miniature power relay



**Technical data**

250 V AC/DC (contact side)  
max. 8 A (depending on application/assembly)

-40 °C ... 85 °C (depending on application/assembly)

0.14 ... 1.5 mm<sup>2</sup> / 0.14 ... 1.5 mm<sup>2</sup> / 26 - 16

6.2 mm  
66 mm  
93 mm

**Ordering data**

Type	Order No.	Pcs. / Pkt.
RIF-0-BPT/1	2901873	10

**Accessories**

FBSR 2-6	3033715	50
FBS 2-6	3030336	50
FBS 2-6 BU	3036932	50
FBS 2-6 GY	3032237	50
FBSR 3-6	3001594	50
FBSR 4-6	3001595	50
FBSR 5-6	3001596	50
FBS 5-6	3030349	50
FBS 10-6	3030271	10
FBS 20-6	3030365	10
FBS 50-6	3032224	10
CLIPFIX 35	3022218	50
MPS-MT	0201744	10
MPS-IH RD	0201676	10
MPS-IH WH	0201663	10
MPS-IH BU	0201689	10
MPS-IH YE	0201692	10
MPS-IH GN	0201702	10
MPS-IH GY	0201728	10
MPS-IH BK	0201731	10
ZB 6:UNBEDRUCKT	1051003	10

# Relay modules

## Industrial relay system with push-in connection - RIFLINE complete

### Plug-in miniature power relays

Plug-in miniature power relays suitable for RIF-0 and PLC-INTERFACE relay bases.

The advantages:

- Power contacts up to 6 A
- Multi-layer gold contact or power contact
- High degree of protection RT III (comparable with IP67)
- Safe isolation according to DIN EN 50178 between coil and contact
- Can be soldered in on PCB



1 PDT

**Notes:**  
If the specified maximum values for multi-layer contact relays are exceeded, the gold plating is destroyed. The maximum values of the power contact relay are then valid. This can result in a shorter service life than with a pure power contact.  
For dimensional drawings and perforations for assembly, see page 424

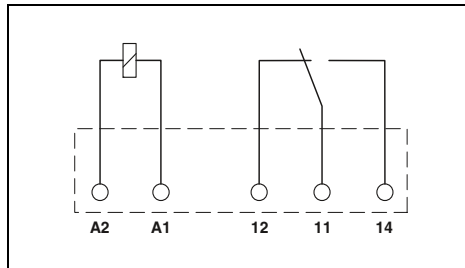

#### Technical data

	①	②
<b>Input data</b>		
Permissible range (with reference to $U_N$ )	see diagram	
Typ. input current at $U_N$	14	7
Typ. response time at $U_N$	5	5
Typ. release time at $U_N$	2.5	2.5
<b>Output data</b>		
Contact type	1 PDT	1 PDT
Contact material	AgSnO	AgSnO, hard gold-plated
Max. switching voltage	250 V AC/DC	30 V AC / 36 V DC
Min. switching voltage	5 V (at 100 mA)	100 mV (at 10 mA)
Limiting continuous current	6 A	50 mA
Max. inrush current	on request	50 mA
Min. switching current	10 mA (at 12 V)	1 mA (at 24 V)
<b>General data</b>		
Test voltage (winding/contact)	4 kV AC (50 Hz, 1 min.)	
Ambient temperature (operation)	-40 °C ... 85 °C	
Nominal operating mode	100% operating factor	
Mechanical service life	2 x 10 <sup>7</sup> cycles	
Standards/regulations	IEC 60664, EN 50178, IEC 62103	
Mounting position / mounting	any / can be aligned without spacing	
Dimensions	5 mm / 28 mm / 15 mm	

#### Ordering data

Description	Input voltage $U_N$	Type	Order No.	Pcs. / Pkt.
<b>Plug-in miniature power relay</b>				
with power contacts	① 12 V DC	REL-MR- 12DC/21	2961150	10
with power contacts	② 24 V DC	REL-MR- 24DC/21	2961105	10
<b>Plug-in miniature power relay</b>				
with multi-layer gold contacts	① 12 V DC	REL-MR- 12DC/21AU	2961163	10
with multi-layer gold contacts	② 24 V DC	REL-MR- 24DC/21AU	2961121	10

### REL-MR-.../21... (1 PDT)

Input voltage range

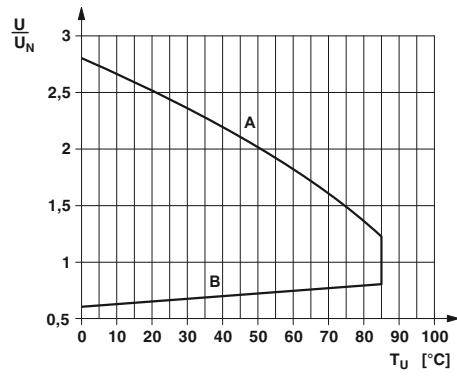

Interrupting rating

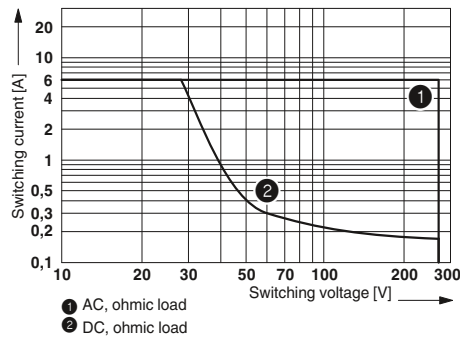

- ① AC, ohmic load
- ② DC, ohmic load

# Relay modules

## Industrial relay system with push-in connection - RIFLINE complete

### Plug-in solid-state relays

Plug-in solid-state relays suitable for RIF-0 and PLC-INTERFACE relay bases.

The advantages:

- Switching capacity of up to 24 V DC/3 A
- RT III wash tight (comparable to IP67)
- Vibration and shock-resistant
- Wear-free and long-lasting
- Zero voltage switch at AC output
- Can be soldered in on PCB

Notes:
For dimensional drawings and perforations for assembly, see page 425



Max. DC voltage output of 3 A

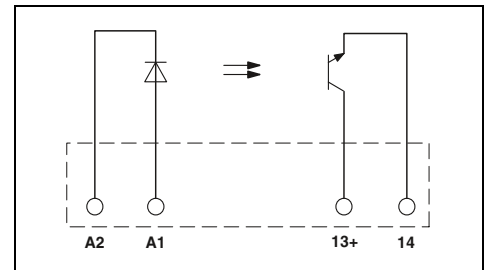

Input data	
Permissible range (with reference to $U_N$ )	
Switching level	1 signal ("H") [V DC] $\geq$ 16 0 signal ("L") [V DC] $\leq$ 10
Typ. input current at $U_N$	[mA] 7
Typ. switch-on time at $U_N$	[ $\mu$ s] 20
Typ. shutdown time at $U_N$	[ $\mu$ s] 300
Transmission frequency $f_{limit}$	[Hz] 300
Output data	
Max. switching voltage	33 V DC
Min. switching voltage	3 V DC
Limiting continuous current	3 A (see derating curve)
Min. load current	-
Max. inrush current	15 A (10 ms)
Leakage current in off state	-
Phase angle (cos $\phi$ )	-
Output circuit	2-wire, floating
Max. load value	-
Output protection	Protection against polarity reversal, surge protection
Voltage drop at max. limiting continuous current	$\leq$ 150 mV
General data	
Rated surge voltage	Basic insulation
Test voltage input/output	2.5 kV (50 Hz, 1 min.)
Ambient temperature (operation)	-25 °C ... 60 °C
Nominal operating mode	100% operating factor
Standards/regulations	IEC 60664, EN 50178, IEC 62103
Pollution degree / surge voltage category	2 / III
Mounting position / mounting	any / can be aligned without spacing
Dimensions	W / H / D 5 mm / 28 mm / 15 mm

### Technical data

①	0.8 - 1.2
	16
	10
	7
	20
	300
	300
	33 V DC
	3 V DC
	3 A (see derating curve)
	-
	15 A (10 ms)
	-
	-
	2-wire, floating
	-
	Protection against polarity reversal, surge protection
	$\leq$ 150 mV
	Basic insulation
	2.5 kV (50 Hz, 1 min.)
	-25 °C ... 60 °C
	100% operating factor
	IEC 60664, EN 50178, IEC 62103
	2 / III
	any / can be aligned without spacing
	5 mm / 28 mm / 15 mm

Description	Input voltage $U_N$
<b>Plug-in solid-state relay</b> Solid-state power relay	① 24 V DC
<b>Plug-in solid-state relay</b> Solid-state input relay	① 24 V DC

### Ordering data

Type	Order No.	Pcs. / Pkt.
<b>OPT-24DC/ 24DC/ 2</b>	<b>2966595</b>	10

Industrial relay system with push-in connection - RIFLINE complete

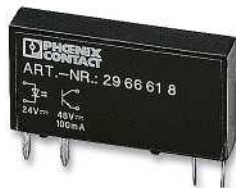

Max. DC voltage output of 100 mA



Max. AC voltage output of 750 mA

Derating curve for OPT...DC/24DC/2 and PLC-OS.../24DC/2 solid-state relays

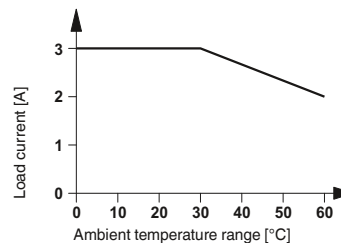

Derating curve for OPT...DC/230AC/1 and PLC-OS.../230AC/1 solid-state relays

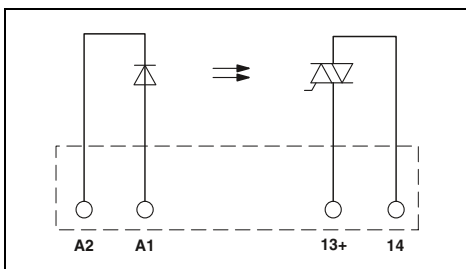
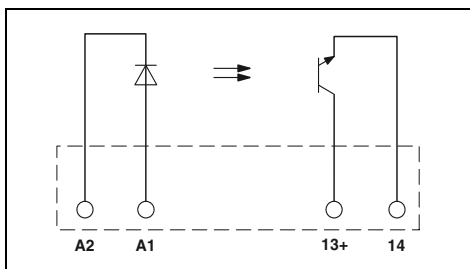
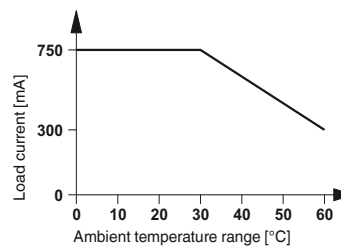

Technical data

①
0.8 -
1.2
16
10
7
20
300
300

48 V DC
3 V DC
100 mA
-
-
-
-
2-wire, floating
-
Protection against polarity reversal, surge protection
≤ 1 V

Basic insulation
2.5 kV (50 Hz, 1 min.)
-25 °C ... 60 °C
100% operating factor
IEC 60664, EN 50178, IEC 62103
2 / III
any / can be aligned without spacing
5 mm / 28 mm / 15 mm

Technical data

①
0.8 -
1.2
10
5
3
6000
500
10

253 V AC
24 V AC
0.75 A (see derating curve)
10 mA
30 A (10 ms)
< 1 mA
0.5
2-wire floating, zero voltage switch
4.5 A²s
RCV circuit
< 1 V

Basic insulation
2.5 kV (50 Hz, 1 min.)
-25 °C ... 60 °C
100% operating factor
IEC 60664, EN 50178, IEC 62103
2 / III
any / can be aligned without spacing
5 mm / 28 mm / 15 mm

Ordering data

Type	Order No.	Pcs. / Pkt.
OPT-24DC/ 48DC/100	2966618	10

Ordering data

Type	Order No.	Pcs. / Pkt.
OPT-24DC/230AC/ 1	2967950	10



# Relay modules

## Industrial relay system with push-in connection - RIFLINE complete

### Modular RIF-1 relay base

- Relay base that can be fitted with 1 or 2 PDT relays or solid-state relays.
- Range of accessories includes:
- Plug-in input and interference suppression module
  - Plug-in timer module
  - Relay retaining bracket with ejector function and holder for marking material
  - Comprehensive range of marking material
  - Test plug
  - FBS 2-6 jumpers for the input side (A2)
  - FBS 2-8 jumpers for the output side (11/21)

Notes:
Type of insulating housing: Polyamide PA non-reinforced, color: gray.
For further marking systems and mounting material, see Catalog 5.

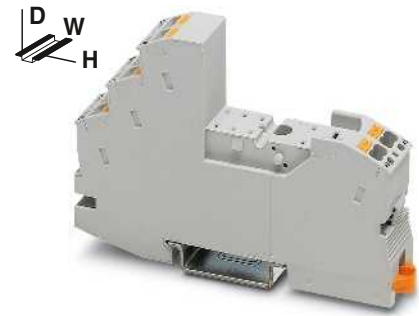

2 PDT relay base for miniature power relay



Nominal voltage  $U_N$   
Nominal current at  $U_N$

General data
Ambient temperature (operation)
Connection data solid / stranded / AWG
Dimensions
Width
Depth with retaining bracket
Height

Technical data
250 V AC/DC max. 13 A (depending on application/assembly)

-40 °C ... 85 °C (depending on application/assembly)
0.14 ... 1.5 mm <sup>2</sup> / 0.14 ... 1.5 mm <sup>2</sup> / 26 - 16
16 mm
75 mm
96 mm

Description
<b>RIF-1 relay base</b> , plug-in option for input/interference suppression module, safe isolation I/O with push-in connection
<b>Relay retaining bracket</b> , with ejector function and holder for marking material, suitable for RIF-1 relay base
- for 16 mm high miniature power and solid-state relays
- for 25 mm high miniature power relays
<b>Relay retaining bracket</b> , wire model, suitable for RIF-1 relay base
- for 16 mm high miniature power and solid-state relays
- for 25 mm high miniature power relays

Ordering data		
Type	Order No.	Pcs. / Pkt.
RIF-1-BPT/2X21	2900931	10

Jumper	
2-pos. red, 32 A	
2-pos. red, 24 A	
2-pos. red, 32 A	
2-pos. blue, 32 A	
2-pos. gray, 32 A	
2-pos. red, 41 A	
2-pos. blue, 41 A	
2-pos. gray, 41 A	
<b>End bracket</b> , for snapping onto NS 35, 9.5 mm wide, can be marked with ZB 6, ZB 8/27, KLM...	
<b>Test plug</b> , consisting of:	
<b>Metal part</b> for 2.3 mm Ø socket hole and	silver
<b>Insulating sleeve</b> , for MPS metal part	red white blue yellow green gray black
<b>Zack marker strip</b> , unprinted	
10-section	
5-section	
<b>Double marker carrier for ZB 5</b>	

Accessories		
FBS 2-6	3030336	50
FBSR 2-6	3033715	50
FBSR 2-8	3033808	10
FBS 2-6 BU	3036932	50
FBS 2-6 GY	3032237	50
FBS 2-8	3030284	10
FBS 2-8 BU	3032567	10
FBS 2-8 GY	3032541	10
	7042	
CLIPFIX 35	3022218	50
MPS-MT	0201744	10
MPS-IH RD	0201676	10
MPS-IH WH	0201663	10
MPS-IH BU	0201689	10
MPS-IH YE	0201692	10
MPS-IH GN	0201702	10
MPS-IH GY	0201728	10
MPS-IH BK	0201731	10
ZB 5 :UNBEDRUCKT	1050004	10
ZB 15:UNBEDRUCKT	0811972	10
STP 5-2	0800967	100



Relay retaining bracket



Relay retaining bracket

ERIC

Technical data			Technical data		
-			-		
-			-		
-			-		
-			-		
-			-		
-			-		
Ordering data			Ordering data		
Type	Order No.	Pcs. / Pkt.	Type	Order No.	Pcs. / Pkt.
RIF-RH-1	2900953	10			
RIF-RH-1-H	2904468	10			
			RIF-RHM-1	2905986	10
			RIF-RHM-1-H	2905985	10
Accessories			Accessories		

# Relay modules

## Industrial relay system with push-in connection - RIFLINE complete

### Plug-in miniature power relays

Plug-in miniature power relays with 1 or 2 PDT contacts, suitable for RIF-1, PR1, and PLC-INTERFACE relay bases.

The advantages:

- Power contacts up to 16 A
- Multi-layer gold contact or power contact
- High degree of protection up to RT III (comparable with IP67) depending on type



1 PDT relay



2 PDT relay

**Notes:**  
If the specified maximum values for multi-layer contact relays are exceeded, the gold plating is destroyed. The maximum values of the power contact relay are then valid. This can result in a shorter service life than with a pure power contact.

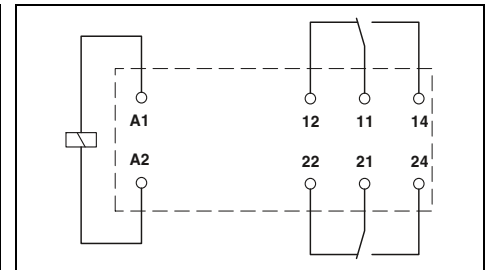
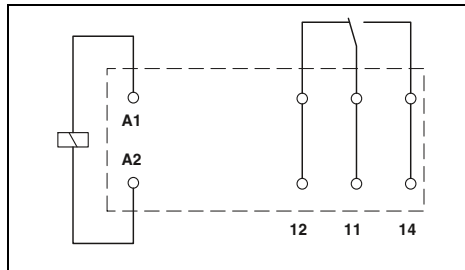

#### Technical data

Input data	①	②	③	④	⑤	⑥	⑦	⑧
Permissible range (with reference to $U_N$ )	see diagram							
Typ. input current at $U_N$ [mA]	33	17	8.7	8.2	4.1	32	7	3
Typ. response time at $U_N$ [ms]	7	7	7	7	7			
Typ. response time at $U_N$ (depending on phase relation) [ms]						3 - 12	3 - 12	3 - 12
Typ. release time at $U_N$ [ms]	3	3	3	3	3			
Typ. release time at $U_N$ (depending on phase relation) [ms]						2 - 9	2 - 9	2 - 9

①	②	③	④	⑤	⑥	⑦	⑧
see diagram							
33	17	8.7	8.2	4.1	32	7	3
7	7	7	7	7			
					3 - 12	3 - 12	3 - 12
3	3	3	3	3			
					2 - 9	2 - 9	2 - 9

#### Technical data

①	②	③	④	⑤	⑥	⑦	⑧
see diagram							
33	17	8.7	8.2	4.1	32	7	3
7	7	7	7	7			
					3 - 12	3 - 12	3 - 12
3	3	3	3	3			
					2 - 9	2 - 9	2 - 9

Output data
Contact type
Contact material
Max. switching voltage
Min. switching voltage
Limiting continuous current
Max. inrush current, AC
Max. inrush current, DC
Min. switching current
General data
Test voltage (winding/contact)
Test voltage (contact/contact)
Ambient temperature (operation), AC
Ambient temperature (operation), DC
Mechanical service life, AC
Mechanical service life, DC
Standards/regulations

1 PDT	1 PDT
AgNi	AgNi, hard gold-plated
250 V AC/DC	30 V AC / 36 V DC
12 V (at 10 mA)	100 mV (at 10 mA)
16 A	50 mA
25 A (20 ms)	50 mA
50 A (20 ms)	50 mA
10 mA (at 12 V)	1 mA (at 24 V)
5 kV AC (50 Hz, 1 min.)	
-	
-40 °C ... 85 °C	
-40 °C ... 85 °C	
1 x 10 <sup>7</sup> cycles	
3 x 10 <sup>7</sup> cycles	
IEC 60664, EN 50178, IEC 62103	

2 PDT	2 PDT
AgNi	AgNi, hard gold-plated
250 V AC/DC	30 V AC / 36 V DC
5 V (at 10 mA)	100 mV (at 10 mA)
8 A	50 mA
12 A (20 ms)	50 mA
25 A (20 ms)	50 mA
10 mA (at 5 V)	1 mA (at 24 V)
5 kV AC (50 Hz, 1 min.)	
2.5 kV AC (50 Hz, 1 min.)	
-40 °C ... 85 °C	
-40 °C ... 85 °C	
1 x 10 <sup>7</sup> cycles	
3 x 10 <sup>7</sup> cycles	
IEC 60664, EN 50178, IEC 62103	

#### Ordering data

Description	Input voltage $U_N$
<b>Plug-in miniature power relay</b>	
with power contacts	① 12 V DC
with power contacts	② 24 V DC
with power contacts	③ 48 V DC
with power contacts	④ 60 V DC
with power contacts	⑤ 110 V DC
with power contacts	⑥ 24 V AC
with power contacts	⑦ 120 V AC
with power contacts	⑧ 230 V AC
<b>Plug-in miniature power relay</b>	
with multi-layer gold contacts	① 12 V DC
with multi-layer gold contacts	② 24 V DC
with multi-layer gold contacts	③ 48 V DC
with multi-layer gold contacts	④ 60 V DC
with multi-layer gold contacts	⑤ 110 V DC
with multi-layer gold contacts	⑥ 24 V AC
with multi-layer gold contacts	⑦ 120 V AC
with multi-layer gold contacts	⑧ 230 V AC

Type	Order No.	Pcs. / Pkt.
REL-MR- 12DC/21HC	2961309	10
REL-MR- 24DC/21HC	2961312	10
REL-MR- 48DC/21HC	2834821	10
REL-MR- 60DC/21HC	2961325	10
REL-MR-110DC/21HC	2961338	10
REL-MR- 24AC/21HC	2961406	10
REL-MR-120AC/21HC	2961419	10
REL-MR-230AC/21HC	2961422	10
REL-MR- 12DC/21HC AU	2961532	10
REL-MR- 24DC/21HC AU	2961545	10
REL-MR-110DC/21HC AU	2961561	10
REL-MR- 24AC/21HC AU	2961503	10
REL-MR-120AC/21HC AU	2961516	10
REL-MR-230AC/21HC AU	2961529	10

#### Ordering data

Type	Order No.	Pcs. / Pkt.
REL-MR- 12DC/21-21	2961257	10
REL-MR- 24DC/21-21	2961192	10
REL-MR- 48DC/21-21	2834834	10
REL-MR- 60DC/21-21	2961273	10
REL-MR-110DC/21-21	2961202	10
REL-MR- 24AC/21-21	2961435	10
REL-MR-120AC/21-21	2961448	10
REL-MR-230AC/21-21	2961451	10
REL-MR- 12DC/21-21AU	2961299	10
REL-MR- 24DC/21-21AU	2961215	10
REL-MR- 48DC/21-21AU	2834847	10
REL-MR- 60DC/21-21AU	2961286	10
REL-MR-110DC/21-21AU	2961228	10
REL-MR- 24AC/21-21AU	2961464	10
REL-MR-120AC/21-21AU	2961477	10
REL-MR-230AC/21-21AU	2961480	10

### REL-MR...21HC... (1 PDT)

Operating voltage range

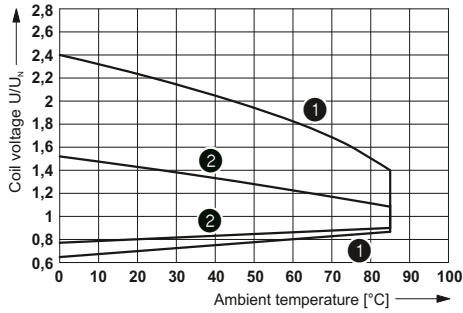

- 1 DC coils
- 2 AC coils

Interrupting rating

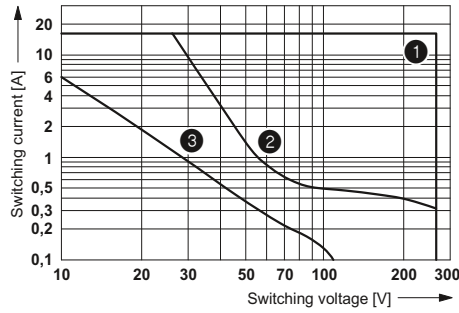

- 1 AC, ohmic load
- 2 DC, ohmic load
- 3 DC, L/R = 40 ms

Electrical service life

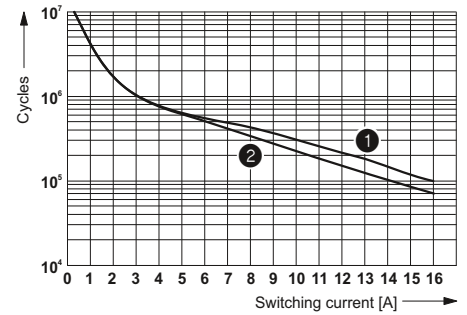

- 1 250 V AC, ohmic load (DC coils)
- 2 250 V AC, ohmic load (AC coils)

Service life reduction factor with various cos phi

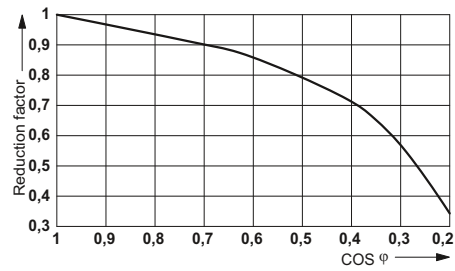

### REL-MR...21-21... (2 PDTs)

Operating voltage range

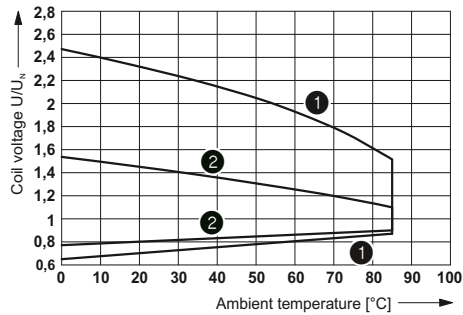

- 1 DC coils
- 2 AC coils

Interrupting rating

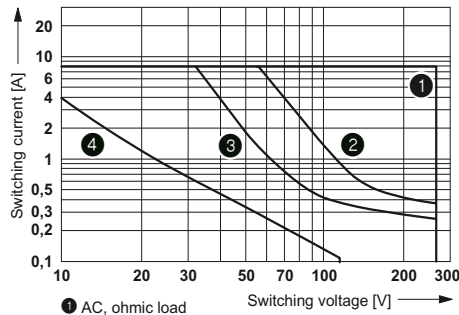

- 1 AC, ohmic load
- 2 DC, ohmic load, contacts in series
- 3 DC, ohmic load
- 4 DC, L/R = 40 ms

Electrical service life

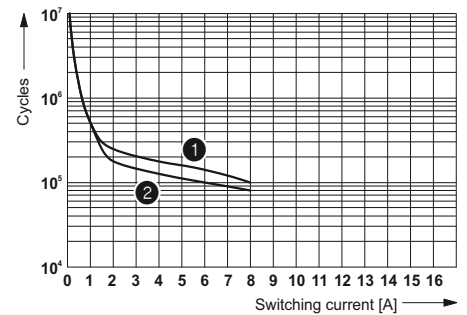

- 1 250 V AC, ohmic load (DC coils)
- 2 250 V AC, ohmic load (AC coils)

Service life reduction factor with various cos phi

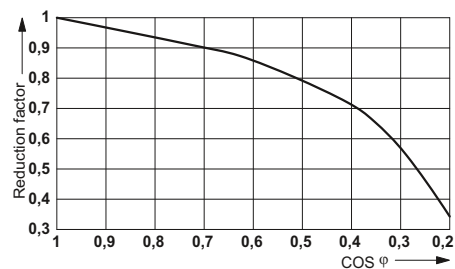

# Relay modules

## Industrial relay system with push-in connection - RIFLINE complete

### Plug-in miniature power relays

Plug-in miniature power relays with 1 or 2 PDT contacts, suitable for RIF-1 and PR1 relay bases.

The advantages:

- Switching current of up to 16 A
- With lockable manual operation
- Mechanical switch position indicator
- Integrated status LED
- Multi-layer gold contact or power contact
- DC types with integrated freewheeling diode
- Can be soldered in on PCB



1 PDT relay



2 PDT relay

**Notes:**

If the specified maximum values for multi-layer contact relays are exceeded, the gold plating is destroyed. The maximum values of the power contact relay are then valid. This can result in a shorter service life than with a pure power contact.

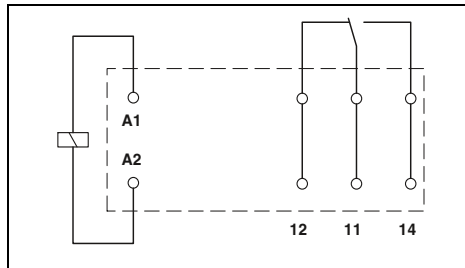

**Technical data**

	①	②	③	④
① see diagram	18	32	7	3.5
②	9			
③		3 - 12	3 - 12	
④	6			
⑤		2 - 8	2 - 8	2 - 8

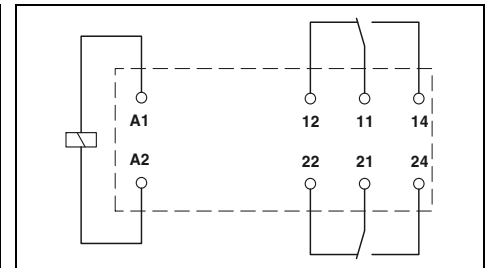

**Technical data**

	①	②	③	④
① see diagram	18	32	7	3.5
②	9			
③		3 - 12	3 - 12	3 - 12
④	6			
⑤		2 - 8	2 - 8	2 - 8

Input data	
Permissible range (with reference to U <sub>N</sub> )	
Typ. input current at U <sub>N</sub>	[mA]
Typ. response time at U <sub>N</sub>	[ms]
Typ. response time at U <sub>N</sub> (depending on phase relation)	[ms]
Typ. release time at U <sub>N</sub>	[ms]
Typ. release time at U <sub>N</sub> (depending on phase relation)	[ms]
Output data	
Contact type	1 PDT
Contact material	AgNi
Max. switching voltage	250 V AC/DC
Min. switching voltage	12 V (at 10 mA)
Limiting continuous current	16 A
Max. inrush current, AC	32 A (20 ms)
Max. inrush current, DC	32 A (20 ms)
Min. switching current	10 mA (at 12 V)
General data	
Test voltage (winding/contact)	5 kV AC (50 Hz, 1 min.)
Test voltage (contact/contact)	-
Ambient temperature (operation), AC	-40 °C ... 70 °C
Ambient temperature (operation), DC	-40 °C ... 70 °C
Mechanical service life, AC	5 x 10 <sup>6</sup> cycles
Mechanical service life, DC	5 x 10 <sup>6</sup> cycles
Standards/regulations	DIN EN 61810-1, VDE 0435-201, EN 50178, IEC 62103

Technical data	
Contact type	1 PDT
Contact material	AgNi, hard gold-plated
Max. switching voltage	30 V AC / 36 V DC
Min. switching voltage	12 V (at 1 mA)
Limiting continuous current	50 mA
Max. inrush current, AC	50 mA
Max. inrush current, DC	50 mA
Min. switching current	1 mA (at 12 V)
General data	
Test voltage (winding/contact)	5 kV AC (50 Hz, 1 min.)
Test voltage (contact/contact)	-
Ambient temperature (operation), AC	-40 °C ... 70 °C
Ambient temperature (operation), DC	-40 °C ... 70 °C
Mechanical service life, AC	5 x 10 <sup>6</sup> cycles
Mechanical service life, DC	5 x 10 <sup>6</sup> cycles
Standards/regulations	DIN EN 61810-1, VDE 0435-201, EN 50178, IEC 62103

Technical data	
Contact type	2 PDT
Contact material	AgNi, hard gold-plated
Max. switching voltage	250 V AC/DC
Min. switching voltage	12 V (at 10 mA)
Limiting continuous current	8 A
Max. inrush current, AC	16 A (20 ms)
Max. inrush current, DC	16 A (20 ms)
Min. switching current	10 mA (at 12 V)
General data	
Test voltage (winding/contact)	5 kV AC (50 Hz, 1 min.)
Test voltage (contact/contact)	2.5 kV AC (50 Hz, 1 min.)
Ambient temperature (operation), AC	-40 °C ... 70 °C
Ambient temperature (operation), DC	-40 °C ... 70 °C
Mechanical service life, AC	5 x 10 <sup>6</sup> cycles
Mechanical service life, DC	5 x 10 <sup>6</sup> cycles
Standards/regulations	DIN EN 61810-1, VDE 0435-201, EN 50178, IEC 62103

**Ordering data**

Description	Input voltage U <sub>N</sub>
<b>Plug-in miniature power relay, with power contacts</b>	
- Status LED, freewheeling diode A1+, A2-	① 24 V DC
- Status LED	② 24 V AC
- Status LED	③ 120 V AC
- Status LED	④ 230 V AC
<b>Plug-in miniature power relay, with multi-layer gold contacts, with manual operation, mechanical switch position indicator</b>	
- Status LED, freewheeling diode A1+, A2-	① 24 V DC
- Status LED	④ 230 V AC

**Ordering data**

Type	Order No.	Pcs. / Pkt.
REL-MR- 24DC/21HC/MS	2987888	10
REL-MR- 24AC/21HC/MS	2987891	10
REL-MR-120AC/21HC/MS	2987901	10
REL-MR-230AC/21HC/MS	2987914	10
REL-MR- 24DC/21HC AU/MS	2987927	10
REL-MR-230AC/21HC AU/MS	2987930	10

**Ordering data**

Type	Order No.	Pcs. / Pkt.
REL-MR- 24DC/21-21/MS	2987943	10
REL-MR- 24AC/21-21/MS	2987956	10
REL-MR-120AC/21-21/MS	2987969	10
REL-MR-230AC/21-21/MS	2987972	10
REL-MR- 24DC/21-21AU/MS	2987985	10
REL-MR-230AC/21-21AU/MS	2987998	10

### REL-MR...21HC...MS (1 PDT)

Operating voltage range

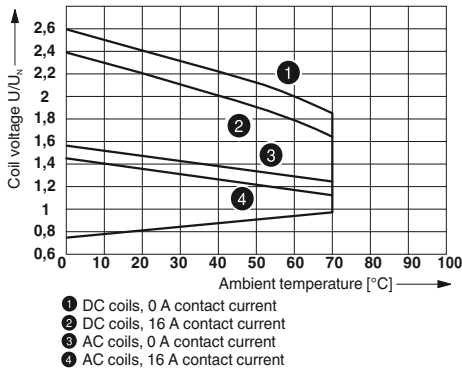

Interrupting rating

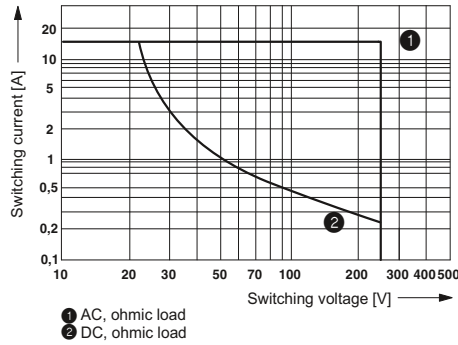

Electrical service life

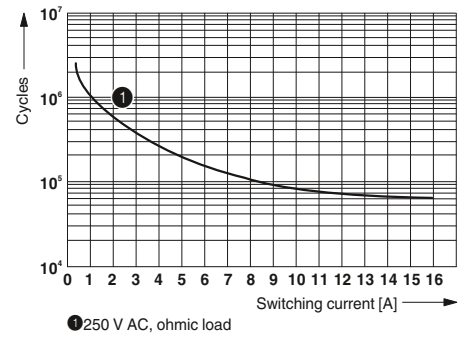

Service life reduction factor with various cos phi

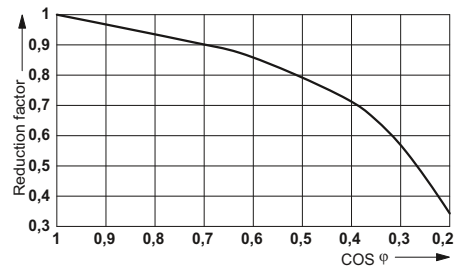

### REL-MR...21-21...MS (2 PDTs)

Operating voltage range

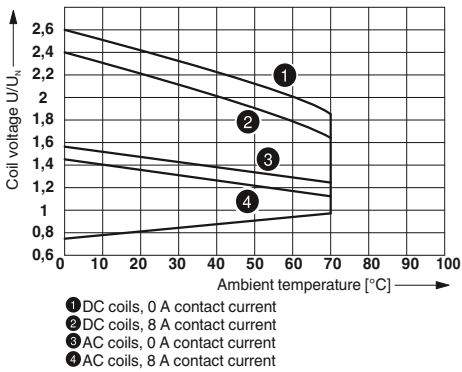

Interrupting rating

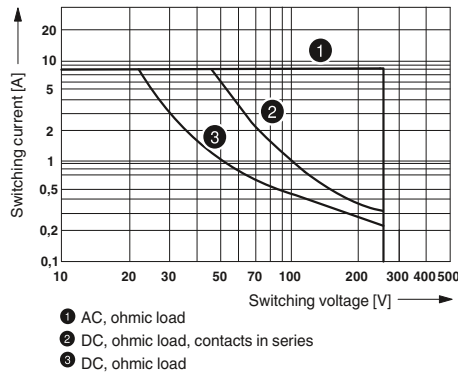

Electrical service life

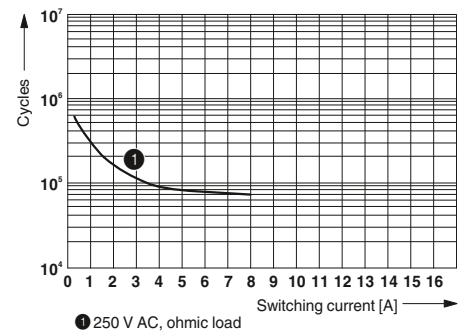

Service life reduction factor with various cos phi

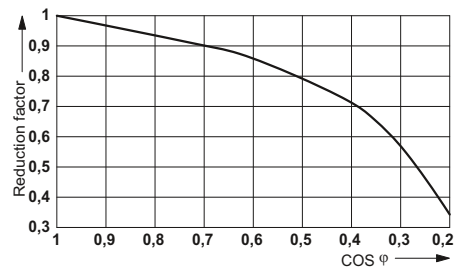



# Relay modules

## Industrial relay system with push-in connection - RIFLINE complete

### Plug-in solid-state relays

Plug-in solid-state relays suitable for RIF-1, PR1, and PLC-INTERFACE relay bases.

The advantages:

- Switching capacity of up to 24 V DC/5 A
- RT III wash tight (comparable to IP67)
- Vibration and shock-resistant
- Wear-free and long-lasting
- Zero voltage switch at AC output
- Can be soldered in on PCB

**Notes:**  
For dimensional drawings and perforations for assembly, see page 425



Max. DC voltage output of 5 A

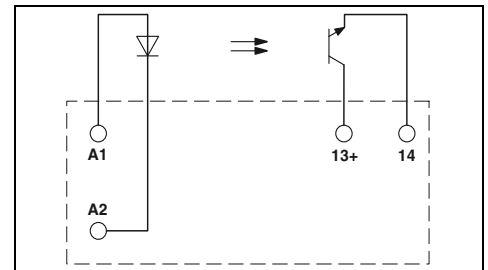

#### Technical data

Input data		①	②	③
Permissible range (with reference to $U_N$ )		0.8 - 1.2	0.8 - 1.2	0.9 - 1.1
Switching level	1 signal ("H") [V DC] $\geq$ 0 signal ("L") [V DC] $\leq$	2.5	16	35
Typ. input current at $U_N$	[mA]	9	7	3
Typ. switch-on time at $U_N$	[ $\mu$ s]	10	20	25
Typ. shutdown time at $U_N$	[ $\mu$ s]	400	400	400
Transmission frequency $f_{limit}$	[Hz]	300	300	300
Output data				
Max. switching voltage		33 V DC		
Min. switching voltage		3 V DC		
Limiting continuous current		5 A (see derating curve)		
Min. load current		-		
Max. inrush current		15 A (10 ms)		
Leakage current in off state		-		
Phase angle (cos $\phi$ )		-		
Output circuit		2-wire, floating		
Max. load value		-		
Output protection		Protection against polarity reversal, surge protection		
Voltage drop at max. limiting continuous current		$\leq$ 200 mV		
General data				
Rated surge voltage		Basic insulation		
Test voltage input/output		2.5 kV (50 Hz, 1 min.)		
Ambient temperature (operation)		-25 °C ... 60 °C		
Nominal operating mode		100% operating factor		
Standards/regulations		IEC 60664, EN 50178, IEC 62103		
Pollution degree / surge voltage category		2 / III		
Mounting position / mounting		any / can be aligned without spacing		
Dimensions	W / H / D	12.7 mm / 29 mm / 15.7 mm		

#### Ordering data

Description	Input voltage $U_N$	Type	Order No.	Pcs. / Pkt.
<b>Plug-in solid-state relay</b>				
Solid-state power relay	① 5 V DC	<b>OPT-5DC/ 24DC/ 5</b>	<b>2982113</b>	10
Solid-state power relay	② 24 V DC	<b>OPT-24DC/ 24DC/ 5</b>	<b>2982100</b>	10
Solid-state power relay	③ 60 V DC	<b>OPT-60DC/ 24DC/ 5</b>	<b>2982126</b>	10



Max. AC voltage output of 2 A

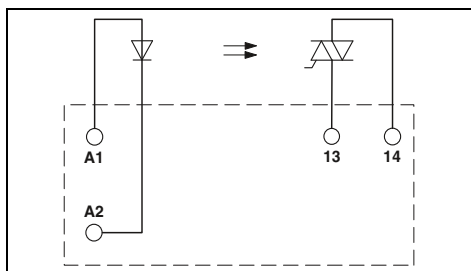

Technical data

①	②	③
0.8 -	0.8 -	0.9 -
1.2	1.2	1.1
3	18	40
1	8.4	20
15	7	2.6
10000	10000	10000
10000	10000	10000
10	10	10

253 V AC  
 24 V AC  
 2 A (see derating curve)  
 25 mA  
 30 A (10 ms)  
 < 1 mA  
 -  
 2-wire floating, zero voltage switch  
 4 A<sup>2</sup>s (tp = 10 ms, at 25 °C)  
 Surge protection  
 ≤ 1 V

Basic insulation  
 2.5 kV (50 Hz, 1 min.)  
 -25 °C ... 60 °C  
 100% operating factor  
 IEC 60664, EN 50178, IEC 62103  
 2 / III

any / see derating curve  
 12.7 mm / 29 mm / 15.7 mm

Ordering data

Type	Order No.	Pcs. / Pkt.
OPT-5DC/230AC/ 2	2982168	10
OPT-24DC/230AC/ 2	2982171	10
OPT-60DC/230AC/ 2	2982184	10

Derating curve for OPT...DC/24DC/5 solid-state relays

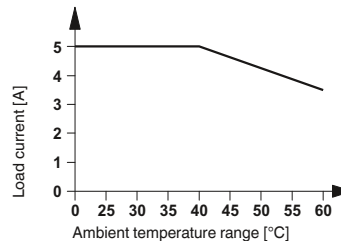

Derating curve for OPT...DC/230AC/2 solid-state relays

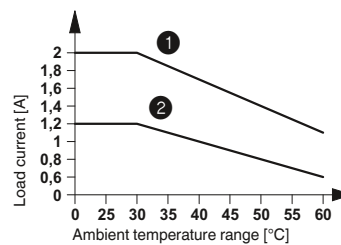

- ① Aligned with > 10 mm spacing
- ② Aligned without spacing

# Relay modules

## Industrial relay system with push-in connection - RIFLINE complete

### Modular RIF-2 relay base

Relay base that can be fitted with 2 or 4 PDT relays.

Range of accessories includes:

- Plug-in input and interference suppression module
- Plug-in timer module
- Relay retaining bracket with ejector function and holder for marking material
- Comprehensive range of marking material
- Test plug
- FBS 2-6 jumpers for the input side (A2)

Notes:
Type of insulating housing: Polyamide PA non-reinforced, color: gray.
For further marking systems and mounting material, see Catalog 5.



4 PDT relay base for industrial relay



Nominal voltage  $U_N$   
Nominal current at  $U_N$

General data
Ambient temperature (operation)
Connection data solid / stranded / AWG
Dimensions
Width
Depth with retaining bracket
Height

Technical data
250 V AC/DC max. 12 A (depending on application/assembly)

-40 °C ... 85 °C (depending on application/assembly)
0.14 ... 1.5 mm <sup>2</sup> / 0.14 ... 1.5 mm <sup>2</sup> / 26 - 16
31 mm
75 mm
96 mm

Description
<b>RIF-2 relay base</b> , plug-in option for input/interference suppression module, safe isolation I/O with push-in connection
<b>Relay retaining bracket</b> , with ejector function and holder for marking material, suitable for RIF-2 relay base
<b>Relay retaining bracket</b> , wire model, suitable for RIF-2 relay base

Ordering data		
Type	Order No.	Pcs. / Pkt.
RIF-2-BPT/4X21	2900934	10

<b>Jumper</b> 2-pos. red, 32 A 2-pos. red, 24 A 2-pos. blue, 32 A 2-pos. gray, 32 A <b>End bracket</b> , for snapping onto NS 35, 9.5 mm wide, can be marked with ZB 6, ZB 8/27, KLM...	
<b>Test plug</b> , consisting of: <b>Metal part</b> for 2.3 mm Ø socket hole and <b>Insulating sleeve</b> , for MPS metal part	silver red white blue yellow green gray black
<b>Zack marker strip, unprinted</b> 10-section 5-section <b>Double marker carrier for ZB 5</b>	

Accessories		
Type	Order No.	Pcs. / Pkt.
FBS 2-6	3030336	50
FBSR 2-6	3033715	50
FBS 2-6 BU	3036932	50
FBS 2-6 GY	3032237	50
CLIPFIX 35	3022218	50
MPS-MT	0201744	10
MPS-IH RD	0201676	10
MPS-IH WH	0201663	10
MPS-IH BU	0201689	10
MPS-IH YE	0201692	10
MPS-IH GN	0201702	10
MPS-IH GY	0201728	10
MPS-IH BK	0201731	10
ZB 5 :UNBEDRUCKT	1050004	10
ZB 15:UNBEDRUCKT	0811972	10
STP 5-2	0800967	100



Relay retaining bracket



Relay retaining bracket

ERIC

Technical data			Technical data		
-			-		
-			-		
-			-		
-			-		
-			-		
-			-		
-			-		
Ordering data			Ordering data		
Type	Order No.	Pcs. / Pkt.	Type	Order No.	Pcs. / Pkt.
RIF-RH-2	2900954	10			
			RIF-RHM-2	2905984	10
Accessories			Accessories		

# Relay modules

## Industrial relay system with push-in connection - RIFLINE complete

### Plug-in industrial relays

Plug-in industrial relays with 2 or 4 PDT contacts, suitable for RIF-2 and PR2 relay bases.

The advantages:

- With detectable manual operation
- Mechanical switch position indicator
- Integrated status LED
- Multi-layer gold contact or power contact
- DC types with integrated freewheeling diode



2 PDT relay



4 PDT relay

**Notes:**  
For other voltages, see [phoenixcontact.net/products](http://phoenixcontact.net/products)

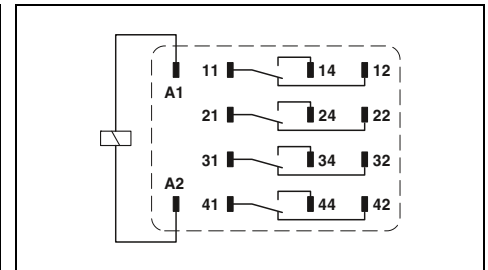
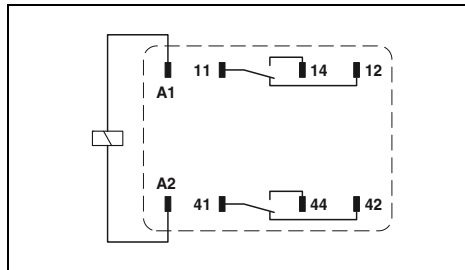

		Technical data							
		①	②	③	④	⑤	⑥	⑦	⑧
Input data		see diagram							
Permissible range (with reference to $U_N$ )		78	42	8	7.7	4	66	13	6.5
Typ. input current at $U_N$	[mA]	13	13	13	13	13			
Typ. response time at $U_N$	[ms]						5 - 15	5 - 15	5 - 15
Typ. response time at $U_N$ (depending on phase relation)	[ms]								
Typ. release time at $U_N$	[ms]	14	14	14	14	14			
Typ. release time at $U_N$ (depending on phase relation)	[ms]						5 - 20	5 - 20	5 - 20
Output data									
Contact type		2 PDT				4 PDTs			
Contact material		AgNi				AgNi, hard gold-plated			
Max. switching voltage		250 V AC/DC				250 V AC/DC			
Min. switching voltage		5 V (at 24 mA)				5 V (at 24 mA)			
Limiting continuous current		12 A				6 A			
Max. inrush current, AC		30 A (20 ms, N/O contact)				16 A (20 ms, N/O contact)			
Max. inrush current, DC		30 A (20 ms, N/O contact)				16 A (20 ms, N/O contact)			
Min. switching current		5 mA (at 24 V)				5 mA (at 24 V)			
General data									
Test voltage (winding/contact)		2.5 kV <sub>rms</sub> (50 Hz, 1 min.)							
Ambient temperature (operation), AC		-40 °C ... 55 °C							
Ambient temperature (operation), DC		-40 °C ... 70 °C							
Mechanical service life, AC		Approx. 2 x 10 <sup>7</sup> cycles							
Mechanical service life, DC		Approx. 2 x 10 <sup>7</sup> cycles							
Standards/regulations		IEC 60664							

		Technical data							
		①	②	③	④	⑤	⑥	⑦	⑧
Input data		see diagram							
Permissible range (with reference to $U_N$ )		78	42	8	7.7	4	66	13	6.5
Typ. input current at $U_N$	[mA]	13	13	13	13	13			
Typ. response time at $U_N$	[ms]						5 - 15	5 - 15	5 - 15
Typ. response time at $U_N$ (depending on phase relation)	[ms]								
Typ. release time at $U_N$	[ms]	14	14	14	14	14			
Typ. release time at $U_N$ (depending on phase relation)	[ms]						5 - 20	5 - 20	5 - 20
Output data									
Contact type		2 PDT				4 PDTs			
Contact material		AgNi				AgNi, hard gold-plated			
Max. switching voltage		250 V AC/DC				250 V AC/DC			
Min. switching voltage		5 V (at 24 mA)				5 V (at 24 mA)			
Limiting continuous current		12 A				6 A			
Max. inrush current, AC		30 A (20 ms, N/O contact)				16 A (20 ms, N/O contact)			
Max. inrush current, DC		30 A (20 ms, N/O contact)				16 A (20 ms, N/O contact)			
Min. switching current		5 mA (at 24 V)				5 mA (at 24 V)			
General data									
Test voltage (winding/contact)		2.5 kV <sub>rms</sub> (50 Hz, 1 min.)							
Ambient temperature (operation), AC		-40 °C ... 55 °C							
Ambient temperature (operation), DC		-40 °C ... 70 °C							
Mechanical service life, AC		Approx. 2 x 10 <sup>7</sup> cycles							
Mechanical service life, DC		Approx. 2 x 10 <sup>7</sup> cycles							
Standards/regulations		IEC 60664							

		Ordering data		
Description	Input voltage $U_N$	Type	Order No.	Pcs. / Pkt.
<b>Plug-in industrial relay, with power contacts</b>				
With freewheeling diode	① 12 V DC	REL-IR2/LDP- 12DC/2X21	2903659	10
With freewheeling diode	② 24 V DC	REL-IR2/LDP- 24DC/2X21	2903660	10
With freewheeling diode	③ 110 V DC	REL-IR2/LDP-110DC/2X21	2903663	10
With freewheeling diode	④ 125 V DC	REL-IR2/LDP-125DC/2X21	2903664	10
With freewheeling diode	⑤ 220 V DC	REL-IR2/LDP-220DC/2X21	2903665	10
With freewheeling diode	⑥ 24 V AC	REL-IR2/L- 24AC/2X21	2903666	10
With freewheeling diode	⑦ 120 V AC	REL-IR2/L-120AC/2X21	2903667	10
With freewheeling diode	⑧ 230 V AC	REL-IR2/L-230AC/2X21	2903668	10
<b>Plug-in industrial relay, with multi-layer gold contacts</b>				
With freewheeling diode	① 12 V DC	REL-IR4/LDP- 12DC/4X21AU	2903669	10
With freewheeling diode	② 24 V DC	REL-IR4/LDP- 24DC/4X21AU	2903670	10
With freewheeling diode	③ 110 V DC	REL-IR4/LDP-110DC/4X21AU	2903673	10
With freewheeling diode	④ 125 V DC	REL-IR4/LDP-125DC/4X21AU	2903674	10
With freewheeling diode	⑤ 220 V DC	REL-IR4/LDP-220DC/4X21AU	2903675	10
With freewheeling diode	⑥ 24 V AC	REL-IR4/L- 24AC/4X21AU	2903683	10
With freewheeling diode	⑦ 120 V AC	REL-IR4/L-120AC/4X21AU	2903684	10
With freewheeling diode	⑧ 230 V AC	REL-IR4/L-230AC/4X21AU	2903685	10

		Ordering data		
Description	Input voltage $U_N$	Type	Order No.	Pcs. / Pkt.
<b>Plug-in industrial relay, with power contacts</b>				
With freewheeling diode	① 12 V DC	REL-IR4/LDP- 12DC/4X21	2903676	10
With freewheeling diode	② 24 V DC	REL-IR4/LDP- 24DC/4X21	2903677	10
With freewheeling diode	③ 110 V DC	REL-IR4/LDP-110DC/4X21	2903680	10
With freewheeling diode	④ 125 V DC	REL-IR4/LDP-125DC/4X21	2903681	10
With freewheeling diode	⑤ 220 V DC	REL-IR4/LDP-220DC/4X21	2903682	10
With freewheeling diode	⑥ 24 V AC	REL-IR4/L- 24AC/4X21	2903686	10
With freewheeling diode	⑦ 120 V AC	REL-IR4/L-120AC/4X21	2903687	10
With freewheeling diode	⑧ 230 V AC	REL-IR4/L-230AC/4X21	2903688	10
<b>Plug-in industrial relay, with multi-layer gold contacts</b>				
With freewheeling diode	① 12 V DC	REL-IR4/LDP- 12DC/4X21AU	2903669	10
With freewheeling diode	② 24 V DC	REL-IR4/LDP- 24DC/4X21AU	2903670	10
With freewheeling diode	③ 110 V DC	REL-IR4/LDP-110DC/4X21AU	2903673	10
With freewheeling diode	④ 125 V DC	REL-IR4/LDP-125DC/4X21AU	2903674	10
With freewheeling diode	⑤ 220 V DC	REL-IR4/LDP-220DC/4X21AU	2903675	10
With freewheeling diode	⑥ 24 V AC	REL-IR4/L- 24AC/4X21AU	2903683	10
With freewheeling diode	⑦ 120 V AC	REL-IR4/L-120AC/4X21AU	2903684	10
With freewheeling diode	⑧ 230 V AC	REL-IR4/L-230AC/4X21AU	2903685	10

		Ordering data		
Description	Input voltage $U_N$	Type	Order No.	Pcs. / Pkt.
<b>Plug-in industrial relay, with power contacts</b>				
With freewheeling diode	① 12 V DC	REL-IR4/LDP- 12DC/4X21	2903676	10
With freewheeling diode	② 24 V DC	REL-IR4/LDP- 24DC/4X21	2903677	10
With freewheeling diode	③ 110 V DC	REL-IR4/LDP-110DC/4X21	2903680	10
With freewheeling diode	④ 125 V DC	REL-IR4/LDP-125DC/4X21	2903681	10
With freewheeling diode	⑤ 220 V DC	REL-IR4/LDP-220DC/4X21	2903682	10
With freewheeling diode	⑥ 24 V AC	REL-IR4/L- 24AC/4X21	2903686	10
With freewheeling diode	⑦ 120 V AC	REL-IR4/L-120AC/4X21	2903687	10
With freewheeling diode	⑧ 230 V AC	REL-IR4/L-230AC/4X21	2903688	10
<b>Plug-in industrial relay, with multi-layer gold contacts</b>				
With freewheeling diode	① 12 V DC	REL-IR4/LDP- 12DC/4X21AU	2903669	10
With freewheeling diode	② 24 V DC	REL-IR4/LDP- 24DC/4X21AU	2903670	10
With freewheeling diode	③ 110 V DC	REL-IR4/LDP-110DC/4X21AU	2903673	10
With freewheeling diode	④ 125 V DC	REL-IR4/LDP-125DC/4X21AU	2903674	10
With freewheeling diode	⑤ 220 V DC	REL-IR4/LDP-220DC/4X21AU	2903675	10
With freewheeling diode	⑥ 24 V AC	REL-IR4/L- 24AC/4X21AU	2903683	10
With freewheeling diode	⑦ 120 V AC	REL-IR4/L-120AC/4X21AU	2903684	10
With freewheeling diode	⑧ 230 V AC	REL-IR4/L-230AC/4X21AU	2903685	10

### REL-IR2... (2 PDTs)

Operating voltage range

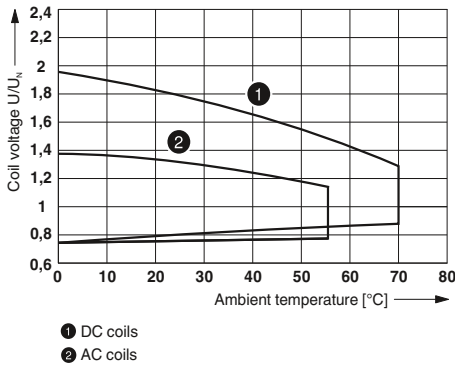

Interrupting rating

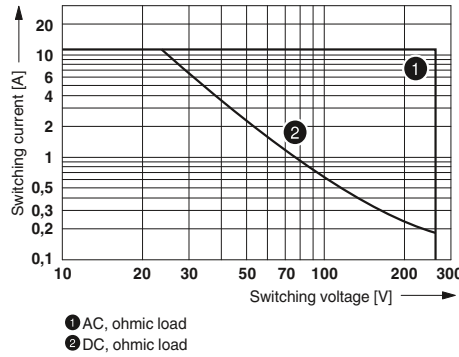

Electrical service life

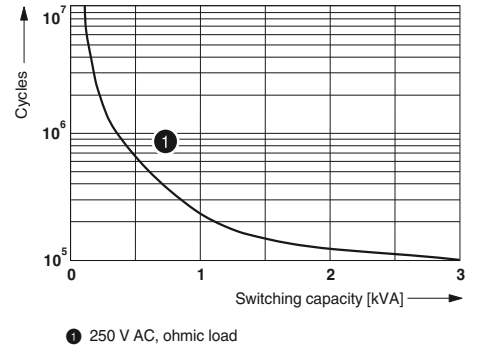

Service life reduction factor

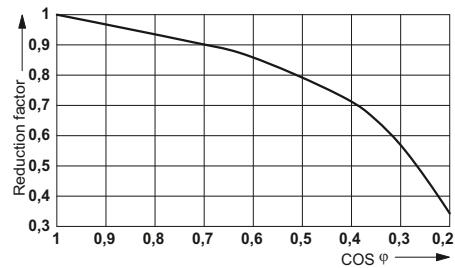

### REL-IR4... (4 PDTs)

Operating voltage range

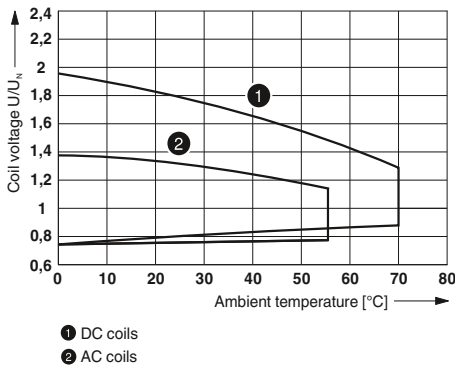

Interrupting rating

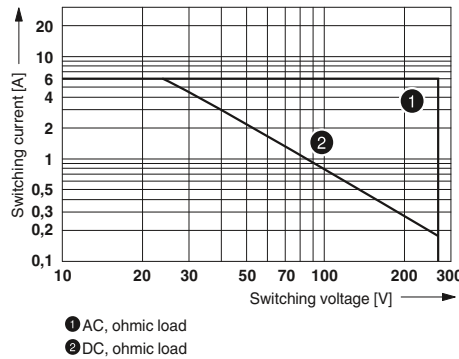

Electrical service life

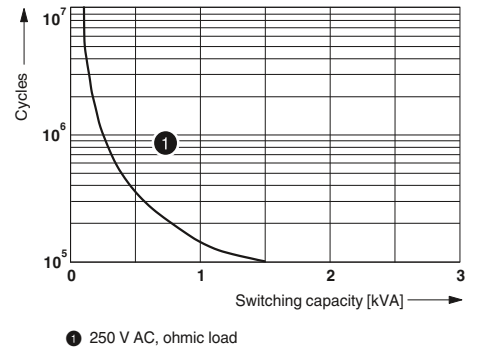

Service life reduction factor

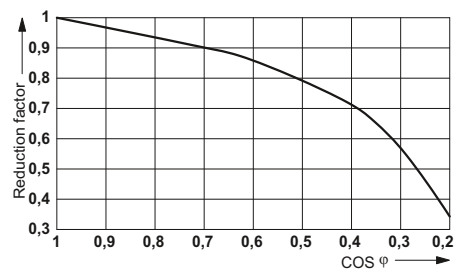



# Relay modules

## Industrial relay system with push-in connection - RIFLINE complete

### Modular RIF-3 relay base

Relay base that can be fitted with 2 or 3 PDT relays.

Range of accessories includes:

- Plug-in input and interference suppression module
- Plug-in timer module
- Relay retaining bracket with ejector function and holder for marking material
- Comprehensive range of marking material
- Test plug
- FBS 2-6 jumpers for the input side (A2)

Notes:
Type of insulating housing: Polyamide PA non-reinforced, color: gray.
For further marking systems and mounting material, see Catalog 5.



2 PDT relay base for octal relay



Nominal voltage  $U_N$   
Nominal current at  $U_N$

General data
Ambient temperature (operation)
Connection data solid / stranded / AWG
Dimensions
Width
Depth with retaining bracket
Height

Technical data
250 V AC/DC max. 12 A (depending on application/assembly)

-40 °C ... 85 °C (depending on application/assembly)
0.14 ... 1.5 mm <sup>2</sup> / 0.14 ... 1.5 mm <sup>2</sup> / 26 - 16
40 mm
90 mm
103 mm

Description
<b>RIF-3 relay base</b> , 2 PDT version, plug-in option for input/interference suppression module, safe isolation I/O with push-in connection
<b>RIF-3 relay base</b> , 3 PDT version, plug-in option for input/interference suppression module, safe isolation I/O with push-in connection
<b>Relay retaining bracket</b> , with holder for marking material, suitable for RIF-3 relay base
<b>Relay retaining bracket</b> , wire model, suitable for RIF-3 and PR3 relay base

Ordering data		
Type	Order No.	Pcs. / Pkt.
RIF-3-BPT/2X21	2900937	10

<b>Jumper</b> 2-pos. red, 32 A 2-pos. red, 24 A 2-pos. blue, 32 A 2-pos. gray, 32 A	
<b>End bracket</b> , for snapping onto NS 35, 9.5 mm wide, can be marked with ZB 6, ZB 8/27, KLM...	
<b>Test plug</b> , consisting of: <b>Metal part</b> for 2.3 mm Ø socket hole and	silver
<b>Insulating sleeve</b> , for MPS metal part	red white blue yellow green gray black
<b>Zack marker strip, unprinted</b> 10-section 5-section	
<b>Double marker carrier for ZB 5</b>	

Accessories		
FBS 2-6	3030336	50
FBSR 2-6	3033715	50
FBS 2-6 BU	3036932	50
FBS 2-6 GY	3032237	50
CLIPFIX 35	3022218	50
MPS-MT	0201744	10
MPS-IH RD	0201676	10
MPS-IH WH	0201663	10
MPS-IH BU	0201689	10
MPS-IH YE	0201692	10
MPS-IH GN	0201702	10
MPS-IH GY	0201728	10
MPS-IH BK	0201731	10
ZB 5 :UNBEDRUCKT	1050004	10
ZB 15:UNBEDRUCKT	0811972	10
STP 5-2	0800967	100

Industrial relay system with push-in connection - RIFLINE complete



3 PDT relay base for octal relay



Relay retaining bracket

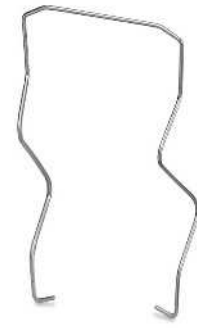

Relay retaining bracket



Technical data			Technical data			Technical data		
250 V AC/DC max. 12 A (depending on application/assembly)			-			-		
-40 °C ... 85 °C (depending on application/assembly)			-			-		
0.14 ... 1.5 mm <sup>2</sup> / 0.14 ... 1.5 mm <sup>2</sup> / 26 - 16			-			-		
40 mm			-			-		
90 mm			-			-		
103 mm			-			-		
Ordering data			Ordering data			Ordering data		
Type	Order No.	Pcs. / Pkt.	Type	Order No.	Pcs. / Pkt.	Type	Order No.	Pcs. / Pkt.
RIF-3-BPT/3X21	2900938	10						
			RIF-RH-3	2900955	10			
						EL3-M52	2833628	10
Accessories			Accessories			Accessories		
FBS 2-6	3030336	50						
FBSR 2-6	3033715	50						
FBS 2-6 BU	3036932	50						
FBS 2-6 GY	3032237	50						
CLIPFIX 35	3022218	50						
MPS-MT	0201744	10						
MPS-IH RD	0201676	10						
MPS-IH WH	0201663	10						
MPS-IH BU	0201689	10						
MPS-IH YE	0201692	10						
MPS-IH GN	0201702	10						
MPS-IH GY	0201728	10						
MPS-IH BK	0201731	10						
ZB 5 :UNBEDRUCKT	1050004	10						
ZB 15:UNBEDRUCKT	0811972	10						
STP 5-2	0800967	100						

# Relay modules

## Industrial relay system with push-in connection - RIFLINE complete

### Plug-in octal relays

Plug-in octal relays with 2 or 3 PDT contacts, suitable for RIF-3 and PR3 relay bases.

The advantages:

- With detectable manual operation
- Mechanical switch position indicator
- Integrated status LED
- DC types with integrated freewheeling diode



2 PDT relay



3 PDT relay

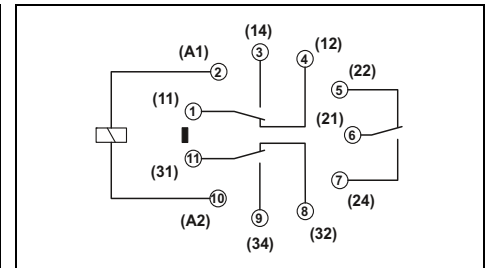
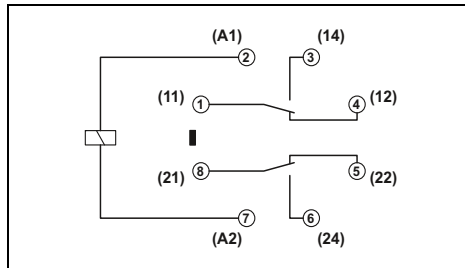

#### Technical data

#### Technical data

Input data	①	②	③	④	
Permissible range (with reference to $U_N$ )	see diagram				
Typ. input current at $U_N$	[mA]	60	108	23	13
Typ. response time at $U_N$	[ms]	18			
Typ. response time at $U_N$ (depending on phase relation)	[ms]	5 - 15		5 - 15	
Typ. release time at $U_N$	[ms]	5 - 20			
Typ. release time at $U_N$ (depending on phase relation)	[ms]	5 - 20		5 - 20	

Input data	①	②	③	④	
Permissible range (with reference to $U_N$ )	see diagram				
Typ. input current at $U_N$	[mA]	60	108	23	13
Typ. response time at $U_N$	[ms]	18			
Typ. response time at $U_N$ (depending on phase relation)	[ms]	5 - 15		5 - 15	
Typ. release time at $U_N$	[ms]	5 - 20			
Typ. release time at $U_N$ (depending on phase relation)	[ms]	5 - 20		5 - 20	

Output data	
Contact type	2 PDTs
Contact material	AgNi
Max. switching voltage	250 V AC/DC
Min. switching voltage	10 V (at 24 mA)
Limiting continuous current	10 A
Max. inrush current, AC	30 A (20 ms, N/O contact)
Max. inrush current, DC	30 A (20 ms, N/O contact)
Min. switching current	10 mA (at 24 V)
General data	
Test voltage (winding/contact)	2.5 kV <sub>rms</sub> (50 Hz, 1 min.)
Ambient temperature (operation), AC	-40 °C ... 55 °C
Ambient temperature (operation), DC	-40 °C ... 70 °C
Nominal operating mode	100% operating factor
Mechanical service life, AC	Approx. 2 x 10 <sup>7</sup> cycles
Mechanical service life, DC	Approx. 2 x 10 <sup>7</sup> cycles
Standards/regulations	IEC 60664
Mounting position / mounting	any
Dimensions	W / H / D 35 mm / 54.4 mm / 35 mm

Output data	
Contact type	3 PDTs
Contact material	AgNi
Max. switching voltage	250 V AC/DC
Min. switching voltage	10 V (at 24 mA)
Limiting continuous current	10 A
Max. inrush current, AC	30 A (20 ms, N/O contact)
Max. inrush current, DC	30 A (20 ms, N/O contact)
Min. switching current	10 mA (at 24 V)
General data	
Test voltage (winding/contact)	2.5 kV <sub>rms</sub> (50 Hz, 1 min.)
Ambient temperature (operation), AC	-40 °C ... 55 °C
Ambient temperature (operation), DC	-40 °C ... 70 °C
Nominal operating mode	100% operating factor
Mechanical service life, AC	Approx. 2 x 10 <sup>7</sup> cycles
Mechanical service life, DC	Approx. 2 x 10 <sup>7</sup> cycles
Standards/regulations	IEC 60664
Mounting position / mounting	any
Dimensions	W / H / D 35 mm / 54.4 mm / 35 mm

#### Ordering data

#### Ordering data

Description	Input voltage $U_N$	Type	Order No.	Pcs. / Pkt.
<b>Plug-in octal relay, with power contacts</b>				
With freewheeling diode	① 24 V DC	REL-OR2/LDP- 24DC/2X21	2903689	10
	② 24 V AC	REL-OR2/L- 24AC/2X21	2903690	10
	③ 120 V AC	REL-OR2/L-120AC/2X21	2903691	10
	④ 230 V AC	REL-OR2/L-230AC/2X21	2903692	10

Description	Input voltage $U_N$	Type	Order No.	Pcs. / Pkt.
<b>Plug-in octal relay, with power contacts</b>				
	① 24 V DC	REL-OR3/LDP-24DC/3X21	2903693	10
	② 24 V AC	REL-OR3/L- 24AC/3X21	2903694	10
	③ 120 V AC	REL-OR3/L-120AC/3X21	2903695	10
	④ 230 V AC	REL-OR3/L-230AC/3X21	2903696	10

### REL-OR2... (2 PDTs)

Operating voltage range

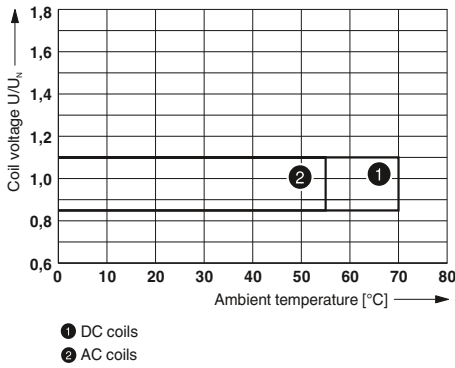

Interrupting rating

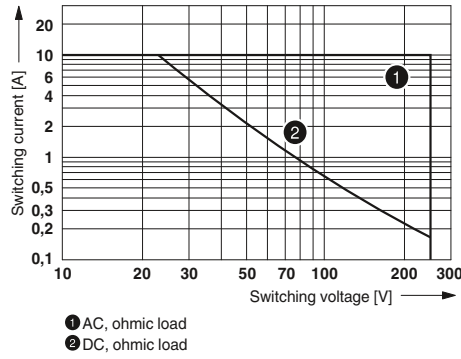

Electrical service life

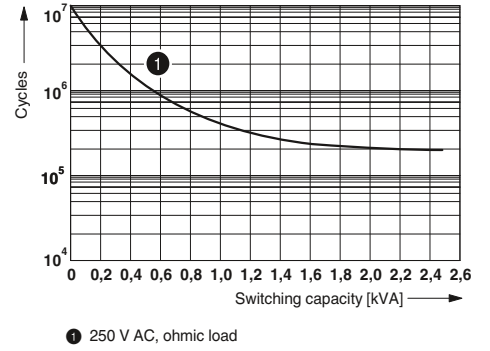

Service life reduction factor

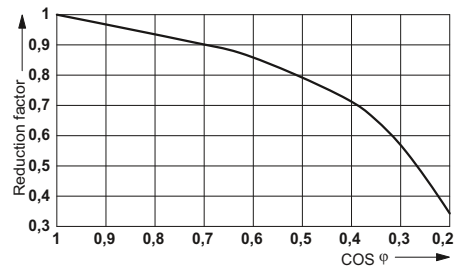

### REL-OR3... (3 PDTs)

Operating voltage range

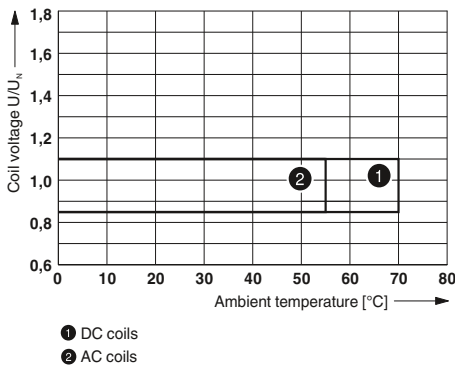

Interrupting rating

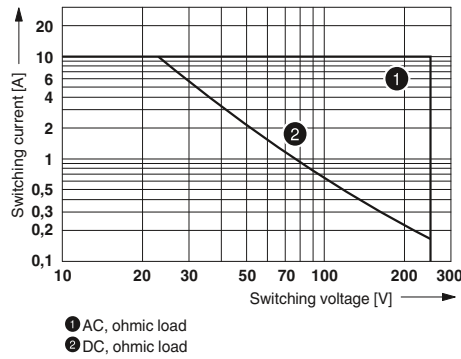

Electrical service life

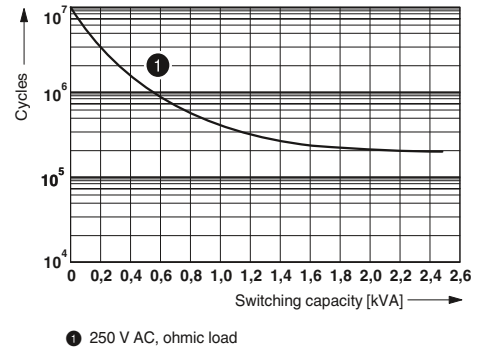

Service life reduction factor

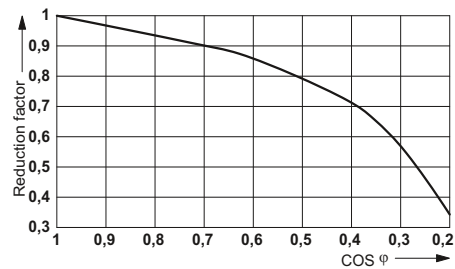

# Relay modules

## Industrial relay system with push-in connection - RIFLINE complete

### Modular RIF-4 relay base

Relay base that can be fitted with 2 or 3 PDT relays or 3 N/O relays.

Range of accessories includes:

- Plug-in input and interference suppression module
- Plug-in timer module
- Relay retaining bracket with ejector function and holder for marking material
- Comprehensive range of marking material
- Test plug
- FBS 2-6 jumpers for the input side (A2)

Notes:
Type of insulating housing: Polyamide PA non-reinforced, color: gray.
For further marking systems and mounting material, see Catalog 5.

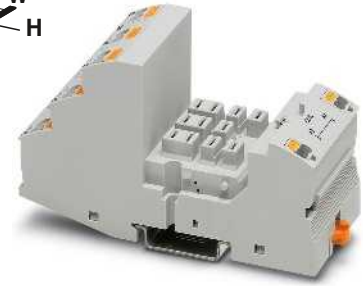

3 PDT relay base for high-power relay



Nominal voltage  $U_N$   
Nominal current at  $U_N$

General data
Ambient temperature (operation)
Connection data solid / stranded / AWG
Input side
Output side
Dimensions
Width
Depth with retaining bracket
Height

### Technical data

440 V AC  
max. 16 A (depending on application/assembly)

-40 °C ... 85 °C (depending on application/assembly)

0.14 ... 1.5 mm<sup>2</sup> / 0.14 ... 1.5 mm<sup>2</sup> / 26 - 16  
0.14 ... 2.5 mm<sup>2</sup> / 0.14 ... 2.5 mm<sup>2</sup> / 26 - 14

43 mm  
90 mm  
111 mm

Description
<b>RIF-4 relay base</b> , plug-in option for input/interference suppression module, safe isolation I/O with push-in connection
<b>Relay retaining bracket</b> , with holder for marking material, suitable for RIF-4 relay base
<b>Relay retaining bracket</b> , wire model, suitable for RIF-4 relay base

### Ordering data

Type	Order No.	Pcs. / Pkt.
RIF-4-BPT/3X21	2900961	10

<b>Jumper</b>	
2-pos. red, 32 A	
2-pos. red, 24 A	
2-pos. blue, 32 A	
2-pos. gray, 32 A	
<b>End bracket</b> , for snapping onto NS 35, 9.5 mm wide, can be marked with ZB 6, ZB 8/27, KLM...	
<b>Test plug</b> , consisting of:	
<b>Metal part</b> for 2.3 mm Ø socket hole and	silver
<b>Insulating sleeve</b> , for MPS metal part	red white blue yellow green gray black
<b>Zack marker strip</b> , unprinted	
10-section	
5-section	
<b>Double marker carrier for ZB 5</b>	

### Accessories

FBS 2-6	3030336	50
FBSR 2-6	3033715	50
FBS 2-6 BU	3036932	50
FBS 2-6 GY	3032237	50
CLIPFIX 35	3022218	50
MPS-MT	0201744	10
MPS-IH RD	0201676	10
MPS-IH WH	0201663	10
MPS-IH BU	0201689	10
MPS-IH YE	0201692	10
MPS-IH GN	0201702	10
MPS-IH GY	0201728	10
MPS-IH BK	0201731	10
ZB 5 :UNBEDRUCKT	1050004	10
ZB 15:UNBEDRUCKT	0811972	10
STP 5-2	0800967	100



Relay retaining bracket



Relay retaining bracket

ERIC

Technical data			Technical data		
-			-		
-			-		
-			-		
-			-		
-			-		
-			-		
-			-		
-			-		
Ordering data			Ordering data		
Type	Order No.	Pcs. / Pkt.	Type	Order No.	Pcs. / Pkt.
RIF-RH-4	2900956	10			
			RIF-RHM-4	2905983	10
Accessories			Accessories		



# Relay modules

## Industrial relay system with push-in connection - RIFLINE complete

### Plug-in high-power relays

Plug-in high-power relays with 2 or 3 PDT contacts for the RIF-4 relay base.

The advantages:

- Use in miniature contactor applications
- Switching current of up to 16 A
- Up to 440 V AC switching voltage



2 PDT relay



3 PDT relay

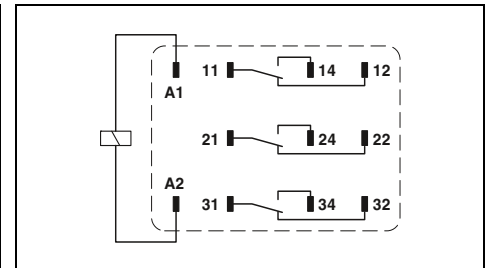
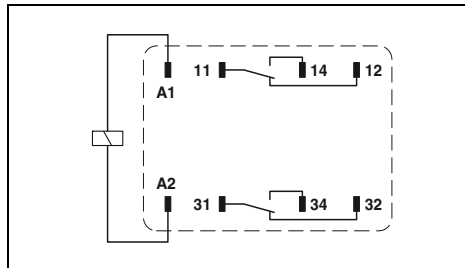

#### Technical data

Input data	①	②	③	④	
Permissible range (with reference to $U_N$ )	see diagram				
Typ. input current at $U_N$	[mA]	56	116	23	12
Typ. response time at $U_N$	[ms]	20			
Typ. response time at $U_N$ (depending on phase relation)	[ms]	5 - 25		5 - 25	
Typ. release time at $U_N$	[ms]	15			
Typ. release time at $U_N$ (depending on phase relation)	[ms]	5 - 20		5 - 20	

#### Technical data

Input data	①	②	③	④	
Permissible range (with reference to $U_N$ )	see diagram				
Typ. input current at $U_N$	[mA]	56	116	23	12
Typ. response time at $U_N$	[ms]	20			
Typ. response time at $U_N$ (depending on phase relation)	[ms]	5 - 25		5 - 25	
Typ. release time at $U_N$	[ms]	15			
Typ. release time at $U_N$ (depending on phase relation)	[ms]	5 - 20		5 - 20	

Output data	①	②	③	④
Contact type	2 PDTs			
Contact material	AgNi			
Max. switching voltage	440 V AC / 250 V DC			
Min. switching voltage	10 V (at 24 mA)			
Limiting continuous current	16 A			
Max. inrush current, AC	50 A (20 ms, N/O contact)			
Max. inrush current, DC	50 A (20 ms, N/O contact)			
Min. switching current	10 mA (at 24 V)			
Max. interrupting rating, ohmic load	4000 VA			

Output data	①	②	③	④
Contact type	3 PDTs			
Contact material	AgNi			
Max. switching voltage	440 V AC / 250 V DC			
Min. switching voltage	10 V (at 24 mA)			
Limiting continuous current	16 A			
Max. inrush current, AC	50 A (20 ms, N/O contact)			
Max. inrush current, DC	50 A (20 ms, N/O contact)			
Min. switching current	10 mA (at 24 V)			
Max. interrupting rating, ohmic load	4000 VA			

Motor load according to UL 508	250 V AC	4000 VA	1/3 HP, 120 V AC (single-phase AC motor)
	440 V AC	4000 VA	1/2 HP, 240 V AC (single-phase AC motor)

Motor load according to UL 508	250 V AC	4000 VA	1/3 HP, 120 V AC (single-phase AC motor)
	440 V AC	4000 VA	1/2 HP, 240 V AC (single-phase AC motor)
	440 V AC	4000 VA	1/2 HP, 240 V AC (three-phase induction motor)

General data	①	②	③	④
Test voltage (winding/contact)	2.5 kV <sub>rms</sub> (50 Hz, 1 min.)			
Ambient temperature (operation), AC	-40 °C ... 55 °C			
Ambient temperature (operation), DC	-40 °C ... 70 °C			
Nominal operating mode	100% operating factor			
Mechanical service life, AC	Approx. 10 <sup>7</sup> cycles			
Mechanical service life, DC	Approx. 10 <sup>7</sup> cycles			
Standards/regulations	IEC 60664			
Mounting position / mounting	any			
Dimensions	W / H / D	38.6 mm / 45.5 mm / 36.1 mm		

General data	①	②	③	④
Test voltage (winding/contact)	2.5 kV <sub>rms</sub> (50 Hz, 1 min.)			
Ambient temperature (operation), AC	-40 °C ... 55 °C			
Ambient temperature (operation), DC	-40 °C ... 70 °C			
Nominal operating mode	100% operating factor			
Mechanical service life, AC	Approx. 10 <sup>7</sup> cycles			
Mechanical service life, DC	Approx. 10 <sup>7</sup> cycles			
Standards/regulations	IEC 60664			
Mounting position / mounting	any			
Dimensions	W / H / D	38.6 mm / 45.5 mm / 36.1 mm		

#### Ordering data

Description	Input voltage $U_N$	Type	Order No.	Pcs. / Pkt.
<b>Plug-in high-power relay, 2 PDTs with power contacts</b>	① 24 V DC	REL-PR2- 24DC/2X21	2903698	1
	② 24 V AC	REL-PR2- 24AC/2X21	2903699	1
	③ 120 V AC	REL-PR2-120AC/2X21	2903700	1
	④ 230 V AC	REL-PR2-230AC/2X21	2903701	1
<b>Plug-in high-power relay, 3 PDTs with power contacts</b>	① 24 V DC	REL-PR3- 24DC/3X21	2903702	1
	② 24 V AC	REL-PR3- 24AC/3X21	2903703	1
	③ 120 V AC	REL-PR3-120AC/3X21	2903704	1
	④ 230 V AC	REL-PR3-230AC/3X21	2903705	1

#### Ordering data

Description	Input voltage $U_N$	Type	Order No.	Pcs. / Pkt.
<b>Plug-in high-power relay, 2 PDTs with power contacts</b>	① 24 V DC	REL-PR2- 24DC/2X21	2903698	1
	② 24 V AC	REL-PR2- 24AC/2X21	2903699	1
	③ 120 V AC	REL-PR2-120AC/2X21	2903700	1
	④ 230 V AC	REL-PR2-230AC/2X21	2903701	1
<b>Plug-in high-power relay, 3 PDTs with power contacts</b>	① 24 V DC	REL-PR3- 24DC/3X21	2903702	1
	② 24 V AC	REL-PR3- 24AC/3X21	2903703	1
	③ 120 V AC	REL-PR3-120AC/3X21	2903704	1
	④ 230 V AC	REL-PR3-230AC/3X21	2903705	1

### REL-PR2... (2 PDTs)

Operating voltage range

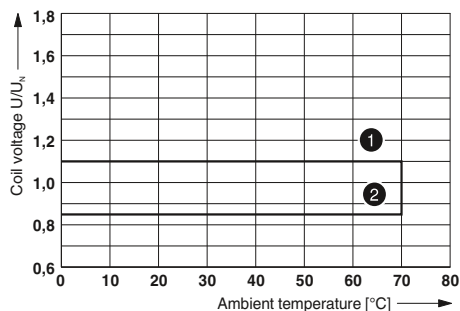

- 1 Maximum continuous voltage at limiting continuous current = 16 A
  - 2 Minimum operate voltage
- For pre-excitation with UN and limiting continuous current = 16 A

Interrupting rating

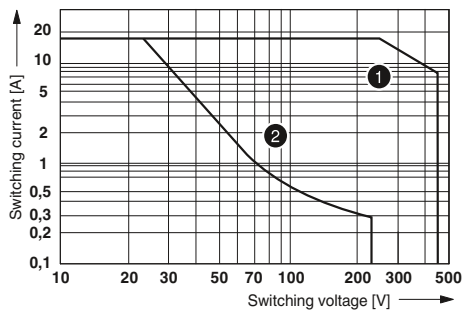

- 1 AC, ohmic load
- 2 DC, ohmic load

Electrical service life

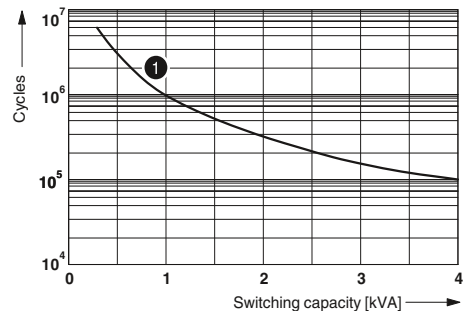

- 1 250 V AC, ohmic load

Service life reduction factor

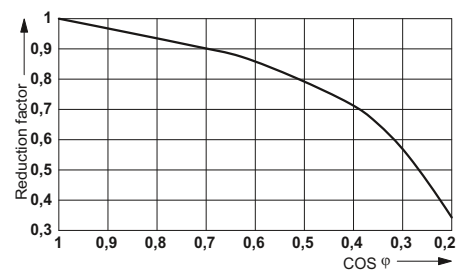

### REL-PR3... (3 PDTs)

Operating voltage range

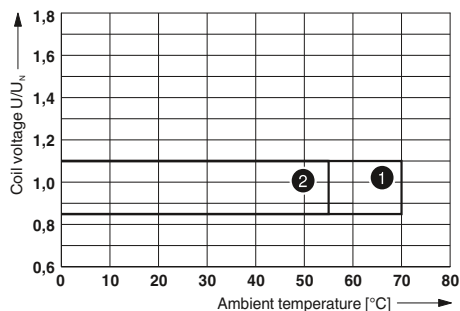

- 1 DC coils
- 2 AC coils

Interrupting rating

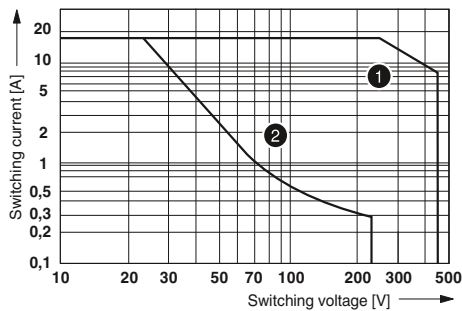

- 1 AC, ohmic load
- 2 DC, ohmic load

Electrical service life

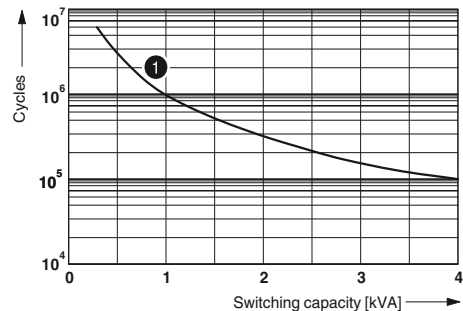

- 1 250 V AC, ohmic load

Service life reduction factor

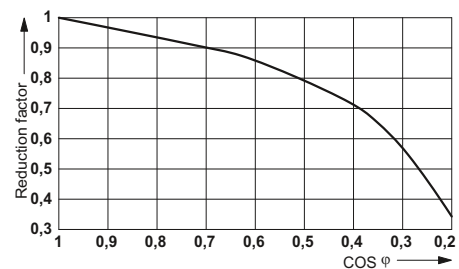

# Relay modules

## Industrial relay system with push-in connection - RIFLINE complete

### Plug-in high-power relays

Plug-in high-power relays with 3 N/O contacts suitable for the RIF-4 relay base.

The advantages:

- Use in miniature contactor applications
- Switching current of up to 16 A
- Up to 440 V AC switching voltage
- Full shutdown by means of  $\geq 3$  mm contact opening



3 N/O relay

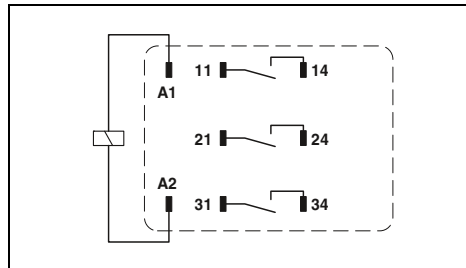

#### Technical data

Input data		①	②	③	④
Permissible range (with reference to $U_N$ )		see diagram			
Typ. input current at $U_N$	[mA]	70	116	23	12
Typ. response time at $U_N$	[ms]	20			
Typ. response time at $U_N$ (depending on phase relation)	[ms]	5 - 25		5 - 25	
Typ. release time at $U_N$	[ms]	15			
Typ. release time at $U_N$ (depending on phase relation)	[ms]	5 - 20		5 - 20	
Output data					
Contact type		3 N/O contacts			
Contact material		AgNi			
Max. switching voltage		440 V AC / 250 V DC			
Min. switching voltage		10 V (at 24 mA)			
Limiting continuous current		16 A			
Max. inrush current, AC		50 A (20 ms, N/O contact)			
Max. inrush current, DC		50 A (20 ms, N/O contact)			
Min. switching current		10 mA (at 24 V)			
Max. interrupting rating, ohmic load		250 V AC	4000 VA		
		440 V AC	4000 VA		
Motor load according to UL 508		1/3 HP, 120 V AC (single-phase AC motor) 1/2 HP, 240 V AC (single-phase AC motor) 1/2 HP, 240 V AC (three-phase induction motor)			
General data					
Test voltage (winding/contact)		2.5 kV <sub>rms</sub> (50 Hz, 1 min.)			
Ambient temperature (operation), AC		-40 °C ... 55 °C			
Ambient temperature (operation), DC		-40 °C ... 70 °C			
Nominal operating mode		100% operating factor			
Mechanical service life, AC		Approx. 10 <sup>7</sup> cycles			
Mechanical service life, DC		Approx. 10 <sup>7</sup> cycles			
Standards/regulations		IEC 60664			
Mounting position / mounting		any			
Dimensions		W / H / D	38.6 mm / 45.5 mm / 36.1 mm		
Ordering data					
Description	Input voltage $U_N$	Type	Order No.	Pcs. / Pkt.	
Plug-in high-power relay, 3 N/O contacts with power contacts	① 24 V DC	REL-PR3-24DC/3X1	2903706	1	
	② 24 V AC	REL-PR3-24AC/3X1	2903707	1	
	③ 120 V AC	REL-PR3-120AC/3X1	2903708	1	
	④ 230 V AC	REL-PR3-230AC/3X1	2903709	1	

### REL-PR2... (3 N/O contacts)

Operating voltage range

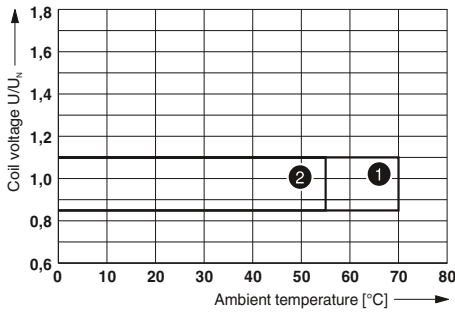

- 1 DC coils
- 2 AC coils

Interrupting rating

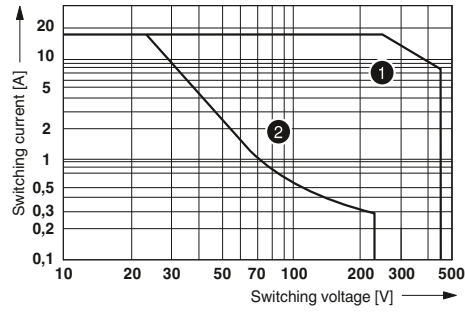

- 1 AC, ohmic load
- 2 DC, ohmic load

Electrical service life

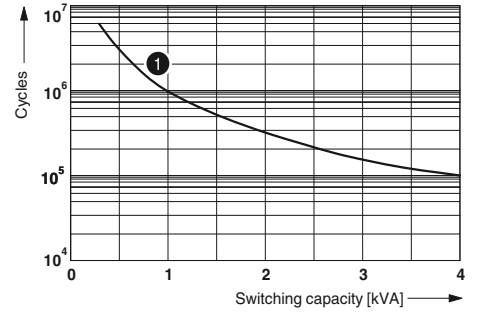

- 1 250 V AC, ohmic load

Service life reduction factor

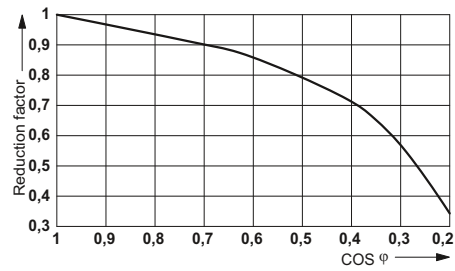

# Relay modules

## Industrial relay system with push-in connection - RIFLINE complete

### Input modules/interference suppression modules for RIF-1, RIF-2, RIF-3, and RIF-4

Plug-in input modules/interference suppression modules for optional fitting of RIF-1 to RIF-4 relay bases.

The advantages:

- Attenuation of reverse voltage induced in coil
- Mechanical coding to protect against incorrect connection



Input/interference suppression module



#### Ordering data

Description	Type	Order No.	Pcs. / Pkt.
<p><b>Plug-in module</b>, with LED status indicator and freewheeling diode to effectively limit the coil induction voltage, polarity: <b>A1+</b>, <b>A2-</b>, input voltage:</p> <ul style="list-style-type: none"> <li>- 12-24 V DC <math>\pm 20\%</math></li> <li>- 48-60 V DC <math>\pm 20\%</math></li> <li>- 110 V DC <math>\pm 20\%</math></li> </ul>	<p><b>RIF-LDP-12-24 DC</b>  <b>RIF-LDP-48-60 DC</b>  <b>RIF-LDP-110 DC</b></p>	<p><b>2900939</b>  <b>2900940</b>  <b>2900941</b></p>	<p>10 10 10</p>
<p><b>Plug-in module</b>, with LED status indicator and varistor to limit the coil induction voltage and/or external interference peaks, input voltage:</p> <ul style="list-style-type: none"> <li>- 12-24 V AC/DC <math>\pm 20\%</math> (30 V varistor)</li> <li>- 48-60 V AC/DC <math>\pm 20\%</math> (75 V varistor)</li> <li>- 120-230 V AC/110 V DC <math>\pm 20\%</math> (275 V varistor)</li> </ul>	<p><b>RIF-LV-12-24 UC</b>  <b>RIF-LV-48-60 UC</b>  <b>RIF-LV-120-230 AC/110 DC</b></p>	<p><b>2900942</b>  <b>2900943</b>  <b>2900944</b></p>	<p>10 10 10</p>
<p><b>Plug-in module</b>, with varistor to limit the coil induction voltage and/or external interference peaks, input voltage:</p> <ul style="list-style-type: none"> <li>- 12-24 V AC/DC <math>\pm 20\%</math> (30 V varistor)</li> <li>- 48-60 V AC/DC <math>\pm 20\%</math> (75 V varistor)</li> <li>- 120-230 V AC/110 V DC <math>\pm 20\%</math> (275 V varistor)</li> </ul>	<p><b>RIF-V-12-24 UC</b>  <b>RIF-V-48-60 UC</b>  <b>RIF-V-120-230 UC</b></p>	<p><b>2900945</b>  <b>2900947</b>  <b>2900948</b></p>	<p>10 10 10</p>
<p><b>Plug-in module</b>, with RC element to limit the coil induction voltage and/or external interference peaks, input voltage:</p> <ul style="list-style-type: none"> <li>- 12-24 V AC/DC <math>\pm 20\%</math> (220 nF/100 <math>\Omega</math>)</li> <li>- 48-60 V AC/DC <math>\pm 20\%</math> (220 nF/220 <math>\Omega</math>)</li> <li>- 120 - 230 V AC/110 DC <math>\pm 20\%</math> (100 nF/470 <math>\Omega</math>)</li> </ul>	<p><b>RIF-RC-12-24 UC</b>  <b>RIF-RC-48-60 UC</b>  <b>RIF-RC-120-230 UC</b></p>	<p><b>2900949</b>  <b>2900950</b>  <b>2900951</b></p>	<p>10 10 10</p>

Timer relay

Plug-in timer module for RIF-1, RIF-2, RIF-3, and RIF-4

The multifunctional plug-in timer module transforms the relay module into a timer relay. The RIF-1 to RIF-4 bases can be fitted with this module. Using DIP switches, you can choose from three time ranges and select four time functions. Fine adjustments to the time are made using a potentiometer. Relays can be operated with an input voltage of 24 V AC/DC.



Timer module

Functions:

- With switch-on delay
- With passing make contact
- Flasher/pulse generator

Time ranges:

- 0.5 s - 10 s
- 5 s - 100 s
- 0.5 min - 10 min
- 5 min - 100 min

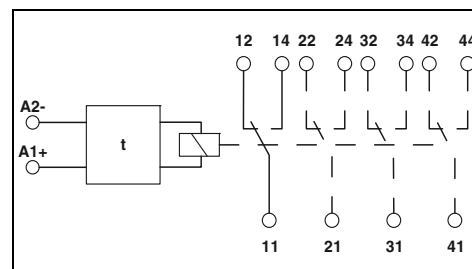

Technical data

<b>Input data</b>	Nominal input voltage $U_N$
	Nominal input voltage range with reference to $U_N$
<b>Input circuit</b>	
<b>Output data</b>	Limiting continuous current
<b>General data</b>	Mounting position Repeat accuracy Ambient temperature (operation)
<b>Standards/specifications</b>	Rated insulation voltage Rated surge voltage

24 V DC (AC operation only permitted for RIF-1)
0.4 ... 1.2
Varistor, yellow LED
≤ 250 mA (relay coil current)
any 1 %
-25 °C ... 50 °C (RIF-1, AC coil, 2 PDTs at 6 A) -25 °C ... 50 °C (RIF-1, DC coil, 2 PDTs at 5 A) -25 °C ... 40 °C (RIF-2, DC coil, 2 PDTs at 8 A) -25 °C ... 40 °C (RIF-2, DC coil, 4 PDTs at 5 A) -25 °C ... 40 °C (RIF-3, DC coil, 3 PDTs at 6.75 A) -25 °C ... 40 °C (RIF-3, DC coil, 2 PDTs at 8 A) -25 °C ... 35 °C (RIF-4, DC coil, 3 PDTs at 8 A) -25 °C ... 25 °C (RIF-4, DC coil, 3 N/O contacts at 8 A)
DIN EN 50178 50 V DC 0.4 kV

With switch-on delay

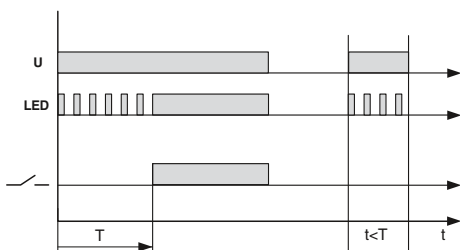

With passing make contact

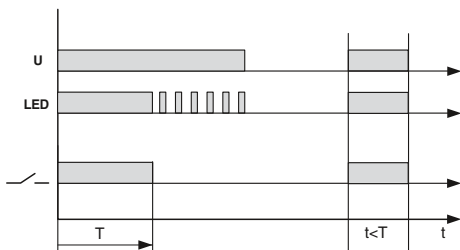

Flasher/pulse generator

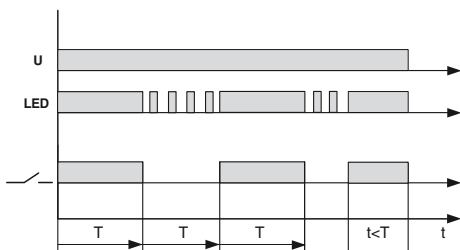

<b>Description</b>	<b>Timer module</b> , for mounting on RIF-1 to RIF-4, with LED status indicator for extending a relay module to create a timer relay with an input voltage of 24 V AC/DC
--------------------	--

Ordering data

Type	Order No.	Pcs. / Pkt.
RIF-T3-24UC	2902647	1



# Relay modules

## Industrial relay system with push-in connection - RIFLINE complete

### Fully mounted RIF-0 relay modules

Fully mounted RIF-0 relay modules, consisting of:

- Relay base with push-in connection
- 1 N/O contact or 1 PDT relay
- Relay ejector lever on the housing

The advantages:

- Status LED integrated in the relay base
- Operational reliability thanks to sealed relay
- Safe isolation between coil and contact side
- Professional bridging of adjacent modules saves wiring time
- For FBS 2-6 jumpers for the input and output side, see page 374.

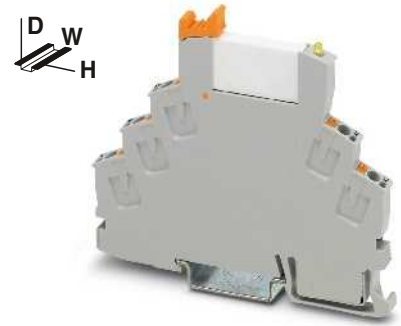

RIF-0 relay module with 1 PDT relay

ERC (R)

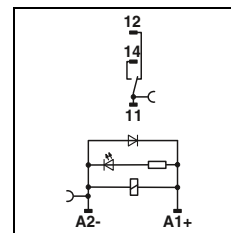

DC coils

Input data	
Permissible range (with reference to $U_N$ )	
Typ. input current at $U_N$	[mA]
Typ. response time at $U_N$	[ms]
Typ. release time at $U_N$	[ms]
Input protection:	
Output data	
Contact type	
Contact material	
Max. switching voltage	
Min. switching voltage	
Limiting continuous current	
Min. switching current	
General data	
Test voltage (winding/contact)	
Ambient temperature (operation)	
Nominal operating mode	
Mechanical service life	
Standards/regulations	
Pollution degree / surge voltage category	
Mounting position / mounting	
Connection data solid / stranded / AWG	
Dimensions	W / H / D
EMC note	

Technical data		
①	②	
see diagram		
16	9	
5	5	
8	8	
Yellow LED, freewheeling diode		
1 PDT		1 PDT
AgSnO		AgSnO, hard gold-plated
250 V AC/DC		30 V AC / 36 V DC
5 V (at 100 mA)		100 mV (at 10 mA)
6 A		50 mA
10 mA (at 12 V)		1 mA
4 $kV_{rms}$ (50 Hz, 1 min.)		
-40 °C ... 60 °C		
100% operating factor		
Approx. $2 \times 10^7$ cycles		
DIN EN 50178, IEC 62103		
2 / III		
any / can be aligned without spacing		
0.14 - 1.5 mm <sup>2</sup> / 0.14 - 1.5 mm <sup>2</sup> / 26 - 16		
6.2 mm / 93 mm / 78 mm		
Class A product, see page 625		

Description	Input voltage $U_N$
<b>Coupling relay modules</b> with power contact relay and push-in connection	① 12 V DC
	② 24 V DC
<b>Coupling relay modules</b> with power contact relay, gold contacts, and push-in connection	① 12 V DC
	② 24 V DC

Ordering data		
Type	Order No.	Pcs. / Pkt.
RIF-0-RPT-12DC/21	2903371	10
RIF-0-RPT-24DC/21	2903370	10
RIF-0-RPT-12DC/21AU	2903369	10
RIF-0-RPT-24DC/21AU	2903368	10

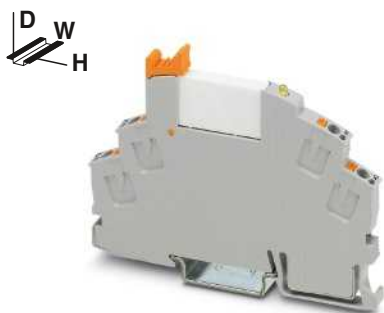

RIF-0 relay module with 1 N/O relay

ERIC

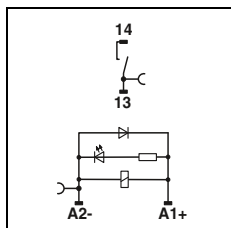

DC coils

Technical data

①	②
see diagram	see diagram
16	9
5	5
8	8
Yellow LED, freewheeling diode	

1 N/O contact AgSnO	1 N/O contact AgSnO, hard gold-plated
------------------------	--

250 V AC/DC 5 V (at 100 mA) 6 A 10 mA (at 12 V)	30 V AC / 36 V DC 100 mV (at 10 mA) 50 mA 1 mA (at 12 V)
--	---

4 kV<sub>ms</sub> (50 Hz, 1 min.)  
-40 °C ... 60 °C  
100% operating factor  
Approx. 2 x 10<sup>7</sup> cycles  
DIN EN 50178, IEC 62103  
2 / III

any / can be aligned without spacing  
0.14 - 1.5 mm<sup>2</sup> / 0.14 - 1.5 mm<sup>2</sup> / 26 - 16  
6.2 mm / 93 mm / 66 mm  
Class A product, see page 625

Ordering data

Type	Order No.	Pcs. / Pkt.
RIF-0-RPT-12DC/ 1	2903362	10
RIF-0-RPT-24DC/ 1	2903361	10
RIF-0-RPT-12DC/ 1AU	2903360	10
RIF-0-RPT-24DC/ 1AU	2903359	10

RIF-0-RPT.../21... (1 PDT)

Operating voltage range

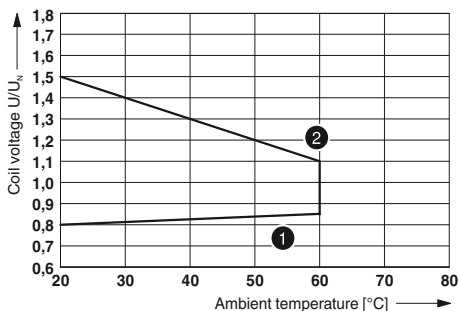

- ① Maximum continuous voltage at limiting continuous current = 6 A
  - ② Minimum operate voltage
- For pre-excitation with U<sub>n</sub> and limiting continuous current = 6 A

Service life reduction factor

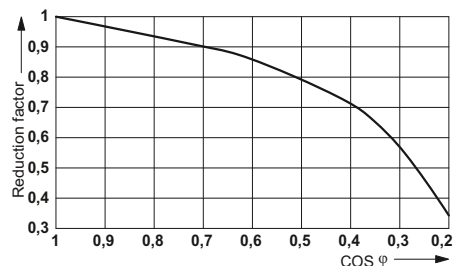

Interrupting rating

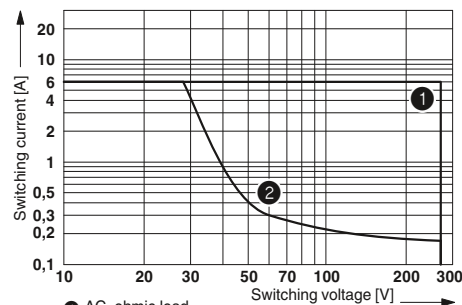

- ① AC, ohmic load
- ② DC, ohmic load

Electrical service life

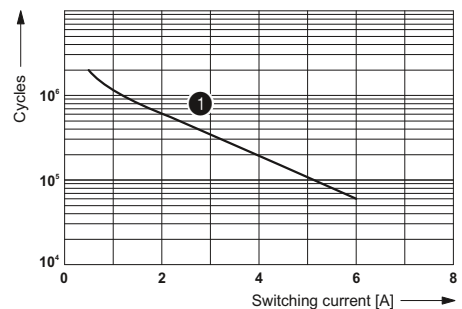

- ① 250 V AC, ohmic load

RIF-0-RPT.../1... (1 N/O contact)

Operating voltage range

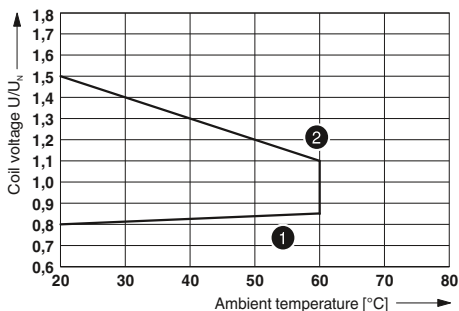

- ① Maximum continuous voltage at limiting continuous current = 6 A
  - ② Minimum operate voltage
- For pre-excitation with U<sub>n</sub> and limiting continuous current = 6 A

Service life reduction factor

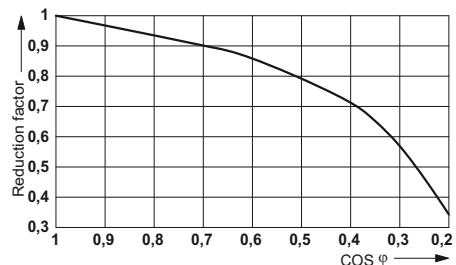

Interrupting rating

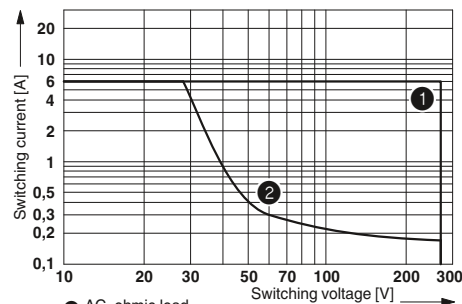

- ① AC, ohmic load
- ② DC, ohmic load

Electrical service life

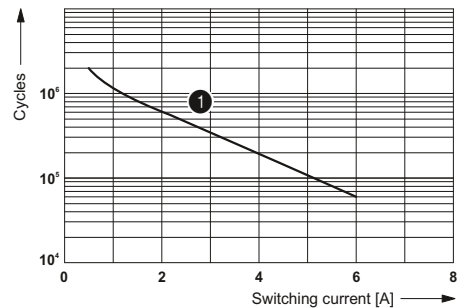

- ① 250 V AC, ohmic load

# Relay modules

## Industrial relay system with push-in connection - RIFLINE complete

### Fully mounted RIF-0 relay modules

Fully mounted RIF-0 relay modules, consisting of:

- Relay base with push-in connection
- Solid-state relay
- Relay ejector lever on the housing

The advantages:

- Status LED integrated into the base
- RTIII sealed solid-state relay
- Zero voltage switch at AC output
- Professional bridging of adjacent modules saves wiring time



Max. DC voltage output of 3 A

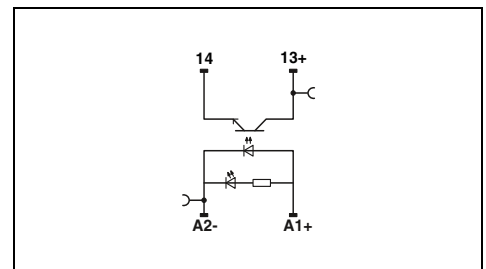

#### Technical data

Input data		①
Rated actuating voltage range with reference to $U_C$		0.8 - 1.2
Rated actuating current $I_C$	[mA]	8.5
Switching level (with reference to $U_C$ )	1 signal ("H") 0 signal ("L")	> 0.8 < 0.4
Typ. switch-on time at $U_N$	[ms]	0.02
Typ. shutdown time at $U_N$	[ms]	0.3
Transmission frequency $f_{limit}$	[Hz]	300
Input circuit DC		Yellow LED, freewheeling diode
Output data		
Max. switching voltage		33 V DC
Min. switching voltage		3 V DC
Max. inrush current		15 A (10 ms)
Min. / max. switching current		- / 3 A (see derating curve)
Output protection		Protection against polarity reversal, surge protection
Voltage drop at max. limiting continuous current		< 200 mV
Leakage current in off state		-
Phase angle (cos $\phi$ )		-
Max. load value		-
General data		
Test voltage input/output		2.5 kV <sub>rms</sub> (50 Hz, 1 min.)
Ambient temperature (operation)		-25 °C ... 60 °C
Standards/regulations		DIN EN 50178
Pollution degree / surge voltage category		2 / III
Connection data solid / stranded / AWG		0.14 - 1.5 mm <sup>2</sup> / 0.14 - 1.5 mm <sup>2</sup> / 26 - 16
Dimensions	W / H / D	6.2 mm / 93 mm / 66 mm
EMC note		Class A product, see page 625

#### Ordering data

Description	Rated actuating voltage $U_C$	Type	Order No.	Pcs. / Pkt.
<b>Coupling relay modules</b> with solid-state relay and push-in connection	① 24 V DC	<b>RIF-0-OPT-24DC/24DC/2</b>	<b>2905293</b>	10

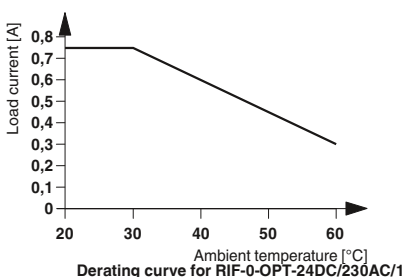
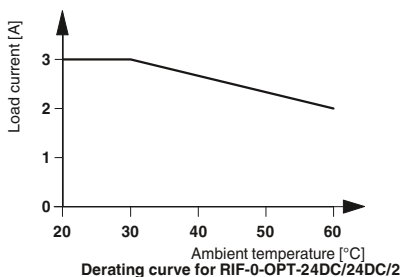

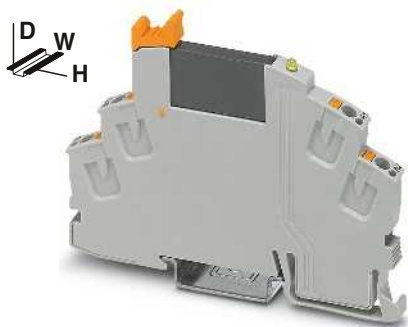

Max. DC voltage output of 100 mA



Max. AC voltage output of 750 mA

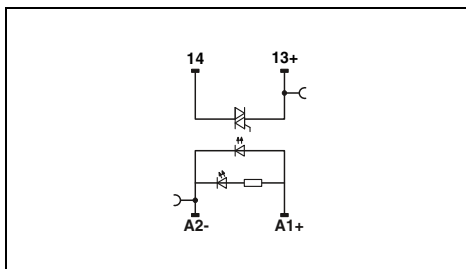
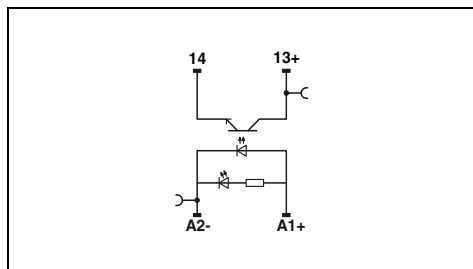

**Technical data**

**Technical data**

①
0.8 - 1.2
8.5
> 0.8
< 0.4
0.02
0.3
300
Yellow LED, freewheeling diode
48 V DC
3 V DC
-
- / 100 mA
Protection against polarity reversal, surge protection
< 1 V
-
-
-
2.5 kV <sub>rms</sub> (50 Hz, 1 min.)
-25 °C ... 60 °C
DIN EN 50178
2 / III
0.14 - 1.5 mm <sup>2</sup> / 0.14 - 1.5 mm <sup>2</sup> / 26 - 16
6.2 mm / 93 mm / 66 mm
Class A product, see page 625

①
0.8 - 1.2
8
> 0.8
< 0.4
10
10
10
Yellow LED, freewheeling diode
253 V AC
24 V AC
30 A (10 ms)
10 mA / 0.75 A (see derating curve)
RCV circuit
< 1 V
1 mA (in off state)
0.5
4.5 A <sup>2</sup> s (tp = 10 ms, at 25 °C)
2.5 kV <sub>rms</sub> (50 Hz, 1 min.)
-25 °C ... 60 °C
DIN EN 50178
2 / III
0.14 - 1.5 mm <sup>2</sup> / 0.14 - 1.5 mm <sup>2</sup> / 26 - 16
6.2 mm / 93 mm / 66 mm
Class A product, see page 625

**Ordering data**

**Ordering data**

Type	Order No.	Pcs. / Pkt.
RIF-0-OPT-24DC/48DC/100	2905294	10

Type	Order No.	Pcs. / Pkt.
RIF-0-OPT-24DC/230AC/1	2905295	10

# Relay modules

## Industrial relay system with push-in connection - RIFLINE complete

### Fully mounted RIF-1 relay modules

Fully mounted RIF-1 relay modules, consisting of:

- Relay base with push-in connection
- 1 or 2 PDT relay
- Relay retaining bracket
- Input module/interference suppr. module

The advantages:

- Logical contact arrangement thanks to 1/3-level relay base
- Operational reliability thanks to sealed relay
- Safe isolation between coil and contact side
- Professional bridging of adjacent modules saves wiring time
- For FBS 2-6 jumpers for the input side (A2), see page 374.
- For FBS 2-8 jumpers for the output side (11/21), see page 374.

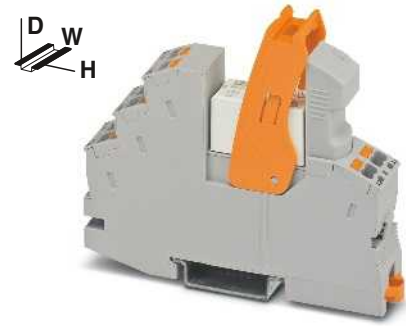

RIF-1 relay module with 1 PDT relay

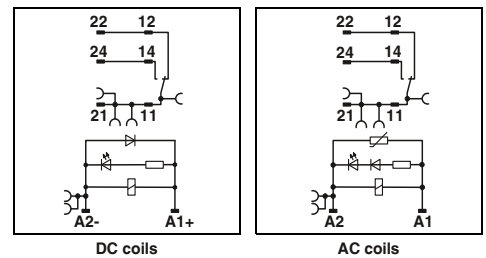

Input data	
Permissible range (with reference to $U_N$ )	
Typ. input current at $U_N$	[mA]
Typ. response time at $U_N$	[ms]
Typ. release time at $U_N$	[ms]
Input circuit AC	
Input circuit DC	
Output data	
Contact type	
Contact material	
Max. switching voltage	
Min. switching voltage	
Limiting continuous current	
Max. inrush current, AC	
Max. inrush current, DC	
Min. switching current	
General data	
Test voltage (winding/contact)	
Ambient temperature (operation), AC	
Ambient temperature (operation), DC	
Nominal operating mode	
Mechanical service life, AC	
Mechanical service life, DC	
Standards/regulations	
Pollution degree / surge voltage category	
Mounting position / mounting	
Connection data solid / stranded / AWG	
Dimensions	W / H / D

Technical data				
①	②	③	④	⑤
see diagram				
33	18	33	8	6
8	8	3 - 12	3 - 12	3 - 12
10	10	3 - 20	3 - 20	3 - 20
Yellow LED, varistor				
Yellow LED, freewheeling diode				
1 PDT		1 PDT		
AgNi		AgNi, hard gold-plated		
250 V AC/DC		30 V AC / 36 V DC		
12 V (at 10 mA)		100 mV (at 10 mA)		
11 A (see diagram)		50 mA		
25 A (20 ms, N/O contact)		50 mA		
50 A (20 ms, N/O contact)		50 mA		
10 mA (at 12 V)		1 mA (at 24 V)		
4 $kV_{rms}$ (50 Hz, 1 min.)				
-40 °C ... 50 °C				
-40 °C ... 70 °C				
100% operating factor				
Approx. $10^7$ cycles				
Approx. $3 \times 10^7$ cycles				
DIN EN 50178, IEC 62103				
2 / III				
any / can be aligned without spacing				
0.14 - 1.5 mm <sup>2</sup> / 0.14 - 1.5 mm <sup>2</sup> / 26 - 16				
16 mm / 93 mm / 75 mm				

Description	Input voltage $U_N$
<b>Coupling relay modules</b> with power contact relay and push-in connection	
①	12 V DC
②	24 V DC
③	24 V AC
④	120 V AC
⑤	230 V AC
②	24 V DC
③	24 V AC
④	120 V AC
⑤	230 V AC

Ordering data		
Type	Order No.	Pcs. / Pkt.
RIF-1-RPT-LDP-12DC/1X21	2906224	10
RIF-1-RPT-LDP-24DC/1X21	2903342	10
RIF-1-RPT-LV-24AC/1X21	2903341	10
RIF-1-RPT-LV-120AC/1X21	2903340	10
RIF-1-RPT-LV-230AC/1X21	2903339	10
RIF-1-RPT-LDP-24DC/1X21AU	2903338	10
RIF-1-RPT-LV-24AC/1X21AU	2903337	10
RIF-1-RPT-LV-120AC/1X21AU	2903336	10
RIF-1-RPT-LV-230AC/1X21AU	2903335	10

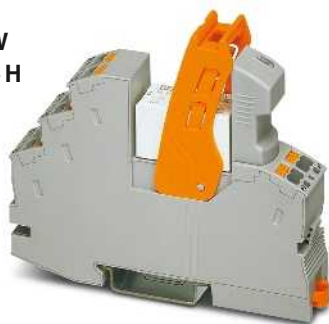

RIF-1 relay module with 2 PDT relay

### RIF-1-RPT.../1X21... (1 PDT)

Operating voltage range

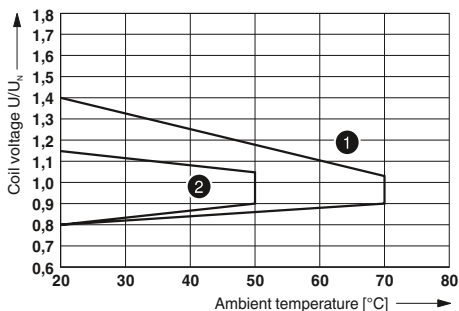

Interrupting rating

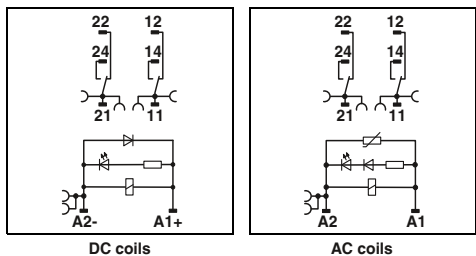
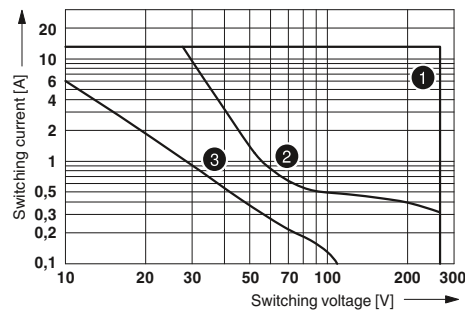

Contact derating

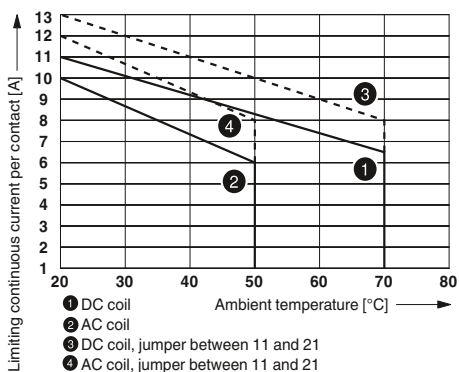

Electrical service life

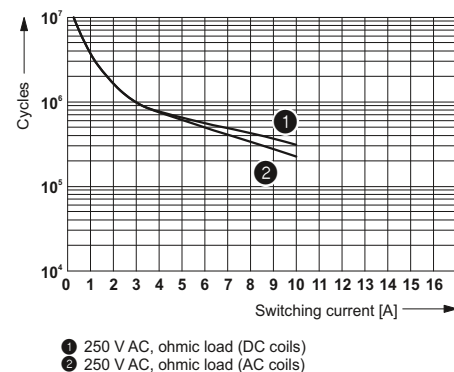

#### Technical data

①	②	③	④	⑤
see diagram				
33	18	33	8	6
8	8	3 - 12	3 - 12	3 - 12
10	10	3 - 20	3 - 20	3 - 20
Yellow LED, varistor				
Yellow LED, freewheeling diode				

2 PDTs	2 PDTs
AgNi	AgNi, hard gold-plated
250 V AC/DC	30 V AC / 36 V DC
5 V (at 10 mA)	100 mV (at 10 mA)
8 A (see diagram)	50 mA
12 A (20 ms, N/O contact)	50 mA
25 A (20 ms, N/O contact)	50 mA
10 mA (at 5 V)	1 mA (at 24 V)

4 kV<sub>ms</sub> (50 Hz, 1 min.)  
 -40 °C ... 50 °C  
 -40 °C ... 70 °C  
 100% operating factor  
 Approx. 10<sup>7</sup> cycles  
 Approx. 3 x 10<sup>7</sup> cycles  
 DIN EN 50178, IEC 62103  
 2 / III

any / can be aligned without spacing  
 0.14 - 1.5 mm<sup>2</sup> / 0.14 - 1.5 mm<sup>2</sup> / 26 - 16  
 16 mm / 93 mm / 75 mm

#### Ordering data

Type	Order No.	Pcs. / Pkt.
RIF-1-RPT-LDP-12DC/2X21	2906223	10
RIF-1-RPT-LDP-24DC/2X21	2903334	10
RIF-1-RPT-LV-24AC/2X21	2903333	10
RIF-1-RPT-LV-120AC/2X21	2903332	10
RIF-1-RPT-LV-230AC/2X21	2903331	10
RIF-1-RPT-LDP-24DC/2X21AU	2903330	10
RIF-1-RPT-LV-24AC/2X21AU	2903329	10
RIF-1-RPT-LV-120AC/2X21AU	2903328	10
RIF-1-RPT-LV-230AC/2X21AU	2903327	10

### RIF-1-RPT.../2X21... (2 PDTs)

Operating voltage range

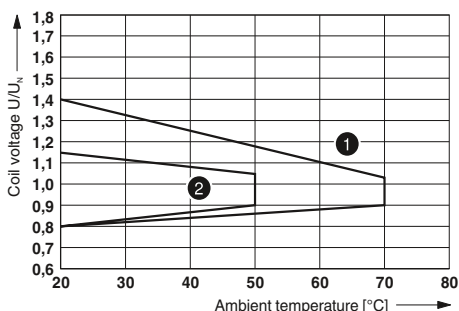

Interrupting rating

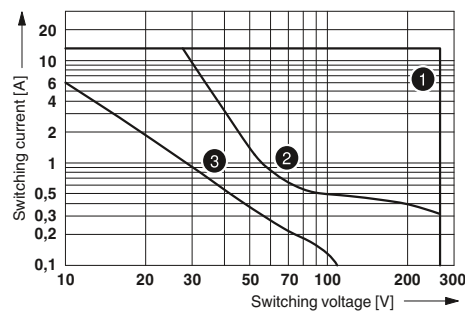

Contact derating

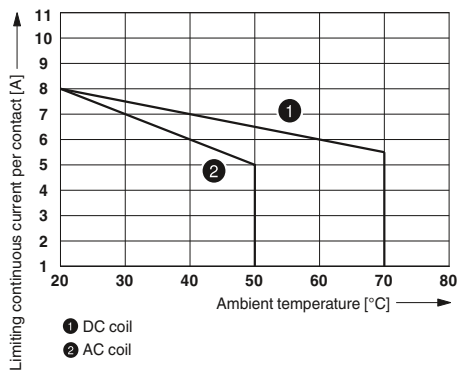

Electrical service life

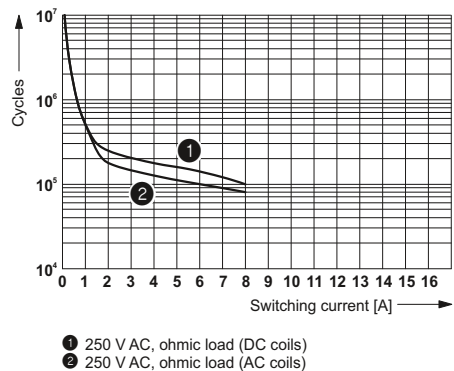



# Relay modules

## Industrial relay system with push-in connection - RIFLINE complete

### Fully mounted RIF-1 relay modules

Fully mounted RIF-1 relay modules, consisting of:

- Relay base with push-in connection
- 1 or 2 PDT relay with detectable manual operation
- Relay retaining bracket
- Input module/interference suppr. module (AC types only)

The advantages:

- Relay with lockable manual operation and status LED
- With DC types, freewheeling diode is integrated into relay
- Mechanical switch position indicator
- Professional bridging of adjacent modules saves wiring time



RIF-1 relay module with 1 PDT relay with manual operation

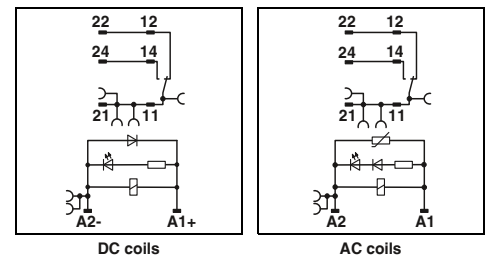

<b>Input data</b>	
Permissible range (with reference to $U_N$ )	
Typ. input current at $U_N$	[mA]
Typ. response time at $U_N$	[ms]
Typ. release time at $U_N$	[ms]
Input circuit AC	
Input circuit DC	
<b>Output data</b>	
Contact type	
Contact material	
Max. switching voltage	
Min. switching voltage	
Limiting continuous current	
Max. inrush current	
Min. switching current	
<b>General data</b>	
Test voltage (winding/contact)	
Ambient temperature (operation), AC	
Ambient temperature (operation), DC	
Nominal operating mode	
Mechanical service life	
Standards/regulations	
Pollution degree / surge voltage category	
Mounting position / mounting	
Connection data solid / stranded / AWG	
Dimensions	W / H / D
EMC note	

Technical data	
①	②
see diagram	
18	4.5
9	4 - 12
10	4 - 20
Yellow LED, varistor	
Yellow LED, freewheeling diode	
1 PDT	
AgNi	
250 V AC/DC	
12 V (at 10 mA)	
see diagram	
32 A (20 ms, N/O contact)	
10 mA (at 12 V)	
4 kV <sub>rms</sub> (50 Hz, 1 min.)	
-40 °C ... 50 °C	
-40 °C ... 70 °C	
100% operating factor	
Approx. 5 x 10 <sup>6</sup> cycles	
DIN EN 50178, IEC 62103	
2 / III	
any / can be aligned without spacing	
0.14 - 1.5 mm <sup>2</sup> / 0.14 - 1.5 mm <sup>2</sup> / 26 - 16	
16 mm / 93 mm / 75 mm	
Class A product, see page 625	

Description	Input voltage $U_N$
<b>Coupling relay modules</b> with power contact relay with manual operation and push-in connection	① 24 V DC
	② 230 V AC

Ordering data		
Type	Order No.	Pcs. / Pkt.
RIF-1-RPT-LDP-24DC/1X21MS	2905289	10
RIF-1-RPT-LV-230AC/1X21MS	2905290	10



RIF-1 relay module with 2 PDT relay with manual operation

### RIF-1-RPT.../1X21... (1 PDT)

Operating voltage range

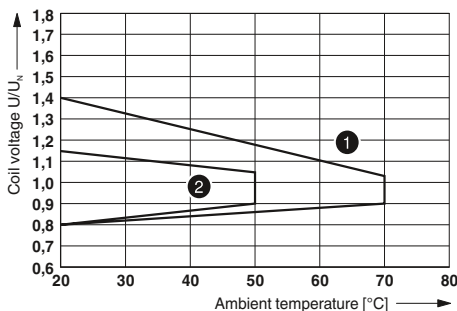

- ① DC coils
- ② AC coils

Interrupting rating

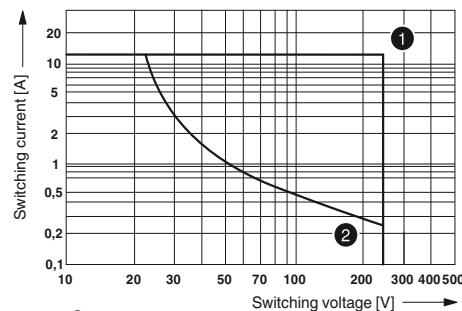

- ① = AC, ohmic load
- ② = DC, ohmic load

Contact derating

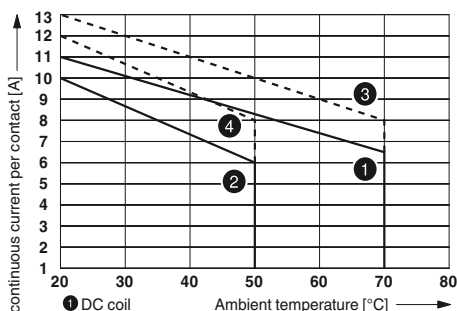

- ① DC coil
- ② AC coil
- ③ DC coil, jumper between 11 and 21
- ④ AC coil, jumper between 11 and 21

Electrical service life

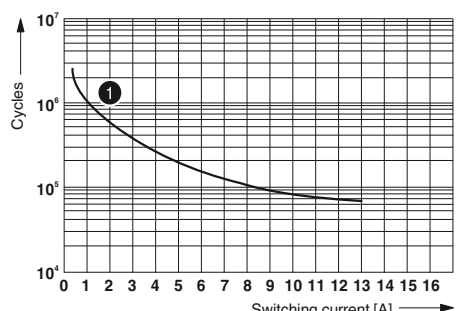

- ① = 250 V AC, ohmic load

ERC

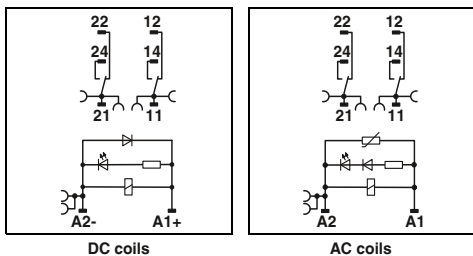

#### Technical data

- ① see diagram
- ② see diagram
- 18 4.5
- 9 4 - 12
- 10 4 - 20
- Yellow LED, varistor
- Yellow LED, freewheeling diode

- 2 PDTs
- AgNi
- 250 V AC/DC
- 12 V (at 10 mA)
- see diagram
- 16 A (20 ms, N/O contact)
- 10 mA (at 12 V)

- 4 kV<sub>rms</sub> (50 Hz, 1 min.)
- 40 °C ... 50 °C
- 40 °C ... 70 °C
- 100% operating factor
- Approx. 5 × 10<sup>6</sup> cycles
- DIN EN 50178, IEC 62103
- 2 / III

- any / can be aligned without spacing
- 0.14 - 1.5 mm<sup>2</sup> / 0.14 - 1.5 mm<sup>2</sup> / 26 - 16
- 16 mm / 93 mm / 75 mm
- Class A product, see page 625

#### Ordering data

Type	Order No.	Pcs. / Pkt.
RIF-1-RPT-LDP-24DC/2X21MS	2905291	10
RIF-1-RPT-LV-230AC/2X21MS	2905292	10

### RIF-1-RPT.../2X21... (2 PDTs)

Operating voltage range

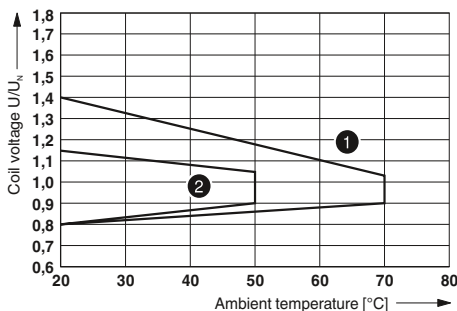

- ① DC coils
- ② AC coils

Interrupting rating

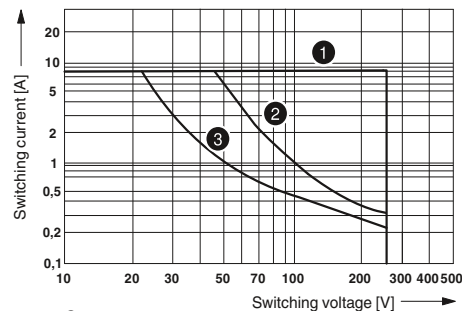

- ① AC, ohmic load
- ② DC, ohmic load, contacts in series
- ③ DC, ohmic load

Contact derating

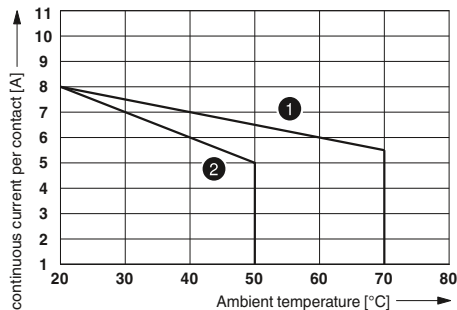

- ① DC coil
- ② AC coil

Electrical service life

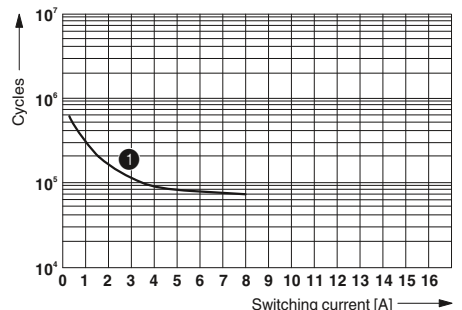

- ① 250 V AC, ohmic load

# Relay modules

## Industrial relay system with push-in connection - RIFLINE complete

### Fully mounted RIF-2 relay modules

Fully mounted RIF-2 relay modules, consisting of:

- Relay base with push-in connection
- 1 or 2 PDT relay
- Relay retaining bracket
- Input module/interference suppr. module (AC types only)

The advantages:

- Relay with lockable manual operation and status LED
- With DC types, freewheeling diode is integrated into relay
- Mechanical switch position indicator
- Logical contact arrangement thanks to 1/3-level relay base
- Professional bridging of adjacent modules saves wiring time
- For FBS 2-6 jumpers for the input side (A2), see page 374.



RIF-2 relay module with 2 PDT relay

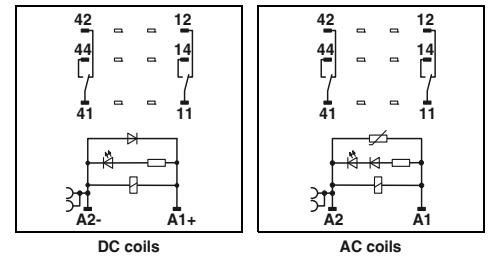

DC coils

AC coils

#### Technical data

Input data	①	②	③	④
Permissible range (with reference to $U_N$ )	see diagram			
Typ. input current at $U_N$ [mA]	42	66	13	6.5
Typ. response time at $U_N$ [ms]	13	5 - 15	5 - 15	5 - 15
Typ. release time at $U_N$ [ms]	14	5 - 20	5 - 20	5 - 20
Input circuit AC	Yellow LED, varistor			
Input circuit DC	Yellow LED, freewheeling diode			
Output data				
Contact type	2 PDTs			
Contact material	AgNi			
Max. switching voltage	250 V AC/DC			
Min. switching voltage	5 V (at 24 mA)			
Limiting continuous current	10 A (see diagram)			
Max. inrush current, AC	30 A (20 ms, N/O contact)			
Max. inrush current, DC	30 A (20 ms, N/O contact)			
Min. switching current	5 mA (at 24 V)			
General data				
Test voltage (winding/contact)	2.5 kV <sub>rms</sub> (50 Hz, 1 min.)			
Ambient temperature (operation), AC	-40 °C ... 50 °C			
Ambient temperature (operation), DC	-40 °C ... 60 °C			
Nominal operating mode	100% operating factor			
Mechanical service life, AC	Approx. 2 x 10 <sup>7</sup> cycles			
Mechanical service life, DC	Approx. 2 x 10 <sup>7</sup> cycles			
Standards/regulations	DIN EN 50178, IEC 62103			
Pollution degree / surge voltage category	2 / III			
Mounting position / mounting	any / can be aligned without spacing			
Connection data solid / stranded / AWG	0.14 - 1.5 mm <sup>2</sup> / 0.14 - 1.5 mm <sup>2</sup> / 26 - 18			
Dimensions	W / H / D 31 mm / 96 mm / 75 mm			
EMC note	Class A product, see page 625			

#### Ordering data

Description	Input voltage $U_N$	Type	Order No.	Pcs. / Pkt.
<b>Pre-assembled coupling relay modules</b> with power contact relay and push-in connection				
	① 24 V DC	RIF-2-RPT-LDP-24DC/2X21	2903315	10
	② 24 V AC	RIF-2-RPT-LV-24AC/2X21	2903313	10
	③ 120 V AC	RIF-2-RPT-LV-120AC/2X21	2903311	10
	④ 230 V AC	RIF-2-RPT-LV-230AC/2X21	2903310	10

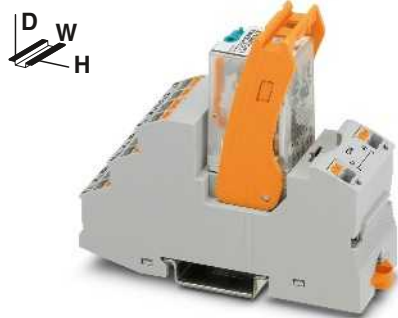

RIF-2 relay module with 4 PDT relay



### RIF-2-RPT.../2X21 (2 PDTs)

Operating voltage range

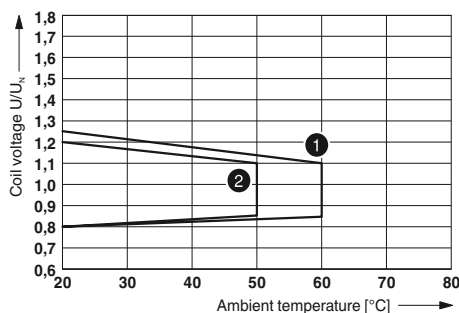

- ① DC coil (observe contact derating)
- ② AC coil (observe contact derating)

Interrupting rating

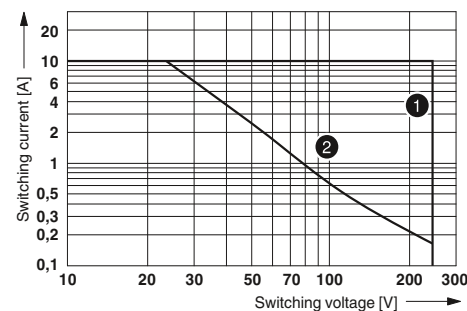

- ① AC, ohmic load
- ② DC, ohmic load

Contact derating

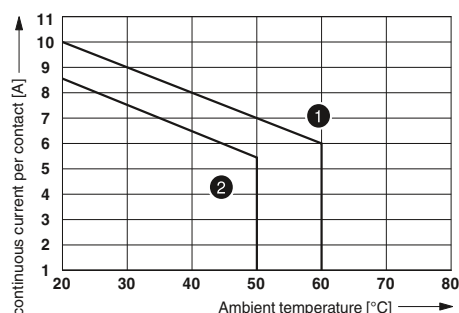

- ① DC coil
- ② AC coil

Electrical service life

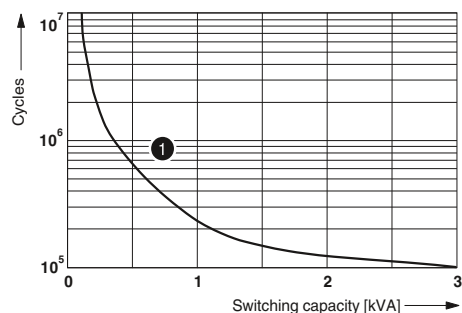

- ① 250 V AC, ohmic load

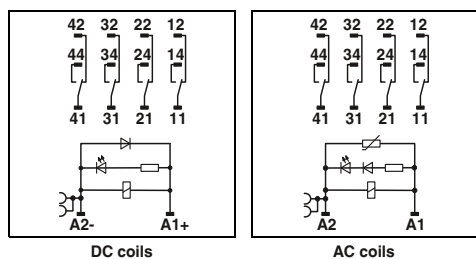

#### Technical data

①	②	③	④
see diagram			
42	66	13	6.5
13	5 - 15	5 - 15	5 - 15
14	5 - 20	5 - 20	5 - 20
Yellow LED, varistor			
Yellow LED, freewheeling diode			

- 4 PDTs
- AgNi
- 250 V AC/DC
- 5 V (at 24 mA)
- 6 A (see diagram)
- 16 A (20 ms, N/O contact)
- 16 A (20 ms, N/O contact)
- 5 mA (at 24 V)

- 2.5 kV<sub>rms</sub> (50 Hz, 1 min.)
- 40 °C ... 50 °C
- 40 °C ... 60 °C
- 100% operating factor
- Approx. 2 × 10<sup>7</sup> cycles
- Approx. 2 × 10<sup>7</sup> cycles
- DIN EN 50178, IEC 62103
- 2 / II

- any / can be aligned without spacing
- 0.14 - 1.5 mm<sup>2</sup> / 0.14 - 1.5 mm<sup>2</sup> / 26 - 16
- 31 mm / 96 mm / 75 mm
- Class A product, see page 625

#### Ordering data

Type	Order No.	Pcs. / Pkt.
RIF-2-RPT-LDP-24DC/4X21	2903308	10
RIF-2-RPT-LV-24AC/4X21	2903306	10
RIF-2-RPT-LV-120AC/4X21	2903305	10
RIF-2-RPT-LV-230AC/4X21	2903304	10

### RIF-2-RPT.../4X21 (4 PDTs)

Operating voltage range

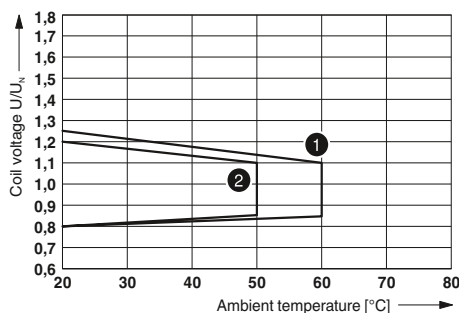

- ① DC coil (observe contact derating)
- ② AC coil (observe contact derating)

Interrupting rating

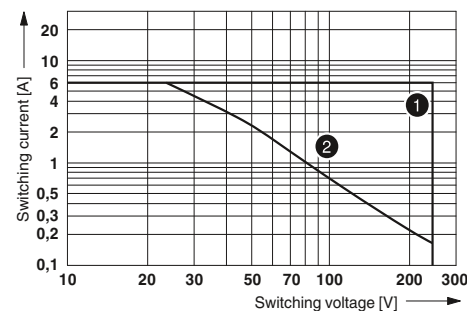

- ① AC, ohmic load
- ② DC, ohmic load

Contact derating

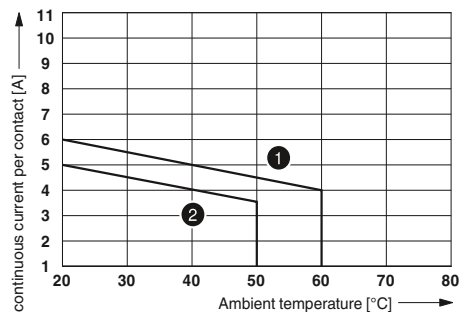

- ① DC coil
- ② AC coil

Electrical service life

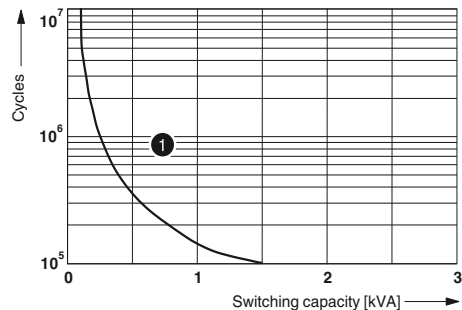

- ① 250 V AC, ohmic load

# Relay modules

## Industrial relay system with push-in connection - RIFLINE complete

### Fully mounted RIF-3 relay modules

Fully mounted RIF-3 relay modules, consisting of:

- Relay base with push-in connection
- 2 or 3 PDT relay
- Relay retaining bracket
- Input module/interference suppr. module (AC types only)

The advantages:

- Relay with lockable manual operation and status LED
- With DC types, freewheeling diode is integrated into relay
- Mechanical switch position indicator
- Logical contact arrangement thanks to 1/3-level relay base
- Professional bridging of adjacent modules saves wiring time
- For FBS 2-6 jumpers for the input side (A2), see page 374.



RIF-3 relay module with 2 PDT relay

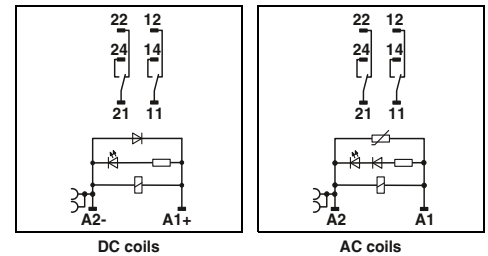

DC coils

AC coils

#### Technical data

	①	②	③
Input data	see diagram		
Permissible range (with reference to $U_N$ )			
Typ. input current at $U_N$	[mA]	60	23 13
Typ. response time at $U_N$	[ms]	18	5 - 15 5 - 15
Typ. release time at $U_N$	[ms]	20	5 - 20 5 - 20
Input circuit AC	Yellow LED, varistor		
Input circuit DC	Yellow LED, freewheeling diode		
Output data	2 PDTs		
Contact type	AgNi		
Contact material	250 V AC/DC		
Max. switching voltage	10 V (at 24 mA)		
Min. switching voltage	10 A (see diagram)		
Limiting continuous current	30 A (20 ms, N/O contact)		
Max. inrush current, AC	30 A (20 ms, N/O contact)		
Max. inrush current, DC	10 mA (at 24 V)		
Min. switching current			
General data	2.5 kV <sub>rms</sub> (50 Hz, 1 min.)		
Test voltage (winding/contact)	-40 °C ... 50 °C		
Ambient temperature (operation), AC	-40 °C ... 60 °C		
Ambient temperature (operation), DC	100% operating factor		
Nominal operating mode	Approx. 2 x 10 <sup>7</sup> cycles		
Mechanical service life, AC	Approx. 2 x 10 <sup>7</sup> cycles		
Mechanical service life, DC	DIN EN 50178, IEC 62103		
Standards/regulations	2 / III		
Pollution degree / surge voltage category	any / can be aligned without spacing		
Mounting position / mounting	0.14 - 1.5 mm <sup>2</sup> / 0.14 - 1.5 mm <sup>2</sup> / 26 - 16		
Connection data solid / stranded / AWG	40 mm / 103 mm / 90 mm		
Dimensions	Class A product, see page 625		
EMC note			

#### Ordering data

Description	Input voltage $U_N$	Type	Order No.	Pcs. / Pkt.
<b>Pre-assembled coupling relay modules</b> with power contact relay and push-in connection	① 24 V DC	RIF-3-RPT-LDP-24DC/2X21	2903297	5
	② 120 V AC	RIF-3-RPT-LV-120AC/2X21	2903296	5
	③ 230 V AC	RIF-3-RPT-LV-230AC/2X21	2903295	5



RIF-3 relay module with 3 PDT relay



### RIF-3-RPT.../2X21 (2 PDTs)

Operating voltage range

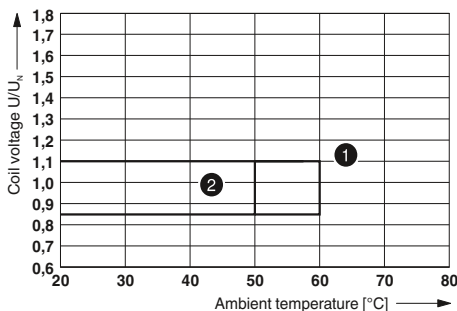

- ① DC coil (observe contact derating)
- ② AC coil (observe contact derating)

Interrupting rating

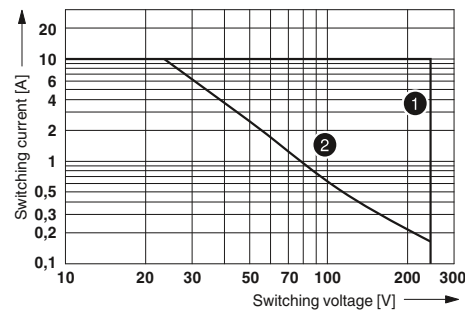

- ① AC, ohmic load
- ② DC, ohmic load

Contact derating

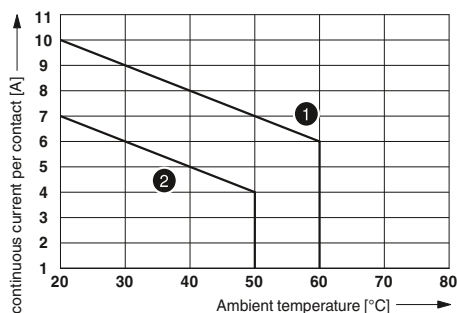

- ① DC coil
- ② AC coil

Electrical service life

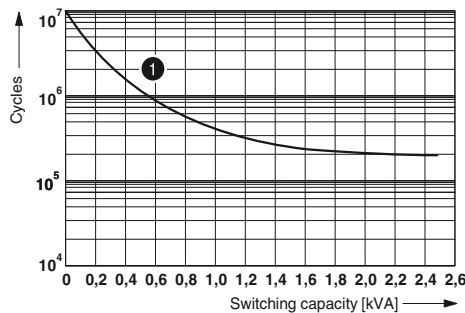

- ① 250 V AC, ohmic load

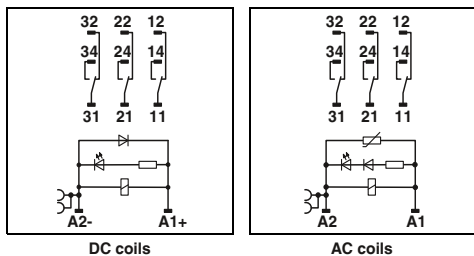

DC coils

AC coils

#### Technical data

- ① see diagram
- ② 60 23 13
- ③ 18 5 - 15 5 - 15
- 20 5 - 20 5 - 20
- Yellow LED, varistor
- Yellow LED, freewheeling diode

- 3 PDTs
- AgNi
- 250 V AC/DC
- 10 V (at 24 mA)
- 8.5 A (see diagram)
- 30 A (20 ms, N/O contact)
- 30 A (20 ms, N/O contact)
- 10 mA (at 24 V)

- 2.5 kV<sub>rms</sub> (50 Hz, 1 min.)
- 40 °C ... 50 °C
- 40 °C ... 60 °C
- 100% operating factor
- Approx. 2 x 10<sup>7</sup> cycles
- Approx. 2 x 10<sup>7</sup> cycles
- DIN EN 50178, IEC 62103
- 2 / III

- any / can be aligned without spacing
- 0.14 - 1.5 mm<sup>2</sup> / 0.14 - 1.5 mm<sup>2</sup> / 26 - 16
- 40 mm / 103 mm / 90 mm
- Class A product, see page 625

#### Ordering data

Type	Order No.	Pcs. / Pkt.
RIF-3-RPT-LDP-24DC/3X21	2903294	5
RIF-3-RPT-LV-120AC/3X21	2903293	5
RIF-3-RPT-LV-230AC/3X21	2903292	5

### RIF-3-RPT.../3X21 (3 PDTs)

Operating voltage range

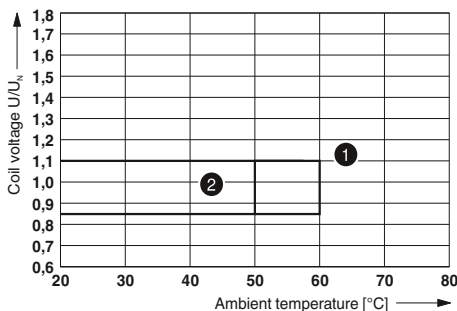

- ① DC coil (observe contact derating)
- ② AC coil (observe contact derating)

Interrupting rating

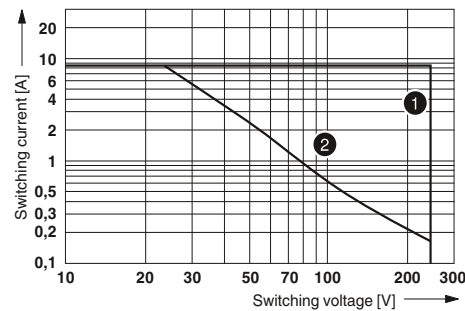

- ① AC, ohmic load
- ② DC, ohmic load

Contact derating

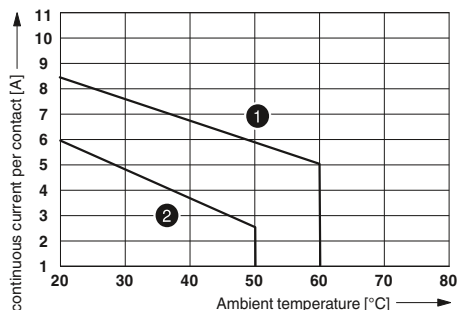

- ① DC coil
- ② AC coil

Electrical service life

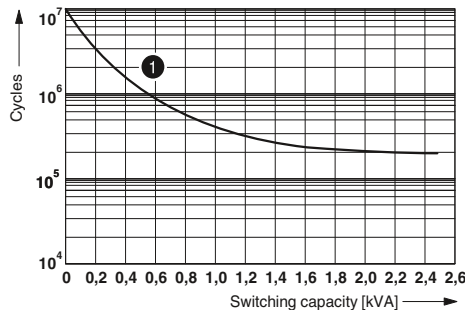

- ① 250 V AC, ohmic load



# Relay modules

## Industrial relay system with push-in connection - RIFLINE complete

### Fully mounted RIF-4 relay modules

Fully mounted RIF-4 relay modules, consisting of:

- Relay base with push-in connection
- 2 or 3 PDT relay
- Relay retaining bracket
- Input module/interference suppr. module

The advantages:

- Logical contact arrangement thanks to 1/3-level relay base
- Professional bridging of adjacent modules saves wiring time
- For FBS 2-6 jumpers for the input side (A2), see page 374.



RIF-4 relay module with 2 PDT relay

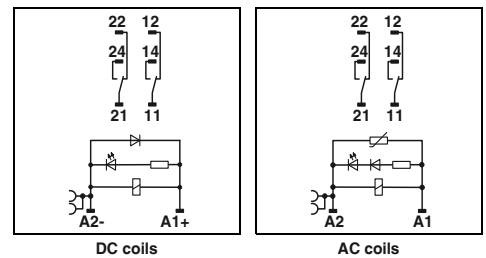

DC coils

AC coils

#### Technical data

	①	②	③
Input data	see diagram		
Permissible range (with reference to $U_N$ )	see diagram		
Typ. input current at $U_N$	[mA]	56	24 14
Typ. response time at $U_N$	[ms]	20	5 - 25 5 - 25
Typ. release time at $U_N$	[ms]	20	5 - 20 5 - 20
Input circuit AC	Yellow LED, varistor		
Input circuit DC	Yellow LED, freewheeling diode, polarity protection diode		
Output data	2 PDTs		
Contact type	AgNi		
Contact material	440 V AC / 250 V DC		
Max. switching voltage	10 V (at 24 mA)		
Min. switching voltage	11 A (see diagram)		
Limiting continuous current	50 A (20 ms, N/O contact)		
Max. inrush current, AC	50 A (20 ms, N/O contact)		
Max. inrush current, DC	10 mA (at 24 V)		
Min. switching current			
Max. interrupting rating, ohmic load	250 V AC	2500 VA	
	440 V AC	4000 VA	
Motor load according to UL 508		1/3 HP, 120 V AC (single-phase AC motor)	1/2 HP, 240 V AC (single-phase AC motor)
General data	2.5 kV <sub>rms</sub> (50 Hz, 1 min.)		
Test voltage (winding/contact)	-40 °C ... 40 °C		
Ambient temperature (operation), AC	-40 °C ... 60 °C		
Ambient temperature (operation), DC	100% operating factor		
Nominal operating mode	Approx. 10 <sup>7</sup> cycles		
Mechanical service life, AC	Approx. 10 <sup>7</sup> cycles		
Mechanical service life, DC	DIN EN 50178, IEC 62103		
Standards/regulations	2 / III		
Pollution degree / surge voltage category	any / can be aligned without spacing		
Mounting position / mounting			
Connection data solid / stranded / AWG	0.14 ... 1.5 mm <sup>2</sup> / 0.14 ... 1.5 mm <sup>2</sup> / 26 - 16		
Input side	0.14 ... 2.5 mm <sup>2</sup> / 0.14 ... 2.5 mm <sup>2</sup> / 26 - 14		
Output side	43 mm / 111 mm / 90 mm		
Dimensions	W / H / D		
EMC note	Class A product, see page 625		

#### Ordering data

Description	Input voltage $U_N$	Type	Order No.	Pcs. / Pkt.
<b>Pre-assembled coupling relay modules</b> with power contact relay and push-in connection	① 24 V DC	RIF-4-RPT-LDP-24DC/2X21	2903281	5
	② 120 V AC	RIF-4-RPT-LV-120AC/2X21	2903280	5
	③ 230 V AC	RIF-4-RPT-LV-230AC/2X21	2903279	5



RIF-4 relay module with 3 PDT relay



### RIF-4-RPT.../2X21 (2 PDTs)

Operating voltage range

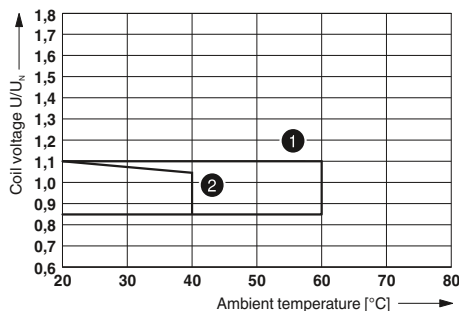

- 1 DC coil (observe contact derating)
- 2 AC coil (observe contact derating)

Interrupting rating

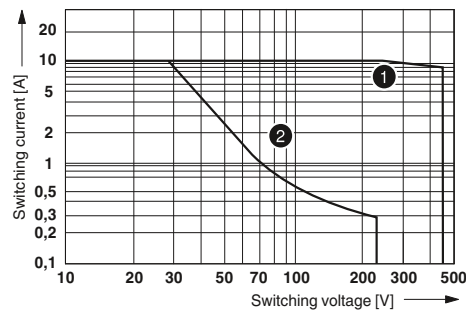

- 1 AC, ohmic load
- 2 DC, ohmic load

Contact derating

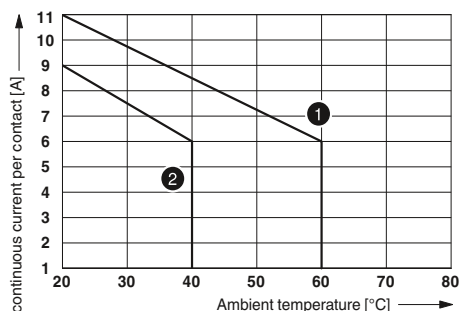

- 1 DC coil
- 2 AC coil

Electrical service life

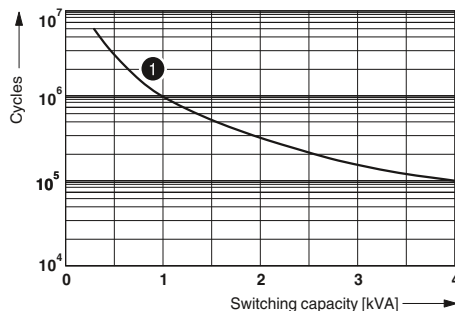

- 1 250 V AC, ohmic load

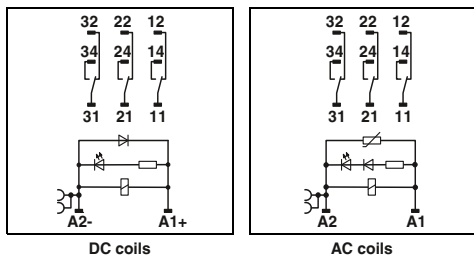

#### Technical data

① ② ③  
 see diagram  
 56 24 14  
 20 5 - 25 5 - 25  
 20 5 - 20 5 - 20  
 Yellow LED, varistor  
 Yellow LED, freewheeling diode, polarity protection diode

3 PDTs  
 AgNi  
 440 V AC / 250 V DC  
 10 V (at 24 mA)  
 10 A (see diagram)  
 50 A (20 ms, N/O contact)  
 50 A (20 ms, N/O contact)  
 10 mA (at 24 V)

2500 VA  
 4000 VA  
 1/3 HP, 120 V AC (single-phase AC motor)  
 1/2 HP, 240 V AC (single-phase AC motor)  
 1/2 HP, 240 V AC (three-phase induction motor)

2.5 kV<sub>rms</sub> (50 Hz, 1 min.)  
 -40 °C ... 40 °C  
 -40 °C ... 60 °C  
 100% operating factor  
 Approx. 10<sup>7</sup> cycles  
 Approx. 10<sup>7</sup> cycles  
 DIN EN 50178, IEC 62103  
 2 / III  
 any / can be aligned without spacing

0.14 ... 1.5 mm<sup>2</sup> / 0.14 ... 1.5 mm<sup>2</sup> / 26 - 16  
 0.14 ... 2.5 mm<sup>2</sup> / 0.14 ... 2.5 mm<sup>2</sup> / 26 - 14  
 43 mm / 111 mm / 90 mm  
 Class A product, see page 625

#### Ordering data

Type	Order No.	Pcs. / Pkt.
RIF-4-RPT-LDP-24DC/3X21	2903278	5
RIF-4-RPT-LV-120AC/3X21	2903277	5
RIF-4-RPT-LV-230AC/3X21	2903276	5

### RIF-4-RPT.../3X21 (3 PDTs)

Operating voltage range

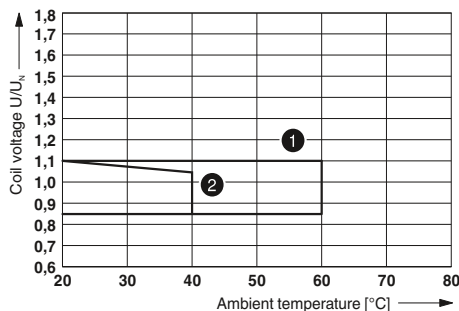

- 1 DC coil (observe contact derating)
- 2 AC coil (observe contact derating)

Interrupting rating

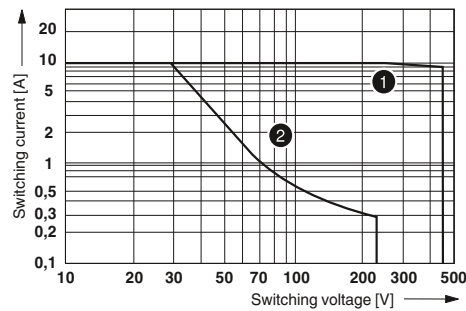

- 1 AC, ohmic load
- 2 DC, ohmic load

Contact derating

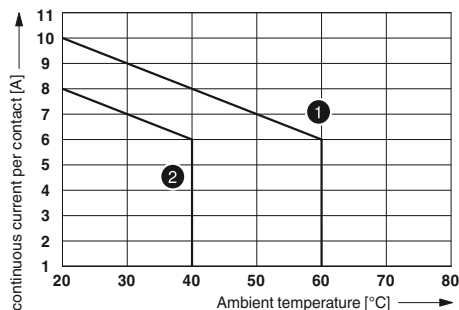

- 1 DC coil
- 2 AC coil

Electrical service life

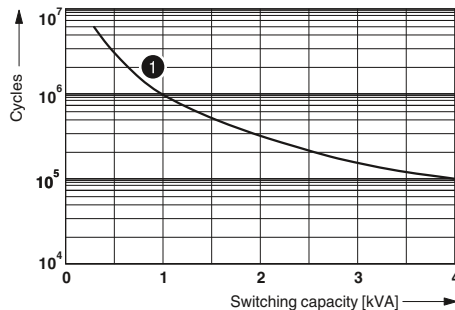

- 1 250 V AC, ohmic load

# Relay modules

## Industrial relay system with push-in connection - RIFLINE complete

### Fully mounted RIF-4 relay modules

- Fully mounted RIF-4 relay modules, consisting of:
- Relay base with push-in connection
  - 3 N/O relay
  - Relay retaining bracket
  - Input module/interference suppr. module



RIF-4 relay module with 3 N/O relay

- The advantages:
- Logical contact arrangement thanks to 1/3-level relay base
  - Full shutdown by means of  $\geq 3$  mm contact opening
  - Professional bridging of adjacent modules saves wiring time
  - For FBS 2-6 jumpers for the input side (A2), see page 374.

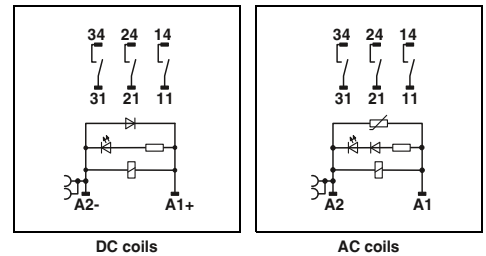

DC coils

AC coils

#### Technical data

	①	②	③
<b>Input data</b>	see diagram		
Permissible range (with reference to $U_N$ )	70	24	14
Typ. input current at $U_N$	[mA]	20	5 - 25
Typ. response time at $U_N$	[ms]	20	5 - 20
Typ. release time at $U_N$	[ms]	20	5 - 20
Input circuit AC	Yellow LED, varistor		
Input circuit DC	Yellow LED, freewheeling diode, polarity protection diode		
<b>Output data</b>	3 N/O contacts		
Contact type	AgNi		
Contact material	440 V AC / 250 V DC		
Max. switching voltage	10 V (at 24 mA)		
Min. switching voltage	10 A (see diagram)		
Limiting continuous current	50 A (20 ms, N/O contact)		
Max. inrush current, AC	50 A (20 ms, N/O contact)		
Max. inrush current, DC	10 mA (at 24 V)		
Min. switching current			
Max. interrupting rating, ohmic load	250 V AC	2500 VA	
	440 V AC	4000 VA	
Motor load according to UL 508	1/3 HP, 120 V AC (single-phase AC motor)		
	1/2 HP, 240 V AC (single-phase AC motor)		
	1/2 HP, 240 V AC (three-phase induction motor)		
<b>General data</b>	2.5 kV <sub>rms</sub> (50 Hz, 1 min.)		
Test voltage (winding/contact)	-40 °C ... 40 °C		
Ambient temperature (operation), AC	-40 °C ... 60 °C		
Ambient temperature (operation), DC	100% operating factor		
Nominal operating mode	Approx. 10 <sup>7</sup> cycles		
Mechanical service life, AC	Approx. 10 <sup>7</sup> cycles		
Mechanical service life, DC	DIN EN 50178, IEC 62103		
Standards/regulations	2 / III		
Pollution degree / surge voltage category	any / can be aligned without spacing		
Mounting position / mounting			
Connection data solid / stranded / AWG	0.14 ... 1.5 mm <sup>2</sup> / 0.14 ... 1.5 mm <sup>2</sup> / 26 - 16		
Input side	0.14 ... 2.5 mm <sup>2</sup> / 0.14 ... 2.5 mm <sup>2</sup> / 26 - 14		
Output side	43 mm / 111 mm / 90 mm		
Dimensions	Class A product, see page 625		
EMC note			

#### Ordering data

Description	Input voltage $U_N$	Type	Order No.	Pcs. / Pkt.
<b>Pre-assembled coupling relay modules</b> with power contact relay and push-in connection	① 24 V DC	RIF-4-RPT-LDP-24DC/3X1	2903275	5
	② 120 V AC	RIF-4-RPT-LV-120AC/3X1	2903274	5
	③ 230 V AC	RIF-4-RPT-LV-230AC/3X1	2903273	5

### RIF-4-RPT.../3X1 (3 N/O contacts)

Operating voltage range

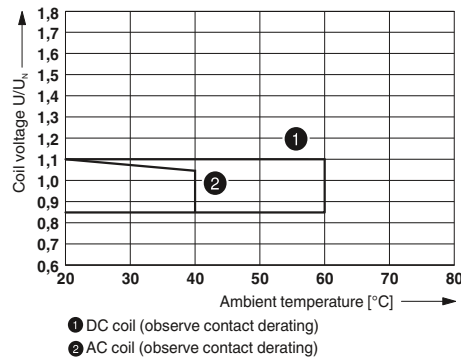

Interrupting rating

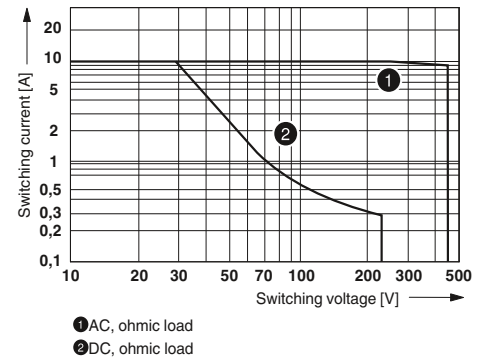

Contact derating

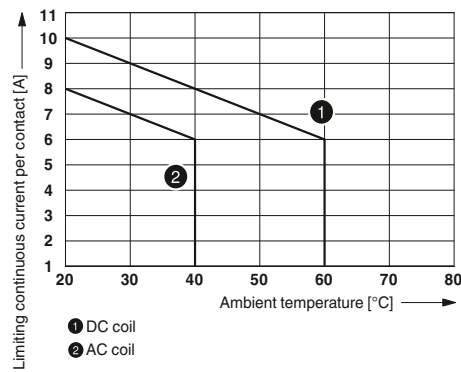

Electrical service life

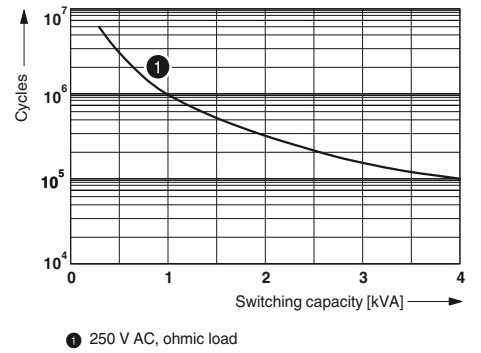

# Relay modules

## Industrial relay system with push-in connection - RIFLINE complete

### RIFLINE complete accessories

#### Jumpers

The jumpers can be used for simple potential distribution via all relay bases.

The end bracket is used for safe isolation between adjacent modules and to visually separate the various function groups.



Description	Color	Ordering data			Ordering data		
		Type	Order No.	Pcs. / Pkt.	Type	Order No.	Pcs. / Pkt.
<b>Jumper</b>							
2-pos. red, 32 A		FBS 2-6	3030336	50			
2-pos. blue, 32 A		FBS 2-6 BU	3036932	50			
2-pos. gray, 32 A		FBS 2-6 GY	3032237	50			
5-pos. red, 32 A		FBS 5-6	3030349	50			
10-pos. red, 32 A		FBS 10-6	3030271	10			
20-pos. red, 32 A		FBS 20-6	3030365	10			
50-pos. red, 32 A		FBS 50-6	3032224	10			
2-pos. red, 41 A		FBS 2-8	3030284	10			
2-pos. blue, 41 A		FBS 2-8 BU	3032567	10			
2-pos. gray, 41 A		FBS 2-8 GY	3032541	10			
<b>End bracket</b> , for snapping onto NS 35, 9.5 mm wide, can be marked with ZB 6, ZB 8/27, KLM...							
			7042		CLIPFIX 35	3022218	50

### RIFLINE complete accessories

#### Marking material

The ZB zack band system offers numerous marking options that can be attached directly to the relay retaining brackets. In addition, further markings can be fixed to the relay base by means of double marker carriers.

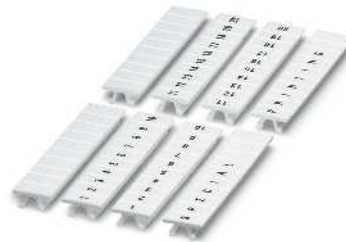

5.2 mm, 6.2 mm, and 15.2 mm wide



Double marker carrier

Description	Color	Ordering data			Ordering data		
		Type	Order No.	Pcs. / Pkt.	Type	Order No.	Pcs. / Pkt.
<b>Zack marker strip, unprinted</b>							
10-section	white	ZB 5 :UNBEDRUCKT	1050004	10			
10-section	white	ZB 6:UNBEDRUCKT	1051003	10			
5-section	white	ZB 15:UNBEDRUCKT	0811972	10			
<b>Double marker carrier for ZB 5</b>	gray				STP 5-2	0800967	100

**RIFLINE complete accessories**

**Test plug**

The two-piece test plug offers individual plug color combinations. The test plug is inserted directly in the function shaft of the push-in connection.



		Ordering data		
Description	Color	Type	Order No.	Pcs. / Pkt.
<b>Test plug</b> , consisting of:				
<b>Metal part</b> for 2.3 mm Ø socket hole and	silver	<b>MPS-MT</b>	<b>0201744</b>	10
<b>Insulating sleeve</b> , for MPS metal part	red	<b>MPS-IH RD</b>	<b>0201676</b>	10
	white	<b>MPS-IH WH</b>	<b>0201663</b>	10
	blue	<b>MPS-IH BU</b>	<b>0201689</b>	10
	yellow	<b>MPS-IH YE</b>	<b>0201692</b>	10
	green	<b>MPS-IH GN</b>	<b>0201702</b>	10
	gray	<b>MPS-IH GY</b>	<b>0201728</b>	10
	black	<b>MPS-IH BK</b>	<b>0201731</b>	10

**Adapter for RIFLINE complete**

RIF-1-V8... is the VARIOFACE adapter which connects the RIF-1 relay modules with the VARIOFACE system cabling. This allows easy connection of eight relay modules to a controller.

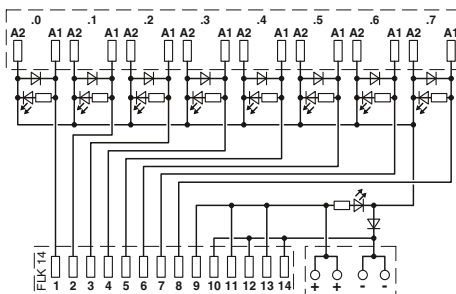

new

**VARIOFACE adapter for RIFLINE complete RIF-1**

		Technical data	
Max. perm. operating voltage		30 V DC	
Max. perm. current (per branch)		1 A (per signal path)	
Max total current (voltage supply)		3 A	
Rated surge voltage		0.6 kV (functional insulation)	
Ambient temperature (operation)		-40 °C ... 60 °C	
Mounting position		any	
Standards/regulations		IEC 60664, IEC 62103, DIN EN 50178	
Connection data solid / stranded / AWG		0.2 ... 1.5 mm <sup>2</sup> / 0.2 ... 1.5 mm <sup>2</sup> / 24 - 16	
Dimensions	H / D	101 mm / 75 mm	

		Ordering data			
Description	No. of pos.	Module width W	Type	Order No.	Pcs. / Pkt.
<b>V8 adapter</b> , for eight RIF-1 relay modules, with FLK connection for PLC system cabling, <b>positive switching</b>					
		128 mm	<b>RIF-1-V8/PT/FLK14/OUT</b>	<b>2905195</b>	1



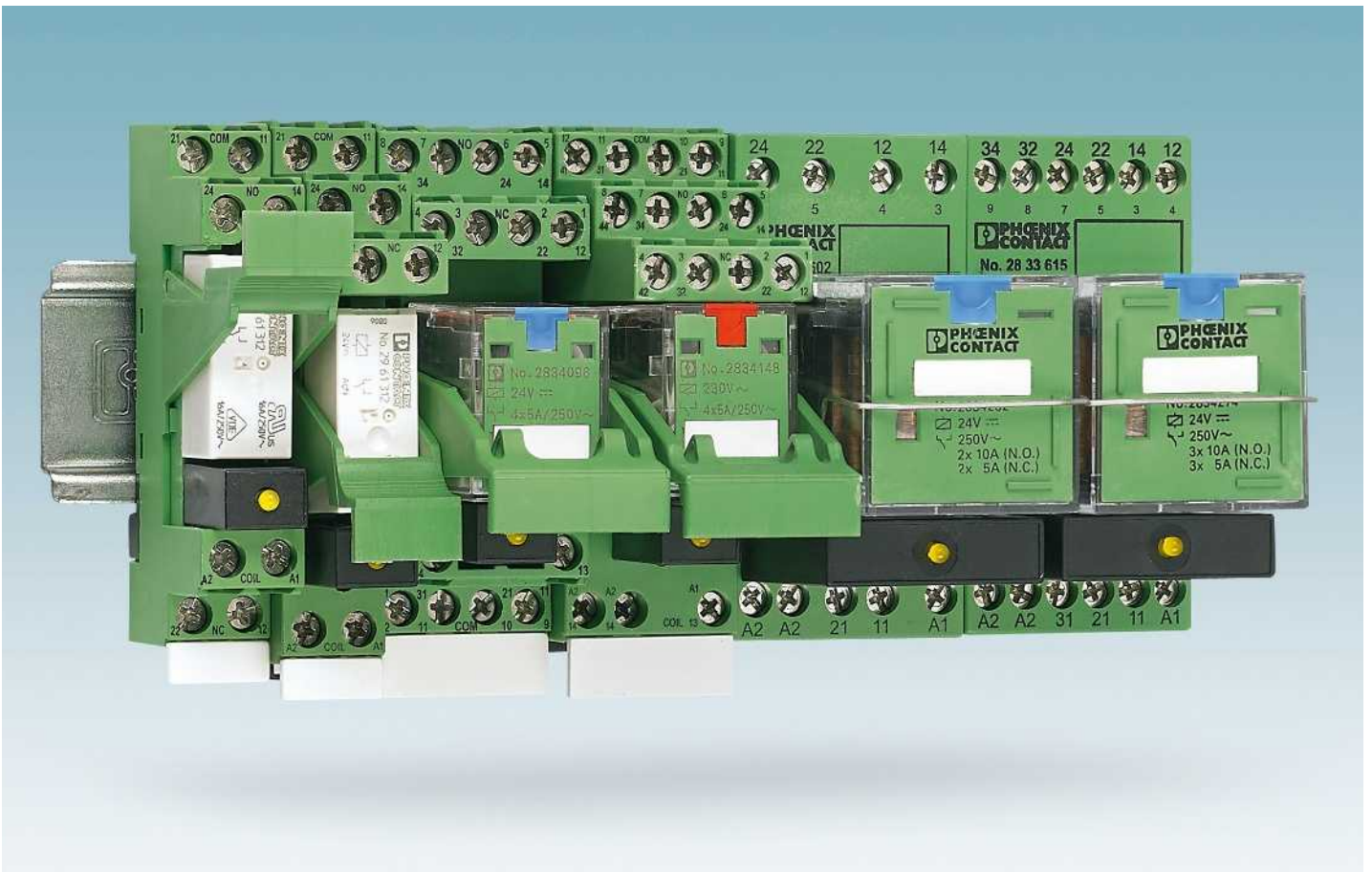

The PR series is a low-priced relay modular system, consisting of DIN rail bases, relays, plug-in input/interference suppression modules, engagement levers and the matching marking labels and universal bridging materials for all bases. The modules are largely compatible with the usual standards on the market, have the major international approvals, and are therefore accepted worldwide.

The PR series also boasts its own particular features:

- Relay retaining bracket: the EL... plastic relay retaining brackets, with which the relays can be held and, if necessary, ejected, have an exposed, smooth, large equipment marking area for standard self-adhesive labels that can be printed easily and inexpensively using standard printers. When fitted, the engagement lever is securely connected to the base, which means that the marking cannot be lost.
- Industrial relays: as standard, all REL-IR... industrial relays have an LED status display and all DC types also have an integrated freewheeling diode. In most cases, this eliminates the plug-in input modules that are otherwise also used.
- Plug-in input modules with RC element: most standard input/interference suppression modules with an RC element used for compensation of interference

coupling on long lines or in the event of leakage currents from electronic AC outputs have only low capacitance values. This greatly limits the filter effect. In contrast, the RC-120-230UC and RC3-120-230UC plug-in module series for mains voltage applications have a filter function that is improved up to a factor of 10. Unlike with the discharge resistors that are normally used for such applications, using RC plug-in modules does not result in any additional heating.

**PR1 series**

The narrow 16 mm PR1 base series for relays with one or two contacts.

Traditional 2/2-level bases are available and there is also a choice of two modern "logical" 1/3-level versions with fully opposite coil and contact connections.

**PR2 series**

The PR2 base series accommodates plug-in industrial relays with two or four PDT contacts.

Just like the PR1 series, the bases are available in traditional 2/2-level and the modern "logical" 1/3-level versions.

**PR3 series**

The robust octal relays with two or three PDT contacts that are widely used in some areas fit on the PR3 base with shock-proof screw connections. All the base connections have a wide connection cross section and are arranged on one level with good accessibility.

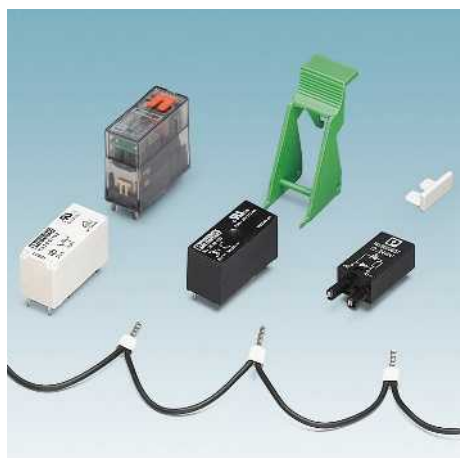

The active components of the PR1 modular system include various miniature power relays (optionally available with manual test function) and electronic solid-state relays. Matching relay retaining brackets with integrated marking area prevent them from being shaken loose. Depending on requirements, input/interference suppression modules with various functions can also be plugged in. Marking labels and loop bridges in various colors that are suitable for universal use with all PR bases complete the range of accessories.



The PR2 modular system is specifically designed for plug-in industrial relays. Industrial relays from Phoenix Contact feature the following as standard: a manual test button, switch position indicator, status LED, and freewheeling diode (DC coils only). Interference suppression modules with a varistor or RC element can also be plugged in as an option. Relay retaining brackets with integrated marking areas prevent the relays from being shaken loose. Marking labels and loop bridges in various colors that are suitable for universal use with all PR bases complete the range of accessories.

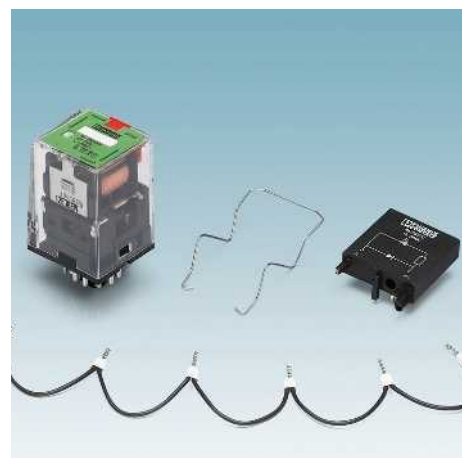

The PR3 modular system is specifically designed for the robust octal relays. The relays have a switch position indicator and a manual test button and there is a wire bracket to prevent them from being shaken loose. Input/interference suppression modules with various functions can also be plugged in as an option. The base can be marked with an 8 x 20 mm standard adhesive label. Loop bridges in various colors for universal use round off the range of accessories.

# Relay modules

## Industrial relay system with screw connection - PR series

### Modular PR1 relay base

- Relay base family that can be fitted with 1 PDT or 2 PDT relay or solid-state relay
- Range of accessories includes:
- Plug-in input modules/interference suppr. modules
  - Relay retaining bracket with marking field and ejection function
  - Marking labels
  - Loop bridges

Notes:
Type of housing: Polyamide fiber reinforced PA-F, color: green.
Marking systems and mounting material See Catalog 5

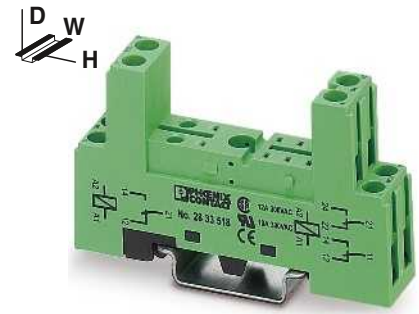

2/2-level design with screw connection



Nominal voltage $U_N$	300 V AC/DC
Nominal current at $U_N$	12 A
<b>General data</b>	
Ambient temperature (operation)	-25 °C ... 85 °C
Connection data solid / stranded / AWG	0.2 ... 2.5 mm <sup>2</sup> / 0.2 ... 2.5 mm <sup>2</sup> / 26 - 14
Dimensions	
Width	16 mm
Depth with retaining bracket	63 mm (EL1-P16) 71 mm (EL1-P25)
Height	75 mm

### Technical data

Nominal voltage $U_N$	300 V AC/DC
Nominal current at $U_N$	12 A
<b>General data</b>	
Ambient temperature (operation)	-25 °C ... 85 °C
Connection data solid / stranded / AWG	0.2 ... 2.5 mm <sup>2</sup> / 0.2 ... 2.5 mm <sup>2</sup> / 26 - 14
Dimensions	
Width	16 mm
Depth with retaining bracket	63 mm (EL1-P16) 71 mm (EL1-P25)
Height	75 mm

Description
<b>PR1 relay base</b> , 2/2-level design, plug-in option for input/interference suppression module, safe isolation I/O, including ten MP1 marking labels per pack
With screw connection <b>PR1 relay base</b> , 1/3-level design, plug-in option for input/interference suppression module, safe isolation I/O, including ten MP1 marking labels per pack
With screw connection <b>Relay retaining bracket</b> , with ejector function and integrated equipment marking area (7.5 x 15 mm), suitable for PR1 relay base
for 16 mm tall miniature power relay and solid-state relay
for 25 mm tall miniature power relay and solid-state relay

### Ordering data

Type	Order No.	Pcs. / Pkt.
<b>PR1-BSC2/2X21</b>	2833518	10
<b>EL1-P16</b>	2833547	10
<b>EL1-P25</b>	2833550	10

<b>Equipment marking label</b> , marking area 6 x 15 mm
<b>Device marking label</b> , for thermal transfer printer, marking area 6 x 15 mm 2500 labels per roll
<b>Loop bridge</b> , 50-pos., divisible, max. bridging distance 60 mm, 0.5 mm <sup>2</sup>
blue
black
gray

### Accessories

	Order No.	Pcs. / Pkt.
<b>MP 1</b>	2833631	10
<b>EML (15X6) R YE</b>	0819288	1
<b>DB 50- 90 BU</b>	2821180	1
<b>DB 50- 90 BK</b>	2820916	1
<b>DB 50- 90 GY</b>	2820929	1

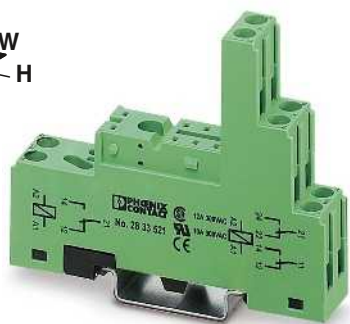

1/3-level design with screw connection



Relay retaining bracket



Technical data			Technical data		
300 V AC/DC			-		
12 A			-		
-25 °C ... 85 °C			-		
0.2 ... 2.5 mm <sup>2</sup> / 0.2 ... 2.5 mm <sup>2</sup> / 26 - 14			-		
16 mm			-		
71 mm (EL1-P16)			-		
79 mm (EL1-P25)			-		
78.5 mm			-		
Ordering data			Ordering data		
Type	Order No.	Pcs. / Pkt.	Type	Order No.	Pcs. / Pkt.
PR1-BSC3/2X21	2833521	10			
EL1-P16	2833547	10	EL1-P16	2833547	10
EL1-P25	2833550	10	EL1-P25	2833550	10
Accessories			Accessories		
MP 1	2833631	10			
EML (15X6) R YE	0819288	1			
DB 50- 90 BU	2821180	1			
DB 50- 90 BK	2820916	1			
DB 50- 90 GY	2820929	1			

# Relay modules

## Industrial relay system with screw connection - PR series

### Plug-in miniature power relays

Plug-in miniature power relays with 1 or 2 PDT contacts, suitable for RIF-1, PR1, and PLC-INTERFACE relay bases.

The advantages:

- Power contacts up to 16 A
- Multi-layer gold contact or power contact
- High degree of protection up to RT III (comparable with IP67) depending on type



1 PDT relay



2 PDT relay

**Notes:**  
If the specified maximum values for multi-layer contact relays are exceeded, the gold plating is destroyed. The maximum values of the power contact relay are then valid. This can result in a shorter service life than with a pure power contact.

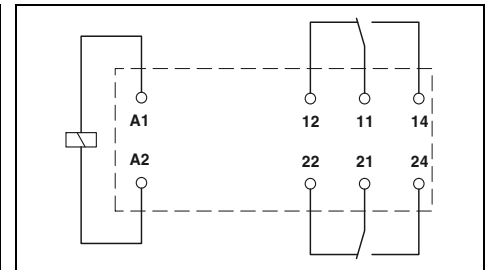
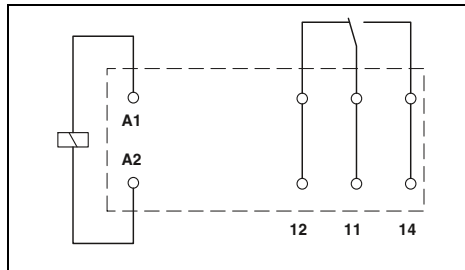

#### Technical data

Input data	①	②	③	④	⑤	⑥	⑦	⑧
Permissible range (with reference to $U_N$ )	see diagram							
Typ. input current at $U_N$	33	17	8.7	8.2	4.1	32	7	3
Typ. response time at $U_N$	7	7	7	7	7			
Typ. response time at $U_N$ (depending on phase relation)						3 - 12	3 - 12	3 - 12
Typ. release time at $U_N$	3	3	3	3	3			
Typ. release time at $U_N$ (depending on phase relation)						2 - 9	2 - 9	2 - 9

①	②	③	④	⑤	⑥	⑦	⑧
see diagram							
33	17	8.7	8.2	4.1	32	7	3
7	7	7	7	7			
					3 - 12	3 - 12	3 - 12
3	3	3	3	3			
					2 - 9	2 - 9	2 - 9

#### Technical data

①	②	③	④	⑤	⑥	⑦	⑧
see diagram							
33	17	8.7	8.2	4.1	32	7	3
7	7	7	7	7			
					3 - 12	3 - 12	3 - 12
3	3	3	3	3			
					2 - 9	2 - 9	2 - 9

Output data	①	②	③	④	⑤	⑥	⑦	⑧
Contact type	1 PDT				1 PDT			
Contact material	AgNi				AgNi, hard gold-plated			
Max. switching voltage	250 V AC/DC				30 V AC / 36 V DC			
Min. switching voltage	12 V (at 10 mA)				100 mV (at 10 mA)			
Limiting continuous current	16 A				50 mA			
Max. inrush current	25 A (20 ms)				50 mA			
Min. switching current	10 mA (at 12 V)				1 mA (at 24 V)			
Max. interrupting rating, ohmic load	250 V AC				-			
General data	4000 VA				-			
Test voltage (winding/contact)	5 kV AC (50 Hz, 1 min.)							
Test voltage (contact/contact)	-							
Ambient temperature (operation)	-40 °C ... 85 °C							
Mechanical service life	1 x 10 <sup>7</sup> cycles							
Electrical service life	see diagram							
Standards/regulations	IEC 60664, EN 50178, IEC 62103							

①	②	③	④	⑤	⑥	⑦	⑧
see diagram							
33	17	8.7	8.2	4.1	32	7	3
7	7	7	7	7			
					3 - 12	3 - 12	3 - 12
3	3	3	3	3			
					2 - 9	2 - 9	2 - 9

①	②	③	④	⑤	⑥	⑦	⑧
see diagram							
33	17	8.7	8.2	4.1	32	7	3
7	7	7	7	7			
					3 - 12	3 - 12	3 - 12
3	3	3	3	3			
					2 - 9	2 - 9	2 - 9

#### Ordering data

Description	Input voltage $U_N$
<b>Plug-in miniature power relay</b>	
with power contacts	① 12 V DC
with power contacts	② 24 V DC
with power contacts	③ 48 V DC
with power contacts	④ 60 V DC
with power contacts	⑤ 110 V DC
with power contacts	⑥ 24 V AC
with power contacts	⑦ 120 V AC
with power contacts	⑧ 230 V AC
<b>Plug-in miniature power relay</b>	
with multi-layer gold contacts	① 12 V DC
with multi-layer gold contacts	② 24 V DC
with multi-layer gold contacts	③ 48 V DC
with multi-layer gold contacts	④ 60 V DC
with multi-layer gold contacts	⑤ 110 V DC
with multi-layer gold contacts	⑥ 24 V AC
with multi-layer gold contacts	⑦ 120 V AC
with multi-layer gold contacts	⑧ 230 V AC

Type	Order No.	Pcs. / Pkt.
REL-MR- 12DC/21HC	2961309	10
REL-MR- 24DC/21HC	2961312	10
REL-MR- 48DC/21HC	2834821	10
REL-MR- 60DC/21HC	2961325	10
REL-MR-110DC/21HC	2961338	10
REL-MR- 24AC/21HC	2961406	10
REL-MR-120AC/21HC	2961419	10
REL-MR-230AC/21HC	2961422	10
REL-MR- 12DC/21HC AU	2961532	10
REL-MR- 24DC/21HC AU	2961545	10
REL-MR-110DC/21HC AU	2961561	10
REL-MR- 24AC/21HC AU	2961503	10
REL-MR-120AC/21HC AU	2961516	10
REL-MR-230AC/21HC AU	2961529	10

#### Ordering data

Type	Order No.	Pcs. / Pkt.
REL-MR- 12DC/21-21	2961257	10
REL-MR- 24DC/21-21	2961192	10
REL-MR- 48DC/21-21	2834834	10
REL-MR- 60DC/21-21	2961273	10
REL-MR-110DC/21-21	2961202	10
REL-MR- 24AC/21-21	2961435	10
REL-MR-120AC/21-21	2961448	10
REL-MR-230AC/21-21	2961451	10
REL-MR- 12DC/21-21AU	2961299	10
REL-MR- 24DC/21-21AU	2961215	10
REL-MR- 48DC/21-21AU	2834847	10
REL-MR- 60DC/21-21AU	2961286	10
REL-MR-110DC/21-21AU	2961228	10
REL-MR- 24AC/21-21AU	2961464	10
REL-MR-120AC/21-21AU	2961477	10
REL-MR-230AC/21-21AU	2961480	10



### REL-MR...21HC... (1 PDT)

Operating voltage range

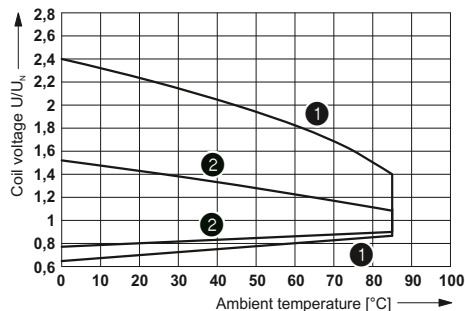

- 1 DC coils
- 2 AC coils

Interrupting rating

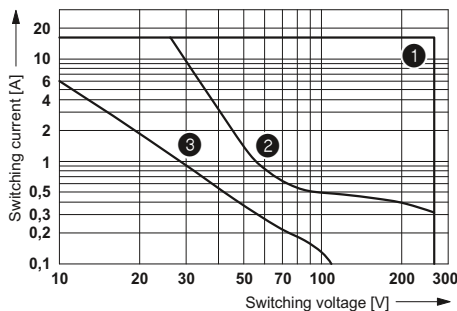

- 1 AC, ohmic load
- 2 DC, ohmic load
- 3 DC, L/R = 40 ms

Electrical service life

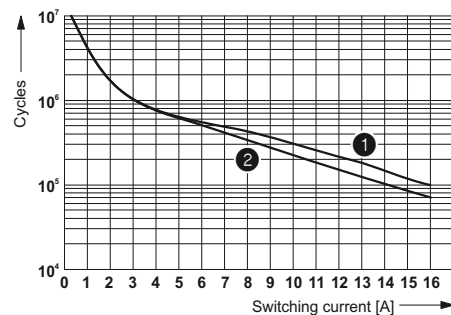

- 1 250 V AC, ohmic load (DC coils)
- 2 250 V AC, ohmic load (AC coils)

Service life reduction factor with various cos phi

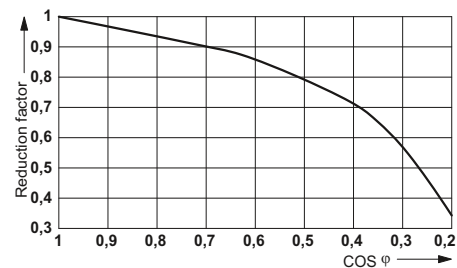

### REL-MR...21-21... (2 PDTs)

Operating voltage range

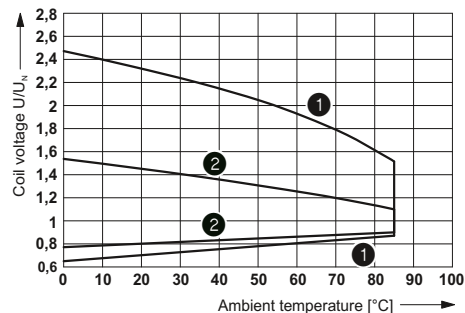

- 1 DC coils
- 2 AC coils

Interrupting rating

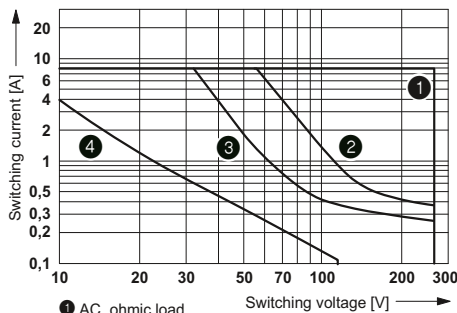

- 1 AC, ohmic load
- 2 DC, ohmic load, contacts in series
- 3 DC, ohmic load
- 4 DC, L/R = 40 ms

Electrical service life

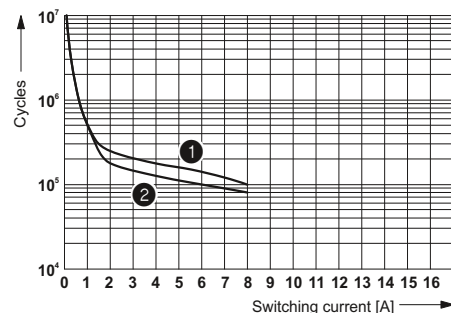

- 1 250 V AC, ohmic load (DC coils)
- 2 250 V AC, ohmic load (AC coils)

Service life reduction factor with various cos phi

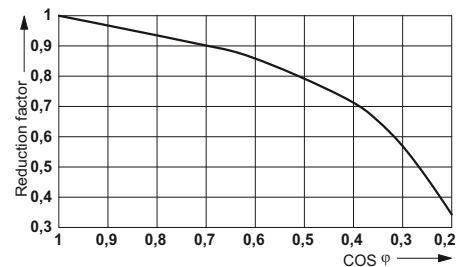



# Relay modules

## Industrial relay system with screw connection - PR series

### Plug-in miniature power relays

Plug-in miniature power relays with 1 or 2 PDT contacts, suitable for RIF-1 and PR1 relay bases.

The advantages:

- Switching current of up to 16 A
- With lockable manual operation
- Mechanical switch position indicator
- Integrated status LED
- Multi-layer gold contact or power contact
- DC types with integrated freewheeling diode
- Can be soldered in on PCB



1 PDT relay



2 PDT relay

**Notes:**

If the specified maximum values for multi-layer contact relays are exceeded, the gold plating is destroyed. The maximum values of the power contact relay are then valid. This can result in a shorter service life than with a pure power contact.

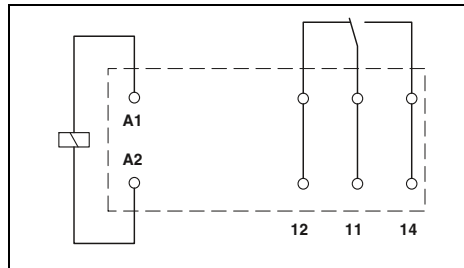

**Technical data**

Input data	①	②	③	④
Permissible range (with reference to U <sub>N</sub> )	see diagram			
Typ. input current at U <sub>N</sub>	18	32	7	3.5
Typ. response time at U <sub>N</sub>	9			
Typ. response time at U <sub>N</sub> (depending on phase relation)		3 - 12	3 - 12	
Typ. release time at U <sub>N</sub>	6			
Typ. release time at U <sub>N</sub> (depending on phase relation)		2 - 8	2 - 8	2 - 8

Output data	1 PDT	1 PDT
Contact type	1 PDT	1 PDT
Contact material	AgNi	AgNi, hard gold-plated
Max. switching voltage	250 V AC/DC	30 V AC / 36 V DC
Min. switching voltage	12 V (at 10 mA)	12 V (at 1 mA)
Limiting continuous current	16 A	50 mA
Max. inrush current	32 A (20 ms)	50 mA
Min. switching current	10 mA (at 12 V)	1 mA (at 12 V)
Max. interrupting rating, ohmic load	250 V AC	4000 VA

General data	1 PDT	1 PDT
Test voltage (winding/contact)	5 kV AC (50 Hz, 1 min.)	5 kV AC (50 Hz, 1 min.)
Test voltage (contact/contact)	-	-
Ambient temperature (operation)	-40 °C ... 70 °C	-40 °C ... 70 °C
Mechanical service life	5 x 10 <sup>6</sup> cycles	5 x 10 <sup>6</sup> cycles
Electrical service life	see diagram	see diagram
Standards/regulations	DIN EN 61810-1, VDE 0435-201, EN 50178, IEC 62103	DIN EN 61810-1, VDE 0435-201, EN 50178, IEC 62103

**Ordering data**

Description	Input voltage U <sub>N</sub>	Type	Order No.	Pcs. / Pkt.
<b>Plug-in miniature power relay, with power contacts</b>				
- Status LED, freewheeling diode A1+, A2-	① 24 V DC	REL-MR- 24DC/21HC/MS	2987888	10
- Status LED	② 24 V AC	REL-MR- 24AC/21HC/MS	2987891	10
- Status LED	③ 120 V AC	REL-MR-120AC/21HC/MS	2987901	10
- Status LED	④ 230 V AC	REL-MR-230AC/21HC/MS	2987914	10
<b>Plug-in miniature power relay, with multi-layer gold contacts, with manual operation, mechanical switch position indicator</b>				
- Status LED, freewheeling diode A1+, A2-	① 24 V DC	REL-MR- 24DC/21HC AU/MS	2987927	10
- Status LED	④ 230 V AC	REL-MR-230AC/21HC AU/MS	2987930	10

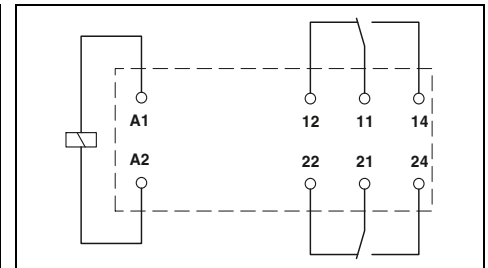

**Technical data**

Input data	①	②	③	④
Permissible range (with reference to U <sub>N</sub> )	see diagram			
Typ. input current at U <sub>N</sub>	18	32	7	3.5
Typ. response time at U <sub>N</sub>	9			
Typ. response time at U <sub>N</sub> (depending on phase relation)		3 - 12	3 - 12	3 - 12
Typ. release time at U <sub>N</sub>	6			
Typ. release time at U <sub>N</sub> (depending on phase relation)		2 - 8	2 - 8	2 - 8

Output data	2 PDTs	2 PDTs
Contact type	2 PDTs	2 PDTs
Contact material	AgNi	AgNi, hard gold-plated
Max. switching voltage	250 V AC/DC	30 V AC / 36 V DC
Min. switching voltage	12 V (at 10 mA)	12 V (at 1 mA)
Limiting continuous current	8 A	50 mA
Max. inrush current	16 A (20 ms)	50 mA
Min. switching current	10 mA (at 12 V)	1 mA (at 12 V)
Max. interrupting rating, ohmic load	2000 VA	-

General data	2 PDTs	2 PDTs
Test voltage (winding/contact)	5 kV AC (50 Hz, 1 min.)	5 kV AC (50 Hz, 1 min.)
Test voltage (contact/contact)	2.5 kV AC (50 Hz, 1 min.)	2.5 kV AC (50 Hz, 1 min.)
Ambient temperature (operation)	-40 °C ... 70 °C	-40 °C ... 70 °C
Mechanical service life	5 x 10 <sup>6</sup> cycles	5 x 10 <sup>6</sup> cycles
Electrical service life	see diagram	see diagram
Standards/regulations	DIN EN 61810-1, VDE 0435-201, EN 50178, IEC 62103	DIN EN 61810-1, VDE 0435-201, EN 50178, IEC 62103

**Ordering data**

Description	Input voltage U <sub>N</sub>	Type	Order No.	Pcs. / Pkt.
<b>Plug-in miniature power relay, with power contacts</b>				
- Status LED, freewheeling diode A1+, A2-	① 24 V DC	REL-MR- 24DC/21-21/MS	2987943	10
- Status LED	② 24 V AC	REL-MR- 24AC/21-21/MS	2987956	10
- Status LED	③ 120 V AC	REL-MR-120AC/21-21/MS	2987969	10
- Status LED	④ 230 V AC	REL-MR-230AC/21-21/MS	2987972	10
<b>Plug-in miniature power relay, with multi-layer gold contacts, with manual operation, mechanical switch position indicator</b>				
- Status LED, freewheeling diode A1+, A2-	① 24 V DC	REL-MR- 24DC/21-21AU/MS	2987985	10
- Status LED	④ 230 V AC	REL-MR-230AC/21-21AU/MS	2987998	10

### REL-MR...21HC...MS (1 PDT)

Operating voltage range

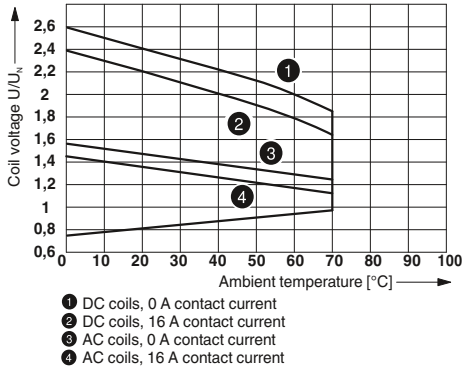

Interrupting rating

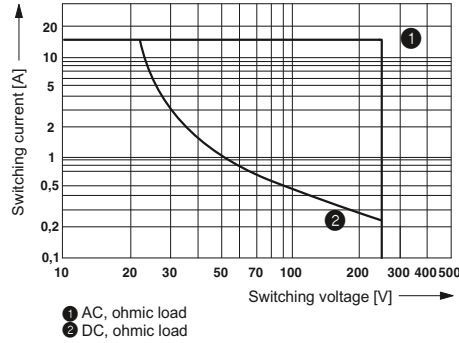

Electrical service life

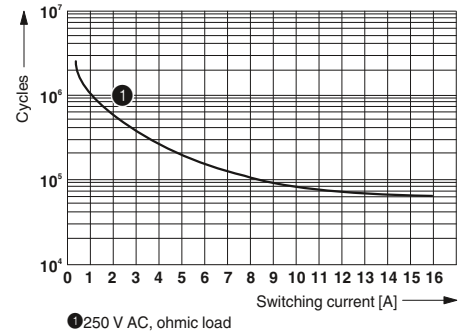

Service life reduction factor with various cos phi

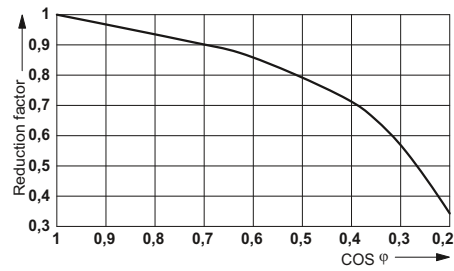

### REL-MR...21-21...MS (2 PDTs)

Operating voltage range

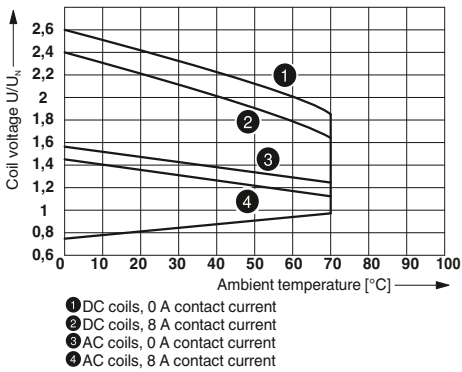

Interrupting rating

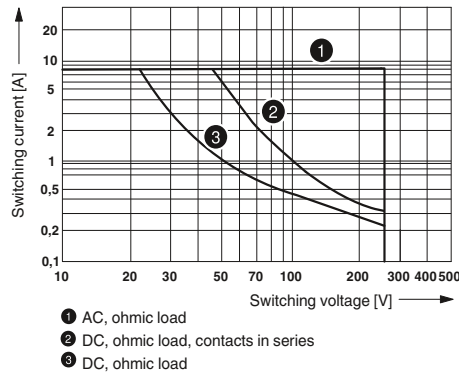

Electrical service life

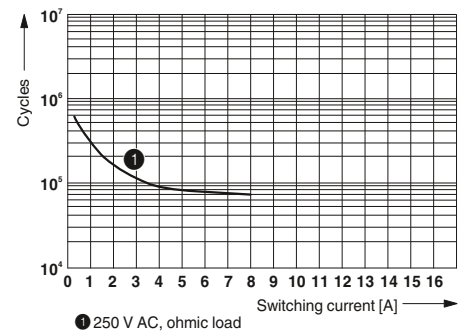

Service life reduction factor with various cos phi

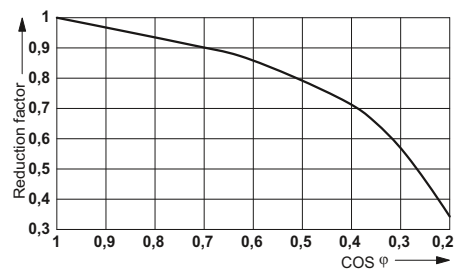

# Relay modules

## Industrial relay system with screw connection - PR series

### Modular PR2 relay base

Relay base family that can be fitted with 2 PDT or 4 PDT relays

Range of accessories includes:

- Plug-in input modules/interference suppression modules
- Relay retaining bracket with marking field and ejection function
- Marking labels
- Loop bridges

Notes:
Type of housing: Polyamide fiber reinforced PA-F, color: green.
Marking systems and mounting material See Catalog 5

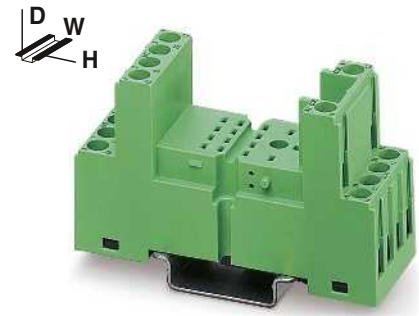

2/2-level design with screw connection



Technical data	
Nominal voltage $U_N$	300 V AC/DC
Nominal current at $U_N$	12 A
General data	
Ambient temperature (operation)	-25 °C ... 85 °C
Connection data solid / stranded / AWG	0.2 ... 2.5 mm <sup>2</sup> / 0.2 ... 2.5 mm <sup>2</sup> / 26 - 14
Dimensions	
Width	27 mm
Depth with retaining bracket	84 mm (EL2-P35)
Height	75 mm

Ordering data			
Description	Type	Order No.	Pcs. / Pkt.
<b>PR2-B relay base</b> , for industrial relay, REL-IR with two or four PDTs, 2/2-level design, connection option for input/interference suppression module, including ten MP2 marking labels per pack			
With screw connection			
<b>PR2-B relay base</b> , for industrial relay, REL-IR with two or four PDTs, 1/3-level design, connection option for input/interference suppression module, including ten MP2 marking labels per pack	<b>PR2-BSC2/4X21</b>	2833563	10
With screw connection			
<b>Relay retaining bracket</b> , with ejector function and integrated equipment marking area (8 x 25 mm), suitable for PR2 relay base	<b>EL2-P35</b>	2833592	10

Accessories			
Description	Type	Order No.	Pcs. / Pkt.
<b>Equipment marking label</b> , marking area 9 x 25 mm			
<b>Device marking label</b> , for thermal transfer printer, marking area 6 x 15 mm 2500 labels per roll	<b>MP 2</b>	2833644	10
<b>Device marking label</b> , for thermal transfer printer, marking area 6 x 15 mm 2500 labels per roll	<b>EML (15X6) R YE</b>	0819288	1
<b>Loop bridge</b> , 50-pos., divisible, max. bridging distance 60 mm, 0.5 mm <sup>2</sup>			
blue	<b>DB 50- 90 BU</b>	2821180	1
black	<b>DB 50- 90 BK</b>	2820916	1
gray	<b>DB 50- 90 GY</b>	2820929	1

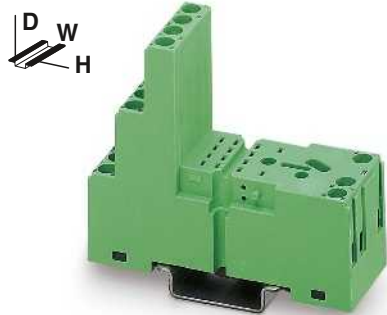

1/3-level design with screw connection



Relay retaining bracket



Technical data	Technical data
300 V AC/DC	-
12 A	-
-25 °C ... 85 °C	-
0.2 ... 2.5 mm <sup>2</sup> / 0.2 ... 2.5 mm <sup>2</sup> / 26 - 14	-
27 mm	-
86 mm (EL2-P35)	-
78.5 mm	-

Ordering data			Ordering data		
Type	Order No.	Pcs. / Pkt.	Type	Order No.	Pcs. / Pkt.
PR2-BSC3/4X21	2833576	10			
EL2-P35	2833592	10	EL2-P35	2833592	10

Accessories			Accessories		
Type	Order No.	Pcs. / Pkt.	Type	Order No.	Pcs. / Pkt.
MP 2	2833644	10			
EML (15X6) R YE	0819288	1			
EML (15X6) R YE	0819288	1			
DB 50- 90 BU	2821180	1			
DB 50- 90 BK	2820916	1			
DB 50- 90 GY	2820929	1			

# Relay modules

## Industrial relay system with screw connection - PR series

### Plug-in industrial relays suitable for PR2 relay base

Plug-in industrial relays with 2 or 4 PDT contacts, suitable for PR2 and RIF-2 relay bases.

The advantages:

- With lockable manual operation
- Mechanical switch position indicator
- Integrated status LED
- Multi-layer gold contact or power contact
- DC types with integrated freewheeling diode



2 PDT relay with power contacts



4 PDT relay with multi-layer gold contact

**Notes:**  
For 48 V DC and 60 V DC types, see [phoenixcontact.net/products](http://phoenixcontact.net/products)

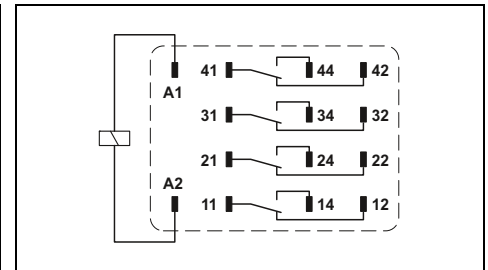
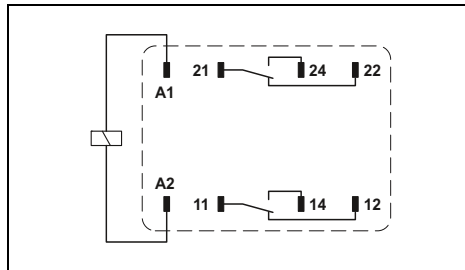

#### Technical data

	①	②	③	④	⑤	⑥	⑦	⑧
Permissible range (with reference to $U_N$ )	see diagram							
Typ. input current at $U_N$	75	38	10	7.2	3.6	54	11	5
Typ. response time at $U_N$	13	13	13	13	13			
Typ. response time at $U_N$ (AC, depending on phase relation)						4 - 10	4 - 10	4 - 10
Typ. release time at $U_N$	5	5	5	5	5			
Typ. release time at $U_N$ (AC, depending on phase relation)						3 - 12	3 - 12	3 - 12

#### Technical data

	①	②	③	④	⑤	⑥	⑦	⑧
Permissible range (with reference to $U_N$ )	see diagram							
Typ. input current at $U_N$	75	38	10	7.2	3.6	54	11	5
Typ. response time at $U_N$	13	13	13	13	13			
Typ. response time at $U_N$ (AC, depending on phase relation)						4 - 10	4 - 10	4 - 10
Typ. release time at $U_N$	5	5	5	5	5			
Typ. release time at $U_N$ (AC, depending on phase relation)						3 - 12	3 - 12	3 - 12

Input data	
Permissible range (with reference to $U_N$ )	
Typ. input current at $U_N$	[mA]
Typ. response time at $U_N$	[ms]
Typ. response time at $U_N$ (AC, depending on phase relation)	[ms]
Typ. release time at $U_N$	[ms]
Typ. release time at $U_N$ (AC, depending on phase relation)	[ms]
Output data	
Contact type	2 PDTs
Contact material	Ag
Max. switching voltage	250 V AC/DC
Min. switching voltage	5 V
Limiting continuous current	10 A
Min. switching current	1 mA
Max. interrupting rating, ohmic load	250 V AC

Input data	
Permissible range (with reference to $U_N$ )	
Typ. input current at $U_N$	[mA]
Typ. response time at $U_N$	[ms]
Typ. response time at $U_N$ (AC, depending on phase relation)	[ms]
Typ. release time at $U_N$	[ms]
Typ. release time at $U_N$ (AC, depending on phase relation)	[ms]
Output data	
Contact type	4 PDTs
Contact material	AgNi, hard gold-plated
Max. switching voltage	250 V AC/DC
Min. switching voltage	1 V
Limiting continuous current	5 A
Min. switching current	1 mA
Max. interrupting rating, ohmic load	1250 VA

General data	
Test voltage (winding/contact)	2 kV AC (50 Hz, 1 min.)
Test voltage (contact/contact)	2 kV AC (50 Hz, 1 min.)
Ambient temperature (operation)	-55 °C ... 70 °C
Nominal operating mode	100% operating factor
Mechanical service life	5 x 10 <sup>7</sup> cycles
Electrical service life	see diagram
Standards/regulations	DIN EN 61810-1, VDE 0435-201, EN 50178, IEC 62103

General data	
Test voltage (winding/contact)	2 kV AC (50 Hz, 1 min.)
Test voltage (contact/contact)	2 kV AC (50 Hz, 1 min.)
Ambient temperature (operation)	-55 °C ... 70 °C
Nominal operating mode	100% operating factor
Mechanical service life	5 x 10 <sup>7</sup> cycles
Electrical service life	see diagram
Standards/regulations	DIN EN 61810-1, VDE 0435-201, EN 50178, IEC 62103

Mounting position / mounting

any / on PR2 relay base

any / on PR2 relay base

#### Ordering data

Description	Input voltage $U_N$	Type	Order No.	Pcs. / Pkt.
<b>Plug-in industrial relay</b> with a test button, status LED, mechanical switch position indicator				
with freewheeling diode, <b>A1 +, A2 -</b>	① 12 V DC	REL-IR/LDP- 12DC/2X21	2834012	10
with freewheeling diode, <b>A1 +, A2 -</b>	② 24 V DC	REL-IR/LDP- 24DC/2X21	2834025	10
with freewheeling diode, <b>A1 +, A2 -</b>	③ 110 V DC	REL-IR/LDP-110DC/2X21	2834041	10
with freewheeling diode, <b>A1 +, A2 -</b>	④ 125 V DC	REL-IR/LDP-125DC/2X21	2834960	10
with freewheeling diode, <b>A1 +, A2 -</b>	⑤ 220 V DC	REL-IR/LDP-220DC/2X21	2834957	10
	⑥ 24 V AC	REL-IR/L- 24AC/2X21	2834054	10
	⑦ 120 V AC	REL-IR/L-120AC/2X21	2834067	10
	⑧ 230 V AC	REL-IR/L-230AC/2X21	2834070	10
<b>Plug-in industrial relay</b> with a test button, status LED, mechanical switch position indicator, (Japanese standard)				
with freewheeling diode, <b>A1 -, A2 +</b>	① 12 V DC	REL-IR/LDM- 12DC/2X21	2834151	10
with freewheeling diode, <b>A1 -, A2 +</b>	② 24 V DC	REL-IR/LDM- 24DC/2X21	2834164	10
with freewheeling diode, <b>A1 -, A2 +</b>	③ 48 V DC	REL-IR/LDM- 48DC/2X21	2834177	10
with freewheeling diode, <b>A1 -, A2 +</b>	④ 110 V DC	REL-IR/LDM-110DC/2X21	2834180	10

#### Ordering data

Description	Input voltage $U_N$	Type	Order No.	Pcs. / Pkt.
<b>Plug-in industrial relay</b> with a test button, status LED, mechanical switch position indicator				
with freewheeling diode, <b>A1 +, A2 -</b>	① 12 V DC	REL-IR/LDP- 12DC/4X21AU	2834083	10
with freewheeling diode, <b>A1 +, A2 -</b>	② 24 V DC	REL-IR/LDP- 24DC/4X21AU	2834096	10
with freewheeling diode, <b>A1 +, A2 -</b>	③ 110 V DC	REL-IR/LDP-110DC/4X21AU	2834119	10
with freewheeling diode, <b>A1 +, A2 -</b>	④ 125 V DC	REL-IR/LDP-125DC/4X21AU	2834313	10
with freewheeling diode, <b>A1 +, A2 -</b>	⑤ 220 V DC	REL-IR/LDP-220DC/4X21AU	2834973	10
	⑥ 24 V AC	REL-IR/L- 24AC/4X21AU	2834122	10
	⑦ 120 V AC	REL-IR/L-120AC/4X21AU	2834135	10
	⑧ 230 V AC	REL-IR/L-230AC/4X21AU	2834148	10
<b>Plug-in industrial relay</b> with a test button, status LED, mechanical switch position indicator, (Japanese standard)				
with freewheeling diode, <b>A1 -, A2 +</b>	① 12 V DC	REL-IR/LDM- 12DC/4X21AU	2834193	10
with freewheeling diode, <b>A1 -, A2 +</b>	② 24 V DC	REL-IR/LDM- 24DC/4X21AU	2834203	10
with freewheeling diode, <b>A1 -, A2 +</b>	③ 48 V DC	REL-IR/LDM- 48DC/4X21AU	2834216	10
with freewheeling diode, <b>A1 -, A2 +</b>	④ 110 V DC	REL-IR/LDM-110DC/4X21AU	2834229	10

### REL-IR...2x21 (2 PDTs)

Operating voltage range

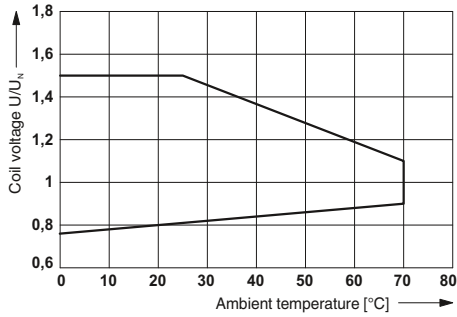

AC interrupting rating

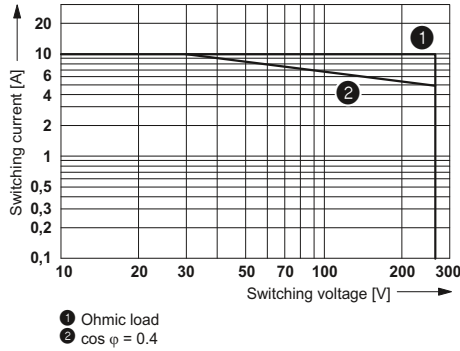

DC interrupting rating

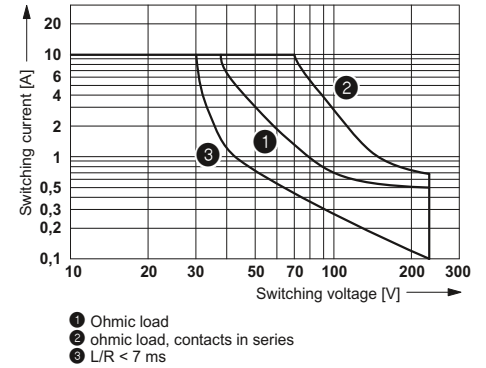

Electrical service life

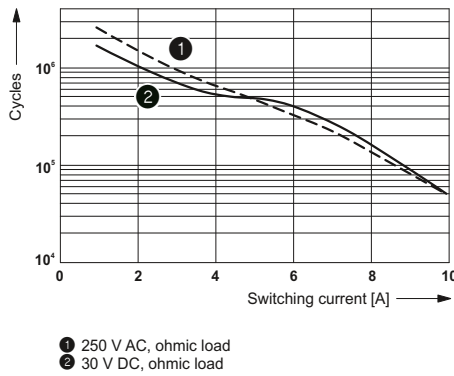

Service life reduction factor

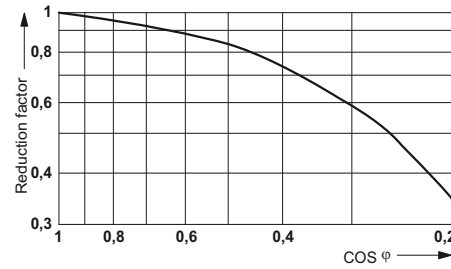

### REL-IR...4x21AU (4 PDTs)

Operating voltage range

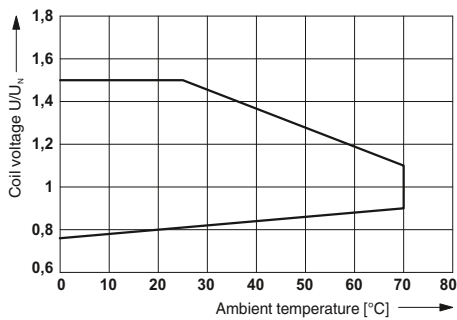

AC interrupting rating

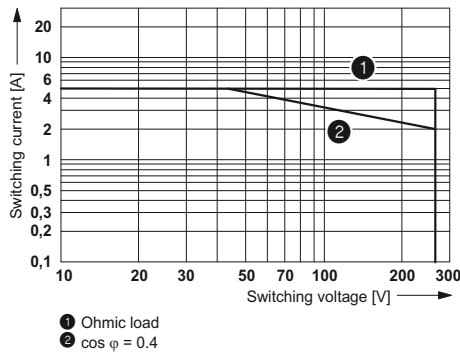

DC interrupting rating

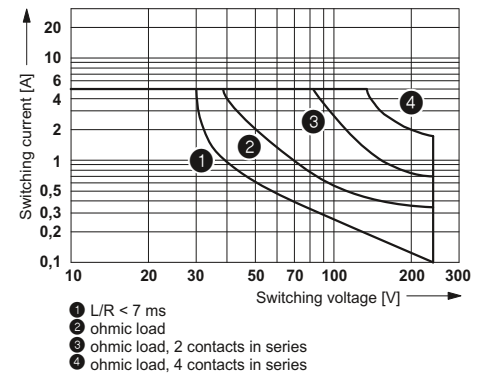

Electrical service life

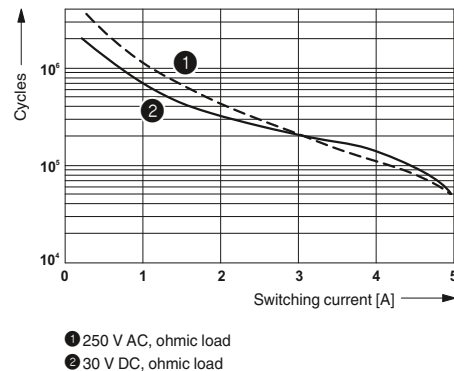

Service life reduction factor

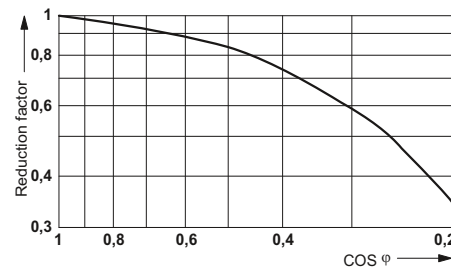



# Relay modules

## Industrial relay system with screw connection - PR series

### Modular PR3 relay base

- Relay base family that can be fitted with 2 PDT or 3 PDT relays
- Range of accessories includes:
- Plug-in input modules/interference suppr. modules
  - Relay retaining bracket
  - Loop bridges

Notes:
Type of housing: Polyamide fiber reinforced PA-F, color: green.
Marking systems and mounting material See Catalog 5

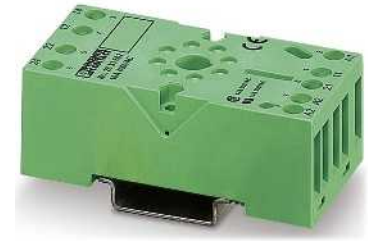

Relay base for 2 PDT octal relay



Nominal voltage $U_N$	400 V AC/DC
Nominal current at $U_N$	10 A
General data	
Ambient temperature (operation)	-40 °C ... 85 °C
Connection data solid / stranded / AWG	0.2 ... 2.5 mm <sup>2</sup> / 0.2 ... 2.5 mm <sup>2</sup> / 26 - 14
Dimensions	
Width	38 mm
Depth with retaining bracket	84 mm (EL3-M52)
Height	75 mm

#### Technical data

Nominal voltage $U_N$	400 V AC/DC
Nominal current at $U_N$	10 A
General data	
Ambient temperature (operation)	-40 °C ... 85 °C
Connection data solid / stranded / AWG	0.2 ... 2.5 mm <sup>2</sup> / 0.2 ... 2.5 mm <sup>2</sup> / 26 - 14
Dimensions	
Width	38 mm
Depth with retaining bracket	84 mm (EL3-M52)
Height	75 mm

Description
<b>PR3 relay base</b> , for REL-OR octal relay with two PDTs, plug-in option for input/interference suppression modules
With screw connection <b>PR3 relay base</b> , for REL-OR octal relay with three PDTs, plug-in option for input/interference suppression modules
With screw connection <b>Relay retaining bracket</b> , wire model, suitable for RIF-3 and PR3 relay base

#### Ordering data

Type	Order No.	Pcs. / Pkt.
<b>PR3-BSC1/2X21</b>	2833602	10
<b>EL3-M52</b>	2833628	10

Loop bridge, 50-pos., divisible, max. bridging distance 60 mm, 0.5 mm <sup>2</sup>			
blue	<b>DB 50- 90 BU</b>	2821180	1
black	<b>DB 50- 90 BK</b>	2820916	1
gray	<b>DB 50- 90 GY</b>	2820929	1

#### Accessories

blue	<b>DB 50- 90 BU</b>	2821180	1
black	<b>DB 50- 90 BK</b>	2820916	1
gray	<b>DB 50- 90 GY</b>	2820929	1



Relay base for  
3 PDT octal relay



Relay retaining bracket



**Technical data**

400 V AC/DC  
10 A

-40 °C ... 85 °C  
0.2 ... 2.5 mm<sup>2</sup> / 0.2 ... 2.5 mm<sup>2</sup> / 26 - 14

38 mm  
84 mm (EL3-M52)  
75 mm

**Technical data**

-  
-  
-  
-  
-  
-

**Ordering data**

Type	Order No.	Pcs. / Pkt.
PR3-BSC1/3X21	2833615	10
EL3-M52	2833628	10

**Ordering data**

Type	Order No.	Pcs. / Pkt.
EL3-M52	2833628	10

**Accessories**

Type	Order No.	Pcs. / Pkt.
DB 50- 90 BU	2821180	1
DB 50- 90 BK	2820916	1
DB 50- 90 GY	2820929	1

**Accessories**

Type	Order No.	Pcs. / Pkt.

# Relay modules

## Industrial relay system with screw connection - PR series

### Plug-in octal relays suitable for PR3 relay base

Plug-in octal relays with 2 or 3 PDT contacts, suitable for PR3 and RIF-3 relay bases.

The advantages:

- With lockable manual operation
- Mechanical switch position indicator
- Extremely robust design



2 PDT relay with power contacts



3 PDT relay with power contacts

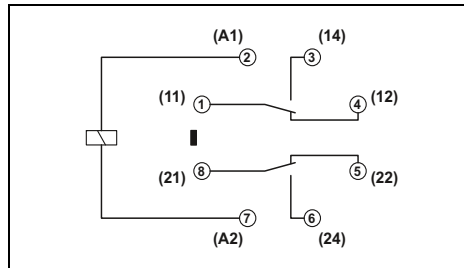

#### Technical data

Input data	①	②	③	④
Typ. input current at $U_N$	56	110	22	10
Typ. response time at $U_N$	12			
Typ. response time at $U_N$ (AC, depending on phase relation)		5 - 20	5 - 20	5 - 20
Typ. release time at $U_N$	6			
Typ. release time at $U_N$ (AC, depending on phase relation)		5 - 20	5 - 20	5 - 20

Output data	250 V AC
2500 VA	
Contact type	2 PDTs
Contact material	AgSnIn
Max. switching voltage	250 V AC/DC
Min. switching voltage	1 V
Limiting continuous current	10 A (N/O contact)
Min. switching current	10 mA
Max. interrupting rating, ohmic load	2500 VA

General data	
Test voltage (winding/contact)	2.5 kV AC (50 Hz, 1 min.)
Test voltage (contact/contact)	2.5 kV AC (50 Hz, 1 min.)
Ambient temperature (operation)	-40 °C ... 60 °C
Nominal operating mode	100% operating factor
Mechanical service life	10 x 10 <sup>6</sup> cycles
Electrical service life	see diagram
Standards/regulations	IEC 60664
Mounting position / mounting	any / on PR3 relay base

#### Ordering data

Description	Input voltage $U_N$
<b>Plug-in octal relay with power contacts</b> , with a test button and mechanical switch position indicator	① 24 V DC
	② 24 V AC
	③ 120 V AC
	④ 230 V AC

Type	Order No.	Pcs. / Pkt.
REL-OR- 24DC/2X21	2834232	10
REL-OR- 24AC/2X21	2834245	10
REL-OR-120AC/2X21	2834258	10
REL-OR-230AC/2X21	2834261	10

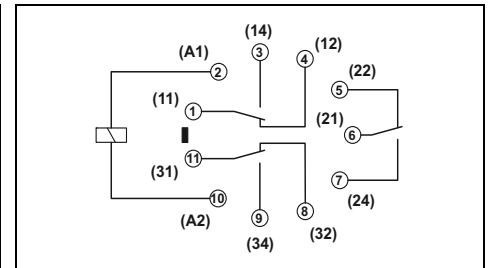

#### Technical data

Input data	①	②	③	④
Typ. input current at $U_N$	56	110	22	10
Typ. response time at $U_N$	12			
Typ. response time at $U_N$ (AC, depending on phase relation)		5 - 20	5 - 20	5 - 20
Typ. release time at $U_N$	6			
Typ. release time at $U_N$ (AC, depending on phase relation)		5 - 20	5 - 20	5 - 20

Output data	2500 VA
2500 VA	
Contact type	3 PDTs
Contact material	AgSnIn
Max. switching voltage	250 V AC/DC
Min. switching voltage	1 V
Limiting continuous current	10 A (N/O contact)
Min. switching current	10 mA
Max. interrupting rating, ohmic load	2500 VA

General data	
Test voltage (winding/contact)	2.5 kV AC (50 Hz, 1 min.)
Test voltage (contact/contact)	2.5 kV AC (50 Hz, 1 min.)
Ambient temperature (operation)	-40 °C ... 60 °C
Nominal operating mode	100% operating factor
Mechanical service life	10 x 10 <sup>6</sup> cycles
Electrical service life	see diagram
Standards/regulations	IEC 60664
Mounting position / mounting	any / on PR3 relay base

#### Ordering data

Type	Order No.	Pcs. / Pkt.
REL-OR- 24DC/3X21	2834274	10
REL-OR- 24AC/3X21	2834287	10
REL-OR-120AC/3X21	2834290	10
REL-OR-230AC/3X21	2834300	10

### REL-OR...2x21 (2 PDTs)

Interrupting rating

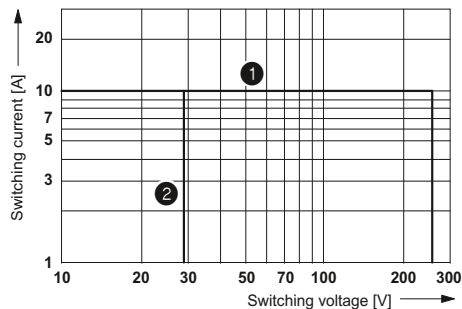

- 1 AC, ohmic load
- 2 DC, ohmic load

Electrical service life

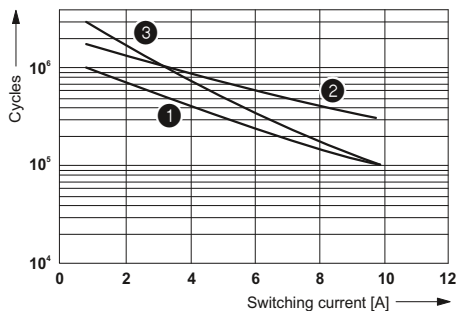

- 1 250V AC, ohmic load
- 2 120VDC, ohmic load
- 3 28V DC, ohmic load

Service life reduction factor with various cos phi

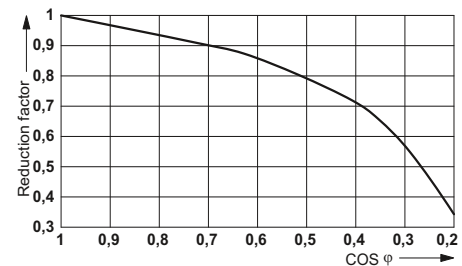

### REL-OR...3x21 (3 PDTs)

Interrupting rating

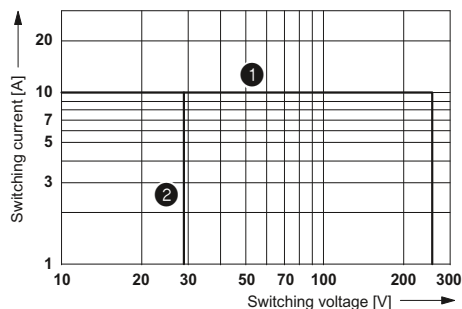

- 1 AC, ohmic load
- 2 DC, ohmic load

Electrical service life

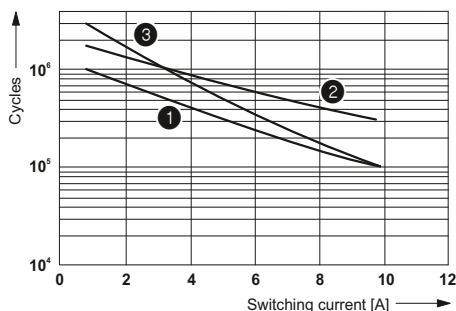

- 1 250V AC, ohmic load
- 2 120VDC, ohmic load
- 3 28V DC, ohmic load

Service life reduction factor with various cos phi

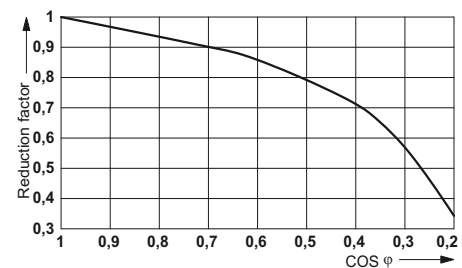

# Relay modules

## Industrial relay system with screw connection - PR series

### Input modules/interference suppression modules for PR1, PR2, and PR3

Plug-in input modules/interference suppression modules for optional fitting of PR... relay bases.

The advantages:

- Attenuation of reverse voltage induced in coil
- Mechanical coding to protect against incorrect connection



Input/interference suppression module to match PR1 and PR2



Input/interference suppression module to match PR3



#### Ordering data

#### Ordering data

Description
<p><b>Plug-in module</b>, for mounting on PR..., with LED status indicator and freewheeling diode to limit the coil induction voltage effectively, polarity: <b>A1 +, A2 -</b>, Input voltage:</p> <ul style="list-style-type: none"> <li>- 12-24 V DC ±20%</li> <li>- 48-60 V DC ±20%</li> <li>- 110 V DC ±20%</li> </ul>
<p><b>Plug-in module</b>, for mounting on PR..., with LED status indicator and freewheeling diode to limit the coil induction voltage effectively, polarity: <b>A1 -, A2 +</b> (Japanese standard), Input voltage:</p> <ul style="list-style-type: none"> <li>- 12-24 V DC ±20%</li> <li>- 48-60 V DC ±20%</li> <li>- 110 V DC ±20%</li> </ul>
<p><b>Plug-in module</b>, for mounting on PR..., with LED status indicator and varistor to limit the coil induction voltage and/or external interference peaks, Input voltage:</p> <ul style="list-style-type: none"> <li>- 12-24 V AC/DC ±20% (30 V varistor)</li> <li>- 48-60 V AC/DC ±20% (75 V varistor)</li> <li>- 120-230 V AC/110 V DC ±20% (275 V varistor)</li> </ul>
<p><b>Plug-in module</b>, for mounting on PR..., with varistor to limit the coil induction voltage and/or external interference peaks, Input voltage:</p> <ul style="list-style-type: none"> <li>- 12-24 V AC/DC ±20% (30 V varistor)</li> <li>- 48-60 V AC/DC ±20% (75 V varistor)</li> <li>- 120-230 V AC/DC ±20% (275 V varistor)</li> </ul>
<p><b>Plug-in module</b>, for mounting on PR..., with RD element to attenuate the coil induction voltage and/or external interference peaks, Input voltage:</p> <ul style="list-style-type: none"> <li>- 12-24 V AC/DC ±20% (220 nF/100 Ω)</li> <li>- 48-60 V AC/DC ±20% (220 nF/220 Ω)</li> <li>- 120-230 V AC/DC ±20% (100 nF/470 Ω)</li> </ul>

Type	Order No.	Pcs. / Pkt.
LDP- 12- 24DC	2833657	10
LDP- 48- 60DC	2833660	10
LDP-110DC	2833673	10
LDM- 12- 24DC	2833686	10
LDM- 48- 60DC	2833699	10
LDM-110DC	2833709	10
LV- 12- 24UC	2833712	10
LV- 48- 60UC	2833725	10
LV-120-230AC/110DC	2833738	10
V- 12- 24UC	2833864	10
V- 48- 60UC	2833877	10
V-120-230UC	2833880	10
RC- 12- 24UC	2833741	10
RC- 48- 60UC	2833754	10
RC-120-230UC	2833767	10

Type	Order No.	Pcs. / Pkt.
LDP3- 12- 24DC	2833770	10
LDP3- 48- 60DC	2833783	10
LDP3-110DC	2833796	10
LDM3- 12- 24DC	2833806	10
LDM3- 48- 60DC	2833819	10
LDM3-110DC	2833822	10
LV3- 12- 24UC	2833835	10
LV3- 48- 60UC	2833848	10
LV3-120-230AC/110DC	2833851	10
V3- 12- 24UC	2833929	10
V3- 48- 60UC	2833932	10
V3-120-230UC	2833945	10
RC3- 12- 24UC	2833893	10
RC3- 48- 60UC	2833903	10
RC3-120-230UC	2833916	10

Terminal assignment of PR1 base/solid-state relay								
	Terminal blocks, PR1 base							
	A1	A2	11	12	14	21	22	24
<b>Solid-state relays</b>								
SIM-EI...48DC/100	A2 (-)	A1 (+)			A	+		
SIM-EI...TTL/100	A2 (-)	A1 (+)			A	+	0	
SIM-EI...48DC/100RC	A2 (-)	A1 (+)			A	+		
SIM-EI-OV-24DC/24DC/3	A2 (-)	A1 (+)			A	+		
OPT-...24DC/5	A1 (+)	A2 (-)	13		14			
OPT-...230AC/2	A1 (+)	A2 (-)	13		14			

The relay bases of the PR1 series can also be equipped with wear-free solid-state relays (OPT... or SIM-EI...) as an alternative to the electromechanical relay.  
LDP... and LV... plug-in modules cannot be used in conjunction with SIM-EI... solid-state relays.



# Relay modules

## Industrial relay system with screw connection - PR series

### Fully mounted PR1 relay modules with screw connection

- Fully mounted PR1 relay modules, consisting of:
- Relay base
  - 1/2 PDT relay
  - Relay retaining bracket
  - Input module/interference suppr. module
  - Marking labels
- The advantages:
- Logical contact arrangement thanks to 1/3-level relay base
  - Operational reliability thanks to sealed relay
  - Safe isolation between coil and contact side

Notes:
Type of housing: Polyamide fiber reinforced PA-F, color: green.
For the protection of input and output, inductive loads must be dampened with an effective protection circuit.
If the specified maximum values for multi-layer contact relays are exceeded, the gold plating is destroyed. The maximum values of the power contact relay are then valid. This can result in a shorter service life than with a pure power contact.
Other input voltages on request.

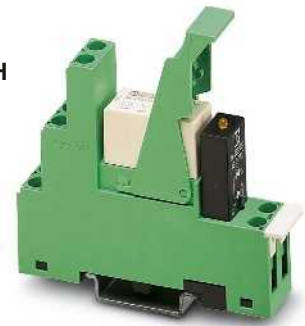

PR1 relay module with 1 PDT relay

ERC

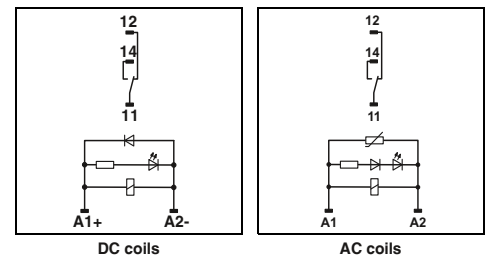

Input data	
Permissible range (with reference to $U_N$ )	
Typ. input current at $U_N$	[mA]
Typ. response time at $U_N$	[ms]
Typ. release time at $U_N$	[ms]
Input circuit AC	
Input circuit DC	
Output data	
Contact type	
Contact material	
Max. switching voltage	
Min. switching voltage	
Limiting continuous current	
Max. inrush current	
Min. switching current	
Interrupting rating (ohmic load)	
General data	
Test voltage (winding/contact)	
Test voltage (contact/contact)	
Ambient temperature (operation)	
Nominal operating mode	
Mechanical service life	
Standards/regulations	
Pollution degree / surge voltage category	
Mounting position / mounting	
Connection data solid / stranded / AWG	
Dimensions	W / H / D
EMC note	

Technical data			
①	②	③	④
see diagram			
19	34	9	6
8	3 - 12	3 - 12	3 - 12
10	1.5 - 14	1.5 - 16	2 - 22
Yellow LED, varistor			
Yellow LED, freewheeling diode			
1 PDT		1 PDT	
AgNi		AgNi, hard gold-plated	
250 V AC/DC		30 V AC / 36 V DC	
12 V (at 10 mA)		100 mV (at 10 mA)	
12 A		50 mA	
30 A (300 ms)		50 mA	
10 mA (at 12 V)		1 mA (at 24 V)	
3000 W (for 250 V AC)		1.2 W (at 24 V DC)	
4 kV (50 Hz, 1 min.)			
-			
-25 °C ... 60 °C			
100% operating factor			
3 x 10 <sup>7</sup> cycles			
IEC 60664, EN 50178, IEC 62103			
3 / III			
any / can be aligned without spacing			
0.14 - 2.5 mm <sup>2</sup> / 0.14 - 2.5 mm <sup>2</sup> / 26 - 14			
16 mm / 78.5 mm / 71 mm			
Class A product, see page 625			

Description	Input voltage $U_N$
<b>Pre-assembled coupling relay modules with miniature power contact relay</b>	① 24 V DC
	② 24 V AC
	③ 120 V AC
	④ 230 V AC
<b>Pre-assembled coupling relay modules with multi-layer contact relay</b>	① 24 V DC
	② 24 V AC
	③ 120 V AC
	④ 230 V AC

Ordering data		
Type	Order No.	Pcs. / Pkt.
PR1-RSC3-LDP-24DC/21	2834326	5
PR1-RSC3-LV- 24AC/21	2834339	5
PR1-RSC3-LV-120AC/21	2834342	5
PR1-RSC3-LV-230AC/21	2834355	5
PR1-RSC3-LDP-24DC/21AU	2834368	5
PR1-RSC3-LV- 24AC/21AU	2834371	5
PR1-RSC3-LV-120AC/21AU	2834384	5
PR1-RSC3-LV-230AC/21AU	2834397	5

Device marking label, for thermal transfer printer, marking area 6 x 15 mm

Accessories		
EML (15X6) R YE	0819288	1

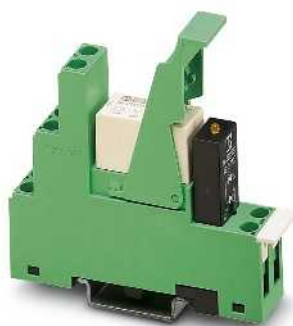

PR1 relay module with 2 PDT relay

### PR1-RSC3.../21 (1 PDT)

Operating voltage range of the relay

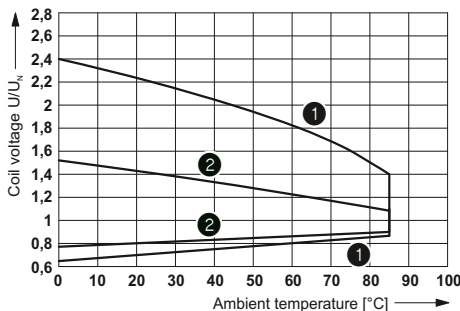

- 1 DC coils
- 2 AC coils

Interrupting rating

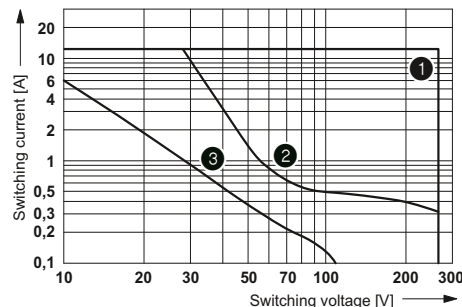

- 1 AC, ohmic load
- 2 DC, ohmic load
- 3 DC, L/R = 40 ms

Service life reduction factor

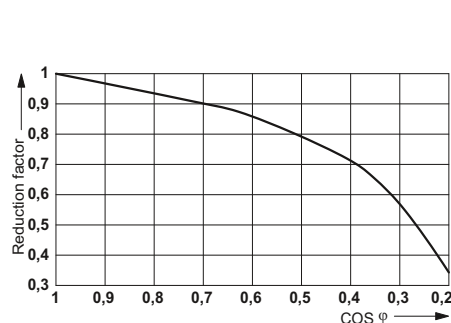

Electrical service life

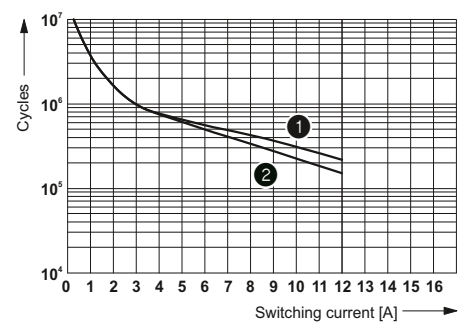

- 1 250 V AC, ohmic load (DC coils)
- 2 250 V AC, ohmic load (AC coils)

### PR1-RSC3.../2x21 (2 PDTs)

Operating voltage range of the relay

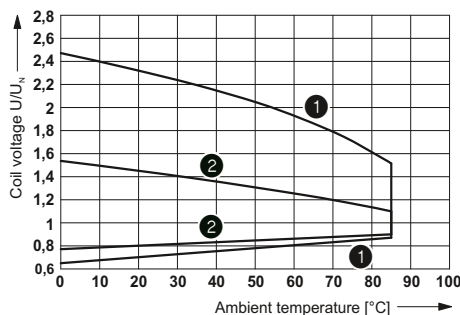

- 1 DC coils
- 2 AC coils

Interrupting rating

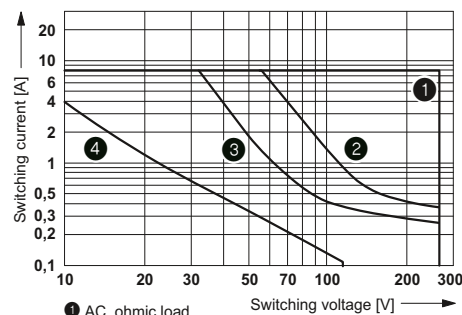

- 1 AC, ohmic load
- 2 DC, ohmic load, contacts in series
- 3 DC, ohmic load
- 4 DC, L/R = 40 ms

Service life reduction factor with various cos phi

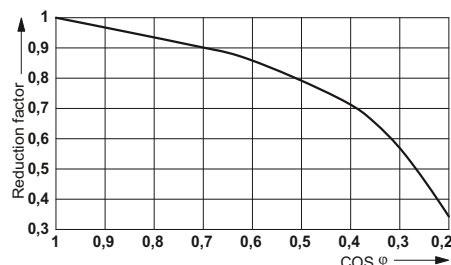

Electrical service life

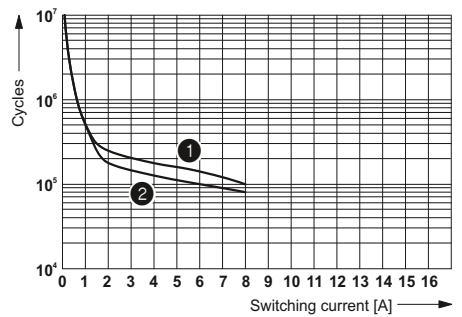

- 1 250 V AC, ohmic load (DC coils)
- 2 250 V AC, ohmic load (AC coils)

ERC

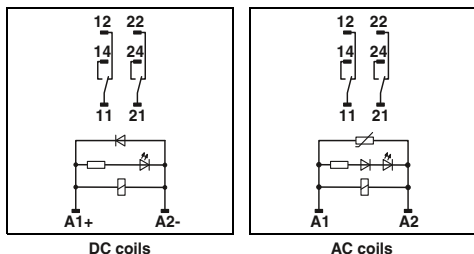

DC coils

AC coils

#### Technical data

①	②	③	④
see diagram			
19	34	9	6
8	3 - 12	3 - 12	3 - 12
10	1.5 - 14	1.5 - 16	2 - 22

Yellow LED, varistor  
Yellow LED, freewheeling diode

2 PDTs  
AgNi

2 PDTs  
AgNi, hard gold-plated

250 V AC/DC  
5 V (at 10 mA)  
8 A  
15 A (300 ms)  
10 mA (at 5 V)  
2000 W (for 250 V AC)

30 V AC / 36 V DC  
100 mV (at 10 mA)  
50 mA  
50 mA  
1 mA (at 24 V)  
1.2 W (at 24 V DC)

4 kV (50 Hz, 1 min.)  
2.5 kV (50 Hz, 1 min.)  
-25 °C ... 60 °C  
100% operating factor  
3 x 10<sup>7</sup> cycles  
IEC 60664, EN 50178, IEC 62103  
3 / III  
any / can be aligned without spacing  
0.14 - 2.5 mm<sup>2</sup> / 0.14 - 2.5 mm<sup>2</sup> / 26 - 14  
16 mm / 78.5 mm / 71 mm  
Class A product, see page 625

#### Ordering data

Type	Order No.	Pcs. / Pkt.
PR1-RSC3-LDP-24DC/2X21	2834481	5
PR1-RSC3-LV- 24AC/2X21	2834494	5
PR1-RSC3-LV-120AC/2X21	2834504	5
PR1-RSC3-LV-230AC/2X21	2834517	5
PR1-RSC3-LDP-24DC/2X21AU	2834520	5
PR1-RSC3-LV- 24AC/2X21AU	2834533	5
PR1-RSC3-LV-120AC/2X21AU	2834546	5
PR1-RSC3-LV-230AC/2X21AU	2834559	5

#### Accessories

EML (15X6) R YE	0819288	1
-----------------	---------	---

# Relay modules

## Industrial relay system with screw connection - PR series

### Fully mounted PR2 relay modules

Fully mounted PR2 relay modules, consisting of:

- Relay base
- 2/4 PDT relay
- Relay retaining bracket
- Input module/interference suppr. module (AC types only)
- Marking labels

The advantages:

- Relay with lockable manual operation and status LED
- With DC types, freewheeling diode is integrated into relay
- Mechanical switch position indicator
- Logical contact arrangement thanks to 1/3-level relay base
- 4 PDT types with multi-layer gold contacts

Notes:
Type of housing: Polyamide fiber reinforced PA-F, color: green.
For the protection of input and output, inductive loads must be dampened with an effective protection circuit.
If the specified maximum values for multi-layer contact relays are exceeded, the gold plating is destroyed. The maximum values of the power contact relay are then valid. This can result in a shorter service life than with a pure power contact.
Other input voltages on request.
The DC types do not have a plug-in module because the status LED and the freewheeling diode are integrated directly into the relay.

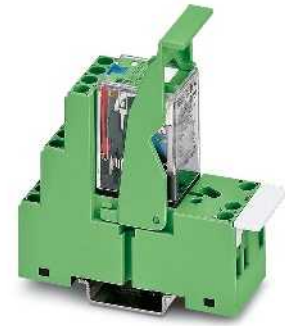

PR2 relay module with 2 PDT relay

ERC

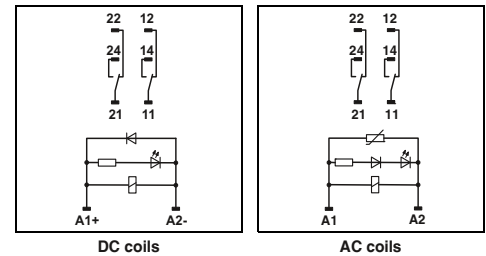

DC coils

AC coils

Input data	
Permissible range (with reference to $U_N$ )	
Typ. input current at $U_N$	[mA]
Typ. response time at $U_N$	[ms]
Typ. release time at $U_N$	[ms]
Input circuit AC	
Input circuit DC	
Output data	
Contact type	
Contact material	
Max. switching voltage	
Min. switching voltage	
Limiting continuous current	
Max. inrush current	
Min. switching current	
Interrupting rating (ohmic load)	
General data	
Test voltage (winding/contact)	
Test voltage (contact/contact)	
Ambient temperature (operation)	
Nominal operating mode	
Mechanical service life	
Standards/regulations	
Pollution degree / surge voltage category	
Mounting position / mounting	
Connection data solid / stranded / AWG	
Dimensions	W / H / D
EMC note	

Technical data				
①	②	③	④	
see diagram				
38	54	11	5	
13	4 - 10	4 - 10	4 - 10	
5	3 - 12	3 - 12	3 - 12	
Red LED, varistor				
Green LED, freewheeling diode				

2 PDTs
Ag
250 V AC/DC
5 V
10 A
20 A (15 ms)
1 mA
2500 VA (for 250 V AC)

2 kV (50 Hz, 1 min.)
2 kV (50 Hz, 1 min.)
-25 °C ... 60 °C
100% operating factor
5 x 10 <sup>7</sup> cycles
IEC 60664, EN 50178, IEC 62103
3 / II

any / can be aligned without spacing
0.14 - 2.5 mm <sup>2</sup> / 0.14 - 2.5 mm <sup>2</sup> / 26 - 14
27 mm / 78.5 mm / 86 mm
Class A product, see page 625

Ordering data		
Type	Order No.	Pcs. / Pkt.
PR2-RSC3-LDP-24DC/2X21	2834643	5
PR2-RSC3-LV- 24AC/2X21	2834656	5
PR2-RSC3-LV-120AC/2X21	2834669	5
PR2-RSC3-LV-230AC/2X21	2834672	5

Description	Input voltage $U_N$
<b>Pre-assembled coupling relay modules with 2-PDT contact relay</b>	
①	24 V DC
②	24 V AC
③	120 V AC
④	230 V AC
<b>Pre-assembled coupling relay modules with 4-PDT contact relay and additional hard gold-plating</b>	
①	24 V DC
②	24 V AC
③	120 V AC
④	230 V AC

Accessories		
EML (15X6) R YE	0819288	1

Device marking label, for thermal transfer printer, marking area 6 x 15 mm



PR2 relay module with 4 PDT relay

### PR2-RS.../2x21 (2 PDTs)

Operating voltage range of relay  $T_a = T_{coil}$

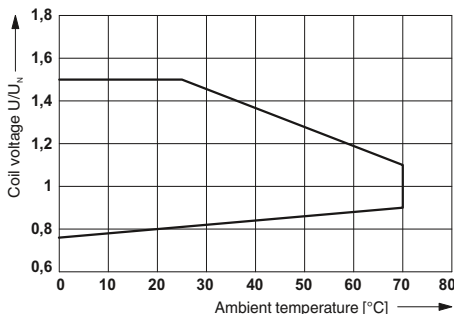

AC interrupting rating

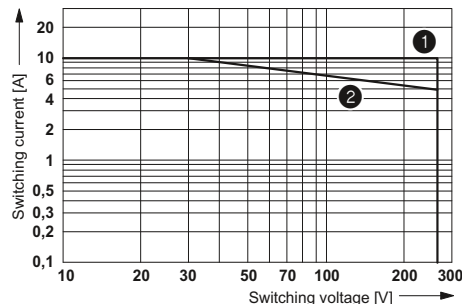

- 1 Ohmic load
- 2  $\cos \varphi = 0.4$

ERC

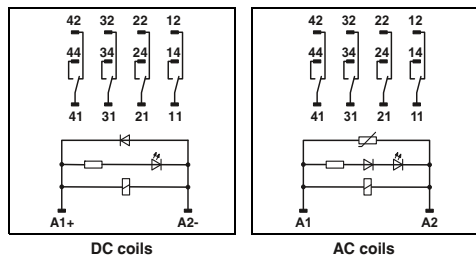

DC interrupting rating

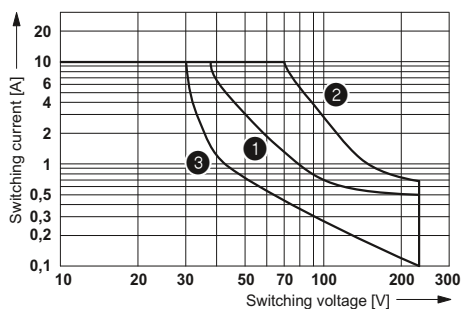

- 1 Ohmic load
- 2 ohmic load, contacts in series
- 3  $L/R < 7 \text{ ms}$

Electrical service life

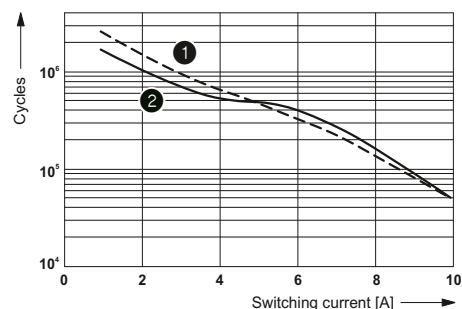

- 1 250 V AC, ohmic load
- 2 30 V DC, ohmic load

#### Technical data

①	②	③	④
see diagram			
38	54	11	5
13	4 - 10	4 - 10	4 - 10
5	3 - 12	3 - 12	3 - 12
Red LED, varistor			
Green LED, freewheeling diode			

4 PDTs  
 AgNi, hard gold-plated  
 250 V AC/DC  
 1 V  
 5 A  
 12 A (15 ms)  
 1 mA  
 1250 VA (for 250 V AC)

2 kV (50 Hz, 1 min.)  
 2 kV (50 Hz, 1 min.)  
 -25 °C ... 60 °C  
 100% operating factor  
 $5 \times 10^7$  cycles  
 IEC 60664, EN 50178, IEC 62103  
 2 / II

any / can be aligned without spacing  
 0.14 - 2.5 mm<sup>2</sup> / 0.14 - 2.5 mm<sup>2</sup> / 26 - 14  
 27 mm / 78.5 mm / 86 mm  
 Class A product, see page 625

#### Ordering data

Type	Order No.	Pcs. / Pkt.
PR2-RSC3-LDP-24DC/4X21AU	2834724	5
PR2-RSC3-LV- 24AC/4X21AU	2834737	5
PR2-RSC3-LV-120AC/4X21AU	2834740	5
PR2-RSC3-LV-230AC/4X21AU	2834753	5

#### Accessories

EML (15X6) R YE	0819288	1
-----------------	---------	---

### PR2-RS.../4x21 (4 PDTs)

Operating voltage range of relay  $T_a = T_{coil}$

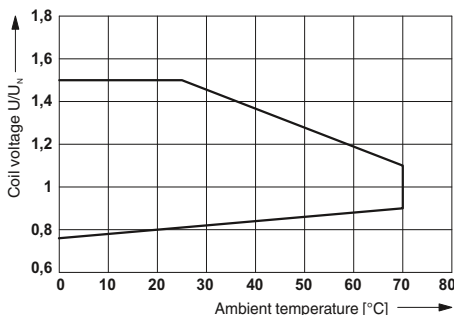

AC interrupting rating

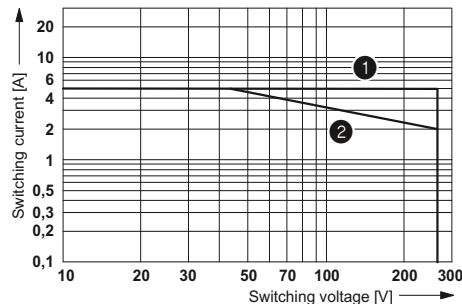

- 1 Ohmic load
- 2  $\cos \varphi = 0.4$

DC interrupting rating

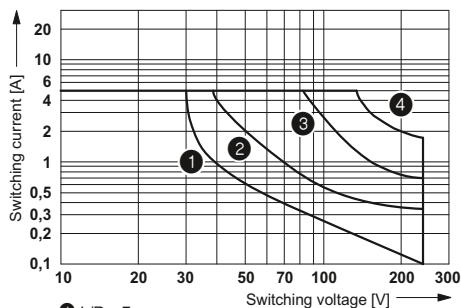

- 1  $L/R < 7 \text{ ms}$
- 2 ohmic load
- 3 ohmic load, 2 contacts in series
- 4 ohmic load, 4 contacts in series

Electrical service life

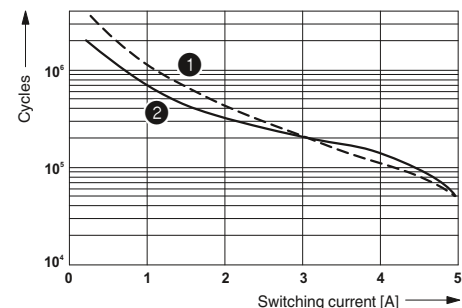

- 1 250 V AC, ohmic load
- 2 30 V DC, ohmic load

# Relay modules

## Highly compact relay modules - PLC-INTERFACE

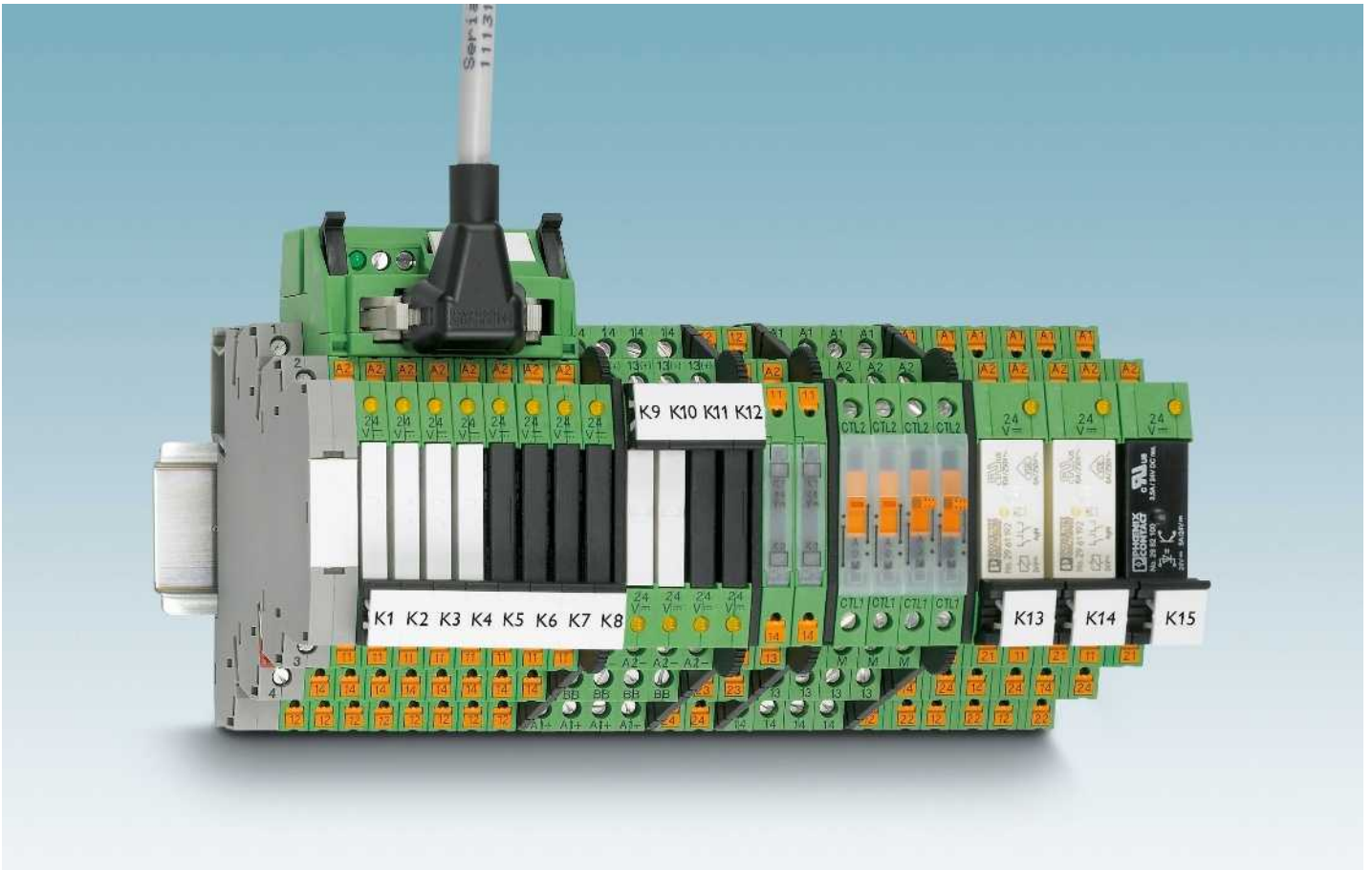

The PLC-INTERFACE relay system is the interface between the controller and system I/O devices.

The universal design is compact and space-saving. While the narrow 6.2 mm module has one contact, the 14 mm version is available with two contacts. The modules can be equipped with either an electromechanical or a solid-state relay.

They are protected against environmental influences by RTIII (IP67). The relays also offer safe isolation according to DIN EN 50178 (VDE 0160).

PLC-INTERFACE is available in three connection technologies. Depending on the usage range, screw or push-in connection can be selected.

In addition to the universal types, PLC-INTERFACE is also available in numerous special versions. These include:

- Sensor and actuator modules that can accommodate all connections directly on the interface
- Modules for high inrush or continuous currents
- Railway modules, which meet specific railway requirements
- Filter modules, which filter out interference on the input side

Jumpers are available for all modules for simple potential distribution. In addition, solutions from system cabling applications offer easy connection to the plant control system. VARIOFACE adapters can be used to reduce wiring effort considerably. Installation is simplified significantly thanks to the integrated input and protective circuit.

Standard marking material from CLIPLINE complete modular terminal blocks can be used to mark PLC-INTERFACE.





### Universal modules

PLC-R... and PLC-O... relay and solid-state relay modules with PDT or N/O contact, designed for universal use. Available in an overall width of 6.2 mm with one contact or in 14 mm with two contacts.

Available either with screw or push-in connection.



### Sensors/actuators

PLC...SEN and PLC...ACT offer space-saving sensor and actuator wiring without additional supply or output terminal blocks. The sensor or actuator connections are incorporated directly at the relay module.

Available either with screw or push-in connection.



### High currents

PLC...IC is particularly suitable for applications with high switch-on currents, e.g. from lamp loads. The PLC...HC relay modules are designed for applications with high continuous currents.

Available either with screw or push-in connection.



### Railway applications

PLC...RW relay or solid-state relay modules are suitable for railway requirements. These cover, for example, the extended temperature and input voltage range of railway applications.

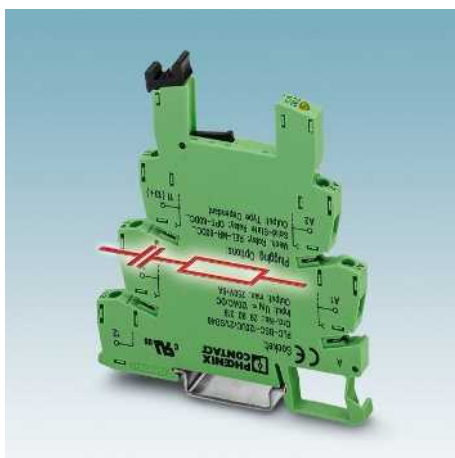

### Interference signals on the input side

PLC-B...SO46 basic terminal blocks are used for filtering interference currents and interference voltages on the input side.

Available either with screw or push-in connection.



### Accessories

The entire PLC-INTERFACE system can be extended by a range of accessories such as power terminals, adapters for system cabling or jumpers for potential distribution.

# Relay modules

## Highly compact relay modules - PLC-INTERFACE

### Universal PLC series with PDT relay

PLC-R... is the relay series that can be used universally and consists of basic terminal blocks and plug-in relays with PDT contacts.

The advantages:

- Slim design
- Screw and push-in connection technology
- Functional jumpers
- Integrated input and interference suppression circuit
- RT III sealed relay
- Safe isolation according to DIN EN 50178 between coil and contact
- Efficient connection to system cabling using V8 adapter

Notes:	
Type of housing:	Polyamide PA non-reinforced, color: green.
Marking systems and mounting material	See Catalog 5
Separating plate PLC-ATP must be installed for voltages larger than 250 V (L1, L2, L3) between identical terminal blocks in adjacent modules. Potential bridging is then carried out with FBST 8-PLC... or FBST 500....	
If the specified maximum values for multi-layer contact relays are exceeded, the gold plating is destroyed. The maximum values of the power contact relay are then valid. This can result in a shorter service life than with a pure power contact.	
For diagrams of operating voltage ranges, see page 423	
Note: for marking material (ZB 6), see "CLIPLINE industrial connection technology, marking material for terminals, conductors, and cables".	
1) 120 and 230 V types up to 55 °C	
2) 230 V types up to 55 °C	



1 PDT with power contact

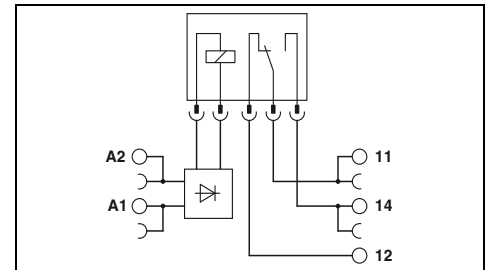

### Technical data

Input data	
Typ. input current at $U_N$	[mA]
Response/release time at $U_N$	[ms]
Input circuit DC	
Input circuit AC/DC	
Output data	
Contact material	AgSnO
Max. switching voltage	250 V AC/DC
Min. switching voltage	5 V (at 100 mA)
Limiting continuous current	6 A
Max. inrush current	on request
Min. switching current	10 mA (at 12 V)
General data	
Test voltage input/output	4 kV AC (50 Hz, 1 min.)
Ambient temperature (operation)	-40 °C ... 60 °C <sup>1)</sup>
Mechanical service life	2 x 10 <sup>7</sup> cycles
Standards/regulations	IEC 60664, EN 50178, IEC 62103
Connection data solid / stranded / AWG	0.14 - 2.5 mm <sup>2</sup> / 0.14 - 2.5 mm <sup>2</sup> / 26 - 14
Dimensions	W / H / D
EMC note	Class A product, see page 625

①	②	③	④	⑤	⑥	⑦
15.3	9	11	9.2	4.8	3.5	3.2
5/8	5/8	6/15	5/8	5/8	6/15	7/15
Yellow LED, protection against polarity reversal, freewheeling diode						
Yellow LED, bridge rectifier						

Electrical interrupting rating for PLC...21 with 1-PDT relay

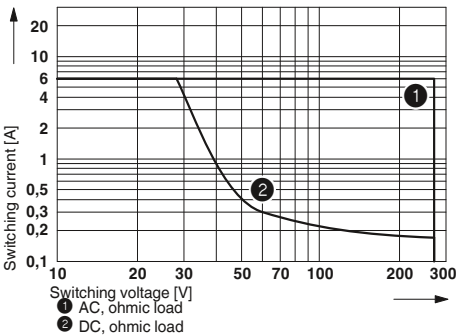

Electrical interrupting rating for PLC...21-21 with 2-PDT relay

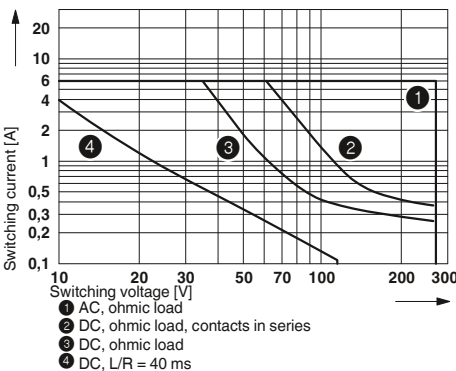

Description	Input voltage $U_N$
<b>PLC-INTERFACE, with screw connection</b>	
①	12 V DC
②	24 V DC
③	24 V AC/DC
④	48 V DC
⑤	60 V DC
⑥	120 V AC (110 V DC)
⑦	230 V AC (220 V DC)
<b>PLC-INTERFACE, with push-in connection</b>	
①	12 V DC
②	24 V DC
③	24 V AC/DC
④	48 V DC
⑤	60 V DC
⑥	120 V AC (110 V DC)
⑦	230 V AC (220 V DC)

### Ordering data

Type	Order No.	Pcs. / Pkt.
PLC-RSC- 12DC/21	2966906	10
PLC-RSC- 24DC/21	2966171	10
PLC-RSC- 24UC/21	2966184	10
PLC-RSC- 48DC/21	2966113	10
PLC-RSC- 60DC/21	2966139	10
PLC-RSC-120UC/21	2966197	10
PLC-RSC-230UC/21	2966207	10
PLC-RPT- 12DC/21	2900316	10
PLC-RPT- 24DC/21	2900299	10
PLC-RPT- 24UC/21	2900300	10
PLC-RPT- 48DC/21	2900301	10
PLC-RPT- 60DC/21	2900303	10
PLC-RPT-120UC/21	2900304	10
PLC-RPT-230UC/21	2900305	10



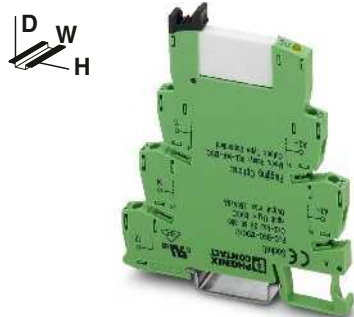

1 PDT with multi-layer gold contact

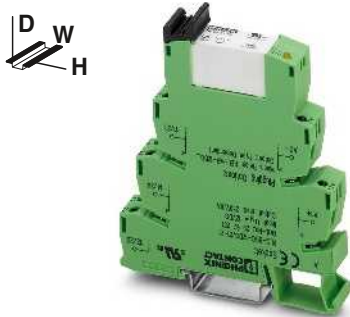

2 PDT with power contact

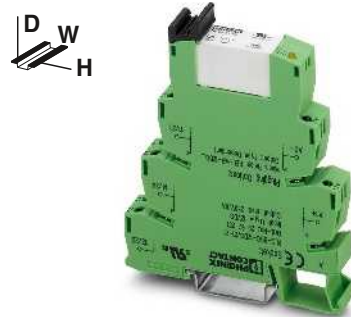

2 PDT with multi-layer gold contact

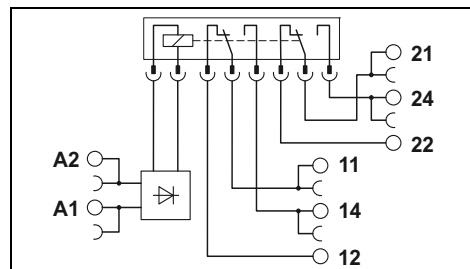
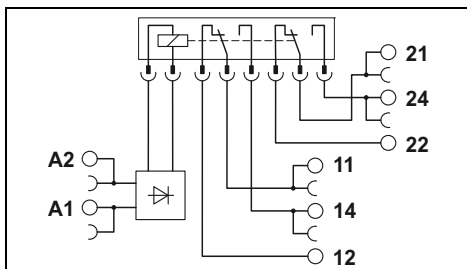
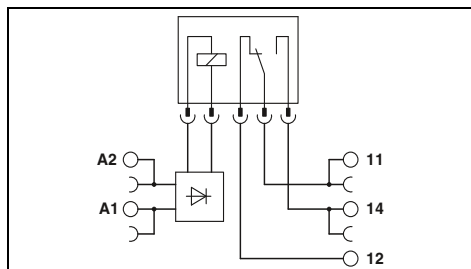

Technical data

①	②	③	④	⑤	⑥	⑦
15.3	9	11	9.2	4.8	3.5	3.2
5/8	5/8	6/15	5/8	5/8	6/15	7/15

Yellow LED, protection against polarity reversal, freewheeling diode  
Yellow LED, bridge rectifier

AgSnO, hard gold-plated  
30 V AC / 36 V DC  
100 mV (at 10 mA)  
50 mA  
50 mA  
1 mA (at 24 V)

4 kV AC (50 Hz, 1 min.)  
-40 °C ... 60 °C<sup>1)</sup>  
2 x 10<sup>7</sup> cycles  
IEC 60664, EN 50178, IEC 62103  
0.14 - 2.5 mm<sup>2</sup> / 0.14 - 2.5 mm<sup>2</sup> / 26 - 14  
6.2 mm / 80 mm / 94 mm  
Class A product, see page 625

Technical data

①	②	③	④	⑤	⑥	⑦
33	18	17.5	20	10	4.5	4.5
8/10	8/10	8/10	8/10	8/10	7/10	7/10

Yellow LED, protection against polarity reversal, freewheeling diode  
Yellow LED, bridge rectifier

AgNi  
250 V AC/DC  
5 V AC/DC (at 10 mA)  
6 A  
15 A (300 ms)  
10 mA (at 5 V)

4 kV AC (50 Hz, 1 min.)  
-40 °C ... 60 °C<sup>2)</sup>  
3 x 10<sup>7</sup> cycles  
IEC 60664, EN 50178, IEC 62103  
0.14 - 2.5 mm<sup>2</sup> / 0.14 - 2.5 mm<sup>2</sup> / 26 - 14  
14 mm / 80 mm / 94 mm  
Class A product, see page 625

Technical data

①	②	③	④	⑤	⑥	⑦
33	18	17.5	20	10	4.5	4.5
8/10	8/10	8/10	8/10	8/10	7/10	7/10

Yellow LED, protection against polarity reversal, freewheeling diode  
Yellow LED, bridge rectifier

AgNi, hard gold-plated  
30 V AC / 36 V DC  
100 mV (at 10 mA)  
50 mA  
50 mA  
1 mA (at 24 V)

4 kV AC (50 Hz, 1 min.)  
-40 °C ... 60 °C<sup>2)</sup>  
3 x 10<sup>7</sup> cycles  
IEC 60664, EN 50178, IEC 62103  
0.14 - 2.5 mm<sup>2</sup> / 0.14 - 2.5 mm<sup>2</sup> / 26 - 14  
14 mm / 80 mm / 94 mm  
Class A product, see page 625

Ordering data

Type	Order No.	Pcs. / Pkt.
PLC-RSC- 12DC/21AU	2966919	10
PLC-RSC- 24DC/21AU	2966265	10
PLC-RSC- 24UC/21AU	2966278	10
PLC-RSC- 48DC/21AU	2966126	10
PLC-RSC- 60DC/21AU	2966142	10
PLC-RSC-120UC/21AU	2966281	10
PLC-RSC-230UC/21AU	2966294	10
PLC-RPT- 12DC/21AU	2900317	10
PLC-RPT- 24DC/21AU	2900306	10
PLC-RPT- 24UC/21AU	2900307	10
PLC-RPT- 48DC/21AU	2900308	10
PLC-RPT- 60DC/21AU	2900309	10
PLC-RPT-120UC/21AU	2900310	10
PLC-RPT-230UC/21AU	2900311	10

Ordering data

Type	Order No.	Pcs. / Pkt.
PLC-RSC- 12DC/21-21	2967235	10
PLC-RSC- 24DC/21-21	2967060	10
PLC-RSC- 24UC/21-21	2967073	10
PLC-RSC- 48DC/21-21	2967248	10
PLC-RSC- 60DC/21-21	2967293	10
PLC-RSC-120UC/21-21	2967086	10
PLC-RSC-230UC/21-21	2967099	10
PLC-RPT- 12DC/21-21	2900329	10
PLC-RPT- 24DC/21-21	2900330	10
PLC-RPT- 24UC/21-21	2900332	10
PLC-RPT- 48DC/21-21	2900333	10
PLC-RPT- 60DC/21-21	2900334	10
PLC-RPT-120UC/21-21	2900335	10
PLC-RPT-230UC/21-21	2900336	10

Ordering data

Type	Order No.	Pcs. / Pkt.
PLC-RSC- 12DC/21-21AU	2967277	10
PLC-RSC- 24DC/21-21AU	2967125	10
PLC-RSC- 24UC/21-21AU	2967112	10
PLC-RSC- 48DC/21-21AU	2967280	10
PLC-RSC- 60DC/21-21AU	2967303	10
PLC-RSC-120UC/21-21AU	2967138	10
PLC-RSC-230UC/21-21AU	2967141	10
PLC-RPT- 12DC/21-21AU	2900337	10
PLC-RPT- 24DC/21-21AU	2900338	10
PLC-RPT- 24UC/21-21AU	2900339	10
PLC-RPT- 48DC/21-21AU	2900340	10
PLC-RPT- 60DC/21-21AU	2900341	10
PLC-RPT-120UC/21-21AU	2900342	10
PLC-RPT-230UC/21-21AU	2900343	10

# Relay modules

## Highly compact relay modules - PLC-INTERFACE

### Universal PLC series with solid-state relays

PLC-O... is the solid-state relay series that can be used universally comprising basic terminal blocks and plug-in solid-state relays.

The advantages:

- Slim design
- Screw and push-in connection technology
- Functional jumpers
- Integrated input circuit
- RT-III sealed solid-state relays
- High switching capacity
- Zero voltage switch at AC output
- Efficient connection to system cabling using V8 adapter

Notes:
Type of housing: Polyamide PA non-reinforced, color: green.
Marking systems and mounting material See Catalog 5
Separating plate PLC-ATP must be installed for voltages larger than 250 V (L1, L2, L3) between identical terminal blocks in adjacent modules. Potential bridging is then carried out with FBST 8-PLC... or FBST 500....
For derating curves see page 425



Max. DC voltage output of 100 mA

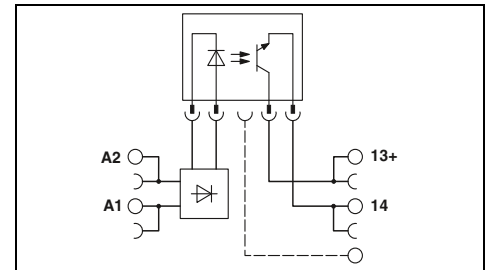

Input data	
Permissible range (with reference to $U_N$ )	
Switching level (with reference to $U_N$ )	1 signal ("H") 0 signal ("L")
Typ. input current at $U_N$	[mA]
Typ. switch-on time at $U_N$	[ms]
Typ. shutdown time at $U_N$	[ms]
Transmission frequency $f_{limit}$	[Hz]
Input circuit DC	
Input circuit AC/DC	
Output data	
Max. switching voltage	48 V DC
Min. switching voltage	3 V DC
Max. inrush current	-
Min. / max. switching current	- / 100 mA
Output protection	Protection against polarity reversal, surge protection
Voltage drop at max. limiting continuous current	≤ 1 V
Leakage current in off state	-
Max. load value	-
General data	
Test voltage input/output	2.5 kV (50 Hz, 1 min.)
Ambient temperature (operation)	-25 °C ... 60 °C
Standards/regulations	IEC 60664, EN 50178, IEC 62103
Pollution degree / surge voltage category	2 / III
Connection data solid / stranded / AWG	0.14 - 2.5 mm <sup>2</sup> / 0.14 - 2.5 mm <sup>2</sup> / 26 - 14
Dimensions	W / H / D 6.2 mm / 80 mm / 94 mm
EMC note	Class A product, see page 625

Technical data					
①	②	③	④	⑤	⑥
0.8 - 1.2	0.8 - 1.2	0.8 - 1.2	0.8 - 1.1	0.9 - 1.1	0.9 - 1.1
≥ 0.8	≥ 0.8	≥ 0.8	≥ 0.8	≥ 0.9	≥ 0.8
≤ 0.4	≤ 0.3	≤ 0.4	≤ 0.4	≤ 0.3	≤ 0.3
8.5	9	5	3	3.5	3.5
0.02	0.03	0.04	1	3	3
0.3	0.3	2	3	4	5
300	300	100	50	10	10
Yellow LED, protection against polarity reversal, freewheeling diode					
Yellow LED, bridge rectifier					

Description	Input voltage $U_N$
<b>PLC-INTERFACE, with screw connection</b>	
①	24 V DC
②	48 V DC
③	60 V DC
④	125 V DC
⑤	120 V AC (110 V DC)
⑥	230 V AC (220 V DC)
<b>PLC-INTERFACE, with push-in connection</b>	
①	24 V DC
②	48 V DC
③	60 V DC
⑤	120 V AC (110 V DC)
⑥	230 V AC (220 V DC)

Ordering data		
Type	Order No.	Pcs. / Pkt.
PLC-OSC- 24DC/ 48DC/100	2966728	10
PLC-OSC- 48DC/ 48DC/100	2966993	10
PLC-OSC- 60DC/ 48DC/100	2967455	10
PLC-OSC-125DC/ 48DC/100	2980047	10
PLC-OSC-120UC/ 48DC/100	2966744	10
PLC-OSC-230UC/ 48DC/100	2966757	10
PLC-OPT- 24DC/ 48DC/100	2900352	10
PLC-OPT- 48DC/ 48DC/100	2900353	10
PLC-OPT- 60DC/ 48DC/100	2900354	10
PLC-OPT-120UC/ 48DC/100	2900355	10
PLC-OPT-230UC/ 48DC/100	2900356	10

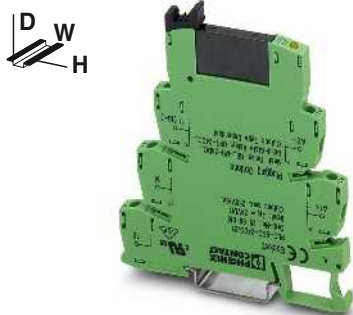

Max. DC voltage output of 3 A

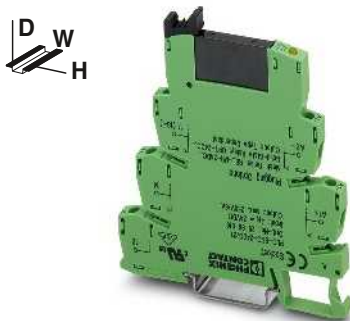

Max. AC voltage output of 750 mA

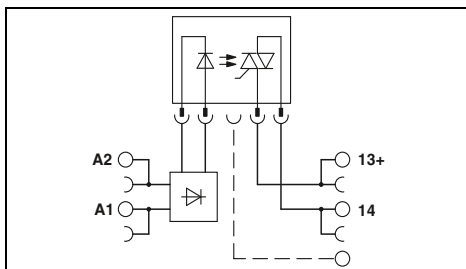
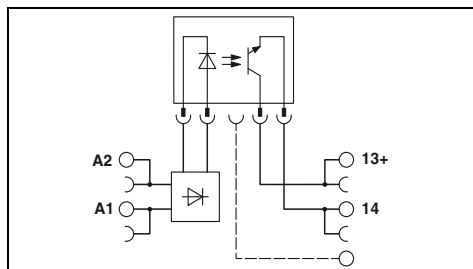

Technical data

①	②	③	④	⑤	⑥
0.8 - 1.2	0.8 - 1.2	0.8 - 1.2	0.8 - 1.1	0.9 - 1.1	0.9 - 1.1
≥ 0.8	≥ 0.8	≥ 0.8	≥ 0.8	≥ 0.8	≥ 0.8
≤ 0.4	≤ 0.4	≤ 0.3	≤ 0.3	≤ 0.3	≤ 0.3
8.5	9	5	3	3.5	3.5
0.02	0.03	0.04	0.04	3.5	4
0.3	0.3	0.5	0.6	7	7
300	300	100	100	10	10

Yellow LED, protection against polarity reversal, freewheeling diode  
Yellow LED, bridge rectifier

33 V DC  
3 V DC  
15 A (10 ms)  
- / 3 A (see derating curve)  
Protection against polarity reversal, surge protection  
≤ 200 mV  
-  
-

2.5 kV (50 Hz, 1 min.)  
-25 °C ... 60 °C  
IEC 60664, EN 50178, IEC 62103  
2 / III

0.14 - 2.5 mm<sup>2</sup> / 0.14 - 2.5 mm<sup>2</sup> / 26 - 14  
6.2 mm / 80 mm / 94 mm  
Class A product, see page 625

Technical data

①	②	③	④	⑤	⑥
0.8 - 1.2	0.8 - 1.2	0.8 - 1.2	0.8 - 1.1	0.9 - 1.1	0.8 - 1.1
≥ 0.8	≥ 0.8	≥ 0.8	≥ 0.8	≥ 0.8	≥ 0.8
≤ 0.25	≤ 0.25	≤ 0.3	≤ 0.3	≤ 0.25	≤ 0.25
8	9	6	3.5	4	3.5
10	10	10	10	10	10
10	10	10	10	10	10
10	10	10	10	3	3

253 V AC  
24 V AC  
30 A (10 ms)  
10 mA / 0.75 A (see derating curve)  
RCV circuit  
< 1 V  
< 1 mA (in off state)  
4.5 A<sup>2</sup>s

2.5 kV (50 Hz, 1 min.)  
-25 °C ... 60 °C  
IEC 60664, EN 50178, IEC 62103  
2 / III

0.14 - 2.5 mm<sup>2</sup> / 0.14 - 2.5 mm<sup>2</sup> / 26 - 14  
6.2 mm / 80 mm / 94 mm  
Class A product, see page 625

Ordering data

Ordering data

Type	Order No.	Pcs. / Pkt.
PLC-OSC- 24DC/ 24DC/ 2	2966634	10
PLC-OSC- 48DC/ 24DC/ 2	2967002	10
PLC-OSC- 60DC/ 24DC/ 2	2967468	10
PLC-OSC-125DC/ 24DC/ 2	2980050	10
PLC-OSC-120UC/ 24DC/ 2	2966650	10
PLC-OSC-230UC/ 24DC/ 2	2966663	10
PLC-OPT- 24DC/ 24DC/2	2900364	10
PLC-OPT- 48DC/ 24DC/2	2900365	10
PLC-OPT- 60DC/ 24DC/2	2900366	10
PLC-OPT-120UC/ 24DC/2	2900367	10
PLC-OPT-230UC/ 24DC/2	2900368	10

Type	Order No.	Pcs. / Pkt.
PLC-OSC- 24DC/230AC/ 1	2967840	10
PLC-OSC- 48DC/230AC/ 1	2967853	10
PLC-OSC- 60DC/230AC/ 1	2967866	10
PLC-OSC-125DC/230AC/ 1	2980063	10
PLC-OSC-120UC/230AC/ 1	2967879	10
PLC-OSC-230UC/230AC/ 1	2967882	10
PLC-OPT- 24DC/230AC/1	2900369	10
PLC-OPT- 48DC/230AC/1	2900370	10
PLC-OPT- 60DC/230AC/1	2900371	10
PLC-OPT-120UC/230AC/1	2900372	10
PLC-OPT-230UC/230AC/1	2900374	10

# Relay modules

## Highly compact relay modules - PLC-INTERFACE

### PLC actuator series for output functions

PLC actuator series for coupling controller and actuators, such as motors, contactors, valves, etc.

The advantages:

- Actuator connected directly to relay module
- No need for additional modular terminal blocks
- Space savings of up to 80%
- Time savings of up to 60%
- Screw and push-in connection technology
- Relay modules with safe isolation according to DIN EN 50178 between coil and contact
- Functional jumpers
- Efficient connection to system cabling using V8 adapter

Notes:
Type of housing: Polyamide PA non-reinforced, color: green.
Marking systems and mounting material See Catalog 5
Separating plate PLC-ATP must be installed for voltages larger than 250 V (L1, L2, L3) between identical terminal blocks in adjacent modules. Potential bridging is then carried out with FBST 8-PLC... or FBST 500....
For diagrams of operating voltage ranges, see page 423
For derating curves see page 425

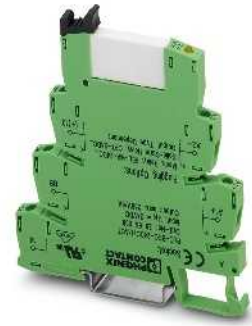

1 N/O contact with power contact

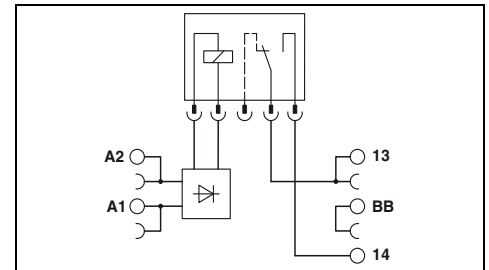

### Technical data

Input data	Permissible range (with reference to $U_N$ )	See diagram
Switching level (with reference to $U_N$ )	1 signal ("H") 0 signal ("L")	
Typ. input current at $U_N$	[mA]	9
Typ. response time/switch-on time at $U_N$	[ms]	5
Typ. release time/shutdown time at $U_N$	[ms]	8
Transmission frequency $f_{limit}$	[Hz]	
Input circuit DC		Yellow LED, protection against polarity reversal, freewheeling diode
Output data		
Contact material		AgSnO
Max. switching voltage		250 V AC/DC
Min. switching voltage		5 V (at 100 mA)
Limiting continuous current		6 A
Max. inrush current		on request
Min. switching current		10 mA (at 12 V)
Output protection		-
Voltage drop at max. limiting continuous current		-
Leakage current in off state		-
Phase angle (cos $\phi$ )		-
Max. load value		-
General data		
Test voltage input/output		4 kV AC (50 Hz, 1 min.)
Ambient temperature (operation)		-40 °C ... 60 °C
Mechanical service life		2 x 10 <sup>7</sup> cycles
Standards/regulations		IEC 60664, EN 50178, IEC 62103
Pollution degree / surge voltage category		3 / III
Connection data solid / stranded / AWG		0.14 - 2.5 mm <sup>2</sup> / 0.14 - 2.5 mm <sup>2</sup> / 26 - 14
Dimensions	W / H / D	6.2 mm / 80 mm / 94 mm
EMC note		Class A product, see page 625

Electrical interrupting rating for PLC...24DC/1/ACT with 1-N/O relay

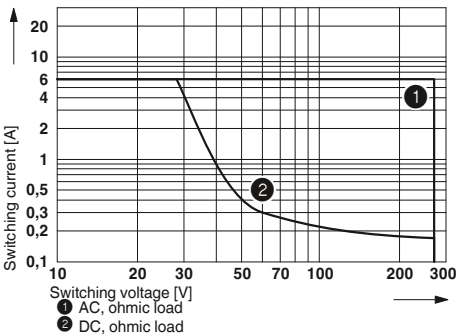

Electrical interrupting rating for PLC...24DC/1-1/ACT with 2-N/O relay

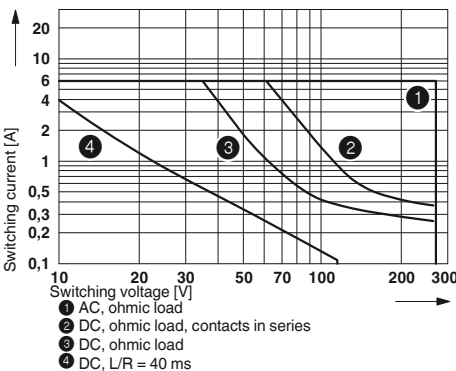

Description	Input voltage $U_N$
PLC-INTERFACE, with screw connection	
①	5 V DC
②	24 V DC
PLC-INTERFACE, with push-in connection	
①	5 V DC
②	24 V DC

### Ordering data

Type	Order No.	Pcs. / Pkt.
PLC-RSC- 24DC/ 1/ACT	2966210	10
PLC-RPT- 24DC/ 1/ACT	2900312	10

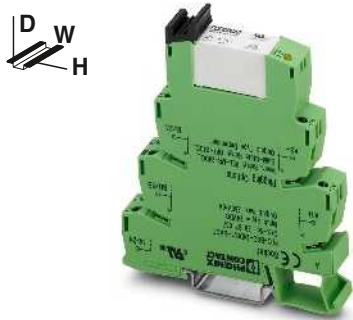

2 N/O contacts with power contact

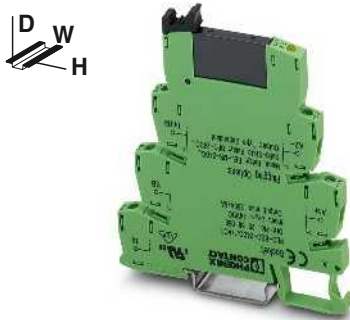

Max. DC voltage output of 3 A

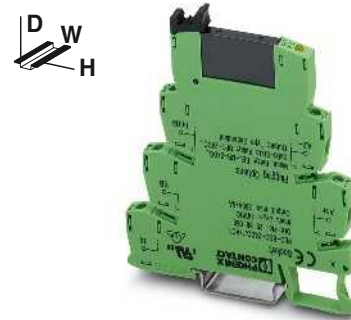

Max. AC voltage output of 750 mA

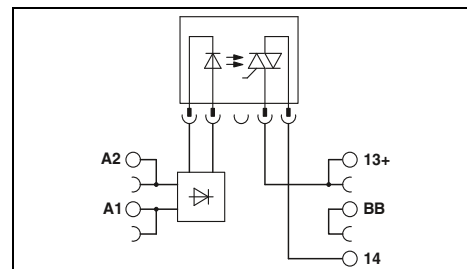
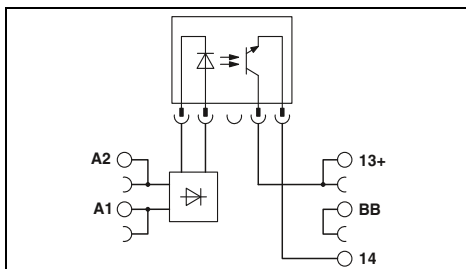
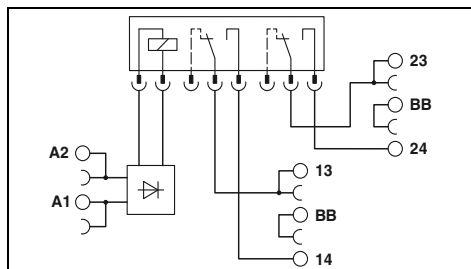

**Technical data**

**Technical data**

**Technical data**

②	See diagram
18	
8	
10	
Yellow LED, protection against polarity reversal, freewheeling diode	
AgNi	-
250 V AC/DC	33 V DC
5 V AC/DC	3 V DC
6 A	3 A (see derating curve)
8 A	15 A (10 ms)
10 mA	-
-	Protection against polarity reversal, surge protection
-	≤ 200 mV
-	-
-	-
-	-
4 kV AC (50 Hz, 1 min.)	2.5 kV (50 Hz, 1 min.)
-40 °C ... 60 °C	-25 °C ... 60 °C
3 x 10 <sup>7</sup> cycles	-
IEC 60664, EN 50178, IEC 62103	IEC 60664, EN 50178, IEC 62103
3 / III	2 / III
0.14 - 2.5 mm <sup>2</sup> / 0.14 - 2.5 mm <sup>2</sup> / 26 - 14	0.14 - 2.5 mm <sup>2</sup> / 0.14 - 2.5 mm <sup>2</sup> / 26 - 14
14 mm / 80 mm / 94 mm	6.2 mm / 80 mm / 94 mm
Class A product, see page 625	Class A product, see page 625

①	②
0.8 - 1.2	0.8 - 1.2
≥ 0.8	≥ 0.8
≤ 0.25	≤ 0.4
9.5	8.5
0.02	0.02
0.3	0.3
300	300
Yellow LED, protection against polarity reversal, freewheeling diode	
-	-
253 V AC	24 V AC
24 V AC	0.75 A (see derating curve)
0.75 A (see derating curve)	30 A (10 ms)
10 mA	10 mA
RCV circuit	RCV circuit
< 1 V	< 1 V
< 1 mA (in off state)	< 1 mA (in off state)
0.5	0.5
4.5 A <sup>2s</sup>	4.5 A <sup>2s</sup>
2.5 kV (50 Hz, 1 min.)	2.5 kV (50 Hz, 1 min.)
-25 °C ... 60 °C	-25 °C ... 60 °C
-	-
IEC 60664, EN 50178, IEC 62103	IEC 60664, EN 50178, IEC 62103
2 / III	2 / III
0.14 - 2.5 mm <sup>2</sup> / 0.14 - 2.5 mm <sup>2</sup> / 26 - 14	0.14 - 2.5 mm <sup>2</sup> / 0.14 - 2.5 mm <sup>2</sup> / 26 - 14
6.2 mm / 80 mm / 94 mm	6.2 mm / 80 mm / 94 mm
Class A product, see page 625	Class A product, see page 625

②	0.8 - 1.2
0.8 - 1.2	0.8 - 1.2
≥ 0.8	≥ 0.8
≤ 0.25	≤ 0.4
9	9
3	3
9	9
10	10
Yellow LED, protection against polarity reversal, freewheeling diode	
-	-
253 V AC	24 V AC
24 V AC	0.75 A (see derating curve)
0.75 A (see derating curve)	30 A (10 ms)
10 mA	10 mA
RCV circuit	RCV circuit
< 1 V	< 1 V
< 1 mA (in off state)	< 1 mA (in off state)
0.5	0.5
4.5 A <sup>2s</sup>	4.5 A <sup>2s</sup>
2.5 kV (50 Hz, 1 min.)	2.5 kV (50 Hz, 1 min.)
-25 °C ... 60 °C	-25 °C ... 60 °C
-	-
IEC 60664, EN 50178, IEC 62103	IEC 60664, EN 50178, IEC 62103
2 / III	2 / III
0.14 - 2.5 mm <sup>2</sup> / 0.14 - 2.5 mm <sup>2</sup> / 26 - 14	0.14 - 2.5 mm <sup>2</sup> / 0.14 - 2.5 mm <sup>2</sup> / 26 - 14
6.2 mm / 80 mm / 94 mm	6.2 mm / 80 mm / 94 mm
Class A product, see page 625	Class A product, see page 625

**Ordering data**

**Ordering data**

**Ordering data**

Type	Order No.	Pcs. / Pkt.
PLC-RSC- 24DC/ 1- 1/ACT	2967109	10

Type	Order No.	Pcs. / Pkt.
PLC-OSC- 5DC/ 24DC/ 2/ACT	2980144	10
PLC-OSC- 24DC/ 24DC/ 2/ACT	2966676	10
PLC-OPT- 5DC/ 24DC/2/ACT	2900375	10
PLC-OPT- 24DC/ 24DC/2/ACT	2900376	10

Type	Order No.	Pcs. / Pkt.
PLC-OSC- 24DC/230AC/ 1/ACT	2967947	10

# Relay modules

## Highly compact relay modules - PLC-INTERFACE

### PLC actuator series for output functions

PLC actuator series with solid-state power relays for coupling the controller and actuators, such as motors, contactors, valves, etc.

<b>Notes:</b>
Type of housing: Polyamide PA non-reinforced, color: green.
Marking systems and mounting material See Catalog 5
Separating plate PLC-ATP must be installed for voltages larger than 250 V (L1, L2, L3) between identical terminal blocks in adjacent modules. Potential bridging is then carried out with FBST 8-PLC... or FBST 500....
For derating curves see page 425



Max. DC voltage output of 5 A

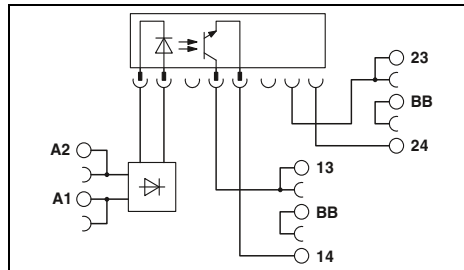

#### Technical data

<b>Input data</b>	①
Permissible range (with reference to $U_N$ )	0.8 - 1.2
Switching level (with reference to $U_N$ )	1 signal ("H") $\geq 0.8$ 0 signal ("L") $\leq 0.4$
Typ. input current at $U_N$	[mA] 9
Typ. switch-on time at $U_N$	[ms] 0.02
Typ. shutdown time at $U_N$	[ms] 0.4
Transmission frequency $f_{limit}$	[Hz] 300
<b>Output data</b>	Yellow LED, protection against polarity reversal, freewheeling diode
Max. / min. switching voltage	33 V DC / 3 V DC
Max. inrush current	15 A (10 ms)
Min. / max. switching current	- / 5 A (see derating curve)
Output protection	Protection against polarity reversal, surge protection
Voltage drop at max. limiting continuous current	$\leq 200$ mV
Leakage current in off state	-
Phase angle ( $\cos \phi$ )	-
Max. load value	-
<b>General data</b>	
Rated insulation voltage	-
Rated surge voltage	Basic insulation
Ambient temperature (operation)	-20 °C ... 60 °C
Standards/regulations	IEC 60664, EN 50178, IEC 62103
Pollution degree / surge voltage category	2 / III
<b>Mounting position / mounting</b>	see derating / can be aligned without spacing
Connection data solid / stranded / AWG	0.14 - 2.5 mm <sup>2</sup> / 0.14 - 2.5 mm <sup>2</sup> / 26 - 14
Dimensions	14 mm / 80 mm / 94 mm

#### Ordering data

Description	Input voltage $U_N$
<b>PLC-INTERFACE, with screw connection</b>	
①	24 V DC

Type	Order No.	Pcs. / Pkt.
PLC-OSC-24DC/24DC/5/ACT	2982786	10



Max. AC voltage output of 2 A

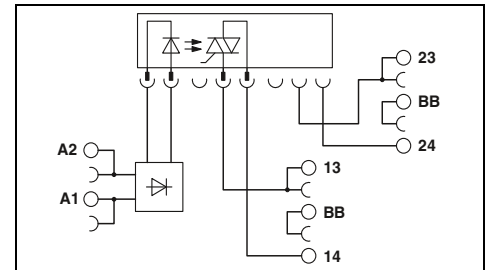

#### Technical data

<b>Input data</b>	①
Permissible range (with reference to $U_N$ )	0.8 - 1.2
Switching level (with reference to $U_N$ )	1 signal ("H") $\geq 0.8$ 0 signal ("L") $\leq 0.4$
Typ. input current at $U_N$	[mA] 9
Typ. switch-on time at $U_N$	[ms] 10
Typ. shutdown time at $U_N$	[ms] 10
Transmission frequency $f_{limit}$	[Hz] 10
<b>Output data</b>	Yellow LED, protection against polarity reversal, freewheeling diode
Max. / min. switching voltage	253 V AC / 24 V AC
Max. inrush current	30 A (10 ms)
Min. / max. switching current	25 mA / 2 A (see derating curve)
Output protection	Surge protection
Voltage drop at max. limiting continuous current	$\leq 1$ V
Leakage current in off state	typ. 1 mA
Phase angle ( $\cos \phi$ )	0.5
Max. load value	4 A <sup>2</sup> s (tp = 10 ms, at 25 °C)
<b>General data</b>	
Rated insulation voltage	-
Rated surge voltage	Basic insulation
Ambient temperature (operation)	-20 °C ... 60 °C
Standards/regulations	IEC 60664, EN 50178, IEC 62103
Pollution degree / surge voltage category	2 / III
<b>Mounting position / mounting</b>	see derating / can be aligned without spacing
Connection data solid / stranded / AWG	0.14 - 2.5 mm <sup>2</sup> / 0.14 - 2.5 mm <sup>2</sup> / 26 - 14
Dimensions	14 mm / 80 mm / 94 mm

#### Ordering data

Type	Order No.	Pcs. / Pkt.
PLC-OSC-24DC/230AC/2/ACT	2982760	10

**PLC actuator series for output functions**

PLC actuator basic terminal blocks that can be fitted with a mechanical or solid-state relay. For coupling the controller and actuators, such as motors, contactors, valves, etc.

<b>Notes:</b>
Maximum interrupting rating diagrams, see page 426
For derating curves see page 425



Basic terminal block that can be fitted with mech. relay



Basic terminal block that can be fitted with solid-state relay

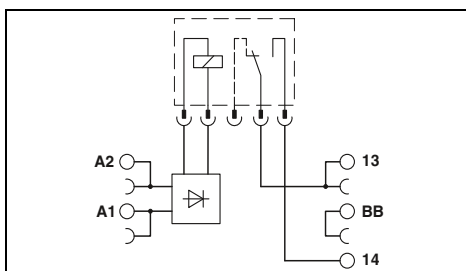

**Technical data**

<b>Input data</b>	
Permissible range (with reference to $U_N$ )	0.8 ... 1.2
Typ. input current with $U_N$ (50 /60 Hz)	15.6 mA / 8.5 mA
Typ. response time at $U_N$	5 ms
Typ. release time at $U_N$	30 ms
<b>Input circuit</b>	Yellow LED, bridge rectifier
<b>Output data with:</b>	REL-MR-24DC/21AU    REL-MR-24DC/21
<b>Contact type</b>	Single contact, 1 N/O contact    Single contact, 1 N/O contact
<b>Contact material</b>	AgSnO, hard gold-plated    AgSnO
<b>Max. switching voltage</b>	30 V AC / 36 V DC    250 V AC/DC
<b>Min. switching voltage</b>	100 mV (at 10 mA)    5 V (at 100 mA)
<b>Limiting continuous current</b>	50 mA    6 A
<b>Min. switching current</b>	1 mA (at 24 V)    10 mA (at 12 V)
<b>Output protection</b>	-    -
<b>Voltage drop at limiting continuous current</b>	-    -
<b>Leakage current in off state</b>	-    -
<b>Max. load value <math>I^2 \times t</math> (t = 10 ms)</b>	-    -
<b>General data</b>	
<b>Rated insulation voltage</b>	250 V AC
<b>Rated surge voltage / insulation</b>	6 kV / Safe isolation, increased insulation
<b>Ambient temperature (operation)</b>	-20 °C ... 60 °C
<b>Clearance and creepage distances</b>	EN 50178 , IEC 62103
<b>Pollution degree / Surge voltage category</b>	2 / III
<b>Connection data solid / stranded / AWG</b>	0.14 - 2.5 mm <sup>2</sup> / 0.14 - 2.5 mm <sup>2</sup> / 26 - 14
<b>Dimensions</b>	W / H / D 6.2 mm / 80 mm / 94 mm

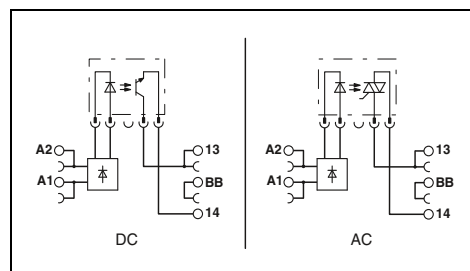

**Technical data**

<b>Input data</b>		
Permissible range (with reference to $U_N$ )	0.8 ... 1.2	
Typ. input current with $U_N$ (50 /60 Hz)	15 mA / 8.3 mA	
Typ. response time at $U_N$	10 ms	
Typ. release time at $U_N$	20 ms	
<b>Input circuit</b>	Yellow LED, bridge rectifier	
<b>Output data with:</b>	OPT...48DC/...    OPT...24DC/...    OPT...230AC/...	
<b>Contact type</b>	-    -    -	
<b>Contact material</b>	-    -    -	
<b>Max. switching voltage</b>	48 V DC    33 V DC    253 V AC	
<b>Min. switching voltage</b>	3 V DC    3 V DC    24 V AC	
<b>Limiting continuous current</b>	100 mA    3 A (see derating curve)    0.75 A (see derating curve)	
<b>Min. switching current</b>	1 mA (at 24 V)    10 mA (at 12 V)	
<b>Output protection</b>	Protection against polarity reversal, surge protection    Protection against polarity reversal, surge protection    RCV circuit	
<b>Voltage drop at limiting continuous current</b>	≤ 1 V    ≤ 150 mV    ≤ 1 V	
<b>Leakage current in off state</b>	-    -    ≤ 1 mA	
<b>Max. load value <math>I^2 \times t</math> (t = 10 ms)</b>	-    -    4.5 A <sup>2</sup> s (tp = 10 ms, at 25 °C)	
<b>General data</b>		
<b>Rated insulation voltage</b>	250 V AC	
<b>Rated surge voltage / insulation</b>	6 kV / Safe isolation, increased insulation	
<b>Ambient temperature (operation)</b>	-20 °C ... 60 °C	
<b>Clearance and creepage distances</b>	EN 50178 , IEC 62103	
<b>Pollution degree / Surge voltage category</b>	2 / III	
<b>Connection data solid / stranded / AWG</b>	0.14 - 2.5 mm <sup>2</sup> / 0.14 - 2.5 mm <sup>2</sup> / 26 - 14	
<b>Dimensions</b>	W / H / D 6.2 mm / 80 mm / 94 mm	

**Ordering data**

Description	Voltage $U_N$
<b>PLC-INTERFACE, with screw connection</b>	24 V AC/DC
<b>PLC-INTERFACE, with push-in connection</b>	24 V AC/DC

Type	Order No.	Pcs. / Pkt.
PLC-BSC- 24UC/ 1/ACT	2982799	10
PLC-BPT- 24UC/ 1/ACT	2900450	10

**Ordering data**

Type	Order No.	Pcs. / Pkt.
PLC-BSC- 24UC/ 1/ACT	2982799	10
PLC-BPT- 24UC/ 1/ACT	2900450	10

**Accessories**

<b>Plug-in miniature relay</b> with multi-layer gold contacts with power contacts	<b>REL-MR- 24DC/21AU</b> <b>REL-MR- 24DC/21</b>	<b>2961121</b> <b>2961105</b>	<b>10</b> <b>10</b>
<b>Plug-in solid-state relay</b> Solid-state input relay Solid-state power relay Solid-state power relay	<b>OPT-24DC/ 48DC/100</b> <b>OPT-24DC/ 24DC/ 2</b> <b>OPT-24DC/230AC/ 1</b>	<b>2966618</b> <b>2966595</b> <b>2967950</b>	<b>10</b> <b>10</b> <b>10</b>

<b>Plug-in miniature relay</b> with multi-layer gold contacts with power contacts	<b>REL-MR- 24DC/21AU</b> <b>REL-MR- 24DC/21</b>	<b>2961121</b> <b>2961105</b>	<b>10</b> <b>10</b>
<b>Plug-in solid-state relay</b> Solid-state input relay Solid-state power relay Solid-state power relay	<b>OPT-24DC/ 48DC/100</b> <b>OPT-24DC/ 24DC/ 2</b> <b>OPT-24DC/230AC/ 1</b>	<b>2966618</b> <b>2966595</b> <b>2967950</b>	<b>10</b> <b>10</b> <b>10</b>



# Relay modules

## Highly compact relay modules - PLC-INTERFACE

### PLC sensor series for input functions

PLC sensor series for coupling controller and sensors, such as proximity switches, limit switches or auxiliary contacts

The advantages:

- Direct connection of sensor to relay module
- No need for additional modular terminal blocks
- Space savings of up to 80%
- Time savings of up to 60%
- Screw and push-in connection technology
- Relay modules with safe isolation according to DIN EN 50178 between coil and contact
- Functional jumpers
- Efficient connection to system cabling using V8 adapter

Notes:
Type of housing: Polyamide PA non-reinforced, color: green.
Marking systems and mounting material See Catalog 5
Separating plate PLC-ATP must be installed for voltages larger than 250 V (L1, L2, L3) between identical terminal blocks in adjacent modules. Potential bridging is then carried out with FBST 8-PLC... or FBST 500....
If the specified maximum values for multi-layer contact relays are exceeded, the gold plating is destroyed. The maximum values of the power contact relay are then valid. This can result in a shorter service life than with a pure power contact.
For diagrams of operating voltage ranges, see page 423
1) 120 and 230 V types up to 55 °C



Relay module  
1 N/O contact

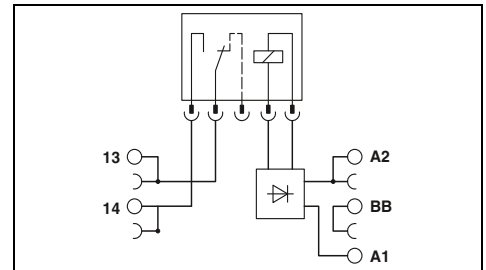

### Technical data

Input data	1	2	3
Permissible range (with reference to $U_N$ )	See diagram		
Switching level (with reference to $U_N$ )	1 signal ("H") 0 signal ("L")		
Typ. input current at $U_N$	[mA]	9	3.5 3.2
Typ. response time/switch-on time at $U_N$	[ms]	5	6 7
Typ. release time/shutdown time at $U_N$	[ms]	8	15 15
Transmission frequency $f_{limit}$	[Hz]		
Input circuit DC			
Input circuit AC/DC			
Output data			
Contact material	AgSnO, hard gold-plated		
Max. switching voltage	30 V AC / 36 V DC		
Min. switching voltage	100 mV (at 10 mA)		
Limiting continuous current	50 mA		
Max. inrush current	50 mA		
Min. switching current	1 mA (at 24 V)		
Output protection	-		
Voltage drop at max. limiting continuous current	-		
General data			
Test voltage input/output	4 kV AC (50 Hz, 1 min.)		
Ambient temperature (operation)	-40 °C ... 60 °C <sup>1)</sup>		
Mechanical service life	2 x 10 <sup>7</sup> cycles		
Standards/regulations	IEC 60664, EN 50178, IEC 62103		
Pollution degree / surge voltage category	3 / III		
Connection data solid / stranded / AWG	0.14 - 2.5 mm <sup>2</sup> / 0.14 - 2.5 mm <sup>2</sup> / 26 - 14		
Dimensions	W / H / D 6.2 mm / 80 mm / 94 mm		
EMC note	Class A product, see page 625		

①	②	③
See diagram		
Yellow LED, protection against polarity reversal, freewheeling diode		
Yellow LED, bridge rectifier		

### Ordering data

Description	Input voltage $U_N$
<b>PLC-INTERFACE, with screw connection</b>	
①	24 V DC
②	120 V AC (110 V DC)
③	230 V AC (220 V DC)
<b>PLC-INTERFACE, with push-in connection</b>	
①	24 V DC
②	120 V AC (110 V DC)
③	230 V AC (220 V DC)

Type	Order No.	Pcs. / Pkt.
PLC-RSC- 24DC/ 1AU/SEN	2966317	10
PLC-RSC-120UC/ 1AU/SEN	2966320	10
PLC-RSC-230UC/ 1AU/SEN	2966333	10
PLC-RPT- 24DC/ 1AU/SEN	2900313	10
PLC-RPT-120UC/ 1AU/SEN	2900314	10
PLC-RPT-230UC/ 1AU/SEN	2900315	10

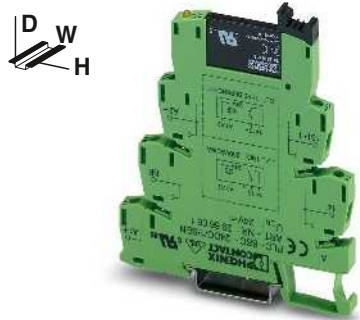

Max. DC voltage output of 100 mA

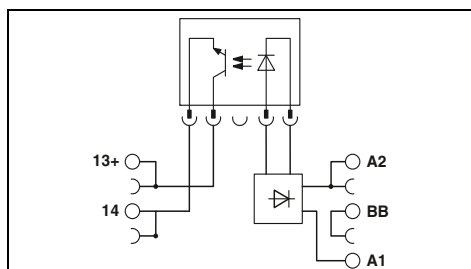

Technical data

①	②	③
0.8 - 1.2	0.8 - 1.1	0.8 - 1.1
≥ 0.8	≥ 0.8	≥ 0.8
≤ 0.4	≤ 0.3	≤ 0.3
8.5	3.5	3.5
0.02	6	3
0.3	10	5
300	10	10

Yellow LED, protection against polarity reversal, freewheeling diode  
 Yellow LED, bridge rectifier

-  
 48 V DC  
 3 V DC  
 100 mA  
 -  
 -  
 Protection against polarity reversal, surge protection  
 ≤ 1 V

2.5 kV (50 Hz, 1 min.)  
 -25 °C ... 60 °C

-  
 IEC 60664, EN 50178, IEC 62103  
 2 / III  
 0.14 - 2.5 mm<sup>2</sup> / 0.14 - 2.5 mm<sup>2</sup> / 26 - 14  
 6.2 mm / 80 mm / 94 mm  
 Class A product, see page 625

Ordering data

Type	Order No.	Pcs. / Pkt.
PLC-OSC- 24DC/ 48DC/100/SEN	2966773	10
PLC-OSC-120UC/ 48DC/100/SEN	2966799	10
PLC-OSC-230UC/ 48DC/100/SEN	2966809	10
PLC-OPT- 24DC/ 48DC/100/SEN	2900358	10
PLC-OPT-120UC/ 48DC/100/SEN	2900359	10
PLC-OPT-230UC/ 48DC/100/SEN	2900361	10

# Relay modules

## Highly compact relay modules - PLC-INTERFACE

### PLC-INTERFACE for high inrush currents

PLC relay modules for high inrush currents due, for example, to capacitive loads

The advantages:

- Max. inrush current of 130 A
- Direct connection of load return line thanks to actuator type
- Screw and push-in connection technology
- Safe isolation according to DIN EN 50178 between coil and contact
- Functional jumpers
- Efficient connection to system cabling using V8 adapter

Notes:
Type of housing: Polyamide PA non-reinforced, color: green.
Marking systems and mounting material See Catalog 5
Separating plate PLC-ATP must be installed for voltages larger than 250 V (L1, L2, L3) between identical terminal blocks in adjacent modules. Potential bridging is then carried out with FBST 8-PLC... or FBST 500....
For diagrams of operating voltage ranges, see page 423



1 N/O contact of up to 130 A peak

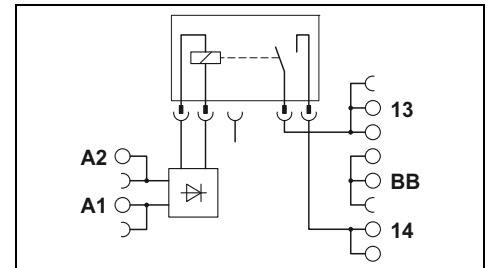

#### Technical data

Input data	
Typ. input current at $U_N$	[mA]
Response/release time at $U_N$	[ms]
Input circuit DC	
Output data	
Contact material	
Max. switching voltage	
Min. switching voltage	
Max. inrush current	
General data	
Test voltage input/output	
Ambient temperature (operation)	
Mechanical service life	
Standards/regulations	
Connection data solid / stranded / AWG	
Dimensions	W / H / D
EMC note	

①	18
	8 / 10
	Yellow LED, protection against polarity reversal, freewheeling diode
	AgSnO
	250 V AC/DC
	12 V AC/DC (at 100 mA)
	80 A (for 20 ms) / 130 A (peak, at capacitive load, 230 V AC, 24 $\mu$ F)
	4 kV AC (50 Hz, 1 min.)
	-40 °C ... 60 °C
	3 x 10 <sup>7</sup> cycles
	IEC 60664, EN 50178, IEC 62103
	0.14 - 2.5 mm <sup>2</sup> / 0.14 - 2.5 mm <sup>2</sup> / 26 - 14
	14 mm / 80 mm / 94 mm
	Class A product, see page 625

#### Basic behavior of capacitive loads:

- Very high input current
- Voltage increases with an e-function

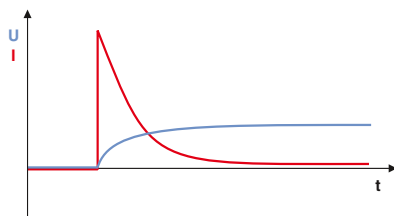

#### Maximum interrupting rating

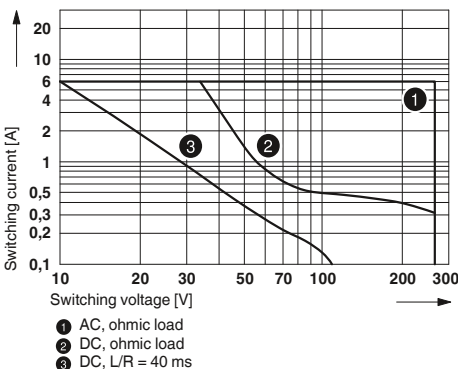

Description	Input voltage $U_N$
PLC-INTERFACE, with screw connection ①	24 V DC
PLC-INTERFACE, with push-in connection ①	24 V DC

#### Ordering data

Type	Order No.	Pcs. / Pkt.
PLC-RSC- 24DC/ 1IC/ACT	2967604	10
PLC-RPT- 24DC/ 1IC/ACT	2900298	10

**PLC-INTERFACE for high continuous currents**

PLC relay modules for high continuous switching currents

The advantages:

- Max. continuous current of 10 A
- Safe isolation according to DIN EN 50178 between coil and contact
- Screw and push-in connection technology
- Functional jumpers
- Efficient connection to system cabling using V8 adapter
- Long electrical service life thanks to 16 A relay
- All common input voltages of 12 V DC to 230 V AC

<b>Notes:</b>
Type of housing: Polyamide PA non-reinforced, color: green.
Marking systems and mounting material See Catalog 5
Separating plate PLC-ATP must be installed for voltages larger than 250 V (L1, L2, L3) between identical terminal blocks in adjacent modules. Potential bridging is then carried out with FBST 8-PLC... or FBST 500....
For diagrams of operating voltage ranges, see page 423
*) 230 V types up to 55 °C



1 PDT up to 10 A

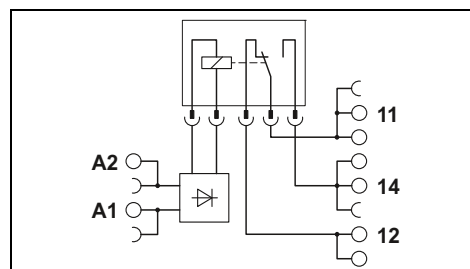

**Technical data**

Input data	①	②	③	④	⑤	⑥	⑦
Typ. input current at $U_N$ [mA]	33	18	17.5	20	10	4.5	4.5
Response/release time at $U_N$ [ms]	8 / 10	8 / 10	8 / 10	8 / 10	8 / 10	7 / 10	7 / 10
Input circuit DC	Yellow LED, protection against polarity reversal, freewheeling diode						
Input circuit AC/DC	Yellow LED, bridge rectifier						
Output data							
Contact material	AgNi						
Max. switching voltage	250 V AC/DC						
Min. switching voltage	12 V AC/DC						
Limiting continuous current	10 A						
Max. inrush current	30 A (300 ms)						
Min. switching current	100 mA						
General data							
Test voltage input/output	4 kV AC (50 Hz, 1 min.)						
Ambient temperature (operation)	-40 °C ... 60 °C*)						
Mechanical service life	3 x 10 <sup>7</sup> cycles						
Standards/regulations	IEC 60664, EN 50178, IEC 62103						
Connection data solid / stranded / AWG	0.14 - 2.5 mm <sup>2</sup> / 0.14 - 2.5 mm <sup>2</sup> / 26 - 14						
Dimensions	W / H / D						14 mm / 80 mm / 94 mm
EMC note	Class A product, see page 625						

**Ordering data**

Description	Input voltage $U_N$	Type	Order No.	Pcs. / Pkt.
<b>PLC-INTERFACE, with screw connection</b>				
①	12 V DC	PLC-RSC- 12DC/21HC	2967617	10
②	24 V DC	PLC-RSC- 24DC/21HC	2967620	10
③	24 V AC/DC	PLC-RSC- 24UC/21HC	2967633	10
④	48 V DC	PLC-RSC- 48DC/21HC	2967646	10
⑤	60 V DC	PLC-RSC- 60DC/21HC	2967659	10
⑥	120 V AC (110 V DC)	PLC-RSC-120UC/21HC	2967662	10
⑦	230 V AC (220 V DC)	PLC-RSC-230UC/21HC	2967675	10
<b>PLC-INTERFACE, with push-in connection</b>				
①	12 V DC	PLC-RPT- 12DC/21HC	2900290	10
②	24 V DC	PLC-RPT- 24DC/21HC	2900291	10
③	24 V AC/DC	PLC-RPT- 24UC/21HC	2900293	10
④	48 V DC	PLC-RPT- 48DC/21HC	2900294	10
⑤	60 V DC	PLC-RPT- 60DC/21HC	2900295	10
⑥	120 V AC (110 V DC)	PLC-RPT-120UC/21HC	2900296	10
⑦	230 V AC (220 V DC)	PLC-RPT-230UC/21HC	2900297	10

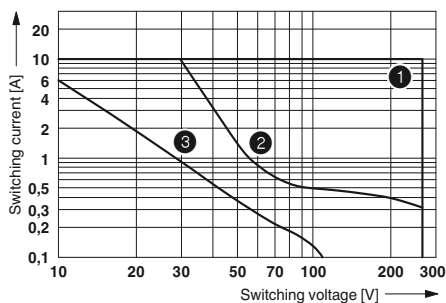

- ① AC, ohmic load
- ② DC, ohmic load
- ③ DC, L/R = 40 ms

Max. interrupting rating

# Relay modules

## Highly compact relay modules - PLC-INTERFACE

### PLC-INTERFACE for hazardous areas

Relay modules with ATEX and/or Class 1, Division 2 approval for potentially explosive applications.

The advantages:

- Slim design
- Functional jumpers
- Integrated input and interference suppression circuit
- RTIII-sealed relays
- Safe isolation according to DIN EN 50178 between coil and contact
- Efficient connection to system cabling using V8 adapter

<b>Notes:</b>
Type of housing: Polyamide PA non-reinforced, color: green.
Marking systems and mounting material See Catalog 5
Separating plate PLC-ATP must be installed for voltages larger than 250 V (L1, L2, L3) between identical terminal blocks in adjacent modules. Potential bridging is then carried out with FBST 8-PLC... or FBST 500....



2 PDT with power contact



1 PDT with power contact

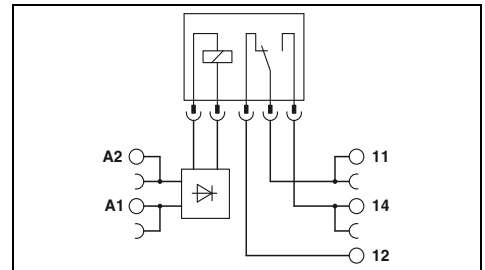
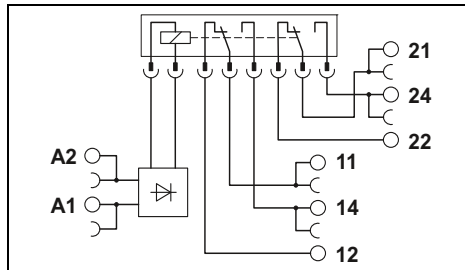

#### Technical data

<b>Input data</b>	
Permissible range (with reference to $U_N$ )	
Switching level (with reference to $U_N$ )	1 signal ("H") 0 signal ("L")
Typ. input current at $U_N$	[mA] 18
Typ. response time/switch-on time at $U_N$	[ms] 8
Typ. release time/shutdown time at $U_N$	[ms] 10
Transmission frequency $f_{emit}$	[Hz]
Input circuit DC	Yellow LED, protection against polarity reversal, surge protection
<b>Input circuit AC/DC</b>	
<b>Output data</b>	
Contact material	AgNi
Max. switching voltage	250 V AC/DC
Min. switching voltage	5 V AC/DC (at 10 mA)
Limiting continuous current	6 A
Max. inrush current	15 A (300 ms)
Min. switching current	10 mA (at 5 V)
Output protection	-
Voltage drop at max. limiting continuous current	-
<b>General data</b>	
Test voltage input/output	4 kV (50 Hz, 1 min.)
Ambient temperature (operation)	-20 °C ... 60 °C (UL)
Mechanical service life	$3 \times 10^7$ cycles
Standards/regulations	IEC 60664, EN 50178, IEC 62103, EN 60079-0, EN 60079-15
Pollution degree / surge voltage category	2 / III
Connection data solid / stranded / AWG	0.14 - 2.5 mm <sup>2</sup> / 0.14 - 2.5 mm <sup>2</sup> / 26 - 14
Dimensions	W / H / D 14 mm / 80 mm / 94 mm
EMC note	
<b>Conformance / approvals</b>	
Conformance	CE-compliant
ATEX	DEMKO 03 ATEX 0326050U; II 3G Ex nA nC IIC Gc
UL, USA	Class I, Zone 2, AEx nA nC IIC T6
UL, USA / Canada	Class I, Div. 2, Groups A, B, C, D
UL, Canada	Class I, Zone 2, Ex nA nC IIC Gc T6 X

<b>Technical data</b>	
Permissible range (with reference to $U_N$ )	② ③
Switching level (with reference to $U_N$ )	See diagram
Typ. input current at $U_N$	[mA] 9 3.5
Typ. response time/switch-on time at $U_N$	[ms] 5 6
Typ. release time/shutdown time at $U_N$	[ms] 8 15
Transmission frequency $f_{emit}$	[Hz]
Input circuit DC	Yellow LED, protection against polarity reversal, freewheeling diode
<b>Input circuit AC/DC</b>	
<b>Output data</b>	
Contact material	AgSnO
Max. switching voltage	250 V AC/DC
Min. switching voltage	5 V (at 100 mA)
Limiting continuous current	6 A
Max. inrush current	on request
Min. switching current	10 mA (at 12 V)
Output protection	-
Voltage drop at max. limiting continuous current	-
<b>General data</b>	
Test voltage input/output	4 kV AC (50 Hz, 1 min.)
Ambient temperature (operation)	-20 °C ... 60 °C
Mechanical service life	$2 \times 10^7$ cycles
Standards/regulations	IEC 60664, EN 50178, IEC 62103, EN 60079-0, EN 60079-15
Pollution degree / surge voltage category	3 / III
Connection data solid / stranded / AWG	0.14 - 2.5 mm <sup>2</sup> / 0.14 - 2.5 mm <sup>2</sup> / 26 - 14
Dimensions	W / H / D 6.2 mm / 80 mm / 94 mm
EMC note	
<b>Conformance / approvals</b>	
Conformance	CE-compliant
ATEX	DEMKO 11 ATEX 1111531U; II 3G Ex nC IIC Gc
UL, USA	Class I, Zone 2, AEx nA nC IIC T6
UL, USA / Canada	Class I, Div. 2, Groups A, B, C, D
UL, Canada	Class I, Zone 2, Ex nA nC IIC Gc T6 X

#### Ordering data

Description	Input voltage $U_N$
<b>PLC-INTERFACE, with screw connection</b>	
①	12 V DC
②	24 V DC
③	120 V AC (110 V DC)
④	230 V AC
<b>PLC-INTERFACE, with spring-cage connection</b>	
①	12 V DC
③	120 V AC (110 V DC)

Type	Order No.	Pcs. / Pkt.
PLC-RSC- 24DC/21-21ATEX	2980461	10

#### Ordering data

Description	Input voltage $U_N$
<b>PLC-INTERFACE, with screw connection</b>	
①	12 V DC
②	24 V DC
③	120 V AC (110 V DC)
④	230 V AC
<b>PLC-INTERFACE, with spring-cage connection</b>	
①	12 V DC
③	120 V AC (110 V DC)

Type	Order No.	Pcs. / Pkt.
PLC-RSC- 24DC/21 ATEX	2902955	1
PLC-RSC-120UC/21 ATEX	2902956	1

Highly compact relay modules - PLC-INTERFACE



new

1 PDT with power contact



new

Max. DC voltage output of 3 A

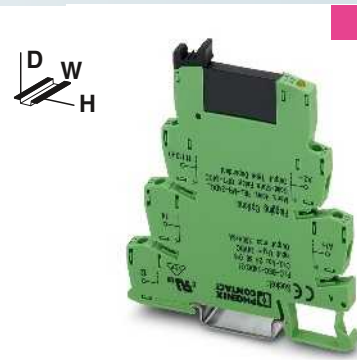

new

Max. DC voltage output of 100 mA

Ex:

Ex:

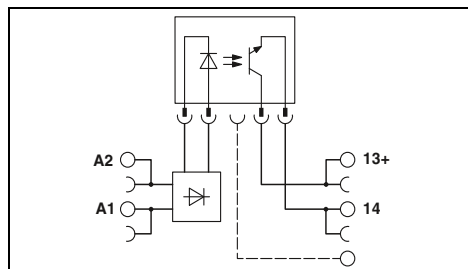
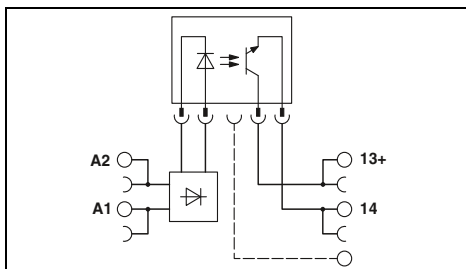
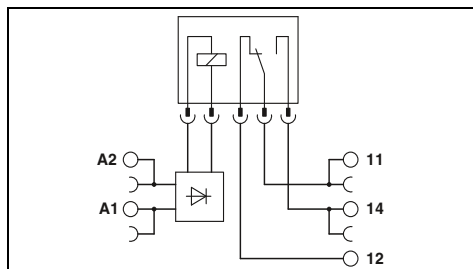

Technical data			
①	②	③	④
See diagram			
15.3	9	3.5	3.2
5	5	6	7
8	8	15	15
Yellow LED, protection against polarity reversal, protection against polarity reversal			
Yellow LED, bridge rectifier			
AgSnO			
250 V AC/DC			
12 V AC/DC			
6 A			
-			
10 mA			
-			
-			
4 kV AC (50 Hz, 1 min.)			
-25 °C ... 60 °C			
2 x 10 <sup>7</sup> cycles			
IEC 60664, EN 50178, IEC 62103, EN 60079-0, EN 60079-15			
3 / III			
0.14 - 2.5 mm <sup>2</sup> / 0.14 - 2.5 mm <sup>2</sup> / 26 - 14			
6.2 mm / 80 mm / 94 mm			
Class A product, see page 625			
CE-compliant			
-			
Class I, Zone 2, AEx nA nC IIC T6			
Class I, Div. 2, Groups A, B, C, D			
Class I, Zone 2, Ex nA nC IIC Gc T6 X			

Technical data	
②	③
0.8 - 1.2	0.9 - 1.1
≥ 0.8	≥ 0.8
≤ 0.4	≤ 0.3
8.5	3.5
0.02	3.5
0.3	7
300	10
Yellow LED, protection against polarity reversal, freewheeling diode	
Yellow LED, bridge rectifier	
-	
33 V DC	
3 V DC	
3 A	
15 A (10 ms)	
-	
Protection against polarity reversal, surge protection	
≤ 200 mV	
2.5 kV (50 Hz, 1 min.)	
-20 °C ... 60 °C	
-	
IEC 60664, EN 50178, IEC 62103	
2 / III	
0.14 - 2.5 mm <sup>2</sup> / 0.14 - 2.5 mm <sup>2</sup> / 26 - 14	
6.2 mm / 80 mm / 94 mm	
Class A product, see page 625	
CE-compliant	
-	
Class I, Zone 2, AEx nA nC IIC T6	
Class I, Div. 2, Groups A, B, C, D	
Class I, Zone 2, Ex nA nC IIC Gc T6 X	

Technical data	
②	③
0.8 - 1.2	0.9 - 1.1
≥ 0.8	≥ 0.9
≤ 0.4	≤ 0.3
8.5	3.5
0.02	3
0.3	4
300	10
Yellow LED, protection against polarity reversal, freewheeling diode	
Yellow LED, bridge rectifier	
-	
48 V DC	
3 V DC	
100 mA	
-	
-	
Protection against polarity reversal, surge protection	
≤ 1 V	
2.5 kV (50 Hz, 1 min.)	
-25 °C ... 60 °C	
-	
IEC 60664, EN 50178, IEC 62103	
2 / III	
0.14 - 2.5 mm <sup>2</sup> / 0.14 - 2.5 mm <sup>2</sup> / 26 - 14	
6.2 mm / 80 mm / 94 mm	
Class A product, see page 625	
CE-compliant	
-	
Class I, Zone 2, AEx nA nC IIC T6	
Class I, Div. 2, Groups A, B, C, D	
Class I, Zone 2, Ex nA nC IIC Gc T6 X	

Ordering data		
Type	Order No.	Pcs. / Pkt.
PLC-RSC-12DC/21-C1D2	5606331	1
PLC-RSC-24DC/21 C1D2	5603154	1
PLC-RSC-120UC/21 C1D2	5603157	1
PLC-RSC-230UC/21-CID2	5607072	1
PLC-RSP-12DC/21 CID2	5606332	1
PLC-RSP-120UC/21 C1D2	5603683	1

Ordering data		
Type	Order No.	Pcs. / Pkt.
PLC-OSC- 24DC/ 24DC/ 2 C1D2	5603260	1
PLC-OSC-120UC/ 24DC/ 2 C1D2	5603262	1

Ordering data		
Type	Order No.	Pcs. / Pkt.
PLC-OSC- 24DC/ 48DC/100 C1D2	5603261	1
PLC-OSC-120UC/ 48DC/100 C1D2	5603263	1

# Relay modules

## Highly compact relay modules - PLC-INTERFACE

### Basic terminal blocks with interference current filter that can be fitted with relays

PLC basic terminal blocks with integrated filter to protect against interference voltages or currents due, for example, to long control lines

The advantages:

- Resistant to interference currents
- High relay release voltage

Typical applications:

- Applications with long control lines
- Use of AC output boards, resulting in residual AC currents
- Screw and push-in connection technology

Notes:
Type of housing: Polyamide PA non-reinforced, color: green.
Marking systems and mounting material See Catalog 5
Separating plate PLC-ATP must be installed for voltages larger than 250 V (L1, L2, L3) between identical terminal blocks in adjacent modules. Potential bridging is then carried out with FBST 8-PLC... or FBST 500....
For diagrams of operating voltage ranges, see page 423
Maximum interrupting rating diagrams, see page 426



Universal design

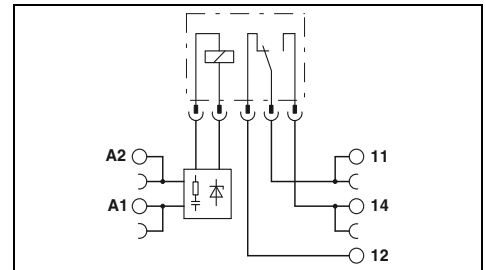

### Technical data

Input data	120 V AC	230 V AC
Nominal input voltage $U_N$	120 V AC	230 V AC
Permissible range (with reference to $U_N$ )	0.8 ... 1.4	0.78 ... 1.14
Typ. release voltage (with relay)	50 V AC	80 V AC
Typ. input current with $U_N$ (50 / 60 Hz)	7 mA / 8 mA	8.8 mA / 10 mA
Typ. response time at $U_N$	7 ms	7 ms
Typ. release time at $U_N$	20 ms	20 ms
Input circuit	Yellow LED, bridge rectifier, filter	
Output data with:	REL-MR-60DC/21	REL-MR-60DC/21AU
Contact type	Single contact, 1-PDT	Single contact, 1-PDT
Contact material	AgSnO	AgSnO, hard gold-plated
Max. switching voltage	250 V AC/DC	30 V AC / 36 V DC
Min. switching voltage	5 V (at 100 mA)	100 mV (at 10 mA)
Limiting continuous current	6 A	50 mA
Max. inrush current	on request	50 mA
Min. switching current	10 mA (at 12 V)	1 mA (at 24 V)
General data		
Test voltage input/output	4 kV (50 Hz, 1 min.)	
Ambient temperature (operation)	-20 °C ... 55 °C	
Mechanical service life	2 x 10 <sup>7</sup> cycles	
Standards/regulations	IEC 60664, EN 50178, IEC 62103	
Pollution degree / Surge voltage category	3 / III	
Connection data solid / stranded / AWG	0.14 - 2.5 mm <sup>2</sup> / 0.14 - 2.5 mm <sup>2</sup> / 26 - 14	
Dimensions	W / H / D 6.2 mm / 80 mm / 94 mm	
EMC note	Class A product, see page 625	

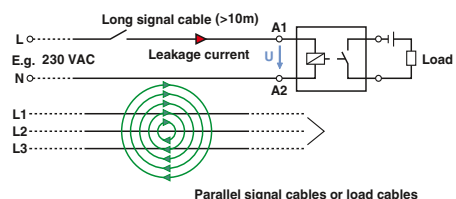
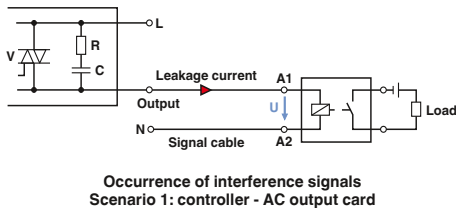

Description	Voltage $U_N$
<b>PLC-INTERFACE basic terminal block</b> , for plug-in miniature relays or solid-state relays	
With screw connection	120 V AC
With screw connection	230 V AC
With push-in connection	120 V AC
With push-in connection	230 V AC

Plug-in miniature relay
with gold contact
with power contact

### Ordering data

Type	Order No.	Pcs. / Pkt.
PLC-BSC-120UC/21/SO46	2980319	10
PLC-BSC-230UC/21/SO46	2980335	10
PLC-BPT-120UC/21/SO46	2900453	10
PLC-BPT-230UC/21/SO46	2900455	10

### Accessories

REL-MR- 60DC/21AU	2961134	10
REL-MR- 60DC/21	2961118	10



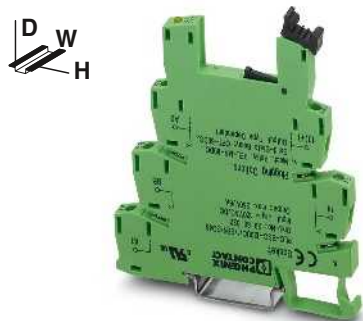

Sensor design

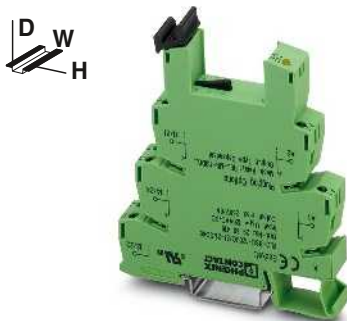

2 PDT universal design

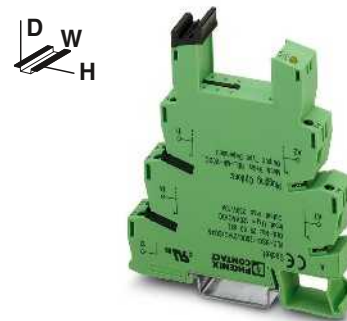

1 PDT for high continuous currents

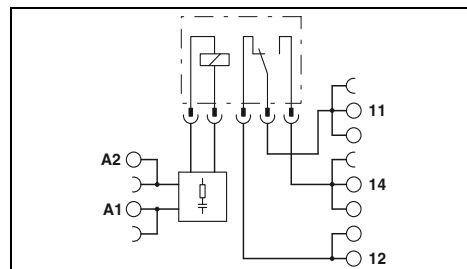
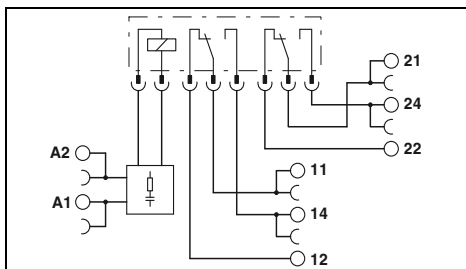
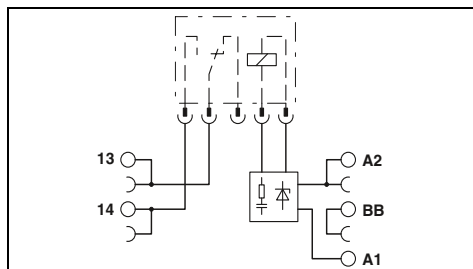

Technical data

Technical data

Technical data

120 V AC	230 V AC
0.8 ... 1.4	0.78 ... 1.14
50 V AC	80 V AC
7 mA / 8 mA	8.8 mA / 10 mA
7 ms	7 ms
20 ms	20 ms
Yellow LED, bridge rectifier, filter	
REL-MR-60DC/21	REL-MR-60DC/21AU
Single contact, 1 N/O contact	Single contact, 1 N/O contact
AgSnO	AgSnO, hard gold-plated
250 V AC/DC	30 V AC / 36 V DC
5 V (at 100 mA)	100 mV (at 10 mA)
6 A	50 mA
on request	50 mA
10 mA (at 12 V)	1 mA (at 24 V)

120 V AC	230 V AC
0.78 ... 1.4	0.78 ... 1.14
16 V AC	70 V AC
6 mA / 7 mA	8.5 mA / 10 mA
7 ms	7 ms
10 ms	10 ms
Yellow LED, bridge rectifier, filter	
REL-MR-110DC/21-21	REL-MR-110DC/21-21AU
Single contact, 2-PDT	Single contact, 2-PDT
AgNi	AgNi, + 5 µm Au
250 V AC/DC	30 V AC / 36 V DC
5 V AC/DC	100 mV
6 A	50 mA
15 A (300 ms)	50 mA
10 mA	1 mA

120 V AC	230 V AC
0.85 ... 1.4	0.78 ... 1.14
16 V AC	70 V AC
6 mA / 7 mA	8.5 mA / 10 mA
7 ms	7 ms
20 ms	20 ms
Yellow LED, bridge rectifier, filter	
REL-MR-110DC/21HC	
Single contact, 1-PDT	
AgNi	
250 V AC/DC	
12 V AC/DC	
10 A	
30 A (300 ms)	
100 mA	

4 kV (50 Hz, 1 min.)  
 -20 °C ... 55 °C  
 2 x 10<sup>7</sup> cycles  
 IEC 60664, EN 50178, IEC 62103  
 3 / III

4 kV (50 Hz, 1 min.)  
 -20 °C ... 55 °C  
 3 x 10<sup>7</sup> cycles  
 IEC 60664, EN 50178, IEC 62103  
 3 / III

4 kV (50 Hz, 1 min.)  
 -20 °C ... 55 °C  
 3 x 10<sup>7</sup> cycles  
 IEC 60664, EN 50178, IEC 62103  
 3 / III

0.14 - 2.5 mm<sup>2</sup> / 0.14 - 2.5 mm<sup>2</sup> / 26 - 14  
 6.2 mm / 80 mm / 94 mm  
 Class A product, see page 625

0.14 - 2.5 mm<sup>2</sup> / 0.14 - 2.5 mm<sup>2</sup> / 26 - 14  
 14 mm / 80 mm / 94 mm  
 Class A product, see page 625

0.14 - 2.5 mm<sup>2</sup> / 0.14 - 2.5 mm<sup>2</sup> / 26 - 14  
 14 mm / 80 mm / 94 mm  
 Class A product, see page 625

Ordering data

Ordering data

Ordering data

Type	Order No.	Pcs. / Pkt.
PLC-BSC-120UC/ 1/SEN/SO46	2980322	10
PLC-BSC-230UC/ 1/SEN/SO46	2980348	10
PLC-BPT-120UC/ 1/SEN/SO46	2900456	10
PLC-BPT-230UC/ 1/SEN/SO46	2900457	10

Type	Order No.	Pcs. / Pkt.
PLC-BSC-120UC/21-21/SO46	2980416	10
PLC-BSC-230UC/21-21/SO46	2980429	10

Type	Order No.	Pcs. / Pkt.
PLC-BSC-120UC/21HC/SO46	2980432	10
PLC-BSC-230UC/21HC/SO46	2980445	10

Accessories

Accessories

Accessories

REL-MR- 60DC/21AU	2961134	10
REL-MR- 60DC/21	2961118	10

REL-MR-110DC/21-21AU	2961228	10
REL-MR-110DC/21-21	2961202	10

REL-MR-110DC/21HC	2961338	10
-------------------	---------	----

# Relay modules

## Highly compact relay modules - PLC-INTERFACE

### Basic terminal blocks with interference current filter that can be fitted with solid-state relays

PLC basic terminal blocks with integrated filter to protect against interference voltages or currents due, for example, to long control lines

The advantages:

- Resistant to interference currents
- High relay release voltage

Typical applications:

- Applications with long control lines
- Use of AC output boards, resulting in residual AC currents
- Screw and push-in connection technology

Notes:
Type of housing: Polyamide PA non-reinforced, color: green.
Marking systems and mounting material See Catalog 5
Separating plate PLC-ATP must be installed for voltages larger than 250 V (L1, L2, L3) between identical terminal blocks in adjacent modules. Potential bridging is then carried out with FBST 8-PLC... or FBST 500....
For derating curves see page 425



Universal design

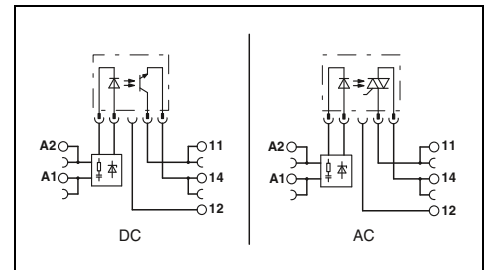

Input data
Nominal input voltage $U_N$
Permissible range (with reference to $U_N$ )
Switching level (with optocoupler) 0 signal ("L")
Typ. input current with $U_N$ (50 / 60 Hz)
Typ. response time/switch-on time at $U_N$
Typ. shutdown time at $U_N$
Input circuit
Output data with:
Max. switching voltage
Min. switching voltage
Limiting continuous current
Max. inrush current
Output protection
Voltage drop at limiting continuous current
Leakage current in off state
Max. phase shift (inductive load)
Max. load value $I^2 \times t$ ( $t = 10$ ms)
General data
Test voltage input/output
Ambient temperature (operation)
Standards/regulations
Pollution degree / Surge voltage category
Connection data solid / stranded / AWG
Dimensions
EMC note

Technical data		
120 V AC	230 V AC	
0.85 ... 1.1	0.8 ... 1.1	
$\leq 0.4$	$\leq 0.4$	
7 mA / 8 mA	8.8 mA / 10 mA	
6 ms	6 ms	
10 ms	10 ms	
Yellow LED, bridge rectifier, filter		
OPT...48DC/...	OPT...24DC/...	OPT...230AC/...
48 V DC	30 V DC	253 V AC
3 V DC	3 V DC	24 V AC
100 mA	3 A	0.75 A
	15 A (10 ms)	30 A (10 ms)
Protection against polarity reversal, surge protection	Protection against polarity reversal, surge protection	RCV circuit
< 1 V DC	< 200 mV	< 1 V AC
-	-	< 1 mA
-	-	0.5
-	-	4.5 A <sup>2</sup> s
2.5 kV (50 Hz, 1 min.)		
-20 °C ... 55 °C		
IEC 60664, EN 50178, IEC 62103		
2 / III		
0.14 - 2.5 mm <sup>2</sup> / 0.14 - 2.5 mm <sup>2</sup> / 26 - 14		
6.2 mm / 80 mm / 94 mm		
Class A product, see page 625		

Description	Voltage $U_N$
<b>PLC-INTERFACE basic terminal block</b> , for plug-in miniature relays or solid-state relays	
With screw connection	120 V AC
With screw connection	230 V AC
With push-in connection	120 V AC
With push-in connection	230 V AC

Ordering data			
Type	Order No.	Pcs. / Pkt.	
PLC-BSC-120UC/21/SO46	2980319	10	
PLC-BSC-230UC/21/SO46	2980335	10	
PLC-BPT-120UC/21/SO46	2900453	10	
PLC-BPT-230UC/21/SO46	2900455	10	

Plug-in solid-state relay	
Solid-state input relay	
Solid-state power relay	
Solid-state power relay	

Accessories		
	Order No.	Pcs. / Pkt.
OPT-60DC/ 48DC/100	2966621	10
OPT-60DC/ 24DC/ 2	2966605	10
OPT-60DC/230AC/ 1	2967963	10



Sensor design

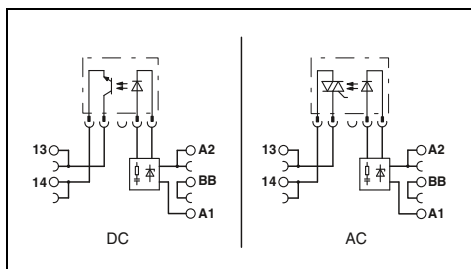

Technical data

120 V AC	230 V AC
0.85 ... 1.1	0.8 ... 1.1
≤ 0.4	≤ 0.4
7 mA / 8 mA	8.8 mA / 10 mA
6 ms	6 ms
10 ms	10 ms
Yellow LED, bridge rectifier, filter	
OPT...48DC/...	OPT...24DC/... OPT...230AC/...
48 V DC	30 V DC 253 V AC
3 V DC	3 V DC 24 V AC
100 mA	3 A 0.75 A
	15 A (10 ms) 30 A (10 ms)
Protection against polarity reversal, surge protection	Protection against polarity reversal, surge protection RCV circuit
< 1 V	< 200 mV < 1 V
-	- < 1 mA
-	- 0.5
-	- 4.5 A²s

2.5 kV (50 Hz, 1 min.)  
 -20 °C ... 55 °C  
 IEC 60664, EN 50178, IEC 62103  
 2 / III

0.14 - 2.5 mm² / 0.14 - 2.5 mm² / 26 - 14  
 6.2 mm / 80 mm / 94 mm  
 Class A product, see page 625

Ordering data

Type	Order No.	Pcs. / Pkt.
PLC-BSC-120UC/ 1/SEN/SO46	2980322	10
PLC-BSC-230UC/ 1/SEN/SO46	2980348	10
PLC-BPT-120UC/ 1/SEN/SO46	2900456	10
PLC-BPT-230UC/ 1/SEN/SO46	2900457	10

Accessories

OPT-60DC/ 48DC/100	2966621	10
OPT-60DC/ 24DC/ 2	2966605	10
OPT-60DC/230AC/ 1	2967963	10

# Relay modules

## Highly compact relay modules - PLC-INTERFACE

### Plug-in miniature power relays

Plug-in miniature power relays suitable for PLC-INTERFACE and RIF-0, RIF-1, and PR1 relay bases.

The advantages:

- Power contacts up to 16 A
- Multi-layer gold contact or power contact
- High degree of protection up to RT III (comparable with IP67) depending on type
- Safe isolation according to DIN EN 50178 between coil and contact

Notes:
If the specified maximum values for multi-layer contact relays are exceeded, the gold plating is destroyed. The maximum values of the power contact relay are then valid. This can result in a shorter service life than with a pure power contact.
For dimensional drawings and perforations for assembly, see page 424
For diagrams of operating voltage ranges, see page 423



1 PDT

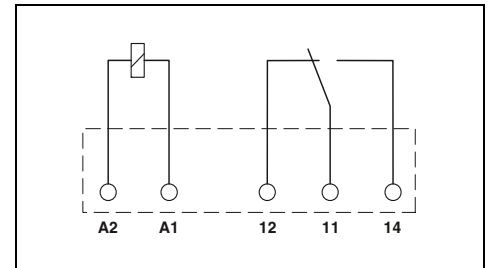

Input data	
Permissible range (with reference to $U_N$ )	
Typ. input current at $U_N$	[mA]
Typ. response time at $U_N$	[ms]
Typ. release time at $U_N$	[ms]
Output data	
Contact type	
Contact material	
Max. switching voltage	
Min. switching voltage	
Limiting continuous current	
Max. inrush current	
Min. switching current	
Max. interrupting rating, ohmic load	
	24 V DC
	48 V DC
	60 V DC
	110 V DC
	220 V DC
	250 V AC
General data	
Test voltage (winding/contact)	
Ambient temperature (operation)	
Nominal operating mode	
Mechanical service life	
Standards/regulations	
Mounting position / mounting	
Dimensions	W / H / D

Technical data				
①	②	③	④	⑤
see diagram				
38	14	9	7	3
5	5	5	5	5
2.5	2.5	2.5	2.5	2.5
1 PDT		1 PDT		
AgSnO		AgSnO, hard gold-plated		
250 V AC/DC		30 V AC / 36 V DC		
5 V (at 100 mA)		100 mV (at 10 mA)		
6 A		50 mA		
on request		on request		
10 mA (at 12 V)		1 mA (at 24 V)		
	140 W			1.2 W
	20 W			-
	18 W			-
	23 W			-
	40 W			-
	1500 VA			-
4 kV AC (50 Hz, 1 min.)				
-40 °C ... 85 °C				
100% operating factor				
2 x 10 <sup>7</sup> cycles				
IEC 60664, EN 50178, IEC 62103				
any / can be aligned without spacing				
5 mm / 28 mm / 15 mm				
Ordering data				
Type	Order No.	Pcs. / Pkt.		
REL-MR- 4,5DC/21	2961367	10		
REL-MR- 12DC/21	2961150	10		
REL-MR- 18DC/21	2961383	10		
REL-MR- 24DC/21	2961105	10		
REL-MR- 60DC/21	2961118	10		
REL-MR 4,5DC/21AU	2961370	10		
REL-MR- 12DC/21AU	2961163	10		
REL-MR- 18DC/21AU	2961493	10		
REL-MR- 24DC/21AU	2961121	10		
REL-MR- 60DC/21AU	2961134	10		

Description	Input voltage $U_N$
<b>Plug-in miniature power relay</b>	
with power contact	① 4.5 V DC
with power contacts	② 12 V DC
with power contact	③ 18 V DC
with power contacts	④ 24 V DC
with power contact	⑤ 60 V DC
with power contact	⑥ 110 V DC
<b>Plug-in miniature power relay</b>	
with gold contact	① 4.5 V DC
with multi-layer gold contacts	② 12 V DC
with gold contact	③ 18 V DC
with multi-layer gold contacts	④ 24 V DC
with gold contact	⑤ 60 V DC
with gold contact	⑥ 110 V DC



2 PDT



1 N/O contact,  
for high inrush currents



1 PDT  
for high continuous currents

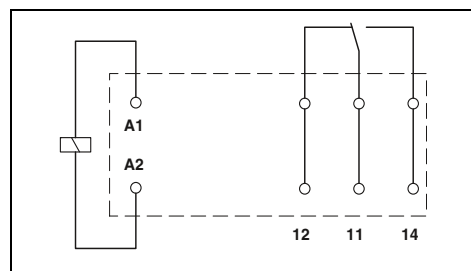
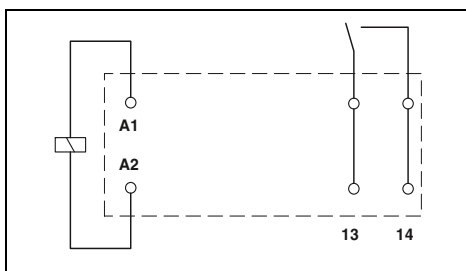
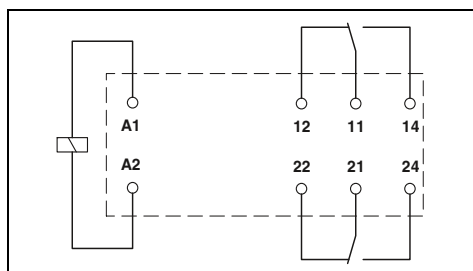

Technical data			
②	④	⑤	⑥

see diagram			
33	17	8.2	4.1
7	7	7	7
3	3	3	3

2 PDT	2 PDT
AgNi	AgNi, hard gold-plated

250 V AC/DC	30 V AC / 36 V DC
5 V (at 10 mA)	100 mV (at 10 mA)
8 A	50 mA
25 A (20 ms)	50 mA
10 mA (at 5 V)	1 mA (at 24 V)

190 W	1.2 W
85 W	-
60 W	-
44 W	-
60 W	-
2000 VA	-

5 kV AC (50 Hz, 1 min.)  
 -40 °C ... 85 °C  
 100% operating factor  
 3 x 10<sup>7</sup> cycles  
 IEC 60664, EN 50178, IEC 62103  
 any / can be aligned without spacing (> 70 °C ≥ 2.5 mm)

12.7 mm / 29 mm / 15.7 mm

Technical data
④

see diagram
17
8
3

1 N/O contact
AgSnO

250 V AC/DC
12 V (at 100 mA)
16 A
80 A (20 ms)
100 mA (at 12 V DC)

384 W
58 W
48 W
50 W
80 W
4000 VA

5 kV AC (50 Hz, 1 min.)  
 -40 °C ... 85 °C  
 100% operating factor  
 3 x 10<sup>7</sup> cycles  
 IEC 60664, EN 50178, IEC 62103  
 any / can be aligned without spacing (> 70 °C ≥ 2.5 mm)

12.7 mm / 29 mm / 15.7 mm

Technical data			
②	④	⑤	⑥

see diagram			
33	17	8.2	4.1
7	7	7	7
3	3	3	3

1 PDT
AgNi

250 V AC/DC
12 V (at 10 mA)
16 A
50 A (20 ms)
10 mA (at 12 V)

384 W
58 W
48 W
50 W
80 W
4000 VA

5 kV AC (50 Hz, 1 min.)  
 -40 °C ... 85 °C  
 100% operating factor  
 3 x 10<sup>7</sup> cycles  
 IEC 60664, EN 50178, IEC 62103  
 any / can be aligned without spacing (> 70 °C ≥ 2.5 mm)

12.7 mm / 29 mm / 15.7 mm

Ordering data

Type	Order No.	Pcs. / Pkt.
REL-MR- 12DC/21-21	2961257	10
REL-MR- 24DC/21-21	2961192	10
REL-MR- 60DC/21-21	2961273	10
REL-MR-110DC/21-21	2961202	10
REL-MR- 12DC/21-21AU	2961299	10
REL-MR- 24DC/21-21AU	2961215	10
REL-MR- 60DC/21-21AU	2961286	10
REL-MR-110DC/21-21AU	2961228	10

Ordering data

Type	Order No.	Pcs. / Pkt.
REL-MR- 24DC/11C	2961341	10

Ordering data

Type	Order No.	Pcs. / Pkt.
REL-MR- 12DC/21HC	2961309	10
REL-MR- 24DC/21HC	2961312	10
REL-MR- 60DC/21HC	2961325	10
REL-MR-110DC/21HC	2961338	10

# Relay modules

## Highly compact relay modules - PLC-INTERFACE

### Plug-in solid-state relays

Plug-in solid-state relays suitable for PLC-INTERFACE and RIF-0, RIF-1, and PR1 relay bases.

The advantages:

- Switching capacity of up to 24 V DC/5 A
- RT III wash tight (comparable to IP67)
- Vibration and shock-resistant
- Wear-free and long-lasting
- Zero voltage switch at AC output
- Can be soldered in on PCB



Max. DC voltage output of 3 A



Max. DC voltage output of 100 mA

**Notes:**  
For dimensional drawings and perforations for assembly, see page 425

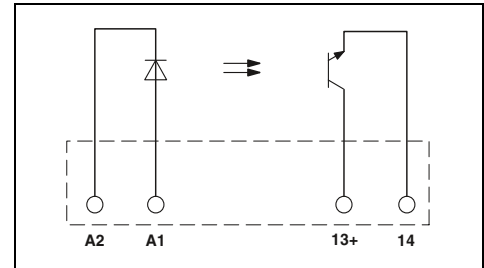
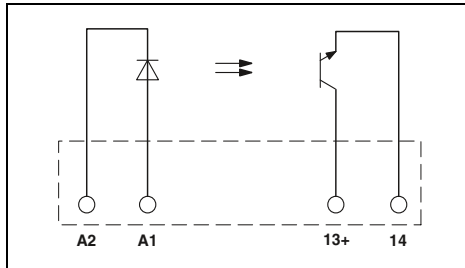

Input data	
Permissible range (with reference to $U_N$ )	0.8 - 0.8 - 0.8 - 1.2 1.2 1.2
Switching level	1 signal ("H") [V DC] $\geq$ 2.5 16 35 0 signal ("L") [V DC] $\leq$ 0.8 10 20
Typ. input current at $U_N$	[mA] 9 7 3
Typ. switch-on time at $U_N$	[ $\mu$ s] 20 20 40
Typ. shutdown time at $U_N$	[ $\mu$ s] 300 300 500
Transmission frequency $f_{emit}$	[Hz] 300 300 300
Output data	
Max. switching voltage	33 V DC
Min. switching voltage	3 V DC
Limiting continuous current	3 A (see derating curve)
Min. load current	-
Max. inrush current	15 A (10 ms)
Leakage current in off state	-
Phase angle (cos $\phi$ )	-
Output circuit	2-wire, floating
Max. load value	-
Output protection	Protection against polarity reversal, surge protection
Voltage drop at max. limiting continuous current	$\leq$ 150 mV
General data	
Rated surge voltage	Basic insulation
Test voltage input/output	2.5 kV (50 Hz, 1 min.)
Ambient temperature (operation)	-25 °C ... 60 °C
Nominal operating mode	100% operating factor
Standards/regulations	IEC 60664, EN 50178, IEC 62103
Pollution degree / surge voltage category	2 / III
Mounting position / mounting	any / can be aligned without spacing
Dimensions	W / H / D 5 mm / 28 mm / 15 mm

Technical data		
①	②	③
0.8 -	0.8 -	0.8 -
1.2	1.2	1.2
2.5	16	35
0.8	10	20
9	7	3
20	20	40
300	300	500
300	300	300
33 V DC		
3 V DC		
3 A (see derating curve)		
-		
15 A (10 ms)		
-		
-		
-		
2-wire, floating		
-		
Protection against polarity reversal, surge protection		
$\leq$ 150 mV		
Basic insulation		
2.5 kV (50 Hz, 1 min.)		
-25 °C ... 60 °C		
100% operating factor		
IEC 60664, EN 50178, IEC 62103		
2 / III		
any / can be aligned without spacing		
5 mm / 28 mm / 15 mm		

Technical data		
①	②	③
0.8 -	0.8 -	0.9 -
1.2	1.2	1.1
2.5	16	52
0.8	10	40
4	7	3
20	20	50
300	300	800
300	300	100
48 V DC		
3 V DC		
100 mA		
-		
-		
-		
-		
2-wire, floating		
-		
Protection against polarity reversal, surge protection		
$\leq$ 1 V		
Basic insulation		
2.5 kV (50 Hz, 1 min.)		
-25 °C ... 60 °C		
100% operating factor		
IEC 60664, EN 50178, IEC 62103		
2 / III		
any / can be aligned without spacing		
5 mm / 28 mm / 15 mm		

Ordering data	
Description	Input voltage $U_N$
<b>Plug-in solid-state relay</b>	
Solid-state power relay	① 5 V DC
Solid-state power relay	② 24 V DC
Solid-state power relay	③ 60 V DC
<b>Plug-in solid-state relay</b>	
Solid-state input relay	① 5 V DC
Solid-state input relay	② 24 V DC
Solid-state input relay	③ 60 V DC

Ordering data		
Type	Order No.	Pcs. / Pkt.
OPT-5DC/ 24DC/ 2	2967989	10
OPT-24DC/ 24DC/ 2	2966595	10
OPT-60DC/ 24DC/ 2	2966605	10

Ordering data		
Type	Order No.	Pcs. / Pkt.
OPT-5DC/ 48DC/100	2967992	10
OPT-24DC/ 48DC/100	2966618	10
OPT-60DC/ 48DC/100	2966621	10



Max. DC voltage output of 5 A



Max. AC voltage output of 750 mA



Max. AC voltage output of 2 A

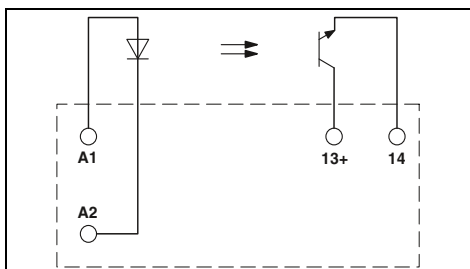

Technical data

①	②	③
0.8 - 1.2	0.8 - 1.2	0.9 - 1.1
2.5	16	35
0.8	10	20
9	7	3
10	20	25
400	400	400
300	300	300

33 V DC  
 3 V DC  
 5 A (see derating curve)  
 -  
 15 A (10 ms)  
 -  
 2-wire, floating  
 -  
 Protection against polarity reversal, surge protection  
 ≤ 200 mV

Basic insulation  
 2.5 kV (50 Hz, 1 min.)  
 -25 °C ... 60 °C  
 100% operating factor  
 IEC 60664, EN 50178, IEC 62103  
 2 / III

any / can be aligned without spacing  
 12.7 mm / 29 mm / 15.7 mm

Ordering data

Type	Order No.	Pcs. / Pkt.
OPT-5DC/24DC/ 5	2982113	10
OPT-24DC/24DC/ 5	2982100	10
OPT-60DC/24DC/ 5	2982126	10

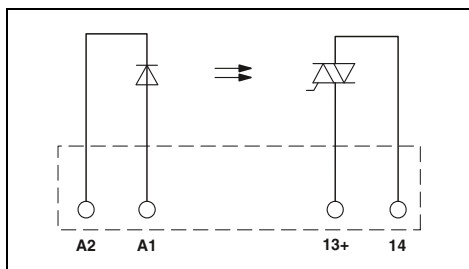

Technical data

②	③
0.8 - 1.2	0.8 - 1.1
10	50
5	15
3	3
6000	9000
500	700
10	10

253 V AC  
 24 V AC  
 0.75 A (see derating curve)  
 10 mA  
 30 A (10 ms)  
 < 1 mA  
 0.5  
 2-wire floating, zero voltage switch  
 4.5 A<sup>2</sup>s  
 RCV circuit  
 < 1 V

Basic insulation  
 2.5 kV (50 Hz, 1 min.)  
 -25 °C ... 60 °C  
 100% operating factor  
 IEC 60664, EN 50178, IEC 62103  
 2 / III

any / can be aligned without spacing  
 5 mm / 28 mm / 15 mm

Ordering data

Type	Order No.	Pcs. / Pkt.
OPT-24DC/230AC/ 1	2967950	10
OPT-60DC/230AC/ 1	2967963	10

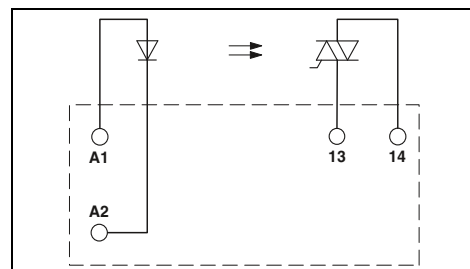

Technical data

①	②	③
0.8 - 1.2	0.8 - 1.2	0.9 - 1.1
3	18	40
1	8.4	20
15	7	2.6
10000	10000	10000
10000	10000	10000
10	10	10

253 V AC  
 24 V AC  
 2 A (see derating curve)  
 25 mA  
 30 A (10 ms)  
 < 1 mA  
 -  
 2-wire floating, zero voltage switch  
 4 A<sup>2</sup>s (tp = 10 ms, at 25 °C)  
 Surge protection  
 ≤ 1 V

Basic insulation  
 2.5 kV (50 Hz, 1 min.)  
 -25 °C ... 60 °C  
 100% operating factor  
 IEC 60664  
 2 / III

any / see derating curve  
 12.7 mm / 29 mm / 15.7 mm

Ordering data

Type	Order No.	Pcs. / Pkt.
OPT-5DC/230AC/ 2	2982168	10
OPT-24DC/230AC/ 2	2982171	10
OPT-60DC/230AC/ 2	2982184	10





**Operating voltage ranges for PLC-INTERFACE, 6.2 mm versions, equipped with relay**

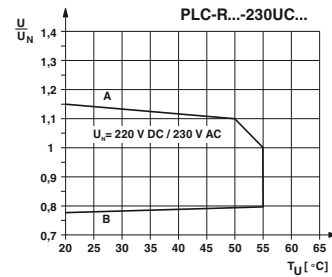
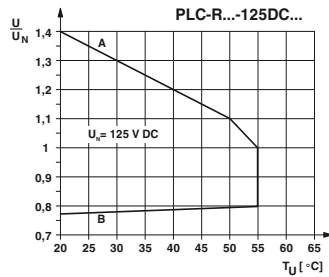
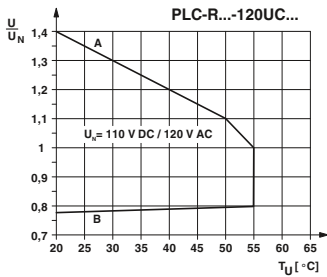
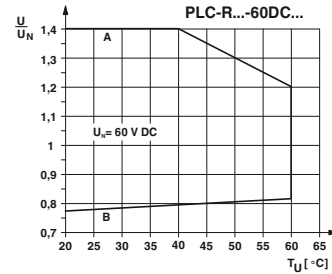
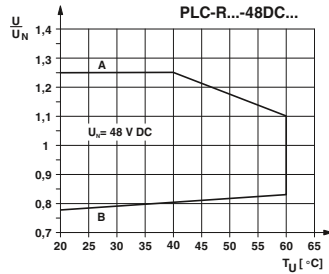
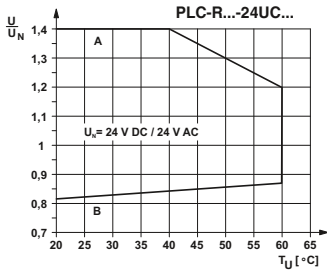
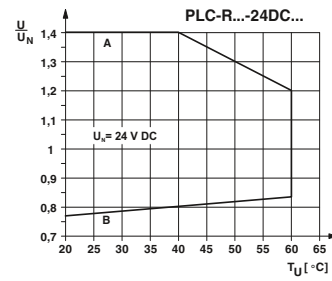
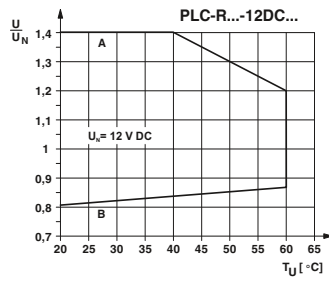

**Operating voltage ranges for PLC-INTERFACE, 14 mm versions, equipped with relay**

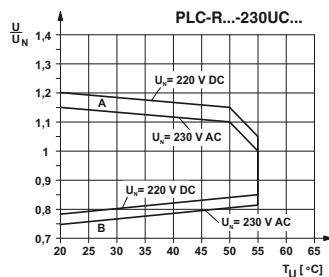
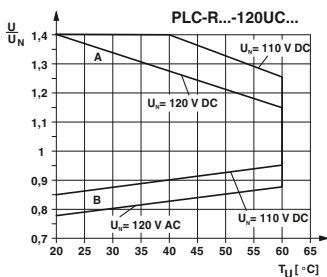
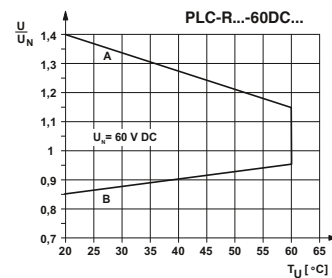
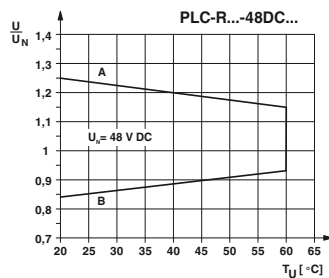
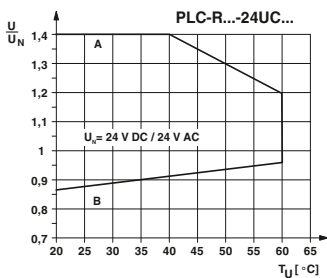
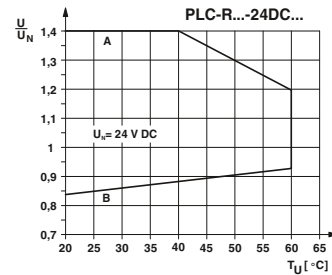
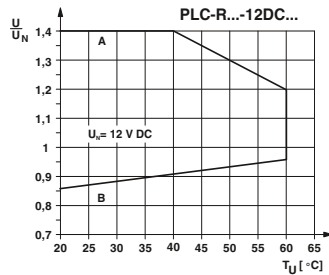

**General conditions:**  
Direct alignment in the block, all devices 100% operating time, horizontal or vertical mounting.

**Curve A**  
Maximum permitted continuous voltage  $U_{max}$ , with limiting continuous current on the contact side (see relevant technical data).

**Curve B**  
Minimum permitted pick-up voltage  $U_{op}$  after pre-excitation<sup>1)</sup> (see relevant technical data).

<sup>1)</sup> **Pre-excitation:** relay has been operated in a thermally steady state at the ambient temperature  $T_A$  with nominal voltage  $U_N$  and limiting continuous current on the contact side (see relevant technical data) (warm coil). After being switched off for a short time, the relay must reliably pick up again at  $U_{op}$ . The  $U_{op}$  values for cold coils ( $T_{coil} = T_A = 20^\circ\text{C}$ ) indicated by other manufacturers yield better values, but are not practical.

# Relay modules

## Tables, diagrams, dimensional drawings

### Plug-in miniature power relays

#### REL-MR...21

Permitted input voltage range  
for REL-MR...21

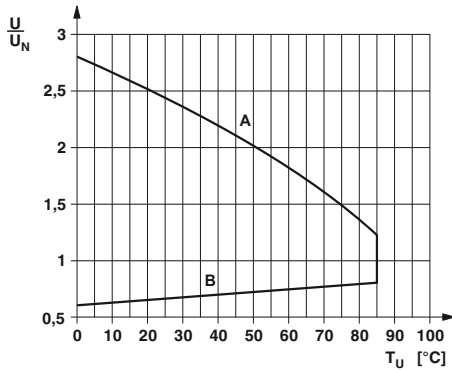

General conditions:

Direct alignment in the block, all devices 100% operating time, horizontal or vertical mounting.

Curve A

Maximum permitted continuous voltage  $U_{max}$  with limiting continuous current on the contact side (see relevant technical data).

Curve B

Minimum permitted pick-up voltage  $U_{op}$  after pre-excitation<sup>1)</sup> (see relevant technical data).

<sup>1)</sup> **Pre-excitation:** relay has been operated in a thermally steady state at the ambient temperature  $T_A$  with nominal voltage  $U_N$  and limiting continuous current on the contact side (see relevant technical data) (warm coil). After being switched off for a short time, the relay must reliably pick up again at  $U_{op}$ . The  $U_{op}$  values for cold coils ( $T_{coil} = T_A = 20^\circ\text{C}$ ) indicated by other manufacturers yield better values, but are not practical.

#### REL-MR...21-21

Permitted input voltage range  
for REL-MR...21-21, REL-MR-24DC/11C, REL-MR...21HC

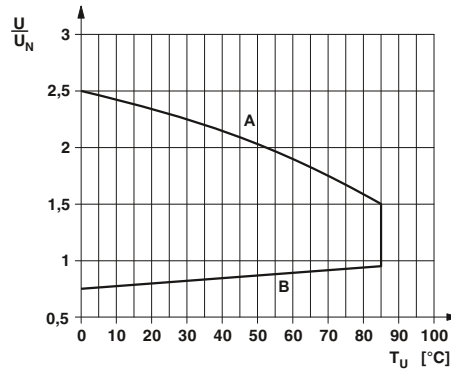

5 mm overall width

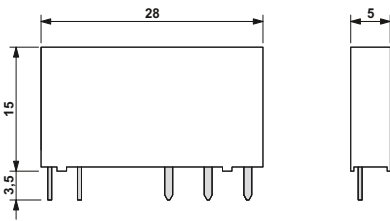

12.7 mm overall width

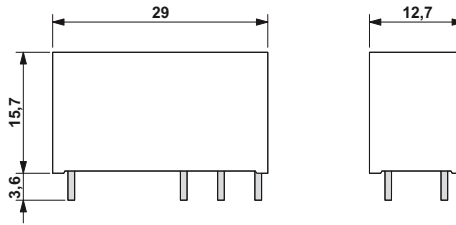

Perforations for assembly: view of the connections

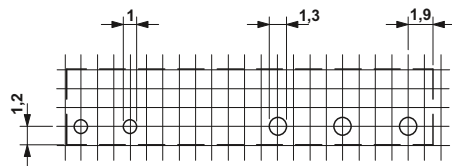

Pitch division: 1.25 mm and 1.27 mm

Perforations for assembly: view of the connections

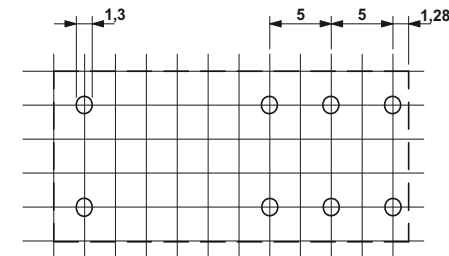

Pitch division: 2.5 mm

Plug-in solid-state relays

**OPT...DC/24DC/2**  
**OPT...DC/230AC/1**

Derating curve for OPT...DC/24DC/2 and PLC-OS.../24DC/2 solid-state relays

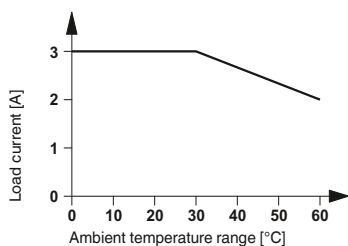

**OPT...DC/24DC/5**  
**OPT...DC/230AC/2**

Derating curve for OPT...DC/24DC/5 and PLC-OS.../24DC/5/ACT solid-state relays

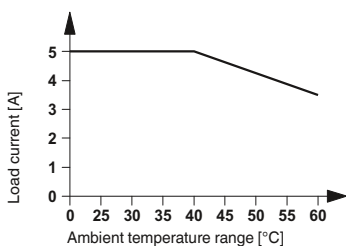

Derating curve for OPT...DC/230AC/1 and PLC-OS.../230AC/1 solid-state relays

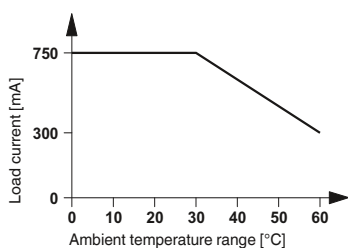

Derating curve for OPT...DC/230AC/2 and PLC-OS.../230AC/2/ACT solid-state relays

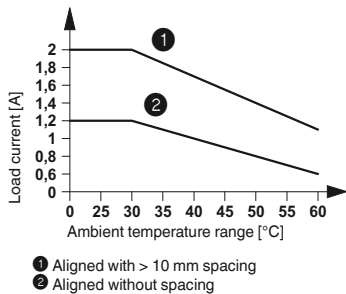

5 mm overall width

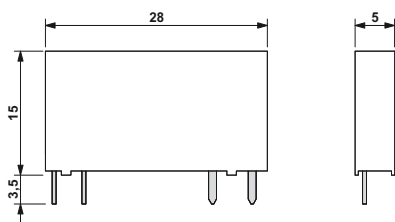

12.7 mm overall width

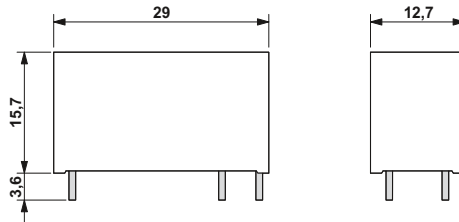

# Relay modules

## Tables, diagrams, dimensional drawings

### Electrical interrupting rating for PLC-INTERFACE

Electrical interrupting rating for PLC...21 with 1 PDT relay

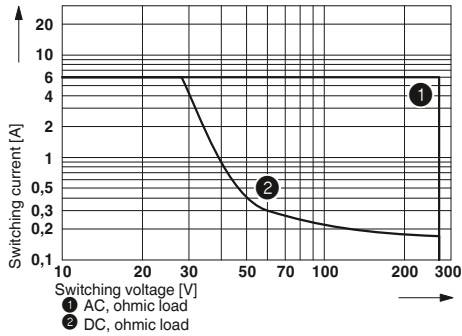

### PLC-INTERFACE for railway applications

Electrical service life for PLC-RSP...UC/21RW

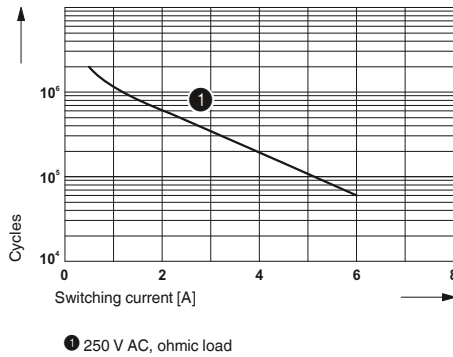

Electrical interrupting rating for PLC...21-21 with 2 PDT relay

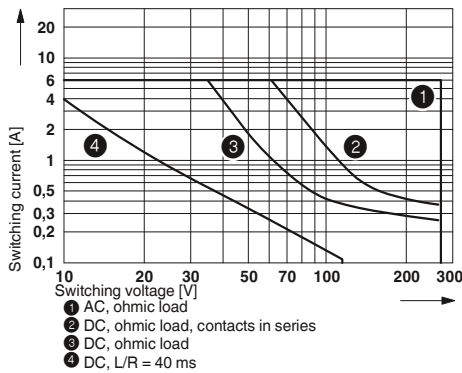

Electrical service life for PLC-RSP...UC/21-21/RW

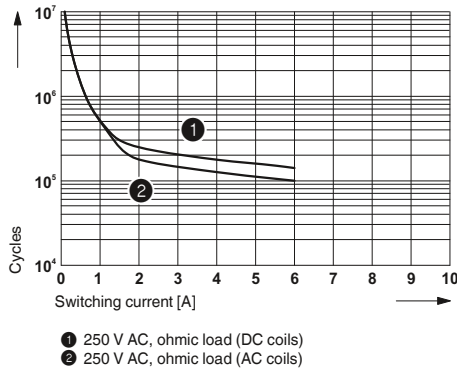

Electrical interrupting rating for PLC...11C/ACT for high inrush currents

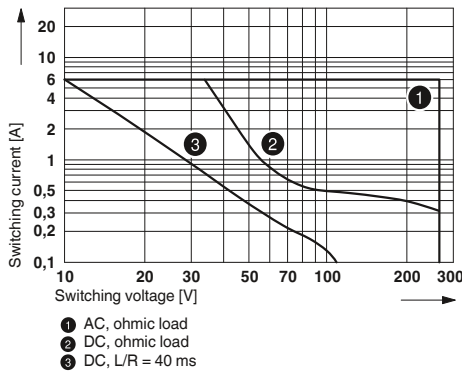

Electrical service life for PLC-RSP...UC/21HC/RW

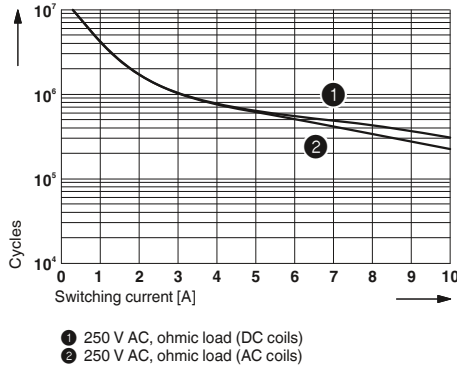

Electrical interrupting rating for PLC...21HC for high continuous currents

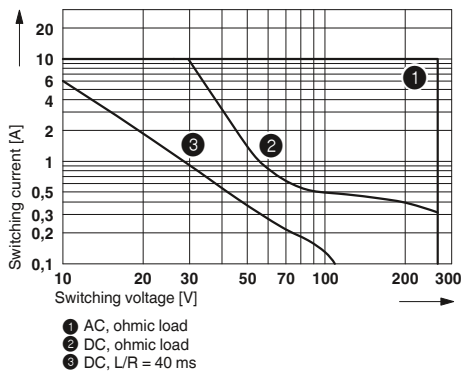

EMG-OV solid-state power relays

Derating curve for EMG 17-OV...48DC/2

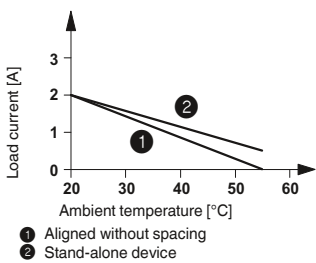

ST-OV 4-24DC/24DC...PRO power circuit breaker solid-state relays with signal logic

Derating curve for ST-OV 4-24DC/24DC...PRO

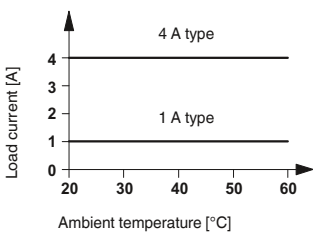

Time-current characteristic, 1 A version

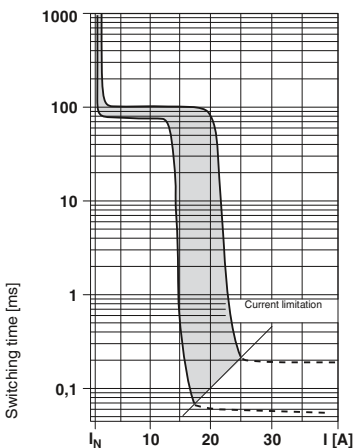

Time-current characteristic, 4 A version

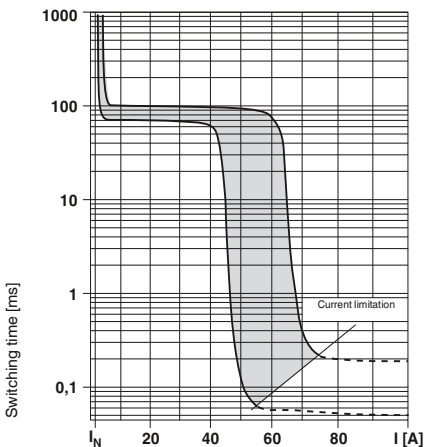

State diagram

Operating state	Switching level Input	Light indicator, yellow LED	Light indicator, red LED	Alarm contact/ CONTROL
Not activated	L	L	L	
Normal operation	H	H	L	
Overload/short circuit	H	H	H	
Opencircuit	L	L	H	

UEGM-OE/AV logic pulse expansion module

Time diagrams for UEGM-OE/AV-24DC/24DC/100

Scenario 1: input pulse  $t_i < t_{O\ set}$

Operating voltage present

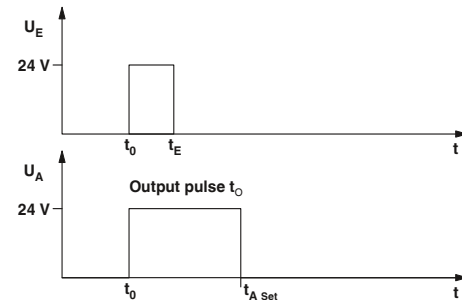

Scenario 2: input pulse  $t_i \geq t_{O\ set}$

Operating voltage present

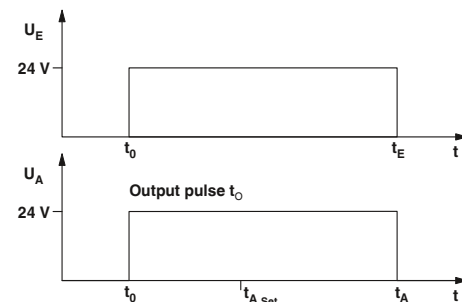

Table of adjustable output pulse lengths

	DIP switches <sup>1)</sup>							
	S1	S2	S3	S4	S5	S6	S7	S8
Length of output pulses [ms] (when in "on" switch position)	10	-	-	-	-	-	-	-
	-	20	-	-	-	-	-	-
	-	-	50	-	-	-	-	-
	-	-	-	100	-	-	-	-
	-	-	-	-	200	-	-	-
	-	-	-	-	-	500	-	-
	-	-	-	-	-	-	1000	-
	-	-	-	-	-	-	-	1500

<sup>1)</sup> If no switch is actuated, the output voltage is not defined.

If the input pulse is longer than the set time, the output is switched off almost simultaneously with the input.

Intermediate values can be obtained by combining several DIP switches according to the following formula:

$$T_{tot} = \frac{1}{\frac{1}{t_1} + \frac{1}{t_2} + \dots + \frac{1}{t_n}}$$

# Relay modules

## Highly compact relay modules - PLC-INTERFACE

### PLC-INTERFACE with two integrated relays

Relay module with two permanently soldered-in power relays

The advantages:

- 100% more channel density than the conventional 6.2 mm relay
- Two switching channels in a 6.2 mm housing
- Integrated input circuit/protective circuit
- Safe isolation according to DIN EN 50178 between coil and contacts and between contacts
- Screw and push-in connection technology

Notes:
Type of housing: Polyamide PA non-reinforced, color: green.
Marking systems and mounting material See Catalog 5



Two integrated relays

ERC

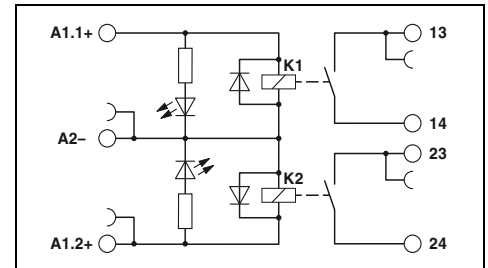

#### Technical data

Input data	①
Typ. input current at $U_N$	7 [mA]
Response/release time at $U_N$	4 / 6 [ms]
Input circuit DC	Yellow LED, protection against polarity reversal, freewheeling diode
Output data	
Contact material	AgNi
Max. switching voltage	250 V AC/DC
Min. switching voltage	24 V AC/DC
Limiting continuous current	3.5 A
Min. switching current	5 mA
General data	
Test voltage input/output	3 kV AC (50 Hz, 1 min.)
Test voltage output/output	3 kV AC (50 Hz, 1 min.)
Ambient temperature (operation)	-20 °C ... 60 °C
Mechanical service life	2 x 10 <sup>7</sup> cycles
Standards/regulations	IEC 60664, EN 50178, IEC 62103
Connection data solid / stranded / AWG	0.14 - 2.5 mm <sup>2</sup> / 0.14 - 2.5 mm <sup>2</sup> / 26 - 14
Dimensions	6.2 mm / 80 mm / 86 mm
EMC note	Class A product, see page 625

#### Ordering data

Description	Input voltage $U_N$	Type	Order No.	Pcs. / Pkt.
<b>PLC-INTERFACE, with screw connection</b>				
①	24 V DC	PLC-2RSC-24DC / 1	2987309	10
<b>PLC-INTERFACE, with push-in connection</b>				
①	24 V DC	PLC-2RPT-24DC/1	2901639	10



Application example for PLC-2RS...24DC/1

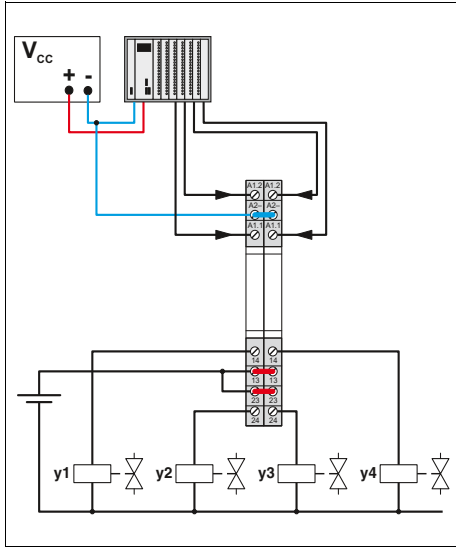

Operating voltage range

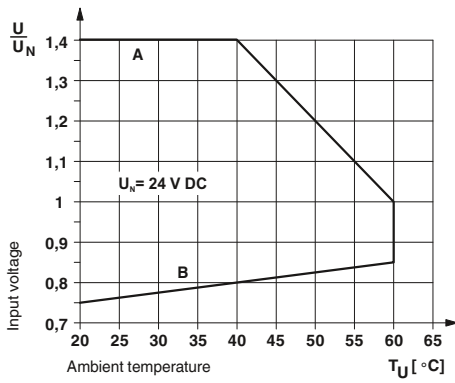

Interrupting rating

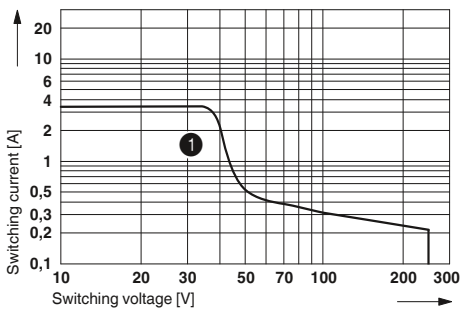

① DC, ohmic load

# Relay modules

## Highly compact relay modules - PLC-INTERFACE

### PLC-INTERFACE with manual switch and relay

Relay module with manual switch and integrated power relay for manual, zero, and automatic functions

#### The advantages are:

- Max. switching current of 6 A
- Only 6.2 mm wide
- Floating confirmation contact
- Safe isolation according to DIN EN 50178 between coil and contact
- Screw and push-in connection technology

<b>Notes:</b>
Type of housing: Polyester PBT non-reinforced, color: green.
Marking systems and mounting material See Catalog 5
For the protection of input and output, inductive loads must be damped with an effective protection circuit.
Separating plate PLC-ATP is to be used in the following cases: always at the start and end of a PLC terminal strip, for voltages greater than 250 V (L1, L2, L3) between the same terminal points of neighboring modules (potential bridging then takes place with FBST 8-PLC... or FBST 500...) and with safe isolation between neighboring modules.
<b>Module height:</b> PLC-...-S/H = 90 mm; PLC-...-S/L = 86 mm
PLC...H - manual operation PLC...L - operation using screwdriver



Relay module with manual switch and integrated relay

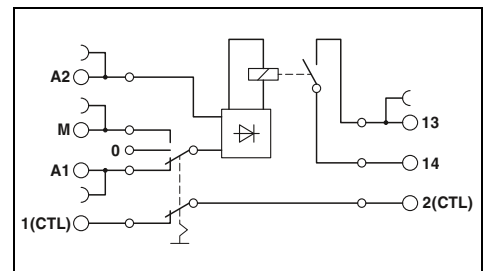

Application example PLC-RS...24UC/1/S...

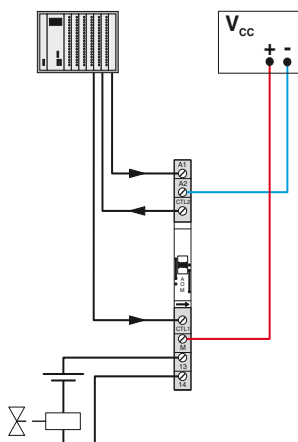

Permissible input voltage range for PLC-RS...24UC/1/S...

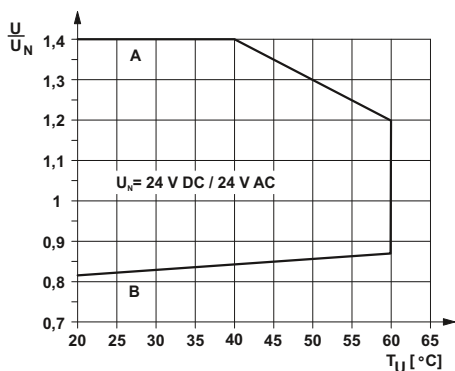

**Curve A**  
maximum continuous voltage at limiting continuous current = 6 A

**Curve B**  
minimum operating voltage for pre-excitation with U<sub>N</sub> and limiting continuous current = 6 A

<b>Input data</b>	
Typ. input current at U <sub>N</sub>	[mA]
Response/release time at U <sub>N</sub>	[ms]
Input circuit AC/DC	
<b>Output data</b>	
Contact material	AgSnO
Max. switching voltage	250 V AC/DC
Min. switching voltage	5 V (at 100 mA)
Limiting continuous current	6 A
Max. inrush current	on request
Min. switching current	10 mA (at 12 V)
<b>Feedback</b>	
Operating mode "Automatic" floating	max. 30 V AC/DC / 50 mA min. 2 V AC/DC / 1 mA
<b>General data</b>	
Rated insulation voltage	250 V AC
Rated surge voltage	6 kV
Ambient temperature (operation)	-20 °C ... 60 °C
Standards/regulations	IEC 60664, EN 50178, IEC 62103
Pollution degree / surge voltage category	2 / III
Connection data solid / stranded / AWG	0.14 - 2.5 mm <sup>2</sup> / 0.14 - 2.5 mm <sup>2</sup> / 26 - 14
Dimensions	6.2 mm / 80 mm / 90 mm
EMC note	Class A product, see page 625

### Technical data

	①	②
Typ. input current at U <sub>N</sub>	11	11
Response/release time at U <sub>N</sub>	6 / 15	6 / 15
Input circuit AC/DC		Yellow LED, bridge rectifier
Contact material	AgSnO	
Max. switching voltage	250 V AC/DC	
Min. switching voltage	5 V (at 100 mA)	
Limiting continuous current	6 A	
Max. inrush current	on request	
Min. switching current	10 mA (at 12 V)	
Operating mode "Automatic" floating	max. 30 V AC/DC / 50 mA min. 2 V AC/DC / 1 mA	
Rated insulation voltage	250 V AC	
Rated surge voltage	6 kV	
Ambient temperature (operation)	-20 °C ... 60 °C	
Standards/regulations	IEC 60664, EN 50178, IEC 62103	
Pollution degree / surge voltage category	2 / III	
Connection data solid / stranded / AWG	0.14 - 2.5 mm <sup>2</sup> / 0.14 - 2.5 mm <sup>2</sup> / 26 - 14	
Dimensions	6.2 mm / 80 mm / 90 mm	
EMC note	Class A product, see page 625	

### Ordering data

Description	Input voltage U <sub>N</sub>	Type	Order No.	Pcs. / Pkt.
<b>PLC-INTERFACE, with screw connection</b>				
①	24 V AC/DC	PLC-RSC- 24UC/ 1/S/H	2982236	10
②	24 V AC/DC	PLC-RSC- 24UC/ 1/S/L	2834876	10
<b>PLC-INTERFACE, with push-in connection</b>				
①	24 V AC/DC	PLC-RPT- 24UC/ 1/S/H	2900328	10
②	24 V AC/DC	PLC-RPT- 24UC/ 1/S/L	2900327	10

**PLC-INTERFACE with manual switch without relay**

Switching module without relay for manual, zero, and automatic functions

The advantages:

- Only 6.2 mm wide
- Floating confirmation contact
- Screw and spring-cage connection technology

<b>Notes:</b>
Type of housing: Polyester PBT non-reinforced, color: green.
Marking systems and mounting material See Catalog 5
For the protection of input and output, inductive loads must be dampened with an effective protection circuit.
Separating plate PLC-ATP is to be used in the following cases: always at the start and end of a PLC terminal strip, for voltages greater than 250 V (L1, L2, L3) between the same terminal points of neighboring modules (potential bridging then takes place with FBST 8-PLC... or FBST 500...) and with safe isolation between neighboring modules.
<b>Module height:</b> PLC-...-S/H = 90 mm; PLC-...-S/L: = 86 mm
PLC...-H - manual operation PLC...-L - operation using screwdriver



Module with manual switch without relay

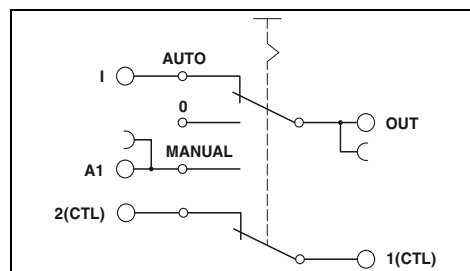

**Technical data**

Max. switching voltage	72 V DC
Min. switching voltage	2 V DC
Max. inrush current	50 mA
Min. switching current	1 mA
Cycles, max.	100 (at 72 V DC / 50 mA) / 10000 (at 12 V DC / 100 mA)
<b>Feedback</b>	
Operating mode "Automatic" floating	≤ 72 V DC / 50 mA
<b>General data</b>	
Rated insulation voltage	85 V AC
Rated surge voltage	0.5 kV / basic insulation
Ambient temperature (operation)	-20 °C ... 60 °C
Standards/regulations	IEC 60664, EN 50178, IEC 62103
Pollution degree / surge voltage category	2 / III
Dimensions	W / H / D 6.2 mm / 80 mm / 90 mm

**Ordering data**

Description	Type	Order No.	Pcs. / Pkt.
<b>PLC-INTERFACE, with screw connection</b>			
	PLC-SC-S/H	2980733	10
	PLC-SC-S/L	2980775	10
<b>PLC-INTERFACE, with spring-cage connection</b>			
	PLC-SP-S/H	2980746	10
	PLC-SP-S/L	2980788	10

Application example PLC-S...S...

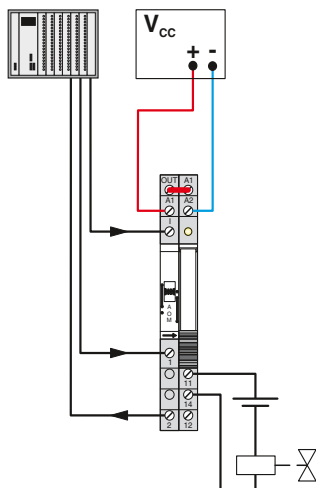

# Relay modules

## Highly compact relay modules - PLC-INTERFACE

### PLC RELAY with an integrated solid-state relay

The slim 6.2 mm PLC housing with integrated electronics in various versions offers the following advantages:

- Option of bridging adjacent modules
- Status display
- Protection circuits in input and output
- Wear-resistant and bounce-free switching
- Integrated protection circuit
- DC outputs of up to 300 V DC/1 A or up to 24 V DC/10 A
- Electronic PDT output of up to 48 V DC/500 mA
- Screw and push-in connection technology

Notes:
Type of housing: Polyester PBT non-reinforced, color: green.
Marking systems and mounting material See Catalog 5
For the protection of input and output, inductive loads must be dampened with an effective protection circuit.
Separating plate PLC-ATP is to be used in the following cases: always at the start and end of a PLC terminal strip, for voltages greater than 250 V (L1, L2, L3) between the same terminal points of neighboring modules (potential bridging then takes place with FBST 8-PLC... or FBST 500...) and with safe isolation between neighboring modules.
The housings of the following modules are open on one side: - PLC-OS...-300DC/1 - PLC-OS...-24DC/24DC/10/R



Power solid-state relay with DC voltage output, max. 1 A

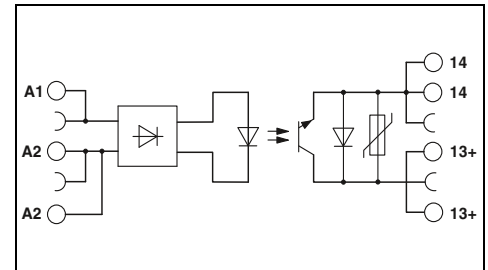

Input data	
Permissible range (with reference to $U_N$ )	
Switching level (with reference to $U_N$ )	1 signal ("H") 0 signal ("L")
Typ. input current at $U_N$	[mA]
Transmission frequency $f_{limit}$	[Hz]
Alarm output	
Operating range	- / -
Output data	
Max. / min. switching voltage	300 V DC / 12 V DC
Limiting continuous current	1 A (see derating curve)
Voltage drop at max. limiting continuous current	< 500 mV
General data	
Rated insulation voltage	300 V
Rated surge voltage	4 kV / basic insulation
Ambient temperature (operation)	-25 °C ... 60 °C
Standards/regulations	IEC 60664, EN 50178, IEC 62103
Connection data solid / stranded / AWG	0.14 - 2.5 mm <sup>2</sup> / 0.14 - 2.5 mm <sup>2</sup> / 26 - 14
Dimensions	W / H / D
EMC note	Class A product, see page 625

Technical data							
①	②	③	④	⑤	⑥	⑦	⑧
0.8 - 1.2	0.8 - 1.2	0.8 - 1.2	0.8 - 1.2	0.8 - 1.2	0.8 - 1.2	0.8 - 1.1	0.8 - 1.1
≥ 0.8	≥ 0.8	≥ 0.8	≥ 0.8	≥ 0.8	≥ 0.8	≥ 0.8	≥ 0.8
≤ 0.4	≤ 0.4	≤ 0.4	≤ 0.4	≤ 0.4	≤ 0.4	≤ 0.4	≤ 0.4
15	6	8	5	5	3	5.6	8.4
50	50	50	50	50	50	10	10

Description	Input voltage $U_N$
<b>PLC-INTERFACE, with screw connection</b>	
①	5 V DC
②	12 V DC
③	24 V DC
④	60 V DC
⑤	110 V DC
⑥	220 V DC
⑦	120 V AC
⑧	230 V AC
<b>PLC-INTERFACE, with push-in connection</b>	
①	5 V DC
②	12 V DC
③	24 V DC
④	60 V DC
⑤	110 V DC
⑥	220 V DC
⑦	120 V AC
⑧	230 V AC

Ordering data		
Type	Order No.	Pcs. / Pkt.
PLC-OSC- 5DC/300DC/ 1	2980652	10
PLC-OSC- 12DC/300DC/ 1	2980665	10
PLC-OSC- 24DC/300DC/ 1	2980678	10
PLC-OSC- 60DC/300DC/ 1	2980681	10
PLC-OSC-110DC/300DC/ 1	2980694	10
PLC-OSC-220DC/300DC/ 1	2980704	10
PLC-OSC-120AC/300DC/ 1	2980717	10
PLC-OSC-230AC/300DC/ 1	2980720	10
PLC-OPT- 5DC/300DC/1	2900381	10
PLC-OPT- 12DC/300DC/1	2900382	10
PLC-OPT- 24DC/300DC/1	2900383	10
PLC-OPT- 60DC/300DC/1	2900384	10
PLC-OPT-110DC/300DC/1	2900385	10
PLC-OPT-220DC/300DC/1	2900387	10
PLC-OPT-120AC/300DC/1	2900388	10
PLC-OPT-230AC/300DC/1	2900389	10

Highly compact relay modules - PLC-INTERFACE



Power solid-state relay with short-circuit-proof DC voltage output, max. 10 A, with feedback



Input solid-state relay with DC voltage output, max. 500 mA, with electronic PDT

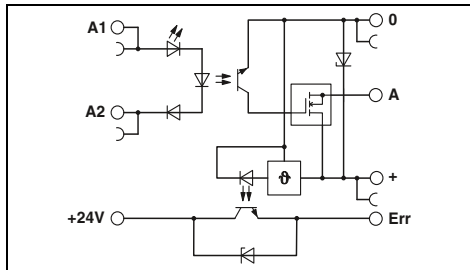

Technical data

- ③
- 0.8 - 1.2
- ≥ 0.8
- ≤ 0.4
- 3
- 100

3 V DC ... 33 V DC (High active) / 100 mA

33 V DC / 5 V DC  
10 A (see derating curve)  
≤ 50 mV

300 V  
4 kV / basic insulation  
-25 °C ... 60 °C  
IEC 60664, EN 50178, IEC 62103  
0.14 - 2.5 mm<sup>2</sup> / 0.14 - 2.5 mm<sup>2</sup> / 26 - 14  
6.2 mm / 80 mm / 86 mm  
Class A product, see page 625

Ordering data

Type	Order No.	Pcs. / Pkt.
PLC-OSC- 24DC/ 24DC/ 10/R	2982702	10
PLC-OPT- 24DC/ 24DC/ 10/R	2900398	10

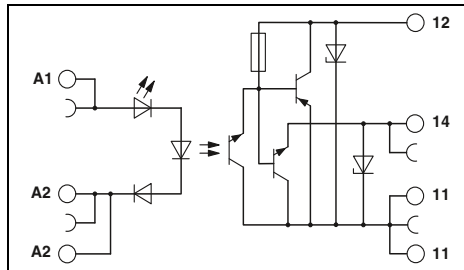

Technical data

- ③
- 0.8 - 1.2
- ≥ 0.8
- ≤ 0.4
- 3
- 1000

- / -

48 V DC / 3 V DC  
500 mA (see derating curve)  
< 1.2 V

300 V  
4 kV / basic insulation  
-25 °C ... 60 °C  
IEC 60664, EN 50178, IEC 62103  
0.14 - 2.5 mm<sup>2</sup> / 0.14 - 2.5 mm<sup>2</sup> / 26 - 14  
6.2 mm / 80 mm / 86 mm  
Class A product, see page 625

Ordering data

Type	Order No.	Pcs. / Pkt.
PLC-OSC- 24DC/ 48DC/ 500/W	2980636	10
PLC-OPT- 24DC/ 48DC/ 500/W	2900378	10

Derating curve for PLC...300DC/1

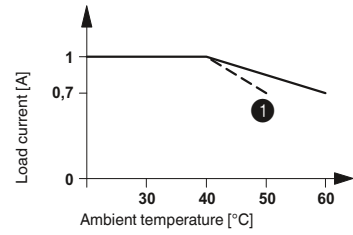

① For input voltages 220 V DC and 230 V AC

Derating curve for PLC...24DC/24DC/10/R

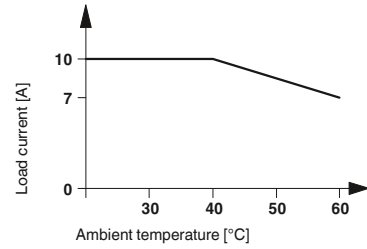

Derating curve for PLC...24DC/48DC/500/W

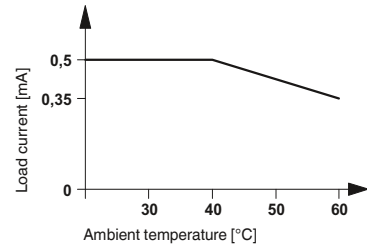

# Relay modules

## Highly compact relay modules - PLC-INTERFACE

### PLC RELAY with an integrated solid-state relay

- 6.2 mm narrow solid-state relay for switching AC loads
- Status display
- Protection circuits in input and output
- Wear-free
- Switching capacity up to 230 V AC/2.4 A
- Screw and push-in connection technology



Solid-state power relay with AC voltage output, max. 2.4 A

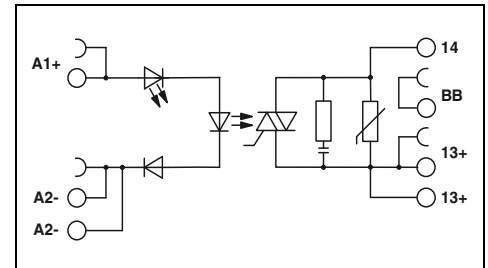

#### Technical data

Input data		①
Rated actuating voltage range with reference to $U_C$		0.8 - 1.2
Rated actuating current $I_C$	[mA]	8
Switching level (with reference to $U_C$ )	1 signal ("H")	> 0.8
	0 signal ("L")	< 0.4
Typ. switch-on time at $U_N$	[ms]	10
Typ. shutdown time at $U_N$	[ms]	10
Transmission frequency $f_{limit}$	[Hz]	10
Input circuit DC		Yellow LED, protection against polarity reversal, surge protection
Output data		
Max. switching voltage		253 V AC
Min. switching voltage		24 V AC
Max. inrush current		250 A (20 ms)
Min. / max. switching current		10 mA / 2.4 A (see to derating)
Output protection		RCV circuit
Voltage drop at max. limiting continuous current		< 1 V
Leakage current in off state		< 1 mA
Phase angle (cos $\phi$ )		-
Max. load value		340 A <sup>2</sup> s (tp = 10 ms, at 25 °C)
General data		
Rated insulation voltage		260 V AC
Rated surge voltage		4 kV
Insulation		Basic insulation
Ambient temperature (operation)		-25 °C ... 60 °C
Standards/regulations		DIN EN 50178
Pollution degree / surge voltage category		2 / III
Connection data solid / stranded / AWG		0.14 - 2.5 mm <sup>2</sup> / 0.14 - 2.5 mm <sup>2</sup> / 26 - 14
Dimensions	W / H / D	6.2 mm / 80 mm / 86 mm
EMC note		Class A product, see page 625

#### Ordering data

Description	Rated actuating voltage $U_C$	Type	Order No.	Pcs. / Pkt.
PLC-INTERFACE, with screw connection	① 24 V DC	PLC-OSC- 24DC/230AC/2.4/ACT	2904631	10
PLC-INTERFACE, with push-in connection	① 24 V DC	PLC-OPT- 24DC/230AC/2.4/ACT	2904632	10

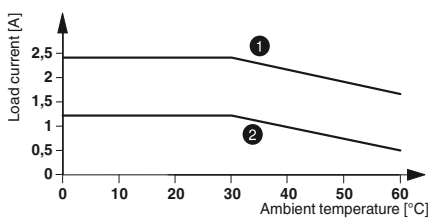

Load current as a function of the ambient temperature  
Operating time: 100% operating factor

**PLC-INTERFACE with hybrid solid-state relay**

The solid-state relay, combined with a mechanical relay, offers the following advantages:

- Higher electrical service life
- Lower power dissipation
- Option of bridging adjacent modules
- Status display
- Protection circuits in input and output
- Switching capacity up to 230 V AC/10 A
- Screw and push-in connection technology



**Hybrid solid-state relay with AC voltage output, max. 10 A**

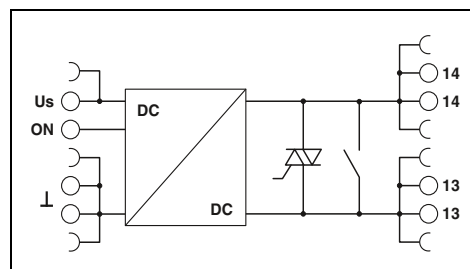

**Technical data**

<b>Input data</b>		①
Rated control supply voltage $U_s$	[V DC]	24
Rated control supply voltage range with reference to $U_s$		0.8 - 1.2
Rated control supply current $I_s$		14 mA (input low, output low) 19 mA (input high, output high)
Rated actuation voltage $U_c$ ON	[V DC]	24
Rated actuating voltage range with reference to $U_c$		0.8 - 1.2
Rated actuating current $I_c$	[mA]	6.8
Input circuit DC		Yellow LED, protection against polarity reversal, surge protection
<b>Output data</b>		
Max. switching voltage		253 V AC 24 V AC
Min. switching voltage		-
Max. inrush current		-
Min. / max. switching current		100 mA / 10 A (see derating curve)
Output protection		RCV circuit
Voltage drop at max. limiting continuous current		-
Leakage current in off state		< 1 mA
Phase angle (cos $\phi$ )		-
Max. load value		350 A <sup>2</sup> s (tp = 10 ms, at 25 °C)
<b>General data</b>		
Rated insulation voltage		260 V AC
Rated surge voltage		6 kV
Insulation		safe isolation
Ambient temperature (operation)		-25 °C ... 60 °C
Standards/regulations		DIN EN 50178
Pollution degree / surge voltage category		2 / III
Connection data solid / stranded / AWG		0.14 - 2.5 mm <sup>2</sup> / 0.14 - 2.5 mm <sup>2</sup> / 26 - 14
Dimensions	W / H / D	6.2 mm / 80 mm / 86 mm

**Ordering data**

Description	Rated actuating voltage $U_c$	Type	Order No.	Pcs. / Pkt.
<b>PLC-INTERFACE, with screw connection</b>				
①	24 V DC	PLC-HSC-24DC/230AC/10	2905214	1
<b>PLC-INTERFACE, with push-in connection</b>				
①	24 V DC	PLC-HPT-24DC/230AC/10	2905215	1



# Relay modules

## Highly compact relay modules - PLC-INTERFACE

### PLC-INTERFACE

#### Solid-state relays up to 100 kHz

A solid-state relay for the safe acquisition of short pulses.

- Status display
- Bridging options
- Cut-off frequency of up to 100 kHz
- Push-pull stage on output side
- Features a capacitor on the input side for interference suppression

Notes:
Type of housing: Polyamide PA non-reinforced, color: green.
Marking systems and mounting material See Catalog 5



With DC voltage output  
Transmission frequency 100 kHz

ERC

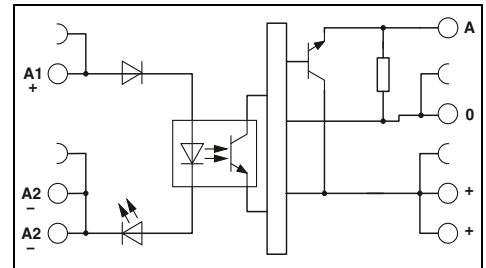

Input data	
Permissible range (with reference to $U_N$ )	
Switching level with reference to $U_N$	1 signal ("H") 0 signal ("L")
Typ. input current at $U_N$	[mA]
Typ. switch-on time at $U_N$	[ $\mu$ s]
Typ. shutdown time at $U_N$	[ $\mu$ s]
Transmission frequency $f_{limit}$	[kHz]
Input protection:	
Output data	
Operating voltage range	
Limiting continuous current	
Quiescent current	
Residual voltage drop at "H"	
Output circuit	
Output protection	
General data	
Test voltage input/output	
Ambient temperature (operation)	
Standards/regulations	
Pollution degree / surge voltage category	
Connection data solid / stranded / AWG	
Dimensions	W / H / D
EMC note	

Technical data	
①	②
0.8 - 1.2	0.8 - 1.2
> 0.8	> 0.8
< 0.4	< 0.4
7	6
1.5	1.5
2	2
100	100
Yellow LED, protection against polarity reversal, surge protection	
4 V DC ... 30 V DC	
50 mA	
4.3 mA	
< 0.5 V	
3-conductor, ground-referenced	
Protection against polarity reversal, surge protection	
2.5 kV <sub>rms</sub> (50 Hz, 1 min.)	
-20 °C ... 60 °C	
DIN EN 50178	
2 / II	
0.14 - 2.5 mm <sup>2</sup> / 0.14 - 2.5 mm <sup>2</sup> / 26 - 14	
6.2 mm / 80 mm / 86 mm	
Class A product, see page 625	

Description	Input voltage $U_N$
<b>Input solid-state relay</b> with screw connection	① 5 V DC
	② 24 V DC
<b>Input solid-state relay</b> with push-in connection	① 5 V DC
	② 24 V DC

Ordering data		
Type	Order No.	Pcs. / Pkt.
PLC-OSC- 5DC/ 24DC/100KHZ	2902963	1
PLC-OSC- 24DC/ 24DC/100KHZ	2902964	1
PLC-OPT- 5DC/ 24DC/100KHZ	2902969	1
PLC-OPT- 24DC/24DC/100KHZ	2902970	1



With DC voltage output push-pull  
Transmission frequency 100 kHz



With DC voltage output push-pull  
Transmission frequency 100 kHz

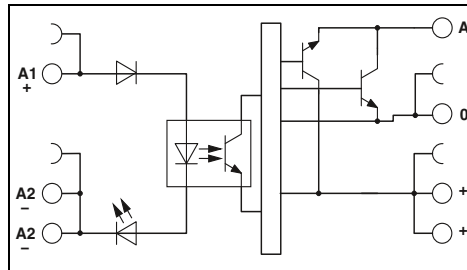
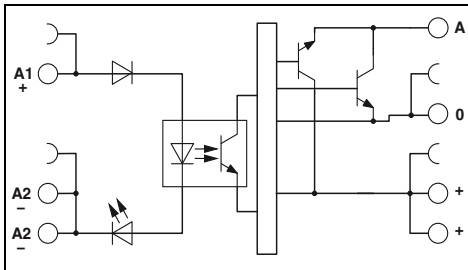

Technical data

①	②
0.5 - 1.2	0.8 - 1.2
> 0.5	> 0.8
< 0.3	< 0.4
8	8
1	1
2	2
100	100
Yellow LED, protection against polarity reversal, surge protection	

Technical data

①	②
0.5 - 1.2	0.8 - 1.2
> 0.5	> 0.8
< 0.3	< 0.4
8	8
1	1
2	2
100	100
Yellow LED, protection against polarity reversal, surge protection	

4 V DC ... 18 V DC  
50 mA  
8.5 mA  
< 1.2 V  
3-conductor push-pull, ground referenced  
Protection against polarity reversal, surge protection

14 V DC ... 30 V DC  
50 mA  
15 mA  
< 2.2 V  
3-conductor push-pull, ground referenced  
Protection against polarity reversal, surge protection

2.5 kV<sub>rms</sub> (50 Hz, 1 min.)  
-20 °C ... 60 °C  
DIN EN 50178  
2 / II

2.5 kV<sub>rms</sub> (50 Hz, 1 min.)  
-20 °C ... 60 °C  
DIN EN 50178  
2 / II

0.14 - 2.5 mm<sup>2</sup> / 0.14 - 2.5 mm<sup>2</sup> / 26 - 14  
6.2 mm / 80 mm / 86 mm  
Class A product, see page 625

0.14 - 2.5 mm<sup>2</sup> / 0.14 - 2.5 mm<sup>2</sup> / 26 - 14  
6.2 mm / 80 mm / 86 mm  
Class A product, see page 625

Ordering data

Ordering data

Type	Order No.	Pcs. / Pkt.
PLC-OSC- 5DC/ 5DC/100KHZ-G	2902965	1
PLC-OSC- 24DC/ 5DC/100KHZ-G	2902966	1
PLC-OPT- 5DC/ 5DC/100KHZ-G	2902971	1
PLC-OPT- 24DC/ 5DC/100KHZ-G	2902972	1

Type	Order No.	Pcs. / Pkt.
PLC-OSC- 5DC/ 24DC/100KHZ-G	2902967	1
PLC-OSC- 24DC/ 24DC/100KHZ-G	2902968	1
PLC-OPT- 5DC/24DC/100KHZ-G	2902973	1
PLC-OPT- 24DC/24DC/100KHZ-G	2902974	1

# Relay modules

## Highly compact relay modules - PLC-INTERFACE

### PLC-INTERFACE for the TTL signal at input

The PLC-BS...TTL/1 basic terminal block is controlled using a TTL (5 V) input signal and can be equipped with a mechanical relay or a solid-state relay as an option. The basic terminal block equipped with a robust miniature relay offers the following advantages:

- 6.2 mm slim overall width
- Bridging options
- Status display
- RTIII degree of protection
- Safe isolation in accordance with EN 50178 (VDE 0160)
- 4 kV<sub>rms</sub> electrical isolation between coil and contact
- Screw and push-in connection technology

Notes:
Type of housing: Polyester PBT non-reinforced, color: green.
Marking systems and mounting material See Catalog 5



Basic terminal block, for fitting with relay for TTL (5 V)

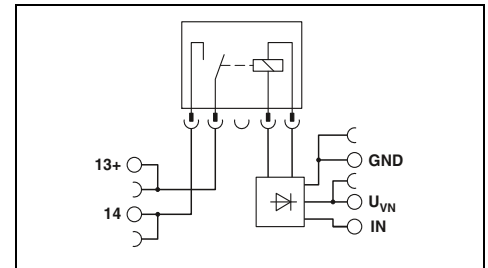

#### Technical data

Input data	REL-MR-4,5DC/21 AU	REL-MR-4,5DC/21
Rated control supply voltage $U_{VN}$	5 V DC	5 V DC
Rated control supply voltage range with reference to $U_{VN}$	0.9 ... 1.2	0.9 ... 1.2
Rated control supply current $I_{VN}$	41 mA	41 mA
Rated actuating voltage $U_c$ (IN)	5 V DC (TTL)	5 V DC (TTL)
Rated actuating voltage range with reference to $U_c$	0.9 ... 1.2	0.9 ... 1.2
Rated actuating current $I_c$	2.5 mA	2.5 mA
Typ. response time at $U_c$	4.5 ms	4.5 ms
Typ. release time for $U_c$	3.5 ms	3.5 ms
Input circuit	Yellow LED, protection against polarity reversal, surge protection	
Output data with:		
Contact type	Single contact, 1 N/O contact	Single contact, 1 N/O contact
Contact material	AgSnO, hard gold-plated	AgSnO
Max. switching voltage	30 V AC / 36 V DC	250 V AC/DC
Min. switching voltage	100 mV (at 10 mA)	5 V (at 100 mA)
Limiting continuous current	50 mA	6 A
Max. inrush current	50 mA	on request
Min. switching current	1 mA (at 24 V)	10 mA (at 12 V)
General data		
Rated insulation voltage	250 V	250 V
Rated surge voltage / insulation	6 kV	6 kV
Ambient temperature (operation)	-20 °C ... 60 °C	-20 °C ... 60 °C
Mechanical service life	2 x 10 <sup>7</sup> cycles	2 x 10 <sup>7</sup> cycles
Clearance and creepage distances between the power circuits	IEC 60664, EN 50178, IEC 62103	
Pollution degree / Surge voltage category	2 / III	
Mounting position / mounting	any / can be aligned without spacing	
Connection data solid / stranded / AWG	0.14 - 2.5 mm <sup>2</sup> / 0.14 - 2.5 mm <sup>2</sup> / 26 - 14	
Dimensions	6.2 mm / 80 mm / 94 mm	
EMC note	Class A product, see page 625	

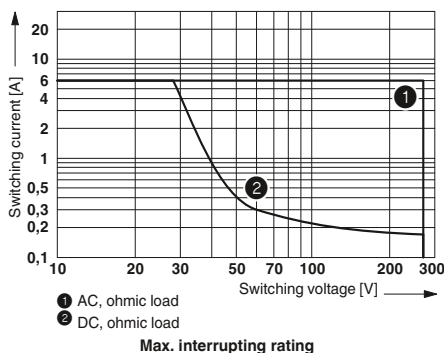

Description
<b>PLC-INTERFACE</b> With screw connection With push-in connection
<b>Plug-in miniature power relay</b> with gold contact with power contact

#### Ordering data

Type	Order No.	Pcs. / Pkt.
PLC-BSC-TTL/1	2982689	10
PLC-BPT-TTL/1	2900458	10

#### Accessories

REL-MR 4,5DC/21AU	2961370	10
REL-MR- 4,5DC/21	2961367	10

**PLC-INTERFACE for the TTL signal at input**

The PLC-BS...TTL/1 basic terminal block is controlled using a TTL (5 V) input signal and can be equipped with a mechanical relay or a solid-state relay as an option. The basic terminal block equipped with a solid-state relay offers the following advantages:

- 6.2 mm slim overall width
- Bridging options
- Status display
- IP67-protected solid-state relay electronic unit
- Switching capacity of up to 24 V DC/3 A
- Alternative input or power solid-state relay
- Wear-free and output-free
- Integrated protective circuit
- 2.5 kV<sub>rms</sub> electrical isolation between input and output
- Screw and push-in connection technology

<b>Notes:</b>
Type of housing: Polyester PBT non-reinforced, color: green.
Marking systems and mounting material See Catalog 5
For derating curves see page 425



**Basic terminal block for fitting with solid-state relay for TTL (5 V)**

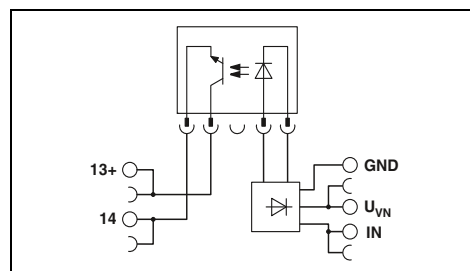

**Technical data**

<b>Input data</b>		
Rated control supply voltage $U_{VN}$	5 V DC	
Rated control supply voltage range with reference to $U_{VN}$	0.9 ... 1.2	
Rated control supply current $I_{VN}$	11.5 mA	
Rated actuating voltage $U_c$ (IN)	5 V DC (TTL)	
Switching level 1 signal ("H") (TTL signal)	> 2 V DC	
Switching level 0 signal ("L") (TTL signal)	< 0.8 V DC	
Rated actuating current $I_c$	2.5 mA	
Typ. response time/switch-on time at $U_c$	35 $\mu$ s	
Typ. shutdown time at $U_c$	320 $\mu$ s	
Input circuit	Yellow LED, protection against polarity reversal, surge protection	
<b>Output data with:</b>	OPT-5DC/48DC/100	OPT-5DC/24DC/2
Max. switching voltage	48 V DC	33 V DC
Min. switching voltage	3 V DC	3 V DC
Limiting continuous current	100 mA	3 A
Output protection	Protection against polarity reversal, surge protection	Protection against polarity reversal, surge protection
Voltage drop at limiting continuous current	< 1 V	< 200 mV
<b>General data</b>		
Rated insulation voltage	250 V	
Rated surge voltage / insulation	6 kV / Basic insulation	
Ambient temperature (operation)	-20 °C ... 60 °C	
Clearance and creepage distances between the power circuits	IEC 60664, EN 50178, IEC 62103	
Pollution degree / Surge voltage category	2 / III	
Connection data solid / stranded / AWG	0.14 - 2.5 mm <sup>2</sup> / 0.14 - 2.5 mm <sup>2</sup> / 26 - 14	
Dimensions	6.2 mm / 80 mm / 94 mm	W / H / D
EMC note	Class A product, see page 625	

**Ordering data**

Description	Type	Order No.	Pcs. / Pkt.
<b>PLC-INTERFACE</b>			
With screw connection	PLC-BSC-TTL/1	2982689	10
With push-in connection	PLC-BPT-TTL/1	2900458	10

**Accessories**

<b>Plug-in solid-state relay</b>			
Solid-state input relay	OPT- 5DC/ 48DC/100	2967992	10
Solid-state power relay	OPT- 5DC/ 24DC/ 2	2967989	10

# Relay modules

## Highly compact relay modules - PLC-INTERFACE

### PLC-INTERFACE for the TTL signal at output

The PLC-OS...24DC/TTL with a built-in solid-state relay can be used for fast and wear-free switching of TTL (5 V) signals.

The module offers the following advantages:

- Switching capacity TTL (5 V), fan out = 1
- 6.2 mm slim overall width
- Bridging options
- Status display
- Integrated protective circuit
- Screw and push-in connection technology

Notes:
Type of housing: Polyester PBT non-reinforced, color: green.
Marking systems and mounting material See Catalog 5



Input solid-state relay with TTL (5 V) output

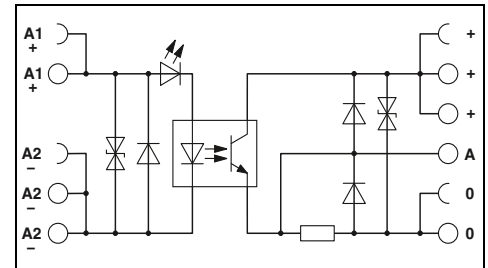

#### Technical data

<b>Input data</b>	
Rated actuating voltage $U_C$	24 V DC
Rated actuating voltage range with reference to $U_C$	0.8 ... 1.2
Switching level 1 signal ("H")	> 0.8
Switching level 0 signal ("L")	< 0.4
Rated actuating current $I_C$	3.4 mA
Typ. switch-on time for $U_C$	35 $\mu$ s
Typ. shutdown time at $U_C$	35 $\mu$ s
Transmission frequency $f_{limit}$	1 kHz
Input circuit DC	Yellow LED, protection against polarity reversal, surge protection
<b>Output data with:</b>	
Rated control supply voltage $U_S$	5 V DC
Rated control supply voltage range with reference to $U_S$	0.9 ... 1.2
Limiting continuous current	A TTL load (Fan out = 1)/50 mA for switching mode
Output protection	Protection against polarity reversal, surge protection
Voltage drop at max. limiting continuous current	< 80 mV
<b>General data</b>	
Rated insulation voltage	250 V DC
Rated surge voltage / insulation	4 kV / basic insulation
Ambient temperature (operation)	-25 °C ... 60 °C
Clearance and creepage distances between the power circuits	IEC 60664, EN 50178, IEC 62103
Pollution degree / surge voltage category	2 / III
Connection data solid / stranded / AWG	0.14 - 2.5 mm <sup>2</sup> / 0.14 - 2.5 mm <sup>2</sup> / 26 - 14
Dimensions	6.2 mm / 80 mm / 86 mm
EMC note	Class A product, see page 625

Derating curve for PLC-OSP...24DC/3RW

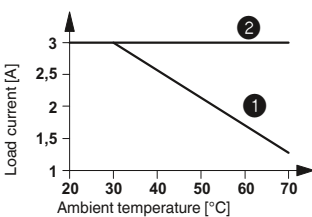

- ① Aligned without spacing
- ② Aligned with  $\geq 20$  mm spacing

Derating curve for PLC-OSP...110DC/3RW

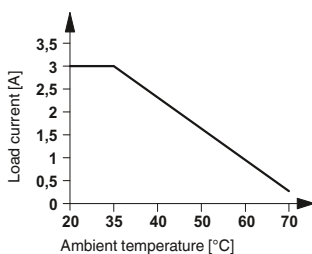

Description	
<b>PLC-INTERFACE</b>	
With screw connection	
With push-in connection	

#### Ordering data

Type	Order No.	Pcs. / Pkt.
PLC-OSC- 24DC/TTL	2982728	10
PLC-OPT- 24DC/TTL	2900363	10

**PLC RELAY with solid-state relays for railway applications**

The PLC-OSP...RW interface modules are intended for use as per DIN EN 50155 (VDE 0115 Part 200) "Railway applications, Part 200: Electronic equipment used on rolling stock".

The advantages:

- Temperature range -25°C to +70°C
- Input voltage range 0.7-1.25 × U<sub>N</sub>
- Shock resistance in acc. with DIN 50155 (requirements in acc. with EN 61373)
- Spring-cage and push-in connection technology



**Power solid-state relay with DC voltage output, max. 3 A**



**Power solid-state relay with DC voltage output, max. 3 A**

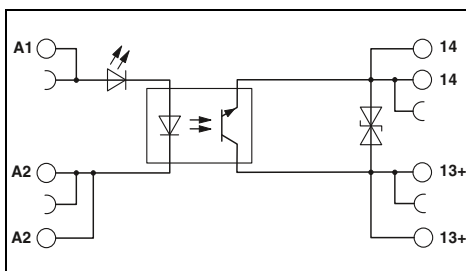

**Technical data**

①	②	③	④	⑤	⑥
0.7 - 1.25	0.7 - 1.25	0.7 - 1.25	0.7 - 1.25	0.7 - 1.25	0.7 - 1.25
≥ 0.6	≥ 0.6	≥ 0.6	≥ 0.6	≥ 0.6	≥ 0.6
≤ 0.3	≤ 0.3	≤ 0.3	≤ 0.3	≤ 0.3	≤ 0.3
8.5	3	8.5	3	8.5	3
0.04	0.08	0.04	0.08	0.04	0.08
0.2	0.6	0.2	0.6	0.2	0.6
300	100	300	100	300	100
Yellow LED, protection against polarity reversal					

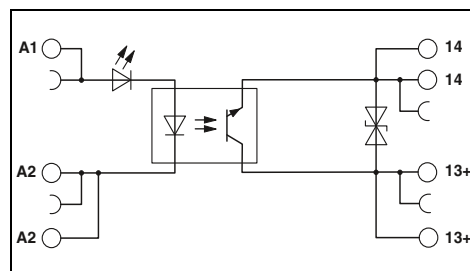

**Technical data**

①	②	③	④	⑤	⑥
0.7 - 1.25	0.7 - 1.25	0.7 - 1.25	0.7 - 1.25	0.7 - 1.25	0.7 - 1.25
> 0.6	> 0.6	> 0.6	> 0.6	> 0.6	> 0.6
< 0.4	< 0.4	< 0.3	< 0.3	< 0.3	< 0.3
12	12	5.5	5.5	5.5	5.5
0.4	0.4	0.04	0.04	0.04	0.4
0.2	0.1	0.2	0.2	0.2	0.2
50	50	300	300	300	300
Yellow LED, protection against polarity reversal, surge protection					

**Notes:**

Type of housing: Polyester PBT non-reinforced, color: green.

Marking systems and mounting material See Catalog 5

For derating curves see page 440

Input data	
Permissible range (with reference to U <sub>N</sub> )	
Switching level (with reference to U <sub>N</sub> )	1 signal ("H") 0 signal ("L")
Typ. input current at U <sub>N</sub>	[mA]
Typ. switch-on time at U <sub>N</sub>	[ms]
Typ. shutdown time at U <sub>N</sub>	[ms]
Transmission frequency f <sub>limit</sub>	[Hz]
Input circuit DC	
Output data	
Max. switching voltage	33 V DC
Min. switching voltage	3 V DC
Limiting continuous current	3 A (see derating curve)
Output protection	Protection against polarity reversal, surge protection
Voltage drop at max. limiting continuous current	< 200 mV
General data	
Rated insulation voltage	250 V
Rated surge voltage	4 kV / basic insulation
Ambient temperature (operation)	-25 °C ... 70 °C
Standards/regulations	IEC 60664, EN 50178, IEC 62103
Pollution degree / surge voltage category	2 / III
Connection data solid / stranded / AWG	
Dimensions	W / H / D
EMC note	

Technical data					
①	⑥				
0.7 - 1.25	0.7 - 1.25				
≥ 0.6	≥ 0.6				
≤ 0.3	≤ 0.3				
8.5	3				
0.04	0.08				
0.2	0.6				
300	100				
Yellow LED, protection against polarity reversal					
Technical data					
①	②	③	④	⑤	⑥
0.7 - 1.25	0.7 - 1.25	0.7 - 1.25	0.7 - 1.25	0.7 - 1.25	0.7 - 1.25
> 0.6	> 0.6	> 0.6	> 0.6	> 0.6	> 0.6
< 0.4	< 0.4	< 0.3	< 0.3	< 0.3	< 0.3
12	12	5.5	5.5	5.5	5.5
0.4	0.4	0.04	0.04	0.04	0.4
0.2	0.1	0.2	0.2	0.2	0.2
50	50	300	300	300	300
Yellow LED, protection against polarity reversal, surge protection					
Technical data					
①	②	③	④	⑤	⑥
0.7 - 1.25	0.7 - 1.25	0.7 - 1.25	0.7 - 1.25	0.7 - 1.25	0.7 - 1.25
> 0.6	> 0.6	> 0.6	> 0.6	> 0.6	> 0.6
< 0.4	< 0.4	< 0.3	< 0.3	< 0.3	< 0.3
12	12	5.5	5.5	5.5	5.5
0.4	0.4	0.04	0.04	0.04	0.4
0.2	0.1	0.2	0.2	0.2	0.2
50	50	300	300	300	300
Yellow LED, protection against polarity reversal, surge protection					
Technical data					
①	②	③	④	⑤	⑥
0.7 - 1.25	0.7 - 1.25	0.7 - 1.25	0.7 - 1.25	0.7 - 1.25	0.7 - 1.25
> 0.6	> 0.6	> 0.6	> 0.6	> 0.6	> 0.6
< 0.4	< 0.4	< 0.3	< 0.3	< 0.3	< 0.3
12	12	5.5	5.5	5.5	5.5
0.4	0.4	0.04	0.04	0.04	0.4
0.2	0.1	0.2	0.2	0.2	0.2
50	50	300	300	300	300
Yellow LED, protection against polarity reversal, surge protection					

Technical data					
①	⑥				
0.7 - 1.25	0.7 - 1.25				
≥ 0.6	≥ 0.6				
≤ 0.3	≤ 0.3				
8.5	3				
0.04	0.08				
0.2	0.6				
300	100				
Yellow LED, protection against polarity reversal					
Technical data					
①	②	③	④	⑤	⑥
0.7 - 1.25	0.7 - 1.25	0.7 - 1.25	0.7 - 1.25	0.7 - 1.25	0.7 - 1.25
> 0.6	> 0.6	> 0.6	> 0.6	> 0.6	> 0.6
< 0.4	< 0.4	< 0.3	< 0.3	< 0.3	< 0.3
12	12	5.5	5.5	5.5	5.5
0.4	0.4	0.04	0.04	0.04	0.4
0.2	0.1	0.2	0.2	0.2	0.2
50	50	300	300	300	300
Yellow LED, protection against polarity reversal, surge protection					
Technical data					
①	②	③	④	⑤	⑥
0.7 - 1.25	0.7 - 1.25	0.7 - 1.25	0.7 - 1.25	0.7 - 1.25	0.7 - 1.25
> 0.6	> 0.6	> 0.6	> 0.6	> 0.6	> 0.6
< 0.4	< 0.4	< 0.3	< 0.3	< 0.3	< 0.3
12	12	5.5	5.5	5.5	5.5
0.4	0.4	0.04	0.04	0.04	0.4
0.2	0.1	0.2	0.2	0.2	0.2
50	50	300	300	300	300
Yellow LED, protection against polarity reversal, surge protection					

Ordering data	
Description	Input voltage U <sub>N</sub>
<b>PLC-INTERFACE, with spring-cage connection</b>	
①	24 V DC
②	36 V DC
③	48 V DC
④	72 V DC
⑤	96 V DC
⑥	110 V DC
<b>PLC-INTERFACE, with push-in connection</b>	
①	24 V DC
②	36 V DC
③	48 V DC
④	72 V DC
⑤	96 V DC
⑥	110 V DC

Ordering data		
Type	Order No.	Pcs. / Pkt.
PLC-OSP- 24DC/ 24DC/ 3RW	2980513	10
PLC-OSP-110DC/ 24DC/ 3RW	2980526	10
PLC-OPT- 24DC/ 24DC/3RW	2900379	10
PLC-OPT-110DC/ 24DC/3RW	2900380	10

Ordering data		
Type	Order No.	Pcs. / Pkt.
PLC-OSP- 24DC/110DC/ 3RW	2982511	10
PLC-OSP- 36DC/110DC/ 3RW	2982524	10
PLC-OSP- 48DC/110DC/ 3RW	2982537	10
PLC-OSP- 72DC/110DC/ 3RW	2982540	10
PLC-OSP- 96DC/110DC/ 3RW	2982553	10
PLC-OSP-110DC/110DC/ 3RW	2982566	10
PLC-OPT- 24DC/110DC/3RW	2900391	10
PLC-OPT- 36DC/110DC/3RW	2900392	10
PLC-OPT- 48DC/110DC/3RW	2900393	10
PLC-OPT- 72DC/110DC/3RW	2900394	10
PLC-OPT- 96DC/110DC/3RW	2900395	10
PLC-OPT-110DC/110DC/3RW	2900396	10

# Relay modules

## Highly compact relay modules - PLC-INTERFACE

### PLC-INTERFACE for railway applications

Relay modules with extended input voltage and temperature range, specifically for use in railway applications

The advantages:

- Temperature range -25°C to +70°C
- Input voltage range 0.7 to 1.25 x UN
- Vibration and shock resistance according to EN 50155
- Safe isolation according to DIN EN 50178 between coil and contact
- Push-in connection technology

Notes:
Type of housing: Polyamide PA non-reinforced, color: green.
Marking systems and mounting material See Catalog 5
Separating plate PLC-ATP must be installed for voltages larger than 250 V (L1, L2, L3) between identical terminal blocks in adjacent modules. Potential bridging is then carried out with FBST 8-PLC... or FBST 500....
If the specified maximum values for multi-layer contact relays are exceeded, the gold plating is destroyed. The maximum values of the power contact relay are then valid. This can result in a shorter service life than with a pure power contact.



Basic terminal block for fitting with 1 PDT relay

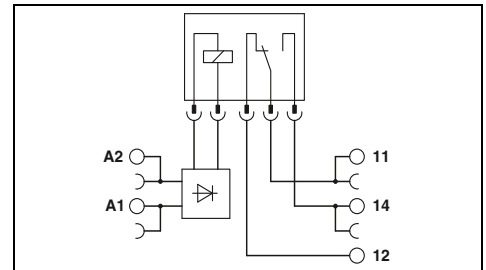

Permitted input voltage range for PLC-BSP-24DC/21RW (with REL-MR-18DC/21... relay)

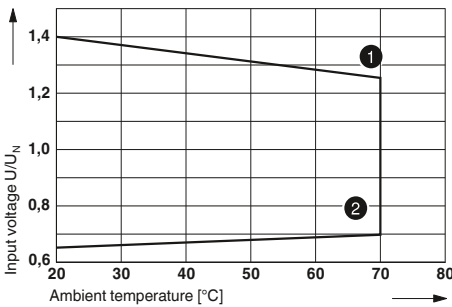

- 1 Maximum continuous voltage at limiting continuous current = 3 A
- 2 Minimum pick-up voltage for pre-excitation with  $U_N$  and limiting continuous current = 3 A

Electrical interrupting rating for PLC...21 with 1 PDT relay

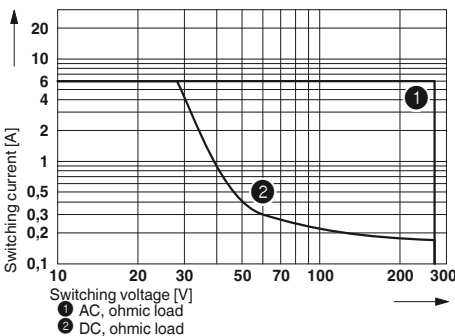

Input data
Nominal input voltage $U_N$
Permissible range (with reference to $U_N$ )
Typ. input current at $U_N$
Typ. response time at $U_N$
Typ. release time at $U_N$
Input circuit
Output data with:
Contact type
Contact material
Max. switching voltage
Min. switching voltage
Limiting continuous current
Max. inrush current
Min. switching current
General data
Test voltage input/output
Ambient temperature (operation)
Mechanical service life
Standards/regulations
Pollution degree / Surge voltage category
Connection data solid / stranded / AWG
Dimensions
EMC note

Technical data	
24 V DC	
See diagram	
12 mA	
5 ms	
8 ms	
Yellow LED, protection against polarity reversal, freewheeling diode	
REL-MR-18DC/21	REL-MR-18DC/21AU
Single contact, 1-PDT	Single contact, 1-PDT
AgSnO	AgSnO, hard gold-plated
250 V AC/DC	30 V AC / 36 V DC
5 V (at 100 mA)	100 mV (at 10 mA)
3 A	50 mA
on request	50 mA
10 mA (at 12 V)	1 mA (at 24 V)
4 kV (50 Hz, 1 min.)	
-25 °C ... 70 °C	
2 x 10 <sup>7</sup> cycles	
IEC 60664, EN 50178, IEC 62103	
3 / III	
0.14 - 2.5 mm <sup>2</sup> / 0.14 - 2.5 mm <sup>2</sup> / 26 - 14	
6.2 mm / 80 mm / 94 mm	
Class A product, see page 625	

Description	Voltage $U_N$
PLC-INTERFACE basic terminal block, for plug-in miniature relay With push-in connection	24 V DC

Plug-in miniature relay
with power contact
with gold contact

Ordering data		
Type	Order No.	Pcs. / Pkt.
PLC-BPT- 24DC/21RW	2900261	10

Accessories		
REL-MR- 18DC/21	2961383	10
REL-MR- 18DC/21AU	2961493	10



**PLC-INTERFACE for railway applications**

Relay module for input voltages with a nominal frequency of 16.7 Hz

The advantages:

- Input nominal frequency 16.7 Hz
- Vibration and shock resistance according to EN 50155
- Safe isolation according to DIN EN 50178 between coil and contact
- Push-in connection technology

<b>Notes:</b>	
Type of housing: Polyamide PA non-reinforced, color: green.	
Marking systems and mounting material See Catalog 5	
Separating plate PLC-ATP must be installed for voltages larger than 250 V (L1, L2, L3) between identical terminal blocks in adjacent modules. Potential bridging is then carried out with FBST 8-PLC... or FBST 500....	
If the specified maximum values for multi-layer contact relays are exceeded, the gold plating is destroyed. The values in parentheses then apply for further operation. This can result in a shorter service life than with a pure power contact.	



For 16.7 Hz input frequency with 2 PDTs

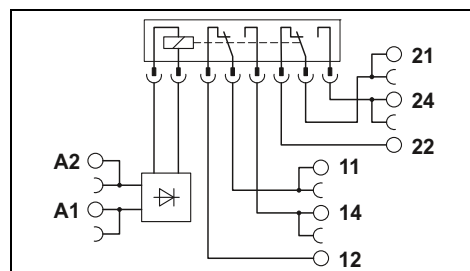

**Technical data**

<b>Input data</b>	
Nominal input voltage $U_N$	230 V AC
Input nominal frequency	16.67 Hz
Permissible range (with reference to $U_N$ )	see diagram
Typ. input current at $U_N$	-
Typ. response time at $U_N$	20 ms
Typ. release time at $U_N$	60 ms
Input circuit	Yellow LED, bridge rectifier
<b>Output data</b>	
Contact type	2 PDT
Contact material	AgNi, hard gold-plated
Max. switching voltage	30 V AC / 36 V DC (250 V AC/DC)
Min. switching voltage	100 mV (5 V AC/DC)
Limiting continuous current	50 mA (6 A)
Max. inrush current	50 mA (8 A)
Min. switching current	1 mA (10 mA)
<b>General data</b>	
Test voltage input/output	6 kV
Ambient temperature (operation)	-25 °C ... 55 °C
Mechanical service life	Approx. $3 \times 10^7$ cycles
Standards/regulations	IEC 60664, EN 50178, IEC 62103
Pollution degree / Surge voltage category	2 / III
Connection data solid / stranded / AWG	0.14 - 2.5 mm <sup>2</sup> / 0.14 - 2.5 mm <sup>2</sup> / 26 - 14
Dimensions	W / H / D 14 mm / 80 mm / 94 mm
EMC note	Class A product, see page 625

Permitted input voltage range for PLC-RSP-230UC/21-21AU/RWF

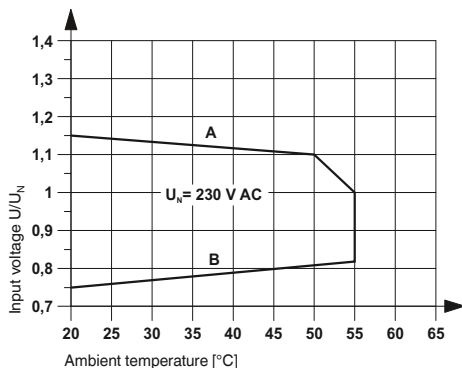

**Curve A**  
Maximum continuous voltage at limiting continuous current = 6 A

**Curve B**  
Minimum pick-up voltage for pre-excitation with  $U_N$  and limiting continuous current = 6 A

Description	Voltage $U_N$	Type	Order No.	Pcs. / Pkt.
<b>PLC-INTERFACE</b> With push-in connection	230 V AC	PLC-RPT-230UC/21-21AU/RWF	2900345	10

# Relay modules

## Highly compact relay modules - PLC-INTERFACE

### PLC-INTERFACE for railway applications

Relay modules with extended input voltage and temperature range, specifically designed for railway applications

The advantages:

- Certified to EN 50155
- Optimum relay operation thanks to wide-range electronics
- Temperature range from -40°C to +70°C (short-term 85°C)
- Input voltage range 0.7 to 1.25 x U<sub>N</sub> (short-term 1.4 x U<sub>N</sub>)
- Vibration and shock resistance according to EN 50155
- Safe isolation according to DIN EN 50178 between coil and contact
- Push-in connection technology

Notes:
Type of housing: Polyamide PA non-reinforced, color: green.
Marking systems and mounting material See Catalog 5
Separating plate PLC-ATP must be installed for voltages larger than 250 V (L1, L2, L3) between identical terminal blocks in adjacent modules. Potential bridging is then carried out with FBST 8-PLC... or FBST 500....
If the specified maximum values for multi-layer contact relays are exceeded, the gold plating is destroyed. The maximum values of the power contact relay are then valid. This can result in a shorter service life than with a pure power contact.
Electrical service life diagrams, see page 426



1 PDT

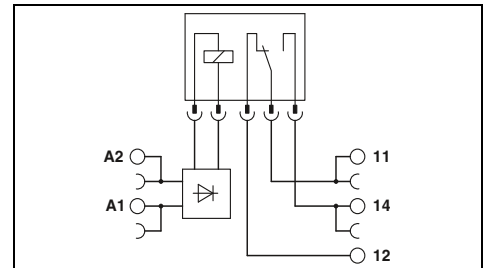

#### Technical data

Input data	①	②	③
Permissible range (with reference to U <sub>N</sub> )	0.7 - 1.25	0.7 - 1.25	0.7 - 1.25
Typ. input current at U <sub>N</sub>	9 [mA]	3	2
Typ. response time at U <sub>N</sub>	4 [ms]	4	4
Typ. release time at U <sub>N</sub>	4 [ms]	4	4
Input protection:	Yellow LED, bridge rectifier, freewheeling diode		
Output data	1 PDT		1 PDT
Contact type	AgSnO		AgSnO, hard gold-plated
Contact material	250 V AC/DC		30 V AC / 36 V DC
Max. switching voltage	5 V (at 100 mA)		100 mV (at 10 mA)
Min. switching voltage	6 A		50 mA
Limiting continuous current	on request		50 mA
Max. inrush current	10 mA (at 12 V)		1 mA (at 24 V)
Min. switching current	General data		
Test voltage (winding/contact)	4 kV <sub>rms</sub> (50 Hz, 1 min.)		
Ambient temperature (operation)	-40 °C ... 70 °C (temperature class TX)		
Mechanical service life	Approx. 2 x 10 <sup>7</sup> cycles		
Standards/regulations	EN 50155 (VDE 0115 part 200), EN 50178, IEC 62103, EN 61373, EN 50121		
Connection data solid / stranded / AWG	0.14 - 2.5 mm <sup>2</sup> / 0.14 - 2.5 mm <sup>2</sup> / 26 - 14		
Dimensions	6.2 mm / 80 mm / 94 mm		
EMC note	Class A product, see page 625		

#### Ordering data

Description	Input voltage U <sub>N</sub>	Type	Order No.	Pcs. / Pkt.
<b>PLC-INTERFACE, with power contact</b>				
With push-in connection	① 24 V DC	PLC-RPT- 24UC/21/RW	2900318	10
	② 72 V DC	PLC-RPT- 72UC/21/RW	2900319	10
	③ 110 V DC	PLC-RPT-110UC/21/RW	2900320	10
<b>PLC-INTERFACE, with hard gold-plated contact</b>				
With push-in connection	① 24 V DC	PLC-RPT- 24UC/21AU/RW	2900321	10
	② 72 V DC	PLC-RPT- 72UC/21AU/RW	2900322	10
	③ 110 V DC	PLC-RPT-110UC/21AU/RW	2900323	10

Highly compact relay modules - PLC-INTERFACE

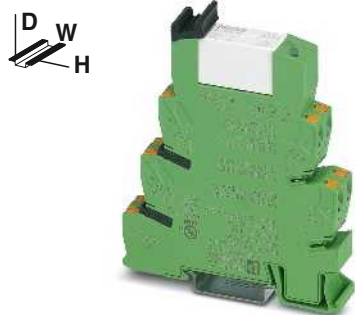

2 PDTs

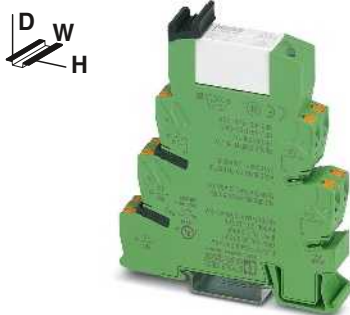

1 PDT up to 10 A

Derating curve for

PLC-RSP...21/RW  
 PLC-RSP...21AU/RW  
 PLC-RSP...21-21/RW  
 PLC-RSP...21-21AU/RW

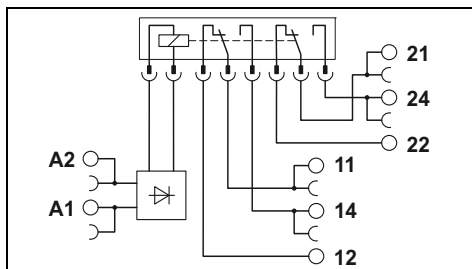
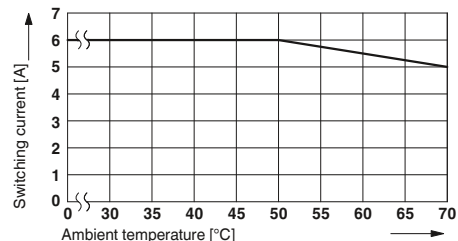

Technical data

①	②	③
0.7 - 1.25	0.7 - 1.25	0.7 - 1.25
20	6	4.5
5	5	5
11	11	11

Yellow LED, bridge rectifier, freewheeling diode

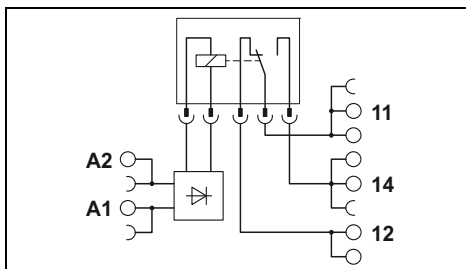

Technical data

①	②	③
0.7 - 1.25	0.7 - 1.25	0.7 - 1.25
20	6	4.5
5	5	5
11	11	11

Yellow LED, bridge rectifier, freewheeling diode

2 PDTs AgNi	2 PDTs AgNi, hard gold-plated
250 V AC/DC 5 V (at 10 mA) 6 A 15 A (300 ms) 10 mA (at 5 V)	30 V AC / 36 V DC 100 mV (at 10 mA) 50 mA 50 mA 1 mA (at 24 V)

5 kV<sub>rms</sub> (50 Hz, 1 min.)  
 -40 °C ... 70 °C (temperature class TX)  
 Approx. 3 x 10<sup>7</sup> cycles  
 EN 50155 (VDE 0115 part 200), EN 50178, IEC 62103, EN 61373, EN 50121  
 0.14 - 2.5 mm<sup>2</sup> / 0.14 - 2.5 mm<sup>2</sup> / 26 - 14  
 14 mm / 80 mm / 94 mm  
 Class A product, see page 625

1 PDT AgNi
250 V AC/DC 12 V (at 10 mA) 10 A (with inserted bridge 2967691) 30 A (300 ms) 10 mA (at 12 V)

5 kV<sub>rms</sub> (50 Hz, 1 min.)  
 -40 °C ... 70 °C (temperature class TX)  
 Approx. 3 x 10<sup>7</sup> cycles  
 EN 50155 (VDE 0115 part 200), EN 50178, IEC 62103, EN 61373, EN 50121  
 0.14 - 2.5 mm<sup>2</sup> / 0.14 - 2.5 mm<sup>2</sup> / 26 - 14  
 14 mm / 80 mm / 94 mm  
 Class A product, see page 625

Ordering data

Type	Order No.	Pcs. / Pkt.
PLC-RPT- 24UC/21-21/RW	2900346	10
PLC-RPT- 72UC/21-21/RW	2900347	10
PLC-RPT-110UC/21-21/RW	2900348	10
PLC-RPT- 24UC/21-21AU/RW	2900349	10
PLC-RPT- 72UC/21-21AU/RW	2900350	10
PLC-RPT-110UC/21-21AU/RW	2900351	10

Ordering data

Type	Order No.	Pcs. / Pkt.
PLC-RPT- 24UC/21HC/RW	2900324	10
PLC-RPT- 72UC/21HC/RW	2900325	10
PLC-RPT-110UC/21HC/RW	2900326	10

Interrupting rating for PLC-RSP...UC/21RW

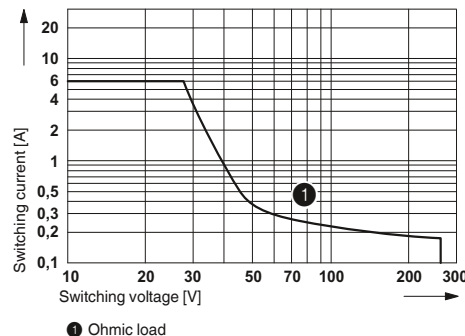

Interrupting rating for PLC-RSP...UC/21-21/RW

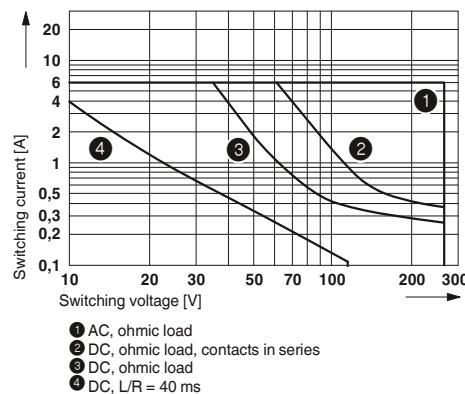

Interrupting rating for PLC-RSP...UC/21HC/RW

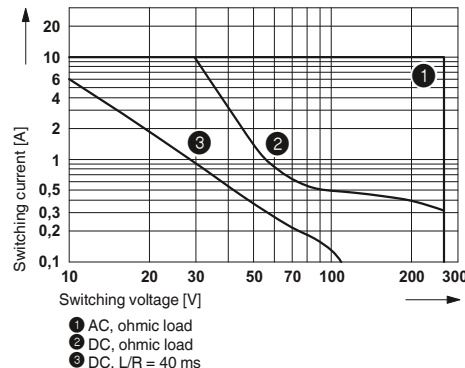

# Relay modules

## Highly compact relay modules - PLC-INTERFACE

### PLC electronic sensor terminal block for NAMUR proximity sensors

The PLC-...-EIK 1-SVN electronic sensor terminal block converts the changeable resistance of a NAMUR sensor unit into a digital signal that can be read by all PLCs.

In addition, the electronics unit monitors the sensor side for short-circuit or open circuit and reports this error via an integrated LED.

Due to a corresponding resistance circuit, the PLC-...-EIK 1-SVN can be used to monitor all mechanical switches (N/C contact or N/O contact) for short-circuit and/or open circuit.

In addition to a high packing density, this switching amplifier features the following:

- Regulated power supply for the NAMUR proximity switch
- 24 V/50 mA digital output for directly connecting programmable logic controls
- Connection option for PLC-V8 adapter
- Screw and push-in connection technology

#### Application 1

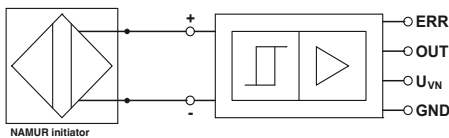

#### Application 2

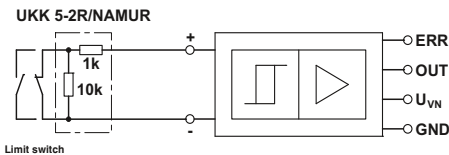

Initiator state	Switching level		LED	
	OUT	ERR	Green	Red
conductive	L	L	OFF	OFF
blocking	H	L	ON	OFF
short circuit	L	H	OFF	ON
open circuit	L	H	OFF	ON

Notes:
Type of housing: Polyamide PA non-reinforced, color: green.
Marking systems and mounting material See Catalog 5
Separating plate PLC-ATP is to be used in the following cases: always at the start and end of a PLC terminal strip, for voltages greater than 250 V (L1, L2, L3) between the same terminal points of neighboring modules (potential bridging then takes place with FBST 8-PLC... or FBST 500...) and with safe isolation between neighboring modules.



For inductive proximity sensors acc. to NAMUR, with light indicators for sensor signal and faults

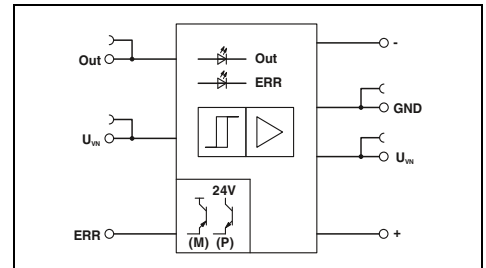

#### Technical data

<b>Supply</b>	Input supply nominal voltage $U_{VN}$ Typ. input current at $U_{VN}$ Transmission frequency $f_{limit}$ Input circuit
<b>Control circuit</b>	No-load voltage Switching points in accordance with EN 60947-5-6:
<b>Protective circuit</b>	Alarm output Operating voltage range (positive switching) Limiting continuous current Voltage drop at max. limiting continuous current Output protection
<b>Signal output</b>	Limiting continuous current Voltage drop $U_R$ at max. limiting continuous current Output protection
<b>General data</b>	Rated insulation voltage Rated surge voltage / insulation Ambient temperature (operation) Standards/regulations Pollution degree / Surge voltage category
<b>Connection data solid / stranded / AWG</b>	
<b>Dimensions</b>	W / H / D
<b>EMC note</b>	

24 V DC  $\pm 20\%$   
approx. 14 mA  
approx. 350 Hz  
Green LED, protection against polarity reversal, surge protection

8.2 V DC  $\pm 10\%$   
 $\geq 2.1$  mA (in conductive state)  
 $\leq 1.2$  mA (in blocking state)  
6.3 mA ... 10 mA (in the event of a short-circuit)  
0 mA ... 0.35 mA (in the event of an open circuit)  
Surge protection

$U_{VN} - U_{Res}$   
50 mA  
 $\leq 1.5$  V ( $U_R$ )  
Red LED, surge protection

50 mA  
 $\leq 1.5$  V ( $U_R$ )  
Surge protection

50 V DC  
0.4 kV / Basic insulation  
-25 °C ... 50 °C  
IEC 60664, EN 50178, IEC 62103  
2 / I

0.14 - 2.5 mm<sup>2</sup> / 0.14 - 2.5 mm<sup>2</sup> / 26 - 12  
6.2 mm / 80 mm / 86 mm  
Class A product, see page 625

#### Ordering data

Type	Order No.	Pcs. / Pkt.
PLC-SC-EIK 1-SVN 24P/P	2982663	10
PLC-PT-EIK 1-SVN 24P/P	2900397	10

#### Accessories

<b>Double-level terminal block, with pre-assembled resistors</b>
With screw connection

<b>UKK 5-2R/NAMUR</b>	2941662	50
-----------------------	---------	----

PLC series

Electronic reversing load relay for DC motors

The PLC-S...-ELR W 1/2-24DC electronic reversing load relays are used to switch mechanically commutated DC motors up to 24 V/2 A.

- Wear-free reversing
- Braking by controlling both inputs
- Short-circuit and surge and overload-proof output
- Integrated locking circuit and load wiring
- Screw-type, spring-cage, and push-in technology

<b>Notes:</b>
Type of housing: Polyester PBT non-reinforced, color: green.
Marking systems and mounting material See Catalog 5
Separating plate PLC-ATP is to be used in the following cases: always at the start and end of a PLC terminal strip, for voltages greater than 250 V (L1, L2, L3) between the same terminal points of neighboring modules (potential bridging then takes place with FBST 8-PLC... or FBST 500...) and with safe isolation between neighboring modules.
For the protection of input and output, inductive loads must be dampened with an effective protection circuit.
PWM = Pulse Width Modulation



With overload and short-circuit-proof output

Application example for PLC-S...ELR W 1/2-24DC

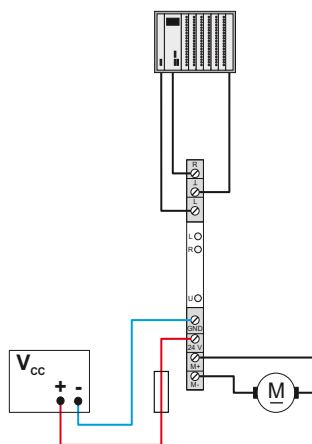

Status table

Input		Output	
Right	Left	M +	M -
0	0	High resistance	High resistance
1	0	+24 V	GND
0	1	GND	+24 V
1	1	GND	GND

Derating curve for PLC-S...ELR W 1/2-24DC

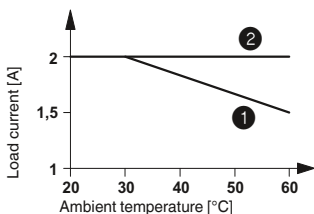

- 1 Aligned without spacing
- 2 Aligned with > 20 mm spacing

<b>Input data</b>	Control voltage $U_{ST}$ right/left Control input current $I_{ST}$ right/left Input protection:
<b>PWM option</b>	Max. clock frequency of the PWM at the control inputs  Pulse width repetition rate of the PWM
<b>Output data</b>	Supply voltage range $U_V$ Quiescent current Output protection
<b>Motor switching output</b>	Continuous current $I_A$ max. Current limitation at short-circuits
<b>General data</b>	Rated insulation voltage Rated surge voltage / insulation Ambient temperature (operation) Standards/regulations Pollution degree / Surge voltage category Mounting position Mounting Connection data solid / stranded / AWG Dimensions EMC note

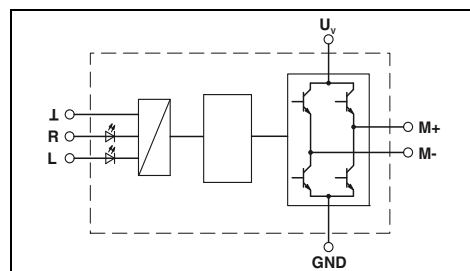

Technical data

24 V DC $\pm 20\%$ approx. 3 mA Yellow LED, protection against polarity reversal, surge protection
1000 Hz
0% ... 100%
10 V DC ... 30 V DC 10 mA Green LED, protection against polarity reversal, surge protection
2 A (see derating curve) 15 A (during braking)
50 V DC 0.5 kV / basic insulation -25 °C ... 60 °C IEC 60664, EN 50178, IEC 62103 2 / II Vertical (horizontal DIN rail) Can be aligned without spacing 0.14 - 2.5 mm <sup>2</sup> / 0.14 - 2.5 mm <sup>2</sup> / 26 - 14 6.2 mm / 80 mm / 86 mm Class A product, see page 625

Ordering data

<b>Description</b>	<b>Type</b>	<b>Order No.</b>	<b>Pcs. / Pkt.</b>
<b>Electronic reversing load relay</b> , for driving DC motors, with light indicator and protection circuit	PLC-SC-ELR W1/ 2-24DC	2980539	1
With screw connection With spring-cage connection	PLC-SP-ELR W1/ 2-24DC	2980555	1

# Relay modules

## Highly compact relay modules - PLC-INTERFACE

### PLC-INTERFACE

#### Pulse expansion module

A solid-state relay for acquiring and extending short pulses.

- Pulse detection can be set from > 0.1 ms or > 2 ms
- Status display
- Delay times of 10 to 2550, can be set via DIP switches
- Bridging options
- Can be retriggered
- Screw and push-in connection technology



With DC voltage output  
Max. 100 mA

ERC

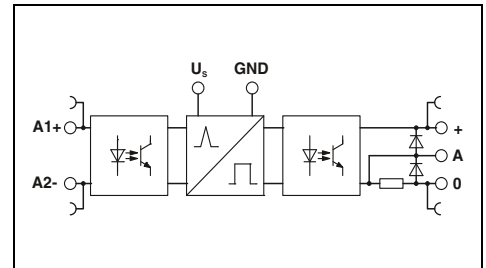

#### Technical data

Input data	
Rated control supply voltage $U_s$	24 V DC
Rated control supply voltage range with reference to $U_s$	0.8 ... 1.2
Rated control supply current $I_s$	
- Input low, output low	13 mA
- Input high, output high	19 mA
Rated actuating voltage $U_c$	24 V DC
Rated actuating current $I_c$	3 mA
Switching threshold "0" signal in reference to $U_c$	< 0.4
Switching threshold "1" signal in reference to $U_c$	> 0.8
Status indication	Yellow LED
Operating voltage display	Green LED
Input circuit	Protection against polarity reversal, surge protection
Output data	
Output voltage range $U_E$	3 V DC ... 48 V DC
Limiting continuous current	100 mA
Voltage drop at max. limiting continuous current	< 1 V DC
Output circuit	3-conductor, ground-referenced
Output protection	Protection against polarity reversal, surge protection, freewheeling
General data	
Rated insulation voltage	50 V DC
Rated surge voltage	0.5 kV
Ambient temperature (operation)	-25 °C ... 60 °C
Standards/regulations	DIN EN 50178
Connection data solid / stranded / AWG	0.14 - 2.5 mm <sup>2</sup> / 0.14 - 2.5 mm <sup>2</sup> / 26 - 14
Dimensions	6.2 mm / 80 mm / 86 mm
EMC note	Class A product, see page 625

#### Ordering data

Description	Type	Order No.	Pcs. / Pkt.
PLC-INTERFACE, with screw connection	PLC-OSC-LPE-24DC/48DC/100	2903171	1
PLC-INTERFACE, with push-in connection	PLC-OPT-LPE-24DC/48DC/100	2903173	1

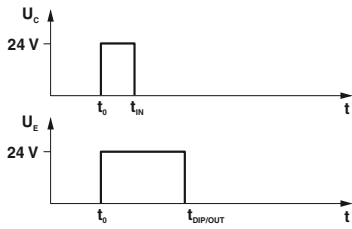

Input pulse  $t_1 <$  set output pulse  $t_3$   
(no restart when triggered again)

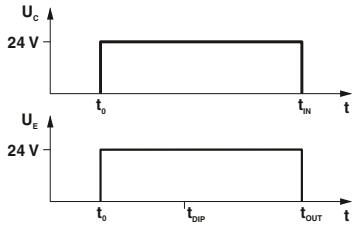

Input pulse  $t_1 \geq$  set output pulse  $t_3$ ,  
then input pulse  $t_1 =$  output pulse  $t_2$   
(no restart when triggered again)

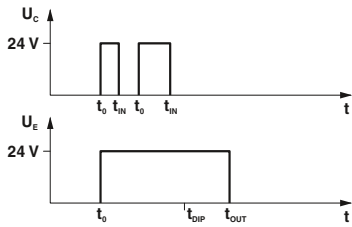

Input pulse  $t_1 <$  set output pulse  $t_3$   
(restart when triggered again)

DIP							
S1	S2	S3	S4	S5	S6	S7	S8
10	-	-	-	-	-	-	-
-	20	-	-	-	-	-	-
-	-	40	-	-	-	-	-
-	-	-	80	-	-	-	-
-	-	-	-	160	-	-	-
-	-	-	-	-	320	-	-
-	-	-	-	-	-	640	-
-	-	-	-	-	-	-	1280



# Relay modules

## Highly compact relay modules - PLC-INTERFACE

### PLC accessories

The **PLC-ESK** power terminal helps in supplying the bridge potentials, the **PLC-ATP** partition plate helps in optical and safe disconnection of the adjacent PLC modules. The **PLC-BP (A1-14)** passive feed-through bridge is used instead of a relay and connects the A1 and 14 terminal points.



Description	Color
<b>Power terminal</b> , for supply of up to four potentials, with the same shape as PLC standard series, max. 32 A/250 V AC	
<b>Separating plate</b> , thickness 2 mm, required at the start and end of a PLC terminal strip. It also serves in visual separation of groups, safe isolation of different voltages of neighboring PLC interfaces as per DIN EN 50178/VDE0160, separation of neighboring bridges of different potentials and separation of PLC interfaces at voltages >250 V	gray
<b>Screwdriver</b> Blade: 0.6 x 3.5 x 100 mm, length: 181 mm	black
<b>Passive feed-through bridge</b> , can be plugged in instead of relay or solid-state relay, bridges terminal points A1 and 14	black

Ordering data		
Type	Order No.	Pcs. / Pkt.
PLC-ESK GY	2966508	5
PLC-ATP BK	2966841	25
SZF 1-0,6X3,5	1204517	10

Ordering data		
Type	Order No.	Pcs. / Pkt.
PLC-BP A1-14	2980283	10

### PLC accessories

The colored isolated FBST jumpers save up to 70% wiring time for PLC-INTERFACE. The 500 mm long **FBST 500-PLC** "continuous bridges" are especially effective. The **FBST 6** 2-pos. individual jumpers are particularly suitable for bridging a smaller number of PLC modules.

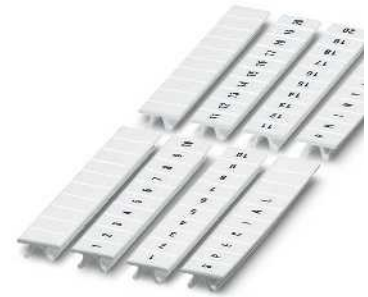
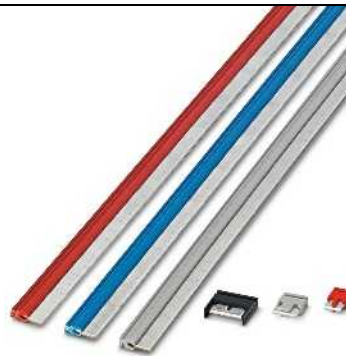

Description	Color
<b>Continuous bridge</b> , 500 mm long, isolated, can be cut to length, for potential distribution Nominal current: 32 A	red blue gray
<b>Jumper</b> , 2-pos., 6 mm long, for potential distribution Nominal current: 6 A	red blue gray
<b>Jumper</b> , 2-pos., 8 mm long, for potential distribution with a partition plate Nominal current: 6 A	gray
<b>Jumper</b> , 2-pos., 14 mm long, insulated, for potential distribution Nominal current: 10 A	black
<b>Zack marker strip, printed horizontally</b> , 10-section, with consecutive numbers, e.g., 1-10, 11-20, etc. up to 91-100	

Ordering data		
Type	Order No.	Pcs. / Pkt.
FBST 500-PLC RD	2966786	20
FBST 500-PLC BU	2966692	20
FBST 500-PLC GY	2966838	20
FBST 6-PLC RD	2966236	50
FBST 6-PLC BU	2966812	50
FBST 6-PLC GY	2966825	50
FBST 8-PLC GY	2967688	50
FBST 14-PLC BK	2967691	50

Ordering data		
Type	Order No.	Pcs. / Pkt.
ZB 6,LGS:FORTL.ZAHLEN	1051016	10

Adapters for PLC-INTERFACE

**PLC-V8/...** are the VARIOFACE adapters which connect the narrow PLC-INTERFACE modules to the VARIOFACE system cabling:

**Notes:**  
For cross-reference list with matching PLC-INTERFACE modules, see page 572

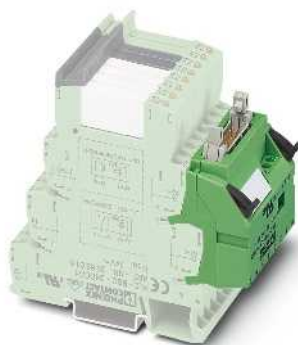

VARIOFACE adapter for 6.2 mm PLC RELAY



VARIOFACE adapter for 14 mm PLC RELAY



Max. perm. operating voltage	30 V DC
Max. perm. current (per branch)	1 A (per signal path)
Max total current (voltage supply)	3 A
Ambient temperature (operation)	-40 °C ... 70 °C
Standards/regulations	IEC 60664, DIN EN 50178, IEC 62103
Connection method	Power supply Screw connection
Connection data solid / stranded / AWG	Signal level IDC/FLK pin strip (2.54 mm)
Dimensions	0.2 ... 4 mm <sup>2</sup> / 0.2 ... 2.5 mm <sup>2</sup> / 24 - 12 100 mm / 94 mm

Technical data	
Max. perm. operating voltage	30 V DC
Max. perm. current (per branch)	1 A (per signal path)
Max total current (voltage supply)	3 A
Ambient temperature (operation)	-40 °C ... 70 °C
Standards/regulations	IEC 60664, DIN EN 50178, IEC 62103
Connection method	Power supply Screw connection
Connection data solid / stranded / AWG	Signal level IDC/FLK pin strip (2.54 mm)
Dimensions	0.2 ... 4 mm <sup>2</sup> / 0.2 ... 2.5 mm <sup>2</sup> / 24 - 12 100 mm / 94 mm

Technical data	
Max. perm. operating voltage	30 V DC
Max. perm. current (per branch)	1 A (per signal path)
Max total current (voltage supply)	3 A
Ambient temperature (operation)	-40 °C ... 70 °C
Standards/regulations	IEC 60664, DIN EN 50178, IEC 62103
Connection method	Screw connection
Connection data solid / stranded / AWG	IDC/FLK pin strip (2.54 mm)
Dimensions	0.2 ... 4 mm <sup>2</sup> / 0.2 ... 2.5 mm <sup>2</sup> / 24 - 12 100 mm / 94 mm

Description	No. of pos.	Module width W
<b>V8 adapter</b> , for 8 PLC interfaces (6.2 mm), with FLK connection, for PLC system cabling, <b>positive switching</b>		
OUTPUT	14	49.6 mm
INPUT	14	49.6 mm
<b>V8 adapter</b> , for 8 PLC interfaces (6.2 mm), with FLK connection, for PLC system cabling, <b>negative switching</b>		
OUTPUT	14	49.6 mm
INPUT	14	49.6 mm
<b>V8 output adapter</b> , for 8 PLC interfaces (6.2 mm), with 15-pos. D-SUB connection		
Pin strip	15	49.6 mm
Socket strip	15	49.6 mm
<b>V8 input adapter</b> , for 8 PLC interfaces (6.2 mm), with 15-pos. D-SUB connection		
Pin strip	15	49.6 mm
Socket strip	15	49.6 mm
<b>V8 adapter</b> , for 8 PLC interfaces (14 mm), with FLK connection, for PLC system cabling, <b>positive switching</b>	14	112.3 mm
<b>V8 adapter</b> , for 8 PLC interfaces (14 mm), with FLK connection, for PLC system cabling, <b>negative switching</b>	14	112.3 mm

Ordering data		
Type	Order No.	Pcs. / Pkt.
PLC-V8/FLK14/OUT	2295554	1
PLC-V8/FLK14/IN	2296553	1
PLC-V8/FLK14/OUT/M	2304102	1
PLC-V8/FLK14/IN/M	2304115	1
PLC-V8/D15S/OUT	2296058	1
PLC-V8/D15B/OUT	2296061	1
PLC-V8/D15S/IN	2296074	1
PLC-V8/D15B/IN	2296087	1

Ordering data		
Type	Order No.	Pcs. / Pkt.
PLC-V8L/FLK14/OUT	2299660	1
PLC-V8L/FLK14/OUT/M	2304306	1

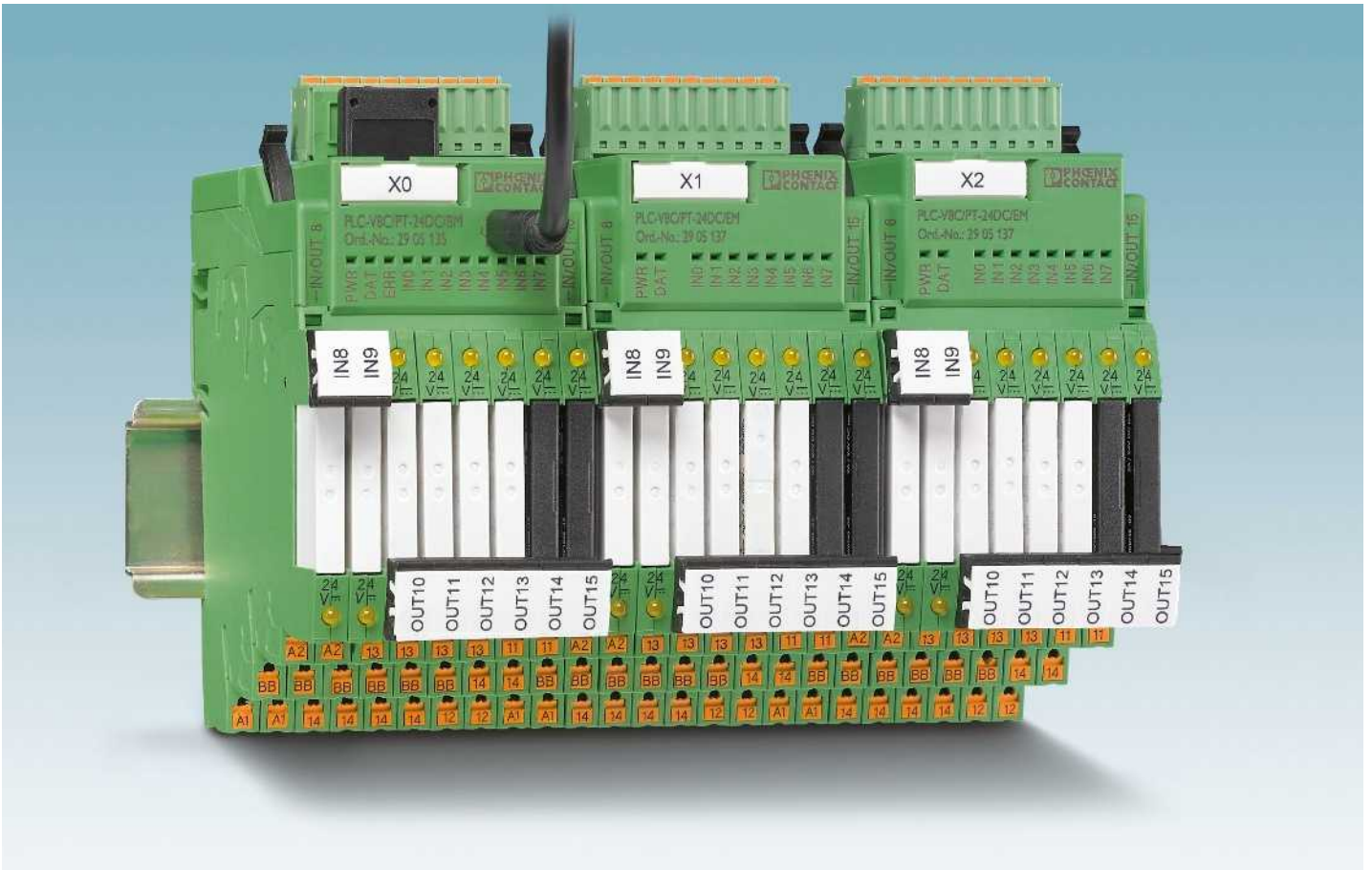

### Extremely compact control

The PLC logic programmable logic relay system is the extremely compact way to carry out small automation tasks easily and flexibly. It consists of the PLC-V8C logic modules, the PLC-INTERFACE relay system, and the LOGIC+ software. The logic modules are simply plugged into a row of eight PLC-INTERFACE terminal blocks and combine the logic and interface level in one unit. Depending on the switching requirements, plug-in electromechanical and solid-state relays can be combined in order to flexibly switch and control the I/O signals.

PLC logic processes digital and analog input signals as well as logic functions and timer modules - and replaces conventional switching and control devices. Up to 16 I/O signals can be processed using the stand-alone logic modules - that's with an overall width of just 50 mm. If more I/O signals are required, a maximum of 48 I/O signals can be linked using the basic and extension modules.

### Switching and controlling with plug-in relays

- PLC logic brings together the standard combination of logic module and separate plug-in relay and eliminates wiring effort and additional switching elements
- Convenient connections with screw or push-in connection technology, which also accommodate return conductors, eliminate the need for separate potential terminal blocks
- Each relay channel can be freely configured as an input or output. PLC logic therefore perfectly adapts to fit the application at hand

### Intuitive programming

Programming is quick and easy with the intuitive LOGIC+ programming software. Ladder (LD) and function block diagrams (FBD) can be created by selecting the relevant functions and their connection using drag & drop. The graphical representation of PLC logic in the hardware editor supports intuitive operation. The programs created can be simulated offline on the PC and tested online during operation. Basic functions, such as AND, OR, NOT, etc. are complemented by special functions, such as counters, seven-day timers, timer modules, and mathematical functions, to name a few.



**Logic module with plug-in relays**

PLC logic combines a logic module and plug-in relay and eliminates wiring effort and additional switching elements. Each relay channel can be flexibly equipped with an electromechanical or a solid-state relay. PLC logic processes 16 I/O signals with just one logic module and boasts an extremely compact overall width of just 50 mm.

**Intuitive programming with LOGIC+**

- Function block diagram or ladder diagram
- Numerous integrated function blocks
- Specific function blocks are available to download
- Hardware view in the program
- Can be downloaded free of charge

**i** Your web code: #0139

**Standard programming cable**

PLC logic is connected to a PC via a standard micro USB cable. The drivers for PLC logic can be downloaded at [phoenixcontact.com](http://phoenixcontact.com).

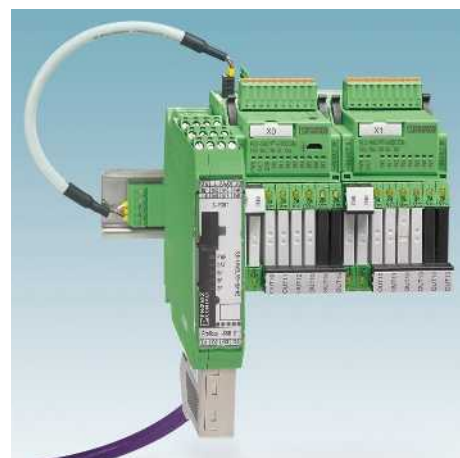

**Easily connect extension modules**

The basic module and the extension module are connected via integrated connectors - no tools required. A maximum of two extension modules can be connected to a basic module. This means that PLC logic can work with up to 48 I/Os.

**Saving and copying data**

PLC logic programs are saved by the memory module or can be easily copied to other devices.

If settings such as time or date are required on the new device, these values can be configured via the integrated web server. The new device does not need access to the LOGIC+ software for this.

**Integration into common bus systems**

PLC logic is integrated into various networks via optional adaptable fieldbus gateways. This enables bidirectional communication with a higher-level controller for remote control as well as diagnostics and visualization.

Gateways are available for transmitting data via PROFIBUS DP, RS-232, RS-485, Modbus/TCP, DeviceNet™, CANopen®, PROFINET, and EtherNet/IP™.



# Relay modules

## Programmable logic relay system - PLC logic

### Logic modules

PLC-V8C are the plug-in logic modules which form the PLC logic relay system in conjunction with the narrow 6.2 mm PLC-INTERFACE terminal blocks. Eight freely-selectable PLC-INTERFACE terminal blocks must be separately ordered for each logic module. You can find an overview of matching PLC-INTERFACE terminal blocks on page 458.

All logic modules feature these properties:

- 8 integrated digital inputs (of which two inputs are configurable as analog inputs), connection via connector with screw or push-in connection technology
- A further 8 channels can be configured with matching PLC-INTERFACE terminal blocks as digital inputs or outputs
- Programming with the LOGIC+ software

#### PLC-V8C.../SAM

- Stand-alone logic module with 16 I/Os, not extendable
- Connection to PC via micro USB socket
- Integrated realtime clock (RTC)
- Accommodates external IFS-CONFSTICK memory module

#### PLC-V8C.../BM

- Basic logic module with 16 I/Os, can be extended with a maximum of two extension modules (PLC-V8C.../EM) to 48 I/Os
- Connection to PC via micro USB socket
- Integrated realtime clock (RTC)
- Accommodates external IFS-CONFSTICK memory module
- Optional connection to IFS gateways

#### PLC-V8C.../EM

- Extension logic module with 16 I/Os, for extending the basic module



Stand-alone module

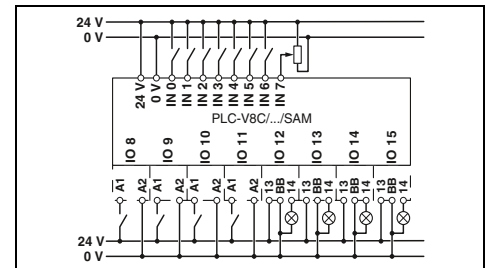

#### Technical data

Supply	24 V DC
Supply voltage	19.2 V DC ... 26.4 V DC
Supply voltage range	120 mA
Max. input current at $U_N$	
Input data (digital)	
Number of inputs	8 (2 configurable as analog)
Input voltage	24 V DC
Description of the input	EN 61131-2, type 3
Input current 0-signal	< 1 mA
Input current 1-signal	typ. 2.5 mA
Input data (analog)	
Number of inputs	2 (IN6 and IN7 are configurable as analog)
Input voltage range	0 V ... 10 V
Input resistance	> 3.5 kΩ
Input data (PLC-INTERFACE)	
Number of inputs	≤ 8
Output data (for controlling PLC-INTERFACE)	
Number of outputs	≤ 8
Nominal voltage	24 V DC
Nominal current	9 mA
Realtime clock (basic module only)	
Buffer time (capacitor)	24 h (capacitor)
Realtime clock accuracy	±2 s/d
General data	
Ambient temperature (operation)	-20 °C ... 45 °C
Ambient temperature (storage/transport)	-20 °C ... 70 °C
Permissible humidity (operation)	95 %
Clearance and creepage distances between the power circuits	DIN EN 50178
Rated insulation voltage	50 V
Rated surge voltage	0.8 kV
Insulation	Basic insulation
Mounting type	Can be plugged onto 8 x PLC-INTERFACE
Degree of protection	IP20
Screw connection solid / stranded / AWG	0.14 - 1.5 mm <sup>2</sup> / 0.14 - 1.5 mm <sup>2</sup> / 28 - 16
Push-in connection solid / stranded / AWG	0.14 - 1.5 mm <sup>2</sup> / 0.14 - 1.5 mm <sup>2</sup> / 26 - 16

#### Ordering data

Description	Type	Order No.	Pcs. / Pkt.
<b>PLC-V8C plug-in logic modules</b>			
With screw connection	PLC-V8C/SC-24DC/SAM	2905082	1
With push-in connection	PLC-V8C/PT-24DC/SAM	2905136	1



Basic module



Extension module

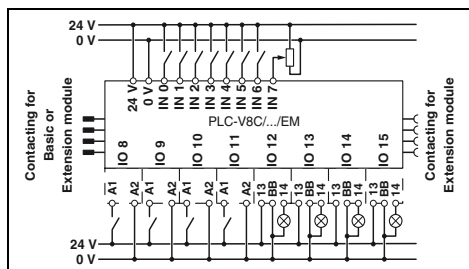
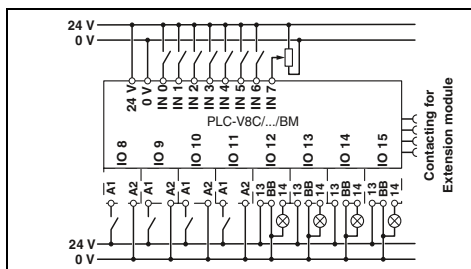

Technical data

24 V DC  
19.2 V DC ... 26.4 V DC  
120 mA

8 (2 configurable as analog)  
24 V DC  
EN 61131-2, type 3  
< 1 mA  
typ. 2.5 mA

2 (IN6 and IN7 are configurable as analog)

0 V ... 10 V  
> 3.5 kΩ

≤ 8

≤ 8  
24 V DC  
9 mA

24 h (capacitor)  
±2 s/d

-20 °C ... 45 °C  
-20 °C ... 70 °C  
95 %  
DIN EN 50178

50 V  
0.8 kV  
Basic insulation  
Can be plugged onto 8 x PLC-INTERFACE  
IP20  
0.14 - 1.5 mm<sup>2</sup> / 0.14 - 1.5 mm<sup>2</sup> / 28 - 16  
0.14 - 1.5 mm<sup>2</sup> / 0.14 - 1.5 mm<sup>2</sup> / 26 - 16

Technical data

24 V DC  
19.2 V DC ... 26.4 V DC  
65 mA

8 (2 configurable as analog)  
24 V DC  
EN 61131-2, type 3  
< 1 mA  
typ. 2.5 mA

2 (IN6 and IN7 are configurable as analog)

0 V ... 10 V  
> 3.5 kΩ

≤ 8

≤ 8  
24 V DC  
9 mA

-

-20 °C ... 45 °C  
-20 °C ... 70 °C  
95 %  
DIN EN 50178

50 V  
0.8 kV  
Basic insulation  
Can be plugged onto 8 x PLC-INTERFACE  
IP20  
0.14 - 1.5 mm<sup>2</sup> / 0.14 - 1.5 mm<sup>2</sup> / 28 - 16  
0.14 - 1.5 mm<sup>2</sup> / 0.14 - 1.5 mm<sup>2</sup> / 26 - 16

Ordering data

Type	Order No.	Pcs. / Pkt.
PLC-V8C/SC-24DC/BM	2903094	1
PLC-V8C/PT-24DC/BM	2905135	1

Ordering data

Type	Order No.	Pcs. / Pkt.
PLC-V8C/SC-24DC/EM	2903095	1
PLC-V8C/PT-24DC/EM	2905137	1

# Relay modules

## Programmable logic relay system - PLC logic

### Accessories

#### Programming cable and memory module

- The programming cable (MICRO USB B to USB A) is used to connect PLC logic to a PC, length: 2 m
- PLC logic programs are saved by the memory module or can be easily copied to other devices



General data		Technical data			Technical data		
EMC note					Class A product, see page 625		
Description		Ordering data			Ordering data		
	Color	Type	Order No.	Pcs. / Pkt.	Type	Order No.	Pcs. / Pkt.
Programming cable		CAB-USB A/MICRO USB B/2,0M	2701626	1			
Multifunctional memory module for the INTERFACE system					IFS-CONFSTICK	2986122	1
- Flat design							

### Accessories

#### PLC logic starter kit

The PLC logic starter kit contains all the components needed to get started quickly and easily with PLC logic with push-in connection technology and 8 inputs and 8 outputs.

- PLC-V8C-PT/24DC/BM plug-in logic module
- PLC-RPT-24DC/1/ACT eight relay output terminal blocks
- Micro USB programming cable
- LOGIC+ software
- "PLC logic quick start guide" poster



Description		Ordering data		
	Color	Type	Order No.	Pcs. / Pkt.
PLC logic starter kit 1, 8 integrated inputs (24 V DC) and 8 outputs via PLC-INTERFACE (switching capacity 250 V AC/DC, max. 6 A)		PLC-LOGIC-STARTERKIT1	2905504	1



**Accessories**  
**IFS gateways**

The gateways are connected to the PLC-V8C.../BM PLC logic basic modules via the ME 22,5 TBUS... DIN rail connector and the PLC-V8C/CAB... connecting cable.

The gateways are connected to a PC and configured via the integrated S-PORT interface and the IFS-USB-DATACABLE.



		Technical data			Technical data		
General data							
EMC note		Class A product, see page 625					
		Ordering data			Ordering data		
Description	Color	Type	Order No.	Pcs. / Pkt.	Type	Order No.	Pcs. / Pkt.
<b>IFS gateway</b> for PROFIBUS DP	green	EM-PB-GATEWAY-IFS	2297620	1			
RS-232	green	EM-RS232-GATEWAY-IFS	2901526	1			
RS-485	green	EM-RS485-GATEWAY-IFS	2901527	1			
Modbus/TCP	green	EM-MODBUS-GATEWAY-IFS	2901528	1			
DeviceNet™	green	EM-DNET-GATEWAY-IFS	2901529	1			
CANopen®	green	EM-CAN-GATEWAY-IFS	2901504	1			
PROFINET	green	EM-PNET-GATEWAY-IFS	2904472	1			
Ethernet/IP™	green	EM-ETH-GATEWAY-IFS	2901988	1			
<b>Programming adapter</b> for configuring modules with S-PORT interface Cable length: 3 m		IFS-USB-DATACABLE	2320500	1			
<b>DIN rail connector</b>	green	ME 22,5 TBUS 1,5/ 5-ST-3,81 GN	2707437	50			
<b>Connecting cable</b> for connecting PLC logic with the ME 22,5 TBUS DIN rail connector, cable length: 0.3 m					PLC-V8C/CAB/TBUS/0,3M	2905263	1

# Relay modules

## Programmable logic relay system - PLC logic

### Selection table for PLC-INTERFACE

Relay output	Push-in connection		Screw connection	
	Type	Order No.	Type	Order No.
1 PDT, output data 6 A, 250 V AC/DC	PLC-RPT-24DC/21	2900299	PLC-RSC-24DC/21	2966171
1 PDT, output data 50 mA, 36 V DC, gold contact	PLC-RPT-24DC/21AU	2900306	PLC-RSC-24DC/21AU	2966265
1 N/O contact, output data 6 A, 250 V AC/DC, actuator type	PLC-RPT-24DC/1/ACT	2900312	PLC-RSC-24DC/1/ACT	2966210
1 N/O contact with switch, output data 6 A, 250 V AC/DC	PLC-RPT-24UC/1/S/H	2900328	PLC-RSC-24UC/1/S/H	2982236
<b>Solid-state relay output</b>				
Output data 100 mA, 3 V DC - 48 V DC	PLC-OPT-24DC/48DC/100	2900352	PLC-OSC-24DC/48DC/100	2966728
Output data 3 A, 3 V DC - 33 V DC	PLC-OPT-24DC/24DC/2	2900364	PLC-OSC-24DC/24DC/2	2966634
Output data 750 mA, 24 V AC - 253 V AC	PLC-OPT-24DC/230AC/1	2900369	PLC-OSC-24DC/230AC/1	2967840
Output data 3 A, 3 V DC - 33 V DC, actuator type	PLC-OPT-24DC/24DC/2/ACT	2900376	PLC-OSC-24DC/24DC/2/ACT	2966676
Output data 750 mA, 24 V AC - 253 V AC, actuator type			PLC-OSC-24DC/230AC/1/ACT	2967947
Output data 1 A, 12 V DC - 300 V DC	PLC-OPT-24DC/300DC/1	2900383	PLC-OSC-24DC/300DC/1	2980678
Output data 10 A, 3 V DC - 33 V DC	PLC-OPT-24DC/24 DC/10/R	2900398	PLC-OSC-24DC/24DC/10/R	2982702
Output data 500 mA, 3 V DC - 48 V DC, electronic PDT	PLC-OPT-24DC/48DC/500/W	2900378	PLC-OSC-24DC/48DC/500/W	2980636
Output data, TTL, 50 mA, 5 V DC	PLC-OPT-24DC/TTL	2900363	PLC-OSC-24DC/TTL	2982728
<b>Relay input</b>				
Input voltage 24 V DC	PLC-RPT-24DC/1AU/SEN	2900313	PLC-RSC-24DC/1AU/SEN	2966317
Input voltage 120 V AC/DC	PLC-RPT-120UC/1AU/SEN	2900314	PLC-RSC-120UC/1AU/SEN	2966320
Input voltage 230 V AC/DC	PLC-RPT-230UC/1AU/SEN	2900315	PLC-RSC-230UC/1AU/SEN	2966333
Input voltage 5 V DC (basic terminal block without relay)			PLC-BSC- 5DC/ 1/SEN	2980267
Relay for 5 V DC basic terminal block			REL-MR-4,5DC/21AU	2961370
<b>Solid-state relay input</b>				
Input voltage 24 V DC	PLC-OPT-24DC/48DC/100/V8C/SEN	2904693	PLC-OSC-24DC/48DC/100/V8C/SEN	2904690
Input voltage 120 V AC/DC	PLC-OPT-120UC/48DC/100/V8C/SEN	2904694	PLC-OSC-120UC/48DC/100/V8C/SEN	2904691
Input voltage 230 V AC/DC	PLC-OPT-230UC/48DC/100/V8C/SEN	2904695	PLC-OSC-230UC/48DC/100/V8C/SEN	2904692
<b>Dummy or reserve</b>				
Basic terminal blocks output	PLC-BPT-24DC/21	2900445	PLC-BSC-24DC/21	2966016
Basic terminal blocks input	PLC-BPT-24DC/1/SEN	2900262	PLC-BSC-24DC/1/SEN	2966061

## LOGIC+ programming software

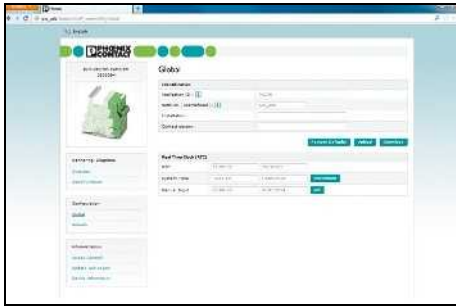

### Integrated web server

PLC logic basic settings are easily configured via the integrated web server. The LOGIC+ software does not need to be installed in order to do so.

- Time and date
- Password and access control
- Firmware update
- Status indicators for inputs and outputs
- General device information

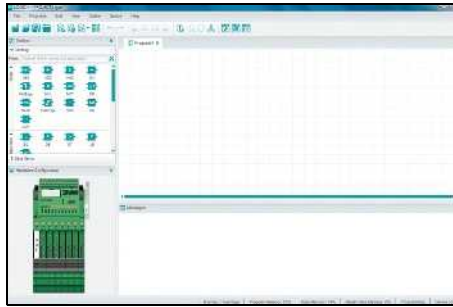

### LOGIC+ user interface

- Clear separation in program editor, toolbox, hardware view, and signaling window
- All elements can be easily placed using drag & drop
- Notes and errors are highlighted in color in the program editor



### Hardware configurator

- Each relay channel can be configured as an input or output with an electromechanical or a solid-state relay
- Clear assignment of the inputs and outputs thanks to the graphical representation of the hardware connections

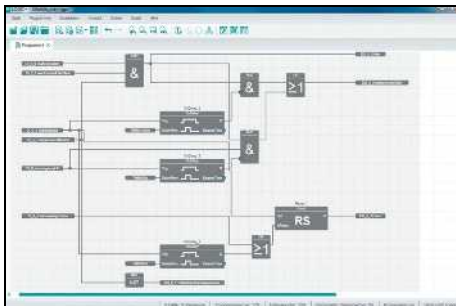

### Function blocks

- Basic functions: AND, OR, NOT, XOR
- Mathematical functions: add, divide, multiply, subtract, generate absolute value
- Positive and negative edge detection
- RS and SR flip-flops
- Switch-on and switch-off delay, pulse encoder, pulse stretching, weekly clock timer
- Up and down counter
- Analog and digital comparators
- Special functions, e.g., solar altitude calculations are available for download

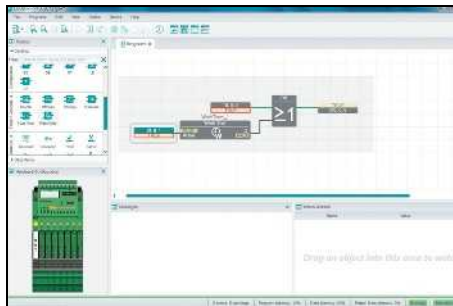

### Simulation and online values

- Offline simulation:
  - Simulation of the created program directly in LOGIC+
  - Virtualization of the values in the program editor, hardware view, and in the observation window
- Online values:
  - Representation of the program running on the hardware in LOGIC+ with online values
  - Overwriting of values from LOGIC+

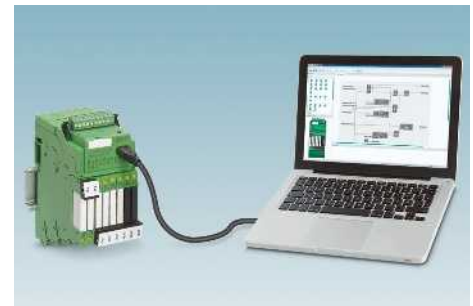

### Example programs

Numerous application examples make it easy to get started with LOGIC+. These include:

- Underground garage ventilation
- Conveyor belt
- Pumping plant
- Two-way control
- Tips for creating shift registers or surge relays

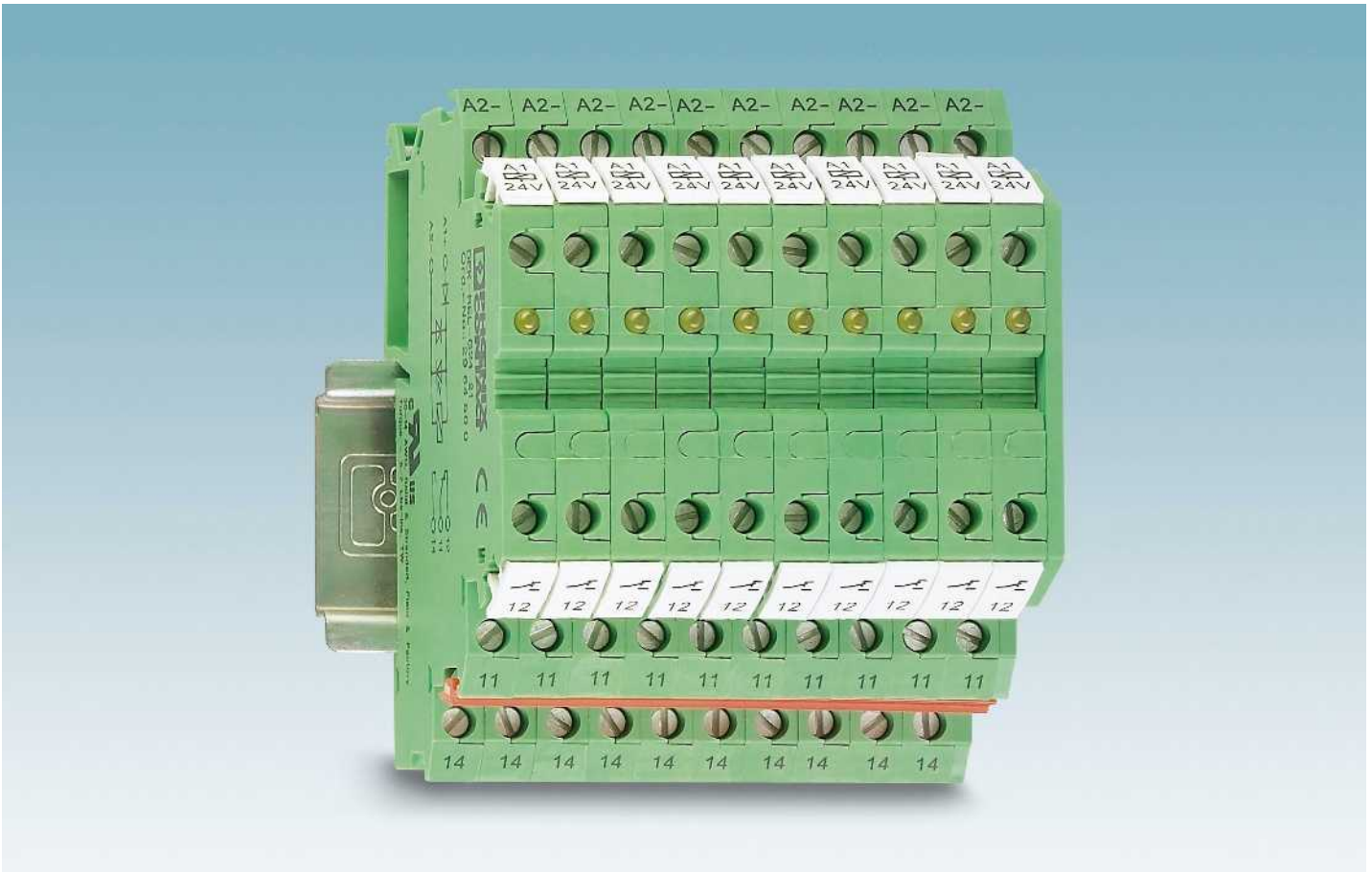

The DEK interface terminal blocks from Phoenix Contact provide complete interface functions in modular terminal block housing that is just 6.2 mm wide. In conjunction with standard terminal block accessories, these high capacity interfaces have not only the design but also the high level of user convenience of modular terminal blocks.

The main common feature of all Phoenix Contact interface terminal blocks is their width of just 6.2 mm. This saves 60% space in the control cabinet in comparison to conventional 15 mm wide coupling relays from modular systems.

The DEK range offers the best solution for all industrial voltages both for signal input and output.

High switching capacities are a matter of course for the DEK-REL... relay terminal block and the DEK-OV... solid-state relay terminal block.

The DEK-OV... wear-free power solid-state relay terminal block is used for applications that require a greater switching frequency in which electromechanical relays reach the end of their service life in a short time.

Integrated LEDs clearly indicate the switching status of the electronic terminal blocks and provide an excellent overview of the coupling level and the system.

EB-DIK colored insertion bridges for the supply and ground signals make it possible to design the circuit simply and effectively.

Integrated protective circuits such as freewheeling diodes, polarity reversal protection diodes, and surge protection elements protect the coupling modules and ensure optimum availability of the system.

**DEK-REL-... relay terminal block**

The Phoenix relay terminal block with PDT contact offers the following advantages:

- Width of just 6.2 mm
- High switching capacity of 250 V AC / 6 A
- Less storage, since PDT, N/O or N/C contacts can be wired
- Minimal wiring effort due to the use of EB-DIK insertion bridges
- IP67 protected relay housing
- Cadmium-free relay contacts
- 4 kV electrical isolation of input and output
- Safe isolation in acc. with DIN EN 50178 (VDE 0160)
- Light indicator for indicating the switching status

<b>Notes:</b>
Type of housing: Polyamide PA non-reinforced, color: green.
Marking systems and mounting material See Catalog 5
For the protection of relay coils and contacts, inductive loads must be dampened with an efficient protection circuit.
For other EB...DIK... insertion bridges refer to page 467



For medium to large loads  
1 PDT (21)

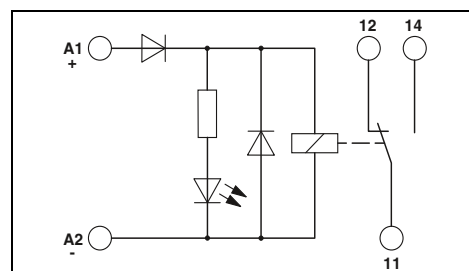

**Technical data**

<b>Input data</b>	①
Permissible range (with reference to $U_N$ )	0.8 - 1.1
Typ. input current at $U_N$ [mA]	9
Response/release time at $U_N$ [ms]	8 / 5
Input protection:	Yellow LED, protection against polarity reversal, freewheeling diode
<b>Output data</b>	
Contact type	1 PDT
Contact material	AgSnO
Max. switching voltage	250 V AC/DC
Min. switching voltage	12 V AC/DC
Limiting continuous current	6 A
Max. inrush current	6 A
Min. switching current	10 mA
Max. interrupting rating, ohmic load	
	24 V DC 140 W
	48 V DC 20 W
	60 V DC 18 W
	110 V DC 23 W
	220 V DC 40 W
	250 V AC 1500 VA
<b>General data</b>	
Test voltage (winding/contact)	4 kV AC (50 Hz, 1 min.)
Ambient temperature (operation)	-20 °C ... 50 °C
Mechanical service life	Approx. 10 <sup>7</sup> cycles
Standards/regulations	IEC 60664, EN 50178, IEC 62103
Connection data solid / stranded / AWG	0.2 - 2.5 mm <sup>2</sup> / 0.2 - 2.5 mm <sup>2</sup> / 24 - 14
Dimensions W / H / D	6.2 mm / 80 mm / 56 mm
EMC note	Class A product, see page 625

**Ordering data**

Description	Input voltage $U_N$	Type	Order No.	Pcs. / Pkt.
Relay terminal block with power relay	① 24 V DC	DEK-REL-G24/21	2964500	10

**Accessories**

Cover	No. of pos.	Color	D-DEK 1,5 GN	2716949	10	
Insertion bridge, for middle and lower levels	80	blue	EB 80- DIK BU	26 A	2715940	1
	80	red	EB 80- DIK RD	26 A	2715953	1
	80	white	EB 80- DIK WH	26 A	2715788	1

# Relay modules

## Relay modules in terminal block design - DEK series

### DEK-REL-24/1/SEN input interface and DEK-REL-24/1/AKT output interface

In addition to the familiar advantages of the DEK-REL... electronic terminal blocks, such as:

- 2-layer contact with hard gold-plating for universal applications from 1 mA to 5 A continuous current
- 2 kV<sub>rms</sub> electrical isolation of input and output
- Integrated input circuit

With this terminal block, "ALL" connections for a sensor or actuator are provided over a width of just 6.2 mm!

This means that 16 outputs take up a total overall width of just 105.4 mm (including the power terminal).

#### Advantages:

- Lower costs as the N terminal block is no longer required
- Wiring is reduced to a minimum
- Up to 73% more space

Notes:	
Type of housing:	Polyamide PA non-reinforced, color: green.
Marking systems and mounting material	See Catalog 5
For the protection of relay coils and contacts, inductive loads must be dampened with an efficient protection circuit.	
For other EB...DIK... insertion bridges refer to page 467	

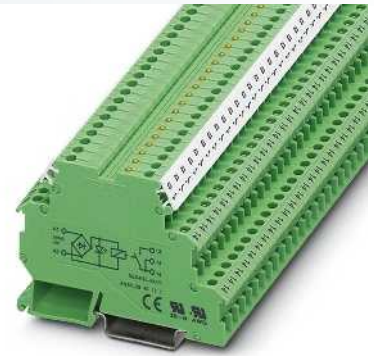

for small to medium loads  
1 N/O contact (1)

ERC

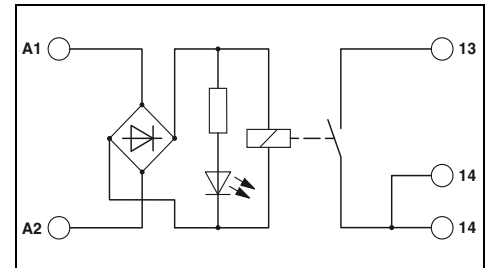

#### Technical data

Input data		①	②
Permissible range (with reference to U <sub>N</sub> )		0.9 - 1.1	0.8 - 1.1
Typ. input current at U <sub>N</sub>	[mA]	23	6.5
Response/release time at U <sub>N</sub>	[ms]	8 / 15	5 / 15
Input protection:		Yellow LED, bridge rectifier	
Output data			
Contact type		1 N/O contact (double contact)	
Contact material		AgNi, hard gold-plated	
Max. switching voltage		250 V AC / 125 V DC	
Min. switching voltage		0.1 V	
Limiting continuous current		3 A (5 A up to 35°C at 24 V DC)	
Max. inrush current		5 A	
Min. switching current		1 mA	
Max. interrupting rating, ohmic load		24 V DC	72 W
		48 V DC	60 W
		60 V DC	50 W
		110 V DC	50 W
		250 V AC	750 VA
General data			
Test voltage (winding/contact)		2 kV AC (50 Hz, 1 min.)	
Ambient temperature (operation)		-20 °C ... 50 °C	
Mechanical service life		Approx. 2 x 10 <sup>7</sup> cycles	
Standards/regulations		IEC 60664, EN 50178, IEC 62103	
Connection data solid / stranded / AWG		0.2 - 2.5 mm <sup>2</sup> / 0.2 - 2.5 mm <sup>2</sup> / 24 - 14	
Dimensions		W / H / D	
EMC note		Class A product, see page 625	

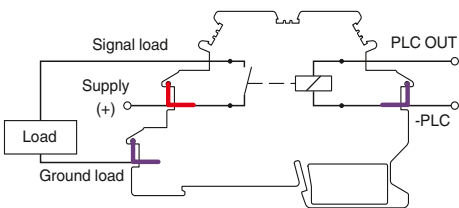

Pin configuration, DEK-REL...AKT

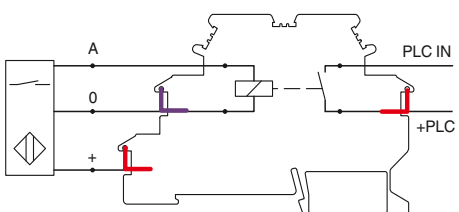

Pin configuration DEK-REL...SEN

Description	Input voltage U <sub>N</sub>
Relay terminal block with miniature relay	① 5 V AC/DC ② 24 V AC/DC

Terminal block, with three through contacts, for mounting on NS 35... For busbar feeding			
Cover			
Insertion bridge, for middle and lower levels	No. of pos.	Color	
	80	blue	
	80	red	
	80	white	

#### Ordering data

Type	Order No.	Pcs. / Pkt.
DEK-REL- 5/I/1	2941183	10
DEK-REL- 24/I/1	2940171	10

#### Accessories

D-DEK 1,5 GN		2716949	10
EB 80- DIK BU	26 A	2715940	1
EB 80- DIK RD	26 A	2715953	1
EB 80- DIK WH	26 A	2715788	1



Relay modules in terminal block design - DEK series

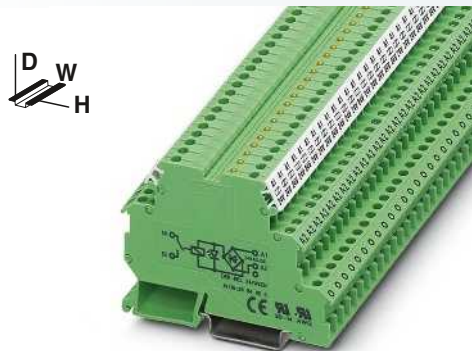

for small to medium loads  
1 N/O contact (1)

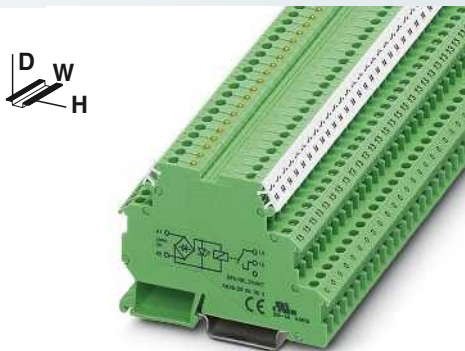

for small to medium loads  
1 N/O contact (1)

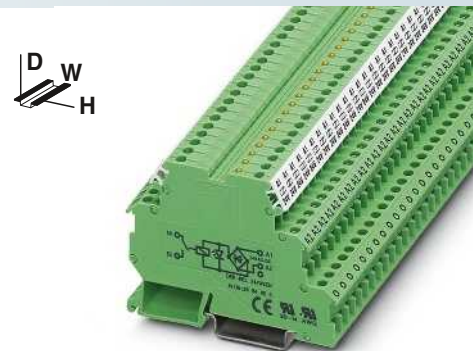

for small to medium loads  
1 N/O contact (1)

ERC

ERC

ERC

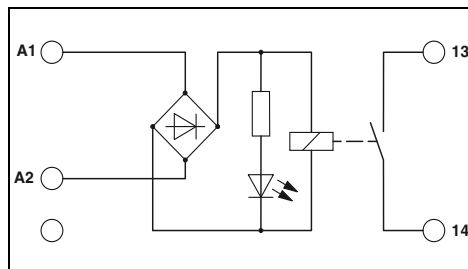
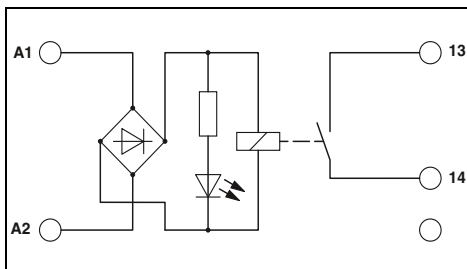
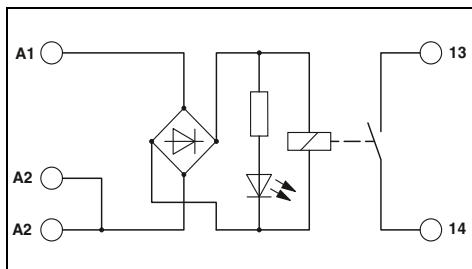

Technical data

Technical data

Technical data

① 0.9 - 0.8 -  
1.1 1.1  
23 6.5  
8 / 15 5 / 15  
Yellow LED, bridge rectifier

② 0.8 -  
1.1  
6.5  
5 / 15  
Yellow LED, bridge rectifier

② 0.8 -  
1.1  
6.5  
5 / 15  
Yellow LED, bridge rectifier

1 N/O contact (double contact)  
AgNi, hard gold-plated  
250 V AC / 125 V DC  
0.1 V  
3 A (5 A up to 35°C at 24 V DC)  
5 A  
1 mA

1 N/O contact  
AgNi, hard gold-plated  
250 V AC / 125 V DC  
0.1 V  
3 A (5 A up to 35°C at 24 V DC)  
5 A  
1 mA

1 N/O contact  
AgNi, hard gold-plated  
250 V AC / 125 V DC  
0.1 V  
3 A (5 A up to 35°C at 24 V DC)  
5 A  
1 mA

72 W  
60 W  
50 W  
50 W  
750 VA

72 W  
60 W  
50 W  
50 W  
750 VA

72 W  
60 W  
50 W  
50 W  
750 VA

2 kV AC (50 Hz, 1 min.)  
-20 °C ... 50 °C  
Approx. 2 x 10<sup>7</sup> cycles  
IEC 60664, EN 50178, IEC 62103  
0.2 - 2.5 mm<sup>2</sup> / 0.2 - 2.5 mm<sup>2</sup> / 24 - 14  
6.2 mm / 80 mm / 56 mm  
Class A product, see page 625

2 kV AC (50 Hz, 1 min.)  
-20 °C ... 50 °C  
Approx. 2 x 10<sup>7</sup> cycles  
IEC 60664, EN 50178, IEC 62103  
0.2 - 2.5 mm<sup>2</sup> / 0.2 - 2.5 mm<sup>2</sup> / 24 - 14  
6.2 mm / 80 mm / 56 mm  
Class A product, see page 625

2 kV AC (50 Hz, 1 min.)  
-20 °C ... 50 °C  
Approx. 2 x 10<sup>7</sup> cycles  
IEC 60664, EN 50178, IEC 62103  
0.2 - 2.5 mm<sup>2</sup> / 0.2 - 2.5 mm<sup>2</sup> / 24 - 14  
6.2 mm / 80 mm / 56 mm  
Class A product, see page 625

Ordering data

Ordering data

Ordering data

Type	Order No.	Pcs. / Pkt.
DEK-REL- 5/O/1	2941170	10
DEK-REL- 24/O/1	2941154	10

Type	Order No.	Pcs. / Pkt.
DEK-REL- 24/1/AKT	2964063	10

Type	Order No.	Pcs. / Pkt.
DEK-REL- 24/1/SEN	2964050	10

Accessories

Accessories

Accessories

D-DEK 1,5 GN	2716949	10
EB 80- DIK BU	26 A 2715940	1
EB 80- DIK RD	26 A 2715953	1
EB 80- DIK WH	26 A 2715788	1

DIKD 1,5	2715979	50
D-DEK 1,5 GN	2716949	10
EB 80- DIK BU	26 A 2715940	1
EB 80- DIK RD	26 A 2715953	1
EB 80- DIK WH	26 A 2715788	1

DIKD 1,5	2715979	50
D-DEK 1,5 GN	2716949	10
EB 80- DIK BU	26 A 2715940	1
EB 80- DIK RD	26 A 2715953	1
EB 80- DIK WH	26 A 2715788	1



# Relay modules

## Relay modules in terminal block design - DEK series

### DEKOE... and DEK-OV... solid-state relay terminal blocks

Phoenix Contact DEK-OE and DEK-OV interface terminal blocks are only 6.2 mm wide but still provide a complete input or output interface with:

- Electrical isolation between input and output at up to 2.5 kV<sub>rms</sub>
- Integrated input circuit
- Status display
- EB-DIK insertion bridges
- Marking and mounting with modular terminal block convenience
- Wear-free switching up to 24 V DC/10 A and 240 V AC/800 mA
- Integrated output protection circuit
- Zero voltage switch at AC output
- Actuator version available

Notes:
Type of housing: Polyamide PA non-reinforced, color: green.
Marking systems and mounting material See Catalog 5
For the protection of input and output, inductive loads must be dampened with an effective protection circuit.
For other EB...DIK... insertion bridges refer to page 467

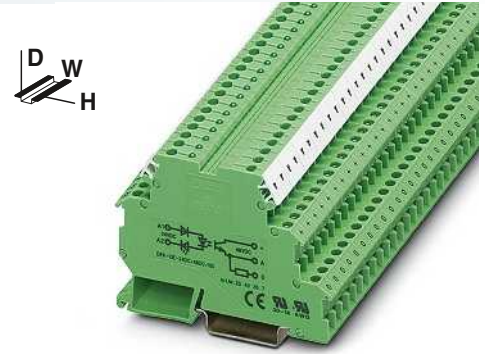

with DC voltage output  
max. = 100 mA

ERC

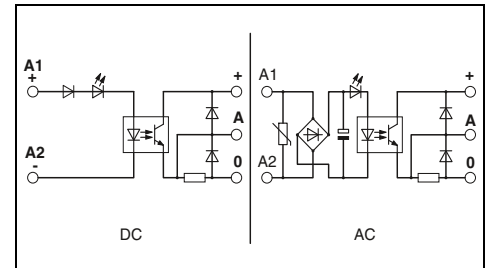

Derating curve for DEK-OV...24DC/3 and DEK-OV-24DC/24DC/3/AKT

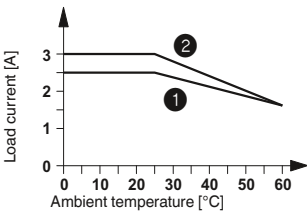

- 1 Horizontal mounting
- 2 Vertical mounting

Derating curve for DEK-OV-24DC/24DC/10

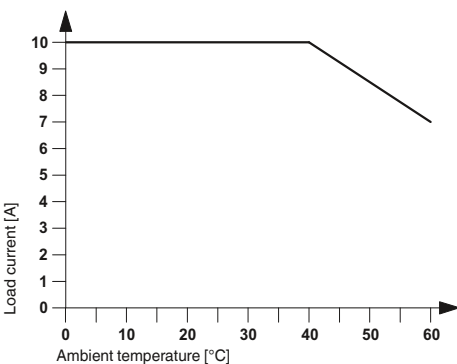

Derating curve for DEK-OV...240AC/800

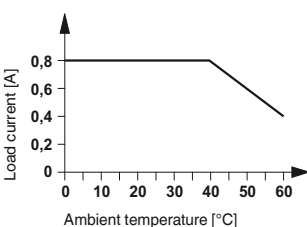

Input data	
Permissible range (with reference to U <sub>N</sub> )	
Switching level with reference to U <sub>N</sub>	1 signal ("H") 0 signal ("L")
Typ. input current at U <sub>N</sub>	[mA]
Transmission frequency f <sub>limit</sub>	[Hz]
Input circuit AC	
Input circuit DC	
Output data	
Operating voltage range	
Periodic peak reverse voltage	
Limiting continuous current	
Min. load current	
Surge current	
Leakage current in off state	
Max. load value	
Output protection	
Voltage drop at max. limiting continuous current	
General data	
Test voltage input/output	
Ambient temperature (operation)	
Standards/regulations	
Pollution degree / surge voltage category	
Connection data solid / stranded / AWG	
Dimensions	W / H / D
EMC note	

Technical data					
①	②	③	④	⑤	⑥
0.9 - 1.1	0.8 - 1.2	0.8 - 1.2	0.8 - 1.2	0.9 - 1.1	0.9 - 1.1
≥ 0.8	≥ 0.8	≥ 0.8	≥ 0.8	≥ 0.8	≥ 0.9
≤ 0.4	≤ 0.4	≤ 0.4	≤ 0.4	≤ 0.4	≤ 0.4
6.5	11	7	4	3.2	2.5
300	300	300	300	3	3
Yellow LED, protection against polarity reversal, surge protection					
Yellow LED, protection against polarity reversal					
3 V DC ... 48 V DC					
-					
100 mA					
-					
-					
-					
Protection against polarity reversal, freewheeling diode					
≤ 0.9 V					
2.5 kV (50 Hz, 1 min.)					
-20 °C ... 60 °C					
IEC 60664, EN 50178, IEC 62103					
2 / III					
0.2 - 2.5 mm <sup>2</sup> / 0.2 - 2.5 mm <sup>2</sup> / 24 - 14					
6.2 mm / 80 mm / 56 mm					
Class A product, see page 625					

Description	Input voltage U <sub>N</sub>
Solid-state input relay	① 5 V DC
	② 12 V DC
	③ 24 V DC
	④ 60 V DC
	⑤ 120 V AC
	⑥ 230 V AC
Solid-state power relay	① 5 V DC
	② 12 V DC
	③ 24 V DC
	⑦ 24 V DC
Actuator principle	

Ordering data		
Type	Order No.	Pcs. / Pkt.
DEK-OE- 5DC/ 48DC/100	2940223	10
DEK-OE- 12DC/ 48DC/100	2964487	10
DEK-OE- 24DC/ 48DC/100	2940207	10
DEK-OE- 60DC/ 48DC/100	2941536	10
DEK-OE-120AC/ 48DC/100	2941659	10
DEK-OE-230AC/ 48DC/100	2940210	10

Insertion bridge, for middle and lower levels	No. of pos.	Color
	80	blue
	80	red
	80	white

Accessories			
Part No.	Current	Order No.	Pcs. / Pkt.
EB 80- DIK BU	26 A	2715940	1
EB 80- DIK RD	26 A	2715953	1
EB 80- DIK WH	26 A	2715788	1

Relay modules in terminal block design - DEK series

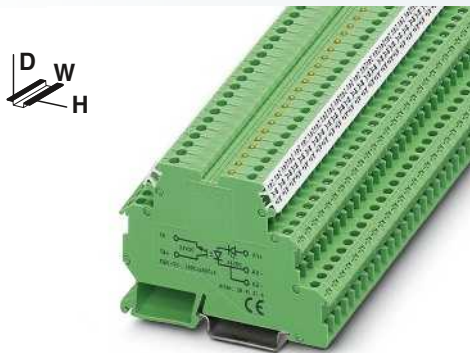

with DC voltage output  
max. = 3 A

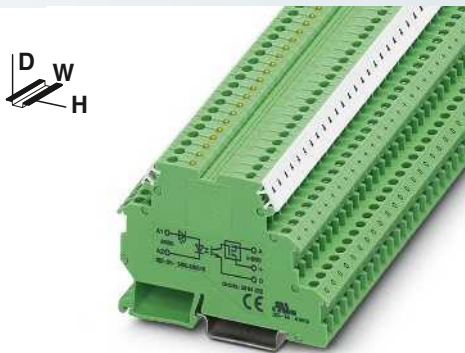

with DC voltage output  
max. = 10 A



with AC voltage output  
max. = 800 mA

ERC

ERC

ERC

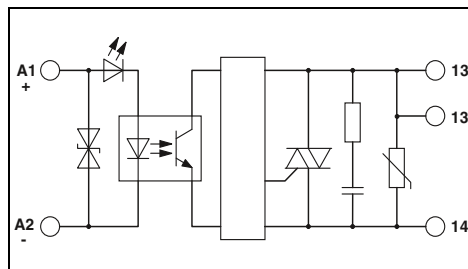
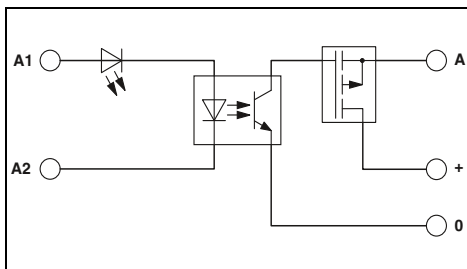
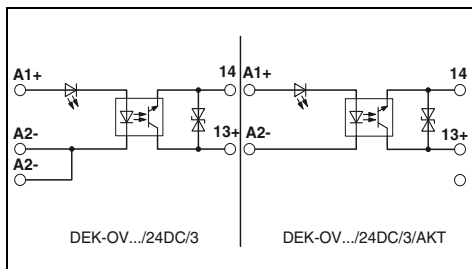

Technical data			
①	②	③	⑦
0.8 - 1.2	0.8 - 1.2	0.8 - 1.2	0.8 - 1.2
≥ 0.8	≥ 0.8	≥ 0.8	≥ 0.8
≤ 0.4	≤ 0.4	≤ 0.4	≤ 0.4
11	8.5	7	7
300	300	300	300

Technical data			
①	②	③	
0.8 - 1.2	0.8 - 1.2	0.8 - 1.2	
≥ 0.8	≥ 0.8	≥ 0.8	
≤ 0.4	≤ 0.4	≤ 0.4	
5.1	4.7	3.5	
100	100	100	

Technical data			
①	②	③	
0.8 - 1.2	0.8 - 1.2	0.8 - 1.2	
≥ 0.8	≥ 0.8	≥ 0.8	
≤ 0.4	≤ 0.4	≤ 0.4	
10.2	10.5	10.7	
10	10	10	

Yellow LED, protection against polarity reversal

Yellow LED, protection against polarity reversal, surge protection

Yellow LED, protection against polarity reversal, surge protection

3 V DC ... 30 V DC

5 V DC ... 30 V DC

10 V AC ... 253 V AC (50/60 Hz)

3 A (see derating curve)

10 A (see derating curve)

0.8 A (see derating curve)

Protection against polarity reversal, surge protection  
≤ 0.2 V

Protection against polarity reversal, surge protection  
≤ 50 mV

RCV circuit  
≤ 1 V

2.5 kV (50 Hz, 1 min.)

2.5 kV (50 Hz, 1 min.)

2.5 kV (50 Hz, 1 min.)

-20 °C ... 60 °C

-20 °C ... 60 °C

-20 °C ... 60 °C

IEC 60664, EN 50178, IEC 62103

IEC 60664, EN 50178, IEC 62103

IEC 60664, EN 50178, IEC 62103

2 / III

2 / III

2 / III

0.2 - 2.5 mm<sup>2</sup> / 0.2 - 2.5 mm<sup>2</sup> / 24 - 14

0.2 - 2.5 mm<sup>2</sup> / 0.2 - 2.5 mm<sup>2</sup> / 24 - 14

0.2 - 4 mm<sup>2</sup> / 0.2 - 2.5 mm<sup>2</sup> / 24 - 12

6.2 mm / 80 mm / 56 mm

6.2 mm / 80 mm / 56 mm

6.2 mm / 80 mm / 56 mm

Class A product, see page 625

Class A product, see page 625

Ordering data		
Type	Order No.	Pcs. / Pkt.
DEK-OV- 5DC/ 24DC/ 3	2941361	10
DEK-OV- 12DC/ 24DC/ 3	2941387	10
DEK-OV- 24DC/ 24DC/ 3	2941374	10
DEK-OV- 24DC/ 24DC/ 3/AKT	2964296	10

Ordering data		
Type	Order No.	Pcs. / Pkt.
DEK-OV- 5DC/ 24DC/ 10	2961752	10
DEK-OV- 12DC/ 24DC/ 10	2961749	10
DEK-OV- 24DC/ 24DC/ 10	2964322	10

Ordering data		
Type	Order No.	Pcs. / Pkt.
DEK-OV- 5DC/240AC/800	2964623	10
DEK-OV- 12DC/240AC/800	2964636	10
DEK-OV- 24DC/240AC/800	2964649	10

Accessories			
EB 80- DIK BU	26 A	2715940	1
EB 80- DIK RD	26 A	2715953	1
EB 80- DIK WH	26 A	2715788	1

Accessories			
EB 80- DIK BU	26 A	2715940	1
EB 80- DIK RD	26 A	2715953	1
EB 80- DIK WH	26 A	2715788	1

Accessories			
EB 80- DIK BU	26 A	2715940	1
EB 80- DIK RD	26 A	2715953	1
EB 80- DIK WH	26 A	2715788	1

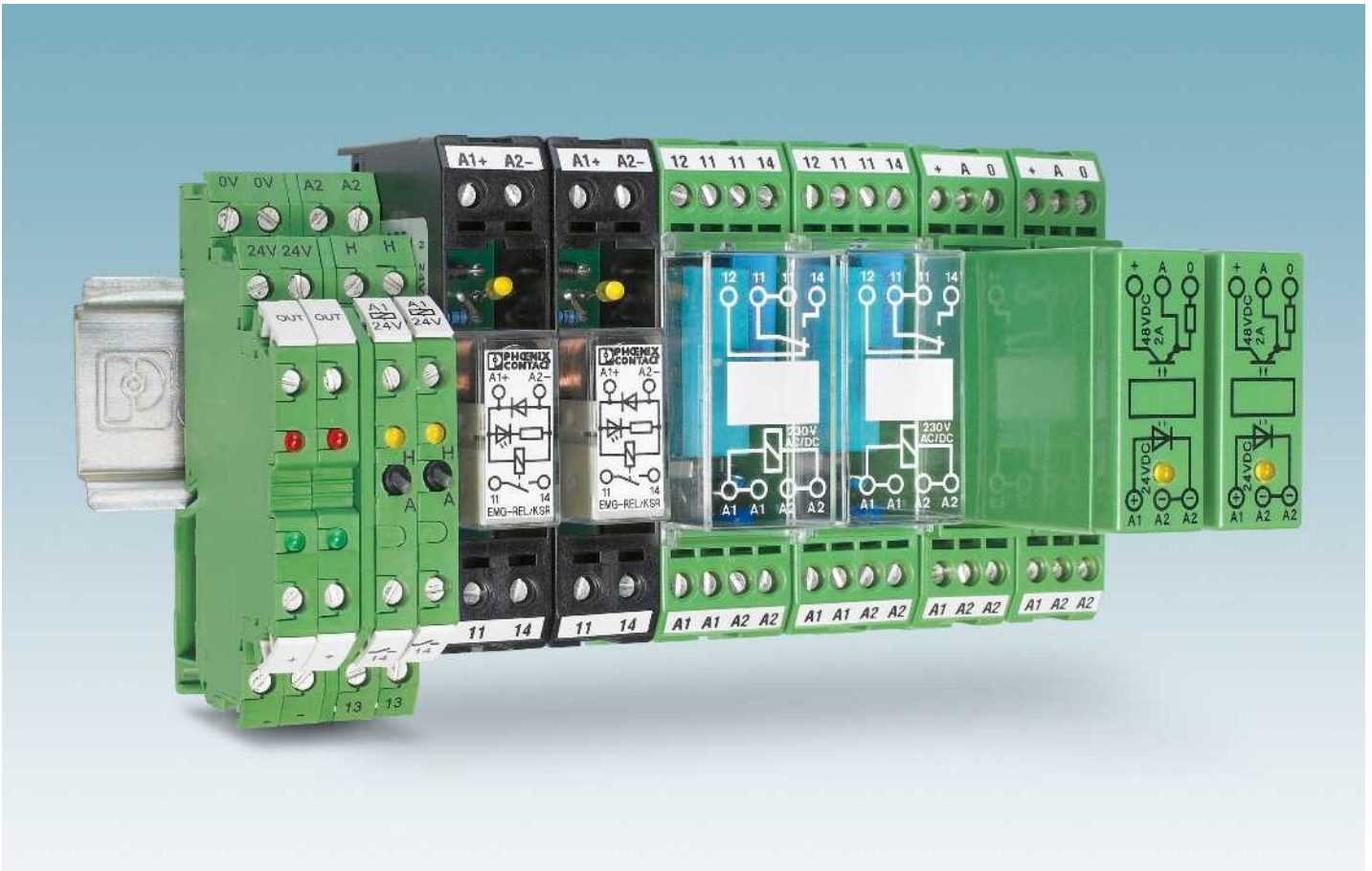

### Switch/relay terminal block DEK-REL-24/1/S

The “Manual”, “0”, and “Automatic” functions are provided in a narrow 6.2 mm relay terminal block.

### Interference-free relay and solid-state relay interfaces

Coupled interference voltages on the coil lines or leakage currents can cause malfunctions in conventional modules. These special interface modules, equipped with high switching thresholds and/or effective filters, ensure good functioning.

### Relay interfaces for switching lamp loads ST-REL... and EMG 17-REL...

Lamp loads and capacitive loads produce extremely high inrush currents which weld conventional relay contacts. To prevent this, Phoenix Contact uses an arc-resistant contact optimized for these applications, which keeps these peaks under control.

### Plug-in solid-state power relay ST-OV 3-24DC/400/3

The output of this component, dimensioned with a peak reverse voltage of 800 V, allows, for example, 230 V motors to be driven in simple reversible mode.

### Power circuit breaker solid-state relay, with signal logic

These modules combine the features of a short-circuit-proof power solid-state relay and those of a thermomagnetic protection element.

### 100 kHz input solid-state relay DEK-OE-...100KHZ

Input solid-state relay for reliable transmission of high frequency signals of the type that occur with, for example, incremental encoders.

### Electronic sensor terminal block for NAMUR proximity sensors

For converting the changeable resistance of a NAMUR sensor into a digital signal that can be read by a PLC.

### Inverter module DEK-TR/INV

Module for converting NPN outputs to PNP outputs and PNP to NPN.

Relay module with manual switch

<b>Notes:</b>
Type of housing: Polyamide PA non-reinforced, color: green.
Marking systems and mounting material See Catalog 5
For the protection of input and output, inductive loads must be dampened with an effective protection circuit.

Relay module with manual switch and integrated power relay for manual, zero, and automatic functions

The advantages:

- Max. switching current of 5 A
- Only 6.2 mm wide
- Increased contact stability thanks to double contact
- Safe isolation according to DIN EN 50178 between coil and contact

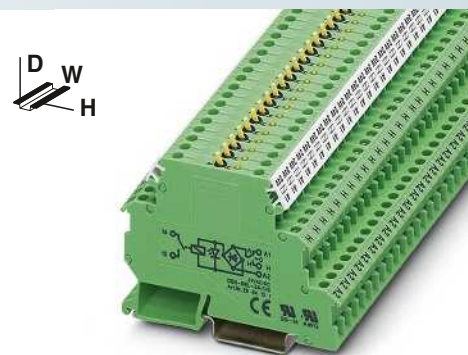

Relay module with manual switch and integrated relay

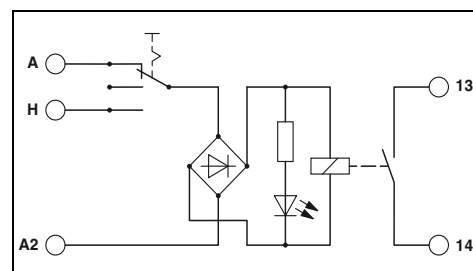

Technical data

<b>Input data</b>	①
Permissible range (with reference to $U_N$ )	0.8 - 1.1
Typ. input current at $U_N$ [mA]	6.5
Response/release time at $U_N$ [ms]	5 / 15
Input protection:	Yellow LED, bridge rectifier
<b>Output data</b>	
Contact type	1 N/O contact
Contact material	AgNi, hard gold-plated
Max. switching voltage	250 V AC / 125 V DC
Min. switching voltage	0.1 V
Limiting continuous current	3 A (5 A up to 35°C at 24 V DC)
Max. inrush current	5 A
Min. switching current	1 mA
Max. interrupting rating, ohmic load	
	24 V DC 72 W
	48 V DC 60 W
	60 V DC 50 W
	110 V DC 50 W
	250 V AC 750 VA
<b>General data</b>	
Test voltage (winding/contact)	2 kV AC (50 Hz, 1 min.)
Ambient temperature (operation)	-20 °C ... 50 °C
Mechanical service life	Approx. $2 \times 10^7$ cycles
Standards/regulations	IEC 60664, EN 50178, IEC 62103
Connection data solid / stranded / AWG	0.2 - 2.5 mm <sup>2</sup> / 0.2 - 2.5 mm <sup>2</sup> / 24 - 14
Dimensions	W / H / D 6.2 mm / 80 mm / 61 mm
EMC note	Class A product, see page 625

Ordering data

Description	Input voltage $U_N$	Type	Order No.	Pcs. / Pkt.
Relay module with power relay	① 24 V AC/DC	DEK-REL- 24/1/S	2964131	10

Accessories

Cover	No. of pos.	Color	D-DEK 1,5 GN	2716949	10
Insertion bridge	2	red	EB 2- DIK RD	2716693	10
	3	red	EB 3- DIK RD	2716745	10
	4	red	EB 4- DIK RD	2716758	10
	5	red	EB 5- DIK RD	2716761	10
	10	red	EB 10- DIK RD	2716774	10
	2	blue	EB 2- DIK BU	2716648	10
	3	blue	EB 3- DIK BU	2716651	10
	4	blue	EB 4- DIK BU	2716664	10
	5	blue	EB 5- DIK BU	2716677	10
	10	blue	EB 10- DIK BU	2716680	10
	80	blue	EB 80- DIK BU	2715940	1
	80	red	EB 80- DIK RD	2715953	1

# Relay modules

## Special relays and solid-state relays

### Relay modules with interference current filter

Relay and solid-state relay modules with integrated filter to protect against interference voltages or currents due, for example, to long control lines

The advantages:

- Resistant to interference currents
- High relay release voltage

Typical applications:

- Applications with long control lines
- Use of AC output boards, resulting in residual AC currents



1 PDT, plug-in relay



1 PDT, soldered-in relay

**Notes:**  
Load current diagrams, see page 427

ERC

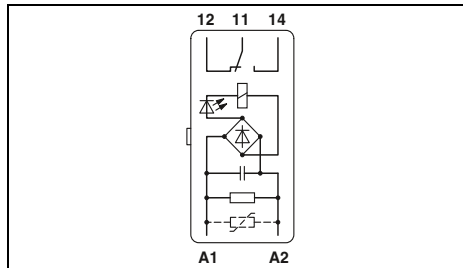

#### Technical data

	①	②	③
Permissible range (with reference to $U_N$ )	0.9 - 1.1	0.85 - 1.1	0.9 - 1.1
Typ. input current at $U_N$ [mA]	26	19	18
Response/release time at $U_N$ [ms]	8 / 10	8 / 11	10 / 8
Input protection:	Yellow LED, bridge rectifier, surge protection		

ERC

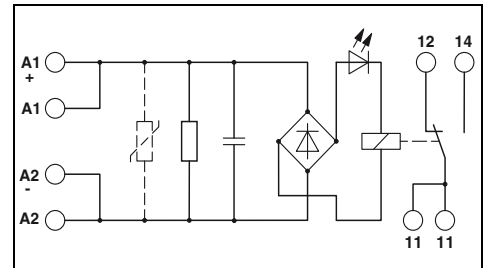

#### Technical data

	③
Permissible range (with reference to $U_N$ )	0.9 - 1.1
Typ. input current at $U_N$ [mA]	18
Response/release time at $U_N$ [ms]	10 / 8
Input protection:	Yellow LED, bridge rectifier, surge protection

Input data	
Permissible range (with reference to $U_N$ )	
Typ. input current at $U_N$ [mA]	
Response/release time at $U_N$ [ms]	
Input protection:	
Output data	
Contact type	
Contact material	
Max. switching voltage	
Limiting continuous current	
Max. inrush current	
Max. interrupting rating, ohmic load	
	24 V DC 140 W
	48 V DC 60 W
	60 V DC 45 W
	110 V DC 35 W
	220 V DC 55 W
	250 V AC 1500 VA
General data	
Test voltage (winding/contact)	2.5 kV AC (50 Hz, 1 min.)
Ambient temperature (operation)	-20 °C ... 50 °C
Mechanical service life	Approx. 2 x 10 <sup>7</sup> cycles
Standards/regulations	IEC 60664, EN 50178, IEC 62103
Connection data solid / stranded / AWG	- / - / -
Dimensions	W / H / D 20.8 mm / 42.5 mm / 112 mm

Technical data	
Contact type	Single contact, 1-PDT / Double contact, 1 PDT
Contact material	AgNi / Au
Max. switching voltage	250 V AC/DC / 30 V AC / 36 V DC
Limiting continuous current	6 A / 0.5 A
Max. inrush current	8 A / 0.2 A
Max. interrupting rating, ohmic load	140 W / 5 W
	60 W / -
	45 W / -
	35 W / -
	55 W / -
	1500 VA / -
Test voltage (winding/contact)	2.5 kV AC (50 Hz, 1 min.)
Ambient temperature (operation)	-20 °C ... 50 °C
Mechanical service life	Approx. 2 x 10 <sup>7</sup> cycles
Standards/regulations	IEC 60664, EN 50178, IEC 62103
Connection data solid / stranded / AWG	- / - / -
Dimensions	W / H / D 20.8 mm / 42.5 mm / 112 mm

Technical data	
Contact type	Single contact, 1-PDT / Double contact, 1 PDT
Contact material	AgNi / AgPd60, hard gold-plated
Max. switching voltage	250 V AC/DC / 30 V AC / 36 V DC
Limiting continuous current	6 A / 0.5 A
Max. inrush current	8 A / 0.2 A
Max. interrupting rating, ohmic load	95 W / 5 W
	50 W / -
	45 W / -
	35 W / -
	55 W / -
	1500 VA / -
Test voltage (winding/contact)	2.5 kV AC (50 Hz, 1 min.)
Ambient temperature (operation)	-20 °C ... 40 °C
Mechanical service life	Approx. 2 x 10 <sup>7</sup> cycles
Standards/regulations	IEC 60664, EN 50178, IEC 62103
Connection data solid / stranded / AWG	0.2 - 4 mm <sup>2</sup> / 0.2 - 2.5 mm <sup>2</sup> / 24 - 12
Dimensions	W / H / D 22.5 mm / 75 mm / 62.5 mm

Ordering data	
Description	Input voltage $U_N$
Relay module with power contact relay	① 24 V AC
	② 120 V AC
	③ 230 V AC
Relay module with multi-layer contact relay	① 24 V AC
	② 120 V AC
	③ 230 V AC

Type	Order No.	Pcs. / Pkt.
ST-REL3-KG 24/21/SO46	2826091	10
ST-REL3-KG120/21/SO46	2833026	10
ST-REL3-KG230/21/SO46	2832027	10
ST-REL3-KG 24/21/AU/SO46	2826981	10
ST-REL3-KG120/21/AU/SO46	2829797	10
ST-REL3-KG230/21/AU/SO46	2826266	10

Type	Order No.	Pcs. / Pkt.
EMG 22-REL/KSR-230/21/ SO46	2940760	10
EMG 22-REL/KSR-230/21/AU/SO46	2940061	10

Accessories	
Basic terminal block, complete with end cover	
Equipment marker	

Accessories	Order No.	Pcs. / Pkt.
URELG 3	2820136	10

Accessories	Order No.	Pcs. / Pkt.
EMG-GKS 12	2947035	50



<b>Notes:</b>	
Type of housing: <b>ST-REL:</b> Polyamide non-reinforced PA, color: bottom part gray, hood green <b>EMG:</b> Polyamide fiber reinforced PA-F, color: green. <b>DEK:</b> Polyamide non-reinforced PA, color: green.	
Marking systems and mounting material See Catalog 5	
For derating curve, refer to page 425	

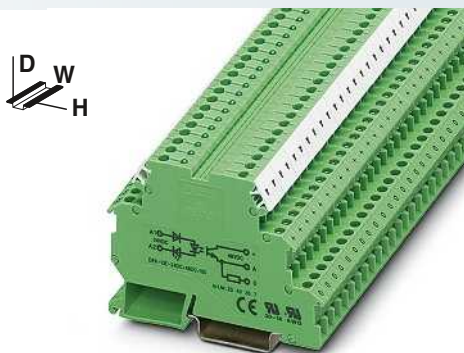

**Solid-state input relay**  
100 mA, maximum



**Solid-state power relay**  
Max. 2 A

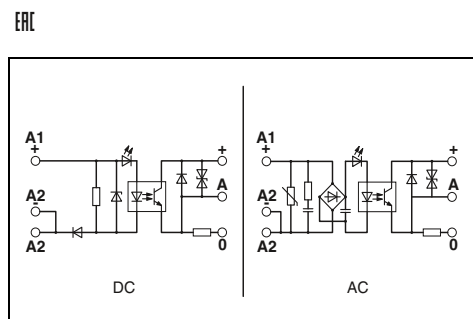
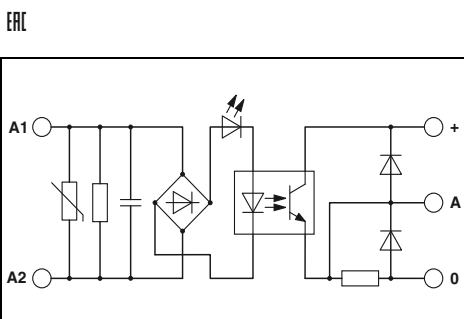

Technical data	
Input data	②
Permissible range (with reference to $U_N$ )	0.9 - 1.1
Switching level	1 signal ("H") [V DC] $\geq$ 207 0 signal ("L") [V DC] $\leq$ 92
Typ. input current at $U_N$	[mA] 2.5
Typ. switch-on time at $U_N$	[ms] 4.4
Typ. shutdown time at $U_N$	[ms] 14
Transmission frequency $f_{limit}$	[Hz] 5
Input circuit AC	Yellow LED, surge protection, RC element
Input circuit DC	
Output data	
Max. switching voltage	48 V DC
Min. switching voltage	3 V DC
Limiting continuous current	100 mA
Max. inrush current	-
Output circuit	3-conductor, ground-referenced
Output protection	Protection against polarity reversal, freewheeling
Voltage drop at max. limiting continuous current	$\leq$ 0.9 V
General data	
Test voltage input/output	2.5 kV AC
Ambient temperature (operation)	0 °C ... 50 °C
Standards/regulations	IEC 60664, EN 50178, IEC 62103
Pollution degree / surge voltage category	2 / III
Mounting position / mounting	any / can be aligned without spacing
Connection data solid / stranded / AWG	0.2 - 4 mm <sup>2</sup> / 0.2 - 2.5 mm <sup>2</sup> / 24 - 12
Dimensions	W / H / D 6.2 mm / 80 mm / 56 mm
EMC note	

Technical data	
Input data	①
Permissible range (with reference to $U_N$ )	0.8 - 1.2
Switching level	16.8
Typ. input current at $U_N$	[mA] 16
Typ. switch-on time at $U_N$	[ms] 8
Typ. shutdown time at $U_N$	[ms] 0.02
Transmission frequency $f_{limit}$	[Hz] 0.2
Input circuit AC	300
Input circuit DC	Protection against polarity reversal
Output data	
Max. switching voltage	48 V DC
Min. switching voltage	12 V DC
Limiting continuous current	2 A (see derating curve)
Max. inrush current	5 A (t = 1 s)
Output circuit	3-conductor, ground-referenced
Output protection	Protection against polarity reversal, surge protection
Voltage drop at max. limiting continuous current	1.1 V
General data	
Test voltage input/output	3.5 kV AC
Ambient temperature (operation)	-10 °C ... 55 °C
Standards/regulations	IEC 60664, EN 50178, IEC 62103
Pollution degree / surge voltage category	2 / III
Mounting position / mounting	- / aligned without spacing: horizontal/not aligned: any
Connection data solid / stranded / AWG	0.2 - 4 mm <sup>2</sup> / 0.2 - 2.5 mm <sup>2</sup> / 24 - 12
Dimensions	17.5 mm / 75 mm / 102 mm
EMC note	Class A product, see page 625

Ordering data		
Type	Order No.	Pcs. / Pkt.
DEK-OE-230AC/ 48DC/100/SO 46	2964678	10

Ordering data		
Type	Order No.	Pcs. / Pkt.
EMG 17-OV- 24DC/ 48DC/2	2942810	10

Accessories		

Accessories		
EMG-GKS 12	2947035	50

Description	Input voltage $U_N$
<b>Solid-state power relay</b>	① 24 V DC ② 230 V AC

Equipment marker

# Relay modules

## Special relays and solid-state relays

### Relay modules for high inrush currents

The Phoenix Contact relay modules of the type SO 38 have been designed for switching electrical equipment with high inrush currents.

Areas of application are:

- Inductive loads (motors, power contactors, etc.)
- Inductive/capacitive loads (fluorescent lamps, etc.)
- Ohmic loads (glow lamps, heaters)

The module is based on a relay with a special arc-resistant tungsten lead contact. This takes over the high inrush and interrupting current capacitively. The inductive main contact made of AgCdO takes over the continuous current up to 10 A reliably. With the EMG 17-REL...2E/SO38 model, this switching capacity is reached using a power relay with a set of silver tin oxide (AgSnO) contacts.

The module is available in two versions:

- EMG modular DIN-rail-mountable housing with an overall width of 17.5 mm
- Convenient ST-REL plug-in housing from the Phoenix ST series for mounting on URELG or UDK-RELG basic terminal blocks

Further features are:

- Snap-on mounting on common EN DIN rails
- Easy maintenance
- Clear marking of terminal blocks using Phoenix Contact marking material

Notes:
Type of housing: Polycarbonate fiber reinforced PC-F, color: green or black.
Marking systems and mounting material See Catalog 5



medium to large loads  
1 N/O contact (1)

ERC

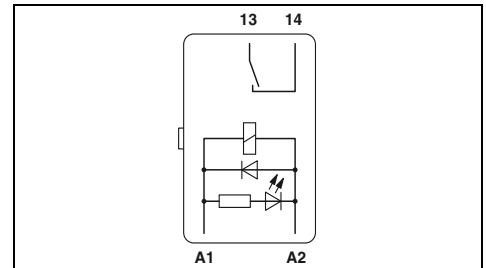

#### Technical data

<b>Input data</b>	①
Permissible range (with reference to $U_N$ )	0.85 - 1.1
Typ. input current at $U_N$	[mA] 28
Response/release time at $U_N$	[ms] 13 / 15
Input protection:	Yellow LED, freewheeling diode
<b>Output data</b>	
Contact type	1 N/O contact with lead contact
Contact material	AgCdO
Max. switching voltage	250 V AC
Limiting continuous current	10 A
Max. inrush current	80 A (20 ms)
Max. interrupting rating, ohmic load	
	24 V DC -
	48 V DC -
	60 V DC -
	110 V DC -
	220 V DC -
	250 V AC 2500 VA
<b>General data</b>	
Test voltage (winding/contact)	2.5 kV AC (50 Hz, 1 min.)
Ambient temperature (operation)	-20 °C ... 50 °C
Mechanical service life	Approx. $10^7$ cycles
Standards/regulations	IEC 60664, EN 50178, IEC 62103
Mounting position / mounting	- / horizontal without spacing, vertical with spacing
Connection data solid / stranded / AWG	- / - / -
Dimensions	W / H / D 20.8 mm / 42.5 mm / 112 mm

#### Ordering data

Description	Input voltage $U_N$	Type	Order No.	Pcs. / Pkt.
Relay module with power contact relay + wolfram lead contact	① 24 V DC	ST-REL3-KG 24/ 1/SO38	2829564	10
Relay module with power contact relay, with two inputs for manual, automatic	① 24 V DC			

#### Accessories

Basic terminal block, complete with end cover	URELG 3	2820136	10
Equipment marker			





medium to large loads  
1 N/O contact (1)



medium to large loads  
1 N/O contact (1)

ERIC

ERIC

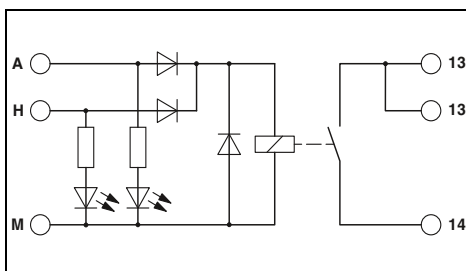
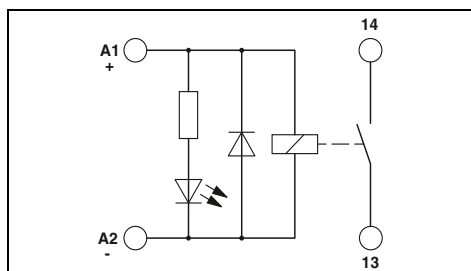

Technical data

Technical data

①  
0.85 -  
1.1  
28  
13 /  
15  
Yellow LED, freewheeling diode

①  
0.9 -  
1.1  
23  
9 / 10  
Automatic: yellow LED, manual: red LED, freewheeling diode, protection against polarity reversal

1 N/O contact with lead contact  
AgCdO  
250 V AC  
10 A  
80 A (20 ms)

Single contact, 1 N/O contact  
AgSnO  
250 V AC/DC  
10 A  
120 A (20 ms)

-  
-  
-  
-  
-  
2500 VA

240 W  
120 W  
85 W  
70 W  
90 W  
2500 VA

4 kV AC (50 Hz, 1 min.)  
-20 °C ... 50 °C  
Approx. 10<sup>7</sup> cycles  
IEC 60664, EN 50178, IEC 62103  
any

4 kV AC (50 Hz, 1 min.)  
-20 °C ... 50 °C  
3 x 10<sup>7</sup> cycles  
IEC 60664, EN 50178, IEC 62103  
any

0.2 - 4 mm<sup>2</sup> / 0.2 - 2.5 mm<sup>2</sup> / 24 - 12  
17.5 mm / 75 mm / 62.5 mm

0.2 - 4 mm<sup>2</sup> / 0.2 - 2.5 mm<sup>2</sup> / 24 - 12  
17.5 mm / 75 mm / 62.5 mm

Ordering data

Ordering data

Type	Order No.	Pcs. / Pkt.
EMG 17-REL/KSR-G 24/SO38 BK	2949994	10

Type	Order No.	Pcs. / Pkt.
EMG 17-REL/KSR-G 24/2E/SO38	2941646	10

Accessories

Accessories

EMG-GKS 12	2947035	50
------------	---------	----

EMG-GKS 12	2947035	50
------------	---------	----

# Relay modules

## Special relays and solid-state relays

### Plug-in solid-state power relays ST-OV 3

The plug-in version of the module provides all the advantages of the ST series, such as:

- Switching of up to 400 V AC/3 A
- Control of 230 V motors in straightforward reversing mode (e.g., synchronous motor in single-phase operation, see illustration)
- Plug-in

Notes:	
Type of insulating housing: polyamide PA non-reinforced, color: bottom part gray, hood green	
Ground (minus) potential from the input and output of the optocoupler should not be connected.	
AC loads must be protected with a varistor or an RC element.	



with AC voltage output  
max. = 3 A

ERC

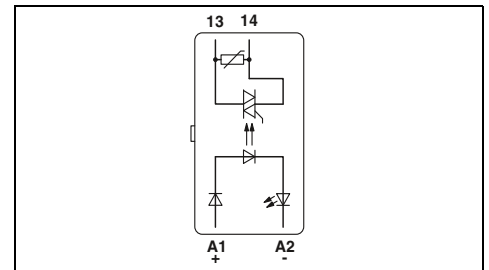

#### Technical data

Input data		①
Switching level with reference to $U_N$	1 signal ("H")	$\geq 0.8$
	0 signal ("L")	$\leq 0.4$
Typ. input current at $U_N$		[mA] 7
Transmission frequency $f_{limit}$		[Hz] 10
Input protection:		Yellow LED, protection against polarity reversal, RC element
Output data		
Operating voltage		400 V AC
Operating voltage range		24 V AC ... 420 V AC
Periodic peak reverse voltage		800 V
Limiting continuous current		3 A (see derating curve)
Min. load current		50 mA
Surge current		125 A ( $t = 10$ ms)
Residual voltage drop at "H"		$\leq 1.2$ V
Leakage current in off state		approx. 12 mA
Output protection		Surge protection, RC element
General data		
Test voltage input/output		2.5 kV AC
Ambient temperature (operation)		0 °C ... 60 °C
Standards/regulations		IEC 60664, EN 50178, IEC 62103
Pollution degree / surge voltage category		2 / III
Mounting position / mounting		Horizontal DIN rail / -
Dimensions	W / H / D	20.8 mm / 42.5 mm / 112 mm

#### Ordering data

Description	Input voltage $U_N$	Type	Order No.	Pcs. / Pkt.
Solid-state power relay	① 24 V DC	ST-OV3- 24DC/400AC/3	2905417	10

#### Accessories

Basic terminal block, complete with end cover	URELG 3	2820136	10
---	---------	---------	----

Derating curve for ST-OV 3-24DC/400AC/3

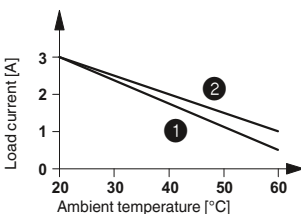

- ① Aligned without spacing
- ② Aligned with  $\geq 20$  mm spacing

**Power protection circuit solid-state relay with signal logic**

**ST-OV 4-24DC/24DC/...-PRO**

The ST-OV 4-...PRO provides protection and monitoring functions that are otherwise only known from thermomagnetic protection elements.

The PROtect modules have the following features:

- Fast disconnection with short-circuits and simultaneous current limitation
- Time-dependent overload shutdown for reliable protection against continuous overloads
- Brief inrush peaks are ignored
- After an overload or short-circuit has been triggered, a defined reset of the control voltage must be carried out
- Reliable detection and indication of a line break on the load side
- Feedback in the event of an error

<b>Notes:</b>	
Type of housing:	Polyamide PA non-reinforced, color: bottom part gray, hood green
Marking systems and mounting material	See Catalog 5
For load current diagram, see page 427	
Derating curve, time/current characteristic curves, and state diagram, see page 427	

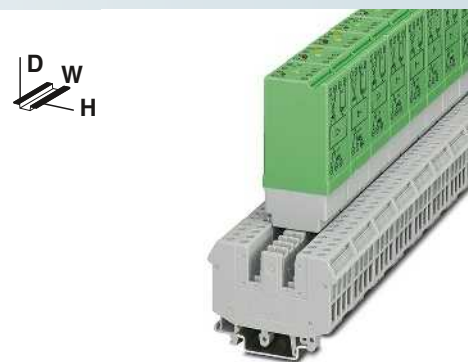

with short-circuit-proof DC voltage output  
max. = 1 A or 4 A

ERIC

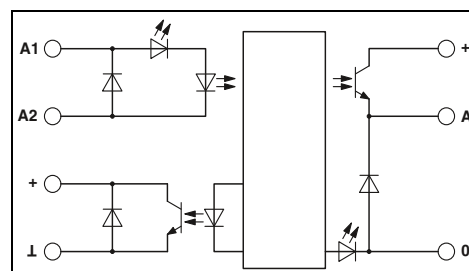

**Technical data**

Input data	ST-OV4- 24DC/ 24DC/1-PRO	ST-OV4- 24DC/ 24DC/4-PRO
Operating voltage	24 V DC ± 50%	
Switching level	8.5 V DC	
	5 V DC	
Typ. input current at U <sub>N</sub>	6.5 mA	
Transmission frequency f <sub>limit</sub>	100 Hz	
Reset period after short-circuit / overload shutdown	1 ms	
Input circuit	Yellow LED, polarity protection diode	
Output data signaling contact / CONTROL		
Operating voltage range	5 V DC ... 36 V DC	
Limiting continuous current	50 mA	
Residual voltage drop at "H"	≤ 1.5 V	
Output protection	Polarity protection diode	
Output circuit	3-conductor, ground-referenced	
Output data load contact		
Operating voltage range	18 V DC ... 36 V DC	
Limiting continuous current	1 A (see derating curve)	4 A (see derating curve)
Min. load current	1 mA	
Residual voltage drop at "H"	300 mV	200 mV
Open circuit alarm with load current	< 100 μA	
Overload disconnection (~ 1.4 x continuous current)	≤ 100 ms (see the time-current characteristic curve)	
Short-circuit disconnection	< 200 μs (see the time-current characteristic curve)	
Current limitation at short-circuits	approx. 25 A	approx. 70 A
Switching time t <sub>in</sub> / t <sub>out</sub>	300 μs / 700 μs	
Output protection	Red LED, freewheeling diode	
Output circuit	3-conductor, ground-referenced	
General data		
Test voltage input/output	2.5 kV AC	
Test voltage output/output	2.5 kV AC	
Rated surge voltage	Basic insulation	
Ambient temperature (operation)	0 °C ... 60 °C	
Standards/regulations	IEC 60664 / EN 50178 / IEC 62103	
Screw connection solid / stranded / AWG	0.2 - 4 mm <sup>2</sup> / 0.2 - 4 mm <sup>2</sup> / 24 - 12	
Dimensions	27 mm / 63.5 mm / 114 mm	

**Ordering data**

Description	Output current	Type	Order No.	Pcs. / Pkt.
<b>Power circuit breaker solid-state relay, with signal logic</b>	1 A	ST-OV4- 24DC/ 24DC/1-PRO	2905572	10
	4 A	ST-OV4- 24DC/ 24DC/4-PRO	2905585	10

**Accessories**

<b>Basic terminal block, complete with end cover</b>	UDK-RELG 4	2777056	10
--	------------	---------	----

# Relay modules

## Special relays and solid-state relays

### 100 kHz input solid-state relay DEK-OE

- A solid-state relay for the reliable detection of short pulses
- Cut-off frequency of up to 100 kHz
  - Push-pull stage on output side
  - Includes signal inputs on PLC counter boards
  - Features a capacitor on the input side for interference suppression

Notes:
Type of housing: Polyamide PA non-reinforced, color: green.
Marking systems and mounting material See Catalog 5

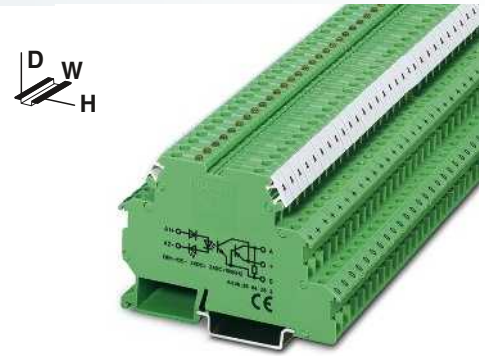

With DC voltage output  
Transmission frequency 100 kHz

ERC

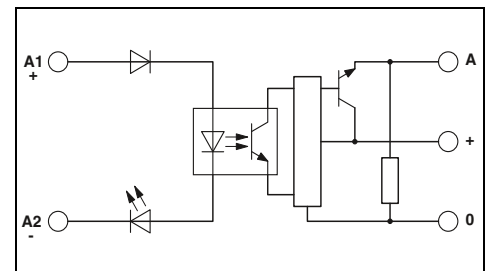

Input data	
Permissible range (with reference to $U_N$ )	
Switching level with reference to $U_N$	1 signal ("H") 0 signal ("L")
Typ. input current at $U_N$	[mA]
Typ. switch-on time at $U_N$	[ $\mu$ s]
Typ. shutdown time at $U_N$	[ $\mu$ s]
Transmission frequency $f_{limit}$	[kHz]
Input protection:	
Output data	
Operating voltage range	
Limiting continuous current	
Quiescent current	
Residual voltage drop at "H"	
Output circuit	
Output protection	
General data	
Test voltage input/output	
Ambient temperature (operation)	
Standards/regulations	
Pollution degree / surge voltage category	
Connection data solid / stranded / AWG	
Dimensions	W / H / D
EMC note	

Technical data	
①	②
0.8 - 1.2	0.8 - 1.2
$\geq 0.8$	$\geq 0.8$
$\leq 0.4$	$\leq 0.4$
7	6
1.5	1.5
2	2
100	100
Yellow LED, protection against polarity reversal, surge protection	
4 V DC ... 30 V DC	
50 mA	
4.3 mA	
$\leq 0.5$ V DC	
3-conductor, ground-referenced	
Surge protection	
2.5 kV AC	
-20 °C ... 60 °C	
IEC 60664, EN 50178, IEC 62103	
2 / II	
0.2 - 4 mm <sup>2</sup> / 0.2 - 2.5 mm <sup>2</sup> / 24 - 12	
6.2 mm / 80 mm / 56 mm	
Class A product, see page 625	

Description	Input voltage $U_N$
Solid-state input relay	① 5 V DC
	② 24 V DC

Ordering data		
Type	Order No.	Pcs. / Pkt.
DEK-OE- 5DC/ 24DC/100KHZ	2964270	10
DEK-OE- 24DC/ 24DC/100KHZ	2964283	10



With DC voltage output push-pull  
Transmission frequency 100 kHz



With DC voltage output push-pull  
Transmission frequency 100 kHz

ERC

ERC

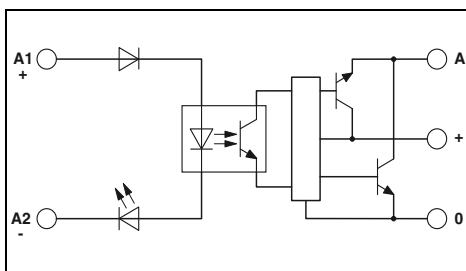
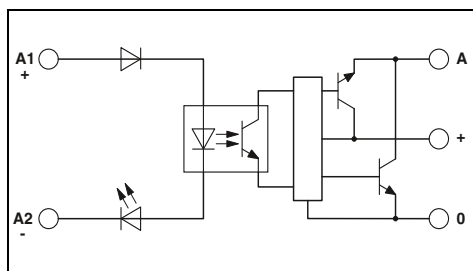

Technical data

Technical data

①	②
0.5 - 1.2	0.8 - 1.2
$\geq 0.5$	$\geq 0.8$
$\leq 0.3$	$\leq 0.4$
8	8
1	1
2	2
100	100

Yellow LED, protection against polarity reversal, surge protection

①	②
0.5 - 1.2	0.8 - 1.2
$\geq 0.5$	$\geq 0.8$
$\leq 0.3$	$\leq 0.4$
8	8
1	1
2	2
100	100

Yellow LED, protection against polarity reversal, surge protection

4 V DC ... 18 V DC  
50 mA  
8.5 mA  
 $\leq 1.2$  V DC  
3-conductor push-pull, ground referenced  
Surge protection

14 V DC ... 30 V DC  
50 mA  
15 mA  
 $\leq 2.2$  V DC  
3-conductor push-pull, ground referenced  
Surge protection

2.5 kV AC  
-20 °C ... 60 °C  
IEC 60664, EN 50178, IEC 62103  
2 / II

2.5 kV AC  
-20 °C ... 60 °C  
IEC 60664, EN 50178, IEC 62103  
2 / II

0.2 - 4 mm<sup>2</sup> / 0.2 - 2.5 mm<sup>2</sup> / 24 - 12  
6.2 mm / 80 mm / 56 mm  
Class A product, see page 625

0.2 - 4 mm<sup>2</sup> / 0.2 - 2.5 mm<sup>2</sup> / 24 - 12  
6.2 mm / 80 mm / 56 mm  
Class A product, see page 625

Ordering data

Ordering data

Type	Order No.	Pcs. / Pkt.
DEK-OE- 5DC/ 5DC/100KHZ-G	2964542	10
DEK-OE- 24DC/ 5DC/100KHZ-G	2964364	10

Type	Order No.	Pcs. / Pkt.
DEK-OE- 5DC/ 24DC/100KHZ-G	2964555	10
DEK-OE- 24DC/ 24DC/100KHZ-G	2964348	10

# Relay modules

## Special relays and solid-state relays

### Electronic sensor terminal block for NAMUR proximity sensors

The EIK 1-SVN 24-P electronic sensor terminal block converts the changeable resistance of a NAMUR sensor unit into a digital signal that can be read by all PLCs.

- Monitoring of initiator side for short-circuit or open circuit
- Suitable resistance circuit to enable monitoring of mechanical switches (see application 2)
- LED error display
- Status display (high signal) via green LED
- 24 V/50 mA digital output
- Bridging and marking with standard terminal accessories

Notes:
Type of housing: Polyamide PA non-reinforced, color: green.
Marking systems and mounting material See Catalog 5

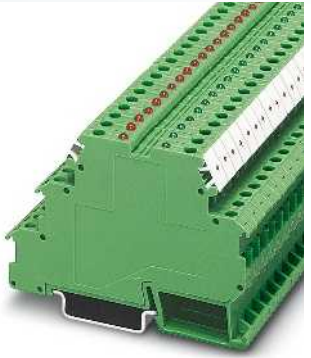

For inductive proximity sensors acc. to NAMUR

ERC

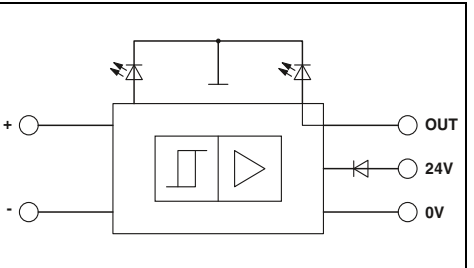

Derating curve for EIK 1-SVN 24 P

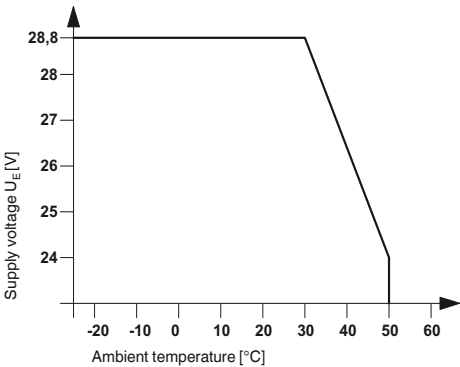

<b>Supply</b>	Input supply nominal voltage $U_{VN}$
<b>Ripple</b>	Current consumption $I_{Rmax}$ Input circuit
<b>Control circuit</b>	No-load voltage Switching points in accordance with EN 60947-5-6:
<b>Switching hysteresis</b>	
<b>Internal resistance</b>	
<b>Output protection</b>	
<b>Signal output</b>	Max. output current $I_{Omax}$ Residual voltage $U_R$ with $I_{Omax}$ Output voltage $U_O$
<b>Output protection</b>	
<b>General data</b>	Ambient temperature (operation) Transmission frequency (INPUT/OUTPUT) Input pulse length Input pause length Standards/regulations Pollution degree / Surge voltage category
<b>Screw connection solid / stranded / AWG</b>	
<b>Dimensions</b>	W / H / D
<b>EMC note</b>	

Technical data	
18.5 V DC ... 28.8 V DC ( $U_{VN}$ , see derating curve)	
in acc. with DIN 19240 70 mA (at 50 mA output current) Green LED, polarity protection diode	
8.2 V DC $\pm 10\%$ $\geq 2.1$ mA (in conductive state) $\leq 1.2$ mA (in blocking state) 6.3 mA ... 10 mA (in the event of a short-circuit) 0 mA ... 0.35 mA (in the event of an open circuit) approx. 0.2 mA approx. 1 k $\Omega$ visual short-circuit and open circuit check with LED (red), 12 V Zener diode	
50 mA $\leq 1.5$ V ( $U_R$ ) $\leq 100$ mV (in conductive state) $U_{VN} - U_R$ ; in blocking state 36 V Zener diode as freewheeling diode	
-25 °C ... 50 °C 1 kHz $\geq 0.5$ ms $\geq 0.5$ ms IEC 60664, EN 61000-6-2, EN 61000-6-4 2 / III	
0.2 - 4 mm <sup>2</sup> / 0.2 - 2.5 mm <sup>2</sup> / 24 - 12 6.2 mm / 80 mm / 56 mm Class A product, see page 625	

Application 1

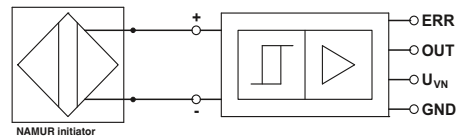

Application 2

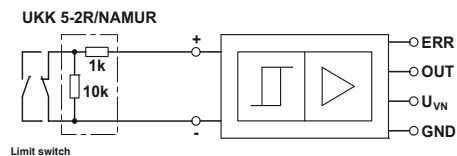

Description
<b>Switching amplifier electronic terminal block</b> , for inductive proximity initiators as per NAMUR, with light indicators for sensor signal and faults
<b>Terminal block</b> , with three through contacts, for mounting on NS 35...
<b>Double-level terminal block</b> , with pre-assembled resistors
<b>Insertion bridge</b>

Ordering data		
Type	Order No.	Pcs. / Pkt.
EIK1-SVN-24P	2940799	10

Accessories		
DIKD 1,5	2715979	50
UKK 5-2R/NAMUR	2941662	50
EB...-DIK...		
Ordering data at DEK-REL...		

### Inverter module DEK-TR/INV

The Phoenix inverter module, DEK-TR/INV, inverts the signals of ground switching NPN transistor outputs into positive switching PNP outputs, and vice versa (see application example).

Notes:
Type of housing: Polyamide PA non-reinforced, color: green.
Marking systems and mounting material See Catalog 5

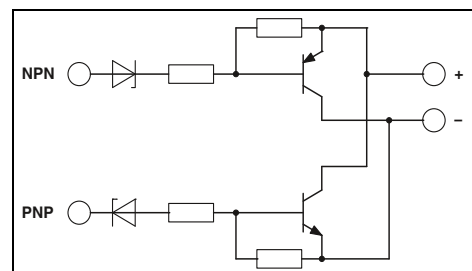
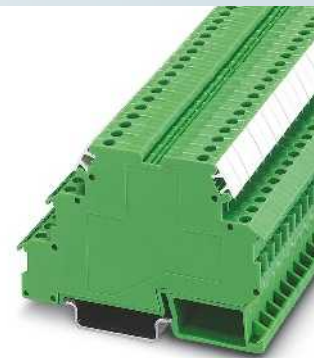

#### Technical data

Supply voltage	20 V DC ... 30 V DC ( $U_V$ )
Continuous current	200 mA
Residual voltage drop	< 1 V
Leakage current	< 1 mA
Max. transmission frequency	15 kHz
NPN input/PNP output	
Switch-on threshold	< 5 V (at $U_V = 24$ V; < ( $U_V - 19$ V))
Switch-off threshold	> 15 V (at $U_V = 24$ V; > ( $U_V - 9$ V))
Min. limit values	-2 V
Max. limit values	26 V (at $U_V = 24$ V; $U_V + 2$ V)
Control circuit	
Switch-on threshold	> 19 V
Switch-off threshold	< 9 V
Min. limit values	-2 V
Max. limit values	26 V (at $U_V = 24$ V; $U_V + 2$ V)
General data	
Ambient temperature (operation)	-20 °C ... 50 °C
Standards/regulations	IEC 60664
	Basic insulation
	2 / II
Pollution degree / Surge voltage category	
Screw connection solid / stranded / AWG	0.2 - 4 mm <sup>2</sup> / 0.2 - 2.5 mm <sup>2</sup> / 24 - 12
Dimensions	6.2 mm / 80 mm / 56 mm

#### Ordering data

Description	Type	Order No.	Pcs. / Pkt.
Inverter module	DEK-TR/INV	2964319	10

#### Connection examples:

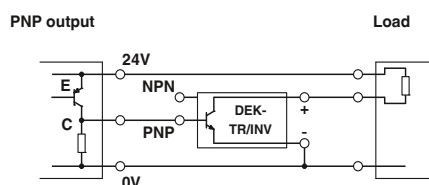
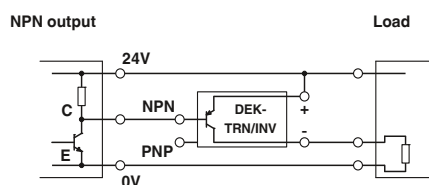



# Relay modules

## Special relays and solid-state relays

### Hybrid relay modules

With its integrated transistor level, the hybrid relay module is able to amplify weak input signals. This serves as the basis for reliable relay operation.

The advantages:

- Low control current (terminal B), type-dependent as of 0.5 mA
- Type-dependent positive or negative control current
- Integrated input and interference suppression circuit
- Safe isolation according to DIN EN 50178 between coil and contact

Notes:	
Type of housing:	Polycarbonate fiber reinforced PC-F, color: green.
Marking systems and mounting material	See Catalog 5
For the protection of relay coils and contacts, inductive loads must be dampened with an efficient protection circuit.	

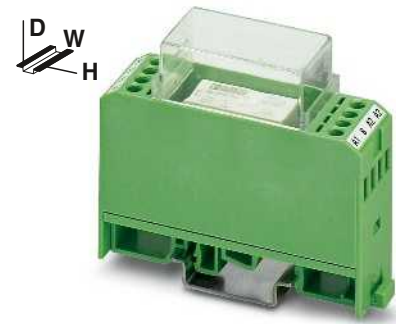

Positive switching hybrid relay

ERC

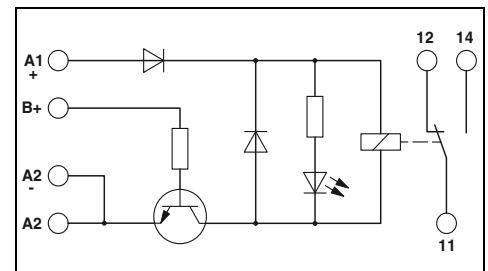

#### Technical data

Input data	①	②	③
Relay supply voltage $U_N \pm 10\%$	[V DC] 24	24	24
Min. control voltage	[V DC] 2.7	5	15
Max. control voltage	[V DC] 5.25	13.2	35
Min. control current	[mA] 2.6	0.5	0.5
Max. control current	[mA] 7.7	1	1
Typ. input current at $U_N$	[mA] 21	21	21
Response/release time at $U_N$	[ms] 9 / 10	9 / 10	9 / 10
Input protection: Yellow LED, protection against polarity reversal, freewheeling diode			
Output data			
Contact type	Single contact, 1-PDT		
Contact material	AgNi		
Max. switching voltage	250 V AC/DC		
Limiting continuous current	5 A		
Max. inrush current	8 A		
Max. interrupting rating, ohmic load	24 V DC	120 W	
	48 V DC	60 W	
	60 V DC	50 W	
	110 V DC	50 W	
	220 V DC	80 W	
	250 V AC	1250 VA	
General data			
Test voltage (winding/contact)	4 kV AC (50 Hz, 1 min.)		
Ambient temperature (operation)	-20 °C ... 50 °C		
Mechanical service life	Approx. $5 \times 10^7$ cycles		
Standards/regulations	IEC 60664, EN 50178, IEC 62103		
Pollution degree / surge voltage category	2 / III		
Connection data solid / stranded / AWG	0.2 - 4 mm <sup>2</sup> / 0.2 - 2.5 mm <sup>2</sup> / 24 - 12		
Dimensions	W / H / D	22.5 mm / 75 mm / 62.5 mm	
EMC note	Class A product, see page 625		

#### Ordering data

Description	Nominal control voltage
<b>Relay module with miniature power contact relay with integrated NPN transistor control, for low control currents</b>	① 5 V DC
	② 12 V DC
	③ 24 V DC
<b>Relay module with miniature power contact relay with integrated PNP transistor control, for low control currents</b>	① 5 V DC
	② 12 V DC
	③ 24 V DC

Type	Order No.	Pcs. / Pkt.
EMG 22-REL/KSR-G 24/TRN 5	2949787	10
EMG 22-REL/KSR-G 24/TRN12	2952363	10
EMG 22-REL/KSR-G 24/TRN35	2952350	10

#### Accessories

Equipment marker	EMG-GKS 12	2947035	50
------------------	------------	---------	----

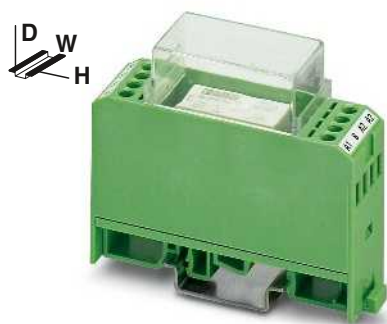

Negative switching hybrid relay

ERC

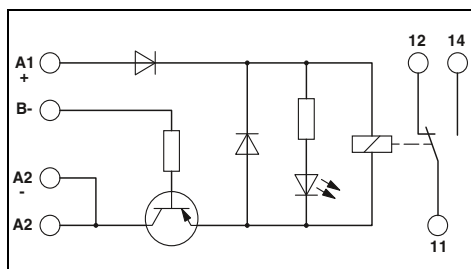

Technical data

①	②	③
24	24	24
-2.4	-6.9	-17.5
-5.25	-13.2	-38.5
1.2	0.6	0.6
1.7	1	1.4
21	21	21
9 / 10	9 / 10	9 / 10

Yellow LED, protection against polarity reversal, freewheeling diode

Single contact, 1-PDT

AgNi  
250 V AC/DC  
5 A  
8 A

120 W  
60 W  
50 W  
50 W  
80 W  
1250 VA

4 kV AC (50 Hz, 1 min.)  
-20 °C ... 50 °C  
Approx.  $5 \times 10^7$  cycles  
IEC 60664, EN 50178, IEC 62103  
2 / III

0.2 - 4 mm<sup>2</sup> / 0.2 - 2.5 mm<sup>2</sup> / 24 - 12  
22.5 mm / 75 mm / 62.5 mm  
Class A product, see page 625

Ordering data

Type	Order No.	Pcs. / Pkt.
EMG 22-REL/KSR-G 24/TRP 5	2949790	10
EMG 22-REL/KSR-G 24/TRP12	2952156	10
EMG 22-REL/KSR-G 24/TRP35	2952169	10

Accessories

EMG-GKS 12	2947035	50
------------	---------	----



# System cabling for controllers

Wiring I/O modules with individual wires is an extremely time-consuming process. Wiring errors and tedious troubleshooting cannot be ruled out.

VARIOFACE system components reduce assembly costs by using plug-in components to carry out wiring quickly, clearly, and without errors.

In the case of **controller-specific system cabling**, front adapters, system cables, and modules are specially matched to each other. Individual solutions exist for the following controllers:

- **ABB**
- **Allen Bradley**
- **Emerson**
- **Honeywell**
- **GE Fanuc**
- **Phoenix Contact**
- **Mitsubishi Electric**
- **OMRON**
- **Schneider Electric**
- **Siemens**
- **Yokogawa**

If automation components with high-pos. connectors such as D-SUB are in the control cabinet, **universal modules** and cables are suitable for signal connection. The 1:1 connection is characteristic for these universal all-purpose modules. The modules allow orderly connection of field signals to screw, spring-cage or push-in technology.

**Universal cables** connect the control and signal level quickly and without errors.

A wide variety of **potential distributors** are available for splitting the control and operating voltage. The different potential levels and the connection terminal blocks make flexible use possible.

Individual application requirements can be realized with customer-specific products (see page 488).

<b>Product range overview</b>	
Introduction	<b>482</b>
Product overview	<b>484</b>
<hr/>	
<b>Customer-specific products</b>	<b>488</b>
<hr/>	
<b>Controller-specific system cabling</b>	
For ABB S800 I/O	<b>490</b>
For Allen Bradley, ControlLogix, SLC 500, and PlantScape	<b>492</b>
For Emerson DeltaV	<b>498</b>
For GE Fanuc RX3i and Series 90-30	<b>502</b>
For Honeywell C300 Series CI/O and PlantScape	<b>504</b>
For Mitsubishi A1S and Q, Melsec L, Honeywell ML 200	<b>506</b>
For Omron CJ1, CS1, and C200H	<b>508</b>
For Phoenix Contact Axioline and Inline	<b>509</b>
For Schneider Electric MODICON®	<b>511</b>
For Siemens SIMATIC® S7-300	<b>514</b>
For Siemens SIMATIC® S7-1500	<b>524</b>
For Siemens SIMATIC® S7-400	<b>526</b>
For Siemens SIMATIC® S5-S7 conversion	<b>527</b>
For Yokogawa Centum VP, ProSafe-RS	<b>534</b>
Termination Carriers for Yokogawa Centum VP and ProSafe-RS	<b>540</b>
Passive modules	<b>542</b>
Active modules	<b>556</b>
V8 adapters for PLC-INTERFACE	<b>568</b>
System and splitting cables	<b>575</b>
<hr/>	
<b>Universal modules</b>	
With flat-ribbon cable connectors	<b>576</b>
With D-SUB connectors	<b>584</b>
With high-density D-SUB connectors	<b>591</b>
With DIN strips	<b>592</b>
With ELCO connectors	<b>594</b>
With RJ45 connectors	<b>598</b>
With COMBICON connection	<b>599</b>
<hr/>	
<b>Universal cables</b>	
With flat-ribbon cable connectors	<b>600</b>
With D-SUB connectors	<b>610</b>
With ELCO connectors	<b>616</b>
<hr/>	
<b>Potential distributors</b>	<b>618</b>

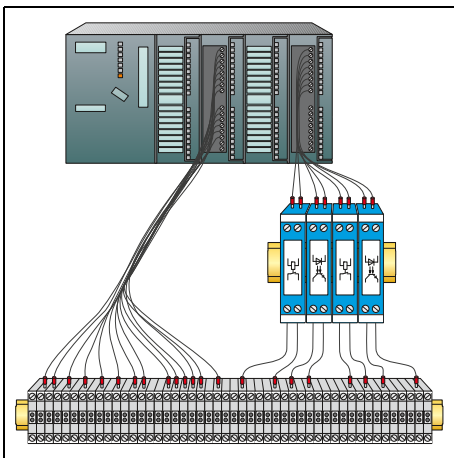

### Wiring with single wires

- Time-consuming
- Confusing wiring
- Risk of mixing wires
- Time-consuming troubleshooting

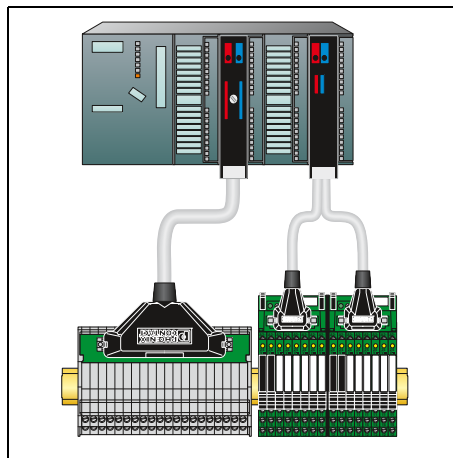

### Wiring with the controller-specific system cabling:

- Fast, fault-free wiring
- Plug and Play solution
- Orderly structure
- Considerable time savings



The matching components are selected with the help of the “system cabling for controllers” online configurator:

- Front adapter
- System cables
- Module

For the online configurator, use the web code:

**i** Your web code: #0007

Simply enter “#0007” into the search field on our website.

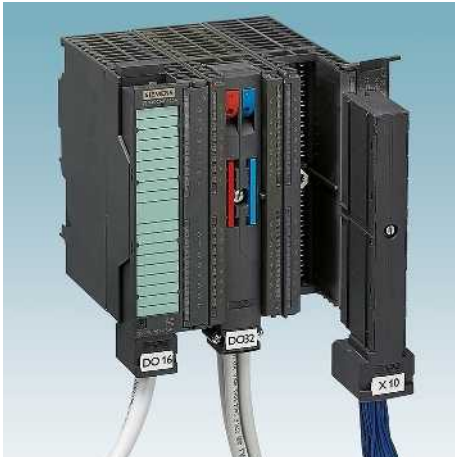

### Front adapter

- Tailored to controller-specific I/O modules
- Plug-in components
- Connection via system cables



### 8 and 32-channel modules

- Passive modules
- Relay modules
- Controller-specific layout
- Screw or push-in connection technology



### PLC-V8 adapter

- Connection of 8 channels via the "PLC series"
- Feasible functions: relay, solid-state relay or feed-through
- Individual function selection per channel
- Screw, spring-cage or push-in connection technology



### Universal modules

- Connector: IDC/FLK, D-SUB, ELCO or DIN
- 1:1 connection
- Screw, spring-cage or push-in connection technology
- Optional status indicator



### Universal cables

- With IDC/FLK connector
- With D-SUB connector
- With ELCO connector
- With open end as an option

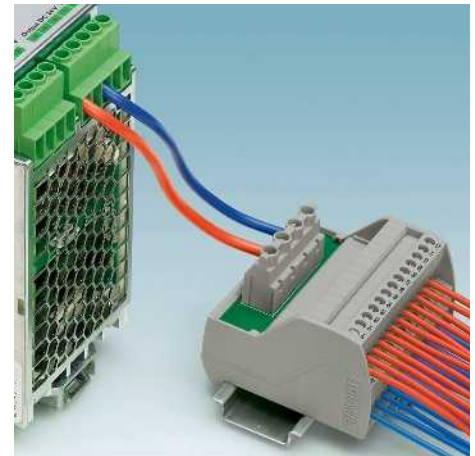

### Potential distributor

- Up to 30 A/250 V
- Two, three or six potential levels
- Screw or push-in connection technology



# System cabling for controllers

## Product overview

### Controller-specific system cabling

System component		Controller									
		ABB	Allen Bradley		Emerson	GE-FANUC		Honeywell		Mitsubishi	
		S800 I/O	Control Logix	SLC 500	DeltaV	RX3i	90-30	C300 Series CI/O ML 200	PlantScape	MELSEC A, A1S, Q, L	
Version		Page	Page	Page	Page	Page	Page	Page	Page	Page	
Front adapter		not required	492	494	not required	502	503	504	492	not required	
System cables	 Standard	610	574	574	606	574	574	610	574		
	 Controller-specific	491		496	498			507		506	
Interface modules	 Passive Standard	542	542	542	542	542	542	505	542	542	
	 Passive Controller-specific	490	545	495	499						
Interface modules	 Active Standard	556	556	556	556	556	556	556	556	556	
	 V8 adapter/ feed-through terminal block	568	568	568	568	568	568	568	568	568	
		 Relay/ optocoupler	398	398	398	398	398	398	398	398	398
	 MINI Analog system adapter										
 MINI Analog											



	OMRON CJ1	Phoenix Contact	Schneider		Siemens				Yokogawa	
	CS1, CQM1, C200H	Axioline Inline	TSX Quantum	M340	S7 300	S7 1500	S7 400	Conversion S5 to S7	Centum VP	ProSafe-RS
	Page	Page	Page	Page	Page	Page	Page	Page	Page	Page
	not required	510	511	512	516	not required	526	527	not required	not required
		574	574	574	574		574			
	508			513	521	524			534	534
	542	542	542	542	542	542	542			
			545		544		544		536	538
	556	556	556	556	556	556	556			
	568	568	568	568	568	568	568		568	
	398	398	398	398	398	398	398		398	
					122				122	
					120				120	

# System cabling for controllers

## Product overview

### Universal modules and cables

		Passive modules (connection technology)				
		Flat-ribbon cable strip	D-SUB strip	DIN strip	ELCO strip	Potential distributor
Device series						
	Page	Page	Page	Page	Page	Page
VIP Line		576	584 591			618
Standard Line				592	596	
Slim Line		580	588			
Feed-through modules		582	589			
Cables		600	610			

COMBICON



Page

599

599

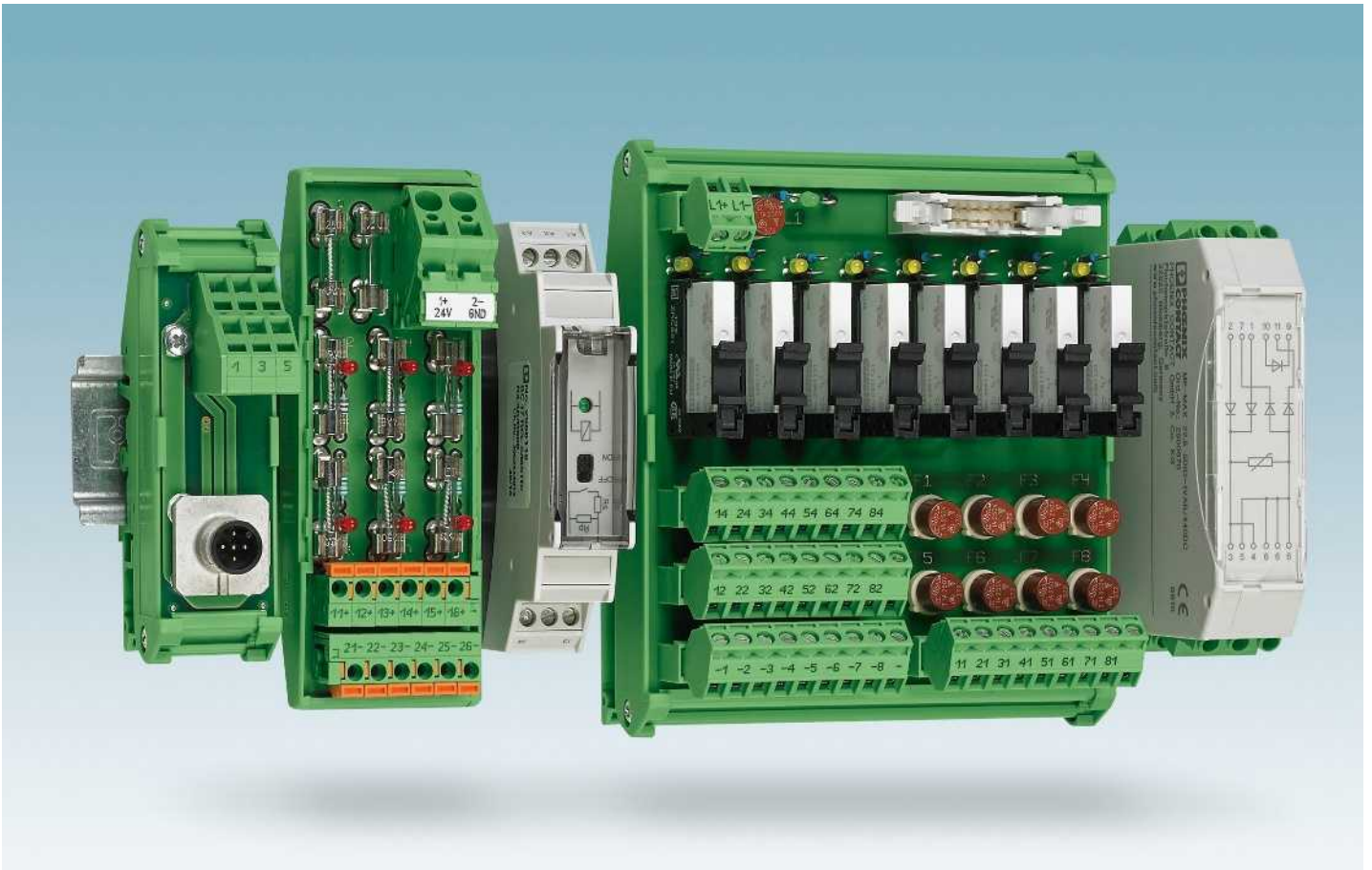

### From the enquiry to the product

We develop your product from the idea to series production.

#### Concept phase

- Realization test according to your specifications
- Personal consultation
- Tendering including draft drawing

#### Realization phase

- Development according to product creation process
- Circuit diagram and PCB layout
- Component selection
- Creation of functional samples
- Creation of prototypes
- Tests in every phase of development
- EC conformance
- Preparation and implementation of approval procedures
- Environmental tests according to standards
- Documentation

#### Series phase

- Production according to IPC-A-610 Class 2
- 100% end test with automated test systems
- Lifecycle management

### Directives and standards

- Low-voltage directive
- EMC directive
- IEC 60664-1  
Insulation coordination for electrical equipment within low-voltage systems
- EN 50178  
Electronic equipment for use in power installations
- EN 61000-6  
Electromagnetic compatibility
- IPC A-600  
Acceptance criteria for PCBs
- IPC-A-610  
Acceptance criteria for electronic modules

### Components used

We use connection technology and housings from the comprehensive Phoenix Contact portfolio.

Here you will find all common market technologies:

- Screw and spring-cage connection
- Push-in spring connection
- Knife disconnection
- Modular component housing
- Building installation housings
- Profile module carriers

Furthermore, we use components, connectors, cables as well as PCBs from qualified and certified suppliers.

### Product range

We create versions from catalog production for you or new products according to your specifications from the following portfolio:

- Function modules such as diode gates
- Relay and optocoupler modules
- 1:1 installation modules (connector on terminal block)
- Potential distributors
- System cables with high-pos. connectors
- System adapters for controllers and control systems
- Transfer modules for use between controller and field level
- Output modules with electrical isolation
- Module carriers for system cabling of signal conditioners or safe coupling relays

### Your direct line to us

Do you have a specific question? Talk to us about it.



### Simplification of installation

- Objectives
  - Reduce assembly costs
  - Minimize installation time
  - Optimize space in the control cabinet
- Implementation
  - Analysis of the application
  - Draft of concept
- Result
  - Tailor-made solution from system components (standard and customer-specific)
  - Fault-free wiring

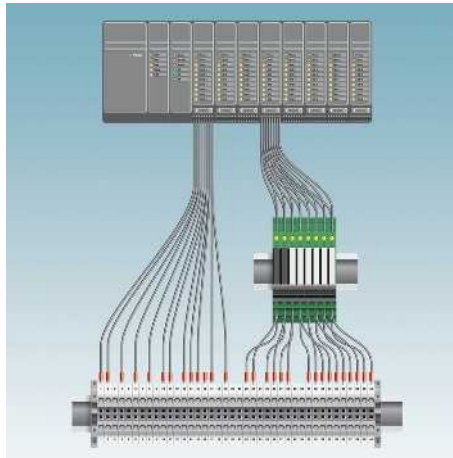

### Retrofitting systems

- Task
  - Extension
  - Retrofitting
- Objectives
  - System availability
  - Fulfillment of statutory specifications
- Solution
  - Use adaptation solutions and high-pos. system cables
- Result
  - Minimum downtimes



### Pre-assembled system cables

- With high-position connectors
  - D-SUB strips
  - IDC/FLK pin strips (2.54 mm)
- Pre-assembled at one or both ends
- Cables
  - Shielded, unshielded, halogen-free
  - 0.14 mm<sup>2</sup>/26 AWG and 0.25 mm<sup>2</sup>/24 AWG
- Quality
  - Continuity and dielectric test
- Other versions available on request.



### Installation modules

- 1:1 marshalling terminal block to high-pos. connector (D-SUB, HE10, ELCO...)
- Passive transfer modules with system connection
- Potential distributors
- Fuse modules
- Diode modules
- Other modules on request



### Relay and optocoupler modules

- With electromechanical relays
- With solid-state relays
- Multi-channel
- With system connection
- N/O contact or PDT contact
- LED status display
- Freewheeling diode
- Protection against polarity reversal
- Redundant power supply



### Termination Carrier module carrier

- The compact Termination Carrier connects
  - Signal conditioners
  - Signal conditioners for Ex i circuits
  - Signal conditioners for SIL applications
  - Safe coupling relays
- easily with the automation system via system cables.
- The advantages are clear:
  - Quick startup
  - Fault minimization



## Controller-specific system cabling

### ABB S800 I/O Termination boards with knife disconnection

The ABB S800 I/O system offers the possibility of realizing the process wiring with D-SUB connectors. ABB TU 812 Compact MTU are available for this purpose.

The FLKM-D25SUB/B/KDS3-MT/... modules are connected to the I/O modules via assembled D-SUB cables (see page 610).

In addition to screw connection with knife disconnection for every channel and ABB S800-specific marking, the modules have the following features:

- Eight negative terminal blocks with knife disconnection (TU810)
- Eight positive terminal blocks with knife disconnection (TU810/P)
- For each channel, there is a positive and negative terminal block with knife disconnection (TU830)

Passive interface modules can also be used for signal transmission (e.g., VIP-3/SC/D25SUB/F, 2315188), see page 585.

### Web code for the online configurator

**i** Your web code: #0007

#### Connectable I/O modules

Card type	FLKM-D25SUB...				
	...TU810	...TU810/P	...TU830		
Digital input	DI 814	DI 810	DI 810		
		DI 811	DI 811		
		DI 814	DI 814		
		DI 818	DI 818		
		DI 830	DI 830		
		DI 831	DI 831		
		DI 840	DI 840		
		DI 885	DI 885		
		Digital output	DO 814	DO 810	DO 810
				DO 814	DO 814
DO 818	DO 818				
DO 840	DO 840				
Analog input	AI 845	AI 810	AI 810		
		AI 815	AI 815		
		AI 820	AI 820		
		AI 830	AI 830		
		AI 835	AI 835		
		AI 845	AI 845		
Analog output	AO 845	AO 810	AO 810		
		AO 815	AO 815		
		AO 820	AO 820		
		AO 845	AO 845		
Other	DP 820	DP 820	DP 820		

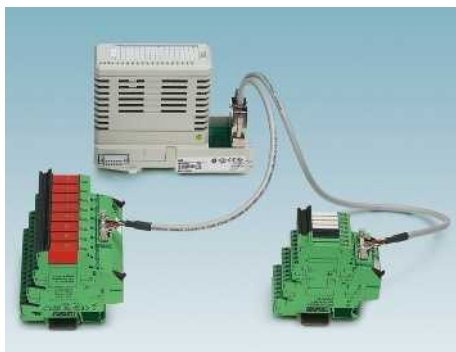

#### Explanation:

- Flat-ribbon cable strip
- Connection to I/O card
- Screw terminal blocks for separate supply

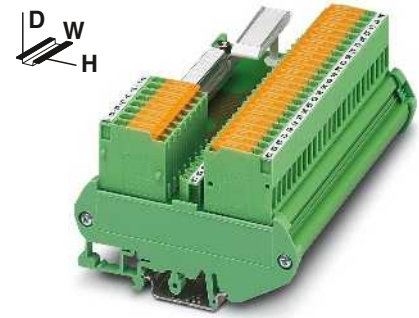

Interface module with knife disconnect terminal blocks

#### Technical data

Max. perm. operating voltage	< 50 V AC / 60 V DC
Max. perm. current (per branch)	2 A
Max total current (voltage supply)	4 A (8 A L1-/L2-)
Ambient temperature (operation)	-20 °C ... 50 °C
Mounting position	any
Standards/regulations	DIN EN 50178, IEC 60664, IEC 62103
Connection method	Screw connection with disconnect knife
	D-SUB socket strip
Connection data solid / stranded / AWG	0.2 ... 4 mm <sup>2</sup> / 0.2 ... 2.5 mm <sup>2</sup> / 24 - 12
Dimensions	90 mm / 61 mm
	Field level
	Controller level

#### Ordering data

Type	Order No.	Pcs. / Pkt.
FLKM-D25 SUB/B/KDS3-MT/TU810	2304513	1
FLKM-D25 SUB/B/KDS3-MT/TU810/P	2304539	1
FLKM-D25 SUB/B/KDS3-MT/TU830	2304526	1

Description	No. of pos.	Module width W
<b>VARIOFACE module</b> , with knife disconnect terminal blocks in ABB-specific marking:		
- with 8 negative terminal blocks	25	126.5 mm
- with 8 positive terminal blocks	25	126.5 mm
- each with 16 positive and negative terminal blocks	25	247.5 mm

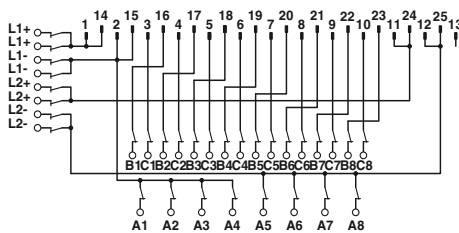

FLKM-D25 SUB/B/KDS3-MT/TU810 connection scheme

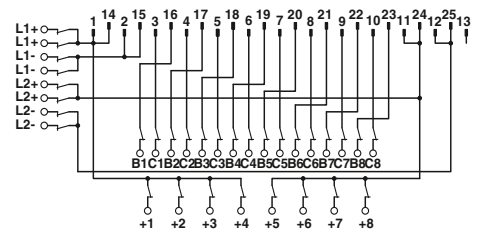

FLKM-D25 SUB/B/KDS3-MT/TU810/P connection scheme

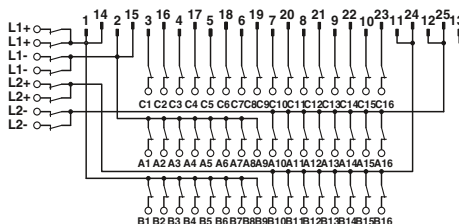

FLKM-D25 SUB/B/KDS3-MT/TU830 connection scheme

**ABB S800 I/O**  
**System cable**

The ABB S800 I/O system offers the possibility of realizing the process wiring with D-SUB connectors. ABB TU 812 Compact MTU are available for this purpose.

The CABLE-D25SUB/B/2X14/.../TU812 system cables convert digital signals from a D-SUB socket strip to two flat-ribbon cable connectors. Therefore, all 8-channel interface modules of the system cabling can be connected to S800 I/O modules. Two interface modules are used per module.



System cable

**Technical data**

Max. perm. operating voltage	< 50 V AC / 60 V DC
Max. perm. current carrying capacity per path	1 A
Ambient temperature (operation)	-20 °C ... 50 °C
Assembly	Insulation displacement, IEC 60352-4/DIN EN 60352-4
Conductor cross section	AWG - / 0.14 mm <sup>2</sup>
Conductor structure: stranded wires / material	7 / Cu tin-plated
Outside diameter	6.3 mm
	25-position

**Ordering data**

Description	No. of pos.	Cable length	Type	Order No.	Pcs. / Pkt.
<b>VARIOFACE system cable</b> , for S800 I/O, with a 25-pos. D-SUB socket strip and two 14-pos. flat-ribbon cable connectors, in standard lengths	25	1 m	<b>CABLE-D25SUB/B/2X14/100/TU812</b>	2304649	1
	25	2 m	<b>CABLE-D25SUB/B/2X14/200/TU812</b>	2304652	1
	25	3 m	<b>CABLE-D25SUB/B/2X14/300/TU812</b>	2304665	1
	25	5 m	<b>CABLE-D25SUB/B/2X14/500/TU812</b>	2304678	1
<b>VARIOFACE system cable</b> for S800 I/O, with a 25-pos. D-SUB socket strip and two 14-pos. flat-ribbon cable connectors, in variable lengths	25		<b>CABLE-D25SUB/B/2X14/TU812/...</b>	2304681	1

**Color code and pin assignment**  
**CABLE-D25SUB/B/2X14...TU812**

D-SUB connector 25-pos.	FLK 14 1st connector	FLK 14 2nd connector	Conductor color
1	9		Gray
2	10		White
3	1		Black
4	3		Red
5	5		Yellow
6	7		Blue
7		1	Black
8		3	Red
9		5	Yellow
10		7	Blue
11		9	Orange
12		10	White
13	NC	NC	-
14	11		White-black
15	12		White-brown
16	2		Brown
17	4		Orange
18	6		Green
19	8		Violet
20		2	Brown
21		4	Orange
22		6	Green
23		8	Violet
24		11	White-black
25		12	White-brown

**Ordering example** for system cable:

- Cable for ABB S800, 12.75 m long

Quantity	Order No.	Length [m] <sup>1)</sup>
1	2304681	12.75

<sup>1)</sup> min. 0.20 m



# System cabling for controllers

## Controller-specific system cabling

### Allen Bradley ControlLogix, Honeywell PlantScape Front adapter

#### I/O modules with 32 channels or of this type

The front adapters are pushed into the tall 1756-TBE covers (not supplied as standard, original accessories must be ordered directly from manufacturer) of the controller. A 50-pos. system cable can connect a maximum of 32 channels to the field level.

Tailor-made VARIOFACE termination boards round off this system concept.

#### Web code for the online configurator

**i** Your web code: #0007

**Notes:**  
Front adapters can also be used without cover.



**32-channel front adapter  
with 50-pos. FLK strip**



#### Technical data

Max. perm. operating voltage  
Max. permissible current

< 50 V AC / 60 V DC  
1 A (per path)  
8 A (per connection, supply via separate power supply)

Ambient temperature (operation)  
Ambient temperature (storage/transport)  
Connection data solid / stranded / AWG  
Standards/regulations

-20 °C ... 50 °C  
-20 °C ... 70 °C  
0.14 ... 1.5 mm<sup>2</sup> / 0.14 ... 1.5 mm<sup>2</sup> / 28 - 16  
DIN EN 50178 / IEC 60664 / IEC 62103

#### Ordering data

Description	No. of pos.
<b>VARIOFACE front adapter, for ControlLogix:</b>	
- A maximum of 1 x 32 channels can be connected	50
- IB 32 input board	50

Type	Order No.	Pcs. / Pkt.
<b>FLKM 50-PA-AB/1756/EXTC</b>	<b>2302735</b>	1
<b>FLKM 50-PA-AB/1756/IN/EXTC</b>	<b>2302748</b>	1

Front adapters for I/O modules of Allen Bradley ControlLogix and Honeywell PlantScape automation devices

Card type	FLKM 50-PA-AB/1756/EXTC
Digital input	1756-IA 16 I* or TC-TDK 161* 1756-IB 16 D* or TC-TDX 161* 1756-IB 16 I* or TC-TDJ 161* 1756-IH 16 I*
Digital output	1756-OB 32 or TC-ODD 321
Analog input	1756-IF 8* 1756-IF 16 I* or TC-IAH 161* 1756-IF 8H* or TC-HAI 081*
Counter	1756-HSC*
Servo	1756-M02 AE*
Card type	FLKM 50-PA-AB/1756/IN/EXTC
Digital input	1756-IB 32 or TC-IDD 321

\* Only in conjunction with  
VIP-2/SC/FLK50/AB-1756, Order No.: 2322317  
VIP-2/PT/FLK50/AB-1756, Order No.: 2904286  
There must be no voltage supply at the front adapter. Risk of short circuit!

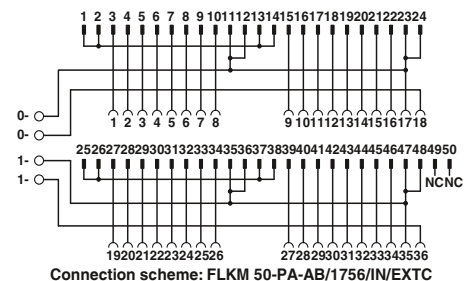
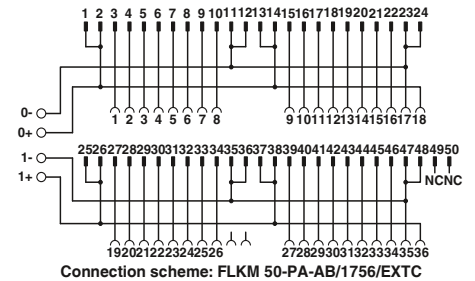

**Explanation:**  

 Flat-ribbon cable strip  
 Connection to I/O card  
 Screw terminal blocks for separate supply

### Allen Bradley ControlLogix, Honeywell PlantScape Front adapter

#### I/O modules with 16 channels or of this type

The front adapters are pushed into the tall 1756-TBE covers (not supplied as standard, original accessories must be ordered directly from manufacturer) of the controller. Two 14-pos. system cables are used to connect up to 2 x 8 channels to the field level.

Tailor-made VARIOFACE termination boards round off this system concept.

#### Web code for the online configurator

 Your web code: #0007

#### Notes:

Front adapters can also be used without cover.



16-channel front adapter  
with two 14-pos. FLK strips



#### Technical data

Max. perm. operating voltage  
Max. permissible current

< 50 V AC / 60 V DC  
1 A (per path)  
8 A (per connection, supply via separate power supply)

Ambient temperature (operation)  
Ambient temperature (storage/transport)  
Connection data solid / stranded / AWG  
Standards/regulations

-20 °C ... 50 °C  
-20 °C ... 70 °C  
0.14 ... 1.5 mm<sup>2</sup> / 0.14 ... 1.5 mm<sup>2</sup> / 28 - 16  
DIN EN 50178 / IEC 60664 / IEC 62103

#### Ordering data

Description	No. of pos.
<b>VARIOFACE front adapter</b> , for ControlLogix:	
- Up to 2 x 8 channels can be connected	14
- IA 16, IB 16, IC 16, IN 16 input card	14
- IF6 I input card (only suitable for measuring current; no power terminals on adapter)	14

Type	Order No.	Pcs. / Pkt.
FLKM 14-PA-AB/1756/EXTC	2302861	1
FLKM 14-PA-AB/1756/IN/EXTC	2302874	1
FLKM 14-PA-AB/1756/IF6/EXTC	2901037	1

#### Front adapters for I/O modules of Allen Bradley ControlLogix and Honeywell PlantScape automation devices

Card type	FLKM 14-PA-AB/1756/EXTC
Digital input	1756-IA 8 D** or TC-IDX 081**
Digital output	1756-OB 16 E
Analog input	1756-IF 6 CIS** 1756-IF 6 I** or TC-IAH 061** 1756-IR 6 I** or TC-IXR 061** 1756-IT 6 I** or TC-IXL 061**
Analog output	1756-OF 4 I** 1756-OF 6 CI** or TC-OAH 061** 1756-OF 6 VI** or TC-OAV 061** 1756-OF 8** or TC-OAV 081** 1756-OF 8 H**
Switch	1756-PLS**

Card type	FLKM 14-PA-AB/1756/IN/EXTC
Digital input	1756-IN 16** 1756-IA 16 or TC-IDA 161** 1756-IB 16 1756-IC 16**

Card type	FLKM 14-PA-AB/1756/IF6/EXTC
Analog input	IF6I**

\*\* Only in conjunction with  
VIP-2/SC/2FLK14/AB-1756, Order No.: 2322333  
VIP-2/PT/2FLK14/AB-1756, Order No.: 2904288  
There must be no voltage supply on the front adapter. Risk of short circuit!

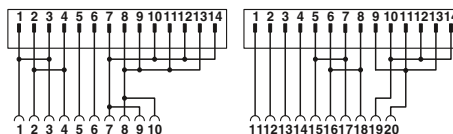

Connection scheme: FLKM 14-PA-AB/1756/IF6/EXTC

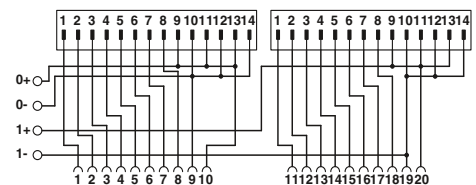

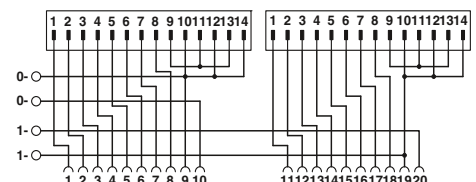

Connection scheme: FLKM 14-PA-AB/1756/EXTC

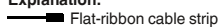
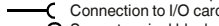

Connection scheme: FLKM 14-PA-AB/1756/IN/EXTC

#### Explanation:

-  Flat-ribbon cable strip
-  Connection to I/O card
-  Screw terminal blocks for separate supply

# System cabling for controllers

## Controller-specific system cabling

### Allen Bradley SLC 500 Front adapter

The front adapters mean that pre-assembled system cables can be directly connected to I/O modules.

- The FLKM 14-PA-SLC500... adapters connect max. 2 x 8 channels via two 14-pos. system cables. Tailor-made VARIOFACE termination boards with a variety of functions and connection options round off this system concept.
- With the FLKM50-PA-SLC500 OUT/2A front adapters, the FLKM 50/16/SLC500 termination board and 50-position system cables, the VARIOFACE system cabling can also be coupled to the OA16 and OW16 power output cards.

### Web code for the online configurator

**i** Your web code: #0007



Front adapter for SLC 500 1746, 2 x 8 channels can be connected



#### Technical data

FLKM 14-PA...	FLKM 50-PA...
< 50 V AC / 60 V DC	< 50 V AC / 60 V DC
1 A (per path)	2 A (per path)
2 A (per byte, for supply via connector)	7 A (per byte, for supply via connector)
-20 °C ... 50 °C	-20 °C ... 50 °C
-20 °C ... 70 °C	-20 °C ... 70 °C
any	any
IEC 60664 / DIN EN 50178 / IEC 62103	IEC 60664 / DIN EN 50178 / IEC 62103

#### Ordering data

Type	Order No.	Pcs. / Pkt.
FLKM 14-PA-SLC500/OUT	2293459	1
FLKM 14-PA-SLC500/IN	2293462	1
FLKM 14-PA-SLC500/IN/M	2293475	1
FLKM 50-PA-SLC500/OUT/2A	2293446	1

Max. perm. operating voltage	< 50 V AC / 60 V DC
Max. permissible current	1 A (per path)
Max. perm. total current	2 A (per byte, for supply via connector)
Ambient temperature (operation)	-20 °C ... 50 °C
Ambient temperature (storage/transport)	-20 °C ... 70 °C
Mounting position	any
Standards/regulations	IEC 60664 / DIN EN 50178 / IEC 62103

Description	No. of pos.
<b>VARIOFACE front adapter, 2 x 8 channels can be connected for Allen Bradley SLC 500 for:</b>	
- 1746 OB16, OV16, OG16 and IG16	14
- 1746 IA16, IB16, ITB16 and IN16	14
- 1746 IV16 and IVT16	14
<b>VARIOFACE front adapter, 1 x 16 channels can be connected for Allen Bradley SLC 500 1746 OA16 and OW16</b>	
	50

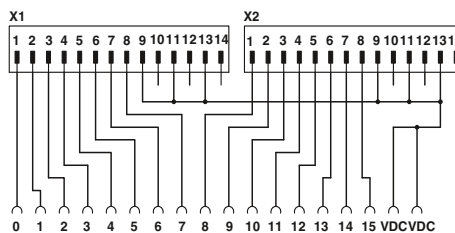

Connection scheme FLKM 14-PA-SLC500/IN/M

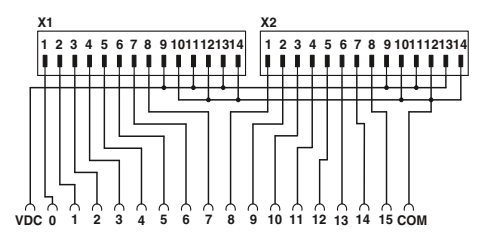

Connection scheme FLKM 14-PA-SLC500/OUT

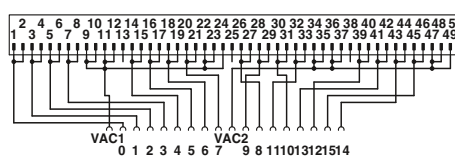

Connection scheme FLKM 50-PA-SLC500/OUT/2A

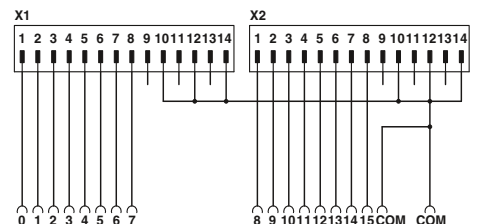

Connection scheme FLKM 14-PA-SLC500/IN

#### Explanation:

- Flat-ribbon cable strip
- Connection to I/O card
- Screw terminal blocks for separate supply

### VIP termination board for Allen Bradley SLC 500, 2 A output cards

The VIP-2/.../FLK50/16/SLC500 VARIOFACE Professional (VIP) module has been designed specifically for OA16 and OW16 output modules. When used in conjunction with the FLKM 50-PA-SLC500/OUT/2A front adapter, currents up to 2 A per channel can be transferred with the system cabling.

**Notes:**

For marking systems (e.g., "ZB 22:UNBEDRUCKT"; Order No. 0811862) and mounting material, see Catalog 5.



**VARIOFACE termination board for 16 channels with screw connection**

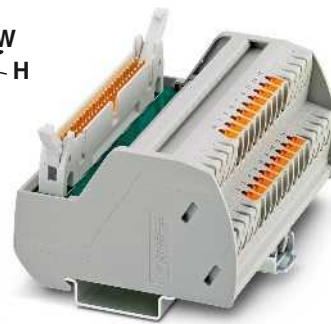

**VARIOFACE termination board for 16 channels with push-in connection**



**Technical data**

Max. perm. operating voltage	120 V AC/DC
Max. perm. current (per branch)	1 A
Max total current (voltage supply)	2 A (per channel)
Ambient temperature (operation)	-20 °C ... 50 °C
Mounting position	any
Standards/regulations	IEC 60664, DIN EN 50178, IEC 62103
Connection method	Screw connection
	Field level
	Controller level
Connection data solid / stranded / AWG	IDC/FLK pin strip (2.54 mm) 0.2 ... 4 mm <sup>2</sup> / 0.2 ... 2.5 mm <sup>2</sup> / 24 - 12
Dimensions	65.5 mm / 56 mm

**Technical data**

Max. perm. operating voltage	120 V AC/DC
Max. perm. current (per branch)	1 A
Max total current (voltage supply)	2 A (per channel)
Ambient temperature (operation)	-20 °C ... 50 °C
Mounting position	any
Standards/regulations	EN 50178
Connection method	Push-in connection
	Field level
	Controller level
Connection data solid / stranded / AWG	IDC/FLK pin strip (2.54 mm) 0.14 ... 2.5 mm <sup>2</sup> / 0.14 ... 2.5 mm <sup>2</sup> / 26 - 14
Dimensions	72.1 mm / 56 mm

**Ordering data**

Description	No. of pos.	Module width W
<b>VARIOFACE controller board</b> , for transfer of max. 16 channels, only in connection with FLKM 50-PA-SLC500 OUT/2A		
- with screw connection	50	90.8 mm
- with push-in connection	50	92.7 mm

Type	Order No.	Pcs. / Pkt.
VIP-2/SC/FLK50/16/SLC500	2322320	1

**Ordering data**

Type	Order No.	Pcs. / Pkt.
VIP-2/PT/FLK50/16/SLC500	2904287	1

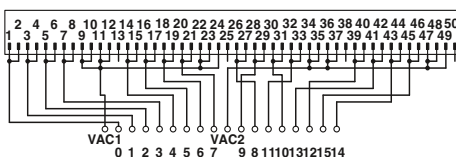

Connection scheme VIP-2/.../FLK50/16/SLC500

# System cabling for controllers

## Controller-specific system cabling

### Allen Bradley SLC 500 System cable for 32 channels

The 32-channel I/O cards of the SLC 500 are connected using 40-pos. connectors (already integrated into the I/O modules). Passive interface modules (-3/SC/FLK40, etc.) are connected to the I/O cards using the **FLK 40/EZ-DR/.../SLC** system cables.

32 channels are split into 4x8 channels using the **FLK 40/4X14/EZ-DR/...** system cables.

The following 8-channel system cabling modules can be coupled:

- OB32 and IB32  
passive and active modules plus V8 adapter
- OV32 and IV32  
passive modules without status indicator

### Web code for the online configurator

**i** Your web code: #0007



**System cable for  
32-channel I/O cards of the SLC 500  
(OB32, OV32, IB32, IV32)**

ERC

#### Technical data

< 50 V AC / 60 V DC  
1 A  
-20 °C ... 50 °C  
Insulation displacement, IEC 60352-4/DIN EN 60352-4

AWG 26 / 0.14 mm<sup>2</sup>  
7 / Cu tin-plated

Max. perm. operating voltage  
Max. perm. current carrying capacity per path  
Ambient temperature (operation)  
Assembly

Conductor cross section  
Conductor structure: stranded wires / material  
Outside diameter

40-position

10 mm

#### Ordering data

Description	No. of pos.	Cable length
<b>Assembled round cable</b> , with two 40-pos. socket strips in fixed lengths (50 cm increments) for connection to 32-channel I/O cards of the SLC 500		
	40	0.5 m
	40	1 m
	40	1.5 m
	40	2 m
	40	3 m
<b>Assembled round cable</b> , for connection to Allen-Bradley SLC500, OB32 and IB32, with one 40-position socket strip and four 14-position socket strips, for splitting max. 32 channels into 4 x 8 channels.		
for OB32	40	0.5 m
	40	1 m
	40	2 m
	40	3 m
for IB32	40	0.5 m
	40	1 m
	40	2 m
	40	3 m

Type	Order No.	Pcs. / Pkt.
FLK 40/EZ-DR/ 50/SLC	2294610	1
FLK 40/EZ-DR/ 100/SLC	2294623	1
FLK 40/EZ-DR/ 150/SLC	2294636	1
FLK 40/EZ-DR/ 200/SLC	2294649	1
FLK 40/EZ-DR/ 300/SLC	2294652	1



**System cable for  
splitting max. 32 channels into 4 x 8 channels  
(OB32, IB32)**

ERC

**Technical data**

< 50 V AC / 60 V DC  
1 A  
-20 °C ... 50 °C  
Insulation displacement, IEC 60352-4/DIN EN 60352-4

AWG 26 / 0.14 mm<sup>2</sup>  
7 / Cu tin-plated

7.8 mm

**Ordering data**

Type	Order No.	Pcs. / Pkt.
FLK 40/4X14/EZ-DR/ 50/OB32	2296786	1
FLK 40/4X14/EZ-DR/ 100/OB32	2298483	1
FLK 40/4X14/EZ-DR/ 200/OB32	2298522	1
FLK 40/4X14/EZ-DR/ 300/OB32	2298535	1
FLK 40/4X14/EZ-DR/ 50/IB32	2296812	1
FLK 40/4X14/EZ-DR/ 100/IB32	2296825	1
FLK 40/4X14/EZ-DR/ 200/IB32	2296838	1
FLK 40/4X14/EZ-DR/ 300/IB32	2296841	1

## Controller-specific system cabling

### Emerson DeltaV System cable

The DeltaV system allows you to install the process wiring through “mass termination blocks” (MTB) using flat-ribbon cable connectors. In addition to the 10, 16, and 20-pos. system cables of system cabling (see page 574), the following system-specific cables are available:

- **FLK 16/14/DV-OUT/...**, for digital modules with 16-pos. MTB for connection to PLC-INTERFACE
- **FLK 16/14/DV-IN/...**, for digital modules with 16-pos. MTB for connection to PLC-INTERFACE
- **FLK 20/2FLK14/EZ-DR/...**, for digital modules with 40-pos. MTB for connection to PLC-INTERFACE
- **FLK 16/24/DV-AI/EZ-DR/...**, for analog modules with 24-pos. MTB
- **FLK 50/2FLK20/EZ-DR/.../DV** system cables are specifically designed for 32-channel I/O modules with 40-pin MTB for the purpose of connecting I/O modules to 32-channel VARIOFACE interface modules



System cable for DeltaV

ERC

#### Technical data

Max. perm. operating voltage	< 50 V AC / 60 V DC	
Max. perm. current carrying capacity per path	1 A	
Max. conductor resistance	0.16 Ω/m	
Ambient temperature (operation)	-20 °C ... 50 °C	
Conductor cross section	AWG 26 / 0.14 mm <sup>2</sup>	
Outside diameter		
	16-position	6.8 mm
	20-position	7.6 mm
	24-position	6.5 mm
	20-position	10.3 mm

#### Ordering data

Description	No. of pos.	Cable length	Type	Order No.	Pcs. / Pkt.
<b>System cable</b> , for 16-pos. “mass termination blocks” with a 16-pos. and a 14-pos. flat-ribbon cable connector for connection to PLC-INTERFACE					
	16	0.3 m	FLK 16/14/DV-OUT/ 30	2304348	1
	16	0.5 m	FLK 16/14/DV-OUT/ 50	2304351	1
	16	1 m	FLK 16/14/DV-OUT/100	2300575	1
	16	2 m	FLK 16/14/DV-OUT/200	2300588	1
	16	3 m	FLK 16/14/DV-OUT/300	2304364	1
Variable cable length	16		FLK 16-14-DV-OUT/...	2304377	1
<b>System cable</b> , for 16-pos. “mass termination blocks” with a 16-pos. and a 14-pos. flat-ribbon cable connector for connection to PLC-INTERFACE					
	16	0.5 m	FLK 16/14/DV-IN/ 50	2304393	1
	16	1 m	FLK 16/14/DV-IN/100	2300559	1
	16	2 m	FLK 16/14/DV-IN/200	2300562	1
	16	3 m	FLK 16/14/DV-IN/300	2304403	1
	16	4 m	FLK 16/14/DV-IN/400	2305185	1
Variable cable length	16		FLK 16-14-DV-IN/...	2304416	1
<b>System cable</b> , for 40-pos. (2 x 20) “mass termination blocks” with a 20-pos. and two 14-pos. flat-ribbon cable connectors for connection to PLC-INTERFACE (two cables should be used per 32-channel I/O card)					
	20	1 m	FLK 20/2FLK14/EZ-DR/100/KONFEK	2298470	1
	20	2 m	FLK 20/2FLK14/EZ-DR/200/KONFEK	2298438	1
	20	3 m	FLK 20/2FLK14/EZ-DR/300/KONFEK	2300818	1
Variable cable length	20		FLK 20/2FLK14/EZ-DR/...	2304487	1
<b>System cable</b> , for 24-pos. “mass termination blocks” with a 24-pos. and a 16-pos. flat-ribbon cable connector for connection to with UM-DELTA/... modules					
	24	0.3 m	FLK 16/24/DV-AI/EZ-DR/ 30	2304319	1
	24	0.5 m	FLK 16/24/DV-AI/EZ-DR/ 50	2304296	1
	24	1 m	FLK 16/24/DV-AI/EZ-DR/100	2301134	1
	24	2 m	FLK 16/24/DV-AI/EZ-DR/200	2301545	1
	24	3 m	FLK 16/24/DV-AI/EZ-DR/300	2304322	1
Variable cable length	24		FLK 16-24-DV-AI-EZ-DR/...	2304335	1
<b>System cable</b> , for 40-pos. “mass termination blocks” with two 20-pos. and one 50-pos. flat-ribbon cable connectors for connection to 32-channel interface modules					
	20	0.5 m	FLK 50/2FLK20/EZ-DR/ 50/DV	2304872	1
	20	1 m	FLK 50/2FLK20/EZ-DR/ 100/DV	2304898	1
	20	2 m	FLK 50/2FLK20/EZ-DR/ 200/DV	2304908	1
	20	3 m	FLK 50/2FLK20/EZ-DR/ 300/DV	2304911	1
	20	6 m	FLK 50/2FLK20/EZ-DR/ 600/DV	2304937	1
	20	8 m	FLK 50/2FLK20/EZ-DR/ 800/DV	2304940	1
	20	10 m	FLK 50/2FLK20/EZ-DR/1000/DV	2304953	1
Variable cable length	20		FLK 50-2FLK20-EZ-DR/DV/...	2304966	1





### Emerson DeltaV Controller board for eight channels

These system-specific interface modules for DeltaV modules are used in combination with the respective system cables. The controller board is connected to 8-channel modules through “mass termination blocks” with flat-ribbon cable connection.

#### FLKM 16/DV

- Universal module
- 1:1 connection

#### FLKM 16/AI/DV

- 1:1 connection
- Separate equipotential terminals per channel

#### FLKM 16/AO/SI/DV

- 1:1 connection
- Fuse 5 x 20, 50 mA T, IEC60127-2/3 per channel

#### FLKM 16/DI/SI/LA/DV

- 1:1 connection
- Fuse 5 x 20, 50 mA T, IEC60127-2/3 per channel
- LED status indicator per signal path

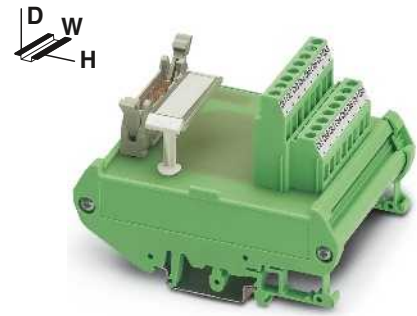

Interface module for 8 channels

Max. perm. operating voltage  
Max. perm. current (per branch)

Ambient temperature (operation)  
Mounting position  
Standards/regulations  
Connection method

Connection data solid / stranded / AWG  
Dimensions

Field level  
Controller level

Technical data	
FLKM 16/.../DV < 50 V AC / 60 V DC 1 A (per signal path)	FLKM 16/.../SI/.../DV < 50 V AC / 60 V DC 50 mA (in delivered state, with one 50 mA fuse, max. 1 A permitted)
-20 °C ... 50 °C any DIN EN 50178, IEC 60664, IEC 62103	-20 °C ... 50 °C any DIN EN 50178, IEC 60664, IEC 62103
Screw connection IDC/FLK pin strip (2.54 mm)	Screw connection IDC/FLK pin strip (2.54 mm)
0.2 ... 4 mm <sup>2</sup> / 0.2 ... 2.5 mm <sup>2</sup> / 24 - 12 90 mm / 68 mm	

Ordering data		
Type	Order No.	Pcs. / Pkt.
FLKM 16/DV	2304432	1
FLKM 16/AI/DV	2304429	1
FLKM 16/AO/SI/DV	2304445	1
FLKM 16/DI/SI/LA/DV	2304458	1

Description	No. of pos.	Module width W
Interface module, with 1:1 connection	16	45 mm
Interface module, with 1:1 connection and separate potential terminal blocks per channel	16	57 mm
Interface module, with fuses per channel	16	90 mm
Transfer module, with LED and fuses per channel, max. permitted operating voltage 30 V DC	16	90 mm

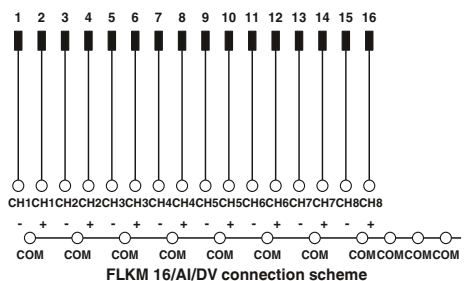
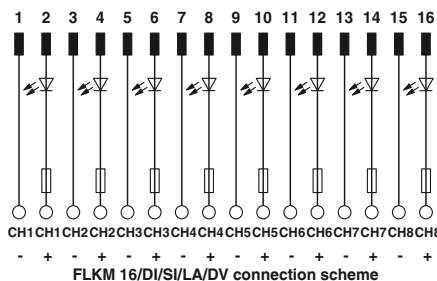
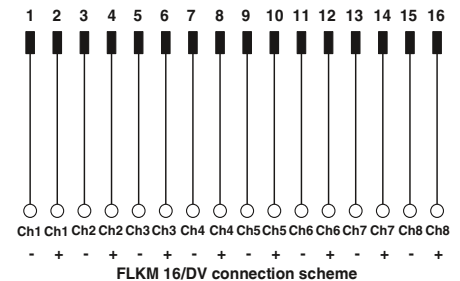
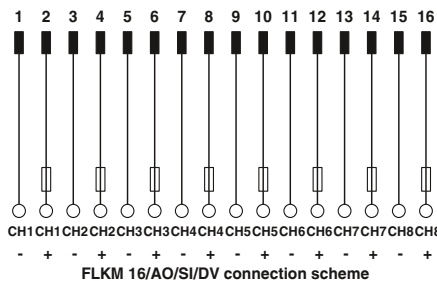

# System cabling for controllers

## Controller-specific system cabling

### Emerson DeltaV Controller board for 32 channels

These system-specific interface modules for DeltaV modules are used in combination with the FLK 50/2FLK20/EZ-DR/.../DV system cables. The controller board is connected to 32-channel modules through 40-pos. "mass termination blocks" with flat-ribbon cable connection.

#### FLKM 50/32M/DV

- Can be used for 32-channel input and output cards
- Two-conductor connection with a separate negative terminal per channel

#### FLKM 50/32M/IN/LA/DV

- Can be used for 32-channel input modules
- LED status display per channel
- Two-conductor connection with a separate negative terminal per channel (Dry Contact)

Max. perm. operating voltage	< 50 V AC / 60 V DC
Max. perm. current (per branch)	1 A
Ambient temperature (operation)	-20 °C ... 50 °C
Mounting position	any
Standards/regulations	DIN EN 50178, IEC 60664, IEC 62103
Connection method	Screw connection
	Field level
	Controller level
Connection data solid / stranded / AWG	0.2 ... 4 mm <sup>2</sup> / 0.2 ... 2.5 mm <sup>2</sup> / 24 - 12
Dimensions	H / D 90 mm / 68 mm

Description	No. of pos.	Module width W
<b>VARIOFACE interface modules</b> , for 32-channel I/O modules:		
- Input/output	50	169 mm
- Input with LED per signal	50	169 mm

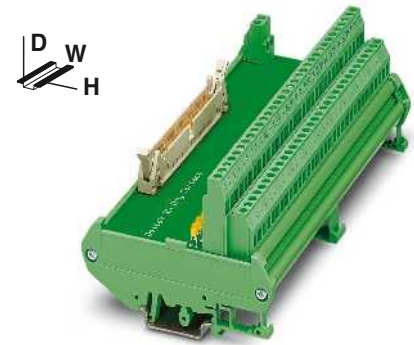

Interface module with two-conductor connection technology for DeltaV

Technical data	
FLKM 50/32M/DV	FLKM 50/32M/IN/LA/DV
< 50 V AC / 60 V DC	30 V DC
1 A	1 A
-20 °C ... 50 °C	-20 °C ... 50 °C
any	any
DIN EN 50178, IEC 60664, IEC 62103	
Screw connection	Screw connection
Field level	Controller level
IDC/FLK pin strip (2.54 mm)	IDC/FLK pin strip (2.54 mm)
Connection data solid / stranded / AWG	0.2 ... 4 mm <sup>2</sup> / 0.2 ... 2.5 mm <sup>2</sup> / 24 - 12
Dimensions	H / D 90 mm / 68 mm

Ordering data		
Type	Order No.	Pcs. / Pkt.
FLKM 50/32M/DV	2304869	1
FLKM 50/32M/IN/LA/DV	2304856	1

### Emerson DeltaV VIP controller board with fuses for 8 channels

System-specific interface module for use in combination with the respective system cables. The controller board is connected to 8-channel modules through 16-position "mass termination blocks" with flat ribbon cable connection.

Features:

- Fuse per channel
- Separate equipotential terminals per channel
- Knife disconnection for each channel
- Push-in connection

Max. perm. operating voltage	24 V DC
Max. perm. current (per branch)	63 mA (in as supplied state, with one 63 mA fuse)
Ambient temperature (operation)	-20 °C ... 60 °C
Mounting position	any
Standards/regulations	DIN EN 50178
Connection method	Push-in connection
	Field level
	Controller level
Connection data solid / stranded / AWG	0.14 ... 2.5 mm <sup>2</sup> / 0.14 ... 2.5 mm <sup>2</sup> / 26 - 14
Dimensions	H / D 109.8 mm / 63 mm

Description	No. of pos.	Module width W
<b>Interface module</b> for 16-pos. mass termination block	16	57.1 mm

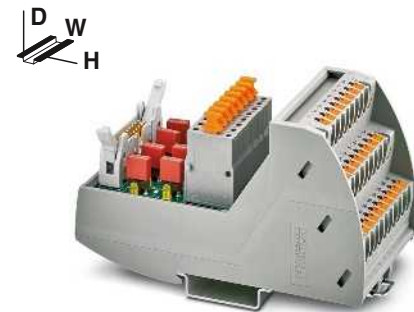

Interface module with fuses for 16-pos. mass termination block

Technical data	
24 V DC	63 mA (in as supplied state, with one 63 mA fuse)
-20 °C ... 60 °C	any
any	DIN EN 50178
DIN EN 50178	
Push-in connection	
Field level	Controller level
IDC/FLK pin strip (2.54 mm)	
Connection data solid / stranded / AWG	0.14 ... 2.5 mm <sup>2</sup> / 0.14 ... 2.5 mm <sup>2</sup> / 26 - 14
Dimensions	H / D 109.8 mm / 63 mm

Ordering data		
Type	Order No.	Pcs. / Pkt.
VIP-PT/FLK16/DS/FU/LED/AN/DV	2903599	1

### Emerson DeltaV Controller boards with fuses for 8 channels

These system-specific interface modules for DeltaV modules are used in combination with the respective system cables. The controller board is connected to 8-channel modules through 16-pos. or 24-pos. "mass termination blocks" with flat-ribbon cable connection.

#### UM-DELTA V/D/SI

- Fuse per channel
- Separate equipotential terminals per channel

#### UM-DELTA V/D/SI

- Fuse per channel
- Separate equipotential terminals per channel
- Knife disconnection for each channel

#### UM-DELTA V/D/SI/BFI/TP

- Fuse and LED status indicator per channel
- Separate equipotential terminals per channel

### UM-DELTA V/D/SI

- Fuse and LED status indicator per channel
- Separate equipotential terminals per channel
- Knife disconnection for each channel

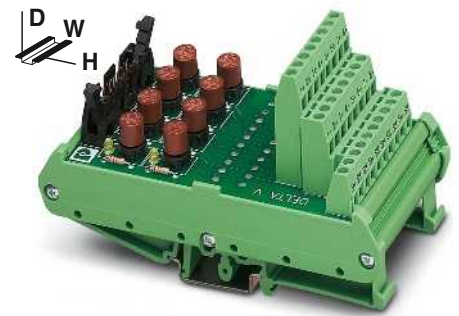

Interface module with fuses for 16-pos. and 24-pos. "mass termination blocks"



#### Technical data

Max. perm. operating voltage	24 V DC
Max. perm. current (per branch)	50 mA (in as-supplied state, with one 50 mA fuse, max. 1 A permitted)
Ambient temperature (operation)	-20 °C ... 50 °C
Mounting position	any
Standards/regulations	IEC 60664, DIN EN 50178, IEC 62103
Connection method	Screw connection
	IDC/FLK pin strip (2.54 mm)
	0.2 ... 4 mm <sup>2</sup> / 0.2 ... 2.5 mm <sup>2</sup> / 24 - 12
Dimensions	126 mm / 71 mm

#### Ordering data

Type	Order No.	Pcs. / Pkt.
UM-DELTA V/D/SI	5603255	1
UM-DELTA V/D/SI/BFI/TP	5603257	1
UM-DELTA V/A/SI	5603256	1
UM-DELTA V/A/SI/BFI/TP	5603258	1

Field level	Connection method
Controller level	Dimensions
	H / D

Description	No. of pos.	Module width W
<b>Interface modules for 16-pos. and 24-pos. "mass termination blocks" with:</b>		
- Fuses	16	61 mm
- Fuses and knife disconnect terminal blocks	16	61 mm
- Fuses and fuse failure display	16	61 mm
- Fuses, fuse failure display and knife disconnect terminal blocks	16	61 mm

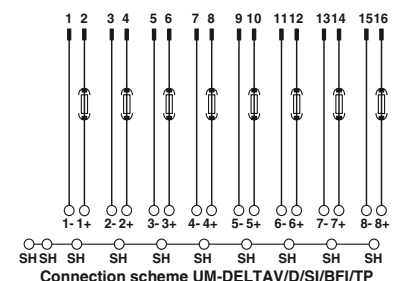
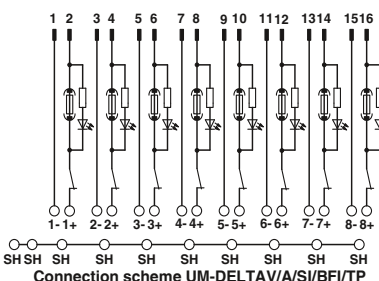
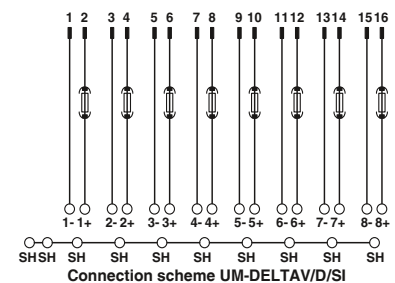
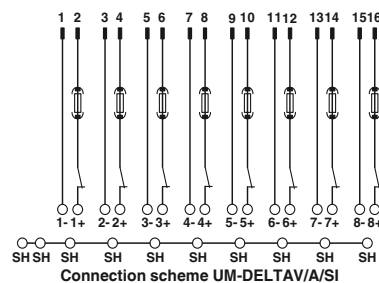

#### Explanation:

- Flat-ribbon cable strip
- Connection to I/O card
- Screw terminal blocks for separate supply

# System cabling for controllers

## Controller-specific system cabling

### GE Fanuc/RX3i Front adapters

The front adapters mean that pre-assembled system cables can be directly connected to I/O modules.

- Transfer of max. 32 channels over one 50-position system cable
- Can be plugged onto I/O modules
- Connection via suitable VARIOFACE termination boards

### Web code for the online configurator

**i** Your web code: #0007



Front adapter for GE Fanuc RX3i

### Technical data

Max. perm. operating voltage	< 50 V AC / 60 V DC
Max. permissible current	1 A (per path) 8 A (per connection, supply via separate power supply)
Ambient temperature (operation)	-20 °C ... 50 °C
Ambient temperature (storage/transport)	-20 °C ... 70 °C
Mounting position	any
Standards/regulations	DIN EN 50178 / IEC 60664 / IEC 62103

### Ordering data

Description	No. of pos.	Type	Order No.	Pcs. / Pkt.
<b>VARIOFACE front adapter, for PACSystems RX3i,</b>				
For digital output and analog modules	50	FLKM 50-PA-GE/TKFC/RXI	2321473	1
For digital input modules	50	FLKM 50-PA-GE/TKFC/RXI/IN	2321486	1

#### Front adapter for I/O modules of RX3i series

Card type	FLKM 50-PA-GE/TKFC/RXI
Digital output	IC 694 MDL 754

Card type	FLKM 50-PA-GE/TKFC/RXI/IN
Digital input	IC 694 MDL 660

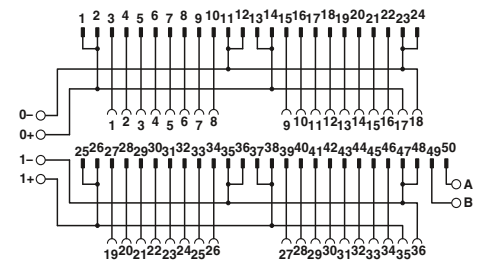

Connection scheme for FLKM 50-PA-GE/TKFC/RXI

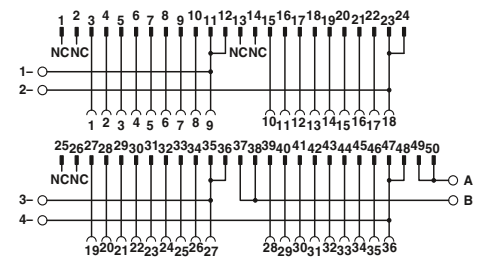

Connection scheme for FLKM 50-PA-GE/TKFC/RXI/IN

#### Explanation:

- Flat-ribbon cable strip
- Connection to I/O card
- Screw terminal blocks for separate supply

### GE-FANUC, Series 90-30 Front adapter

The front adapters mean that pre-assembled system cables can be directly connected to I/O modules.

Up to 2 x 8 channels are connected via two 14-pos. system cables.

Tailor-made VARIOFACE termination boards with a variety of functions and connection options round off this system concept.

#### Web code for the online configurator

**i** Your web code: #0007



Front adapter for GE-FANUC  
Series 90-30



#### Technical data

Max. perm. operating voltage  
Max. permissible current

< 50 V AC / 60 V DC  
1 A (per path)  
4 A (per connection, supply via separate power supply)

Max. perm. total current

3 A (per byte, for supply via connector)

Ambient temperature (operation)  
Ambient temperature (storage/transport)  
Mounting position  
Standards/regulations

-20 °C ... 50 °C  
-20 °C ... 70 °C  
any  
IEC 60664 / DIN EN 50178 / IEC 62103

#### Ordering data

Description	No. of pos.
<b>VARIOFACE front adapter</b> , for Series 90-30, max. 2 x 8 channels can be connected, digital output	14
<b>VARIOFACE front adapter</b> , for Series 90-30, max. 2 x 8 channels can be connected, digital input	14

Type	Order No.	Pcs. / Pkt.
<b>FLKM 14-PA/GE/DO</b>	2290009	2
<b>FLKM 14-PA/GE/DI</b>	2290038	5

#### Front adapter for Series 90-30 I/O modules

Card type	FLKM 14-PA/GE/DO
<b>Digital output</b>	IC 693 MDL 732 IC 693 MDL 733* IC 693 MDL 740 IC 693 MDL 741* IC 693 MDL 742
<b>Analog</b>	IC 693 ALG 220* IC 693 ALG 221* IC 693 ALG 222* IC 693 ALG 223* IC 693 ALG 390* IC 693 ALG 391* IC 693 ALG 392* IC 693 ALG 442*

Card type	FLKM 14-PA/GE/DI
<b>Digital input</b>	IC 693 MDL 241 IC 693 MDL 634 IC 693 MDL 645 IC 693 MDL 646

\* Only in conjunction with VIP-2/SC/2FLK14(1-20)/S7, Order No.: 2315230 and UM 45-2FLK14/ZFKDS/S7, Order No.: 2965156. All wire jumpers (DR) on the adapter must be disconnected. There must be no voltage supply at the front adapter (flowing via the slip-on connections)!

#### Explanation:

- Flat-ribbon cable strip
- Connection to I/O card
- Screw terminal blocks for separate supply

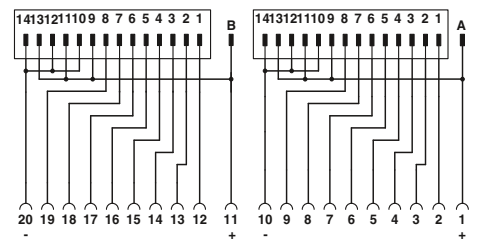

Connection scheme FLKM 14-PA/GE/DO

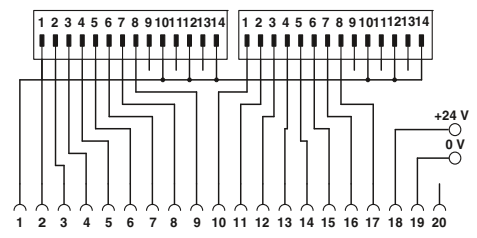

Connection scheme FLKM 14-PA/GE/DI

# System cabling for controllers

## Controller-specific system cabling

### Honeywell C300, Series CI/O Front adapters

The front adapters mean that pre-assembled system cables can be directly connected to I/O modules.

#### FLKM-PA-D37/HW/DIO/C300

- Front adapter with D-SUB connector
- Connection of a maximum of 16 digital channels
- Specifically for digital I/O cards

#### FLKM-PA-D37/HW/AN/C300

- Front adapter with D-SUB connector
- Connection of analog modules

#### FLKM-PA-2D15/HW/.../C300

- Front adapter with two 15-pos. D-SUB connectors
- Connection of a maximum of 2 x 8 digital inputs/outputs per adapter
- Specifically for connecting PLC-V8/D15.../OUT or PLC-V8/D15.../IN

### Web code for the online configurator

**i** Your web code: #0007

Front adapter for I/O modules of Series C300, Series CI/O

Card type	FLKM-PA-D37/HW/DIO/C300
Digital input	TDIL 11* TDIL 01*
Digital output	TDOB 11* TDOB 01*

Card type	FLKM-PA-D37/HW/AN/C300
Analog input	TAIX 01** TAIX 11**
Analog output	TAOX 01** TAOX 11**

Card type	FLKM-PA-2D15/HW/DO/C300
Digital output	TDOB 01* TDOB 11*

Card type	FLKM-PA-2D15/HW/DI/C300
Digital input	TDIL 01* TDIL 11*

\* Two front adapters are required for each module.

\*\* For three-conductor operation (channels 13 - 16) of input modules: only in conjunction with VIP-3/SC/D37SUB/M/HW/C300, Order No. 2900675.

#### Notes:

Matching system cable fitted with D-SUB socket strip at both ends, see page 611



Honeywell C300 front adapter



#### Technical data

60 V DC  
1 A (per path)  
-20 °C ... 50 °C  
-20 °C ... 70 °C  
any  
IEC 60664 / DIN EN 50178 / IEC 62103

#### Ordering data

Description	No. of pos.
<b>VARIOFACE front adapter</b> for Series CI/O, with one D-SUB pin strip	
- For digital I/O modules	37
- For analog I/O modules	37
<b>VARIOFACE front adapter</b> for Series CI/O, with two D-SUB pin strips	
- For digital output modules	15
- For digital input modules	15

Type	Order No.	Pcs. / Pkt.
<b>FLKM-PA-D37/HW/DIO/C300</b>	<b>2901423</b>	1
<b>FLKM-PA-D37/HW/AN/C300</b>	<b>2900622</b>	1
<b>FLKM-PA-2D15/HW/DO/C300</b>	<b>2900924</b>	1
<b>FLKM-PA-2D15/HW/DI/C300</b>	<b>2901879</b>	1

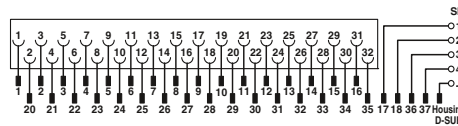

Connection scheme: FLKM-PA-D37/HW/AN/C300

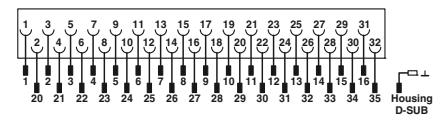

Connection scheme: FLKM-PA-D37/HW/DIO/C300

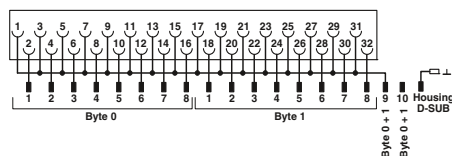

FLKM-PA-2D15/HW/DI/C300 connection scheme

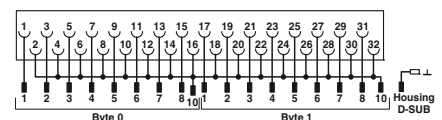

Connection scheme: FLKM-PA-2D15/HW/DO/C300

#### Explanation:

- Connector
- Connection to I/O card
- Screw terminal blocks for separate supply



### Honeywell C300, Series CI/O Interface modules

These VARIOFACE modules are used in combination with 37-pos. D-SUB cables and the relevant front adapters. The three module versions are available with screw or push-in connection technology.

#### VIP-2/.../D37SUB/M

- In conjunction with FLKM-PA-D37/HW/C300 or FLKM-PA-D37/HW/AN/C300 front adapter
- Universal module
- Field connection via double-level terminal blocks

#### VIP-2/.../D37SUB/M/SO

- In conjunction with FLKM-PA-D37/HW/C300 front adapter
- System-specific marking
- Field connection via double-level terminal blocks

#### VIP-3/.../D37SUB/M/HW/C300

- In conjunction with FLKM-PA-D37/HW/AN/C300 front adapter
- System-specific marking
- For TAIX01, TAIX11 analog input modules
- Field connection via three-level terminal blocks

#### Web code for the online configurator

**i** Your web code: #0007

#### Notes:

For marking systems (e.g., "ZB 22:UNBEDRUCKT"; Order No. 0811862) and mounting material, see Catalog 5.

Max. perm. operating voltage	
Max. perm. current (per branch)	
Ambient temperature (operation)	
Mounting position	
Standards/regulations	
Connection method	D-SUB connection
Dimensions	H / D
Screw connection solid / stranded / AWG	
Push-in connection solid / stranded / AWG	

Description	No. of pos.	Module width W
<b>VARIOFACE front module</b> , with D-SUB pin strip and universal marking,		
- with screw connection	37	101 mm
- with push-in connection	37	102.8 mm
<b>VARIOFACE front module</b> , with D-SUB pin strip and system specific marking,		
- with screw connection	37	101 mm
- with push-in connection	37	102.8 mm
<b>VARIOFACE front module</b> , with D-SUB pin strip for analog input modules,		
- with screw connection	37	88 mm
- with push-in connection	37	87.6 mm

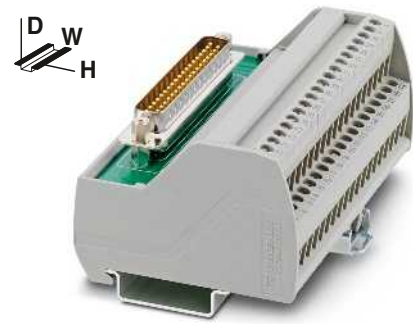

37-pos. with screw or push-in connection



#### Technical data

VIP-2/...	VIP-3/...C300
125 V AC/DC	125 V AC/DC
2 A	2 A
-20 °C ... 50 °C	-20 °C ... 50 °C
any	any
DIN EN 50178	
D-SUB pin strip	D-SUB pin strip
72.1 mm / 46.6 mm	75.8 mm / 63 mm
0.2 ... 4 mm <sup>2</sup> / 0.2 ... 2.5 mm <sup>2</sup> / 24 - 12	
0.14 ... 4 mm <sup>2</sup> / 0.14 ... 2.5 mm <sup>2</sup> / 26 - 14	

#### Ordering data

Type	Order No.	Pcs. / Pkt.
VIP-2/SC/D37SUB/M	2900676	1
VIP-2/PT/D37SUB/M	2904277	1
VIP-2/SC/D37SUB/M/SO	2900786	1
VIP-2/PT/D37SUB/M/SO	2904278	1
VIP-3/SC/D37SUB/M/HW/C300	2900675	1
VIP-3/PT/D37SUB/M/HW/C300	2904276	1

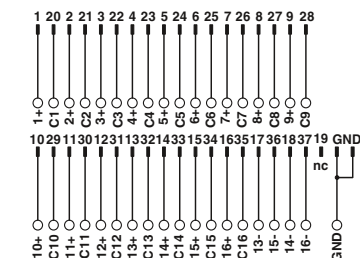

Connection scheme VIP-3/SC/D37SUB/M/HW/C300

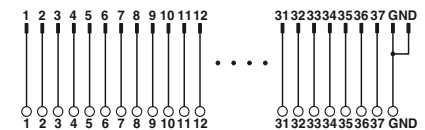

Connection scheme VIP-2/SC/D37SUB/M

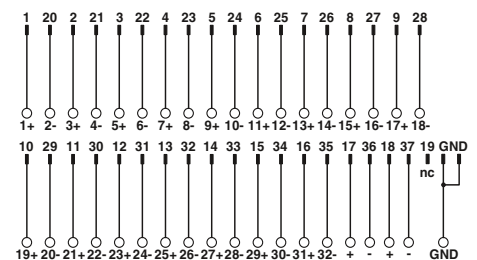

Connection scheme VIP-2/SC/D37SUB/M/SO



# System cabling for controllers

## Controller-specific system cabling

### Mitsubishi Electric MELSEC A, A1S, and Q System cable

For 32/64-channel I/O cards with 37-pos. D-SUB connectors. System cables are available for connecting 1 x 32 channels or 4 x 8 channels.

#### Web code for the online configurator

 Your web code: #0007



**System cable,  
D-SUB socket strip on FLK,  
number of positions: 37 on 50**



**Splitting cable,  
D-SUB socket strip on FLK,  
number of positions: 37 on 4 x 14**



Max. perm. operating voltage  
Max. perm. current carrying capacity per path  
Max. conductor resistance  
Ambient temperature (operation)  
Conductor cross section  
Conductor structure: stranded wires / material  
Outside diameter

< 50 V AC / 60 V DC  
1 A  
0.16 Ω/m  
-20 °C ... 50 °C  
AWG 26 / 0.14 mm<sup>2</sup>  
7 / Cu tin-plated

< 50 V AC / 60 V DC  
1 A  
0.16 Ω/m  
-20 °C ... 50 °C  
AWG 26 / 0.14 mm<sup>2</sup>  
7 / Cu tin-plated

37-position

10.5 mm

6.3 mm

#### Technical data

#### Technical data

#### Ordering data

#### Ordering data

Description	No. of pos.	Cable length
<b>Round cable for output module</b> MELSEC Q Y81 P, MELSEC A1S Y81, and MELSEC A AY82EP, in standard lengths		
	37	0.5 m
	37	1 m
	37	2 m
	37	3 m
<b>Round cable, as above, however in variable lengths</b>		
	37	
<b>Round cable for input module</b> MELSEC Q X81, MELSEC A1S X81, and MELSEC A AX82, in standard lengths		
	37	0.5 m
	37	1 m
	37	2 m
	37	3 m
<b>Round cable, as above, however in variable lengths</b>		
	37	

Type	Order No.	Pcs. / Pkt.
FLK 50/EZ-DR/D37SUB/ 50/Y81P-O	2302599	1
FLK 50/EZ-DR/D37SUB/100/Y81P-O	2302609	1
FLK 50/EZ-DR/D37SUB/200/Y81P-O	2302612	1
FLK 50/EZ-DR/D37SUB/300/Y81P-O	2302638	1
FLK 50-EZ-DR-D37SUB-Y81P-O/...	2302625	1
FLK 50/EZ-DR/D37SUB/ 50/X81-I	2302641	1
FLK 50/EZ-DR/D37SUB/100/X81-I	2302654	1
FLK 50/EZ-DR/D37SUB/200/X81-I	2302667	1
FLK 50/EZ-DR/D37SUB/300/X81-I	2302670	1
FLK 50-EZ-DR-D37SUB-X81-I/...	2302683	1

Type	Order No.	Pcs. / Pkt.
CABLE-D37-M2,5/4X14/ 50/Y81P-O	2302476	1
CABLE-D37-M2,5/4X14/100/Y81P-O	2302489	1
CABLE-D37-M2,5/4X14/200/Y81P-O	2302492	1
CABLE-D37-M2,5/4X14/300/Y81P-O	2302502	1
CABLE-D37-M2,5-4X14-Y81P-O/...	2302696	1
CABLE-D37-M2,5/4X14/ 50/X81-I	2302515	1
CABLE-D37-M2,5/4X14/100/X81-I	2302528	1
CABLE-D37-M2,5/4X14/200/X81-I	2302531	1
CABLE-D37-M2,5/4X14/300/X81-I	2302544	1
CABLE-D37-M2,5-4X14-X81-I/...	2302706	1

#### Ordering example for system cable:

– Cable for MELSEC Q Y81P, 12.75 m long

Quantity      Order No.      Length [m]<sup>1)</sup>

1	2302625	12.75
---	---------	-------

<sup>1)</sup> min. 0.20 m

#### Ordering examples for splitting cable:

– Cable for MELSEC Q Y81P, 11.00 m long

Quantity      Order No.      Length [m]<sup>1)</sup>

1	2302696	11.00
---	---------	-------

<sup>1)</sup> min. 0.20 m

**Mitsubishi Electric  
MELSEC L/Q and Honeywell ML 200  
System cables**

These system cables are plugged onto the I/O cards that are connected using Fujitsu connectors.

**CABLE-FCN40/1X50/...**

– Signal transmission of 32 channels

**CABLE-FCN40/4X14/...**

– Splitting up 32 channels into 4 x 8 channels

**Web code for the online configurator**

**i** Your web code: #0007



Fujitsu FCN connector on flat-ribbon cable, number of positions: 40 on 50



Fujitsu FCN connector on flat-ribbon cable, number of positions: 40 on 4 x 14

ERC

**Technical data**

Max. perm. operating voltage	< 50 V AC / 60 V DC
Max. perm. current carrying capacity per path	1 A
Max. conductor resistance	0.16 Ω/m
Ambient temperature (operation)	-20 °C ... 50 °C
Conductor cross section	AWG 26 / 0.14 mm <sup>2</sup>
Conductor structure: stranded wires / material	7 / Cu tin-plated

**Ordering data**

Description	No. of pos.	Cable length
-------------	-------------	--------------

<b>Round cable in variable lengths for Mitsubishi Melsec L</b>		
LX41C4, LX42C4 (common positive connection to B01, B02)		
LY41NT1P, LY42NT1P, LY41PT1P, LY42PT1P		
<b>Mitsubishi Melsec Q</b>		
QX41, QX41-S1, QX42, QX42-S1		
QX71 and QX72 (common positive connection to B01, B02)		
QY41P, QY42P, QY71, QH42P		
<b>Honeywell ML 200</b>		
2MLQ-TR4A, 2MLQ-TR8A, 2MLQ-TR4B, 2MLQ-TR8B		
	40	0.5 m
	40	1 m
	40	2 m
	40	3 m
	40	4 m
	40	6 m
	40	8 m
	40	10 m

<b>Round cable in variable lengths for Mitsubishi Melsec L</b>		
LX41C4 and LX42C4 (common negative connection to B01, B02)		
<b>Mitsubishi Melsec Q</b>		
QX71 and QX72 (common negative connection to B01, B02)		
QX82, QX82-S1		
<b>Honeywell ML 200</b>		
2MLI-D24A, 2MLI-D28B, 2MLF-SOEA (common negative connection to B01, B02)		
	40	0.5 m
	40	1 m
	40	2 m
	40	3 m
	40	4 m
	40	6 m
	40	8 m
	40	10 m

<b>Round cable in variable lengths for Mitsubishi Melsec L</b>		
LX41C4 and LX42C4 (common positive connection to B01, B02)		
LY41NT1P, LY42NT1P, LY41PT1P, LY42PT1P		
<b>Mitsubishi Melsec Q</b>		
QX41, QX41-S1, QX42, QX42-S1		
QY41P (24 V), QY42P (24 V), QH42P (24 V)		
<b>Honeywell ML 200</b>		
2MLQ-TR4A, 2MLQ-TR8A, 2MLQ-TR4B, 2MLQ-TR8B		
	40	0.5 m
	40	1 m
	40	2 m
	40	3 m
	40	4 m
	40	6 m
	40	8 m
	40	10 m

Type	Order No.	Pcs. / Pkt.
------	-----------	-------------

CABLE-FCN40/1X50/ 0,5M/IM/MEL	2903468	1
CABLE-FCN40/1X50/ 1,0M/IM/MEL	2903469	1
CABLE-FCN40/1X50/ 2,0M/IM/MEL	2903470	1
CABLE-FCN40/1X50/ 3,0M/IM/MEL	2903471	1
CABLE-FCN40/1X50/ 4,0M/IM/MEL	2903472	1
CABLE-FCN40/1X50/ 6,0M/IM/MEL	2903473	1
CABLE-FCN40/1X50/ 8,0M/IM/MEL	2903474	1
CABLE-FCN40/1X50/10,0M/IM/MEL	2903475	1
CABLE-FCN40/1X50/ 0,5M/IP/MEL	2903476	1
CABLE-FCN40/1X50/ 1,0M/IP/MEL	2903477	1
CABLE-FCN40/1X50/ 2,0M/IP/MEL	2903478	1
CABLE-FCN40/1X50/ 3,0M/IP/MEL	2903479	1
CABLE-FCN40/1X50/ 4,0M/IP/MEL	2903480	1
CABLE-FCN40/1X50/ 6,0M/IP/MEL	2903481	1
CABLE-FCN40/1X50/ 8,0M/IP/MEL	2903482	1
CABLE-FCN40/1X50/10,0M/IP/MEL	2903483	1

ERC

**Technical data**

Max. perm. operating voltage	< 50 V AC / 60 V DC
Max. perm. current carrying capacity per path	1 A
Max. conductor resistance	0.16 Ω/m
Ambient temperature (operation)	-20 °C ... 50 °C
Conductor cross section	AWG 26 / 0.14 mm <sup>2</sup>
Conductor structure: stranded wires / material	7 / Cu tin-plated

**Ordering data**

Type	Order No.	Pcs. / Pkt.
------	-----------	-------------

CABLE-FCN40/4X14/ 0,5M/IM/MEL	2903502	1
CABLE-FCN40/4X14/ 1,0M/IM/MEL	2903503	1
CABLE-FCN40/4X14/ 2,0M/IM/MEL	2903504	1
CABLE-FCN40/4X14/ 3,0M/IM/MEL	2903505	1
CABLE-FCN40/4X14/ 4,0M/IM/MEL	2903506	1
CABLE-FCN40/4X14/ 6,0M/IM/MEL	2903507	1
CABLE-FCN40/4X14/ 8,0M/IM/MEL	2903508	1
CABLE-FCN40/4X14/10,0M/IM/MEL	2903509	1

# System cabling for controllers

## Controller-specific system cabling

### OMRON CJ1, CS1, CQM1, and C200H System cable

These system cables are plugged onto the I/O cards that are connected using Fujitsu connectors.

#### FLK 50/EZ-DR/...

– Signal transmission of 32 channels

#### CABLE-FCN40...

– Splitting up 32 channels into 4 x 8 channels

#### CABLE-FCN24...

– Splitting up 16 channels into 2 x 8 channels



Fujitsu FCN connector on flat-ribbon cable, number of positions: 40 on 50



Fujitsu FCN connector on flat-ribbon cable, number of positions: 40 on 4 x 14 or 24 on 2 x 14



Max. perm. operating voltage  
Max. perm. current carrying capacity per path  
Max. conductor resistance  
Ambient temperature (operation)  
Conductor cross section  
Conductor structure: stranded wires / material

< 50 V AC / 60 V DC  
1 A  
0.16 Ω/m  
-20 °C ... 50 °C  
AWG 26 / 0.14 mm<sup>2</sup>  
7 / Cu tin-plated

< 50 V AC / 60 V DC  
1 A  
0.16 Ω/m  
-20 °C ... 50 °C  
AWG 26 / 0.14 mm<sup>2</sup>  
7 / Cu tin-plated

#### Technical data

#### Technical data

#### Ordering data

#### Ordering data

Description	No. of pos.	Cable length
<b>Round cable</b> in variable lengths for CJ1: OD231, OD261 CS1, C200H: OD218, OD219 CQM1: OD213	40 40	1 m 2 m
<b>Round cable</b> , as above, however in variable lengths	40	
<b>Round cable</b> in variable lengths for CJ1: ID231, ID261 CS1 and C200H: ID111, ID216, ID217, CQM1: ID213; ID214; ID112	40 40	1 m 2 m
<b>Round cable</b> , as above, however in variable lengths	40	
<b>Round cable</b> in variable lengths for CS1, C200H: OD215, MD115 (only output), MD215 (only output)	24 24	1 m 2 m
<b>Round cable</b> , as above, however in variable lengths	24	
<b>Round cable</b> in variable lengths for CS1, C200H: ID215, MD115 (only input), MD215 (only input)	24 24	1 m 2 m
<b>Round cable</b> , as above, however in variable lengths	24	

Type	Order No.	Pcs. / Pkt.
FLK 50/EZ-DR/FCN40/100/OMR-OUT	2304144	1
FLK 50/EZ-DR/FCN40/200/OMR-OUT	2304157	1
FLK 50-EZ-DR-FCN40-OMR-OUT/...	2302829	1
FLK 50/EZ-DR/FCN40/100/OMR-IN	2304160	1
FLK 50/EZ-DR/FCN40/200/OMR-IN	2304173	1
FLK 50-EZ-DR-FCN40-OMR-IN/...	2302803	1

Type	Order No.	Pcs. / Pkt.
CABLE-FCN40/4X14/100/OMR-OUT	2304186	1
CABLE-FCN40/4X14/200/OMR-OUT	2304199	1
CABLE-FCN40-4X14-OMR-OUT/...	2302832	1
CABLE-FCN40/4X14/100/OMR-IN	2304209	1
CABLE-FCN40/4X14/200/OMR-IN	2304212	1
CABLE-FCN40-4X14-OMR-IN/...	2302816	1
CABLE-FCN24/2X14/100/OMR-OUT	2304225	1
CABLE-FCN24/2X14/200/OMR-OUT	2304238	1
CABLE-FCN24-2X14-OMR-OUT/...	2302858	1
CABLE-FCN24/2X14/100/OMR-IN	2304241	1
CABLE-FCN24/2X14/200/OMR-IN	2304254	1
CABLE-FCN24-2X14-OMR-IN/...	2302845	1

#### Ordering example for system cable:

– Cable for OMRON CJ1, ID231, 12.75 m long

Quantity      Order No.      Length [m]<sup>1)</sup>

1	2302803	/	12.75
---	---------	---	-------

<sup>1)</sup> min. 0.20 m

### Phoenix Contact Axioline realtime I/O System cables

These cables have been specifically developed for connecting VARIOFACE termination boards to the Axioline realtime I/O system. The push-in technology on the I/O system ensures rapid connection.

The cables have the following features:

- 1:1 connection
- 14-pos. connector; molded
- 8 pre-assembled open ends, for connection to the Axioline realtime I/O system
- Transmission of groups of 8 channels
- Marking field on connector

Tailor-made VARIOFACE termination boards round off this system concept.

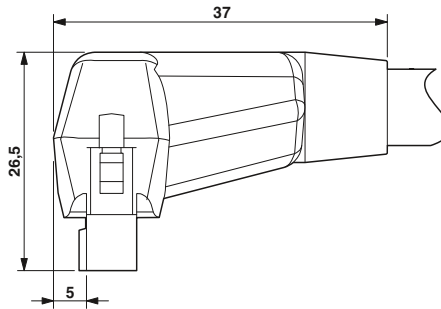

System cable for 8 channels

**Notes:**  
The following modules cannot be coupled due to the larger outer contour of the molded connectors:  
UM 45-FLK14/ 8IM/ZFKDS/PLC, 2965211  
UM 45- 8RM/MR-G24/1/PLC, 2962900

Max. perm. operating voltage  
Max. perm. current carrying capacity per path  
Max. conductor resistance  
Ambient temperature (operation)  
Assembly

Conductor cross section  
Conductor structure: stranded wires / material  
Outside diameter

14-position

ERIC

#### Technical data

< 50 V AC / 60 V DC  
1 A  
0.16 Ω/m  
-20 °C ... 50 °C  
Insulation displacement, IEC 60352-4/DIN EN 60352-4

AWG - / 0.14 mm<sup>2</sup>  
7 / Cu tin-plated

6.4 mm

#### Ordering data

Description	No. of pos.	Cable length	Type	Order No.	Pcs. / Pkt.
<b>Round cable with an open end (8 individual wires)</b>					
	14	0.5 m	VIP-CAB-FLK14/AXIO/0,14/0,5M	2901604	1
	14	1 m	VIP-CAB-FLK14/AXIO/0,14/1,0M	2901605	1
	14	1.5 m	VIP-CAB-FLK14/AXIO/0,14/1,5M	2901606	1
	14	2 m	VIP-CAB-FLK14/AXIO/0,14/2,0M	2901607	1
	14	2.5 m	VIP-CAB-FLK14/AXIO/0,14/2,5M	2901608	1
	14	3 m	VIP-CAB-FLK14/AXIO/0,14/3,0M	2901609	1
	14	4 m	VIP-CAB-FLK14/AXIO/0,14/4,0M	2901610	1
	14	6 m	VIP-CAB-FLK14/AXIO/0,14/6,0M	2901611	1



# System cabling for controllers

## Controller-specific system cabling

### Phoenix Contact Inline Front adapters

The front adapters are used to connect pre-assembled system cables directly to Inline. Front adapters are simply plugged into the relevant Inline modules. Three connection options are available:

- Transfer of 8 channels via a 14-pos. system cable
  - Transmission of 2 x 8 channels over two 14-position system cables
  - Transmission of 4 x 8 channels over four 14-position system cables
- Tailor-made VARIOFACE termination boards round off this system concept.

### Web code for the online configurator

**i** Your web code: #0007

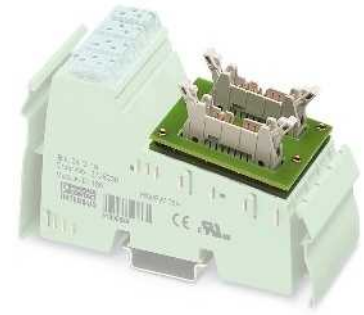

Front adapter for Inline



Max. perm. operating voltage  
Max. permissible current  
Ambient temperature (operation)  
Ambient temperature (storage/transport)  
Mounting position  
Standards/regulations

60 V DC  
1 A (per path)  
-20 °C ... 50 °C  
-20 °C ... 70 °C  
any  
IEC 60664 / DIN EN 50178 / IEC 62103

### Ordering data

Description	No. of pos.
<b>VARIOFACE front adapter, for 8-channel Inline modules</b>	
Input: IB IL 24 D I8/HD-PAC Output: IB IL 24 DO 8/HD-PAC	
<b>VARIOFACE front adapter, for 16-channel Inline modules</b>	
Input: IB IL 24 DI 16-PAC Output: IB IL 24 DO 16-PAC	
<b>VARIOFACE front adapter, for 32-channel Inline modules</b>	
Input: IB IL 24 DI 32/HD-PAC and IB IL 24 DI 32/HD-NPN-PAC Output: IB IL 24 DO 32/HD-PAC	

Type	Order No.	Pcs. / Pkt.
<b>FLKM 14-PA-INLINE/DIO8</b>	2900889	1
<b>FLKM 14-PA-INLINE/IN16</b>	2302751	1
<b>FLKM 14-PA-INLINE/OUT16</b>	2302764	1
<b>FLKM 14-PA-INLINE/32</b>	2302777	1

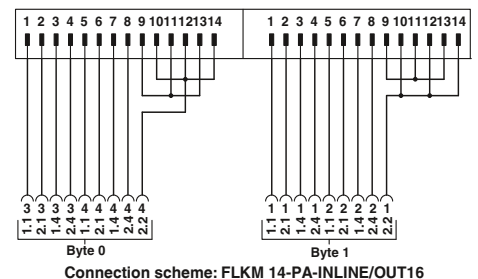
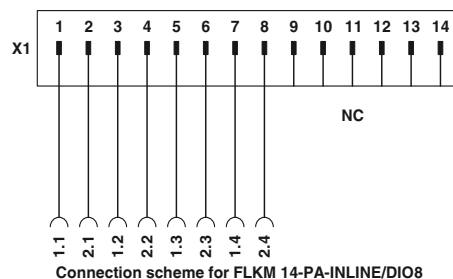
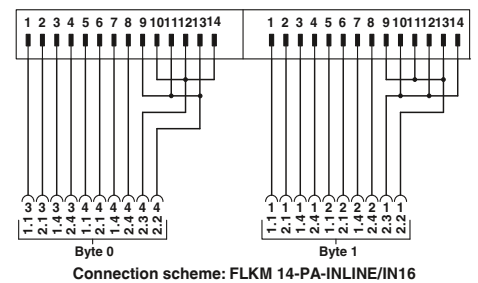
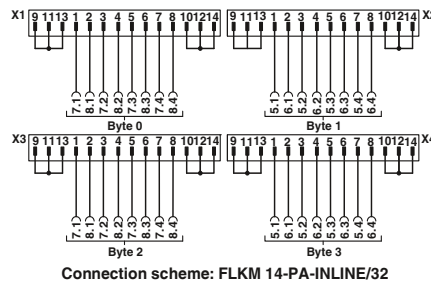

**Explanation:**  

- Flat-ribbon cable strip
- Connection to I/O card
- Screw terminal blocks for separate supply

**Schneider Electric**  
**MODICON® TSX Quantum**  
**Front adapters**

The front adapters mean that pre-assembled system cables can be directly connected to I/O modules. There are two connection options available:

- Transfer of max. 32 channels over one 50-position system cable
- Transmission of 4 x 8 channels over four 14-position system cables

Tailor-made VARIOFACE termination boards with a variety of functions and connection options round off this system concept.

**Web code for the online configurator**

**i** Your web code: #0007



Front adapter for MODICON TSX Quantum



**Technical data**

Max. perm. operating voltage  
Max. permissible current

< 50 V AC / 60 V DC  
1 A (per path)  
4 A (per connection, supply via separate power supply)

Ambient temperature (operation)  
Ambient temperature (storage/transport)  
Mounting position  
Standards/regulations

-20 °C ... 50 °C  
-20 °C ... 70 °C  
any  
IEC 60664 / DIN EN 50178 / IEC 62103

**Ordering data**

Description	No. of pos.
<b>VARIOFACE front adapter</b> , for MODICON® TSX Quantum, 1 x 32 channels can be connected	50
<b>VARIOFACE front adapter</b> , for MODICON® TSX Quantum, 4 x 8 channels can be connected	14

Type	Order No.	Pcs. / Pkt.
FLKM 50-PA-MODI-TSX/Q	2294306	1
FLKM 50/ 4-FLK14/PA-MODI-TSX/Q	2294416	1

Front adapter for I/O modules of MODICON® TSX Quantum automation devices

Card type	FLKM 50-PA-MODI-TSX/Q
<b>Digital input</b>	DDI 353 DDI 841* DDI 853 DAI 340* DAI 353** DAI 440* DAI 453**
<b>Digital output</b>	DDO 353
<b>Digital input/output</b>	DDM 390*
<b>Analog input</b>	ACI 030* ACI 040* ATI 030* ARI 030* AVI 030*
<b>Analog output</b>	ACO 020* ACO 130* AVO 020*
<b>Analog input/output</b>	AMM 090*
<b>Counter</b>	ECH 105* EHC 202*

\* Only in conjunction with VIP-2/SC/FLK50/MODI-TSX/Q, Order No. 2322304.  
\*\* Only in conjunction with Passive interface modules without LED.

Card type	FLKM 50/4-FLK14/PA-MODI-
<b>Digital input</b>	DDI 353 DDI 853 DAI 353** DAI 453**
<b>Digital output</b>	DDO 353

\*\* Only in conjunction with Passive interface modules without LED.

**Explanation:**  
 Flat-ribbon cable strip  
 Connection to I/O card  
 Screw terminal blocks for separate supply

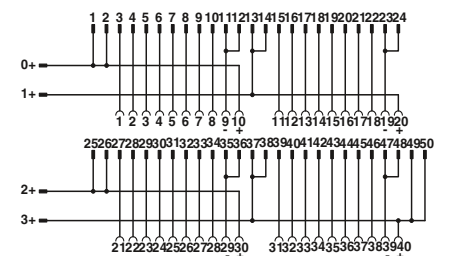

Connection scheme FLKM 50-PA-MODI-TSX/Q

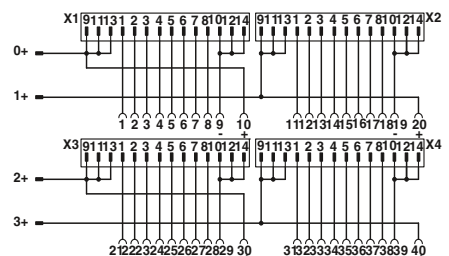

Connection scheme FLKM 50/ 4-FLK14/PA-MODI-TSX/Q

# System cabling for controllers

## Controller-specific system cabling

### Schneider Electric MODICON® M340 Front adapter

Pre-assembled system cables are connected directly to the 16-channel I/O modules using the front adapter. The adapters connect 2 x 8 channels of the controller via two 14-pos. system cables. Tailor-made VARIOFACE termination boards with a variety of functions and connection options are available for connection to field level and round off this system concept.

#### Web code for the online configurator

**i** Your web code: #0007



#### Technical data

Max. perm. operating voltage	< 50 V AC / 60 V DC
Max. permissible current	1 A (per path)
Max. perm. total current	3 A (per system cable when supplying from the module side) 10 A (when supplying via the front adapter)
Ambient temperature (operation)	-20 °C ... 60 °C
Ambient temperature (storage/transport)	-20 °C ... 60 °C
Mounting position	any
Standards/regulations	IEC 60664 / DIN EN 50178 / IEC 62103

#### Ordering data

Description	No. of pos.	Type	Order No.	Pcs. / Pkt.
VARIOFACE front adapter, for MODICON® M340 with two FLK pin strips	14	FLKM 14-PA-MODI/M340	2903208	1

#### Front adapter for MODICON C340 series I/O modules

Card type	FLKM 14-PA-MODI/M340
Digital input	BMX DDI1602 BMX DDI1603 BMX DAI1602 BMX DAI1603
Digital output	BMX DDO1602 BMX DDO1612

#### Assignment table

Contacts of front adapter/ controller	Connector (Byte 0)	Connector (Byte 1)
1	1	
2	2	
3	3	
4	4	
5	5	
6	6	
7	7	
8	8	
9		1
10		2
11		3
12		4
13		5
14		6
15		7
16		8
17	10, 12, 14 (-)	10, 12, 14 (-)
18	9, 11, 13 (+)	9, 11, 13 (+)
19	10, 12, 14 (-)	10, 12, 14 (-)
20	9, 11, 13 (+)	9, 11, 13 (+)

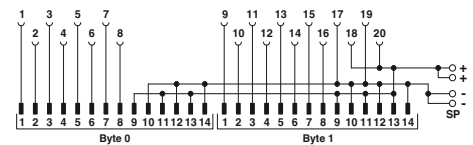

Connection scheme FLKM 14-PA-MODI/M340



**Schneider Electric MODICON® M340 System cable**

These system cables are plugged onto the I/O cards that are connected using Fujitsu connectors.

**CABLE-FCN40/1X50/...**

– Signal transmission of 32 channels

**CABLE-FCN40/4X14/...**

– Splitting up 32 channels into 4 x 8 channels

**Web code for the online configurator**

**i** Your web code: #0007



Fujitsu FCN connector on flat-ribbon cable, number of positions: 40 on 50



Fujitsu FCN connector on flat-ribbon cable, number of positions: 40 on 4 x 14

ERC

**Technical data**

Max. perm. operating voltage	< 50 V AC / 60 V DC
Max. perm. current carrying capacity per path	1 A
Max. conductor resistance	0.16 Ω/m
Ambient temperature (operation)	-20 °C ... 50 °C
Conductor cross section	AWG 26 / 0.14 mm <sup>2</sup>
Conductor structure: stranded wires / material	7 / Cu tin-plated

**Ordering data**

Description	No. of pos.	Cable length
<b>Round cable</b> in variable lengths for BMX DDI 3202K, BMX DDI 6402K, BMX DD0 3202K, BMX DD0 6402K, BMX DDM 3202K		
	40	0.5 m
	40	1 m
	40	2 m
	40	3 m
	40	4 m
	40	6 m
	40	8 m
	40	10 m
	40	15 m

ERC

**Technical data**

Max. perm. operating voltage	< 50 V AC / 60 V DC
Max. perm. current carrying capacity per path	1 A
Max. conductor resistance	0.16 Ω/m
Ambient temperature (operation)	-20 °C ... 50 °C
Conductor cross section	AWG 26 / 0.14 mm <sup>2</sup>
Conductor structure: stranded wires / material	7 / Cu tin-plated

**Ordering data**

Type	Order No.	Pcs. / Pkt.
CABLE-FCN40/1X50/ 0,5M/M340	2321635	1
CABLE-FCN40/1X50/ 1,0M/M340	2321648	1
CABLE-FCN40/1X50/ 2,0M/M340	2321651	1
CABLE-FCN40/1X50/ 3,0M/M340	2321664	1
CABLE-FCN40/1X50/ 4,0M/M340	2321677	1
CABLE-FCN40/1X50/ 6,0M/M340	2321680	1
CABLE-FCN40/1X50/ 8,0M/M340	2321693	1
CABLE-FCN40/1X50/10,0M/M340	2321703	1
CABLE-FCN40/1X50/15,0M/M340	2903748	1

# System cabling for controllers

## Controller-specific system cabling

### VIP - power cabling

#### Universal front adapters for SIMATIC® S7-300

##### Four connection options are available:

- Connection of 40-pos. modules via four cables, each with a 10-pos. COMBI connector
- Connection of 20-pos. modules via two cables, each with a 10-pos. COMBI connector
- Connection of 40-pos. modules via 40 individual wires in rope structure (not assembled)
- Connection of 20-pos. modules via 20 individual wires in rope structure (not assembled)

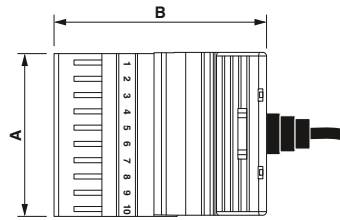

	A	B
...4X10COMBI...	52	70
...2X10COMBI...		
...4X10 PT...	35	62
...2X10 PT...		

##### The front adapters have the following features:

- Can be screwed on/snapped in with the I/O module
- Suitable for all common S7-300 modules, up to max. 250 V AC/DC, 6 A
- Universal 1:1 connection
- Numerically marked wires/connectors

##### Combination example:

A front adapter with punched-on 10-pos. COMBI connectors can be combined with the following modular terminal blocks for field connection:

- Overall width of 52 mm per connector:
- 3045017 UT 2,5/1P
- 3210033 PT 2,5/1P
- 3040012 ST 2,5/1P
- 3040766 ST 2,5-TWIN-MT/1P

Reduced overall width of 35 mm per connector:

- 3208582 PT 1,5/S/1P
- 3212439 PTTB 1,5/S/2P

You can find further versions, accessories, and combination options in Catalog 3 “Terminal blocks” in the “Plug-in COMBI connection solutions” section or online at [phoenixcontact.net/products](http://phoenixcontact.net/products).



Front adapter with punched-on connectors for 40 plug-in modular terminal blocks

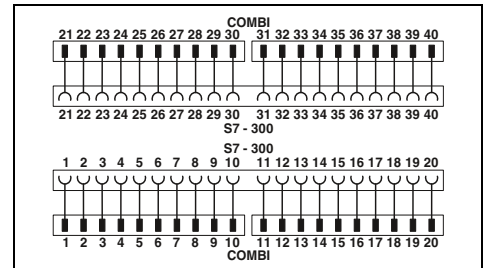

##### Technical data

Max. perm. operating voltage	≤ 250 V AC/DC
Max. perm. current carrying capacity per path	6 A (per single wire at 40°C) 4 A (per single wire at 60°C)
Max. perm. total current	20 A (per cable at 40°C) 16 A (per cable at 60°C)
Max. conductor resistance	39 Ω/km
Conductor cross section	AWG 21 / 0.5 mm <sup>2</sup>
Conductor structure: stranded wires / material	16 / Cu uninsulated
Outside diameter	9 mm
Ambient temperature range	-20 °C ... 60 °C
Standards/regulations	DIN EN 50178, IEC 60664, IEC 62103
Connection method	Can be plugged onto 40-pos. I/O modules COMBICON connectors

Max. perm. operating voltage	≤ 250 V AC/DC
Max. perm. current carrying capacity per path	6 A (per single wire at 40°C) 4 A (per single wire at 60°C)
Max. perm. total current	20 A (per cable at 40°C) 16 A (per cable at 60°C)
Max. conductor resistance	39 Ω/km
Conductor cross section	AWG 21 / 0.5 mm <sup>2</sup>
Conductor structure: stranded wires / material	16 / Cu uninsulated
Outside diameter	9 mm
Ambient temperature range	-20 °C ... 60 °C
Standards/regulations	DIN EN 50178, IEC 60664, IEC 62103
Connection method	Can be plugged onto 40-pos. I/O modules COMBICON connectors

##### Ordering data

Description	Cable length
<b>VIP - power adapter</b> , for universal connection of the SIMATIC S7-300, with an overall width of 52 mm per connector	0.5 m
	1 m
	1.5 m
	2 m
	2.5 m
	3 m
	4 m
	5 m
	6 m
	8 m
10 m	
<b>VIP - power adapter</b> , for universal connection of the SIMATIC S7-300, with reduced overall width of 35 mm per connector	0.5 m
	1 m
	1.5 m
	2 m
	2.5 m
	3 m
	4 m
	5 m
	6 m
	8 m
10 m	

Type	Order No.	Pcs. / Pkt.
VIP-PA-PWR/4X10COMBI/ 0,5M/S7	2904702	1
VIP-PA-PWR/4X10COMBI/ 1,0M/S7	2904703	1
VIP-PA-PWR/4X10COMBI/ 1,5M/S7	2904704	1
VIP-PA-PWR/4X10COMBI/ 2,0M/S7	2904705	1
VIP-PA-PWR/4X10COMBI/ 2,5M/S7	2904706	1
VIP-PA-PWR/4X10COMBI/ 3,0M/S7	2904707	1
VIP-PA-PWR/4X10COMBI/ 4,0M/S7	2904708	1
VIP-PA-PWR/4X10COMBI/ 5,0M/S7	2904709	1
VIP-PA-PWR/4X10COMBI/ 6,0M/S7	2904710	1
VIP-PA-PWR/4X10COMBI/ 8,0M/S7	2904711	1
VIP-PA-PWR/4X10COMBI/10,0M/S7	2904712	1
VIP-PA-PWR/4X10 PT/ 0,5M/S7	2905516	1
VIP-PA-PWR/4X10 PT/ 1,0M/S7	2905517	1
VIP-PA-PWR/4X10 PT/ 1,5M/S7	2905518	1
VIP-PA-PWR/4X10 PT/ 2,0M/S7	2905519	1
VIP-PA-PWR/4X10 PT/ 2,5M/S7	2905520	1
VIP-PA-PWR/4X10 PT/ 3,0M/S7	2905521	1
VIP-PA-PWR/4X10 PT/ 4,0M/S7	2905522	1
VIP-PA-PWR/4X10 PT/ 5,0M/S7	2905523	1
VIP-PA-PWR/4X10 PT/ 6,0M/S7	2905524	1
VIP-PA-PWR/4X10 PT/ 8,0M/S7	2905525	1
VIP-PA-PWR/4X10 PT/10,0M/S7	2905526	1



Front adapter with punched-on connectors for 20 plug-in modular terminal blocks



Front adapter with 40 open cable ends



Front adapter with 20 open cable ends

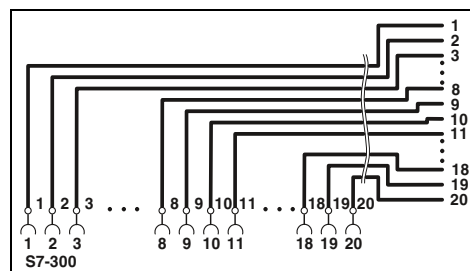
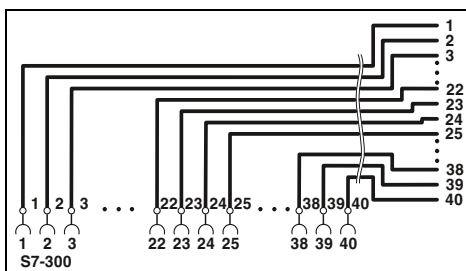
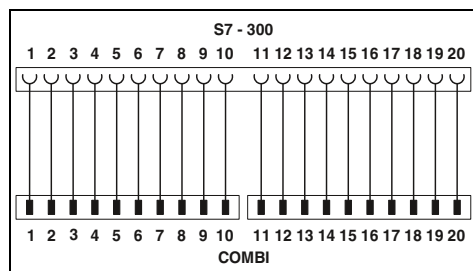

### Technical data

≤ 250 V AC/DC  
 6 A (per single wire at 40°C)  
 4 A (per single wire at 60°C)  
 20 A (per cable at 40 °C)  
 16 A (per cable at 60°C)  
 39 Ω/km  
 AWG 21 / 0.5 mm<sup>2</sup>  
 16 / Cu uninsulated  
 9 mm  
 -20 °C ... 60 °C  
 DIN EN 50178, IEC 60664, IEC 62103  
 Can be plugged onto 20-pos. I/O modules  
 COMBICON connectors

### Technical data

≤ 250 V AC/DC  
 6 A (per single wire at 40°C)  
 4 A (per single wire at 60°C)  
 20 A (per cable at 40 °C)  
 16 A (per cable at 60°C)  
 39 Ω/km  
 AWG 21 / 0.5 mm<sup>2</sup>  
 16 / Cu uninsulated  
 13 mm  
 -20 °C ... 60 °C  
 DIN EN 50178, IEC 60664, IEC 62103  
 Can be plugged onto 40-pos. I/O modules  
 Open cable end

### Technical data

≤ 250 V AC/DC  
 6 A (per single wire at 40°C)  
 4 A (per single wire at 60°C)  
 20 A (per cable at 40 °C)  
 16 A (per cable at 60°C)  
 39 Ω/km  
 AWG 21 / 0.5 mm<sup>2</sup>  
 16 / Cu uninsulated  
 9 mm  
 -20 °C ... 60 °C  
 DIN EN 50178, IEC 60664, IEC 62103  
 Can be plugged onto 20-pos. I/O modules  
 Open cable end

### Ordering data

Type	Order No.	Pcs. / Pkt.
VIP-PA-PWR/2X10COMBI/ 0,5M/S7	2904713	1
VIP-PA-PWR/2X10COMBI/ 1,0M/S7	2904714	1
VIP-PA-PWR/2X10COMBI/ 1,5M/S7	2904715	1
VIP-PA-PWR/2X10COMBI/ 2,0M/S7	2904716	1
VIP-PA-PWR/2X10COMBI/ 2,5M/S7	2904717	1
VIP-PA-PWR/2X10COMBI/ 3,0M/S7	2904718	1
VIP-PA-PWR/2X10COMBI/ 4,0M/S7	2904719	1
VIP-PA-PWR/2X10COMBI/ 5,0M/S7	2904720	1
VIP-PA-PWR/2X10COMBI/ 6,0M/S7	2904721	1
VIP-PA-PWR/2X10COMBI/ 8,0M/S7	2904722	1
VIP-PA-PWR/2X10COMBI/10,0M/S7	2904723	1
VIP-PA-PWR/2X10 PT/ 0,5M/S7	2905528	1
VIP-PA-PWR/2X10 PT/ 1,0M/S7	2905529	1
VIP-PA-PWR/2X10 PT/ 1,5M/S7	2905531	1
VIP-PA-PWR/2X10 PT/ 2,0M/S7	2905532	1
VIP-PA-PWR/2X10 PT/ 2,5M/S7	2905533	1
VIP-PA-PWR/2X10 PT/ 3,0M/S7	2905534	1
VIP-PA-PWR/2X10 PT/ 4,0M/S7	2905535	1
VIP-PA-PWR/2X10 PT/ 5,0M/S7	2905536	1
VIP-PA-PWR/2X10 PT/ 6,0M/S7	2905537	1
VIP-PA-PWR/2X10 PT/ 8,0M/S7	2905538	1
VIP-PA-PWR/2X10 PT/10,0M/S7	2905539	1

### Ordering data

Type	Order No.	Pcs. / Pkt.
VIP-PA-PWR/40XOE/ 1,0M/S7	2904731	1
VIP-PA-PWR/40XOE/ 2,0M/S7	2904732	1
VIP-PA-PWR/40XOE/ 3,0M/S7	2904733	1
VIP-PA-PWR/40XOE/ 4,0M/S7	2904734	1
VIP-PA-PWR/40XOE/ 6,0M/S7	2904735	1
VIP-PA-PWR/40XOE/ 8,0M/S7	2904736	1
VIP-PA-PWR/40XOE/10,0M/S7	2904737	1

### Ordering data

Type	Order No.	Pcs. / Pkt.
VIP-PA-PWR/20XOE/ 1,0M/S7	2904724	1
VIP-PA-PWR/20XOE/ 2,0M/S7	2904725	1
VIP-PA-PWR/20XOE/ 3,0M/S7	2904726	1
VIP-PA-PWR/20XOE/ 4,0M/S7	2904727	1
VIP-PA-PWR/20XOE/ 6,0M/S7	2904728	1
VIP-PA-PWR/20XOE/ 8,0M/S7	2904729	1
VIP-PA-PWR/20XOE/10,0M/S7	2904730	1

# System cabling for controllers

## Controller-specific system cabling

### VIP – VARIOFACE Professional front adapters for SIMATIC S7-300

#### Three connection options are available:

- Transfer of max. 32 channels via two 50-pos. system cables (32-channel cards or this type)
- Transfer of 4 x 8 channels via two 14-pos. system cables (32-channel cards or this type)
- Transfer of 2 x 8 channels via two 14-pos. system cables (16-channel cards or this type)

#### The front adapters have the following features:

- Can be screwed with I/O module
- Voltage supply via terminal blocks with spring-cage double connection
- Encapsulated socket strips for module side  
Special lengths can be configured using separate order numbers.

#### Ordering example:

A front adapter with a connected 50-pos. system cable (32-channel cards), 12.75 m in length:

**1 pcs. 2900885/12,75**

#### Web code for the online configurator

**i Your web code: #0007**

#### Notes:

The following modules cannot be coupled due to the larger outer contour of the molded connectors:  
 UM 45-FLK14/ 8IM/ZFKDS/PLC, 2965211  
 UM 45-FLK50/32IM/ZFKDS/PLC, 2965224  
 UM 45- 8RM/MR-G24/1/PLC, 2962900  
 UM 45-16RM/MR-G24/1/PLC, 2962913

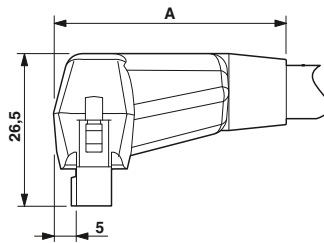

	A
...FLK14...	37
...FLK50...	42



Front adapter with system cable  
1 x 32 channels can be connected

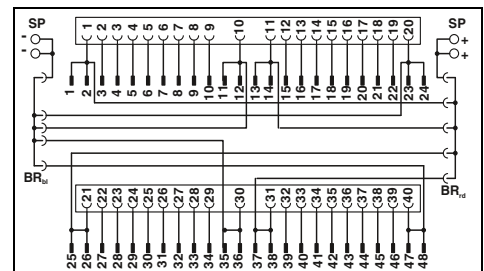

#### Technical data

Max. perm. operating voltage  
 Max. perm. current carrying capacity per path  
 Max. perm. current (separate power supply)

< 50 V AC / 60 V DC  
 1 A (per path)  
 8 A

Max. conductor resistance  
 Conductor cross section  
 Conductor structure: stranded wires / material  
 Outside diameter  
 Ambient temperature range  
 Standards/regulations  
 Connection method

0.16 Ω/m  
 AWG 26 / 0.14 mm<sup>2</sup>  
 7 / Cu tin-plated  
 10.3 mm  
 -20 °C ... 50 °C

Front adapter

Can be plugged onto 40-pos. I/O modules / separate power supply through terminal blocks with spring-cage double connection

System cable

Flat-ribbon cable connector in acc. with IEC 60603-13

Connection data solid / stranded / AWG

0.2 ... 2.5 mm<sup>2</sup> / 0.2 ... 2.5 mm<sup>2</sup> / 24 - 14

#### Ordering data

Description	Cable length
VIP VARIOFACE front adapter, with connected system cables for SIMATIC S7 300	
	0.5 m
	1 m
	1.5 m
	2 m
	2.5 m
	3 m
	4 m
	5 m
	6 m
	7 m
	8 m
	10 m
VIP VARIOFACE front adapter, as above, in variable lengths	

Type	Order No.	Pcs. / Pkt.
VIP-PA-FLK50/ 0,5M/S7	2322443	1
VIP-PA-FLK50/ 1,0M/S7	2322456	1
VIP-PA-FLK50/ 1,5M/S7	2322469	1
VIP-PA-FLK50/ 2,0M/S7	2321800	1
VIP-PA-FLK50/ 2,5M/S7	2322472	1
VIP-PA-FLK50/ 3,0M/S7	2322485	1
VIP-PA-FLK50/ 4,0M/S7	2322498	1
VIP-PA-FLK50/ 5,0M/S7	2322508	1
VIP-PA-FLK50/ 6,0M/S7	2322511	1
VIP-PA-FLK50/ 7,0M/S7	2322524	1
VIP-PA-FLK50/ 8,0M/S7	2322537	1
VIP-PA-FLK50/10,0M/S7	2322540	1
VIP-PA-FLK50-S7/...	2900885	1



Front adapter with system cable  
4 x 8 channels can be connected



Front adapter with system cable  
2 x 8 channels can be connected

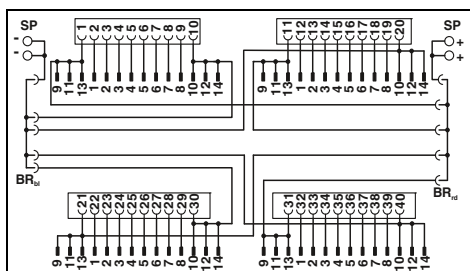

### Technical data

< 50 V AC / 60 V DC  
1 A (per path)  
8 A

0.16 Ω/m  
AWG 26 / 0.14 mm<sup>2</sup>  
7 / Cu tin-plated  
6.4 mm  
-20 °C ... 50 °C  
IEC 60664, IEC 62103, DIN EN 50178

Can be plugged onto 40-pos. I/O modules / separate power supply through terminal blocks with spring-cage double connection

Flat-ribbon cable connector in acc. with IEC 60603-13

0.2 ... 2.5 mm<sup>2</sup> / 0.2 ... 2.5 mm<sup>2</sup> / 24 - 14

### Ordering data

Type	Order No.	Pcs. / Pkt.
VIP-PA-FLK50/4X14/ 0,5M/S7	2322553	1
VIP-PA-FLK50/4X14/ 1,0M/S7	2322566	1
VIP-PA-FLK50/4X14/ 1,5M/S7	2322579	1
VIP-PA-FLK50/4X14/ 2,0M/S7	2321910	1
VIP-PA-FLK50/4X14/ 2,5M/S7	2322582	1
VIP-PA-FLK50/4X14/ 3,0M/S7	2322595	1
VIP-PA-FLK50/4X14/ 4,0M/S7	2322605	1
VIP-PA-FLK50/4X14/ 5,0M/S7	2322618	1
VIP-PA-FLK50/4X14/ 6,0M/S7	2322621	1
VIP-PA-FLK50/4X14/ 7,0M/S7	2322634	1
VIP-PA-FLK50/4X14/ 8,0M/S7	2322647	1
VIP-PA-FLK50/4X14/10,0M/S7	2322650	1
VIP-PA-FLK50-4X14-S7/...	2900886	1

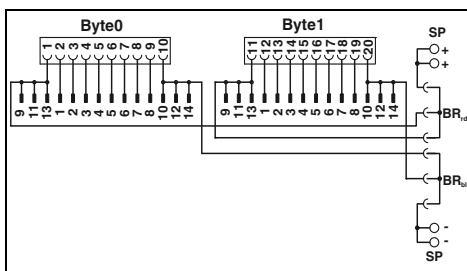

### Technical data

< 50 V AC / 60 V DC  
1 A (per path)  
8 A

0.16 Ω/m  
AWG 26 / 0.14 mm<sup>2</sup>  
7 / Cu tin-plated  
6.4 mm  
-20 °C ... 50 °C  
IEC 60664, IEC 62103, DIN EN 50178

Can be plugged onto 20-pos. I/O modules / separate power supply through terminal blocks with spring-cage double connection

Flat-ribbon cable connector in acc. with IEC 60603-13

0.2 ... 2.5 mm<sup>2</sup> / 0.2 ... 2.5 mm<sup>2</sup> / 24 - 14

### Ordering data

Type	Order No.	Pcs. / Pkt.
VIP-PA-FLK14/ 0,5M/S7	2322663	1
VIP-PA-FLK14/ 1,0M/S7	2322676	1
VIP-PA-FLK14/ 1,5M/S7	2322689	1
VIP-PA-FLK14/ 2,0M/S7	2321790	1
VIP-PA-FLK14/ 2,5M/S7	2322692	1
VIP-PA-FLK14/ 3,0M/S7	2322702	1
VIP-PA-FLK14/ 4,0M/S7	2322715	1
VIP-PA-FLK14/ 5,0M/S7	2322728	1
VIP-PA-FLK14/ 6,0M/S7	2322731	1
VIP-PA-FLK14/ 7,0M/S7	2322744	1
VIP-PA-FLK14/ 8,0M/S7	2322757	1
VIP-PA-FLK14/10,0M/S7	2322760	1
VIP-PA-FLK14-S7/...	2900887	1

### Front adapters for 32-channel cards of SIMATIC® S7-300

Card type	VIP-PA-FLK50/...M/S7
Digital input	6ES7 321-1BL00-0AA0
Digital output	6ES7 322-1BL00-0AA0
Digital input/output	6ES7 323-1BL00-0AA0
Analog input	6ES7 331-7PF01-0AB0* 6ES7 331-7PF11-0AB0* 6ES7 331-7NF00-0AB0* 6ES7 331-7NF10-0AB0* 6ES7 331-1KF01-0AB0*
Analog output	6ES7 332-5HF00-0AB0*
CPU	312C, 313C, 314C, 313C-2PIP 313C-2DP, 314C-2DP
Other modules	6ES7 350-2AH01-0AE0* 6ES7 357-4AH01-0AE0*

Card type	VIP-PA-FLK50/4X14/...M/S7
Digital input	6ES7 321-1BL00-0AA0
Digital output	6ES7 322-1BL00-0AA0
Digital input/output	6ES7 323-1BL00-0AA0
CPU	313C, 314C, 313C-2PIP 313C-2DP, 314C-2DP

\* Only in conjunction with  
VIP-2/SC/FLK50 (1-40)/S7, Order No.: 2315243,  
VIP-2/PT/FLK50 (1-40)/S7, Order No.: 2903804,  
FLKM 50/KDS3-MT/PPA/S7-300, Order No.: 2304490.  
All bridges (BR) at the adapter must be removed!

### Front adapters for 16-channel cards of SIMATIC® S7-300

Card type	VIP-PA-FLK14/...M/S7
Digital input	6ES7 321-1BH02-0AA0 6ES7 321-1BH10-0AA0 6ES7 321-1BH50-0AA0* 6ES7 321-7BH01-0AB0*
Digital output	6ES7 322-1BH01-0AA0 6ES7 322-1BH10-0AA0 6ES7 322-8BF00-0AB0*
Digital input/output	6ES7 323-1BH01-0AA0
Analog input	6ES7 331-7KF02-0AB0* 6ES7 331-7HF01-0AB0* 6ES7 331-7KB02-0AB0* 6ES7 331-7TF01-0AB0*
Analog output	6ES7 332-5HD01-0AB0* 6ES7 332-5HB01-0AB0* 6ES7 332-7ND02-0AB0*
Analog input/output	6ES7 334-0CE01-0AA0* 6ES7 334-0KE00-0AB0* 6ES7 335-7HG01-0AB0*
Other modules	6ES7 338-4BC01-0AB0* 6ES7 350-1AH03-0AE0* 6ES7 351-1AH01-0AE0* 6ES7 352-1AH02-0AE0* 6ES7 353-1AH01-0AE0* 6ES7 354-1AH01-0AE0* 6ES7 355-0VH10-0AE0* 6ES7 355-1VH10-0AE0*

\* Only in conjunction with  
VIP-2/SC/2FLK14 (1-20)/S7, Order No.: 2315230  
VIP-2/PT/2FLK14 (1-20)/S7, Order No.: 2903802  
FLKM-2FLK14/KDS 3-MT/PPA/S7, Order No.: 2295062  
All bridges (BR) on the adapter must be disconnected.

**Note:**  
The front adapters are non-isolated on delivery.  
Removal of the bridges can achieve electrical isolation (in groups of 8).

**Explanation:**  
 Flat-ribbon cable strip  
 Connection to I/O card

SP: Separate power terminals  
BR<sub>+</sub>: blue jumper  
BR<sub>0</sub>: red jumper

# System cabling for controllers

## Controller-specific system cabling

### Siemens SIMATIC® S7-300 Front adapter

#### I/O modules with 32 channels or with this design

There are two connection options available:

- Transfer of max. 32 channels over one 50-position system cable
- Transmission of 4 x 8 channels over four 14-position system cables

Tailor-made VARIOFACE termination boards with a variety of functions and connection options round off this system concept.

#### Web code for the online configurator

**i** Your web code: #0007



Front adapter for SIMATIC® S7-300, I/O cards with max. 32 channels



#### Technical data

Max. perm. operating voltage	< 50 V AC / 60 V DC
Max. permissible current	1 A (per path) 8 A (per connection, supply via separate power supply (2.8 x 0.8 mm))
Max. perm. total current	2 A (per byte, for supply via connector) 8 A (during supply via a separate bridged power supply)
Ambient temperature (operation)	-20 °C ... 50 °C
Ambient temperature (storage/transport)	-20 °C ... 70 °C
Standards/regulations	IEC 60664 / DIN EN 50178 / IEC 62103
Connection method	IDC/FLK pin strip (2.54 mm)

#### Ordering data

Description	No. of pos.	Type	Order No.	Pcs. / Pkt.
<b>VARIOFACE front adapter, for SIMATIC® S7-300</b>				
- 1 x 32 channels can be connected	50	<b>FLKM 50-PA-S300</b>	<b>2294445</b>	1
- 4 x 8 channels can be connected	14	<b>FLKM 50/4-FLK14/PA-S300</b>	<b>2296281</b>	1

#### Front adapters for 32-channel cards of SIMATIC® S7-300

Card type	FLKM 50-PA-S300
Digital input	6ES7 321-1BL00-0AA0
Digital output	6ES7 322-1BL00-0AA0
Digital input/output	6ES7 323-1BL00-0AA0
Analog input	6ES7 331-7PF01-0AB0* 6ES7 331-7PF11-0AB0* 6ES7 331-7NF00-0AB0* 6ES7 331-7NF10-0AB0* 6ES7 331-1KF01-0AB0*
Analog output	6ES7 332-5HF00-0AB0*
CPU	312C, 313C, 314C, 313C-2PiP 313C-2DP, 314C-2DP
Other modules	6ES7 350-2AH01-0AE0* 6ES7 357-4AH01-0AE0*

Card type	FLKM 50/4-FLK14/PA-S300
Digital input	6ES7 321-1BL00-0AA0
Digital output	6ES7 322-1BL00-0AA0
Digital input/output	6ES7 323-1BL00-0AA0
CPU	313C, 314C, 313C-2PiP 313C-2DP, 314C-2DP

\* Only in conjunction with  
VIP-2/SC/FLK50(1-40)/S7, Order No.: 2315243,  
VIP-2/PT/FLK50(1-40)/S7, Order No.: 2903804,  
FLKM 50/KDS3-MT/PPA/S7-300, Order No.: 2304490.  
All wire jumpers (DR) on the adapter must be disconnected!  
There must be no voltage supply at the front adapter (flowing via the slip-on connections)!

**Note:**  
The front adapters are non-isolated on delivery.  
Removal of the wire jumpers can achieve electrical isolation (in groups of 8).

**Explanation:**

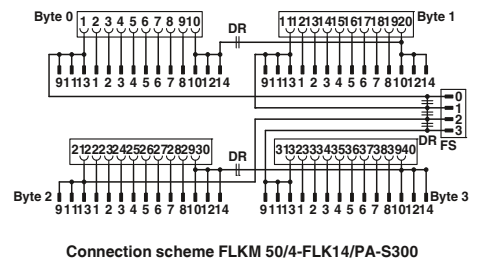
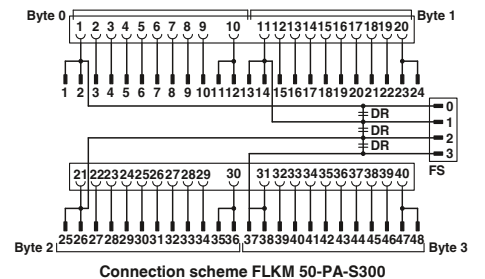

### Siemens SIMATIC® S7-300 Front adapter

#### I/O modules with 16 channels or with this design

– Up to 2 x 8 channels are connected via two 14-position system cables.

Tailor-made VARIOFACE termination boards with a variety of functions and connection options round off this system concept.

#### Web code for the online configurator

 Your web code: #0007



Front adapter for SIMATIC® S7-300,  
I/O cards with max. 16 channels



#### Technical data

Max. perm. operating voltage  
Max. permissible current

< 50 V AC / 60 V DC  
1 A (per path)  
8 A (per connection, supply via separate power supply (2.8 x 0.8 mm))

Max. perm. total current

2 A (per byte, for supply via connector)  
8 A (during supply via a separate bridged power supply)

Ambient temperature (operation)  
Ambient temperature (storage/transport)  
Standards/regulations  
Connection method

-20 °C ... 50 °C  
-20 °C ... 70 °C  
IEC 60664 / DIN EN 50178 / IEC 62103  
IDC/FLK pin strip (2.54 mm)

#### Ordering data

Description	No. of pos.
<b>VARIOFACE front adapter, for SIMATIC® S7-300</b>	
- 2 x 8 channels can be connected	14

Type	Order No.	Pcs. / Pkt.
<b>FLKM 14-PA-S300</b>	<b>2299770</b>	1

#### Front adapters for 16-channel cards of SIMATIC® S7-300



Card type	FLKM 14-PA-S300
<b>Digital input</b>	6ES7 321-1BH02-0AA0 6ES7 321-1BH10-0AA0 6ES7 321-1BH50-0AA0* 6ES7 321-7BH01-0AB0*
<b>Digital output</b>	6ES7 322-1BH01-0AA0 6ES7 322-1BH10-0AA0 6ES7 322-8BF00-0AB0*
<b>Digital input/output</b>	6ES7 323-1BH01-0AA0
<b>Analog input</b>	6ES7 331-7KF02-0AB0* 6ES7 331-7HF01-0AB0* 6ES7 331-7KB02-0AB0* 6ES7 331-7TF01-0AB0*
<b>Analog output</b>	6ES7 332-5HD01-0AB0* 6ES7 332-5HB01-0AB0* 6ES7 332-7ND02-0AB0*
<b>Analog input/output</b>	6ES7 334-0CE01-0AA0* 6ES7 334-0KE00-0AB0* 6ES7 335-7HG01-0AB0*
<b>Other modules</b>	6ES7 338-4BC01-0AB0* 6ES7 350-1AH03-0AE0* 6ES7 351-1AH01-0AE0* 6ES7 352-1AH02-0AE0* 6ES7 353-1AH01-0AE0* 6ES7 354-1AH01-0AE0* 6ES7 355-0VH10-0AE0* 6ES7 355-1VH10-0AE0*

\* Only in conjunction with  
VIP-2/SC/2FLK14 (1-20)/S7, Order No.: 2315230  
VIP-2/PT/2FLK14 (1-20)/S7, Order No.: 2903802  
FLKM-2FLK14/KDS 3-MT/PPA/S7, Order No.: 2295062  
All wire jumpers (DR) on the adapter must be disconnected.  
There must be no voltage supply at the front adapter (flowing via the slip-on connections)!

#### Note:

The front adapters are non-isolated on delivery.  
Removal of the wire jumpers can achieve electrical isolation (in groups of 8).

#### Explanation:

-  Flat-ribbon cable strip
-  Connection to I/O card
-  Screw terminal blocks for separate supply

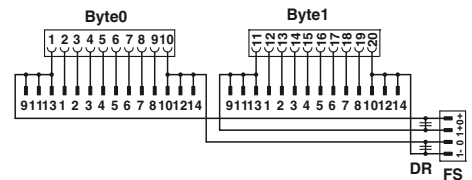

Connection scheme FLKM 14-PA-S300



# System cabling for controllers

## Controller-specific system cabling

### Siemens SIMATIC® S7-300 Front adapter for failsafe modules

The front adapters are coupled using 50-pos. system cables and convert the signals for passive modules.



Siemens SIMATIC S7-300 front adapter for failsafe I/O cards

#### Technical data

Max. perm. operating voltage	< 50 V AC / 60 V DC
Max. permissible current	1 A (per path)
Max. perm. total current	2 A
Ambient temperature (operation)	-20 °C ... 50 °C
Ambient temperature (storage/transport)	-20 °C ... 70 °C
Standards/regulations	IEC 60664 / DIN EN 50178 / IEC 62103
Connection method	Flat-ribbon cable connector in acc. with IEC 60603-13

#### Ordering data

Description	No. of pos.	Type	Order No.	Pcs. / Pkt.
<b>VARIOFACE front adapter for failsafe I/O cards</b>				
6ES7 326-1BK02-0AB0 6ES7 326-1RF00-0AB0 6ES7 336-1HE00-0AB0	50	FLKM 50-PA-S300/SO167	2307662	1
<b>VARIOFACE front adapter for failsafe I/O cards</b>				
6ES7 326-2BF01-0AB0	50	FLKM 50-PA/DO326/S7-300	2321952	1

#### Front adapter for I/O modules of SIMATIC® S7-300

Card type	FLKM 50-PA-S300/SO167
Digital input	6ES7 326-1BK02-0AB0* 6ES7 326-1RF00-0AB0**)
Analog input	6ES7 336-1HE00-0AB0*
<hr/>	
Card type	FLKM 50-PA/DO326/S7-300
Digital output	6ES7 326-2BF01-0AB0** 6ES7 326-2BF10-0AB0**

\* Only in conjunction with  
VIP-2/SC/FLK50 (1-40)/S7, Order No.: 2315243,  
VIP-2/PT/FLK50 (1-40)/S7, Order No.: 2903804,  
FLKM 50/KDS3-MT/PPA/S7-300, Order No.: 2304490.

\*\* Only in conjunction with  
FLKM 50/DO326/S7-300, Order No. 2321965.

1) Not suitable for signals from the Ex area.

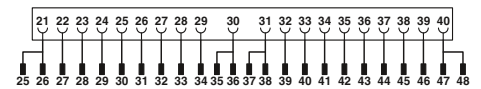
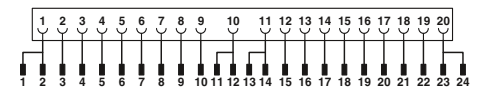

Connection scheme FLKM 50-PA-S300/SO167

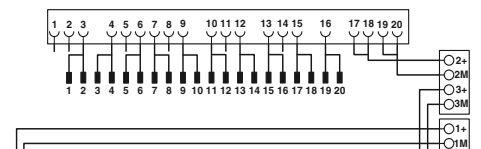

Connection scheme FLKM 50-PA/DO326/S7-300

**Explanation:**

### Siemens SIMATIC S7 -300 System cables for 64-channel I/O cards

These system cables are plugged onto the 64-channel (2x32) I/O cards that are directly connected using connectors.

#### CABLE-FCN40/1X50/...

- Signal transmission of 1x32 channels
- System cable: 40-pos. connector on 50-pos. flat-ribbon cable strip

#### CABLE-FCN40/4X14/...

- Signal transmission of 4x8 channels
- Splitting cable: 40-pos. connector on four 14-pos. flat-ribbon cable strips



System cable



Splitting cable

ERC

#### Technical data

Max. perm. operating voltage	< 50 V AC / 60 V DC
Max. perm. current carrying capacity per path	1 A
Max. conductor resistance	0.16 Ω/m
Ambient temperature (operation)	-20 °C ... 50 °C
Conductor cross section	AWG 26 / 0.14 mm <sup>2</sup>
Conductor structure: stranded wires / material	7 / Cu tin-plated

#### Ordering data

Description	No. of pos.	Cable length
<b>Round cable, for output module 6ES7 322-1BP00-0AA0 and 6ES7 322-1BP50-0AA0 (two cables per module)</b>		
	40	0.5 m
	40	1 m
	40	2 m
	40	3 m
	40	4 m
	40	6 m
	40	8 m
	40	10 m
<b>Round cable, for input module 6ES7 321-1BP00-0AA0 (two cables per module). Plus-reading operation (sinking mode) of the module</b>		
	40	0.5 m
	40	1 m
	40	2 m
	40	3 m
	40	4 m
	40	6 m
	40	8 m
	40	10 m

ERC

#### Technical data

Max. perm. operating voltage	< 50 V AC / 60 V DC
Max. perm. current carrying capacity per path	1 A
Max. conductor resistance	0.16 Ω/m
Ambient temperature (operation)	-20 °C ... 50 °C
Conductor cross section	AWG 26 / 0.14 mm <sup>2</sup>
Conductor structure: stranded wires / material	7 / Cu tin-plated

#### Ordering data

Type	Order No.	Pcs. / Pkt.	Type	Order No.	Pcs. / Pkt.
CABLE-FCN40/1X50/ 0,5M/S7-OUT	2321017	1	CABLE-FCN40/4X14/ 0,5M/S7-OUT	2321172	1
CABLE-FCN40/1X50/ 1,0M/S7-OUT	2321020	1	CABLE-FCN40/4X14/ 1,0M/S7-OUT	2321185	1
CABLE-FCN40/1X50/ 2,0M/S7-OUT	2321033	1	CABLE-FCN40/4X14/ 2,0M/S7-OUT	2321198	1
CABLE-FCN40/1X50/ 3,0M/S7-OUT	2321046	1	CABLE-FCN40/4X14/ 3,0M/S7-OUT	2321208	1
CABLE-FCN40/1X50/ 4,0M/S7-OUT	2321059	1	CABLE-FCN40/4X14/ 4,0M/S7-OUT	2321211	1
CABLE-FCN40/1X50/ 6,0M/S7-OUT	2321062	1	CABLE-FCN40/4X14/ 6,0M/S7-OUT	2321224	1
CABLE-FCN40/1X50/ 8,0M/S7-OUT	2321075	1	CABLE-FCN40/4X14/ 8,0M/S7-OUT	2321237	1
CABLE-FCN40/1X50/10,0M/S7-OUT	2321088	1	CABLE-FCN40/4X14/10,0M/S7-OUT	2321240	1
CABLE-FCN40/1X50/ 0,5M/S7-IN	2321091	1	CABLE-FCN40/4X14/ 0,5M/S7-IN	2321253	1
CABLE-FCN40/1X50/ 1,0M/S7-IN	2321101	1	CABLE-FCN40/4X14/ 1,0M/S7-IN	2321266	1
CABLE-FCN40/1X50/ 2,0M/S7-IN	2321114	1	CABLE-FCN40/4X14/ 2,0M/S7-IN	2321279	1
CABLE-FCN40/1X50/ 3,0M/S7-IN	2321127	1	CABLE-FCN40/4X14/ 3,0M/S7-IN	2321282	1
CABLE-FCN40/1X50/ 4,0M/S7-IN	2321130	1	CABLE-FCN40/4X14/ 4,0M/S7-IN	2321295	1
CABLE-FCN40/1X50/ 6,0M/S7-IN	2321143	1	CABLE-FCN40/4X14/ 6,0M/S7-IN	2321305	1
CABLE-FCN40/1X50/ 8,0M/S7-IN	2321156	1	CABLE-FCN40/4X14/ 8,0M/S7-IN	2321318	1
CABLE-FCN40/1X50/10,0M/S7-IN	2321169	1	CABLE-FCN40/4X14/10,0M/S7-IN	2321321	1

# System cabling for controllers

## Controller-specific system cabling

### Siemens SIMATIC® S7-300 Front adapter for MINI MCR

This front adapter is used exclusively to couple the MINI MCR-SL-V8-FLK 16 A adapter. Changed standard analog signals can be transmitted with the help of these components.

Suitable isolators can be found from page 92.

For suitable 16-pos. system cable (FLK 16/EZ-DR/...), refer to page 606.



Front adapter for SIMATIC® S7-300,  
20-pos. analog I/O cards



#### Technical data

FLKM 16-PA-S300/MINI-MCR  
 < 50 V AC / 60 V DC  
 50 mA (per path)  
 500 mA (per connection, supply via separate power supply)

-20 °C ... 60 °C  
 -20 °C ... 70 °C  
 IEC 60664 / DIN EN 50178 / IEC 62103

#### Ordering data

Type	Order No.	Pcs. / Pkt.
FLKM 16-PA-S300/MINI-MCR	2314749	1
<b>Accessories</b>		
FLK 16/EZ-DR/ 300/KONFEK	2299330	1
MINI MCR-SL-V8-FLK 16-A	2811268	1

Max. perm. operating voltage  
 Max. permissible current

Ambient temperature (operation)  
 Ambient temperature (storage/transport)  
 Standards/regulations

Description	No. of pos.
<b>VARIOFACE front adapter</b> , for SIMATIC® S7-300, only in connection with MINI MCR-SL-V8-FLK 16-A	16

Assembled round cable, with two 16-pos. socket strips

System adapter, for MINI Analog modules with screw connection

Front adapter for analog cards of  
 SIMATIC® S7-300

Card type	FLKM 16-PA-S300/MINI-MCR
Analog input	6ES7 331-7KF02-0AB0 6ES7 331-7KB02-0AB0 6ES7 331-7KB81-0AB0 6ES7 331-7TF00-0AB0
Analog output	6ES7 332-8TF01-0AB0

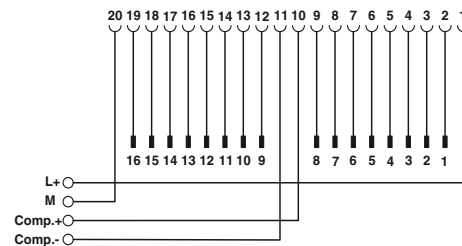
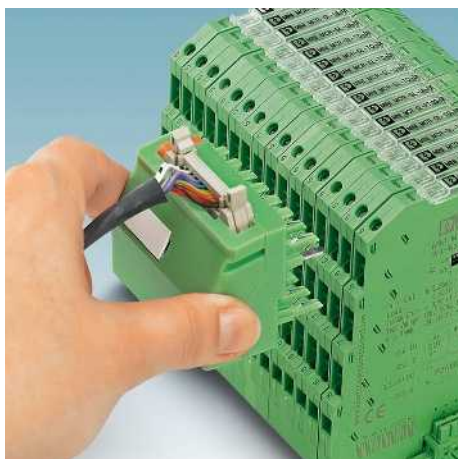

FLKM 16-PA-S300/MINI-MCR connection scheme

#### Explanation:

- Flat-ribbon cable strip
- Connection to I/O card
- Screw terminal blocks for separate supply

**Siemens SIMATIC® S7-300**  
**Front adapter for**  
**MINI Analog system cabling**

The FLKM 16-PA-331-1KF//MINI-MCR front adapter helps in system cabling in conjunction with the MINI Analog system adapter and a 16-pos. system cable FLK 16/EZ-DR/.../KONFEK, refer to page 606.

Instead of the conventional front connector, screw terminal blocks are used to snap this component onto the analog module.

The DIP switches can be used to connect “M-” connections to each other and to the central ground of the system.

The front adapter supports **only current signals**.

The front adapter is suitable for the following analog input card:  
 – 6ES7 331-1KF02-0AB0

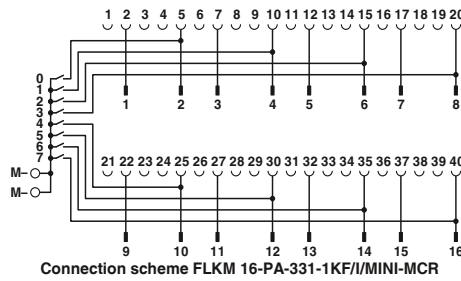

Max. perm. operating voltage  
 Max. permissible current  
 Ambient temperature (operation)  
 Ambient temperature (storage/transport)  
 Standards/regulations

< 50 V AC / 60 V DC  
 50 mA (per path)  
 -20 °C ... 60 °C  
 -20 °C ... 70 °C  
 IEC 60664 / DIN EN 50178 / IEC 62103

Description	No. of pos.
<b>VARIOFACE front adapter</b> , for SIMATIC® S7-300, only in connection with MINI MCR-SL-V8-FLK 16-A	16

Ordering data		
Type	Order No.	Pcs. / Pkt.
FLKM 16-PA- 331-1KF//MINI-MCR	2318237	1



Front adapter for SIMATIC® S7-300,  
 6ES7 331-1KF02-0AB0 analog I/O card

Technical data

Ordering data

**Siemens SIMATIC® S7-300**  
**Front adapter for**  
**MINI Analog system cabling**

The FLKM 16-PA-332-5HF//MINI-MCR front adapter helps in system cabling in conjunction with the MINI Analog system adapter and a 16-pos. system cable FLK 16/EZ-DR/.../KONFEK, refer to page 606.

Instead of the conventional front connector, screw terminal blocks are used to snap this component onto the analog module.

The front adapter supports **only current signals**.

The front adapter is suitable for the following analog output cards:  
 – 6ES7 332-5HF00-0AB0

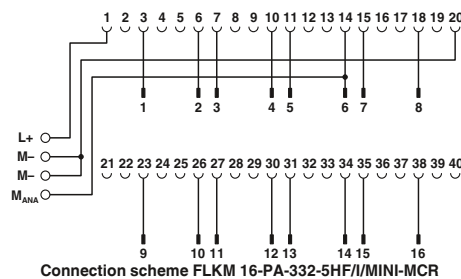

Max. perm. operating voltage  
 Max. permissible current  
 Ambient temperature (operation)  
 Ambient temperature (storage/transport)  
 Standards/regulations

< 50 V AC / 60 V DC  
 50 mA (per path)  
 500 mA (per connection, supply via separate power supply)  
 -20 °C ... 60 °C  
 -20 °C ... 70 °C  
 IEC 60664 / DIN EN 50178 / IEC 62103

Description	No. of pos.
<b>VARIOFACE front adapter</b> , for SIMATIC® S7-300, only in connection with MINI MCR-SL-V8-FLK 16-A	16

Ordering data		
Type	Order No.	Pcs. / Pkt.
FLKM 16-PA- 332-5HF//MINI-MCR	2318240	1



Front adapter for SIMATIC® S7-300,  
 6ES7 332-5HF00-0AB0 analog I/O card

Technical data

Ordering data

# System cabling for controllers

## Controller-specific system cabling

### Siemens SIMATIC® S7-1500

#### System cables for front connectors from the “TOP connect” series

These system cables are connected directly to Siemens “SIMATIC TOP connect” front connectors. A VARIOFACE front adapter is not required. The cables can be used to connect existing 8-channel Phoenix Contact interface modules.

- For passive signal transmission, e.g., VIP-2/SC/FLK14/PLC;  
Order No. 2315214, see page 542.
- For relay or solid-state relay connection via V8 adapters, e.g., PLC-V8/FLK14/OUT;  
Order No. 2295554, see page 451.

The system cables are available in the following versions:

- Unshielded
- Shielded
- Halogen-free

The following SIMATIC® S7-1500 cards can be coupled:

#### Digital input:

- 6ES7 521-1BH00-0AB0
- 6ES7 521-1BH50-0AA0
- 6ES7 521-1BL00-0AB0

#### Digital output:

- 6ES7 522-1BH00-0AB0
- 6ES7 522-1BL00-0AB0

#### Web code for the online configurator

**i** Your web code: #0007

#### Notes:

These system cables are connected directly to the Siemens S7-1500 6ES7 921-5AB20-0AA0 or 6ES7 921-5AH20-0AA0 front connector modules.

The Siemens adapters are not supplied by Phoenix Contact.



#### Technical data

Max. perm. operating voltage	< 50 V AC / 60 V DC
Max. perm. current carrying capacity per path	1 A
Max. conductor resistance	0.16 Ω/m
Ambient temperature (operation)	-20 °C ... 50 °C
Assembly	Insulation displacement, IEC 60352-4/DIN EN 60352-4
Number of positions, control side	16
Number of positions, module side	14
Conductor cross section	AWG 26 / 0.14 mm <sup>2</sup>
Conductor structure: stranded wires / material	7 / Cu tin-plated
Outside diameter	6.4 mm

#### Ordering data

Description	Cable length	Type	Order No.	Pcs. / Pkt.
<b>Unshielded round cables</b> , with one 16-pos. and one 14-pos. socket strip in fixed lengths for transmitting 8 channels				
	0.5 m	FLK 14/16/EZ-DR/ 50/S7	2293815	5
	1 m	FLK 14/16/EZ-DR/ 100/S7	2293828	1
	1.5 m	FLK 14/16/EZ-DR/ 150/S7	2293831	1
	2 m	FLK 14/16/EZ-DR/ 200/S7	2293844	1
	2.5 m	FLK 14/16/EZ-DR/ 250/S7	2293857	1
	3 m	FLK 14/16/EZ-DR/ 300/S7	2293860	1
	4 m	FLK 14/16/EZ-DR/ 400/S7	2293886	1
	5 m	FLK 14/16/EZ-DR/ 500/S7	2293899	1
	6 m	FLK 14/16/EZ-DR/ 600/S7	2293909	1
	7 m	FLK 14/16/EZ-DR/ 700/S7	2293912	1
	8 m	FLK 14/16/EZ-DR/ 800/S7	2293925	1
	9 m	FLK 14/16/EZ-DR/ 900/S7	2293938	1
	10 m	FLK 14/16/EZ-DR/1000/S7	2293941	1
<b>Unshielded round cables</b> , as above, but in variable lengths of type “FLK EZ-DR/14U/C52/...”				
		FLK EZ-DR.../.../...	2295059	1
<b>Shielded round cables</b> , with one 16-pos. and one 14-pos. socket strip, for transmitting 8 channels in variable lengths of type “FLK EZ-DR-S/14S/C52/...”				
		FLK EZ-DR-S.../.../...	2295046	1
<b>Unshielded halogen-free round cables</b> , with one 16-pos. and one 14-pos. socket strip, for transmitting 8 channels in variable lengths				



**Halogen-free  
(cable only)**

ERC

### Technical data

< 50 V AC / 60 V DC  
1 A  
0.16 Ω/m  
-20 °C ... 50 °C  
Insulation displacement, IEC 60352-4/DIN EN 60352-4

16  
14  
AWG 26 / 0.14 mm<sup>2</sup>  
7 / Cu tin-plated  
6.4 mm

### Ordering data

Type	Order No.	Pcs. / Pkt.
FLK 14/16/EZ-DR/HF/ 50/S7	2296919	1
FLK 14/16/EZ-DR/HF/ 100/S7	2296922	1
FLK 14/16/EZ-DR/HF/ 150/S7	2296935	1
FLK 14/16/EZ-DR/HF/ 200/S7	2296948	1
FLK 14/16/EZ-DR/HF/ 250/S7	2296951	1
FLK 14/16/EZ-DR/HF/ 300/S7	2296964	1
FLK 14/16/EZ-DR/HF/ 400/S7	2904525	1
FLK 14/16/EZ-DR/HF/ 500/S7	2304704	1
FLK 14/16/EZ-DR/HF/ 600/S7	2904526	1
FLK 14/16/EZ-DR/HF/ 800/S7	2904527	1
FLK 14/16/EZ-DR/HF/1000/S7	2904528	1
FLK 14-16-EZ-DR-HF-S7/...	2295693	1

### Pin assignment and color code:

- FLK 14/16/EZ-DR/.../S7  
- FLK 14/16/EZ-DR/HF/.../S7

14-pos. socket strip PIN	16-pos. socket strip PIN	Wire color
1	16	Black
2	14	Brown
3	12	Red
4	10	Orange
5	8	Yellow
6	6	Green
7	4	Blue
8	2	Violet
9	9	Gray
10	1	White
11	11	White-black
12	3	White-brown
13	13	White-red
14	5	White-orange
Not used	7	-
Not used	15	-

### Ordering example for unshielded round cable:

Unshielded round cable, assembled with one 14-pos. and one 16-pos. socket strip, 12.70 m long  
Type: FLK EZ-DR /14U/C52/...

Quantity	Order No.	Length [m] <sup>1)</sup>
1	2295059/14U/C52	12.70

<sup>1)</sup> Min. 0.20 m

14U ≙ 14-pos. unshielded cable  
C52 ≙ S7-1500 assembly with 14-pos. socket strip at one end and 16-pos. socket strip at the other

### Ordering example for shielded round cable:

Unshielded round cable, assembled with one 14-pos. and one 16-pos. socket strip, 13.20 m long  
Type: FLK EZ-DR-S /14S/C52/...

Quantity	Order No.	Length [m] <sup>1)</sup>
1	2295046/14S/C52	13.20

<sup>1)</sup> Min. 0.20 m

14S ≙ 14-pos. shielded cable  
C52 ≙ S7-1500 assembly with 14-pos. socket strip at one end and 16-pos. socket strip at the other

### Ordering example for halogen-free round cable:

Halogen-free round cable, assembled with one 14-pos. and one 16-pos. socket strip, 15.50 m long  
Type: FLK 14-16-EZ-DR-HF-S7/...

Quantity	Order No.	Length [m] <sup>1)</sup>
1	2295693	15.50

<sup>1)</sup> Min. 0.20 m

# System cabling for controllers

## Controller-specific system cabling

### Siemens SIMATIC® S7-400

#### Front adapter

The front adapters mean that pre-assembled system cables can be directly connected to I/O modules.

#### FLKM 50-PA-S400

– Transmission of max. 32 digital channels over one 50-position system cable.

#### FLKM 50/4-FLK14/PA-S400

– Transmission of max. 32 digital channels via one 14-position system cable.

Tailor-made VARIOFACE termination boards with a variety of functions and connection options round off this system concept.

#### FLKM 50-PA-S400 (3-48)

– Analog channels are connected via a 50-position system cable.

The 1:1 connection of the adapter means that corresponding 1:1 interface modules are connected here

#### Web code for the online configurator

**i** Your web code: #0007



Front adapter for SIMATIC® S7-400



#### Technical data

Max. perm. operating voltage	< 50 V AC / 60 V DC
Max. permissible current	1 A (per path) 8 A (per connection, supply via separate power supply)
Max. perm. total current	2 A (per byte, for supply via connector) 8 A (during supply via a separate bridged power supply)
Ambient temperature (operation)	-20 °C ... 50 °C
Ambient temperature (storage/transport)	-20 °C ... 70 °C
Mounting position	any
Standards/regulations	IEC 60664 / DIN EN 50178 / IEC 62103

#### Ordering data

Description	No. of pos.	Type	Order No.	Pcs. / Pkt.
<b>VARIOFACE front adapter, for</b>				
- SIMATIC® S7-400, 1 x 32 channels can be connected	50	<b>FLKM 50-PA-S400</b>	<b>2294500</b>	2
- SIMATIC® S7-400, 4 x 8 channels can be connected	14	<b>FLKM 50/ 4-FLK14/PA-S400</b>	<b>2294429</b>	2
- SIMATIC® S7-400, only analog	50	<b>FLKM 50-PA-S400(3-48)</b>	<b>2294908</b>	2

Front adapter for I/O modules of the Siemens automation devices SIMATIC® S7-400

Card type	FLKM 50-PA-S400
Digital input	6ES7 421-1BL01-0AA0 6ES7 421-7BH01-0AB0* 6ES7 421-7DH00-0AB0*
Digital output	6ES7 422-1BL00-0AA0 6ES7 422-7BL00-0AB0

Card type	FLKM 50/4-FLK14/PA-S400
Digital input	6ES7 421-1BL01-0AA0
Digital output	6ES7 422-1BL00-0AA0 6ES7 422-7BL00-0AB0

Card type	FLKM 50-PA-S400 (3-48)
Analog input	6ES7 431-0HH00-0AB0** 6ES7 431-1KF00-0AB0** 6ES7 431-1KF10-0AB0** 6ES7 431-1KF20-0AB0** 6ES7 431-7KF00-0AB0** 6ES7 431-7KF10-0AB0** 6ES7 431-7QH00-0AB0**
Analog output	6ES7 432-1HF00-0AB0**

\* Only in conjunction with VIP-2/SC/FLK50/S7/A-S400, Order No.: 2322359  
VIP-2/PT/FLK50/S7/A-S400, Order No.: 2904289  
all DR wire jumpers on the adapter must be disconnected.

\*\* Only in conjunction with VIP-3/SC/FLK50, Order No.: 2315081  
VIP-3/PT/FLK50, Order No.: 2903794  
FLKM 50/KDS 3-MT/PPA/AN/PLC, Order No.: 2291587

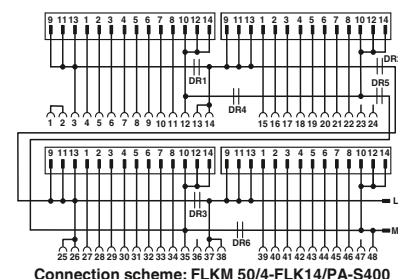
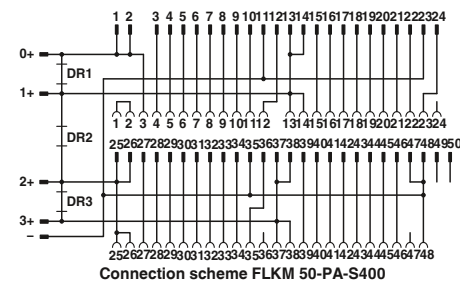
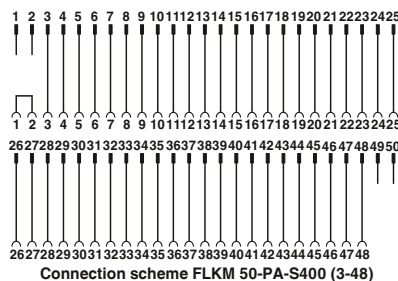

#### Explanation:

- Flat-ribbon cable strip
- Connection to I/O card
- Screw terminal blocks for separate supply



### Siemens SIMATIC® S7-400 Adapter for conversion from S5-135/155 to S7-400

The FLKM S135/... adapters connect a SIMATIC® S5 plug wired with individual conductors directly with the SIMATIC® S7-400 basic card.

The SIMATIC® S5 plug is plugged directly onto an S7-400-I/O card with the help of an FFLKM S135/... intermediate adapter.

A new SIMATIC® S7-400 is installed in place of the SIMATIC® S5. The existing field wiring remains intact.

#### Attention:

The LEDs of the S7-400 module are hidden.



Adapter for Siemens SIMATIC® S5-135/S7-400

Max. perm. operating voltage  
Max. permissible current

Ambient temperature (operation)  
Mounting position

Standards/regulations

Technical data			
①	②	③	④
60 V DC	60 V DC	60 V DC	60 V DC
4 A (per path)	2 A (per path)	4 A (per path)	4 A (per path)
-20 °C ... 50 °C any	-20 °C ... 50 °C any	-20 °C ... 50 °C any	-20 °C ... 50 °C any
IEC 60664 / DIN EN 50178 / IEC 62103			

Ordering data			
Type	Order No.	Pcs. / Pkt.	
FLKM S135/S400/SO120	2301723	1	①
FLKM S135/S400/SO121	2301736	1	②
FLKM S135-431-4UA/S400	2314846	1	③
FLKM S135/S400/SO122	2301749	1	④

Description	No. of pos.
<b>Digital IN 24 V from S5-135/155 to S7-400</b>	
6ES5 420-4UA14 to 6ES7 421-1BL01-0AA0	①
6ES5 430-4UA14 to 6ES7 421-1BL01-0AA0	②
6ES5 431-4UA12 to 6ES7 421-7DH00-0AB0	③
6ES5 432-4UA12 to 6ES7 421-1BL01-0AA0	④

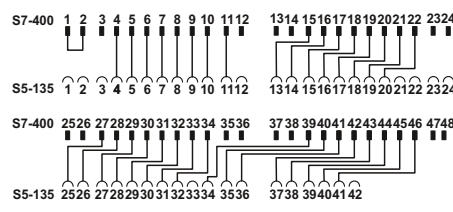

FLKM S135-431-UA/S400 connection scheme

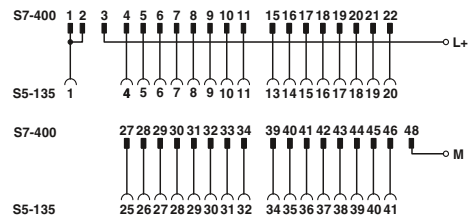

Connection scheme: FLKM S135/S400/SO120

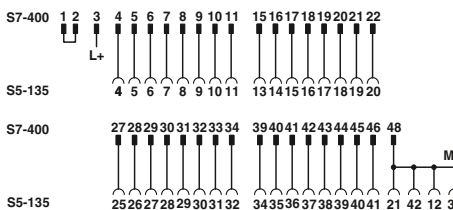

Connection scheme: FLKM S135/S400/SO122

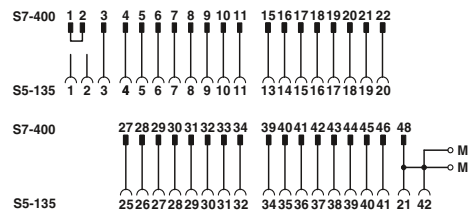

Connection scheme: FLKM S135/S400/SO121

## Controller-specific system cabling

### Siemens SIMATIC® S7-400 Adapter for conversion from S5-135/155 to S7-400

The FLKM S135/... adapters connect a SIMATIC® S5 plug wired with individual conductors directly with the SIMATIC® S7-400 basic card.

The SIMATIC® S5 plug is plugged directly onto an S7-400-I/O card with the help of an FFLKM S135/... intermediate adapter.

A new SIMATIC® S7-400 is installed in place of the SIMATIC® S5. The existing field wiring remains intact.

#### Attention:

The LEDs of the S7-400 module are hidden.



Front adapter for SIMATIC S5-135 S7 400

Max. perm. operating voltage  
Max. permissible current

Ambient temperature (operation)  
Mounting position

Standards/regulations

#### Technical data

①	②	③
60 V DC	60 V DC	60 V DC
4 A (per path)	4 A (per path)	4 A (per path)
-20 °C ... 50 °C	-20 °C ... 50 °C	-20 °C ... 50 °C
any	any	any

IEC 60664 / DIN EN 50178 / IEC 62103

#### Ordering data

Description	No. of pos.
<b>Digital OUT 24 V from S5-135/155 to S7-400</b>	
6ES5 441-4UA12 to 6ES7 422-1BL00-0AA0	①
6ES5 451-4UA14 to 6ES7 422-1BL00-0AA0	②
<b>Digital OUT 24 V DC / 2 A from S5-135/155 to S7-400</b>	
6ES5 453-4UA12 to 6ES7 422-1HH00-0AA0	③

Type	Order No.	Pcs. / Pkt.
FLKM S135/S400/SO125	2301778	1
FLKM S135/S400/SO126	2301781	1
FLKM S135/S400/SO127	2301794	1

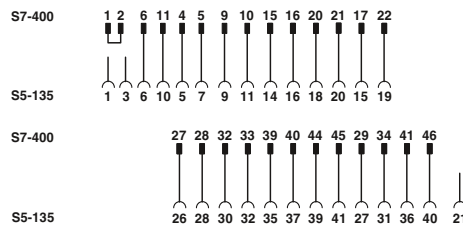

Connection scheme: FLKM S135/S400/SO127

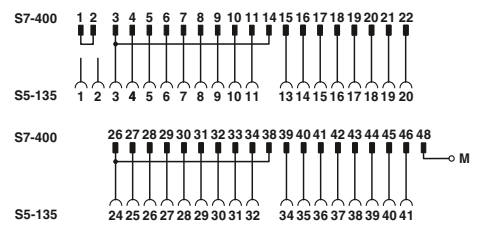

Connection scheme: FLKM S135/S400/SO125

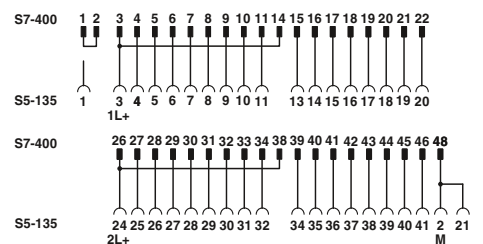

Connection scheme: FLKM S135/S400/SO126

### Siemens SIMATIC® S7-400 Adapter for conversion from S5-135/155 to S7-400

The FLKM S135/... adapters connect a SIMATIC® S5 plug wired with individual conductors directly with the SIMATIC® S7-400 basic card.

The SIMATIC® S5 plug is plugged directly onto an S7-400-I/O card with the help of an FFLKM S135/... intermediate adapter.

A new SIMATIC® S7-400 is installed in place of the SIMATIC® S5. The existing field wiring remains intact.

#### Attention:

The LEDs of the S7-400 module are hidden.



Adapter for Siemens SIMATIC® S5-135/S7-400

Max. perm. operating voltage  
Max. permissible current

Ambient temperature (operation)  
Mounting position

Standards/regulations

#### Technical data

①	②	③
60 V DC	60 V DC	60 V DC
4 A (per path)	4 A (per path)	4 A (per path)
-20 °C ... 50 °C	-20 °C ... 50 °C	-20 °C ... 50 °C
any	any	any

IEC 60664 / DIN EN 50178 / IEC 62103

Description	No. of pos.
<b>Digital OUT 24 V DC / 2 A from S5-135/155 to S7-400</b>	
6ES5 454-4UA14 to 6ES7 422-1BH11-0AA0	①
<b>Analog IN (only current measurement) from S5-135/155 to S7-400</b>	
6ES5 460-4UA13 to 6ES7 431-1KF00-0AB0	②
<b>Analog IN (only voltage measurement) from S5-135/155 to S7-400</b>	
6ES5 460-4UA13 to 6ES7 431-1KF00-0AB0	③

#### Ordering data

Type	Order No.	Pcs. / Pkt.
FLKM S135-454-4UA/S400	2314859	1
FLKM S135-460-4UA/I/S400	2314613	1
FLKM S135-460-4UA/U/S400	2314862	1

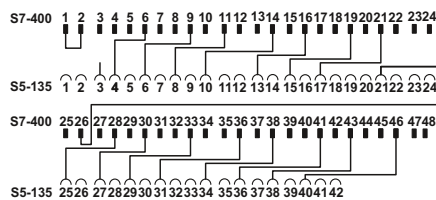

Connection scheme: FLKM S135-460-4UA/U/S400

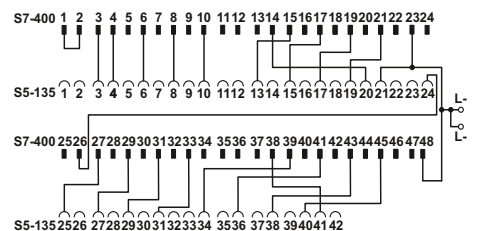

FLKM S135-454-4UA/S400 connection scheme

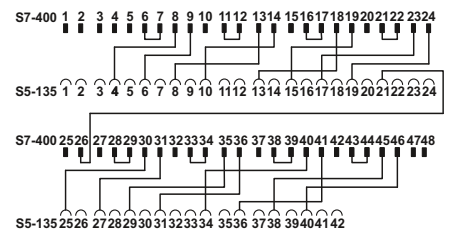

FLKM S135-460-4UA/I/S400 connection scheme

# System cabling for controllers

## Controller-specific system cabling

### Siemens SIMATIC® S7-400 Adapter for conversion from S5-135/155 to S7-400

The FLKM S135/... adapters connect a SIMATIC® S5 plug wired with individual conductors directly with the SIMATIC® S7-400 basic card.

The SIMATIC® S5 plug is plugged directly onto an S7-400-I/O card with the help of an FFLKM S135/... intermediate adapter.

A new SIMATIC® S7-400 is installed in place of the SIMATIC® S5. The existing field wiring remains intact.

#### Attention:

The LEDs of the S7-400 module are hidden.



Adapter for Siemens SIMATIC® S5-135/S7-400



Max. perm. operating voltage  
Max. permissible current

Ambient temperature (operation)  
Mounting position

Standards/regulations

#### Technical data

①	②	③	④
60 V DC	60 V DC	60 V DC	60 V DC
2 A (per path)	4 A (per path)	4 A (per path)	4 A (per path)
-20 °C ... 50 °C	-20 °C ... 50 °C	-20 °C ... 50 °C	-20 °C ... 50 °C
any	any	any	any

IEC 60664 / DIN EN 50178 / IEC 62103

#### Ordering data

Description	No. of pos.
<b>Analog IN (only Pt 100) from S5-135/155 to S7-400</b>	
6ES5 465-4UA13 to 6ES7 431-7KF10-0AB0	①
<b>Analog IN (only current and voltage measurement) from S5-135/155 to S7-400</b>	
6ES5 465-4UA13 to 6ES7 431-0HH00-0AB0	②
6ES5 465-4UA13 to 6ES7 431-7QH00-0AB0	
<b>Analog OUT (only current output) from S5-135/155 to S7-400</b>	
6ES5 470-4UA13 to 6ES7 432-1HF00-0AB0	③
6ES5 470-4UC13 to 6ES7 432-1HF00-0AB0	
<b>Analog OUT (only voltage output) from S5-135/155 to S7-400</b>	
6ES5 470-4UA13 to 6ES7 432-1HF00-0AB0	④
6ES5 470-4UB13 to 6ES7 432-1HF00-0AB0	
6ES5 470-4UC13 to 6ES7 432-1HF00-0AB0	

Type	Order No.	Pcs. / Pkt.
FLKM S135-465-4UA/T/S400	2314875	1
FLKM S135-465-4UA/UI/S400	2314888	1
FLKM S135-470-4UC/I/S400	2314626	1
FLKM S135-470-4UC/U/S400	2314891	1

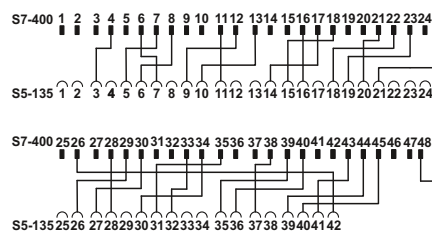

Connection scheme FLKM S135-470-4UC/I/S400

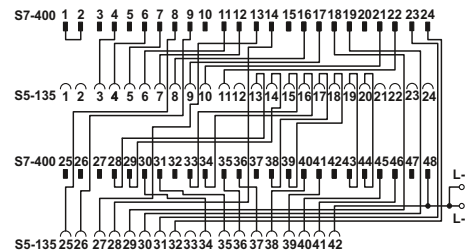

FLKM S135-465-4UA/T/S400 connection scheme

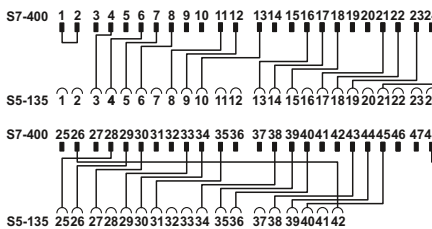

Connection scheme FLKM S135-470-4UC/U/S400

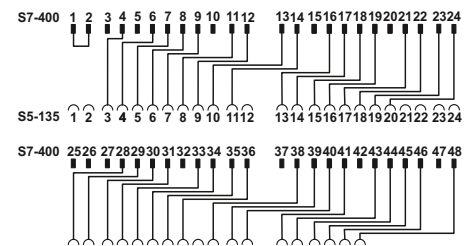

FLKM S135-465-4UA/UI/S400 connection scheme

**Siemens SIMATIC® S7-300  
Adapter for conversion from  
S5-135/155 to S7-300**

S5-S7 adapters connect the S5-135 front adapters wired with individual wires to the I/O modules of the S7.

With the help of the FLKM S135/S7/FLK50 converter module, the signals of the S5-135 front adapter can be converted to a 50-pos. strip. A 50-pos. system cable FLK 50/EZ-DR/.../KONFEK and a front adapter for the SIMATIC® S7 (FLKM 50-PA-S300) now connect the signals with the I/O module.

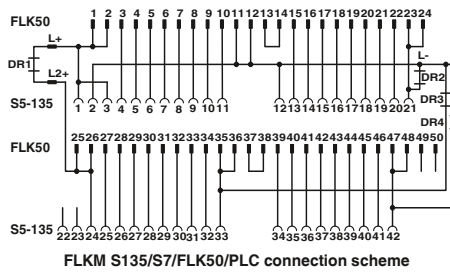

Max. perm. operating voltage  
Max. permissible current  
Ambient temperature (operation)  
Ambient temperature (storage/transport)  
Mounting position  
Standards/regulations



Converter for Siemens SIMATIC® S5-135 to 50-pos. FLK strip.

**Notes:**  
Due to the geometry, it is not possible to couple any molded FLK connectors (e.g., VIP-PA...S7).

**Technical data**

60 V DC  
1 A (per path)  
-20 °C ... 50 °C  
-20 °C ... 70 °C  
any  
IEC 60664 / DIN EN 50178 / IEC 62103

**Ordering data**

Description
<b>Digital IN or OUT 24 V DC from S5-135 to S7-300</b>
<b>IN</b> 6ES5 420-4UA14 to 6ES7 321-1BL00-0AA0 6ES5 430-4UA14 to 6ES7 321-1BL00-0AA0
<b>OUT</b> 6ES5 441-4UA14 to 6ES7 322-1BL00-0AA0 6ES5 451-4UA14 to 6ES7 322-1BL00-0AA0

Type	Order No.	Pcs. / Pkt.
FLKM S135/S7/FLK50/PLC	2314736	1

**Startup adapters for extending the existing S5-135/155 field wiring**

All signals of the existing S5-135 wiring are extended by 3 or 5 meters with the help of the universal startup adapters. The open cable end can be connected to various controllers such as S7-400 or S7-300. Thus, the existing field wiring of S5-135 can communicate with the new controller unit is temporarily arranged before the control cabinet, the original status of the system can be restored if required.

If the system functions with the new controller without problems, the S5-135 can now be replaced.

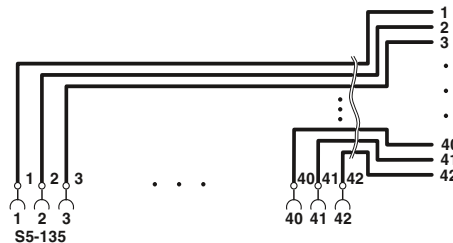

Max. perm. operating voltage  
Max. permissible current  
Ambient temperature (operation)  
Ambient temperature (storage/transport)  
Mounting position  
Standards/regulations



**Technical data**

250 V AC/DC  
6 A (per path)  
-20 °C ... 50 °C  
-20 °C ... 80 °C  
any  
IEC 60664 / DIN EN 50178 / IEC 62103

**Ordering data**

Description
<b>Connection of all S5-135 connections (1 to 42) at the open cable end</b>

Type	Order No.	Pcs. / Pkt.
FLKM S135/42X0,75/3,0M/OE	2315007	1
FLKM S135/42X0,75/5,0M/OE	2318017	1

## Controller-specific system cabling

### Siemens SIMATIC® S7-400 Adapter for conversion from S5-115 to S7-400

The FLKM S115/... adapters connect a SIMATIC® S5 plug wired with individual conductors directly with the SIMATIC® S7-400 basic card.

The SIMATIC® S5 plug is plugged directly onto an S7-400-I/O card with the help of an FFLKM S115/... intermediate adapter.

A new SIMATIC® S7-400 is installed in place of the SIMATIC® S5. The existing field wiring remains intact.

#### Attention:

Due to the geometry, it is only possible to use every other slot. The LEDs of the S7-400 module are hidden by the S5-115 adapter.



Adapter for Siemens SIMATIC® S5-115/S7-400

Max. perm. operating voltage  
Max. permissible current

Ambient temperature (operation)  
Ambient temperature (storage/transport)  
Mounting position  
Standards/regulations

60 V DC  
4 A (per path)  
4 A (per connection, supply via separate power supply)

-20 °C ... 50 °C  
-20 °C ... 70 °C  
any  
IEC 60664 / DIN EN 50178 / IEC 62103

#### Technical data

#### Ordering data

Description
<b>Digital IN or OUT 24 V DC from S5-115 to S7-400</b>
<b>IN</b> 6ES5 420-7LA11 to 6ES7 421-1BL01-0AA0 6ES5 430-7LA11 to 6ES7 421-1BL01-0AA0
<b>OUT</b> 6ES5 441-7LA11 to 6ES7 422-1BL00-0AA0 6ES5 451-7LA11 to 6ES7 422-1BL00-0AA0
<b>Digital OUT 24 V DC from S5-115 to S7-400</b>
6ES5 454-7LA12 to 6ES7 422-1BH11-0AA0
<b>Analog IN (only current and voltage measurement) from S5-115 to S7-400</b>
6ES5 465-7LA13 to 6ES7 431-0HH00-0AB0 6ES5 465-7LA13 to 6ES7 431-7QH00-0AB0

Type	Order No.	Pcs. / Pkt.
FLKM S115/S400/SO155	2307248	1
FLKM S115-454-7LA/S400	2314901	1
FLKM S115-465-7LA/UI/S400	2314914	1

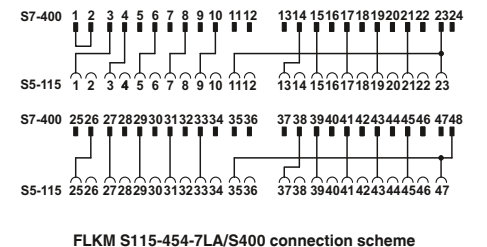
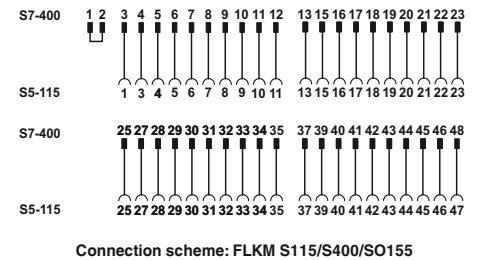
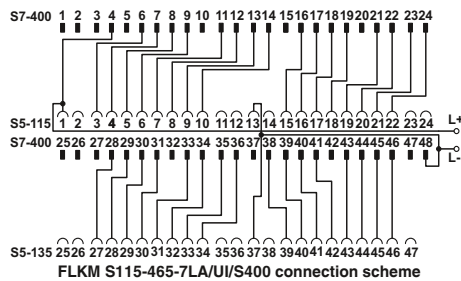

**Siemens SIMATIC® S7-300  
Adapter for conversion from  
S5-115 to S7-300**

S5-S7 adapters connect the S5-115 front adapters wired with individual wires to the I/O modules of S7-300.

With the aid of the FLKM S115/S7/FLK50/SO137 converter module, the signals of the S5-115 front adapter can be converted to a 50-pos. strip. A 50-pos. system cable FLK 50/EZ-DR/.../KONFEK and a front adapter for the SIMATIC® S7 (FLKM 50-PA-S300) now connect the signals with the I/O module.

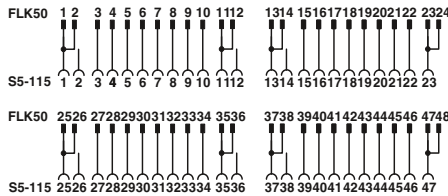

Connection scheme: FLKM S115/S7/FLK50/PLC/SO137



Converter for Siemens SIMATIC® S5-115 to 50-pos. FLK strip.

**Notes:**  
Due to the geometry, it is not possible to couple any molded FLK connectors (e.g., VIP-PA...S7).

Max. perm. operating voltage  
Max. permissible current  
Max. perm. total current  
Ambient temperature (operation)  
Ambient temperature (storage/transport)  
Standards/regulations

60 V DC  
1 A (per path)  
2 A (per byte)  
-20 °C ... 50 °C  
-20 °C ... 70 °C  
IEC 60664 / DIN EN 50178 / IEC 62103

**Technical data**

**Ordering data**

Description
<b>Digital IN or OUT 24 V DC from S5-115 through converters, system cables and front adapters to S7-300</b>
<b>IN</b> 6ES5 420-7LA11 to 6ES7 321-1BL00-0AA0 6ES5 430-7LA11 to 6ES7 321-1BL00-0AA0
<b>OUT</b> 6ES5 441-7LA11 to 6ES7 322-1BL00-0AA0 6ES5 451-7LA11 to 6ES7 322-1BL00-0AA0

Type	Order No.	Pcs. / Pkt.
FLKM S115/S7/FLK50/PLC/SO137	2306294	1

**Startup adapters for extending the existing S5-115 field wiring**

All signals of the existing S5-115 wiring are extended by 3 or 5 meters with the help of the universal startup adapters. The open cable end can be connected to various controllers such as S7-400 or S7-300. Thus, the existing field wiring of S5-115 can communicate with the new controller for test purposes. Since the new control unit is temporarily arranged before the control cabinet, the original status of the system can be restored if required.

If the system functions with the new controller without problems, the S5-115 can now be replaced.

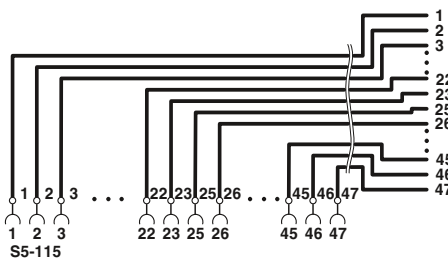

Max. perm. operating voltage  
Max. permissible current  
Ambient temperature (operation)  
Ambient temperature (storage/transport)  
Mounting position  
Standards/regulations

250 V AC/DC  
6 A (per path)  
-20 °C ... 50 °C  
-20 °C ... 80 °C  
any  
DIN EN 50178 / IEC 60664 / IEC 62103

**Technical data**

**Ordering data**

Description
<b>Connection of all S5-115 connections (1 to 23, 25 to 47) at the open cable end</b>

Type	Order No.	Pcs. / Pkt.
FLKM S115/47X0,75/3,0M/OE	2314985	1
FLKM S115/47X0,75/5,0M/OE	2314998	1



# System cabling for controllers

## Controller-specific system cabling

### YOKOGAWA Centum VP and ProSafe-RS System cables

These shielded system cables for digital (50-pos.) and analog (40-pos.) I/O modules are connected directly to the modules. An intermediate adapter is not required.

Features:

- Molded connector
- Can be screwed
- Lateral cable outlet of the I/O module
- KS/AKB-compatible connectors on the module side



Shielded



shielded and halogen-free

ERC

#### Technical data

Max. perm. operating voltage	30 V DC
Max. perm. current carrying capacity per path	500 mA
Max. conductor resistance	0.16 Ω/m
Ambient temperature (operation)	-20 °C ... 50 °C
Conductor cross section	AWG 26 / 0.14 mm <sup>2</sup>
Conductor structure: stranded wires / material	7 / Cu tin-plated
Outside diameter	
	50-position 11 mm
	40-position 11 mm

ERC

#### Technical data

Max. perm. operating voltage	30 V DC
Max. perm. current carrying capacity per path	500 mA
Max. conductor resistance	0.16 Ω/m
Ambient temperature (operation)	-20 °C ... 50 °C
Conductor cross section	AWG 26 / 0.14 mm <sup>2</sup>
Conductor structure: stranded wires / material	7 / Cu tin-plated
Outside diameter	
	11 mm
	11 mm

#### Ordering data

Description	No. of pos.	Cable length	Type	Order No.	Pcs. / Pkt.
<b>50-pos. YUC cables, for digital I/O modules</b>					
	50	1 m	FLK 50-PA/EZ-DR/KS/ 100/YUC	2900991	1
	50	2 m	FLK 50-PA/EZ-DR/KS/ 200/YUC	2314299	1
	50	3 m	FLK 50-PA/EZ-DR/KS/ 300/YUC	2314309	1
	50	4 m	FLK 50-PA/EZ-DR/KS/ 400/YUC	2314312	1
	50	5 m	FLK 50-PA/EZ-DR/KS/ 500/YUC	2321499	1
	50	6 m	FLK 50-PA/EZ-DR/KS/ 600/YUC	2314927	1
	50	7 m	FLK 50-PA/EZ-DR/KS/ 700/YUC	2321509	1
	50	8 m	FLK 50-PA/EZ-DR/KS/ 800/YUC	2314930	1
	50	9 m	FLK 50-PA/EZ-DR/KS/ 900/YUC	2321512	1
	50	10 m	FLK 50-PA/EZ-DR/KS/1000/YUC	2314325	1
	50	15 m	FLK 50-PA/EZ-DR/KS/1500/YUC	2314338	1
	50	20 m	FLK 50-PA/EZ-DR/KS/2000/YUC	2314503	1
	50	25 m	FLK 50-PA/EZ-DR/KS/2500/YUC	2314516	1
	50	30 m	FLK 50-PA/EZ-DR/KS/3000/YUC	2314529	1

#### Ordering data

Description	No. of pos.	Cable length	Type	Order No.	Pcs. / Pkt.
<b>50-pos. YUC cables, for digital I/O modules</b>					
	50	1 m	FLK 50-PA/EZ-DR/HF/KS/ 100/YUC	2904739	1
	50	2 m	FLK 50-PA/EZ-DR/HF/KS/ 200/YUC	2904740	1
	50	3 m	FLK 50-PA/EZ-DR/HF/KS/ 300/YUC	2904741	1
	50	4 m	FLK 50-PA/EZ-DR/HF/KS/ 400/YUC	2904742	1
	50	5 m	FLK 50-PA/EZ-DR/HF/KS/ 500/YUC	2904636	1
	50	6 m	FLK 50-PA/EZ-DR/HF/KS/ 600/YUC	2904743	1
	50	7 m	FLK 50-PA/EZ-DR/HF/KS/ 700/YUC	2904744	1
	50	8 m	FLK 50-PA/EZ-DR/HF/KS/ 800/YUC	2904745	1
	50	9 m	FLK 50-PA/EZ-DR/HF/KS/ 900/YUC	2904746	1
	50	10 m	FLK 50-PA/EZ-DR/HF/KS/1000/YUC	2904637	1
	50	15 m	FLK 50-PA/EZ-DR/HF/KS/1500/YUC	2904638	1
	50	20 m	FLK 50-PA/EZ-DR/HF/KS/2000/YUC	2904487	1
	50	25 m	FLK 50-PA/EZ-DR/HF/KS/2500/YUC	2904639	1
	50	30 m	FLK 50-PA/EZ-DR/HF/KS/3000/YUC	2904640	1

#### 40-pos. YUC cables, for analog I/O modules

	40	1 m	FLK 40-PA/EZ-DR/KS/ 100/YUC	2322786	1
	40	2 m	FLK 40-PA/EZ-DR/KS/ 200/YUC	2314341	1
	40	3 m	FLK 40-PA/EZ-DR/KS/ 300/YUC	2314354	1
	40	4 m	FLK 40-PA/EZ-DR/KS/ 400/YUC	2314367	1
	40	5 m	FLK 40-PA/EZ-DR/KS/ 500/YUC	2321570	1
	40	6 m	FLK 40-PA/EZ-DR/KS/ 600/YUC	2314943	1
	40	7 m	FLK 40-PA/EZ-DR/KS/ 700/YUC	2321583	1
	40	8 m	FLK 40-PA/EZ-DR/KS/ 800/YUC	2314956	1
	40	9 m	FLK 40-PA/EZ-DR/KS/ 900/YUC	2321415	1
	40	10 m	FLK 40-PA/EZ-DR/KS/1000/YUC	2314370	1
	40	15 m	FLK 40-PA/EZ-DR/KS/1500/YUC	2314383	1
	40	20 m	FLK 40-PA/EZ-DR/KS/2000/YUC	2314532	1
	40	25 m	FLK 40-PA/EZ-DR/KS/2500/YUC	2314545	1
	40	30 m	FLK 40-PA/EZ-DR/KS/3000/YUC	2314558	1

	40	1 m	FLK 40-PA/EZ-DR/HF/KS/ 100/YUC	2904747	1
	40	2 m	FLK 40-PA/EZ-DR/HF/KS/ 200/YUC	2904748	1
	40	3 m	FLK 40-PA/EZ-DR/HF/KS/ 300/YUC	2904749	1
	40	4 m	FLK 40-PA/EZ-DR/HF/KS/ 400/YUC	2904750	1
	40	5 m	FLK 40-PA/EZ-DR/HF/KS/ 500/YUC	2904645	1
	40	6 m	FLK 40-PA/EZ-DR/HF/KS/ 600/YUC	2904751	1
	40	7 m	FLK 40-PA/EZ-DR/HF/KS/ 700/YUC	2904752	1
	40	8 m	FLK 40-PA/EZ-DR/HF/KS/ 800/YUC	2904753	1
	40	9 m	FLK 40-PA/EZ-DR/HF/KS/ 900/YUC	2904754	1
	40	10 m	FLK 40-PA/EZ-DR/HF/KS/1000/YUC	2904646	1
	40	15 m	FLK 40-PA/EZ-DR/HF/KS/1500/YUC	2904647	1
	40	20 m	FLK 40-PA/EZ-DR/HF/KS/2000/YUC	2904488	1
	40	25 m	FLK 40-PA/EZ-DR/HF/KS/2500/YUC	2904648	1
	40	30 m	FLK 40-PA/EZ-DR/HF/KS/3000/YUC	2904649	1

## YOKOGAWA Centum VP System cables

These system cables for digital I/O modules are connected directly to the modules. An intermediate adapter is not required. Features:

- Lateral cable outlet of the I/O module
- Four 14-pos. connectors on the module side for connection of four 8-channel VARIOFACE modules of the system cabling



Shielded

		Technical data
Max. perm. operating voltage		30 V DC
Max. perm. current carrying capacity per path		500 mA
Max. conductor resistance		0.16 Ω/m
Ambient temperature (operation)		-20 °C ... 50 °C
Conductor cross section		AWG 26 / 0.14 mm <sup>2</sup>
Outside diameter	50-position	11 mm

			Ordering data		
Description	No. of pos.	Cable length	Type	Order No.	Pcs. / Pkt.
<b>System cable</b> for digital I/O modules for coupling four 8-channel VARIOFACE modules					
	50	2 m	CABLE-50/4FLK14/ 2,0M/YUC	2314655	1
	50	4 m	CABLE-50/4FLK14/ 4,0M/YUC	2314671	1
	50	6 m	CABLE-50/4FLK14/ 6,0M/YUC	2318978	1
	50	10 m	CABLE-50/4FLK14/10,0M/YUC	2314684	1
	50	15 m	CABLE-50/4FLK14/15,0M/YUC	2322773	1
	50	20 m	CABLE-50/4FLK14/20,0M/YUC	2314778	1

## YOKOGAWA Centum VP System cables for MINI Analog system cabling

The Yokogawa system cable **CABLE-40/2FLK16/.../YUC** makes it possible to connect 16 MINI Analog modules to a Yokogawa control system. In conjunction with two MINI Analog system adapters MINI MCR-SL-V8-FLK-16-A, the Yokogawa system cable provides a simple and cost-effective Plug and Play solution.

The system cable is plugged directly into Yokogawa module. Two 16-pos. flat-ribbon cable connectors are provided for connecting the module to the MINI Analog system adapters.

The system cable in conjunction with **4-wire measuring transducers** is suitable for the following analog cards:

- AAI 141
- AAI 143



Shielded

		Technical data
Max. perm. operating voltage		30 V DC
Max. perm. current carrying capacity per path		500 mA
Max. conductor resistance		0.16 Ω/m
Ambient temperature (operation)		-20 °C ... 50 °C
Conductor cross section		AWG 26 / 0.14 mm <sup>2</sup>
Conductor structure: stranded wires / material		7 / Cu tin-plated
Outside diameter	40-position	11 mm

			Ordering data		
Description	No. of pos.	Cable length	Type	Order No.	Pcs. / Pkt.
<b>System cable</b> , for analog I/O modules for coupling two 8-channel MINI Analog system adapters					
	40	2 m	CABLE-40/2FLK16/ 2,0M/YUC	2321334	1
	40	4 m	CABLE-40/2FLK16/ 4,0M/YUC	2321347	1
	40	10 m	CABLE-40/2FLK16/10,0M/YUC	2321350	1
	40	15 m	CABLE-40/2FLK16/15,0M/YUC	2321376	1
	40	20 m	CABLE-40/2FLK16/20,0M/YUC	2321363	1

# System cabling for controllers

## Controller-specific system cabling

### YOKOGAWA Centum VP Interface modules

These modules are connected to the I/O modules via the YUC system cable (on page 534).

#### FLKM-KS40/YCS:

- For analog modules
  - Universal interface module with 40 connection terminal blocks
- For more cabling solutions for Yokogawa visit: [phoenixcontact.com](http://phoenixcontact.com)

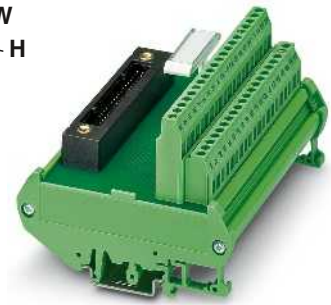

Passive interface modules

#### Technical data

Max. perm. operating voltage	< 25 V AC / 30 V DC
Max. perm. current (per branch)	1 A
Ambient temperature (operation)	-20 °C ... 50 °C
Mounting position	any
Standards/regulations	DIN EN 50178, IEC 60664, IEC 62103
Connection method	Screw connection
	Field level
	Controller level
Connection data solid / stranded / AWG	Yokogawa KS-compatible 0.2 ... 4 mm <sup>2</sup> / 0.2 ... 2.5 mm <sup>2</sup> / 24 - 12
Dimensions	90 mm / 68 mm

#### Ordering data

Description	No. of pos.	Module width W
<b>Controller board</b> , for analog I/O modules	40	112 mm

Type	Order No.	Pcs. / Pkt.
<b>FLKM-KS40/YCS</b>	<b>2314642</b>	1

### YOKOGAWA Centum VP Interface modules

These modules are connected to the I/O modules via the YUC system cable (on page 534).

#### FLKMS-KS50/32IM/YCS:

- For digital modules ADV 151 and ADV 551
  - Three-conductor connection (signal, plus, minus)
  - Redundant voltage supply (fuse IEC 127-2, 5 x 20, 2 A)
- For more cabling solutions for Yokogawa visit: [phoenixcontact.com](http://phoenixcontact.com)

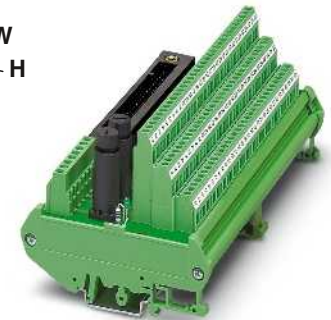

Passive interface modules

#### Technical data

Max. perm. operating voltage	30 V DC
Max. perm. current (per branch)	1 A
Ambient temperature (operation)	-20 °C ... 50 °C
Mounting position	any
Standards/regulations	DIN EN 50178, IEC 60664, IEC 62103
Connection method	Screw connection
	Field level
	Controller level
Connection data solid / stranded / AWG	Yokogawa KS-compatible 0.2 ... 4 mm <sup>2</sup> / 0.2 ... 2.5 mm <sup>2</sup> / 24 - 12
Dimensions	90 mm / 81 mm

#### Ordering data

Description	No. of pos.	Module width W
<b>Controller board</b> , for digital I/O modules ADV 151 and ADV 551	50	174 mm

Type	Order No.	Pcs. / Pkt.
<b>FLKMS-KS50/32IM/YCS</b>	<b>2314451</b>	1

## YOKOGAWA Centum VP Interface modules

These modules are connected to the analog I/O modules via the 40-pos. YUC system cable (on page 534).

The modules are designed for redundant signal transmission (two connectors parallel). A separate connection to the HART multiplexer is possible.

### FLKM-KS40/AO16/YCS

– For analog module AAI 543

### FLKMS-KS40/SI/AI16/YCS

– For analog modules AAI 141 and AAI 143 (operation of modules in 4-wire mode)

– Transfer of 16 channels with separate positive and negative connections

– 16 plug-in fuses (IEC 127-2, 5 x 20, 0.1 A) per positive supply and LED status indicator

– Redundant voltage supply (fuse IEC 127-2, 5 x 20, 2 A)

### FLKMS-KS40/AI/YCS

– For analog modules AAI 141 and AAI 143 (operation of modules in 4-wire mode)

– Transfer of 16 channels with separate positive and negative connections

– Redundant voltage supply (fuse IEC 127-2, 5 x 20, 2 A)

For more cabling solutions for Yokogawa visit: [phoenixcontact.com](http://phoenixcontact.com)



Interface modules for analog I/O modules

#### Technical data

Max. perm. operating voltage	30 V DC
Max. perm. current (per branch)	100 mA
Ambient temperature (operation)	-20 °C ... 50 °C
Mounting position	any
Standards/regulations	DIN EN 50178, IEC 60664, IEC 62103
Connection method	Field level Screw connection
Connection data solid / stranded / AWG	Controller level Yokogawa KS-compatible
Dimensions	0.2 ... 4 mm <sup>2</sup> / 0.2 ... 2.5 mm <sup>2</sup> / 24 - 12 126 mm / 68 mm

#### Ordering data

Description	No. of pos.	Module width W	Type	Order No.	Pcs. / Pkt.
<b>Controller board</b> , for analog output modules AAI 543	40	108 mm	FLKM-KS40/AO16/YCS	2314260	1
<b>Controller board</b> , with fuses and LED, for analog input modules AAI 141 and AAI 143	40	214 mm	FLKMS-KS40/SI/AI16/YCS	2314273	1
<b>Controller board</b> , for analog input modules AAI 141 and AAI 143, without fuses and LED	40	214 mm	FLKMS-KS40/AI/YCS	2314286	1

# System cabling for controllers

## Controller-specific system cabling

### Yokogawa ProSafe-RS Interface modules

These modules are connected to the I/O module via the 50-pos. YUC system cable (on page 534).

- For SDV144 digital module
- Redundant signal transmission (two parallel connectors)
- 16 channels

#### UM-2KS50/16DI/RS/MKDS

- Screw connection
- Redundant voltage supply with signaling relay and fuse (IEC 127-2, 5 x 20, 3,15 AT)
- LED status display per channel

#### UM-2KS50/DI16/RS/K-MT/SO241

- Screw connection with knife disconnection
- Redundant voltage supply with signaling relay and fuse (TR5, 2 AT)
- Plug-in fuses (TR5, 0,1 AT) and LED status indicator per channel

Max. perm. operating voltage	24 V DC ±5 %
Max. perm. current (per branch)	100 mA
Ambient temperature (operation)	-20 °C ... 70 °C
Mounting position	any
Standards/regulations	DIN EN 50178
Connection method	Screw connection
	Field level
	Controller level
Connection data solid / stranded / AWG	Yokogawa KS-compatible
Dimensions	0.2 ... 2.5 mm <sup>2</sup> / 0.2 ... 1.5 mm <sup>2</sup> / 24 - 14 112 mm / 80 mm



Passive interface modules

#### Technical data

#### Ordering data

Description	No. of pos.	Module width W
<b>Interface module</b> , for I/O card: SDV144		
- with LED status indicator	50	162 mm
- with fuse and LED status indicator	50	181 mm

Type	Order No.	Pcs. / Pkt.
<b>UM-2KS50/16DI/RS/MKDS</b>	2900173	1
<b>UM-2KS50/DI16/RS/K-MT/SO241</b>	2319618	1

### Yokogawa ProSafe-RS Interface modules

These modules are connected to the I/O modules via the 40-pos. YUC system cable (on page 534).

- Redundant signal transmission (two parallel connectors)

#### UM-2KS40/16AI/SI/RS/SO225

- For SAI143 analog module
- Screw connection
- Redundant voltage supply with signaling relay and fuse (IEC 127-2, 5 x 20, 10 AT)
- Plug-in fuses (IEC 127-2, 5 x 20, 1 AT) and LED status indicator per channel

#### UM-2KS40/16AIO/RS/SO225

- For SAI143, SAV144, SAI533 analog modules
- Screw connection
- 16 analog inputs or 8 analog outputs

Max. perm. operating voltage	30 V DC
Max. perm. current (per branch)	1 A
Ambient temperature (operation)	-20 °C ... 55 °C
Mounting position	any
Standards/regulations	DIN EN 50178
Connection method	Screw connection
	Field level
	Controller level
Connection data solid / stranded / AWG	Yokogawa KS-compatible
Dimensions	0.2 ... 4 mm <sup>2</sup> / 0.2 ... 2.5 mm <sup>2</sup> / 24 - 12 126 mm / 96 mm

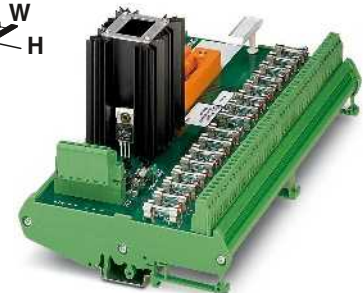

Passive interface modules

#### Technical data

#### Ordering data

Description	No. of pos.	Module width W
<b>Interface module</b> , for I/O card: SAI143		
	50	250 mm
<b>Interface module</b> , for I/O card: SAI143, SAV144, and SAI533		
	50	168 mm

Type	Order No.	Pcs. / Pkt.
<b>UM-2KS40/16AI/SI/RS/SO225</b>	2319841	1
<b>UM-2KS40/16AIO/RS/SO225</b>	2319838	1

## Yokogawa ProSafe-RS Interface modules

These modules are connected to the I/O modules via the 50-pos. YUC system cable (on page 534).

### UM-2KS50/8DO/RS/MKDS

- For SDV531 and SDV531L digital modules
- Redundant signal transmission (two parallel connectors)
- Screw terminal blocks
- Redundant voltage supply with signaling relay and fuse (IEC 127-2, 5 x 20, 3,15 AT)
- LED status display per channel

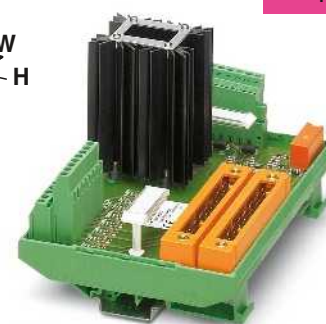

new

Passive interface modules

#### Technical data

Max. perm. operating voltage	24 V DC ±5 %
Max. perm. current (per branch)	100 mA
Ambient temperature (operation)	-20 °C ... 70 °C
Mounting position	any
Standards/regulations	DIN EN 50178
Connection method	Screw connection
	Field level
	Controller level
Connection data solid / stranded / AWG	Yokogawa KS-compatible 0.2 ... 2.5 mm <sup>2</sup> / 0.2 ... 1.5 mm <sup>2</sup> / 24 - 14
Dimensions	112 mm / 80 mm

#### Ordering data

Description	No. of pos.	Module width W	Type	Order No.	Pcs. / Pkt.
<b>Interface module</b> , for I/O card: SDV531 and SDV531L					
	50	162 mm	<b>UM-2KS50/ 8DO/RS/MKDS</b>	<b>2900174</b>	<b>1</b>

## Yokogawa ProSafe-RS Interface modules

These modules are connected to the I/O modules via the 50-pos. YUC system cable (on page 534).

- Redundant signal transmission (two parallel connectors)
- Redundant voltage supply with signaling relay and fuse (IEC 127-2, 5 x 20, 6,3 AT)
- For SDV541 digital modules

### UM-2KS50/DO16/RS/K-MT/SO241

- Screw connection with knife disconnection
- Plug-in fuses (TR5, 0,2 AT) and LED status indicator per channel

### UM-2KS50/16DO/RS/MKDS

- Screw connection
- LED status display per channel

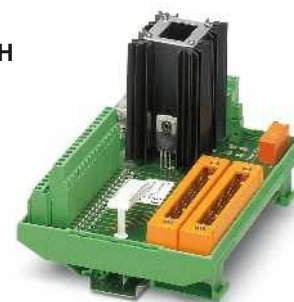

new

Passive interface modules

#### Technical data

Max. perm. operating voltage	24 V DC ±5 %
Max. perm. current (per branch)	100 mA
Ambient temperature (operation)	-20 °C ... 70 °C
Mounting position	any
Standards/regulations	DIN EN 50178
Connection method	Screw connection
	Field level
	Controller level
Connection data solid / stranded / AWG	Yokogawa KS-compatible 0.2 ... 2.5 mm <sup>2</sup> / 0.2 ... 1.5 mm <sup>2</sup> / 24 - 14
Dimensions	112 mm / 80 mm

#### Ordering data

Description	No. of pos.	Module width W	Type	Order No.	Pcs. / Pkt.
<b>Interface module</b> , for I/O card: SDV541					
- with LED status indicator	50	162 mm	<b>UM-2KS50/16DO/RS/MKDS</b>	<b>2900175</b>	<b>1</b>
- with fuse and LED status indicator	50	215 mm	<b>UM-2KS50/DO16/RS/K-MT/SO241</b>	<b>2319595</b>	<b>1</b>



# System cabling for controllers

## Controller-specific system cabling

### Termination Carriers for Yokogawa Centum VP and ProSafe-RS

The Termination Carriers are a compact solution for connecting signal conditioners and coupling relays to the Yokogawa Centum VP systems and ProSafe-RS.

- Mechanically decoupled PCB
- Redundant system connection
- Simple or redundant supply (diode decoupling, polarity reversal protection) and monitoring function. Implementation via separate DIN rail module or integrated switching on the PCB

### Termination Carrier for MINI Analog signal conditioners

#### TC-2KS40-AI16-M-PRH-CS

- For AAI141/AAI143 analog I/O modules

#### TC-2KS40-AO16-M-PRH-CS

- For AAI543 analog I/O module

### Termination Carrier for Ex i signal conditioners of the MACX Analog Ex series

#### TC-2KS50-DI32-2EX-PR-CS

- For ADV151/ADV161 digital I/O modules

#### TC-2KS50-DO32-EX-PR-CS

- For ADV551/ADV digital I/O modules

#### TC-2KS40-AO16-EX-PR-CS

- For AAI543 analog I/O module

#### TC-2KS40-AI16-EX-PR-CS

- For AAI141/AAI143 analog I/O modules

#### TC-2KS50-DO16-EX-PR-RS

- For SDV541 digital I/O module

#### TC-2KS50-DI16-EX-PR-RS

- For SDV144 digital I/O modules

#### TC-2KS40-AI16-EX-PR-RS

- For SAI143 analog I/O module

#### TC-2KS40-AO8-EX-PR-RS

- For SAI533 analog I/O module

### Termination Carrier for coupling relays from the PSR-ETP or PSR-FSP series

#### TC-2KS50-DO16-F&G-AR-RS

- For SDV541 digital I/O modules

#### TC-2KS50-DO16-ESD-AR-RS

- For SDV541 digital I/O modules



Termination Carrier for Centum VP system, can be used with signal conditioners of the MINI Analog series

General data	
Connection to the control system level	Yokogawa KS-compatible
Max. operating voltage	< 50 V DC (per signal/channel)
Max. permissible current	23 mA (signal/channel)
Pollution degree / surge voltage category	2 / II
Clearance and creepage distances	DIN EN 50178 (basic insulation)
Ambient temperature range	-20 °C ... 60 °C (please observe module specifications)
Shock	15g, according to IEC 60068-2-27
Vibration (operation)	2g, according to IEC 60068-2-6
Dimensions H / D	170 / 160 mm
EMC note	
Power supply via power module	
Input voltage range	19.2 V DC ... 30 V DC
Redundant supply	yes, decoupled from diodes
Polarization and surge protection	Yes
Fuse	2x 2.5 A on PCB, slow-blow (replaceable)
Status indication	2 x red LED (error) 2x green LEDs (PWR1 and PWR2) 1 N/C contact (alarm = open)

Technical data		
Yokogawa KS-compatible		
< 50 V DC (per signal/channel)		
23 mA (signal/channel)		
2 / II		
DIN EN 50178 (basic insulation)		
-20 °C ... 60 °C (please observe module specifications)		
15g, according to IEC 60068-2-27		
2g, according to IEC 60068-2-6		
170 / 160 mm		
19.2 V DC ... 30 V DC		
yes, decoupled from diodes		
Yes		
2x 2.5 A on PCB, slow-blow (replaceable)		
2 x red LED (error)		
2x green LEDs (PWR1 and PWR2)		
1 N/C contact (alarm = open)		

Switching output	
Description	Module width W
<b>Termination Carrier for 16 highly compact signal conditioners</b>	
- For AAI141 and AAI143 analog I/O modules	148 mm
- For AAI543 analog I/O modules	148 mm
<b>Termination Carrier for 16/32 Ex i signal conditioners (SIL 2)</b>	
- For ADV151 and ADV161 digital I/O modules	242 mm
- For ADV551 and ADV561 digital I/O modules	448 mm
- For AAI543 analog I/O module	242 mm
- For AAI141 and AAI143 analog I/O modules	242 mm
<b>Termination Carrier for 8/16 Ex i signal conditioners (SIL 2)</b>	
- For SDV144 digital I/O modules	242 mm
- For SDV541 digital I/O modules	242 mm
- For SAI143 analog I/O module	242 mm
- For SAI533 analog I/O module	148 mm
<b>Termination Carrier for 16 PSR-FSP/PSR-ETP relays</b>	
- For SDV541 digital I/O modules (low-demand application)	304 mm
- For SDV541 digital I/O module (high-demand application)	304 mm

Ordering data		
Type	Order No.	Pcs. / Pkt.
TC-2KS40-AI16-M-PRH-CS	2905257	1
TC-2KS40-AO16-M-PRH-CS	2905905	1

<b>MINI Analog power terminal</b>
<b>MINI Analog fault signaling module</b>
<b>Power and fault signaling module</b>
<b>Cable set</b> with 24 V module supply, suitable for PSR-ETP/Order No.: 2986711
<b>Cable set</b> without use of confirmation contact, suitable for PSR-FSP/Order No.: 2981978
<b>Cable set</b> with use of confirmation contact, suitable for PSR-FSP/Order No.: 2986960 and 2986575
<b>Jumper plug</b> for occupying unused module slots, suitable for PSR-FSP/Order No.: 2986960 and 2986575

Accessories		
Type	Order No.	Pcs. / Pkt.
MINI MCR-SL-PTB-FM	2902958	1
MINI MCR-SL-FM-RC-NC	2902961	1



new



Termination Carrier for Centum VP System, can be used with Ex i signal conditioners of the MACX Analog Ex series

new



Termination Carrier for ProSafe-RS system, can be used with Ex i signal conditioners of the MACX Analog Ex series

new



Termination Carrier for ProSafe-RS system, can be used with coupling relays from the PSR-ETP or PSR-FSP series

Technical data
Yokogawa KS-compatible < 50 V DC (per signal/channel) 1 A (signal/channel) 2 / II DIN EN 50178 (basic insulation) -20 °C ... 60 °C (please observe module specifications)
15g, according to IEC 60068-2-27 2g, according to IEC 60068-2-6 170 / 160 mm
19.2 V DC ... 30 V DC yes, decoupled from diodes Yes 2x 2.5 A on PCB, slow-blow (replaceable)
1 x red LED (error) 2x green LEDs (PWR1 and PWR2) 1 N/C contact (alarm = open)

Technical data
Yokogawa KS-compatible < 50 V DC (per signal/channel) 1 A (signal/channel) 2 / II DIN EN 50178 (basic insulation) -20 °C ... 60 °C (please observe module specifications)
15g, according to IEC 60068-2-27 2g, according to IEC 60068-2-6 170 / 160 mm
19.2 V DC ... 30 V DC yes, decoupled from diodes Yes 2x 2.5 A on PCB, slow-blow (replaceable)
1 x red LED (error) 2x green LEDs (PWR1 and PWR2) 1 N/C contact (alarm = open)

Technical data
Yokogawa KS-compatible 24 V DC (21.1 V ... 26.4 V) 1200 mA 2 / II DIN EN 50178 (basic insulation) -20 °C ... 60 °C
15g, according to IEC 60068-2-27 2g, according to IEC 60068-2-6 170 / 160 mm Class A product, see page 625
21.1 V DC ... 26.4 V DC yes, decoupled from diodes Yes 2.5 A on PCB, slow-blow (replaceable)
2 x red LED (error) 2x green LEDs (PWR1 and PWR2) 1 N/C contact (alarm = open)

Ordering data		
Type	Order No.	Pcs. / Pkt.
TC-2KS50-DI32-2EX-PR-CS	2904676	1
TC-2KS50-DO32-EX-PR-CS	2905199	1
TC-2KS40-AO16-EX-PR-CS	2905201	1
TC-2KS40-AI16-EX-PR-CS	2905677	1
TC-2KS50-DI16-EX-PR-RS	2905202	1
TC-2KS50-DO16-EX-PR-RS	2905678	1
TC-2KS40-AI16-EX-PR-RS	2905203	1
TC-2KS40-AO8-EX-PR-RS	2905204	1
TC-2KS50-DO16-F&G-AR-RS	2904112	1
TC-2KS50-DO16-ESD-AR-RS	2904113	1

Ordering data		
Type	Order No.	Pcs. / Pkt.
TC-2KS50-DI16-EX-PR-RS	2905202	1
TC-2KS50-DO16-EX-PR-RS	2905678	1
TC-2KS40-AI16-EX-PR-RS	2905203	1
TC-2KS40-AO8-EX-PR-RS	2905204	1
TC-2KS50-DO16-F&G-AR-RS	2904112	1
TC-2KS50-DO16-ESD-AR-RS	2904113	1

Ordering data		
Type	Order No.	Pcs. / Pkt.
TC-2KS50-DO16-F&G-AR-RS	2904112	1
TC-2KS50-DO16-ESD-AR-RS	2904113	1

Accessories		
Type	Order No.	Pcs. / Pkt.
TC-MACX-MCR-PTB	2904673	1

Accessories		
Type	Order No.	Pcs. / Pkt.
TC-MACX-MCR-PTB	2904673	1

Accessories		
Type	Order No.	Pcs. / Pkt.
TC-C-PSR3-SC-A100V+A20000	2903391	16
TC-C-PSR3-SC-A1000A20000	2903389	16
TC-C-PSR3-SC-A1000A23132	2903390	16
TC-C-PTSM-50-00000000J1J1	2903388	8

# System cabling for controllers

## Controller-specific system cabling

### VIP termination boards for 8 channels

These VIP - VARIOFACE Professional modules are used in combination with 14-pos. system cables and the relevant front adapters.

#### Features:

- Byte-by-byte marking
- For digital I/O modules
- With LED as an option

**Notes:**  
For marking systems (e.g., "ZB 22:UNBEDRUCKT"; Order No. 0811862) and mounting material, see Catalog 5.



Passive interface modules for input/output with screw connection



Passive interface modules for input/output with push-in connection



Max. perm. operating voltage	
Max. perm. current (per branch)	
Max total current (voltage supply)	
Ambient temperature (operation)	
Mounting position	
Standards/regulations	
Connection method	Field level
	Controller level
Connection data solid / stranded / AWG	
Dimensions	H / D

Technical data	
VIP-2/.../FLK14/PLC	VIP-2/.../FLK14/LED/PLC
60 V AC/DC	24 V DC
1 A	1 A
3 A	3 A
-20 °C ... 50 °C	-20 °C ... 50 °C
any	any
IEC 60664, DIN EN 50178, IEC 62103	IEC 60664, DIN EN 50178, IEC 62103
Screw connection	Screw connection
IDC/FLK pin strip (2.54 mm)	IDC/FLK pin strip (2.54 mm)
0.2 ... 4 mm <sup>2</sup> / 0.2 ... 2.5 mm <sup>2</sup> / 24 - 12	
65.5 mm / 56 mm	

Technical data	
VIP-2/.../FLK14/PLC	VIP-2/.../FLK14/LED/PLC
60 V AC/DC	24 V DC
1 A	1 A
3 A	3 A
-20 °C ... 50 °C	-20 °C ... 50 °C
any	any
IEC 60664, DIN EN 50178, IEC 62103	IEC 60664, DIN EN 50178, IEC 62103
Push-in connection	Push-in connection
IDC/FLK pin strip (2.54 mm)	IDC/FLK pin strip (2.54 mm)
0.14 ... 2.5 mm <sup>2</sup> / 0.14 ... 2.5 mm <sup>2</sup> / 26 - 14	
72.1 mm / 56 mm	

Description	No. of pos.	Module width W
<b>VARIOFACE interface module</b> , for eight channels,		
- with screw connection	14	39.8 mm
- with push-in connection	14	41.9 mm
<b>VARIOFACE interface module</b> , for eight channels with light indicator,		
- with screw connection	14	39.8 mm
- with push-in connection	14	41.9 mm

Ordering data		
Type	Order No.	Pcs. / Pkt.
VIP-2/SC/FLK14/PLC	2315214	1
VIP-2/SC/FLK14/LED/PLC	2322249	1

Ordering data		
Type	Order No.	Pcs. / Pkt.
VIP-2/PT/FLK14/PLC	2903801	1
VIP-2/PT/FLK14/LED/PLC	2904279	1

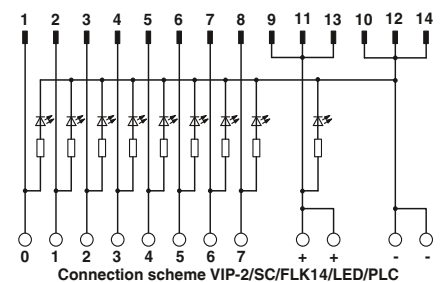
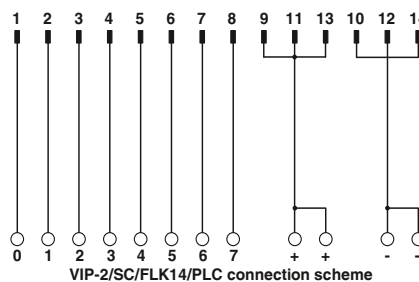

### VIP termination boards for 32 channels

These VIP - VARIOFACE Professional modules are used in combination with 50-pos. system cables and the relevant front adapters.

#### Features:

- Byte-by-byte marking
- For digital I/O modules
- With LED as an option

**Notes:**  
For marking systems (e.g., "ZB 22:UNBEDRUCKT"; Order No. 0811862) and mounting material, see Catalog 5.

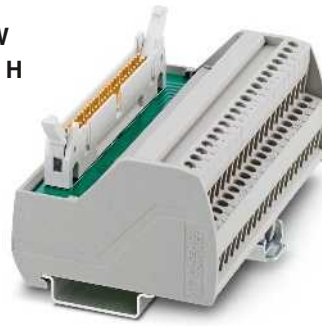

Passive interface modules for input/output with screw connection



#### Technical data

VIP-2/.../FLK50/PLC	VIP-2/.../FLK50/LED/PLC
60 V AC/DC	24 V DC
1 A	1 A
2 A (per byte)	2 A (per byte)
-20 °C ... 50 °C	-20 °C ... 50 °C
any	any
IEC 60664, DIN EN 50178, IEC 62103	IEC 60664, DIN EN 50178, IEC 62103
Screw connection	Screw connection
Field level	Field level
Controller level	Controller level
IDC/FLK pin strip (2.54 mm)	IDC/FLK pin strip (2.54 mm)

Max. perm. operating voltage	
Max. perm. current (per branch)	
Max total current (voltage supply)	
Ambient temperature (operation)	
Mounting position	
Standards/regulations	
Connection method	
Connection data solid / stranded / AWG	
Dimensions	H / D

#### Ordering data

Type	Order No.	Pcs. / Pkt.
VIP-2/SC/FLK50/PLC	2315227	1
VIP-2/SC/FLK50/LED/PLC	2322252	1

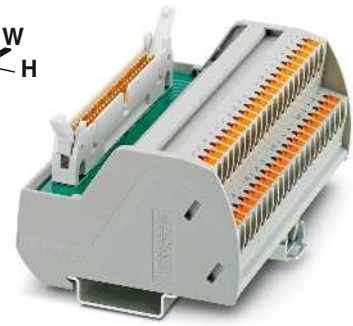

Passive interface modules for input/output with push-in connection



#### Technical data

VIP-2/.../FLK50/PLC	VIP-2/.../FLK50/LED/PLC
60 V AC/DC	24 V DC
1 A	1 A
2 A (per byte)	2 A (per byte)
-20 °C ... 50 °C	-20 °C ... 50 °C
any	any
IEC 60664, DIN EN 50178, IEC 62103	IEC 60664, DIN EN 50178, IEC 62103
Push-in connection	Push-in connection
Field level	Field level
Controller level	Controller level
IDC/FLK pin strip (2.54 mm)	IDC/FLK pin strip (2.54 mm)

Connection data solid / stranded / AWG	
Dimensions	H / D

#### Ordering data

Type	Order No.	Pcs. / Pkt.
VIP-2/PT/FLK50/PLC	2903803	1
VIP-2/PT/FLK50/LED/PLC	2904280	1

Description	No. of pos.	Module width W
<b>VARIOFACE interface module</b> , for 32 channels,		
- with screw connection	50	106.1 mm
- with push-in connection	50	107.9 mm
<b>VARIOFACE interface module</b> , for 32 channels with light indicator,		
- with screw connection	50	106.1 mm
- with push-in connection	50	107.9 mm

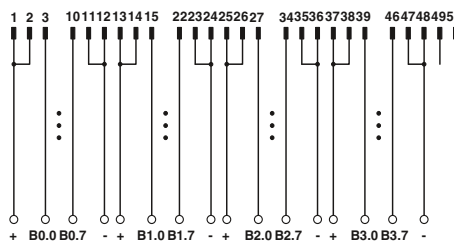

VIP-2/SC/FLK50/PLC connection scheme

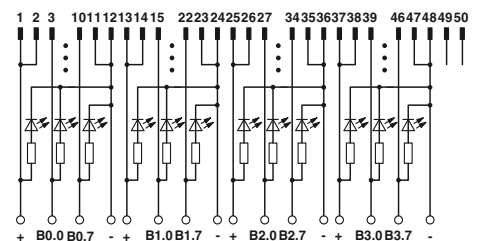

Connection scheme VIP-2/SC/FLK50/LED/PLC

# System cabling for controllers

## Controller-specific system cabling

### VIP termination boards for SIMATIC® S7

These VIP - VARIOFACE Professional modules are used in combination with 50-pos. system cables and the relevant front adapters for SIMATIC® S7.

#### Features:

- Numerical marking
- Specifically for S7-300 or S7-400

**Notes:**  
For marking systems (e.g., "ZB 22:UNBEDRUCKT"; Order No. 0811862) and mounting material, see Catalog 5.

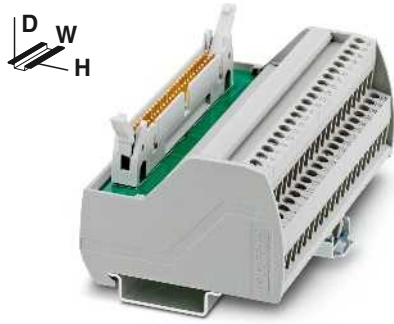

Passive interface modules for input/output, with SIMATIC®-specific marking and screw connection

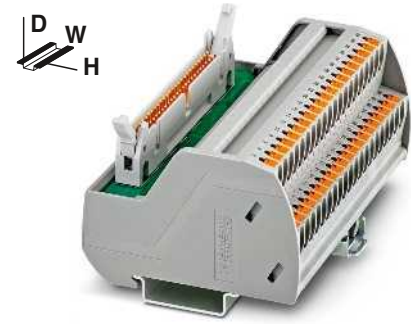

Passive interface modules for input/output, with SIMATIC®-specific marking and push-in connection



#### Technical data

Max. perm. operating voltage	60 V AC/DC
Max. perm. current (per branch)	1 A
Ambient temperature (operation)	-20 °C ... 50 °C
Mounting position	any
Standards/regulations	IEC 60664, DIN EN 50178, IEC 62103
Connection method	Screw connection
	Field level
	Controller level
Connection data solid / stranded / AWG	IDC/FLK pin strip (2.54 mm) 0.2 ... 4 mm <sup>2</sup> / 0.2 ... 2.5 mm <sup>2</sup> / 24 - 12
Dimensions	65.5 mm / 56 mm

#### Technical data

Max. perm. operating voltage	60 V AC/DC
Max. perm. current (per branch)	1 A
Ambient temperature (operation)	-20 °C ... 50 °C
Mounting position	any
Standards/regulations	IEC 60664, DIN EN 50178, IEC 62103
Connection method	Push-in connection
	Field level
	Controller level
Connection data solid / stranded / AWG	IDC/FLK pin strip (2.54 mm) 0.14 ... 2.5 mm <sup>2</sup> / 0.14 ... 2.5 mm <sup>2</sup> / 26 - 14
Dimensions	72.1 mm / 56 mm

#### Ordering data

Description	No. of pos.	Module width W
<b>VARIOFACE interface module, with SIMATIC® S7-300-specific marking from 1 to 40</b>		
- with screw connection	50	106.1 mm
- with push-in connection	50	107.9 mm
<b>VARIOFACE interface module, with SIMATIC® S7-400-specific marking from 3 to 48</b>		
- with screw connection	50	106.1 mm
- with push-in connection	50	107.9 mm

Type	Order No.	Pcs. / Pkt.
VIP-2/SC/FLK50 (1-40) /S7	2315243	1
VIP-2/SC/FLK50/S7/A-S400	2322359	1

#### Ordering data

Type	Order No.	Pcs. / Pkt.
VIP-2/PT/FLK50 (1-40) /S7	2903804	1
VIP-2/PT/FLK50/S7/A-S400	2904289	1

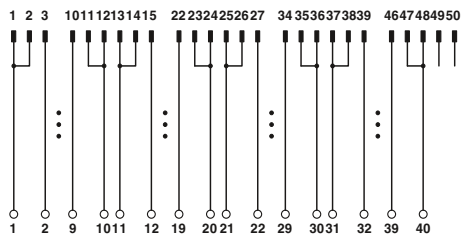

Connection scheme VIP-2/.../FLK50 (1-40) /S7

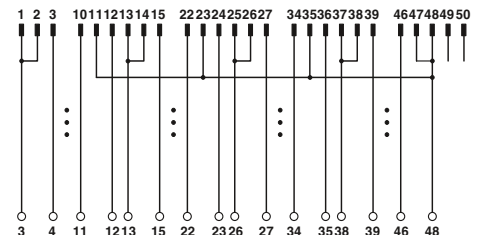

Connection scheme VIP-2/.../FLK50/S7/A-S400

### VIP termination boards for MODICON® TSX Quantum and Allen Bradley ControlLogix

These VIP - VARIOFACE Professional modules are used in combination with 50-pos. system cables and the relevant front adapters.

#### Features:

- Specific marking
- Specifically for MODICON TSX Quantum or ControlLogix

#### Notes:

For marking systems (e.g., "ZB 22:UNBEDRUCKT"; Order No. 0811862) and mounting material, see Catalog 5.

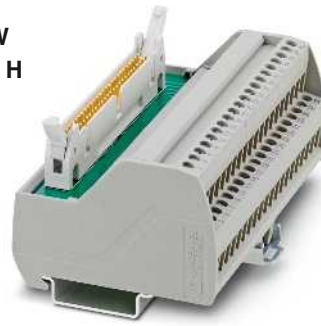

Passive interface modules for input/output, with specific marking and screw connection

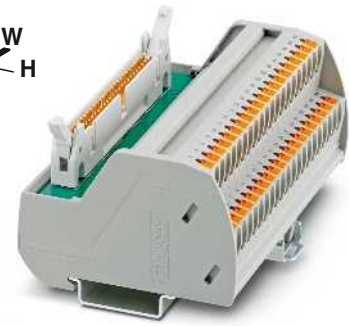

Passive interface modules for input/output, with specific marking and push-in connection



#### Technical data

Max. perm. operating voltage	60 V AC/DC
Max. perm. current (per branch)	1 A
Ambient temperature (operation)	-20 °C ... 50 °C
Mounting position	any
Standards/regulations	IEC 60664, DIN EN 50178, IEC 62103
Connection method	Screw connection
	Field level
	Controller level
Connection data solid / stranded / AWG	IDC/FLK pin strip (2.54 mm) 0.2 ... 4 mm <sup>2</sup> / 0.2 ... 2.5 mm <sup>2</sup> / 24 - 12
Dimensions	H / D 65.5 mm / 56 mm

#### Technical data

Max. perm. operating voltage	60 V AC/DC
Max. perm. current (per branch)	1 A
Ambient temperature (operation)	-20 °C ... 50 °C
Mounting position	any
Standards/regulations	IEC 60664, DIN EN 50178, IEC 62103
Connection method	Push-in connection
Connection data solid / stranded / AWG	IDC/FLK pin strip (2.54 mm) 0.14 ... 2.5 mm <sup>2</sup> / 0.14 ... 2.5 mm <sup>2</sup> / 26 - 14
Dimensions	H / D 72.1 mm / 56 mm

#### Ordering data

Type	Order No.	Pcs. / Pkt.
VIP-2/SC/FLK50/MODI-TSX/Q	2322304	1
VIP-2/SC/FLK50/AB-1756	2322317	1

#### Ordering data

Type	Order No.	Pcs. / Pkt.
VIP-2/PT/FLK50/MODI-TSX/Q	2904285	1
VIP-2/PT/FLK50/AB-1756	2904286	1

Description	No. of pos.	Module width W
<b>VARIOFACE interface module</b> , with MODICON® TSX Quantum-specific marking from 1 to 40		
- with screw connection	50	106.1 mm
- with push-in connection	50	107.9 mm
<b>VARIOFACE interface module</b> , with ControlLogix-specific marking from 1 to 36		
- with screw connection	50	95.9 mm
- with push-in connection	50	97.7 mm

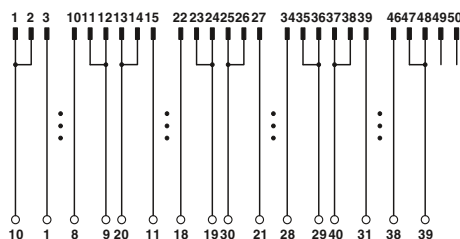

Connection scheme VIP-2/.../FLK50/MODI-TSX/Q

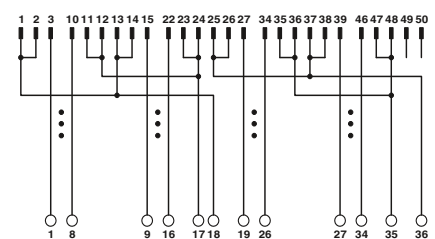

Connection scheme VIP-2/.../FLK50/AB-1756

# System cabling for controllers

## Controller-specific system cabling

### VIP termination boards for Siemens SIMATIC® S7-300

These VIP - VARIOFACE Professional modules are used in combination with two 14-pos. system cables and the relevant front adapters for Siemens SIMATIC® S7-300.

#### Features:

- Numerical marking (1-20)
- Specifically for S7-300

**Notes:**  
For marking systems (e.g., "ZB 22:UNBEDRUCKT"; Order No. 0811862) and mounting material, see Catalog 5.

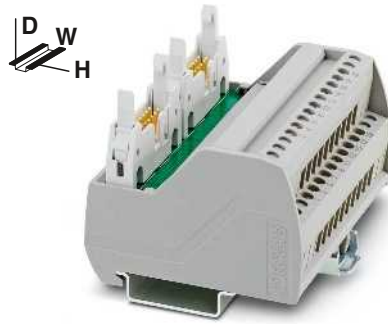

**Passive interface modules for SIMATIC® S7-300 with screw connection**

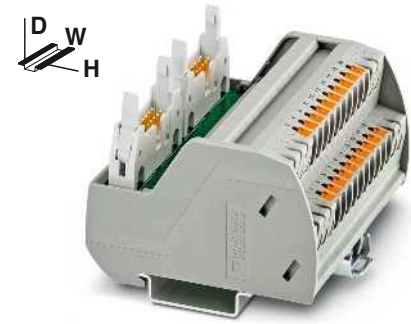

**Passive interface modules for SIMATIC® S7-300 with push-in connection**



#### Technical data

Max. perm. operating voltage	60 V AC/DC
Max. perm. current (per branch)	1 A
Ambient temperature (operation)	-20 °C ... 50 °C
Mounting position	any
Standards/regulations	IEC 60664, DIN EN 50178, IEC 62103
Connection method	Screw connection
	Field level
	Controller level
Connection data solid / stranded / AWG	IDC/FLK pin strip (2.54 mm) 0.2 ... 4 mm <sup>2</sup> / 0.2 ... 2.5 mm <sup>2</sup> / 24 - 12
Dimensions	H / D 65.5 mm / 56 mm

#### Technical data

Max. perm. operating voltage	60 V AC/DC
Max. perm. current (per branch)	1 A
Ambient temperature (operation)	-20 °C ... 50 °C
Mounting position	any
Standards/regulations	IEC 60664, DIN EN 50178, IEC 62103
Connection method	Push-in connection
	Field level
	Controller level
Connection data solid / stranded / AWG	IDC/FLK pin strip (2.54 mm) 0.14 ... 2.5 mm <sup>2</sup> / 0.14 ... 2.5 mm <sup>2</sup> / 26 - 14
Dimensions	H / D 72.1 mm / 56 mm

#### Ordering data

Description	No. of pos.	Module width W
<b>VARIOFACE interface module</b> , with SIMATIC® S7-300-specific marking from 1 to 20		
- with screw connection	14	80.6 mm
- with push-in connection	14	82.5 mm

Type	Order No.	Pcs. / Pkt.
VIP-2/SC/2FLK14 (1-20) /S7	2315230	1

#### Ordering data

Type	Order No.	Pcs. / Pkt.
VIP-2/PT/2FLK14 (1-20) /S7	2903802	1

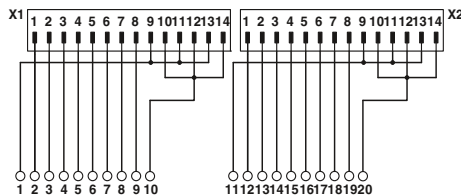

Connection diagram: VIP-2/.../2FLK14 (1-20) /S7

**VIP termination boards for Allen Bradley**

These VIP - VARIOFACE Professional modules are used in combination with two 14-pos. system cables and the relevant front adapters for Allen Bradley.

**Features:**

- Numerical marking (1-20)
- Specifically for ControlLogix

**Notes:**  
For marking systems (e.g., "ZB 22:UNBEDRUCKT"; Order No. 0811862) and mounting material, see Catalog 5.

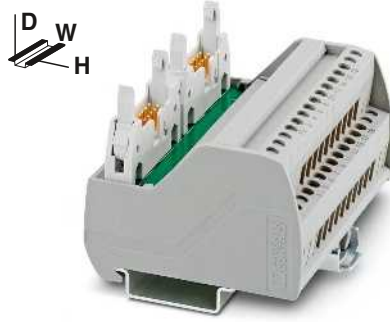

**Passive interface modules for Allen Bradley ControlLogix with screw connection**

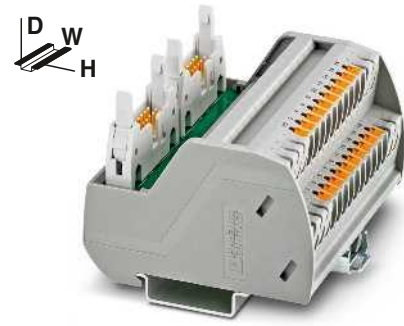

**Passive interface modules for Allen Bradley ControlLogix with push-in connection**



**Technical data**

Max. perm. operating voltage	60 V AC/DC
Max. perm. current (per branch)	1 A
Ambient temperature (operation)	-20 °C ... 50 °C
Mounting position	any
Standards/regulations	IEC 60664, DIN EN 50178, IEC 62103
Connection method	Screw connection
	Field level
	Controller level
Connection data solid / stranded / AWG	IDC/FLK pin strip (2.54 mm) 0.2 ... 4 mm <sup>2</sup> / 0.2 ... 2.5 mm <sup>2</sup> / 24 - 12
Dimensions	H / D 65.5 mm / 56 mm

**Technical data**

Max. perm. operating voltage	60 V AC/DC
Max. perm. current (per branch)	1 A
Ambient temperature (operation)	-20 °C ... 50 °C
Mounting position	any
Standards/regulations	IEC 60664, DIN EN 50178, IEC 62103
Connection method	Push-in connection
Connection data solid / stranded / AWG	IDC/FLK pin strip (2.54 mm) 0.2 ... 4 mm <sup>2</sup> / 0.2 ... 2.5 mm <sup>2</sup> / 24 - 12
Dimensions	H / D 72.1 mm / 56 mm

**Ordering data**

Description	No. of pos.	Module width W
<b>VARIOFACE interface module, with ControlLogix-specific marking from 1 to 20</b>		
- with screw connection	14	80.6 mm
- with push-in connection	14	82.5 mm

Type	Order No.	Pcs. / Pkt.
VIP-2/SC/2FLK14/AB-1756	2322333	1

**Ordering data**

Type	Order No.	Pcs. / Pkt.
VIP-2/PT/2FLK14/AB-1756	2904288	1

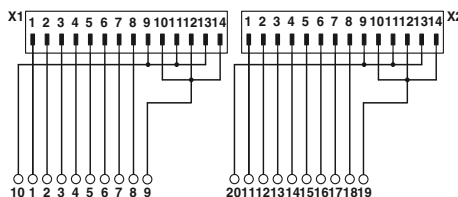

Connection scheme VIP-2.../2FLK14/AB-1756



# System cabling for controllers

## Controller-specific system cabling

### VIP termination boards in 2-conductor connection technology for 8 channels

These VIP VARIOFACE modules are used in combination with 14-pos. system cables and the relevant front adapters.

#### Features:

- Byte-by-byte marking
- For digital I/O modules
- Negative or positive connection per signal

**Notes:**  
For marking systems (e.g., "ZB 22:UNBEDRUCKT"; Order No. 0811862) and mounting material, see Catalog 5.



Passive interface modules with screw connection



Passive interface modules with push-in connection



Max. perm. operating voltage	
Max. perm. current (per branch)	
Max total current (voltage supply)	
Ambient temperature (operation)	
Mounting position	
Standards/regulations	
Connection method	Field level
	Controller level
Connection data solid / stranded / AWG	
Dimensions	H / D

Technical data	
60 V DC	
1 A	
3 A (per byte)	
-20 °C ... 50 °C	
any	
IEC 60664, DIN EN 50178, IEC 62103	
Screw connection	
IDC/FLK pin strip (2.54 mm)	
0.2 ... 4 mm <sup>2</sup> / 0.2 ... 2.5 mm <sup>2</sup> / 24 - 12	
65.5 mm / 56 mm	

Technical data	
60 V AC/DC	
1 A	
3 A (per byte)	
-20 °C ... 50 °C	
any	
IEC 60664, DIN EN 50178, IEC 62103	
Push-in connection	
IDC/FLK pin strip (2.54 mm)	
0.14 ... 2.5 mm <sup>2</sup> / 0.14 ... 2.5 mm <sup>2</sup> / 26 - 14	
72.1 mm / 56 mm	

Description	No. of pos.	Module width W
<b>VARIOFACE interface module</b> , for eight channels, each with an additional terminal block per signal for a common minus potential		
- with screw connection	14	50 mm
- with push-in connection	14	52 mm
<b>VARIOFACE interface module</b> , for eight channels, each with an additional terminal block per signal for a common plus potential		
- with screw connection	14	50 mm
- with push-in connection	14	52 mm

Ordering data		
Type	Order No.	Pcs. / Pkt.
VIP-2/SC/FLK14/8M/PLC	2322281	1
VIP-2/SC/FLK14/8P/PLC	2322294	1

Ordering data		
Type	Order No.	Pcs. / Pkt.
VIP-2/PT/FLK14/8M/PLC	2904283	1
VIP-2/PT/FLK14/8P/PLC	2904284	1

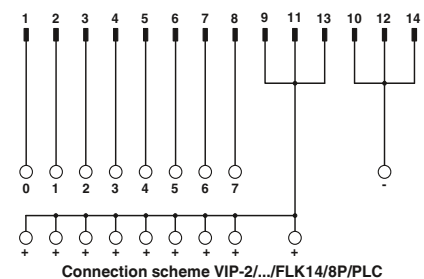
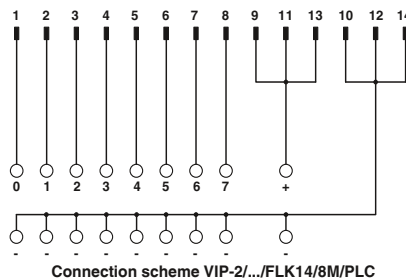

### Termination boards in 2-conductor connection technology for 32 channels

These VARIOFACE modules are used in combination with 50-pos. system cables and the relevant front adapters.

The following module types with 2-conductor connection technology are available:

#### FLKM 50/32M/PLC

- Byte-by-byte marking
- For digital I/O modules
- Negative connection per signal

#### FLKM 50/32P/PLC

- Byte-by-byte marking
- For digital I/O modules
- Positive connection per signal

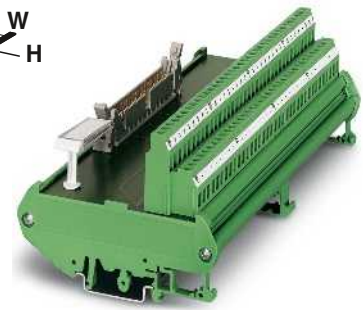

Passive interface modules with screw connection



#### Technical data

Max. perm. operating voltage	60 V DC
Max. perm. current (per branch)	1 A
Max total current (voltage supply)	8 A (per byte)
Ambient temperature (operation)	-20 °C ... 50 °C
Mounting position	any
Standards/regulations	DIN EN 50178, IEC 60664, IEC 62103
Connection method	Screw connection
	Field level
	Controller level
Connection data solid / stranded / AWG	IDC/FLK pin strip (2.54 mm) 0.2 ... 4 mm <sup>2</sup> / 0.2 ... 2.5 mm <sup>2</sup> / 24 - 12
Dimensions	90 mm / 68 mm

#### Ordering data

Description	No. of pos.	Module width W	Type	Order No.	Pcs. / Pkt.
<b>VARIOFACE interface module</b> , for 32 channels, each with an additional terminal block per signal for a common minus potential	50	192 mm	<b>FLKM 50/32M/PLC</b>	<b>2289719</b>	<b>1</b>
<b>VARIOFACE interface module</b> , for 32 channels, each with an additional terminal block per signal for a common plus potential	50	192 mm	<b>FLKM 50/32P/PLC</b>	<b>2291121</b>	<b>1</b>

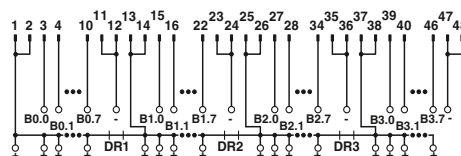

Connection scheme: FLKM 50/32P/PLC

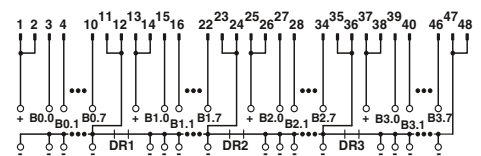

Connection scheme: FLKM 50/32M/PLC

# System cabling for controllers

## Controller-specific system cabling

### Termination boards with fuses in 2-conductor connection technology

These VARIOFACE modules are used in combination with 14 or 50-pos. system cables and the relevant front adapters.

The following module types with fuses and 2-conductor connection technology are available:

#### FLKM 14/8M/SI/PLC (for 8 channels) FLKM 50/32M/SI/PLC (for 32 channels)

- Byte-by-byte marking
- Can be used for digital I/O modules
- Plug-in fuse (IEC 127-3, 1AF) per signal path (F1)
- Plug-in fuse (IEC 127-3, 2AF) per voltage supply (F2)
- Negative connection per signal.

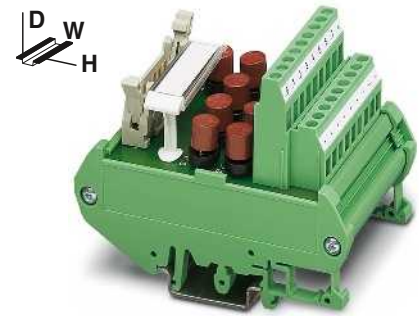

Passive fuse modules for 8 or 32 channels



#### Technical data

FLKM 14/8M/SI/PLC	FLKM 50/32M/SI/PLC
60 V DC	60 V DC
1 A	1 A
2 A	2 A (per byte)
-20 °C ... 50 °C	-20 °C ... 50 °C
any	any
DIN EN 50178, IEC 60664, IEC 62103	
Field level	Screw connection
Controller level	IDC/FLK pin strip (2.54 mm)

Max. perm. operating voltage	
Max. perm. current (per branch)	
Max total current (voltage supply)	
Ambient temperature (operation)	
Mounting position	
Standards/regulations	
Connection method	Field level

Connection data solid / stranded / AWG	0.2 ... 4 mm <sup>2</sup> / 0.2 ... 2.5 mm <sup>2</sup> / 24 - 12
Dimensions	H / D 90 mm / 68 mm

#### Ordering data

Description	No. of pos.	Module width W	Type	Order No.	Pcs. / Pkt.
<b>VARIOFACE module</b> , for eight channels, each with an additional terminal block and fuse per signal, (common minus potential)	14	57 mm	<b>FLKM 14/8M/SI/PLC</b>	2294487	1
<b>VARIOFACE module</b> , for 32 channels, each with an additional terminal block and fuse per signal, (common minus potential)	50	192 mm	<b>FLKM 50/32M/SI/PLC</b>	2294490	1

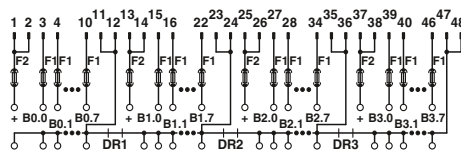

Connection scheme: FLKM 50/32M/SI/PLC

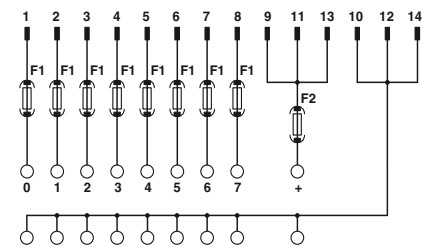

Connection scheme: FLKM 14/8M/SI/PLC

### VIP initiator modules for 8 channels

These VIP - VARIOFACE Professional modules are used in combination with 14-pos. system cables and the relevant front adapters.

#### Features:

- Byte-by-byte marking
- For digital I/O modules
- Positive and negative connection per signal
- With LED as an option

**Notes:**  
For marking systems (e.g., "ZB 22:UNBEDRUCKT"; Order No. 0811862) and mounting material, see Catalog 5.

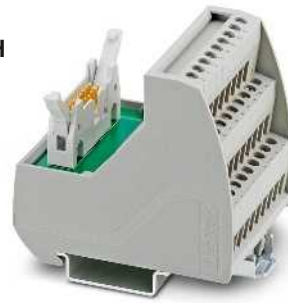

Initiator modules with screw connection

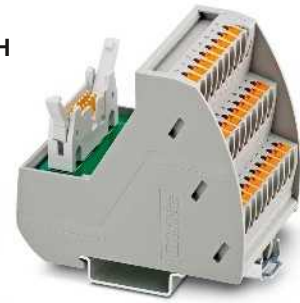

Initiator modules with push-in connection



Max. perm. operating voltage	
Max. perm. current (per branch)	
Max total current (voltage supply)	
Ambient temperature (operation)	
Mounting position	
Standards/regulations	
Connection method	Field level
	Controller level
Connection data solid / stranded / AWG	
Dimensions	H / D

Technical data	
VIP-3/SC/FLK14/8IM/PLC	VIP-3/SC/FLK14/8IM/LED/PLC
60 V DC	24 V DC
1 A	1 A
3 A	3 A
-20 °C ... 50 °C	-20 °C ... 50 °C
any	any
IEC 60664, DIN EN 50178, IEC 62103	IEC 60664, DIN EN 50178, IEC 62103
Screw connection	Screw connection
IDC/FLK pin strip (2.54 mm)	IDC/FLK pin strip (2.54 mm)
0.2 ... 4 mm <sup>2</sup> / 0.2 ... 2.5 mm <sup>2</sup> / 24 - 12	
69 mm / 62 mm	

Technical data	
VIP-3/PT/FLK14/8IM/PLC	VIP-3/PT/FLK14/8IM/LED/PLC
60 V AC/DC	24 V DC
1 A	1 A
3 A	3 A
-20 °C ... 50 °C	-20 °C ... 50 °C
any	any
IEC 60664, DIN EN 50178, IEC 62103	IEC 60664, DIN EN 50178, IEC 62103
Push-in connection	Push-in connection
IDC/FLK pin strip (2.54 mm)	IDC/FLK pin strip (2.54 mm)
0.14 ... 2.5 mm <sup>2</sup> / 0.14 ... 2.5 mm <sup>2</sup> / 26 - 14	
75.8 mm / 63 mm	

Description	No. of pos.	Module width W
<b>VARIOFACE initiator module</b> , for connecting 8 PNP initiators, with an additional positive and negative terminal block each per signal		
- with screw connection	14	52.3 mm
- with push-in connection	14	52 mm
<b>VARIOFACE initiator module with LED</b> , for connecting 8 PNP initiators, with an additional positive and negative terminal block each per signal		
- with screw connection	14	52.3 mm
- with push-in connection	14	52 mm

Ordering data		
Type	Order No.	Pcs. / Pkt.
VIP-3/SC/FLK14/8IM/PLC	2322278	1
VIP-3/SC/FLK14/8IM/LED/PLC	2322265	1

Ordering data		
Type	Order No.	Pcs. / Pkt.
VIP-3/PT/FLK14/8IM/PLC	2904282	1
VIP-3/PT/FLK14/8IM/LED/PLC	2904281	1

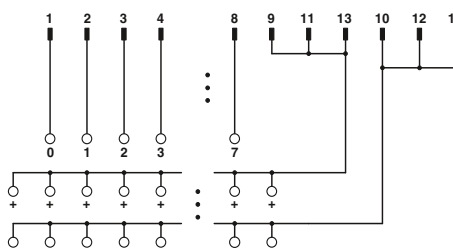

Connection scheme VIP-3/.../FLK14/8IM/PLC

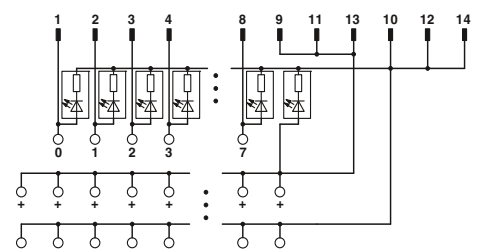

Connection scheme VIP-3/.../FLK14/8IM/LED/PLC

# System cabling for controllers

## Controller-specific system cabling

### Initiator modules for 32 channels

These VARIOFACE modules are used in combination with 50-pos. system cables and the relevant front adapters for digital I/O modules.

#### Features:

- Byte-by-byte marking
- Positive and negative connection per signal
- With LED as an option

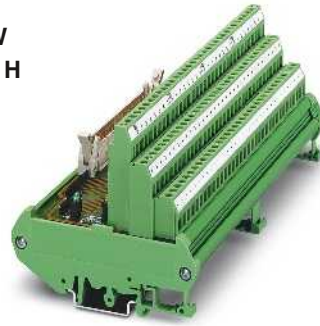

Initiator modules for 32 channels, with screw connection

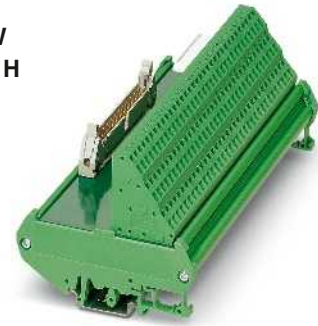

Initiator modules for 32 channels, with spring-cage connection



		Technical data		Technical data	
Max. perm. operating voltage		... 50/32 IM	... 50/32 IM/LA	60 V DC	60 V DC
Max. perm. current (per branch)		60 V DC	30 V DC	1 A	1 A
Max total current (voltage supply)		1 A	1 A	2 A (per byte)	2 A (per byte)
Status indication		2 A (per byte)	2 A (per byte)	-	-
Ambient temperature (operation)		-	LED	-20 °C ... 50 °C	-20 °C ... 50 °C
Mounting position		-20 °C ... 50 °C	-20 °C ... 50 °C	any	any
Standards/regulations		any	any	DIN EN 50178, IEC 60664, IEC 62103	DIN EN 50178, IEC 60664, IEC 62103
Connection method	Field level	Screw connection	Screw connection	Spring-cage connection	Spring-cage connection
	Controller level	IDC/FLK pin strip (2.54 mm)	IDC/FLK pin strip (2.54 mm)	IDC/FLK pin strip (2.54 mm)	IDC/FLK pin strip (2.54 mm)
Connection data solid / stranded / AWG		0.2 ... 4 mm <sup>2</sup> / 0.2 ... 2.5 mm <sup>2</sup> / 24 - 12	0.2 ... 4 mm <sup>2</sup> / 0.2 ... 2.5 mm <sup>2</sup> / 24 - 12	0.2 ... 2.5 mm <sup>2</sup> / 0.2 ... 1.5 mm <sup>2</sup> / 24 - 12	0.2 ... 2.5 mm <sup>2</sup> / 0.2 ... 1.5 mm <sup>2</sup> / 24 - 12
Dimensions	H / D	90 mm / 81 mm	90 mm / 81 mm	90 mm / 73.5 mm	90 mm / 73.5 mm

			Ordering data			Ordering data		
Description	No. of pos.	Module width W	Type	Order No.	Pcs. / Pkt.	Type	Order No.	Pcs. / Pkt.
VARIOFACE initiator module, for connection of 32 PNP initiators	50	180 mm	FLKMS 50/32IM/PLC	2284523	1			
VARIOFACE initiator module, as above, however with light indicator	50	180 mm	FLKMS 50/32IM/LA/PLC	2284510	1			
VARIOFACE initiator module, for connection of 32 PNP initiators	50	180 mm	FLKMS 50/32IM/ZFKDS/PLC	2901389	1			

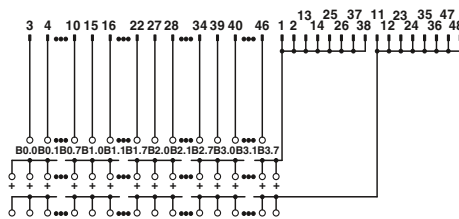

Connection scheme: FLKMS 50/32IM/PLC, ...50/32IM/ZFKDS/PLC

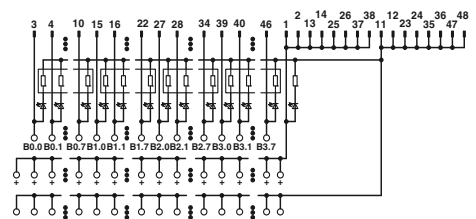

FLKMS 50/32IM/LA/PLC connection scheme



# System cabling for controllers

## Controller-specific system cabling

### Controller boards with knife disconnect terminal blocks

These VARIOFACE modules with knife disconnection and test connection for each signal (2 or 2.3 mm Ø test plug) are used in combination with the respective front adapters.

#### FLKM14/KDS3-MT/PPA/PLC

(for 8 channels)

#### FLKM 50/KDS3-MT/PPA/PLC

(for 32 channels)

- Byte-by-byte marking
- Can be used for digital I/O modules

#### FLKM-2FLK14/KDS3-MT/PPA/S7

- Numerical marking (1-20)
- Specifically for S7-300

(in conjunction with the front adapter FLKM 14-PA-S300, Order No.: 2299770)

#### FLKM 50/KDS3-MT/PPA/7-300

- Numerical marking (1-40)
- Specifically for S7-300

(in conjunction with the front adapter FLKM 50-PA-S300, Order No.: 2294445).

#### FLKM 50/KDS3-MT/PPA/AN/PLC

- Numerical marking (1-50)
- Specifically for S7-400

(in conjunction with the front adapter FLKM 50-PA-S400 (3-48) Order No.: 2294908).

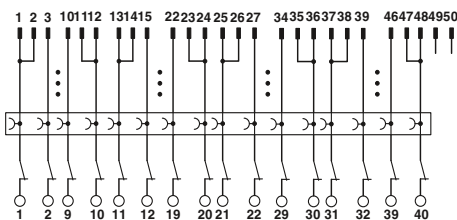
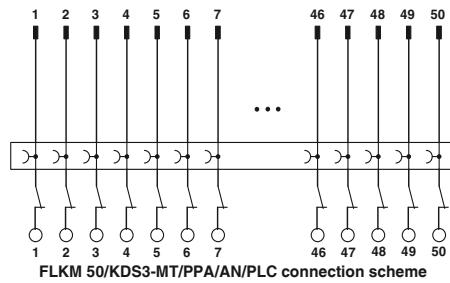

FLKM 50/KDS3-MT/PPA/S7-300 connection scheme

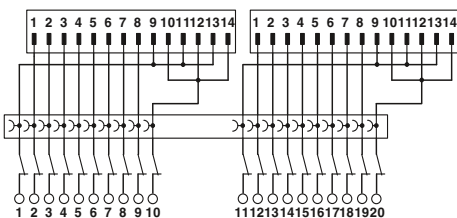

FLKM-2FLK14/KDS3-MT/PPA/S7 connection scheme

Max. perm. operating voltage	60 V DC
Max. perm. current (per branch)	1 A
Max total current (voltage supply)	3 A
Ambient temperature (operation)	-20 °C ... 50 °C
Mounting position	any
Standards/regulations	DIN EN 50178, IEC 60664, IEC 62103
Connection method	Screw connection with disconnect knife
	Field level
	Controller level
Connection data solid / stranded / AWG	0.2 ... 4 mm <sup>2</sup> / 0.2 ... 2.5 mm <sup>2</sup> / 24 - 12
Dimensions	77 mm / 61 mm

Description	No. of pos.	Module width W
VARIOFACE interface module, for eight channels, with knife disconnect terminal blocks and test sockets to the field and the system	14	67 mm
VARIOFACE interface module, for 32 channels, with knife disconnect terminal blocks and test sockets to the field and the system	50	214 mm
VARIOFACE interface module, for SIMATIC S7-300 with SIMATIC-specific marking (1-20), knife disconnect terminal blocks and test sockets to the field and the system	14	113 mm
VARIOFACE interface module, as above, however, with SIMATIC-specific marking (1-40)	50	214 mm
VARIOFACE interface module, as above, however, for SIMATIC S7-400 with SIMATIC-specific marking (3-48)	50	259 mm

FLKM 50/KDS3-MT/PPA/PLC connection scheme

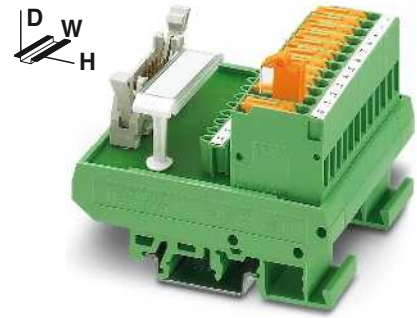

Passive interface modules for eight or 32 channels with knife disconnect terminal blocks



Technical data	
FLKM...14/KDS 3-MT...	FLKM 50/KDS 3-MT...
60 V DC	60 V DC
1 A	1 A
3 A	2 A (per byte)
-20 °C ... 50 °C	-20 °C ... 50 °C
any	any
DIN EN 50178, IEC 60664, IEC 62103	DIN EN 50178, IEC 60664, IEC 62103
Screw connection with disconnect knife	Screw connection with disconnect knife
IDC/FLK pin strip (2.54 mm)	IDC/FLK pin strip (2.54 mm)

Ordering data		
Type	Order No.	Pcs. / Pkt.
FLKM 14/KDS3-MT/PPA/PLC	2290423	1
FLKM 50/KDS3-MT/PPA/PLC	2290614	1
FLKM-2FLK14/KDS3-MT/PPA/S7	2295062	1
FLKM 50/KDS3-MT/PPA/S7-300	2304490	1
FLKM 50/KDS3-MT/PPA/AN/PLC	2291587	1

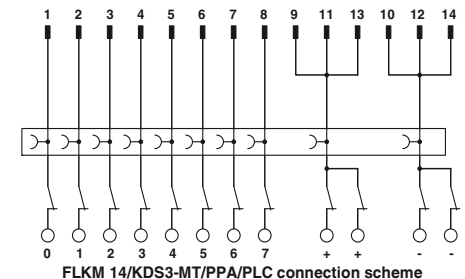
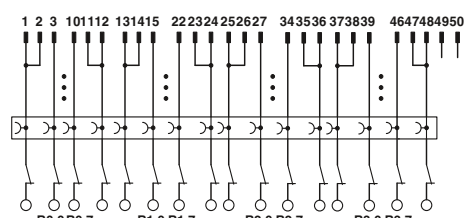

FLKM 14/KDS3-MT/PPA/PLC connection scheme



**Simulation module with switches**

These VARIOFACE modules enable simple simulation of the control and peripheral hardware for 8 signals.

The UM 45-DI/DO/S/LA/SIM8 switch module is assembled for signal transmission with COMBICON screw connector for single-conductor wiring. Alternatively, connection to the PLC system cabling is established through a 14-pos. flat-ribbon cable pin strip. Connection to the front adapters of the PLC system cabling is established through 14-pos. system cables with socket strips.

Each signal path is allocated an LED which signals the "high active" signal state. The supply voltage to the modules is signaled via a green LED.

<b>Notes:</b>
Type of housing: Terminal blocks: Polyamide PA non-reinforced, color: green. Housing: PVC
Marking systems and mounting material See Catalog 5

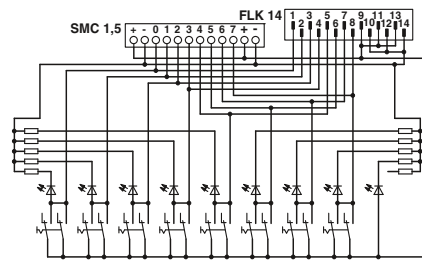

Max. perm. operating voltage	30 V DC
Max. perm. current (per branch)	1 A
Max total current (voltage supply)	8 A (+, - terminal block)
Ambient temperature (operation)	-20 °C ... 50 °C
Mounting position	any
Standards/regulations	DIN EN 50178, IEC 60664, IEC 62103
Connection data solid / stranded / AWG	0,14 ... 1,5 mm <sup>2</sup> / 0,14 ... 1,5 mm <sup>2</sup> / 28 - 16
Dimensions	45 mm / 51 mm

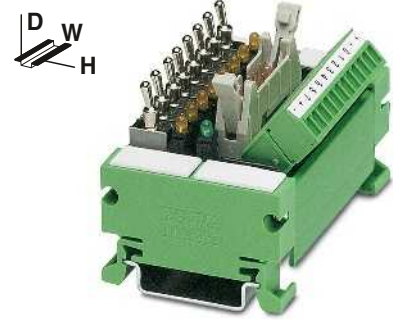

Switch module

**Technical data**

Description	No. of pos.	Module width W
<b>VARIOFACE switch module, for simulation</b>		75 mm

Ordering data		
Type	Order No.	Pcs. / Pkt.
<b>UM 45-DI/DO/S/LA/SIM8</b>	2968205	1

**Simulation module for display**

These VARIOFACE modules enable simple simulation of the control and peripheral hardware for 8 signals.

The UM 45-DO/LA/SIM8 display module is assembled for signal transmission with COMBICON screw connector for single-conductor wiring. Alternatively, connection to the PLC system cabling is established through a 14-pos. flat-ribbon cable pin strip. Connection to the front adapters of the PLC system cabling is established through 14-pos. system cables with socket strips.

Each signal path is allocated an LED which signals the "high active" signal state. The supply voltage to the modules is signaled via a green LED.

<b>Notes:</b>
Type of housing: Terminal blocks: Polyamide PA non-reinforced, color: green. Housing: PVC
Marking systems and mounting material See Catalog 5

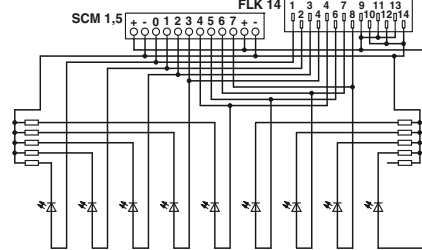

Max. perm. operating voltage	30 V DC
Max. perm. current (per branch)	1 A
Max total current (voltage supply)	8 A (+, - terminal block)
Ambient temperature (operation)	-20 °C ... 50 °C
Mounting position	any
Standards/regulations	DIN EN 50178, IEC 60664, IEC 62103
Connection data solid / stranded / AWG	0,14 ... 1,5 mm <sup>2</sup> / 0,14 ... 1,5 mm <sup>2</sup> / 28 - 16
Dimensions	45 mm / 51 mm

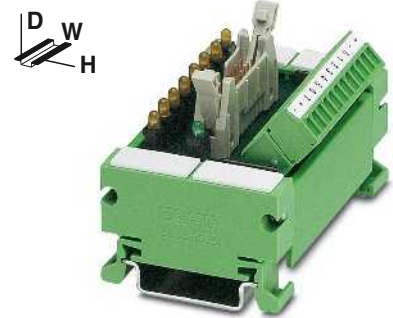

Indicator module

**Technical data**

Description	No. of pos.	Module width W
<b>VARIOFACE display module, for simulation</b>		75 mm

Ordering data		
Type	Order No.	Pcs. / Pkt.
<b>UM 45-DO/LA/SIM8</b>	2968195	1

## Controller-specific system cabling

### COMPACT LINE output modules with relays, one N/O contact

These VARIOFACE Compact Line output modules are used in combination with the respective front adapters.

Like the front adapters, the modules are connected via 14-pos. or 50-pos. system cables. The following features characterize these relay modules:

- Plug-in miniature relays, each with an N/O contact
- Universal applications from 1 mA to 3 A continuous current through 2-layer double contact with hard gold plating
- Low construction height of only 45 mm
- LED status display for each signal path and supply voltage
- Freewheeling and reverse polarity protection diode for each signal path

With the 32-channel version, the system cable is connected to the 16-channel base module UM 45-16RM/MR-G24/1/PLC.

The output extension module UM 45-16RM/MR-G24/1/E/PLC with a further 16 channels is coupled to the base module via a 20-position flat-ribbon cable (length: 10 cm).

#### Notes:

The connecting cable between the base and the extension modules is delivered with the extension unit.

Due to the geometry, it is not possible to couple any molded FLK connectors (e.g., VIP-PA...S7).



Output module with eight miniature relays, 1 N/O contact

ERC

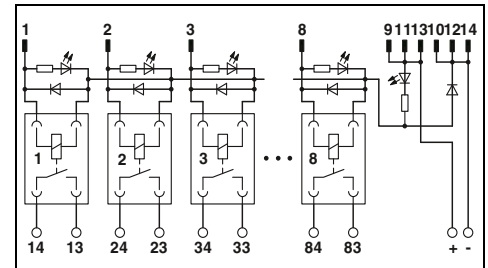

#### Technical data

<b>Coil side</b>	
Operating voltage $U_N$	24 V DC
Typ. input current at $U_N$	6.5 mA
Typ. response time at $U_N$	5 ms
Typ. release time at $U_N$	15 ms
Input circuit	Freewheeling diode, protection against polarity reversal
Status display/channel	Yellow LED
Connection method	IDC/FLK pin strip (2.54 mm)
No. of pos.	14
<b>Contact side</b>	
Contact type	1 N/O contact (double contact)
Contact material	AgNi, 5 µm hard gold-plated
Max. switching voltage	250 V AC / 125 V DC
Min. switching voltage	5 V
Max. inrush current	5 A
Limiting continuous current	3 A
Min. switching current	1 mA
Max. interrupting rating:	24 V DC 72 W 48 V DC 60 W 60 V DC 50 W 110 V DC 50 W 250 V AC 750 VA
Connection method	Screw connection
Connection data solid / stranded / AWG	0.14 ... 1.5 mm <sup>2</sup> / 0.14 ... 1.5 mm <sup>2</sup> / 26 - 14
<b>General data</b>	
Rated insulation voltage	260 V AC
Rated surge voltage	4 kV (basic insulation)
Pollution degree / Surge voltage category	2 / III
Ambient temperature (operation)	-20 °C ... 50 °C
Nominal operating mode	100% operating factor
Mechanical service life	2 x 10 <sup>7</sup> cycles
Standards/regulations	DIN EN 50178, IEC 60664, IEC 62103
Mounting position	any
Mounting	Can be aligned without spacing
Dimensions	45 mm / 50 mm
EMC note	Class A product, see page 625

#### Ordering data

Description	Module width W	Type	Order No.	Pcs. / Pkt.
<b>VARIOFACE COMPACT LINE output module, for 24 V DC (including relays)</b>				
- with 8 miniature relays	103	<b>UM 45- 8RM/MR-G24/1/PLC</b>	<b>2962900</b>	<b>1</b>
- with 16 miniature relays (basic module)	215			
- with 16 miniature relays (extension module)	200			

#### Accessories

<b>Plug-in miniature relay</b>	<b>REL-MR-G 24/1</b>	<b>2961037</b>	<b>8</b>
--------------------------------	----------------------	----------------	----------

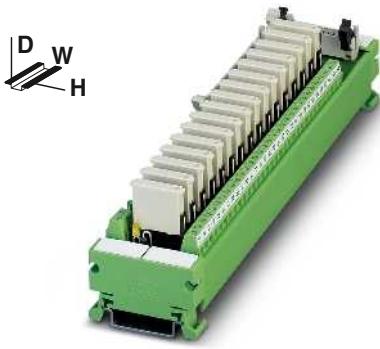

Output base module  
with 16 miniature relays,  
1 N/O contact

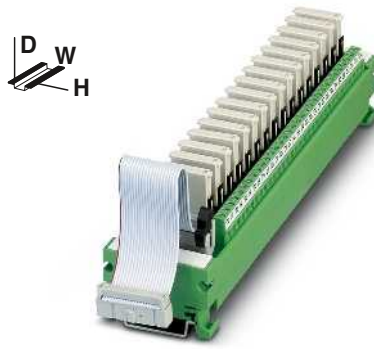

Output extension module  
with 16 miniature relays,  
1 N/O contact

ERC

ERC

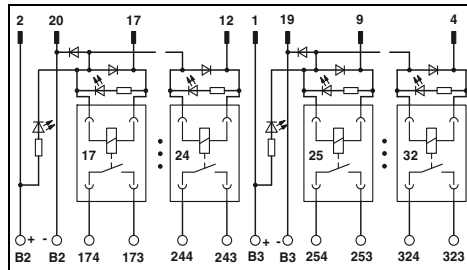
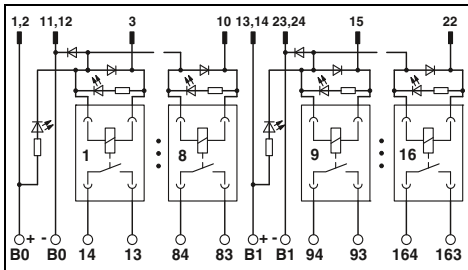

Technical data

Technical data

24 V DC  
6.5 mA  
5 ms  
15 ms  
Freewheeling diode, protection against polarity reversal  
Yellow LED  
IDC/FLK pin strip (2.54 mm)  
50

24 V DC  
6.5 mA  
5 ms  
15 ms  
Freewheeling diode, protection against polarity reversal  
Yellow LED  
IDC/FLK pin strip (2.54 mm)  
20

1 N/O contact (double contact)  
AgNi, 5 µm hard gold-plated  
250 V AC / 125 V DC  
5 V  
5 A  
3 A  
1 mA  
72 W  
60 W  
50 W  
50 W  
750 VA  
Screw connection  
0.14 ... 1.5 mm<sup>2</sup> / 0.14 ... 1.5 mm<sup>2</sup> / 26 - 14

1 N/O contact (double contact)  
AgNi, 5 µm hard gold-plated  
250 V AC / 125 V DC  
5 V  
5 A  
3 A  
1 mA  
72 W  
60 W  
50 W  
50 W  
750 VA  
Screw connection  
0.14 ... 1.5 mm<sup>2</sup> / 0.14 ... 1.5 mm<sup>2</sup> / 26 - 14

260 V AC  
4 kV (basic insulation)  
2 / III  
-20 °C ... 50 °C  
100% operating factor  
2 x 10<sup>7</sup> cycles  
DIN EN 50178, IEC 60664, IEC 62103  
any  
Can be aligned without spacing  
45 mm / 50 mm  
Class A product, see page 625

260 V AC  
4 kV (basic insulation)  
2 / III  
-20 °C ... 50 °C  
100% operating factor  
2 x 10<sup>7</sup> cycles  
DIN EN 50178, IEC 60664, IEC 62103  
any  
Can be aligned without spacing  
45 mm / 50 mm  
Class A product, see page 625

Ordering data

Ordering data

Type	Order No.	Pcs. / Pkt.
UM 45-16RM/MR-G24/1/PLC	2962913	1

Type	Order No.	Pcs. / Pkt.
UM 45-16RM/MR-G24/1/E/PLC	2962926	1

Accessories

Accessories

REL-MR-G 24/1	2961037	8
---------------	---------	---

REL-MR-G 24/1	2961037	8
---------------	---------	---

# System cabling for controllers

## Controller-specific system cabling

### Output modules with relays, one N/O contact

These VARIOFACE output modules are used in combination with the respective front adapters.

- Plug-in miniature relays, each with an N/O contact
- Universal applications from 1 mA to 3 A continuous current through 2-layer double contact with hard gold plating
- Narrow overall width of just 55 mm (8 channels) or 202 mm (32 channels)
- LED status display for each signal path and supply voltage
- Freewheeling and reverse polarity protection diode for each signal path

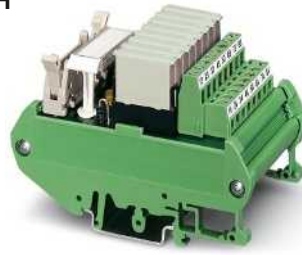

Output module with eight miniature relays, 1 N/O contact

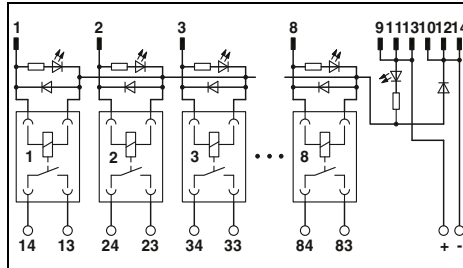

#### Technical data

Coil side	
Operating voltage $U_N$	24 V DC
Typ. input current at $U_N$	6.5 mA
Typ. response time at $U_N$	5 ms
Typ. release time at $U_N$	15 ms
Input circuit	Freewheeling diode, protection against polarity reversal
Status display/channel	Yellow LED
Connection method	IDC/FLK pin strip (2.54 mm)
No. of pos.	14
Contact side	
Contact type	1 N/O contact (double contact)
Contact material	AgNi, 5 µm hard gold-plated
Max. switching voltage	250 V AC / 125 V DC
Min. switching voltage	5 V
Max. inrush current	5 A
Limiting continuous current	3 A
Min. switching current	1 mA
Max. interrupting rating:	24 V DC 48 V DC 60 V DC 110 V DC 250 V AC
Connection method	
Connection data solid / stranded / AWG	0.14 ... 1.5 mm <sup>2</sup> / 0.14 ... 1.5 mm <sup>2</sup> / 26 - 14
General data	
Rated insulation voltage	260 V AC
Rated surge voltage	4 kV (basic insulation)
Pollution degree / Surge voltage category	2 / III
Ambient temperature (operation)	-20 °C ... 50 °C
Nominal operating mode	100% operating factor
Mechanical service life	2 x 10 <sup>7</sup> cycles
Standards/regulations	DIN EN 50178, IEC 60664, IEC 62103
Mounting position	any
Mounting	Can be aligned without spacing
Dimensions	90 mm / 58 mm
EMC note	Class A product, see page 625

#### Ordering data

Description	Module width W
VARIOFACE output module, with 8 miniature relays, plugged in, for 24 V DC (including relays)	56
VARIOFACE output module, with 32 miniature relays, plugged in, for 24 V DC (including relays)	202

#### Accessories

Plug-in miniature relay	REL-MR-G 24/1	2961037	8
-------------------------	---------------	---------	---

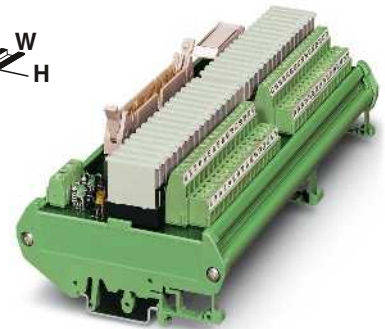

Output module with 32 miniature relays, 1 N/O contact

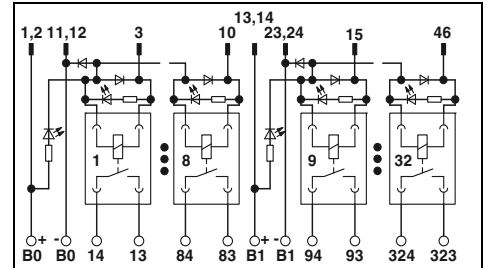

#### Technical data

Coil side	
Operating voltage $U_N$	24 V DC
Typ. input current at $U_N$	6.5 mA
Typ. response time at $U_N$	5 ms
Typ. release time at $U_N$	15 ms
Input circuit	Freewheeling diode, protection against polarity reversal
Status display/channel	Yellow LED
Connection method	IDC/FLK pin strip (2.54 mm)
No. of pos.	50
Contact side	
Contact type	1 N/O contact (double contact)
Contact material	AgNi, 5 µm hard gold-plated
Max. switching voltage	250 V AC / 125 V DC
Min. switching voltage	5 V
Max. inrush current	5 A
Limiting continuous current	3 A
Min. switching current	1 mA
Max. interrupting rating:	24 V DC 48 V DC 60 W 50 W 50 W 750 VA
Connection method	
Connection data solid / stranded / AWG	0.14 ... 1.5 mm <sup>2</sup> / 0.14 ... 1.5 mm <sup>2</sup> / 26 - 16
General data	
Rated insulation voltage	260 V AC
Rated surge voltage	4 kV (basic insulation)
Pollution degree / Surge voltage category	2 / III
Ambient temperature (operation)	-20 °C ... 50 °C
Nominal operating mode	100% operating factor
Mechanical service life	2 x 10 <sup>7</sup> cycles
Standards/regulations	DIN EN 50178, IEC 60664, IEC 62103
Mounting position	any
Mounting	Can be aligned without spacing
Dimensions	90 mm / 58 mm
EMC note	Class A product, see page 625

#### Ordering data

Type	Order No.	Pcs. / Pkt.
UMK- 8 RM/MR-G24/ 1/PLC	2979469	1
UMK-32 RM/MR-G24/1/PLC	2979472	1

#### Accessories

Plug-in miniature relay	REL-MR-G 24/1	2961037	8
-------------------------	---------------	---------	---

### Output modules with relay, 1 PDT

These VARIOFACE output modules are used in combination with the respective front adapters.

Like the front adapters, the modules are connected via 14-pos. or 50-pos. system cables. The following features characterize these relay modules:

- Plug-in miniature relays, each with a PDT contact
- Narrow overall width of just 80 mm (8 channels) or 271 mm (32 channels)
- LED status display for each signal path and supply voltage
- Freewheeling diode for each signal path

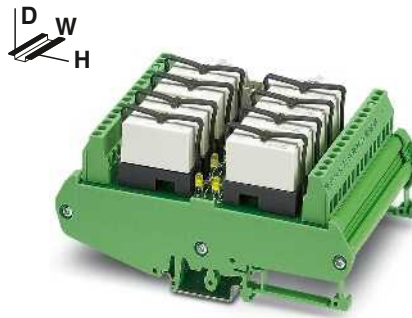

**Output module with eight miniature relays, 1 PDT**

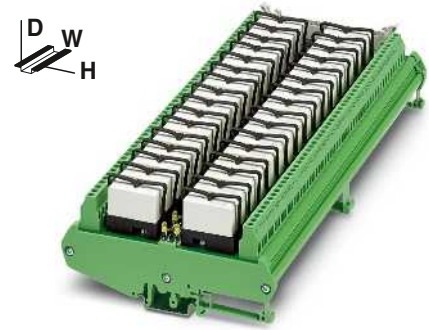

**Output module with 32 miniature relays, 1 PDT**

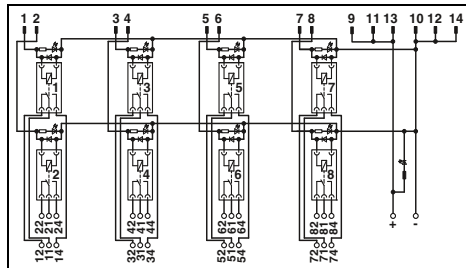

#### Technical data

Coil side	
Operating voltage $U_N$	24 V DC
Typ. input current at $U_N$	18 mA
Typ. response time at $U_N$	8 ms
Typ. release time at $U_N$	10 ms
Input circuit	Freewheeling diode
Status display/channel	Yellow LED
Connection method	IDC/FLK pin strip (2.54 mm)
No. of pos.	14
Contact side	
Contact type	Single contact, 1-PDT
Contact material	AgNi
Max. switching voltage	250 V AC/DC
Min. switching voltage	12 V AC/DC
Limiting continuous current	5 A
Min. switching current	100 mA
Max. interrupting rating:	24 V DC 120 W 48 V DC 58 W 60 V DC 48 W 110 V DC 50 W 220 V DC 80 W 250 V AC 1250 VA
Connection method	Screw connection
Connection data solid / stranded / AWG	0.2 ... 4 mm <sup>2</sup> / 0.2 ... 2.5 mm <sup>2</sup> / 24 - 12
General data	
Rated insulation voltage	260 V AC
Rated surge voltage	4 kV (basic insulation between output contact current paths) 6 kV (safe isolation and reinforced insulation between input circuit and output contact paths)
Pollution degree / Surge voltage category	2 / III
Ambient temperature (operation)	-20 °C ... 50 °C
Nominal operating mode	100% operating factor
Mechanical service life	3 x 10 <sup>7</sup> cycles
Standards/regulations	DIN EN 50178, IEC 60664, IEC 62103
Mounting position	any
Mounting	Can be aligned without spacing
Dimensions	H / D 123 mm / 68 mm
EMC note	Class A product, see page 625

#### Ordering data

Description	Module width W	Type	Order No.	Pcs. / Pkt.
<b>VARIOFACE output module, for 24 V DC (incl. relay)</b>				
- with 8 miniature relays	80	UM- 8 RM/RT-G24/21/PLC	2968386	1
- with 32 miniature relays	271			

#### Accessories

<b>Plug-in miniature relay</b>	REL-MR- 24DC/21HC	2961312	10
--------------------------------	-------------------	---------	----

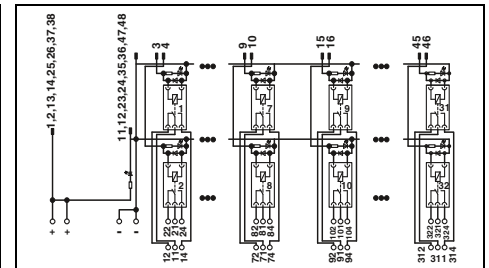

#### Technical data

Coil side	
Operating voltage $U_N$	24 V DC
Typ. input current at $U_N$	18 mA
Typ. response time at $U_N$	8 ms
Typ. release time at $U_N$	10 ms
Input circuit	Freewheeling diode
Status display/channel	Yellow LED
Connection method	IDC/FLK pin strip (2.54 mm)
No. of pos.	50
Contact side	
Contact type	Single contact, 1-PDT
Contact material	AgNi
Max. switching voltage	250 V AC/DC
Min. switching voltage	12 V AC/DC
Limiting continuous current	5 A
Min. switching current	100 mA
Max. interrupting rating:	120 W 58 W 48 W 50 W 80 W 1250 VA
Connection method	Screw connection
Connection data solid / stranded / AWG	0.2 ... 4 mm <sup>2</sup> / 0.2 ... 2.5 mm <sup>2</sup> / 24 - 12
General data	
Rated insulation voltage	260 V AC
Rated surge voltage	4 kV (basic insulation between output contact current paths) 6 kV (safe isolation and reinforced insulation between input circuit and output contact paths)
Pollution degree / Surge voltage category	2 / III
Ambient temperature (operation)	-20 °C ... 50 °C
Nominal operating mode	100% operating factor
Mechanical service life	3 x 10 <sup>7</sup> cycles
Standards/regulations	DIN EN 50178, IEC 60664, IEC 62103
Mounting position	any
Mounting	Can be aligned without spacing
Dimensions	H / D 123 mm / 68 mm
EMC note	Class A product, see page 625

#### Ordering data

Description	Module width W	Type	Order No.	Pcs. / Pkt.
<b>VARIOFACE output module, for 24 V DC (incl. relay)</b>				
- with 8 miniature relays	80	UM- 8 RM/RT-G24/21/PLC	2968386	1
- with 32 miniature relays	271	UM-32 RM/RT-G24/21/PLC	2968373	1

#### Accessories

<b>Plug-in miniature relay</b>	REL-MR- 24DC/21HC	2961312	10
--------------------------------	-------------------	---------	----

## Controller-specific system cabling

### Output modules with relay, 1 PDT

These VARIOFACE output modules are used in combination with the respective front adapters.

Like the front adapters, the modules are connected via 14-pos. or 50-pos. system cables. The following features characterize these relay modules:

- Plug-in miniature relays, each with a PDT contact
- LED status display for each signal path and supply voltage
- Freewheeling and reverse polarity protection diode for each signal path

With the 32-channel version, the system cable is connected to the base module with the 16-channel UMK-16R.../KSR-G24/21/PLC. The output extension module UMK-16R.../KSR-G24/21/E/PLC with a further 16 channels is coupled to the base module via a 20-position flat-ribbon cable (length: 10 cm).

#### Notes:

The connecting cable between the base and the extension modules is delivered with the extension unit.

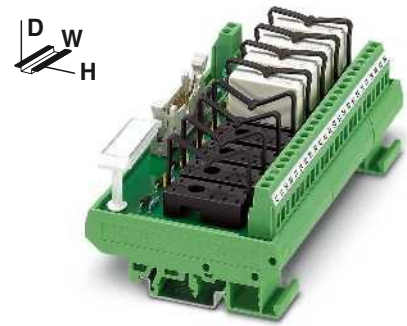

**Output module  
with eight miniature relays,  
1 PDT**

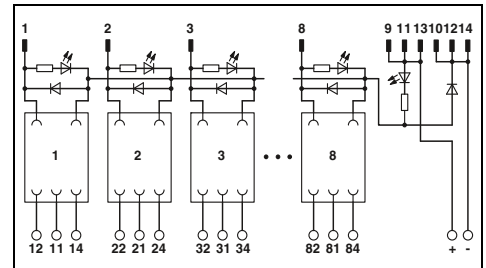

#### Technical data

Coil side	
Operating voltage $U_N$	24 V DC $\pm 10\%$
Input circuit	Freewheeling diode, protection against polarity reversal
Operating voltage display	Green LED
Status display/channel	Yellow LED
Connection method	IDC/FLK pin strip (2.54 mm)
No. of pos.	14
Contact side	
Contact type	1 PDT
Max. switching voltage	250 V AC/DC
Limiting continuous current	5 A
Connection method	Screw connection
Connection data solid / stranded / AWG	0.2 ... 4 mm <sup>2</sup> / 0.2 ... 2.5 mm <sup>2</sup> / 24 - 12
General data	
Rated insulation voltage	260 V AC
Rated surge voltage	4 kV (basic insulation between output contact current paths) 6 kV (safe isolation and reinforced insulation between input circuit and output contact paths)
Pollution degree / Surge voltage category	2 / III
Ambient temperature (operation)	-20 °C ... 50 °C
Standards/regulations	DIN EN 50178, IEC 60664, IEC 62103
Mounting position	any
Mounting	Can be aligned without spacing
Dimensions	77 mm / 59 mm
EMC note	Class A product, see page 625

#### Ordering data

Description	Module width W	Type	Order No.	Pcs. / Pkt.
<b>VARIOFACE output module</b> , for 24 V DC - with 8 plug-in bases including relay	135	<b>UMK- 8 RM/KSR-G 24/21/PLC</b>	<b>2979485</b>	1
- with 8 plug-in bases without relay	135	<b>UMK- 8 RELS/KSR-G24/21/PLC</b>	<b>2974914</b>	1
<b>VARIOFACE output basic module</b> , for 24 V DC - with 16 plug-in bases including relay	259			
- with 16 plug-in bases without relay	259			
<b>VARIOFACE output extension module</b> , for 24 V DC - with 16 plug-in bases including relay	259			
- with 16 plug-in bases without relay	259			

#### Accessories

<b>Plug-in miniature relay</b>	<b>REL-MR- 24DC/21HC</b>	<b>2961312</b>	10
--------------------------------	--------------------------	----------------	----



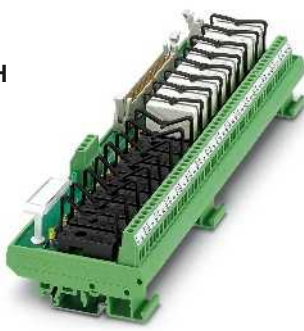

Output base module  
with 16 miniature relays,  
1 PDT

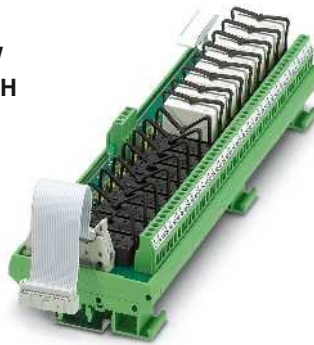

Output extension module  
with 16 miniature relays,  
1 PDT

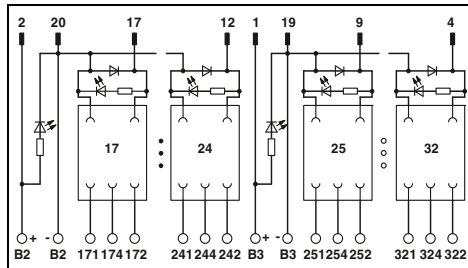
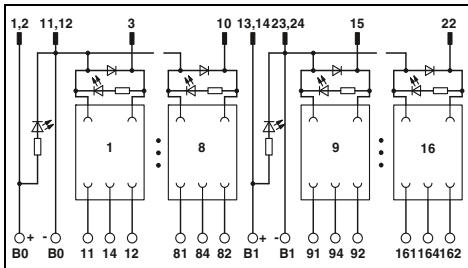

Technical data

Technical data

24 V DC  $\pm 10\%$   
 Freewheeling diode, protection against polarity reversal  
 Green LED  
 Yellow LED  
 IDC/FLK pin strip (2.54 mm)  
 50

24 V DC  $\pm 10\%$   
 Freewheeling diode, protection against polarity reversal  
 Green LED  
 Yellow LED  
 IDC/FLK pin strip (2.54 mm)  
 20

1 PDT  
 250 V AC/DC  
 5 A  
 Screw connection  
 0.2 ... 4 mm<sup>2</sup> / 0.2 ... 2.5 mm<sup>2</sup> / 24 - 12

1 PDT  
 250 V AC/DC  
 5 A  
 Screw connection  
 0.2 ... 4 mm<sup>2</sup> / 0.2 ... 2.5 mm<sup>2</sup> / 24 - 12

260 V AC  
 4 kV (basic insulation between output contact current paths)  
 6 kV (safe isolation and reinforced insulation between input circuit and output contact paths)

260 V AC  
 4 kV (basic insulation between output contact current paths)  
 6 kV (safe isolation and reinforced insulation between input circuit and output contact paths)

2 / III  
 -20 °C ... 50 °C  
 DIN EN 50178, IEC 60664, IEC 62103  
 any  
 Can be aligned without spacing  
 77 mm / 59 mm  
 Class A product, see page 625

2 / III  
 -20 °C ... 50 °C  
 DIN EN 50178, IEC 60664, IEC 62103  
 any  
 Can be aligned without spacing  
 77 mm / 59 mm  
 Class A product, see page 625

Ordering data

Ordering data

Type	Order No.	Pcs. / Pkt.
UMK-16 RM/KSR-G 24/21/PLC	2979498	1
UMK-16 RELS/KSR-G24/21/PLC	2974901	1

Type	Order No.	Pcs. / Pkt.
UMK-16 RM/KSR-G 24/21/E/PLC	2979508	1
UMK-16 RELS/KSR-G24/21/E/PLC	2974891	1

Accessories

Accessories

REL-MR- 24DC/21HC	2961312	10
-------------------	---------	----

REL-MR- 24DC/21HC	2961312	10
-------------------	---------	----



## Controller-specific system cabling

### Output module for relays

#### - 2 PDTs

#### - 1 PDT with disconnect terminal blocks

These VARIOFACE output modules are used in combination with the respective front adapters.

8 channels are controlled via 14-pos. cables. All modules feature the following:

- Plug-in miniature relays
- LED status indicator and freewheeling diode per signal path
- Supply voltage indicator (LED)
- Polarity protection diode

With the 32-channel version (1 PDT with knife disconnect terminal blocks), the 50-pos. system cable is connected to the base module with 16 channels.

The output extension module with a further 16 channels is coupled to the base module via a 20-pos. flat-ribbon cable (length: 10 cm).

#### Notes:

The connecting cable between the base and the extension modules is delivered with the extension unit.

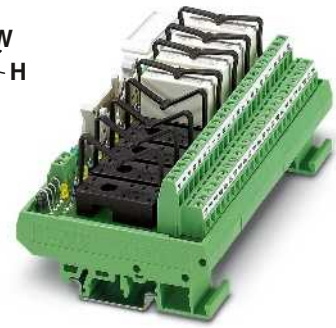

Output module for 8 miniature relays, 2 PDTs

ERC

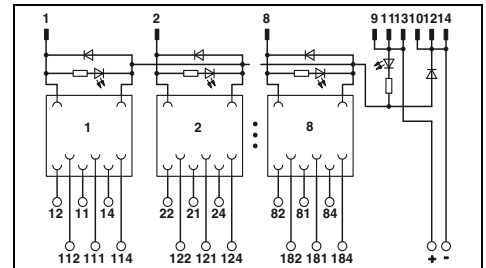

#### Technical data

<b>Coil side</b>	
Operating voltage $U_N$	24 V DC
Input circuit	Freewheeling diode
Operating voltage display	Green LED
Status display/channel	Yellow LED
Connection method	IDC/FLK pin strip (2.54 mm)
No. of pos.	14
<b>Contact side</b>	
Contact type	2 PDT
Max. switching voltage	250 V AC/DC
Limiting continuous current	3 A
Connection method	Screw connection
Connection data solid / stranded / AWG	0.14 ... 1.5 mm <sup>2</sup> / 0.14 ... 1.5 mm <sup>2</sup> / 26 - 14
<b>General data</b>	
Rated insulation voltage	260 V AC
Rated surge voltage	4 kV (basic insulation between output contact current paths) 6 kV (safe isolation and reinforced insulation between input circuit and output contact paths)
Pollution degree / Surge voltage category	2 / III
Ambient temperature (operation)	-20 °C ... 50 °C
Standards/regulations	DIN EN 50178, IEC 60664, IEC 62103
Mounting position	any
Mounting	Can be aligned without spacing
Dimensions	77 mm / 59 mm
EMC note	Class A product, see page 625

<b>Technical data</b>	
Operating voltage $U_N$	24 V DC
Input circuit	Freewheeling diode
Operating voltage display	Green LED
Status display/channel	Yellow LED
Connection method	IDC/FLK pin strip (2.54 mm)
No. of pos.	14
<b>Contact side</b>	
Contact type	2 PDT
Max. switching voltage	250 V AC/DC
Limiting continuous current	3 A
Connection method	Screw connection
Connection data solid / stranded / AWG	0.14 ... 1.5 mm <sup>2</sup> / 0.14 ... 1.5 mm <sup>2</sup> / 26 - 14
<b>General data</b>	
Rated insulation voltage	260 V AC
Rated surge voltage	4 kV (basic insulation between output contact current paths) 6 kV (safe isolation and reinforced insulation between input circuit and output contact paths)
Pollution degree / Surge voltage category	2 / III
Ambient temperature (operation)	-20 °C ... 50 °C
Standards/regulations	DIN EN 50178, IEC 60664, IEC 62103
Mounting position	any
Mounting	Can be aligned without spacing
Dimensions	77 mm / 59 mm
EMC note	Class A product, see page 625

#### Ordering data

Description	Module width W
<b>VARIOFACE output module, for 24 V DC (2 PDTs)</b>	
- with 8 plug-in bases without relay	135
<b>VARIOFACE output module with disconnect terminal blocks, for 24 V DC (1 PDT)</b>	
- with 8 plug-in bases without relay	145
<b>VARIOFACE output module with disconnect terminal blocks, for 24 V DC (1 PDT)</b>	
- basic module with 16 plug-in bases without relay	285
- extension module with 16 plug-in bases without relay	285

Type	Order No.	Pcs. / Pkt.
<b>UMK- 8 RELS/KSR-G24/21-PLC</b>	<b>2976187</b>	1

#### Accessories

<b>Plug-in miniature relay</b>
--------------------------------

<b>REL-MR- 24DC/21-21</b>	<b>2961192</b>	10
---------------------------	----------------	----



Output module for 8 miniature relays with knife/disconnect terminal blocks, 1 PDT

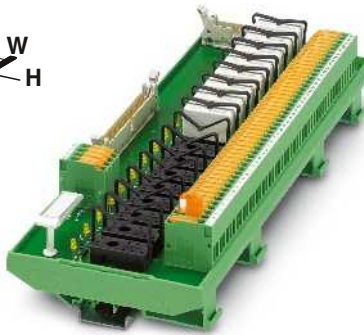

Output module for 16 miniature relays with knife/disconnect terminal blocks, 1 PDT

ERC

ERC

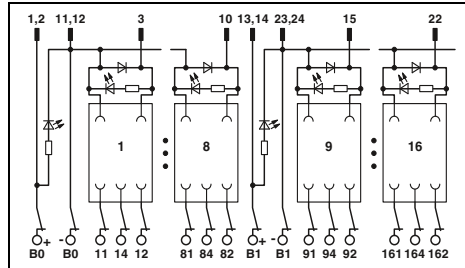
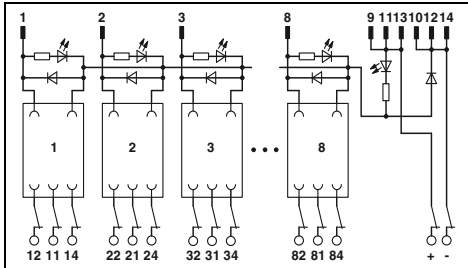

Technical data

Technical data

24 V DC  
 Freewheeling diode, protection against polarity reversal  
 Green LED  
 Yellow LED  
 IDC/FLK pin strip (2.54 mm)  
 14

24 V DC  
 Freewheeling diode  
 Green LED  
 Yellow LED  
 IDC/FLK pin strip (2.54 mm)  
 50

1 PDT  
 250 V AC/DC  
 5 A  
 Screw connection with disconnect knife  
 0.2 ... 4 mm<sup>2</sup> / 0.2 ... 2.5 mm<sup>2</sup> / 24 - 12

1 PDT  
 250 V AC/DC  
 5 A  
 Screw connection with disconnect knife  
 0.2 ... 4 mm<sup>2</sup> / 0.2 ... 2.5 mm<sup>2</sup> / 24 - 12

260 V AC  
 4 kV (basic insulation between output contact current paths)  
 6 kV (safe isolation and reinforced insulation between input circuit and output contact paths)

260 V AC  
 4 kV (basic insulation between output contact current paths)  
 6 kV (safe isolation and reinforced insulation between input circuit and output contact paths)

2 / III  
 -20 °C ... 50 °C  
 DIN EN 50178, IEC 60664, IEC 62103  
 any  
 Can be aligned without spacing  
 111.5 mm / 59 mm  
 Class A product, see page 625

2 / III  
 -20 °C ... 50 °C  
 DIN EN 50178, IEC 60664, IEC 62103  
 any  
 Can be aligned without spacing  
 111.5 mm / 59 mm  
 Class A product, see page 625

Ordering data

Ordering data

Type	Order No.	Pcs. / Pkt.
UM-8 RELS/KSR-G24/21/MT/PLC	2962463	1

Type	Order No.	Pcs. / Pkt.
UM-16 RELS/KSR-G24/21/MT/PLC	2962382	1
UM-16 RELS/KSR-G24/21/E/MT/PLC	2962379	1

Accessories

Accessories

REL-MR- 24DC/21HC	2961312	10
-------------------	---------	----

REL-MR- 24DC/21HC	2961312	10
-------------------	---------	----

# System cabling for controllers

## Controller-specific system cabling

### Output modules with relays, 1 PDT with detectable manual operation

These VARIOFACE output modules are used in combination with the respective front adapters.

The modules are connected via 14 or 50-pos. system cable. These relay modules offer the following features:

- Plug-in miniature relays each with a PDT contact and detectable manual operation
- Narrow overall width of just 92 mm (8 channels) or 285 mm (32 channels)
- LED status indicator and freewheeling diode per signal path (integrated in relay)
- Supply voltage indicator (LED)



Output module with 8 miniature relays, 1 PDT with detectable manual operation

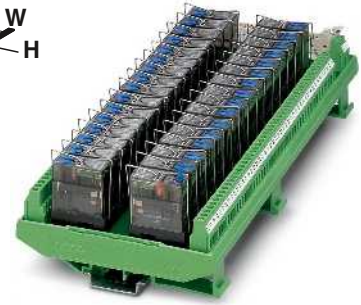

Output module with 32 miniature relays, 1 PDT with detectable manual operation

ERC

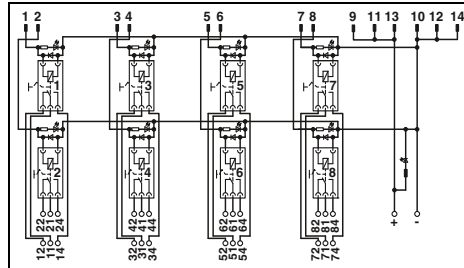

ERC

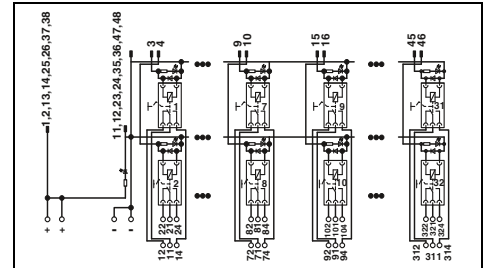

#### Technical data

Coil side	
Operating voltage $U_N$	24 V DC
Typ. input current at $U_N$	18 mA
Typ. response time at $U_N$	9 ms
Typ. release time at $U_N$	6 ms
Input circuit	Freewheeling diode (integrated in relay)
Status display/channel	Yellow LED (integrated in relay)
Connection method	IDC/FLK pin strip (2.54 mm)
No. of pos.	14
Contact side	
Contact type	Single contact, 1-PDT
Contact material	AgNi
Max. switching voltage	250 V AC/DC
Min. switching voltage	12 V AC/DC
Limiting continuous current	5 A
Min. switching current	100 mA
Max. interrupting rating:	24 V DC 120 W 48 V DC 62 W 60 V DC 42 W 110 V DC 55 W 220 V DC 66 W 250 V AC 1250 VA
Connection method	Screw connection
Connection data solid / stranded / AWG	0.2 ... 4 mm <sup>2</sup> / 0.2 ... 2.5 mm <sup>2</sup> / 24 - 12
General data	
Rated insulation voltage	260 V AC
Rated surge voltage	4 kV (basic insulation between output contact current paths) 6 kV (safe isolation and reinforced insulation between input circuit and output contact paths)
Pollution degree / Surge voltage category	
Ambient temperature (operation)	2 / III -20 °C ... 50 °C
Nominal operating mode	100% operating factor
Mechanical service life	5 x 10 <sup>6</sup> cycles
Standards/regulations	DIN EN 50178, IEC 60664, IEC 62103
Mounting position	any
Mounting	Can be aligned without spacing
Dimensions	111 mm / 64 mm
EMC note	Class A product, see page 625

#### Ordering data

Description	Module width W
<b>VARIOFACE output module</b> , for 24 V DC (incl. relay)	
- with 8 miniature relays	92
- with 32 miniature relays	285

#### Accessories

<b>Plug-in miniature power relay</b> , with power contacts
--

#### Technical data

Coil side	
Operating voltage $U_N$	24 V DC
Typ. input current at $U_N$	18 mA
Typ. response time at $U_N$	9 ms
Typ. release time at $U_N$	6 ms
Input circuit	Freewheeling diode (integrated in relay)
Status display/channel	Yellow LED (integrated in relay)
Connection method	IDC/FLK pin strip (2.54 mm)
No. of pos.	50
Contact side	
Contact type	Single contact, 1-PDT
Contact material	AgNi
Max. switching voltage	250 V AC/DC
Min. switching voltage	12 V AC/DC
Limiting continuous current	5 A
Min. switching current	100 mA
Max. interrupting rating:	120 W 62 W 42 W 55 W 66 W 1250 VA
Connection method	Screw connection
Connection data solid / stranded / AWG	0.2 ... 4 mm <sup>2</sup> / 0.2 ... 2.5 mm <sup>2</sup> / 24 - 12
General data	
Rated insulation voltage	260 V AC
Rated surge voltage	4 kV (basic insulation between output contact current paths) 6 kV (safe isolation and reinforced insulation between input circuit and output contact paths)
Pollution degree / Surge voltage category	
Ambient temperature (operation)	2 / III -20 °C ... 50 °C
Nominal operating mode	100% operating factor
Mechanical service life	5 x 10 <sup>6</sup> cycles
Standards/regulations	DIN EN 50178, IEC 60664, IEC 62103
Mounting position	any
Mounting	Can be aligned without spacing
Dimensions	111 mm / 64 mm
EMC note	Class A product, see page 625

#### Ordering data

Type	Order No.	Pcs. / Pkt.
<b>VARIOFACE output module</b> , for 24 V DC (incl. relay)		
- with 8 miniature relays	2900890	1
- with 32 miniature relays	2900891	1

#### Accessories

<b>Plug-in miniature power relay</b> , with power contacts
--

### Output modules with relays, 1 PDT with or without manual operation and fuses

These VARIOFACE output modules are used in combination with the respective front adapters.

The modules are connected via 14-pos. system cable. These relay modules offer the following features:

- Plug-in miniature relays each with a PDT contact with or without manual operation
- Fuse per output circuit as short-circuit protection
- Narrow overall width of just 127 mm
- LED status indicator and freewheeling diode per signal path
- Supply voltage indicator (LED)
- Polarity protection diode



Output module with 8 miniature relays, 1 PDT and fuse per output circuit



Output module with 8 miniature relays, 1 PDT with detectable manual operation and fuse per output circuit

ERC

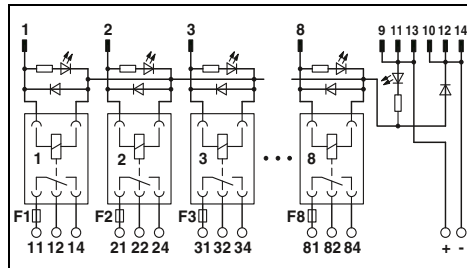

ERC

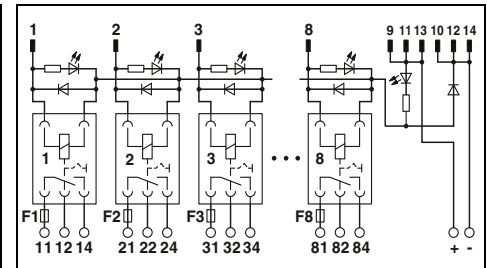

#### Technical data

Coil side	
Operating voltage $U_N$	24 V DC
Typ. input current at $U_N$	17 mA
Typ. response time at $U_N$	8 ms
Typ. release time at $U_N$	10 ms
Input circuit	Freewheeling diode
Status display/channel	Yellow LED
Connection method	IDC/FLK pin strip (2.54 mm)
No. of pos.	14
Contact side	
Contact type	Single contact, 1-PDT
Contact material	AgNi
Max. switching voltage	250 V AC/DC
Min. switching voltage	12 V AC/DC
Output fuse	4 A 5x20 fuse (slow-blow)
Limiting continuous current	3.9 A (observe derating)
Min. switching current	100 mA
Max. interrupting rating:	24 V DC 93 W 48 V DC 58 W 60 V DC 48 W 110 V DC 50 W 220 V DC 80 W 250 V AC 975 VA

Connection method	Screw connection
Connection data solid / stranded / AWG	0.2 ... 4 mm <sup>2</sup> / 0.2 ... 2.5 mm <sup>2</sup> / 24 - 12

General data	
Rated insulation voltage	260 V AC
Rated surge voltage	4 kV (basic insulation between output contact current paths) 6 kV (safe isolation and reinforced insulation between input circuit and output contact paths)

Pollution degree / Surge voltage category	2 / III
Ambient temperature (operation)	-20 °C ... 50 °C
Nominal operating mode	100% operating factor
Mechanical service life	3 x 10 <sup>7</sup> cycles
Standards/regulations	DIN EN 50178, IEC 60664, IEC 62103
Mounting position	any
Mounting	Can be aligned without spacing
Dimensions	111 mm / 60 mm
EMC note	Class A product, see page 625

#### Ordering data

Description	Module width W
<b>VARIOFACE output module</b> , with 8 miniature relays, plugged in, for 24 V DC (including relays)	127

<b>Plug-in miniature relay</b>	
--------------------------------	--

Type	Order No.	Pcs. / Pkt.
UM- 8RM/KSR-G24/21/SI/PLC	2900892	1

#### Accessories

REL-MR- 24DC/21HC	2961312	10
-------------------	---------	----

#### Technical data

Coil side	
Operating voltage $U_N$	24 V DC
Typ. input current at $U_N$	18 mA
Typ. response time at $U_N$	9 ms
Typ. release time at $U_N$	6 ms
Input circuit	Freewheeling diode (integrated in relay)
Status display/channel	Yellow LED (integrated in relay)
Connection method	IDC/FLK pin strip (2.54 mm)
No. of pos.	14
Contact side	
Contact type	Single contact, 1-PDT
Contact material	AgNi
Max. switching voltage	250 V AC/DC
Min. switching voltage	12 V AC/DC
Output fuse	4 A 5x20 fuse (slow-blow)
Limiting continuous current	3.9 A (observe derating)
Min. switching current	100 mA
Max. interrupting rating:	93 W 62 W 42 W 55 W 66 W 975 VA

Connection method	Screw connection
Connection data solid / stranded / AWG	0.2 ... 4 mm <sup>2</sup> / 0.2 ... 2.5 mm <sup>2</sup> / 24 - 12

General data	
Rated insulation voltage	260 V AC
Rated surge voltage	4 kV (basic insulation between output contact current paths) 6 kV (safe isolation and reinforced insulation between input circuit and output contact paths)

Pollution degree / Surge voltage category	2 / III
Ambient temperature (operation)	-20 °C ... 50 °C
Nominal operating mode	100% operating factor
Mechanical service life	5 x 10 <sup>6</sup> cycles
Standards/regulations	DIN EN 50178, IEC 60664, IEC 62103
Mounting position	any
Mounting	Can be aligned without spacing
Dimensions	111 mm / 64 mm
EMC note	Class A product, see page 625

#### Ordering data

Type	Order No.	Pcs. / Pkt.
UM- 8RM/KSR-G24/21/MS/SI/PLC	2900893	1

#### Accessories

REL-MR- 24DC/21HC/MS	2987888	10
----------------------	---------	----

### VIP output module

This VIP VARIOFACE output module is used in combination with the respective front adapters. Like the front adapters, the module is connected via 14-pos. system cables.

**Features:**

- Plug-in miniature relays, each with a PDT contact
- LED status display for each signal path and supply voltage
- Freewheeling diode for each signal path
- Push-in connection



**Output module with 8 miniature relays, 1 PDT and fuse per output circuit**

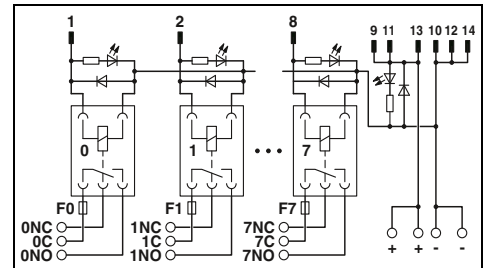

#### Technical data

<b>Coil side</b>		
Operating voltage $U_N$		24 V DC
Typ. input current at $U_N$		9 mA
Typ. response time at $U_N$		5 ms
Typ. release time at $U_N$		8 ms
Input circuit		Freewheeling diode
Status display/channel		Yellow LED
Connection method		IDC/FLK pin strip (2.54 mm)
No. of pos.		14
<b>Contact side</b>		
Contact type		Single contact, 1-PDT
Contact material		AgSnO
Max. switching voltage		250 V AC/DC
Min. switching voltage		12 V AC/DC
Limiting continuous current		5 A (observe derating)
Min. switching current		10 mA
Max. interrupting rating:		24 V DC 120 W
		48 V DC 20 W
		60 V DC 18 W
		110 V DC 23 W
		220 V DC 40 W
		250 V AC 1250 VA
Connection method		Push-in connection
Connection data solid / stranded / AWG		0.14 ... 2.5 mm <sup>2</sup> / 0.14 ... 2.5 mm <sup>2</sup> / 26 - 14
<b>General data</b>		
Ambient temperature (operation)		-20 °C ... 60 °C
Nominal operating mode		100% operating factor
Mechanical service life		2 x 10 <sup>7</sup> cycles
Standards/regulations		DIN EN 50178
Mounting position		any
Mounting		Can be aligned without spacing
Dimensions	H / D	109.8 mm / 63 mm
EMC note		Class A product, see page 625

#### Ordering data

Description	Module width W	Type	Order No.	Pcs. / Pkt.
VARIOFACE output module, with eight miniature relays, plugged in, for 24 V DC (incl. relays)	87.6	VIP-8RPT-24DC/21/D0/FU/PLC	2903601	1

### VIP input modules

These VIP VARIOFACE input modules are used in combination with the respective front adapters. Like the front adapters, the modules are connected via 14-pos. system cables.

#### Features:

- Plug-in miniature relays, each with an N/O contact
- LED status display for each signal path and supply voltage
- Freewheeling diode for each signal path
- Push-in connection



Digital input module with 8 channels for 24 V DC



Digital input module with 8 channels for 120 V AC

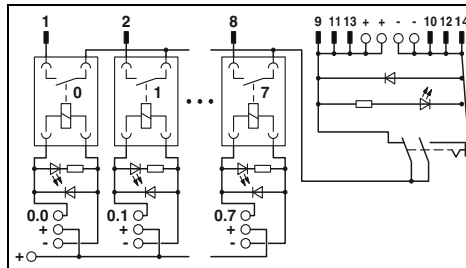

#### Technical data

Coil side	
Operating voltage $U_N$	24 V DC $\pm 10\%$ (supply, 2 A)
Typ. input current at $U_N$	9 mA (per channel)
Typ. response time at $U_N$	5 ms
Typ. release time at $U_N$	8 ms
Input circuit	Freewheeling diode
Status display/channel	Yellow LED
Connection method	Push-in connection
Connection data solid / stranded / AWG	0.14 ... 2.5 mm <sup>2</sup> / 0.14 ... 2.5 mm <sup>2</sup> / 26 - 14
Contact side	
Contact type	1 N/O contact
Contact material	AgSnO, hard gold-plated
Limiting continuous current	50 mA
Connection method	IDC/FLK pin strip (2.54 mm)
No. of pos.	14
General data	
Ambient temperature (operation)	-20 °C ... 60 °C
Nominal operating mode	100% operating factor
Mechanical service life	2 x 10 <sup>7</sup> cycles
Standards/regulations	DIN EN 50178
Mounting position	any
Mounting	Can be aligned without spacing
Dimensions	109.8 mm / 63 mm
EMC note	Class A product, see page 625

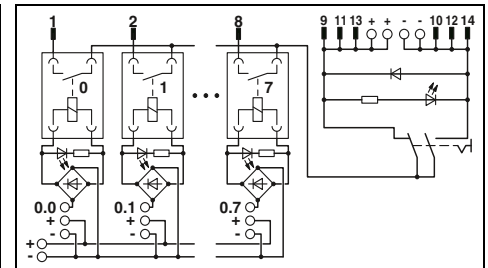

#### Technical data

Coil side	
Operating voltage $U_N$	120 V AC $\pm 10\%$ (supply, 2 A)
Typ. input current at $U_N$	3.5 mA (per channel)
Typ. response time at $U_N$	6 ms
Typ. release time at $U_N$	15 ms
Input circuit	Freewheeling diode
Status display/channel	Yellow LED
Connection method	Push-in connection
Connection data solid / stranded / AWG	0.14 ... 2.5 mm <sup>2</sup> / 0.14 ... 2.5 mm <sup>2</sup> / 26 - 26
Contact side	
Contact type	1 N/O contact
Contact material	AgSnO, hard gold-plated
Limiting continuous current	50 mA
Connection method	IDC/FLK pin strip (2.54 mm)
No. of pos.	14
General data	
Ambient temperature (operation)	-20 °C ... 60 °C
Nominal operating mode	100% operating factor
Mechanical service life	2 x 10 <sup>7</sup> cycles
Standards/regulations	DIN EN 50178
Mounting position	any
Mounting	Can be aligned without spacing
Dimensions	109.8 mm / 63 mm
EMC note	Class A product, see page 625

#### Ordering data

Description	Module width W
<b>VARIOFACE interface module</b> , for eight channels,	
24 V DC (incl. relays)	92.7
120 V AC (incl. relays)	92.7

Type	Order No.	Pcs. / Pkt.
VIP-8RPT-24DC/1AU/DI/PLC	2903600	1

#### Ordering data

Type	Order No.	Pcs. / Pkt.
VIP-8RPT-120AC/1AU/DI/PLC	2904576	1



# System cabling for controllers

## Controller-specific system cabling

### Adapters for PLC RELAY (6.2 mm)

**PLC-V8/...** are the VARIOFACE adapters connecting the eight slim 6.2 mm PLC-INTERFACE modules to the VARIOFACE system cabling:

- Can be plugged into the bridge shafts of eight aligned PLC RELAY modules
- Freely definable configuration with relays, optocouplers, and passive feed-through terminal blocks
- With D-SUB connection as an option for universal connections

#### Notes:

For cross-reference list with matching PLC-INTERFACE modules, see page 572

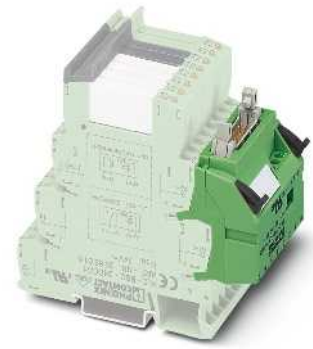

**VARIOFACE adapter for 6.2 mm PLC RELAY**



#### Technical data

Max. perm. operating voltage	30 V DC
Max. perm. current (per branch)	1 A (per signal path)
Max total current (voltage supply)	3 A
Ambient temperature (operation)	-40 °C ... 70 °C
Standards/regulations	IEC 60664, DIN EN 50178, IEC 62103
Connection method	Power supply Signal level Screw connection
Connection data solid / stranded / AWG	IDC/FLK pin strip (2.54 mm)
Dimensions	0.2 ... 4 mm <sup>2</sup> / 0.2 ... 2.5 mm <sup>2</sup> / 24 - 12 100 mm / 94 mm

#### Ordering data

Description	No. of pos.	Module width W	Type	Order No.	Pcs. / Pkt.
<b>V8 adapter</b> , for 8 PLC interfaces (6.2 mm), with FLK connection, for PLC system cabling, <b>positive switching</b>					
OUTPUT	14	49.6 mm	PLC-V8/FLK14/OUT	2295554	1
INPUT	14	49.6 mm	PLC-V8/FLK14/IN	2296553	1
<b>V8 adapter</b> , for 8 PLC interfaces (6.2 mm), with FLK connection, for PLC system cabling, <b>negative switching</b>					
OUTPUT	14	49.6 mm	PLC-V8/FLK14/OUT/M	2304102	1
INPUT	14	49.6 mm	PLC-V8/FLK14/IN/M	2304115	1
<b>V8 output adapter</b> , for 8 PLC interfaces (6.2 mm), with 15-pos. D-SUB connection					
Pin strip	15	49.6 mm	PLC-V8/D15S/OUT	2296058	1
Socket strip	15	49.6 mm	PLC-V8/D15B/OUT	2296061	1
<b>V8 input adapter</b> , for 8 PLC interfaces (6.2 mm), with 15-pos. D-SUB connection					
Pin strip	15	49.6 mm	PLC-V8/D15S/IN	2296074	1
Socket strip	15	49.6 mm	PLC-V8/D15B/IN	2296087	1

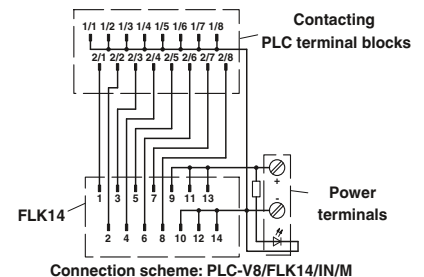
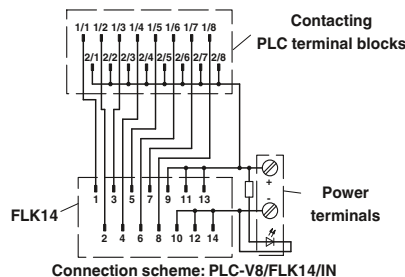
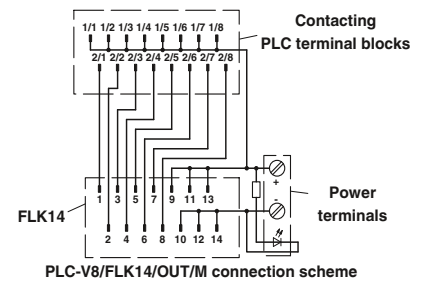
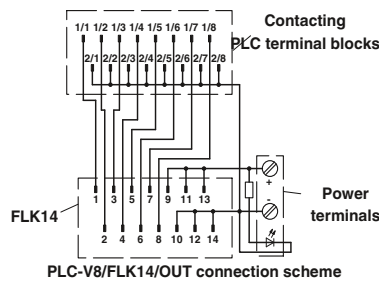



### Adapters for PLC RELAY (14 mm)

**Notes:**  
For cross-reference list with matching PLC-INTERFACE modules, see page 572

**PLC-V8L/...** are the VARIOFACE adapters connecting the eight 14 mm PLC-INTERFACE modules (2 PDT, HC, and IC types) to the system cabling:

- Can be plugged into the bridge shafts of eight aligned PLC RELAY modules
- Freely definable configuration with relays or optocouplers

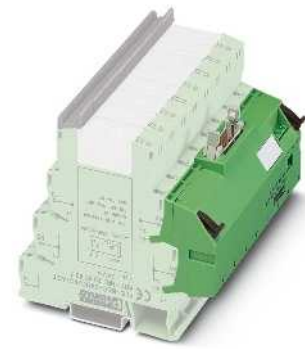

**VARIOFACE adapter for 14 mm PLC RELAY**



#### Technical data

Max. perm. operating voltage	30 V DC
Max. perm. current (per branch)	1 A (per signal path)
Max total current (voltage supply)	3 A
Ambient temperature (operation)	-40 °C ... 70 °C
Mounting position	any
Standards/regulations	IEC 60664, DIN EN 50178, IEC 62103
Connection method	Screw connection
	IDC/FLK pin strip (2.54 mm)
Connection data solid / stranded / AWG	0.2 ... 4 mm <sup>2</sup> / 0.2 ... 2.5 mm <sup>2</sup> / 24 - 12
Dimensions	100 mm / 94 mm

#### Ordering data

Description	No. of pos.	Module width W	Type	Order No.	Pcs. / Pkt.
<b>V8 adapter, for 8 PLC interfaces (14 mm), with FLK connection, for PLC system cabling, positive switching</b>	14	112.3 mm	PLC-V8L/FLK14/OUT	2299660	1
<b>V8 adapter, for 8 PLC interfaces (14 mm), with FLK connection, for PLC system cabling, negative switching</b>	14	112.3 mm	PLC-V8L/FLK14/OUT/M	2304306	1

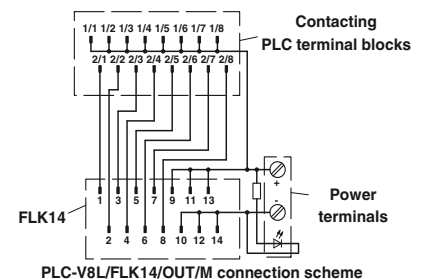
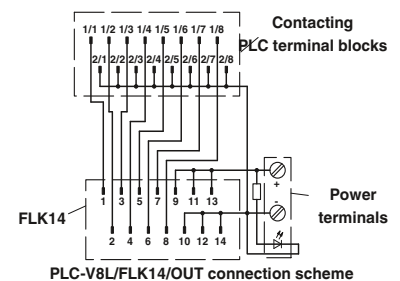

# System cabling for controllers

## Controller-specific system cabling

### Feed-through terminal blocks for PLC RELAY

The VARIOFACE PLC-VT terminals are passive feed-through terminal blocks, with the same shape as the 6.2 mm slim relays and PLC RELAY optocoupler interfaces. It is thus possible to implement 8-channel interface blocks for the system cabling, which can be adapted to the specific application with bit accuracy. For individual requirements, the relay, optocoupler or the PLC-VT terminal blocks for passive signal transmission can be combined as needed.

### PLC-VT PLC-VT/LA

- Can be combined with PLC RELAY universal series
- Signal path with additional potential level for free assignment (two-conductor connection)
- With LED as an option

### PLC-VT/ACT PLC-VT/ACT/LA

- Can be combined with PLC RELAY actuator series
  - Signal path with two additional potential levels for free assignment (three-conductor connection)
  - With LED as an option
- The system connection is made via the PLC-V8 adapter.

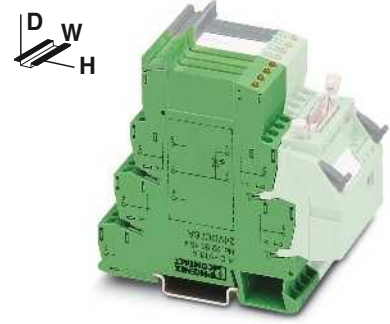

VARIOFACE feed-through terminal blocks for PLC-INTERFACE universal series



#### Technical data

PLC-VT, PLC-VT/ACT	PLC-VT/LA, PLC-VT/ACT/LA
250 V AC/DC	30 V DC
6 A (per signal conductor)	6 A (per signal conductor)
-40 °C ... 70 °C	-40 °C ... 70 °C
any	any
DIN EN 50178, IEC 60664, IEC 62103	
0.2 ... 4 mm <sup>2</sup> / 0.2 ... 2.5 mm <sup>2</sup> / 24 - 12	
80 mm / 94 mm	

#### Ordering data

Type	Order No.	Pcs. / Pkt.
PLC-VT	2296870	10
PLC-VT/LA	2296854	10
PLC-VT/ACT	2295567	10
PLC-VT/ACT/LA	2296867	10

Max. perm. operating voltage	
Max. perm. current (per branch)	
Ambient temperature (operation)	
Mounting position	
Standards/regulations	
Connection data solid / stranded / AWG	
Dimensions	H / D

Description	No. of pos.	Module width W
VARIOFACE feed-through terminal block (two-conductor connection), for PLC RELAY universal series		6.2 mm
VARIOFACE feed-through terminal block, as above, however, with 24 V DC light indicator		6.2 mm
VARIOFACE feed-through terminal block (three-conductor connection), for PLC-INTERFACE actuator series		6.2 mm
VARIOFACE feed-through terminal block, as above, however, with 24 V DC light indicator		6.2 mm



PLC-VT connection scheme

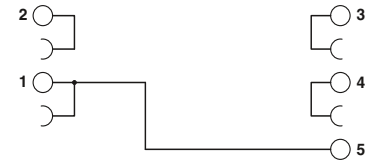

PLC-VT/ACT connection scheme

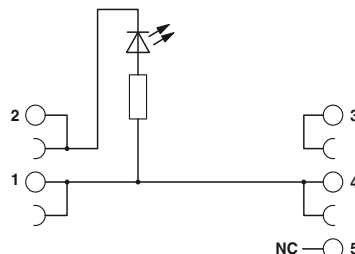

PLC-VT/LA connection scheme

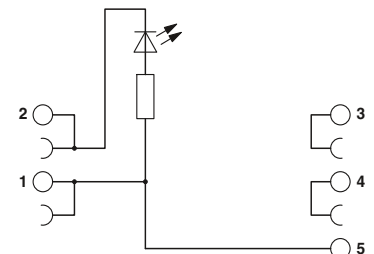

PLC-VT/ACT/LA connection scheme

### Adapter for RIFLINE complete RF-1

new

RIF-1-V8/... are the VARIOFACE adapters that connect the eight RIF-1 relay modules with the system cabling:

- Can be plugged into eight RIF-1 relay modules in series
- The adapter has one LED indicator and one freewheeling diode per relay

The following RIF-1 relay modules can be connected with the adapter:

- RIF-1-BPT/2X21, Order No. 2900931
- RIF-1-RPT-LDP-24DC/1X21, Order No. 2903342
- RIF-1-RPT-LDP-24DC/1X21 AU, Order No. AU 2903338
- RIF-1-RPT-LDP-24DC/2X21, Order No. 2903334
- RIF-1-RPT-LDP-24DC/2X21 AU, Order No. 2903330

If fully assembled RIF-1 relay modules are used, the indicator/interference suppression modules must be removed before installation.

Max. perm. operating voltage	30 V DC
Max. perm. current (per branch)	1 A (per signal path)
Max total current (voltage supply)	3 A
Ambient temperature (operation)	-40 °C ... 60 °C
Mounting position	any
Standards/regulations	IEC 60664, IEC 62103, DIN EN 50178
Connection method	Spring-cage connection
	IDC/FLK pin strip (2.54 mm)
Connection data solid / stranded / AWG	0.2 ... 1.5 mm <sup>2</sup> / 0.2 ... 1.5 mm <sup>2</sup> / 24 - 16
Dimensions	101 mm / 75 mm



#### Technical data

Power supply	30 V DC
Signal level	1 A (per signal path)
	3 A
	-40 °C ... 60 °C
	any
	IEC 60664, IEC 62103, DIN EN 50178
	Spring-cage connection
	IDC/FLK pin strip (2.54 mm)
	0.2 ... 1.5 mm <sup>2</sup> / 0.2 ... 1.5 mm <sup>2</sup> / 24 - 16
	101 mm / 75 mm

#### Ordering data

Description	No. of pos.	Module width W
<b>V8 adapter</b> , for eight RIF-1 relay modules, with FLK connection for PLC system cabling, <b>positive switching</b>		128 mm

Type	Order No.	Pcs. / Pkt.
<b>RIF-1-V8/PT/FLK14/OUT</b>	<b>2905195</b>	1



**VARIOFACE adapter for RIFLINE complete RIF-1**

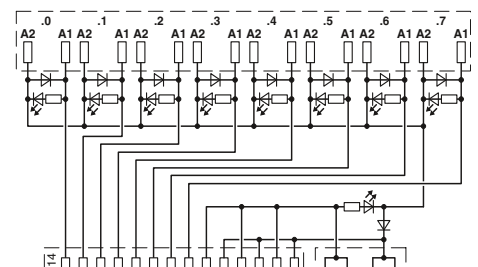

### Cross-reference list for PLC-V8 adapters with matching PLC-INTERFACE modules

Series



Function	Contact	Input	Output	Page	Spring-cage connection	Order No.	
Relay	1 PDT	24 V DC	250 V AC/DC/ 6 A	400	PLC-RSP-24DC/21	2966472	
		24 V DC	250 V AC/DC/10 A	411	PLC-RSP-24DC/21HC	2912277	
		12 V DC	30 V AC/36 V DC/50 mA	401	PLC-RSP-12DC/21AU	2967442	
		24 V DC	30 V AC/36 V DC/50 mA	401	PLC-RSP-24DC/21AU	2966540	
		24 V AC/DC	30 V AC/36 V DC/50 mA	401	PLC-RSP-24UC/21AU	2966553	
		48 V DC	30 V AC/36 V DC/50 mA	401	PLC-RSP-48DC/21AU	2966566	
		60 V DC	30 V AC/36 V DC/50 mA	401	PLC-RSP-60DC/21AU	2966579	
		120 V AC/DC	30 V AC/36 V DC/50 mA	401	PLC-RSP-120UC/21AU	2966582	
		230 V AC/DC	30 V AC/36 V DC/50 mA	401	PLC-RSP-230UC/21AU	2966647	
		120 V AC	30 V AC/36 V DC/50 mA <sup>1)</sup>	414	PLC-BSP-120UC/21/SO46	2980351 <sup>3)</sup>	
	230 V AC	30 V AC/36 V DC/50 mA <sup>1)</sup>	414	PLC-BSP-230UC/21/SO46	2980377 <sup>3)</sup>		
	Relay switch	2 PDTs	24 V DC	250 V AC/DC/ 6 A	401	PLC-RSP-24DC/21-21	2912507
			24 V DC	30 V AC/DC/50 mA	401	PLC-RSP-24DC/21-21AU	2912578
	Relay switch	1 N/O contact	24 V AC/DC	250 V AC/DC/ 6 A	430	PLC-RSP-24UC/1/S/H	2982249
24 V AC/DC			250 V AC/DC/ 6 A	430	PLC-RSP-24UC/1/S/L	2834889	
Optocoupler	1 N/O contact, electronic	24 V DC	24 V DC/ 3 A	403	PLC-OSP-24DC/24DC/2	2967471	
		24 V DC	24 V DC/10 A	433	PLC-OSP-24DC/24DC/10/R	2982715	
		24 V DC	250 V AC/0.75 A	403	PLC-OSP-24DC/230AC/1	2967895	
		24 V DC	300 V DC/1 A	432	PLC-OSP-24DC/300DC/1	2980830	
		24 V DC	48 V DC/100 mA	402	PLC-OSP-24DC/48DC/100	2967549	
		48 V DC	48 V DC/100 mA	402	PLC-OSP-48DC/48DC/100	2967743	
		60 V DC	48 V DC/100 mA	402	PLC-OSP-60DC/48DC/100	2967756	
		120 V AC/DC	48 V DC/100 mA	402	PLC-OSP-120UC/48DC/100	2967552	
		230 V AC/DC	48 V DC/100 mA	402	PLC-OSP-230UC/48DC/100	2967565	
		NAMUR	24 V DC/50 mA	446	PLC-SP-EIK 1-SVN 24P/P	2982676	
	120 V AC	48 V DC/100 mA <sup>2)</sup>	414	PLC-BSP-120UC/21/SO46	2980351 <sup>3)</sup>		
	230 V AC	48 V DC/100 mA <sup>2)</sup>	414	PLC-BSP-230UC/21/SO46	2980377 <sup>3)</sup>		
	1 PDT, electronic	24 V DC	48 V DC/0.5 A	433	PLC-OSP-24DC/48DC/500/W	2980649	
	Feed-through	-	250 V AC/DC	250 V AC/DC	570	-	-
24 V DC			24 V DC	570	-	-	
Relay	1 N/O contact	24 V DC	250 V AC/DC/6 A	404	PLC-RSP-24DC/1/ACT	2967345	
		24 V DC	250 V AC/DC/10 A (80 A; 20 ms)	410	PLC-RSP-24DC/11C/ACT	2912413	
	2 N/O contacts	24 V DC	250 V AC/DC/6 A	405	-	-	
		24 V DC	24 V DC/3 A	405	PLC-OSP-24DC/24DC/2/ACT	2967507	
	Optocoupler	1 N/O contact, electronic	24 V DC	24 V DC/5 A	406	-	-
			24 V DC	250 V AC/0.75 A	405	-	-
			24 V DC	250 V AC/2 A	406	-	-
	Feed-through	-	250 V AC/DC	250 V AC/DC	570	-	-
24 V DC			24 V DC	570	-	-	
Relay	1 N/O contact	24 V DC	30 V AC/36 V DC/50 mA	408	PLC-RSP-24DC/1AU/SEN	2967374	
		120 V AC/DC	30 V AC/36 V DC/50 mA	408	PLC-RSP-120UC/1AU/SEN	2967390	
		230 V AC/DC	30 V AC/36 V DC/50 mA	408	PLC-RSP-230UC/1AU/SEN	2967413	
		120 V AC	30 V AC/36 V DC/50 mA <sup>1)</sup>	415	PLC-BSP-120UC/1/SEN/SO46	2980364 <sup>3)</sup>	
		230 V AC	30 V AC/36 V DC/50 mA <sup>1)</sup>	415	PLC-BSP-230UC/1/SEN/SO46	2980380 <sup>3)</sup>	
	Optocoupler	1 N/O contact, electronic	24 V DC	48 V DC/100 mA	409	PLC-OSP-24DC/48DC/100/SEN	2967578
			120 V AC/DC	48 V DC/100 mA	409	PLC-OSP-120UC/48DC/100/SEN	2967581
			230 V AC/DC	48 V DC/100 mA	409	PLC-OSP-230UC/48DC/100/SEN	2967594
			120 V AC	48 V DC/100 mA <sup>2)</sup>	415	PLC-BSP-120UC/1/SEN/SO46	2980364 <sup>3)</sup>
			230 V AC	48 V DC/100 mA <sup>2)</sup>	415	PLC-BSP-230UC/1/SEN/SO46	2980380 <sup>3)</sup>

1) Plug-in miniature relay insert: REL-MR-60DC/21AU, 2961134  
 2) Plug-in solid-state relay insert: OPT-60DC/48DC/100, 2966621  
 3) PLC-...SO46 is supplied as a basic terminal block with filter, but without relay or solid-state relay.  
 4) Cannot be combined with the universal series (within a byte)



Push-in connection



Screw connection

	Order No.		Order No.	PLC-V8...OUT(M)	PLC-V8...IN(M)	PLC-V8L...OUT
PLC-RPT-24DC/21	2900299	PLC-RSC-24DC/21	2966171	X		
PLC-RPT-24DC/21HC	2900291	PLC-RSC-24DC/21HC	2967620			X
PLC-RPT-12DC/21AU	2900317	PLC-RSC-12DC/21AU	2966919		X	
PLC-RPT-24DC/21AU	2900306	PLC-RSC-24DC/21AU	2966265	X	X	
PLC-RPT-24UC/21AU	2900307	PLC-RSC-24UC/21AU	2966278	X	X	
PLC-RPT-48DC/21AU	2900308	PLC-RSC-48DC/21AU	2966126		X	
PLC-RPT-60DC/21AU	2900309	PLC-RSC-60DC/21AU	2966142		X	
PLC-RPT-120UC/21AU	2900310	PLC-RSC-120UC/21AU	2966281		X	
PLC-RPT-230UC/21AU	2900311	PLC-RSC-230UC/21AU	2966294		X	
PLC-RPT-120UC/21/SO46	2900453 <sup>3)</sup>	PLC-BSC-120UC/21/SO46	2980319 <sup>3)</sup>		X	
PLC-RPT-230UC/21/SO46	2900455 <sup>3)</sup>	PLC-BSC-230UC/21/SO46	2980335 <sup>3)</sup>		X	
PLC-RPT-24DC/21-21	2900330	PLC-RSC-24DC/21-21	2967060			X
PLC-RPT-24DC/21-21AU	2900338	PLC-RSC-24DC/21-21AU	2967125			X
PLC-RPT-24UC/1/S/H	2900328	PLC-RSC-24UC/1/S/H	2982236	X		
PLC-RPT-24UC/1/S/L	2900327	PLC-RSC-24UC/1/S/L	2834876	X		

PLC-OPT-24DC/24DC/2	2900364	PLC-OSC-24DC/24DC/2	2966634	X		
PLC-OPT-24DC/24DC/10/R	2900398	PLC-OSC-24DC/24DC/10/R	2982702	X		
PLC-OPT-24DC/230AC/1	2900369	PLC-OSC-24DC/230AC/1	2967840	X		
PLC-OPT-24DC/300DC/1	2900383	PLC-OSC-24DC/300DC/1	2980678	X		
PLC-OPT-24DC/48DC/100	2900352	PLC-OSC-24DC/48DC/100	2966728	X	X	
PLC-OPT-48DC/48DC/100	2900353	PLC-OSC-48DC/48DC/100	2966993		X	
PLC-OPT-60DC/48DC/100	2900354	PLC-OSC-60DC/48DC/100	2967455		X	
PLC-OPT-120UC/48DC/100	2900355	PLC-OSC-120UC/48DC/100	2966744		X	
PLC-OPT-230UC/48DC/100	2900356	PLC-OSC-230UC/48DC/100	2966757		X	
PLC-PT-EIK 1-SVN 24P/P	2900397	PLC-SC-EIK 1-SVN 24P/P	2982663		X	
PLC-BPT-120UC/21/SO46	2900453 <sup>3)</sup>	PLC-BSC-120UC/21/SO46	2980319 <sup>3)</sup>		X	
PLC-BPT-230UC/21/SO46	2900455 <sup>3)</sup>	PLC-BSC-230UC/21/SO46	2980335 <sup>3)</sup>		X	
PLC-OPT-24DC/48DC/500/W	2900378	PLC-OSC-24DC/48DC/500/W	2980636	X		

-		PLC-VT	2296870	X	X	
-		PLC-VT/LA	2296854	X	X	

PLC-RPT-24DC/1/ACT	2900312	PLC-RSC-24DC/1/ACT	2966210	X		
PLC-RPT-24DC/11C/ACT	2900298	PLC-RSC-24DC/11C/ACT	2967604			X
-		PLC-RSC-24DC/1-1/ACT	2967109			X
PLC-OPT-24DC/24DC/2/ACT	2900376	PLC-OSC-24DC/24DC/2/ACT	2966676	X		
-		PLC-OSC-24DC/24DC/5/ACT	2982786			X
-		PLC-OSC-24DC/230AC/1/ACT	2967947	X		
-		PLC-OSC-24DC/230AC/2/ACT	2982760			X
-		PLC-VT/AKT	2295567	X		
-		PLC-VT/AKT/LA	2296867	X		

PLC-RPT-24DC/1AU/SEN	2900313	PLC-RSC-24DC/1AU/SEN	2966317		X	
PLC-RPT-120UC/1AU/SEN	2900314	PLC-RSC-120UC/1AU/SEN	2966320		X	
PLC-RPT-230UC/1AU/SEN	2900315	PLC-RSC-230UC/1AU/SEN	2966333		X	
PLC-BPT-120UC/1/SEN/SO46	2900456 <sup>3)</sup>	PLC-BSC-120UC/1/SEN/SO46	2980322 <sup>3)</sup>		X	
PLC-BPT-230UC/1/SEN/SO46	2900457 <sup>3)</sup>	PLC-BSC-230UC/1/SEN/SO46	2980348 <sup>3)</sup>		X	
PLC-OPT-24DC/48DC/100/SEN	2900358	PLC-OSC-24DC/48DC/100/SEN	2966773		X	
PLC-OPT-120UC/48DC/100/SEN	2900359	PLC-OSC-120UC/48DC/100/SEN	2966799		X	
PLC-OPT-230UC/48DC/100/SEN	2900361	PLC-OSC-230UC/48DC/100/SEN	2966809		X	
PLC-BPT-120UC/1/SEN/SO46	2900456 <sup>3)</sup>	PLC-BSC-120UC/1/SEN/SO46	2980322 <sup>3)</sup>		X	
PLC-BPT-230UC/1/SEN/SO46	2900457 <sup>3)</sup>	PLC-BSC-230UC/1/SEN/SO46	2980348 <sup>3)</sup>		X	

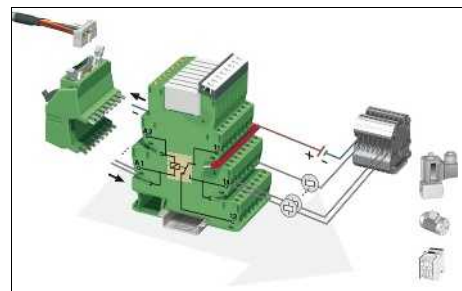

### PLC universal series

The universal series of products can be used as either input or output interfaces. Each product consists of a basic terminal block with a plug-in miniature relay (PDT) or a plug-in solid-state relay.

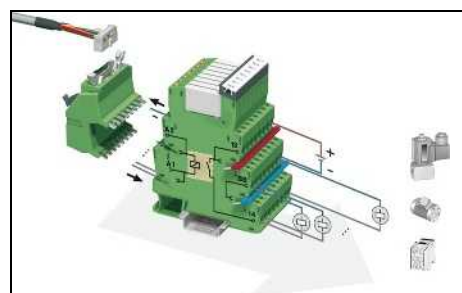

### PLC actuator series

When used as an interface between the PLC and actuators, such as motors, contactors or solenoid valves, only one N/O contact function is normally required. In such cases, the PLC...ACT output interface is used. All actuator connections, including the load return line, are connected directly. This eliminates the need for additional output terminal blocks.

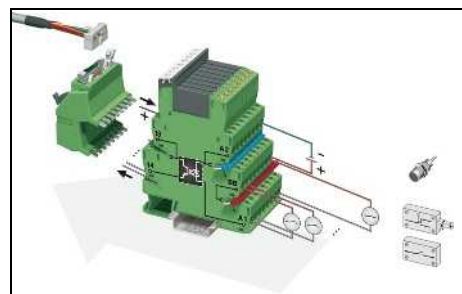

### PLC sensor series

When used as an interface between the PLC and sensors, such as proximity switches, limit switches or auxiliary contacts, only one N/O contact function is normally required. In such cases, the PLC...SEN input interface is used. All sensor connections, including the supply voltage for the sensors/switches, are connected directly. This eliminates the need for additional terminal blocks.

# System cabling for controllers

## Controller-specific system cabling

### System cable with flat-ribbon cable connector

- 1:1 connection
- 14 and 50-pos.
- Connectors as per IEC 60603-13
- Unshielded
- Shielded
- Halogen-free see page 605
- Special lengths see page 609



Unshielded



Shield connection at one end



ERC

Applied for: cUL / UL

	Technical data	Technical data
Max. perm. operating voltage	< 50 V AC / 60 V DC	< 50 V AC / 60 V DC
Max. perm. current carrying capacity per path	1 A	1 A
Max. conductor resistance	0.16 Ω/m	0.16 Ω/m
Ambient temperature (operation)	-20 °C ... 50 °C	-20 °C ... 50 °C
Shield	-	Tinned copper-braided shield, approx. 85% covering
Assembly	Insulation displacement, IEC 60352-4/DIN EN 60352-4	Insulation displacement, IEC 60352-4/DIN EN 60352-4
Conductor cross section	AWG 26 / 0.14 mm <sup>2</sup>	AWG 26 / 0.14 mm <sup>2</sup>
Conductor structure: stranded wires / material	7 / Cu tin-plated	7 / Cu tin-plated
Outside diameter		
	14-position: 6.4 mm	6.7 mm
	50-position: 10.3 mm	11 mm

			Ordering data			Ordering data		
Description	No. of pos.	Cable length	Type	Order No.	Pcs. / Pkt.	Type	Order No.	Pcs. / Pkt.
<b>Assembled round cable, with two 14-pos. socket strips in fixed lengths for transfer of 8 channels</b>								
	14	0.3 m	FLK 14/EZ-DR/ 30/KONFEK	2295729	5			
	14	0.5 m	FLK 14/EZ-DR/ 50/KONFEK	2288901	5	FLK 14/EZ-DR/ 50/KONFEK/S	2296977	1
	14	1 m	FLK 14/EZ-DR/ 100/KONFEK	2288914	1	FLK 14/EZ-DR/ 100/KONFEK/S	2296980	1
	14	1.5 m	FLK 14/EZ-DR/ 150/KONFEK	2288927	1	FLK 14/EZ-DR/ 150/KONFEK/S	2296993	1
	14	2 m	FLK 14/EZ-DR/ 200/KONFEK	2288930	1	FLK 14/EZ-DR/ 200/KONFEK/S	2297002	1
	14	2.5 m	FLK 14/EZ-DR/ 250/KONFEK	2288943	1			
	14	3 m	FLK 14/EZ-DR/ 300/KONFEK	2288956	1	FLK 14/EZ-DR/ 300/KONFEK/S	2299013	1
	14	3.5 m	FLK 14/EZ-DR/ 350/KONFEK	2288969	1			
	14	4 m	FLK 14/EZ-DR/ 400/KONFEK	2288972	1	FLK 14/EZ-DR/ 400/KONFEK/S	2299026	1
	14	4.5 m	FLK 14/EZ-DR/ 450/KONFEK	2290847	1			
	14	5 m	FLK 14/EZ-DR/ 500/KONFEK	2290834	1			
	14	5.5 m	FLK 14/EZ-DR/ 550/KONFEK	2290850	1			
	14	6 m	FLK 14/EZ-DR/ 600/KONFEK	2290863	1	FLK 14/EZ-DR/ 600/KONFEK/S	2299039	1
	14	8 m	FLK 14/EZ-DR/ 800/KONFEK	2299563	1	FLK 14/EZ-DR/ 800/KONFEK/S	2299042	1
	14	10 m	FLK 14/EZ-DR/1000/KONFEK	2299576	1	FLK 14/EZ-DR/1000/KONFEK/S	2299055	1
<b>Assembled round cable, with two 50-pos. socket strips in fixed lengths for transfer of 32 channels</b>								
	50	0.5 m	FLK 50/EZ-DR/ 50/KONFEK	2289065	5	FLK 50/EZ-DR/ 50/KONFEK/S	2299097	1
	50	1 m	FLK 50/EZ-DR/ 100/KONFEK	2289078	1	FLK 50/EZ-DR/ 100/KONFEK/S	2299107	1
	50	1.5 m	FLK 50/EZ-DR/ 150/KONFEK	2289081	1	FLK 50/EZ-DR/ 150/KONFEK/S	2299110	1
	50	2 m	FLK 50/EZ-DR/ 200/KONFEK	2289094	1	FLK 50/EZ-DR/ 200/KONFEK/S	2299123	1
	50	2.5 m	FLK 50/EZ-DR/ 250/KONFEK	2289104	1			
	50	3 m	FLK 50/EZ-DR/ 300/KONFEK	2289117	1	FLK 50/EZ-DR/ 300/KONFEK/S	2299136	1
	50	3.5 m	FLK 50/EZ-DR/ 350/KONFEK	2289120	1			
	50	4 m	FLK 50/EZ-DR/ 400/KONFEK	2289133	1	FLK 50/EZ-DR/ 400/KONFEK/S	2299149	1
	50	4.5 m	FLK 50/EZ-DR/ 450/KONFEK	2289573	1			
	50	5 m	FLK 50/EZ-DR/ 500/KONFEK	2289586	1			
	50	5.5 m	FLK 50/EZ-DR/ 550/KONFEK	2289599	1			
	50	6 m	FLK 50/EZ-DR/ 600/KONFEK	2289609	1	FLK 50/EZ-DR/ 600/KONFEK/S	2299152	1
	50	6.5 m	FLK 50/EZ-DR/ 650/KONFEK	2289612	1			
	50	7 m	FLK 50/EZ-DR/ 700/KONFEK	2289625	1			
	50	7.5 m	FLK 50/EZ-DR/ 750/KONFEK	2289638	1			
	50	8 m	FLK 50/EZ-DR/ 800/KONFEK	2289641	1	FLK 50/EZ-DR/ 800/KONFEK/S	2299165	1
	50	8.5 m	FLK 50/EZ-DR/ 850/KONFEK	2289654	1			
	50	9 m	FLK 50/EZ-DR/ 900/KONFEK	2289667	1			
	50	9.5 m	FLK 50/EZ-DR/ 950/KONFEK	2289670	1			
	50	10 m	FLK 50/EZ-DR/1000/KONFEK	2289683	1	FLK 50/EZ-DR/1000/KONFEK/S	2299178	1



### Splitting cable with flat-ribbon cable connector

- Splitting of 32 channels to 4 x 8 channels
- 50-pos. connector at one end
- 4 x 14-pos. connector at one end
- Connectors as per IEC 60603-13
- Unshielded
- Shielded
- Special lengths



**Splitting cable unshielded**  
50 positions on 4 x 14



**Splitting cable shielded**  
50 positions on 4 x 14

ERAC

#### Technical data

Max. perm. operating voltage  
Max. perm. current carrying capacity per path  
Max. conductor resistance  
Ambient temperature (operation)  
Shield

< 50 V AC / 60 V DC  
1 A  
0.16 Ω/m  
-20 °C ... 50 °C  
-

Assembly

Insulation displacement, IEC 60352-4/DIN EN 60352-4

Conductor cross section  
Conductor structure: stranded wires / material  
Number of plugs on the module side  
Outside diameter

AWG 26 / 0.14 mm<sup>2</sup>  
7 / Cu tin-plated  
4

50-position

6.3 mm

#### Ordering data

Description	No. of pos.	Cable length
<b>Assembled round cable</b> , with a 50-pos. socket strip and four 14-pos. socket strips, for splitting 32 channels into 4 x 8 channels.		
	50	0.5 m
	50	1 m
	50	1.5 m
	50	2 m
	50	2.5 m
	50	3 m
	50	4 m
	50	6 m
	50	8 m
	50	10 m
<b>Assembled round cable</b> , as above, however in variable lengths		
	50	
<b>Assembled round cable</b> , as above, however shielded and in variable lengths		
	50	

Type	Order No.	Pcs. / Pkt.
FLK 50/4X14/EZ-DR/ 50/KONFEK	2296689	1
FLK 50/4X14/EZ-DR/ 100/KONFEK	2296692	1
FLK 50/4X14/EZ-DR/ 150/KONFEK	2296702	1
FLK 50/4X14/EZ-DR/ 200/KONFEK	2296715	1
FLK 50/4X14/EZ-DR/ 250/KONFEK	2305402	1
FLK 50/4X14/EZ-DR/ 300/KONFEK	2296728	1
FLK 50/4X14/EZ-DR/ 400/KONFEK	2296731	1
FLK 50/4X14/EZ-DR/ 600/KONFEK	2296744	1
FLK 50/4X14/EZ-DR/ 800/KONFEK	2296757	1
FLK 50/4X14/EZ-DR/1000/KONFEK	2296773	1
FLK 50-4X14-EZ-DR ...	2302405	1

ERIC

#### Technical data

< 50 V AC / 60 V DC  
1 A  
0.16 Ω/m  
-20 °C ... 50 °C  
Tinned copper-braided shield, approx. 85% covering

Insulation displacement, IEC 60352-4/DIN EN 60352-4

AWG 26 / 0.14 mm<sup>2</sup>  
7 / Cu tin-plated  
4

6.3 mm

#### Ordering data

Type	Order No.	Pcs. / Pkt.
FLK 50-4X14-EZ-DR-S ...	2302447	1

### Ordering example for system cable:

– Unshielded splitting cable 12.75 m long

Quantity	Order No.	Length [m] <sup>1)</sup>
1	2302405	12.75

<sup>1)</sup> min. 0.30 m

– Shielded splitting cable 11.00 m long

Quantity	Order No.	Length [m] <sup>1)</sup>
1	2302447	11.00

<sup>1)</sup> min. 0.30 m



## Universal modules

### VIP – VARIOFACE Professional modules with flat-ribbon cable connectors

- 1:1 connection
  - 10 to 64-pos.
  - Screw connection
  - Metal foot
  - As per IEC 60603-13
  - With status indicator as an option
- Low and high engagement latches are supplied with all modules.

#### Notes:

For marking systems (e.g., "ZB 22:UNBEDRUCKT"; Order No. 0811862) and mounting material, see Catalog 5.



10 to 20 positions with screw connection



#### Technical data

Operating voltage	60 V AC/DC
Max. perm. current (per branch)	1 A
Ambient temperature (operation)	-20 °C ... 50 °C
Mounting position	any
Standards/regulations	IEC 60664, DIN EN 50178, IEC 62103
Connection data solid / stranded / AWG	0.2 - 4 mm <sup>2</sup> / 0.2 - 2.5 mm <sup>2</sup> / 24 - 12
Dimensions	H / D 65.5 mm / 56 mm

#### Ordering data

Description	No. of pos.	Module width W	Type	Order No.	Pcs. / Pkt.
<b>VARIOFACE module, with pin strip</b>	10	34.70	VIP-2/SC/FLK10	2315010	1
	14	39.80	VIP-2/SC/FLK14	2315023	1
	16	45.00	VIP-2/SC/FLK16	2315036	1
	20	55.10	VIP-2/SC/FLK20	2315049	1
<b>VARIOFACE module, with pin strip and light indicator</b>	10	34.70			
	14	44.90			
	16	50.00			
	20	60.20			
<b>VARIOFACE module, with pin strip</b>	26	57.10			
	34	67.30			
	40	77.40			
	50	92.70			
	60	108.00			
	64	118.00			
<b>VARIOFACE module, with pin strip and light indicator</b>	26	57.40			
	34	67.60			
	40	77.80			
	50	93.10			
	60	113.50			
	64	118.60			

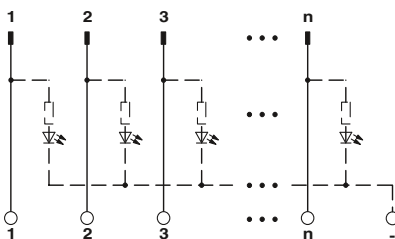



10 to 20 positions  
with screw connection and light indicator

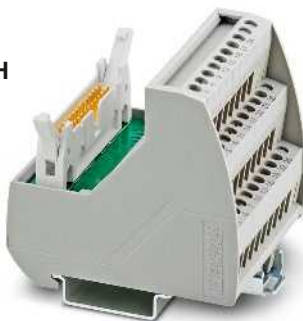

26 to 64 positions  
with screw connection



26 to 64 positions  
with screw connection and light indicator



**Technical data**

24 V DC  
1 A  
-20 °C ... 50 °C  
any  
IEC 60664, DIN EN 50178, IEC 62103  
0.2 - 4 mm<sup>2</sup> / 0.2 - 2.5 mm<sup>2</sup> / 24 - 12  
65.5 mm / 56 mm

**Technical data**

60 V AC/DC  
1 A  
-20 °C ... 50 °C  
any  
IEC 60664, DIN EN 50178, IEC 62103  
0.2 - 4 mm<sup>2</sup> / 0.2 - 2.5 mm<sup>2</sup> / 24 - 12  
69 mm / 62 mm

**Technical data**

24 V DC  
1 A  
-20 °C ... 50 °C  
any  
IEC 60664, DIN EN 50178, IEC 62103  
0.2 - 4 mm<sup>2</sup> / 0.2 - 2.5 mm<sup>2</sup> / 24 - 12  
69 mm / 62 mm

**Ordering data**

Type	Order No.	Pcs. / Pkt.
VIP-2/SC/FLK10/LED	2322045	1
VIP-2/SC/FLK14/LED	2322058	1
VIP-2/SC/FLK16/LED	2322061	1
VIP-2/SC/FLK20/LED	2322074	1

**Ordering data**

Type	Order No.	Pcs. / Pkt.
VIP-3/SC/FLK26	2315052	1
VIP-3/SC/FLK34	2315065	1
VIP-3/SC/FLK40	2315078	1
VIP-3/SC/FLK50	2315081	1
VIP-3/SC/FLK60	2315094	1
VIP-3/SC/FLK64	2315104	1

**Ordering data**

Type	Order No.	Pcs. / Pkt.
VIP-3/SC/FLK26/LED	2322087	1
VIP-3/SC/FLK34/LED	2322090	1
VIP-3/SC/FLK40/LED	2322100	1
VIP-3/SC/FLK50/LED	2322113	1
VIP-3/SC/FLK60/LED	2322126	1
VIP-3/SC/FLK64/LED	2322139	1

# System cabling for controllers

## Universal modules

### VIP – VARIOFACE Professional modules with flat-ribbon cable connectors

- 1:1 connection
  - 10 to 64-pos.
  - Push-in connection
  - Metal foot
  - As per IEC 60603-13
  - With status indicator as an option
- Low and high engagement latches are supplied with all modules.

#### Notes:

For marking systems (e.g., "ZB 22:UNBEDRUCKT"; Order No. 0811862) and mounting material, see Catalog 5.



10 to 20 positions with push-in connection



#### Technical data

Operating voltage	60 V AC/DC
Max. perm. current (per branch)	1 A
Ambient temperature (operation)	-20 °C ... 50 °C
Mounting position	any
Standards/regulations	IEC 60664, DIN EN 50178, IEC 62103
Connection data solid / stranded / AWG	0.14 - 2.5 mm <sup>2</sup> / 0.14 - 2.5 mm <sup>2</sup> / 26 - 14
Dimensions	H / D 72.1 mm / 56 mm

#### Ordering data

Description	No. of pos.	Module width W	Type	Order No.	Pcs. / Pkt.
<b>VARIOFACE module, with pin strip</b>	10	36.80	VIP-2/PT/FLK10	2903787	1
	14	41.90	VIP-2/PT/FLK14	2903788	1
	16	46.90	VIP-2/PT/FLK16	2903789	1
	20	57.10	VIP-2/PT/FLK20	2903790	1
<b>VARIOFACE module, with pin strip and light indicator</b>	10	36.80			
	14	41.90			
	16	46.90			
	20	57.10			
<b>VARIOFACE module, with pin strip</b>	26	57.10			
	34	67.30			
	40	77.40			
	50	92.70			
	60	107.90			
	64	118.10			
<b>VARIOFACE module, with pin strip and light indicator</b>	26	57.10			
	34	67.30			
	40	77.40			
	50	92.70			
	60	107.90			
	64	118.10			

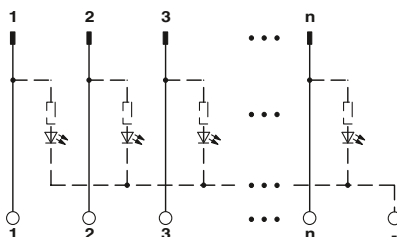



10 to 20 positions  
with push-in connection and light indicator

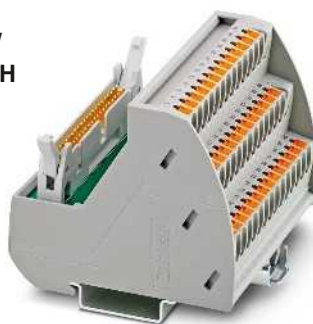

26 to 64 positions  
with push-in connection

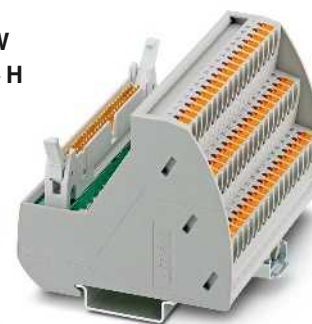

26 to 64 positions  
with push-in connection and light indicator



Technical data
24 V DC
1 A
-20 °C ... 50 °C
any
IEC 60664, DIN EN 50178, IEC 62103
0.14 - 2.5 mm <sup>2</sup> / 0.14 - 2.5 mm <sup>2</sup> / 26 - 14
72.1 mm / 56 mm

Technical data
60 V AC/DC
1 A
-20 °C ... 50 °C
any
IEC 60664, DIN EN 50178, IEC 62103
0.14 - 2.5 mm <sup>2</sup> / 0.14 - 2.5 mm <sup>2</sup> / 26 - 14
75.8 mm / 63 mm

Technical data
24 V DC
1 A
-20 °C ... 50 °C
any
IEC 60664, DIN EN 50178, IEC 62103
0.14 - 2.5 mm <sup>2</sup> / 0.14 - 2.5 mm <sup>2</sup> / 26 - 14
75.8 mm / 63 mm

Ordering data
---------------

Ordering data
---------------

Ordering data
---------------

Type	Order No.	Pcs. / Pkt.
VIP-2/PT/FLK10/LED	2904248	1
VIP-2/PT/FLK14/LED	2904249	1
VIP-2/PT/FLK16/LED	2904250	1
VIP-2/PT/FLK20/LED	2904251	1

Type	Order No.	Pcs. / Pkt.
VIP-3/PT/FLK26	2903791	1
VIP-3/PT/FLK34	2903792	1
VIP-3/PT/FLK40	2903793	1
VIP-3/PT/FLK50	2903794	1
VIP-3/PT/FLK60	2903795	1
VIP-3/PT/FLK64	2903796	1

Type	Order No.	Pcs. / Pkt.
VIP-3/PT/FLK26/LED	2904252	1
VIP-3/PT/FLK34/LED	2904253	1
VIP-3/PT/FLK40/LED	2904254	1
VIP-3/PT/FLK50/LED	2904255	1
VIP-3/PT/FLK60/LED	2904256	1
VIP-3/PT/FLK64/LED	2904257	1

# System cabling for controllers

## Universal modules

### SLIM-LINE modules for flat-ribbon cable connectors

VARIOFACE SLIM-LINE modules connect flat-ribbon cable connectors in accordance with IEC 60603-13/DIN 41651 to front connection terminal blocks.

The modules are provided with low and high engagement catches to protect the flat-ribbon cable connector against being accidentally released.



**20 and 26-pos.  
With screw connection**

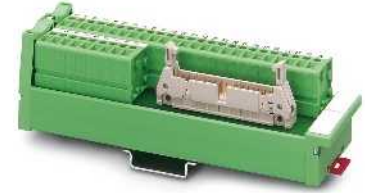

**34 to 50 positions  
With screw connection**

Operating voltage  
Max. perm. current (per branch)  
  
Ambient temperature (operation)  
Mounting position  
Standards/regulations  
Screw connection solid / stranded / AWG  
Dimensions

D / W

ERC

#### Technical data

< 50 V AC / 60 V DC  
0.8 A (data valid for 100% simultaneity factor)  
  
-10 °C ... 50 °C  
any  
DIN EN 50178, IEC 60664, IEC 62103  
0.2 ... 4 mm<sup>2</sup> / 0.2 ... 2.5 mm<sup>2</sup> / 24 - 12  
45 mm / 25 mm

#### Ordering data

Description	No. of pos.	Module height H
<b>VARIOFACE SLIM-LINE module, with pin strip</b>	20	177.00
	26	217.00
<b>VARIOFACE SLIM-LINE module, with pin strip</b>	34	147.00
	40	167.00
	50	197.00

ERC

#### Technical data

< 50 V AC / 60 V DC  
1 A (data valid for 100% simultaneity factor)  
  
-10 °C ... 50 °C  
any  
DIN EN 50178, IEC 60664, IEC 62103  
0.2 ... 4 mm<sup>2</sup> / 0.2 ... 2.5 mm<sup>2</sup> / 24 - 12  
45 mm / 45 mm

#### Ordering data

Type	Order No.	Pcs. / Pkt.
UM 25-FLK20/FRONT/Q	2959515	1
UM-25 FLK26/FRONT/Q	2959528	1

Type	Order No.	Pcs. / Pkt.
UM 45-FLK34/FRONT/Q	2959531	1
UM 45-FLK40/FRONT/Q	2959544	1
UM 45-FLK50/FRONT/Q	2959557	1



# System cabling for controllers

## Universal modules

### Feed-through modules for IDC/FLK connectors (pitch 2.54 mm) with screw connection

VARIOFACE DFLK... feed-through modules connect the flat-ribbon cable connectors in accordance with IEC 60603-13/DIN 41651 to the screw connection terminal blocks.

These modules are suitable for mounting on a side panel with an appropriate housing cutout (see dimensioning table).

The modules are provided with low and high engagement catches to protect the flat-ribbon cable connector against being accidentally released.



16 to 50 positions  
with screw connection

#### Technical data

Operating voltage	< 50 V AC / 60 V DC
Max. perm. current (per branch)	1 A
Ambient temperature (operation)	-20 °C ... 50 °C
Mounting position	any
Standards/regulations	DIN EN 50178, IEC 60664, IEC 62103
Connection data solid / stranded / AWG	0,2 - 4 mm <sup>2</sup> / 0,2 - 2,5 mm <sup>2</sup> / 24 - 12

#### Ordering data

Description	No. of pos.	Module width W	Type	Order No.	Pcs. / Pkt.
<b>VARIOFACE feed-through module, with pin strip</b>					
	16	39.00	<b>DFLK 16</b>	<b>2280239</b>	5
	20	39.00	<b>DFLK 20</b>	<b>2280242</b>	5
	26	39.00	<b>DFLK 26</b>	<b>2280255</b>	5
	34	39.00	<b>DFLK 34</b>	<b>2280268</b>	5
	40	39.00	<b>DFLK 40</b>	<b>2280271</b>	5
	50	39.00	<b>DFLK 50</b>	<b>2280284</b>	5

#### Dimensioning of the housing cutout

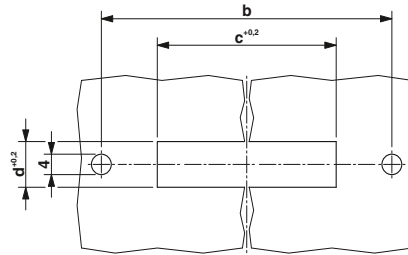

Type	a	b	c	d
DFLK 16	58.4	52.5	40.1 + 0.2	9 + 0.2
DFLK 20	68.4	62.5	45.2 + 0.2	9 + 0.2
DFLK 26	83.4	77.5	52.8 + 0.2	9 + 0.2
DFLK 34	103.4	97.5	63.0 + 0.2	9 + 0.2
DFLK 40	128.4	122.5	70.6 + 0.2	9 + 0.2
DFLK 50	143.4	137.5	83.3 + 0.2	9 + 0.2

#### Dimensional drawing DFLK:

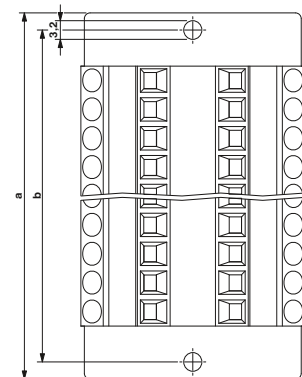
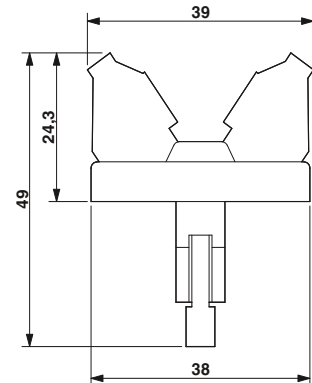



**Feed-through modules for IDC/FLK connectors (pitch 2.54 mm) with spring-cage connection**

- 1:1 connection
- 10 to 50-pos.
- Plug-in push-in spring-cage connection
- Connectors as per IEC 60603-13
- Short and long catches are supplied with the module
- Select housing cutout for side panel mounting according to dimensioning table



**With pin strip and push-in spring-cage connection**

**Technical data**

Operating voltage	< 50 V AC / 60 V DC
Max. perm. current (per branch)	1 A
Ambient temperature (operation)	-20 °C ... 50 °C
Mounting position	any
Standards/regulations	DIN EN 50178, IEC 60664, IEC 62103
Connection data solid / stranded / AWG	0.2 - 2.5 mm <sup>2</sup> / 0.2 - 2.5 mm <sup>2</sup> / 24 - 12

**Ordering data**

Description	No. of pos.	Module width W	Type	Order No.	Pcs. / Pkt.
<b>VARIOFACE feed-through module, with pin strip</b>					
	10	36.50	DFLK 10/FKCT	2903034	1
	14	36.50	DFLK 14/FKCT	2903035	1
	16	36.50	DFLK 16/FKCT	2903036	1
	20	36.50	DFLK 20/FKCT	2903038	1
	26	36.50	DFLK 26/FKCT	2903039	1
	34	36.50	DFLK 34/FKCT	2903041	1
	40	36.50	DFLK 40/FKCT	2903042	1
	50	36.50	DFLK 50/FKCT	2903043	1

**Dimensioning of the housing cutout**

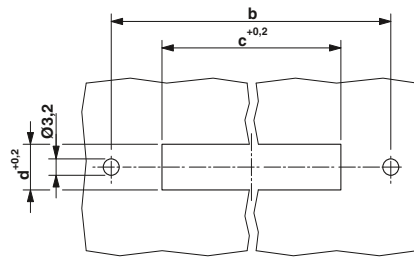

Type	a	b	c	d
DFLK 10/FKCT	58.4	52.5	40.1 + 0.2	9 + 0.2
DFLK 14/FKCT	58.4	52.5	40.1 + 0.2	9 + 0.2
DFLK 16/FKCT	58.4	52.5	40.1 + 0.2	9 + 0.2
DFLK 20/FKCT	68.4	62.5	45.2 + 0.2	9 + 0.2
DFLK 26/FKCT	83.4	77.5	52.8 + 0.2	9 + 0.2
DFLK 34/FKCT	103.4	97.5	63.0 + 0.2	9 + 0.2
DFLK 40/FKCT	128.4	122.5	70.6 + 0.2	9 + 0.2
DFLK 50/FKCT	143.4	137.5	83.3 + 0.2	9 + 0.2

**Dimensional drawing DFLK...FKCT**

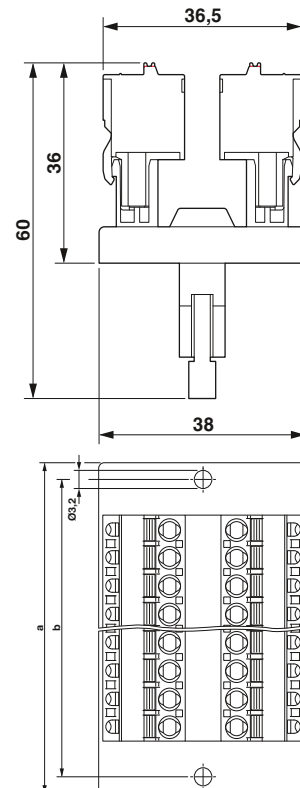

## Universal modules

### VIP – VARIOFACE Professional modules with D-SUB connectors

- 1:1 connection
  - 9 to 50-pos.
  - Screw connection
  - Metal foot
  - As per IEC 60807-2
  - With status indicator as an option
- The D-SUB-4-40 UNC threads are led directly to a connection terminal block.

**Notes:**  
For marking systems (e.g., "ZB 22:UNBEDRUCKT"; Order No. 0811862) and mounting material, see Catalog 5.



9 to 15 positions  
with screw connection



#### Technical data

Operating voltage	125 V AC/DC
Max. perm. current (per branch)	2 A
Ambient temperature (operation)	-20 °C ... 50 °C
Mounting position	any
Standards/regulations	IEC 60664, DIN EN 50178, IEC 62103
Connection data solid / stranded / AWG	0.2 - 4 mm <sup>2</sup> / 0.2 - 2.5 mm <sup>2</sup> / 24 - 12
Dimensions	65.5 mm / 45.1 mm

#### Ordering data

Description	No. of pos.	Module width W	Type	Order No.	Pcs. / Pkt.
<b>VARIOFACE module</b> , with D-Subminiature pin strip	9	34.70	<b>VIP-2/SC/D 9SUB/M</b>	<b>2315117</b>	1
	15	45.00	<b>VIP-2/SC/D15SUB/M</b>	<b>2315120</b>	1
<b>VARIOFACE module</b> , with D-Subminiature pin strip and light indicator	9	34.70			
	15	50.00			
<b>VARIOFACE module</b> , with D-Subminiature socket strip	9	34.70	<b>VIP-2/SC/D 9SUB/F</b>	<b>2315162</b>	1
	15	45.00	<b>VIP-2/SC/D15SUB/F</b>	<b>2315175</b>	1
<b>VARIOFACE module</b> , with D-Subminiature socket strip and light indicator	9	34.70			
	15	50.00			
<b>VARIOFACE module</b> , with D-Subminiature pin strip	25	57.40			
	37	72.70			
	50	98.20			
<b>VARIOFACE module</b> , with D-Subminiature pin strip and light indicator	25	57.40			
	37	72.70			
	50	98.20			
<b>VARIOFACE module</b> , with D-Subminiature socket strip	25	57.40			
	37	72.70			
	50	98.20			
<b>VARIOFACE module</b> , with D-Subminiature socket strip and light indicator	25	57.40			
	37	72.70			
	50	98.20			

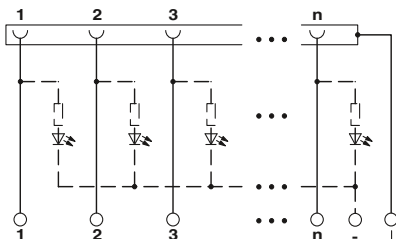



9 to 15 positions  
with screw connection and light indicator



25 to 50 positions  
with screw connection



25 to 50 positions  
with screw connection and light indicator



**Technical data**

24 V DC  
2.5 A  
-20 °C ... 50 °C  
any  
IEC 60664, DIN EN 50178, IEC 62103  
0.2 - 4 mm<sup>2</sup> / 0.2 - 2.5 mm<sup>2</sup> / 24 - 12  
65.5 mm / 45.1 mm

**Technical data**

125 V AC/DC  
2 A  
-20 °C ... 50 °C  
any  
IEC 60664, DIN EN 50178, IEC 62103  
0.2 - 4 mm<sup>2</sup> / 0.2 - 2.5 mm<sup>2</sup> / 24 - 12  
69 mm / 62 mm

**Technical data**

24 V DC  
2.5 A  
-20 °C ... 50 °C  
any  
IEC 60664, DIN EN 50178, IEC 62103  
0.2 - 4 mm<sup>2</sup> / 0.2 - 2.5 mm<sup>2</sup> / 24 - 12  
69 mm / 62 mm

**Ordering data**

Type	Order No.	Pcs. / Pkt.
VIP-2/SC/D 9SUB/M/LED	2322142	1
VIP-2/SC/D15SUB/M/LED	2322155	1
VIP-2/SC/D 9SUB/F/LED	2322197	1
VIP-2/SC/D15SUB/F/LED	2322207	1

**Ordering data**

Type	Order No.	Pcs. / Pkt.
VIP-3/SC/D25SUB/M	2315133	1
VIP-3/SC/D37SUB/M	2315146	1
VIP-3/SC/D50SUB/M	2315159	1
VIP-3/SC/D25SUB/F	2315188	1
VIP-3/SC/D37SUB/F	2315191	1
VIP-3/SC/D50SUB/F	2315201	1

**Ordering data**

Type	Order No.	Pcs. / Pkt.
VIP-3/SC/D25SUB/M/LED	2322168	1
VIP-3/SC/D37SUB/M/LED	2322171	1
VIP-3/SC/D50SUB/M/LED	2322184	1
VIP-3/SC/D25SUB/F/LED	2322210	1
VIP-3/SC/D37SUB/F/LED	2322223	1
VIP-3/SC/D50SUB/F/LED	2322236	1

## Universal modules

### VIP – VARIOFACE Professional modules with D-SUB connectors

- 1:1 connection
  - 9 to 50-pos.
  - Push-in connection
  - Metal foot
  - As per IEC 60807-2
  - With status indicator as an option
- The D-SUB-4-40 UNC threads are led directly to a connection terminal block.

**Notes:**

For marking systems (e.g., "ZB 22:UNBEDRUCKT"; Order No. 0811862) and mounting material, see Catalog 5.



9 to 15 positions  
with push-in connection



#### Technical data

Operating voltage	125 V AC/DC
Max. perm. current (per branch)	2 A
Ambient temperature (operation)	-20 °C ... 50 °C
Mounting position	any
Standards/regulations	IEC 60664, DIN EN 50178, IEC 62103
Connection data solid / stranded / AWG	0.14 - 2.5 mm <sup>2</sup> / 0.14 - 2.5 mm <sup>2</sup> / 26 - 14
Dimensions	H / D 72.1 mm / 46.6 mm

#### Ordering data

Description	No. of pos.	Module width W	Type	Order No.	Pcs. / Pkt.
<b>VARIOFACE module</b> , with D-Subminiature pin strip	9	36.80	<b>VIP-2/PT/D 9SUB/M</b>	<b>2903777</b>	1
	15	46.90	<b>VIP-2/PT/D15SUB/M</b>	<b>2903779</b>	1
<b>VARIOFACE module</b> , with D-Subminiature pin strip and light indicator	9	36.80			
	15	52.00			
<b>VARIOFACE module</b> , with D-Subminiature socket strip	9	36.80	<b>VIP-2/PT/D 9SUB/F</b>	<b>2903778</b>	1
	15	46.90	<b>VIP-2/PT/D15SUB/F</b>	<b>2903780</b>	1
<b>VARIOFACE module</b> , with D-Subminiature socket strip and light indicator	9	36.80			
	15	52.00			
<b>VARIOFACE module</b> , with D-Subminiature pin strip	25	57.10			
	37	72.30			
	50	97.70			
<b>VARIOFACE module</b> , with D-Subminiature pin strip and light indicator	25	57.10			
	37	72.30			
	50	97.70			
<b>VARIOFACE module</b> , with D-Subminiature socket strip	25	57.10			
	37	72.30			
	50	97.70			
<b>VARIOFACE module</b> , with D-Subminiature socket strip and light indicator	25	57.10			
	37	72.30			
	50	97.70			

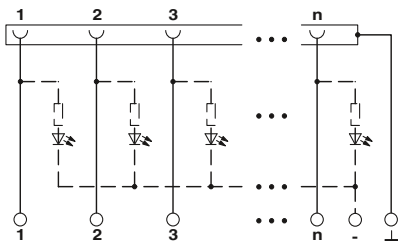



9 to 15 positions  
with push-in connection and light indicator

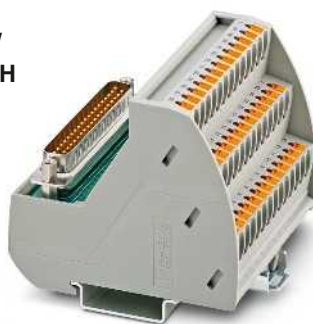

25 to 50 positions  
with push-in connection



25 to 50 positions  
with push-in connection and light indicator



**Technical data**

24 V DC  
2 A  
-20 °C ... 50 °C  
any  
IEC 60664, DIN EN 50178, IEC 62103  
0.14 - 2.5 mm<sup>2</sup> / 0.14 - 2.5 mm<sup>2</sup> / 26 - 14  
72.1 mm / 46.6 mm

**Technical data**

125 V AC/DC  
2 A  
-20 °C ... 50 °C  
any  
IEC 60664, DIN EN 50178, IEC 62103  
0.14 - 2.5 mm<sup>2</sup> / 0.14 - 2.5 mm<sup>2</sup> / 26 - 14  
75.8 mm / 63 mm

**Technical data**

24 V DC  
2 A  
-20 °C ... 50 °C  
any  
IEC 60664, DIN EN 50178, IEC 62103  
0.14 - 2.5 mm<sup>2</sup> / 0.14 - 2.5 mm<sup>2</sup> / 26 - 14  
75.8 mm / 63 mm

**Ordering data**

Type	Order No.	Pcs. / Pkt.
VIP-2/PT/D 9SUB/M/LED	2904258	1
VIP-2/PT/D15SUB/M/LED	2904259	1
VIP-2/PT/D 9SUB/F/LED	2904263	1
VIP-2/PT/D15SUB/F/LED	2904264	1

**Ordering data**

Type	Order No.	Pcs. / Pkt.
VIP-3/PT/D25SUB/M	2903781	1
VIP-3/PT/D37SUB/M	2903783	1
VIP-3/PT/D50SUB/M	2903785	1
VIP-3/PT/D25SUB/F	2903782	1
VIP-3/PT/D37SUB/F	2903784	1
VIP-3/PT/D50SUB/F	2903786	1

**Ordering data**

Type	Order No.	Pcs. / Pkt.
VIP-3/PT/D25SUB/M/LED	2904260	1
VIP-3/PT/D37SUB/M/LED	2904261	1
VIP-3/PT/D50SUB/M/LED	2904262	1
VIP-3/PT/D25SUB/F/LED	2904265	1
VIP-3/PT/D37SUB/F/LED	2904266	1
VIP-3/PT/D50SUB/F/LED	2904267	1

# System cabling for controllers

## Universal modules

### SLIM-LINE modules for D-SUB connectors

These VARIOFACE modules connect D-SUB strips with front connection terminal blocks in accordance with IEC 60807-2/DIN 41652.

To make the ground connection, the metallic plug shell (4-40 UNC thread) makes contact with a connection terminal block.



9 to 25 positions  
With screw connection



37 to 50 positions  
With screw connection

Operating voltage  
Max. perm. current (per branch)  
Ambient temperature (operation)  
Mounting position  
Standards/regulations  
Dimensions

D / W

ERC

#### Technical data

125 V AC/DC  
2.5 A  
-10 °C ... 50 °C  
any  
DIN EN 50178, IEC 60664, IEC 62103  
45 mm / 25 mm

#### Ordering data

Description	No. of pos.	Module height H
<b>VARIOFACE SLIM-LINE module, with D-Subminiature pin strip</b>		
	9	117.00
	15	147.00
	25	217.00
<b>VARIOFACE SLIM-LINE module, with D-Subminiature socket strip</b>		
	9	117.00
	15	147.00
	25	217.00
<b>VARIOFACE SLIM-LINE module, with D-Subminiature pin strip</b>		
	37	157.00
	50	187.00
<b>VARIOFACE SLIM-LINE module, with D-Subminiature socket strip</b>		
	37	157.00
	50	187.00

ERC

#### Technical data

125 V AC/DC  
2.5 A  
-10 °C ... 50 °C  
any  
DIN EN 50178, IEC 60664, IEC 62103  
45 mm / 45 mm

#### Ordering data

Type	Order No.	Pcs. / Pkt.
<b>UM 25-D 9SUB/S/Front/Q</b>	<b>2959573</b>	1
<b>UM 25-D15SUB/S/Front/Q</b>	<b>2959599</b>	1
<b>UM 25-D25SUB/S/Front/Q</b>	<b>2959612</b>	1
<b>UM 25-D 9SUB/B/Front/Q</b>	<b>2959560</b>	1
<b>UM 25-D15SUB/B/Front/Q</b>	<b>2959586</b>	1
<b>UM 25-D25SUB/B/Front/Q</b>	<b>2959609</b>	1

Type	Order No.	Pcs. / Pkt.
<b>UM 45-D37SUB/S/Front/Q</b>	<b>2959638</b>	1
<b>UM 45-D50SUB/S/Front/Q</b>	<b>2959654</b>	1
<b>UM 45-D37SUB/B/Front/Q</b>	<b>2959625</b>	1
<b>UM 45-D50SUB/B/Front/Q</b>	<b>2959641</b>	1

**Feed-through modules for D-SUB connectors with screw connection**

- 1:1 connection
- 9 to 50-pos.
- Screw connection
- As per IEC 60807-2
- D-SUB 4-40 UNC thread
- 9 to 37-pos.: separate ground tap
- 50-pos.: no ground tap

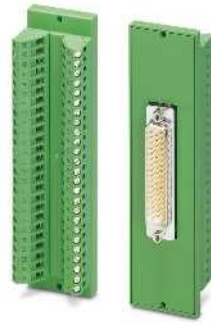

With D-SUB pin strip



With D-SUB socket strip

Operating voltage  
Max. perm. current (per branch)  
Ambient temperature (operation)  
Mounting position  
Standards/regulations  
Connection data solid / stranded / AWG

125 V AC/DC  
2.5 A  
-20 °C ... 50 °C  
any  
IEC 60664, DIN EN 50178, IEC 62103  
0.2 - 4 mm<sup>2</sup> / 0.2 - 2.5 mm<sup>2</sup> / 24 - 12

125 V AC/DC  
2.5 A  
-20 °C ... 50 °C  
any  
IEC 60664, DIN EN 50178, IEC 62103  
0.2 - 4 mm<sup>2</sup> / 0.2 - 2.5 mm<sup>2</sup> / 24 - 12

Ordering data

Type	Order No.	Pcs. / Pkt.
DFLK-D 9 SUB/S	2283870	5
DFLK-D15 SUB/S	2280297	5
DFLK-D25 SUB/S	2280310	5
DFLK-D37 SUB/S	2280336	5
DFLK-D50 SUB/S	2291286	5

Ordering data

Type	Order No.	Pcs. / Pkt.
DFLK-D 9 SUB/B	2287135	5
DFLK-D15 SUB/B	2280307	5
DFLK-D25 SUB/B	2280323	5
DFLK-D37 SUB/B	2280349	5
DFLK-D50 SUB/B	2287669	5

Description	No. of pos.	Module width W
VARIOFACE feed-through module, with D-subminiature connector		
	9	39.00
	15	39.00
	25	39.00
	37	39.00
	50	39.00

Dimensioning of the housing cutout

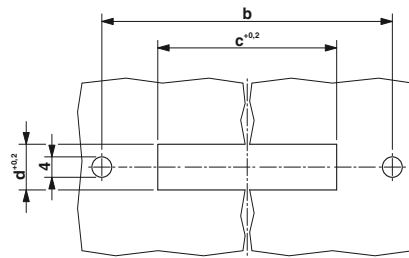

Type	a	b	c	d
DFLK-D 9 SUB/S	58.4	52.5	40.2 + 0.2	13 + 0.2
DFLK-D 15 SUB/S	58.4	52.5	40.2 + 0.2	13 + 0.2
DFLK-D 25 SUB/S	83.4	77.5	54.2 + 0.2	13 + 0.2
DFLK-D 37 SUB/S	128.4	122.5	70.6 + 0.2	13 + 0.2
DFLK-D 50 SUB/S	143.4	137.5	67.8 + 0.2	15.8 + 0.2
DFLK-D 9 SUB/B	58.4	52.5	40.2 + 0.2	13 + 0.2
DFLK-D 15 SUB/B	58.4	52.5	40.2 + 0.2	13 + 0.2
DFLK-D 25 SUB/B	83.4	77.5	54.2 + 0.2	13 + 0.2
DFLK-D 37 SUB/B	128.4	122.5	70.6 + 0.2	13 + 0.2
DFLK-D 50 SUB/B	143.4	137.5	67.8 + 0.2	15.8 + 0.2

Dimensional drawing: DFLK-D...SUB:

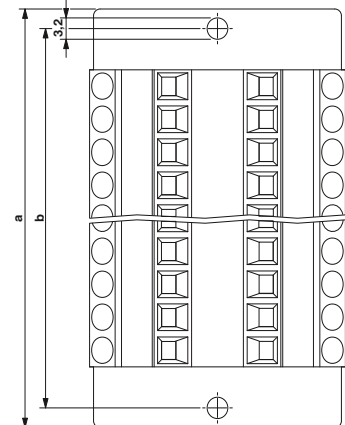
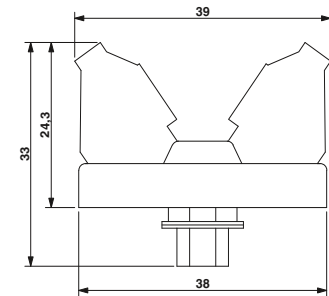



# System cabling for controllers

## Universal modules

### Feed-through modules for D-SUB connectors with push-in connection

- 1:1 connection
- 9 to 50-pos.
- Plug-in push-in spring-cage connection
- Connector according to IEC 60807-2
- D-SUB 4-40 UNC thread
- 9 to 37-pos. with separate ground tap
- 50-pos.: no ground tap
- Select housing cutout for side panel mounting according to dimensions table



With D-SUB pin strip and push-in connection

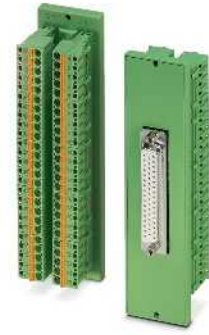

With D-SUB socket strip and push-in connection

Operating voltage  
Max. perm. current (per branch)  
Ambient temperature (operation)  
Mounting position  
Standards/regulations  
Connection data solid / stranded / AWG

125 V AC/DC  
2.5 A  
-20 °C ... 50 °C  
any  
DIN EN 50178, IEC 60664, IEC 62103  
0.2 - 2.5 mm<sup>2</sup> / 0.2 - 2.5 mm<sup>2</sup> / 24 - 12

125 V AC/DC  
2.5 A  
-20 °C ... 50 °C  
any  
DIN EN 50178, IEC 60664, IEC 62103  
0.2 - 2.5 mm<sup>2</sup> / 0.2 - 2.5 mm<sup>2</sup> / 24 - 12

Description	No. of pos.	Module width W
<b>VARIOFACE feed-through module, with D-subminiature connector</b>		
	9	36.50
	15	36.50
	25	36.50
	37	36.50
	50	36.50

Ordering data		
Type	Order No.	Pcs. / Pkt.
DFLK-D 9 SUB/M/FKCT	2903052	1
DFLK-D15 SUB/M/FKCT	2903054	1
DFLK-D25 SUB/M/FKCT	2903055	1
DFLK-D37 SUB/M/FKCT	2903056	1
DFLK-D50 SUB/M/FKCT	2903058	1

Ordering data		
Type	Order No.	Pcs. / Pkt.
DFLK-D 9 SUB/F/FKCT	2903063	1
DFLK-D15 SUB/F/FKCT	2903065	1
DFLK-D25 SUB/F/FKCT	2903067	1
DFLK-D37 SUB/F/FKCT	2903069	1
DFLK-D50 SUB/F/FKCT	2903070	1

Dimensioning of the housing cutout

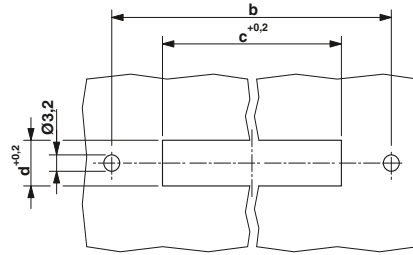

Type	a	b	c	d
DFLK-D 9 SUB/M/FKCT	58.4	52.5	40.2 + 0.2	13 + 0.2
DFLK-D15 SUB/M/FKCT	58.4	52.5	40.2 + 0.2	13 + 0.2
DFLK-D25 SUB/M/FKCT	83.4	77.5	54.2 + 0.2	13 + 0.2
DFLK-D37 SUB/M/FKCT	128.4	122.5	70.6 + 0.2	13 + 0.2
DFLK-D50 SUB/M/FKCT	143.4	137.5	67.8 + 0.2	15.8 + 0.2
DFLK-D 9 SUB/F/FKCT	58.4	52.5	40.2 + 0.2	13 + 0.2
DFLK-D15 SUB/F/FKCT	58.4	52.5	40.2 + 0.2	13 + 0.2
DFLK-D25 SUB/F/FKCT	83.4	77.5	54.2 + 0.2	13 + 0.2
DFLK-D37 SUB/F/FKCT	128.4	122.5	70.6 + 0.2	13 + 0.2
DFLK-D50 SUB/F/FKCT	143.4	137.5	67.8 + 0.2	15.8 + 0.2

Dimensional drawing DFLK-D...SUB...FKCT

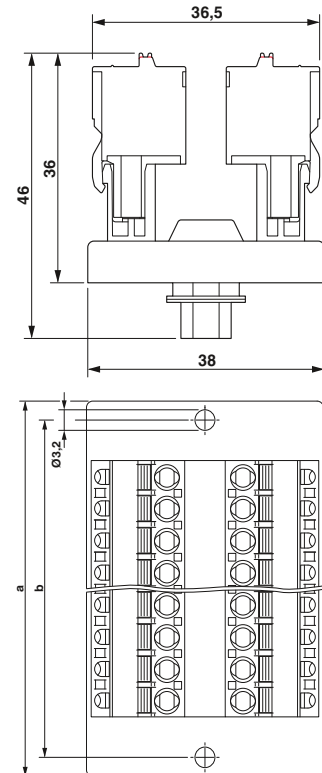

**VIP – VARIOFACE Professional modules for high density D-SUB connectors**

- 1:1 connection
  - 15 to 62-pos.
  - Screw and push-in connection
  - Metal foot
- The D-SUB-4-40 UNC threads are led directly to a connection terminal block.



**15 to 62 positions with screw connection**

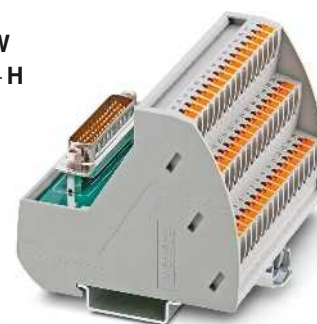

**15 to 62 positions with push-in connection**

**Notes:**

For marking systems (e.g., "ZB 22:UNBEDRUCKT"; Order No. 0811862) and mounting material, see Catalog 5.

1) Module with double-level terminal blocks



**Technical data**

Operating voltage	125 V AC/DC
Max. perm. current (per branch)	1 A
Ambient temperature (operation)	-20 °C ... 50 °C
Mounting position	any
Standards/regulations	EN 50178
Connection data solid / stranded / AWG	0.2 - 4 mm <sup>2</sup> / 0.2 - 2.5 mm <sup>2</sup> / 24 - 12
Dimensions	69 mm / 62 mm

H / D

**Ordering data**

Description	No. of pos.	Module width W
<b>VARIOFACE module, with D-Subminiature pin strip</b>		
With screw connection 1)	15	44.90
With screw connection	26	52.30
With screw connection	44	82.90
With screw connection	62	113.50
With push-in connection 1)	15	46.90
With push-in connection	26	52.00
With push-in connection	44	82.50
With push-in connection	62	113.00
<b>VARIOFACE module, with D-Subminiature socket strip</b>		
With screw connection 1)	15	44.90
With screw connection	26	52.30
With screw connection	44	82.90
With screw connection	62	113.50
With push-in connection 1)	15	46.90
With push-in connection	26	52.00
With push-in connection	44	82.50
With push-in connection	62	113.00



**Technical data**

Operating voltage	125 V AC/DC
Max. perm. current (per branch)	1 A
Ambient temperature (operation)	-20 °C ... 50 °C
Mounting position	any
Standards/regulations	EN 50178
Connection data solid / stranded / AWG	0.14 - 2.5 mm <sup>2</sup> / 0.14 - 2.5 mm <sup>2</sup> / 26 - 14
Dimensions	75.8 mm / 63 mm

**Ordering data**

Type	Order No.	Pcs. / Pkt.
VIP-2/SC/HD15SUB/M	2322326	1
VIP-3/SC/HD26SUB/M	2322375	1
VIP-3/SC/HD44SUB/M	2322388	1
VIP-3/SC/HD62SUB/M	2322391	1
VIP-2/PT/HD15SUB/M	2904268	1
VIP-3/PT/HD26SUB/M	2904269	1
VIP-3/PT/HD44SUB/M	2904270	1
VIP-3/PT/HD62SUB/M	2904271	1
VIP-2/PT/HD15SUB/F	2904272	1
VIP-3/PT/HD26SUB/F	2904273	1
VIP-3/PT/HD44SUB/F	2904274	1
VIP-3/PT/HD62SUB/F	2904275	1

## Universal modules

### Modules for connectors IEC 60603/DIN 41612

These VARIOFACE interface modules connect high-position connectors in acc. with IEC 60603/DIN 41612 to screw connection terminal blocks.

The following VARIOFACE modules are available:

- **UMK** modules with double-level connection terminal blocks
- **UMKS** modules with three-level connection terminal blocks

Notes:
Suitable cable housings, see the table on page 620

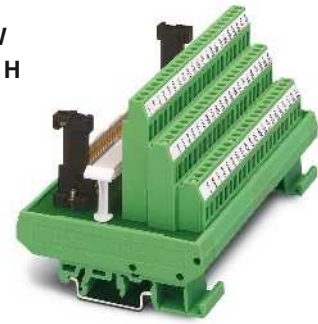

**Type C,  
64-position, a, c assembled**

ERC

Operating voltage	
Max. perm. current (per branch)	
Ambient temperature (operation)	
Mounting position	
Standards/regulations	
Connection data solid / stranded / AWG	
Dimensions	H / D

Technical data
125 V AC/DC
1 A
-20 °C ... 50 °C
any
DIN EN 50178, IEC 60664, IEC 62103
0.2 - 4 mm <sup>2</sup> / 0.2 - 2.5 mm <sup>2</sup> / 24 - 12
77 mm / 72 mm

Description	No. of pos.	Module width W
<b>VARIOFACE module, C 64-pos., screw-on cable housing, with:</b>		
- Pin contact strip	64	135.00
<b>VARIOFACE module, E 48-pos., screw-on cable housing, with:</b>		
- Pin contact strip	48	123.80
<b>VARIOFACE module, F 48-pos., screw-on cable housing, with:</b>		
- Pin contact strip	48	112.50
<b>VARIOFACE module, F 48-pos., snap-on cable housing, with:</b>		
- Pin contact strip	48	112.50
<b>VARIOFACE module, D 32-pos., screw-on cable housing, with:</b>		
- Pin contact strip	32	135.00

Ordering data		
Type	Order No.	Pcs. / Pkt.
<b>UMKS- C64M-VS</b>	<b>2970565</b>	1

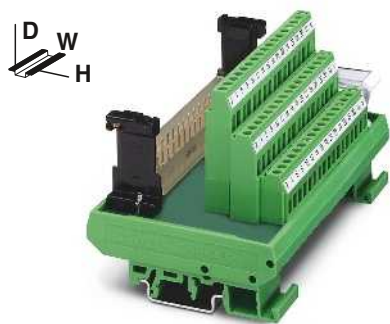

**Type E,**  
48-position, a, c, e assembled

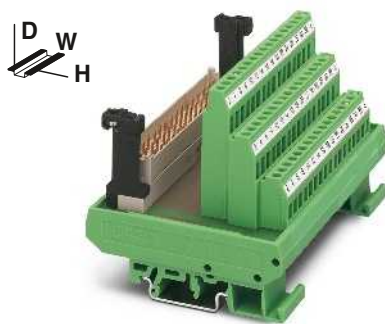

**Type F,**  
48-position, z, b, d assembled

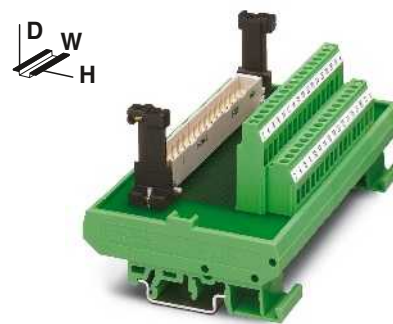

**Type D,**  
32-position, a, c assembled

ERC

ERC

ERC

Technical data
125 V AC/DC
4 A
-20 °C ... 50 °C
any
DIN EN 50178, IEC 60664, IEC 62103
0.2 - 4 mm <sup>2</sup> / 0.2 - 2.5 mm <sup>2</sup> / 24 - 12
77 mm / 72 mm

Technical data
250 V AC/DC
4 A
-20 °C ... 45 °C
any
DIN EN 50178, IEC 60664, IEC 62103
0.2 - 4 mm <sup>2</sup> / 0.2 - 2.5 mm <sup>2</sup> / 24 - 12
77 mm / 72 mm

Technical data
250 V AC/DC
2 A
-20 °C ... 50 °C
any
DIN EN 50178, IEC 60664, IEC 62103
0.2 - 4 mm <sup>2</sup> / 0.2 - 2.5 mm <sup>2</sup> / 24 - 12
77 mm / 62.5 mm

Ordering data		
Type	Order No.	Pcs. / Pkt.
UMKS- E48M-VS	2970154	1

Ordering data		
Type	Order No.	Pcs. / Pkt.
UMKS- F48M-VS	2970714	1
UMKS- F48M-VR	2970167	1

Ordering data		
Type	Order No.	Pcs. / Pkt.
UMK- D32M-VS	2970060	1

### Modules for ELCO connectors

<b>Notes:</b>
Dimensional drawings and pin assignments, see page 620

These modules can be used to connect ELCO connectors of the 8016 series to screw connection terminal blocks.

The diagonal position of the ELCO connector means that the wires leading out of the cable housing at the side can be led away without restricting neighboring modules.

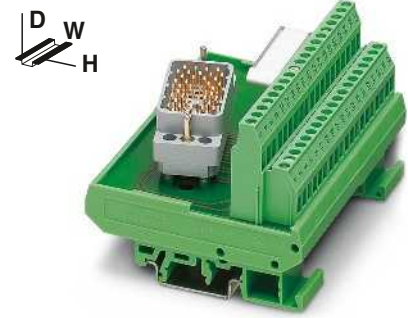

38-pos.

ERC

Operating voltage	25 V AC / 60 V DC
Max. perm. current (per branch)	2 A
Total current	76 A
Ambient temperature (operation)	-20 °C ... 40 °C
Mounting position	any
Standards/regulations	IEC 60664, DIN EN 50178, IEC 62103
Connection data solid / stranded / AWG	0.2 - 4 mm <sup>2</sup> / 0.2 - 2.5 mm <sup>2</sup> / 24 - 12
Dimensions	77 mm / 58.5 mm

#### Technical data

Operating voltage	25 V AC / 60 V DC
Max. perm. current (per branch)	2 A
Total current	76 A
Ambient temperature (operation)	-20 °C ... 40 °C
Mounting position	any
Standards/regulations	IEC 60664, DIN EN 50178, IEC 62103
Connection data solid / stranded / AWG	0.2 - 4 mm <sup>2</sup> / 0.2 - 2.5 mm <sup>2</sup> / 24 - 12
Dimensions	77 mm / 58.5 mm

#### Ordering data

Description	No. of pos.	Module width W
<b>VARIOFACE module, with:</b>		
- Pin strip 8016 right	38	101.50
- Pin strip 8016 left	38	101.50
<b>VARIOFACE module, with:</b>		
- Pin strip 8016 right	56	157.50
- Pin strip 8016 left	56	157.50
<b>VARIOFACE module, with:</b>		
- Pin strip 8016 right	56	77.00
- Pin strip 8016 left	56	77.00
<b>VARIOFACE module, with:</b>		
- Pin strip 8016 right above	32	101.30
- Pin strip 8016 right below	32	101.30
- Pin strip 8016 left above	32	101.30
- Pin strip 8016 left below	32	101.30

Type	Order No.	Pcs. / Pkt.
<b>UMK- EC38/38-XOR</b>	<b>2976297</b>	1
<b>UMK- EC38/38-XOL</b>	<b>2976284</b>	1

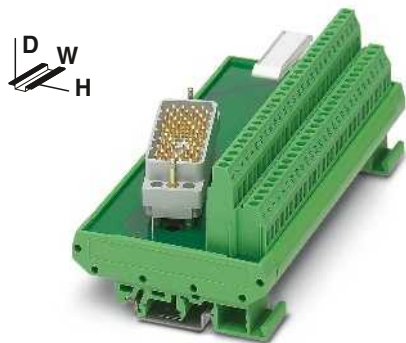

56-pos.

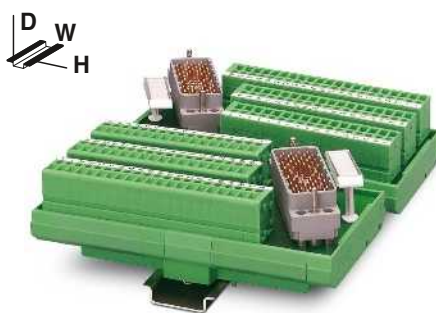

56-pos.,  
with front connection terminal blocks

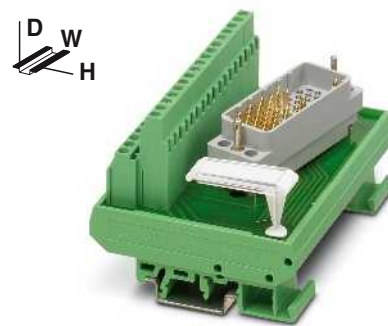

32-pos.

ERC

ERC

ERC

Technical data
125 V AC/DC
1.5 A
28 A (56 branches with 0.5 A each)
-20 °C ... 50 °C
any
IEC 60664, DIN EN 50178, IEC 62103
0.2 - 4 mm <sup>2</sup> / 0.2 - 2.5 mm <sup>2</sup> / 24 - 12
77 mm / 58.5 mm

Technical data
25 V AC / 60 V DC
1.5 A
28 A (56 branches with 0.5 A each)
-20 °C ... 50 °C
any
IEC 60664, DIN EN 50178, IEC 62103
0.2 - 2.5 mm <sup>2</sup> / 0.2 - 1.5 mm <sup>2</sup> / 26 - 16
146.3 mm / 47.5 mm

Technical data
25 V AC / 60 V DC
2 A
32 A (32 branches with 1 A each)
-20 °C ... 40 °C
any
IEC 60664, DIN EN 50178, IEC 62103
0.2 - 4 mm <sup>2</sup> / 0.2 - 2.5 mm <sup>2</sup> / 24 - 12
77 mm / 58.5 mm

Ordering data		
Type	Order No.	Pcs. / Pkt.
UMK- EC56/56-XOR	2975900	1
UMK- EC56/56-XOL	2975890	1

Ordering data		
Type	Order No.	Pcs. / Pkt.
UMK- EC56/FRONT 2,5V/R	2976161	1
UMK- EC56/FRONT 2,5V/L	2976158	1

Ordering data		
Type	Order No.	Pcs. / Pkt.
UMK- EC56/32-XOR	2975858	1
UMK- EC56/32-XUR	2975777	1
UMK- EC56/32-XOL	2975764	1
UMK- EC56/32-XUL	2975780	1

# System cabling for controllers

## Universal modules

### Modules for ELCO connectors for use in Ex i circuits

The VARIOFACE modules connect ELCO connectors of the 8016 series to screw connection terminal blocks. The modules for ELCO connectors can be used as simple electrical equipment for applications in intrinsically safe circuits as per EN 60079-14. They fulfill the requirements of intrinsic safety as per EN 60079-11 (EN 50020) and can be used for various intrinsically safe circuits taking into account the pin configuration.

The voltage of an intrinsically safe circuit may not exceed 30 V. The voltage difference between two intrinsically safe circuits can be up to 60 V.

For clear identification for intrinsically safe circuits, the modules are fitted with blue screw connection terminal blocks.

The arrangement of angled ELCO connectors makes it possible to lead the lines led out from the cable housing away from the adjacent modules without any negative effects.

To separate intrinsically safe and non-intrinsically safe circuits, a distance of at least 50 mm should be kept between the connection points using partition plates or spaces.

Notes:
Dimensional drawings and pin assignments, see page 621
Facts about explosion protection, see page 144

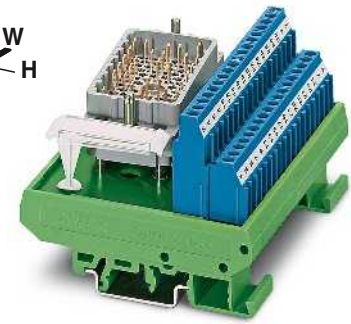

32-pos.

Operating voltage	
Max. perm. current (per branch)	
Ambient temperature (operation)	
Mounting position	
Standards/regulations	
Connection data solid / stranded / AWG	
Dimensions	H / D

Technical data
max. 30 V DC (max. voltage between two intrinsically safe circuits: 60 V DC)
500 mA
-20 °C ... 50 °C
any
DIN EN 60079-11
0.2 - 4 mm <sup>2</sup> / 0.2 - 2.5 mm <sup>2</sup> / 24 - 12
77 mm / 58.5 mm

Description	No. of pos.	Module width W
<b>VARIOFACE module, with:</b>		
- Pin strip 8016 right above	32	101.30
- Pin strip 8016 right below	32	101.30
- Pin strip 8016 left above	32	101.30
- Pin strip 8016 left below	32	101.30
<b>VARIOFACE module, with:</b>		
- Pin strip 8016 right	25	78.80
- Pin strip 8016 left	25	78.80
<b>VARIOFACE module, with:</b>		
- Pin strip 8016 right	25	77.00
- Pin strip 8016 left	25	77.00

Ordering data		
Type	Order No.	Pcs. / Pkt.
<b>UMK- EC90/32/EX-XOR</b>	<b>2900109</b>	1
<b>UMK- EC90/32/EX-XUR</b>	<b>2969068</b>	1
<b>UMK- EC90/32/EX-XOL</b>	<b>2900110</b>	1
<b>UMK- EC90/32/EX-XUL</b>	<b>2969071</b>	1



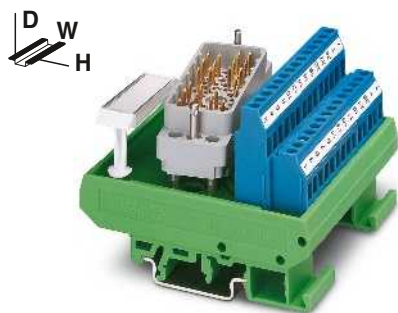

25-pos.

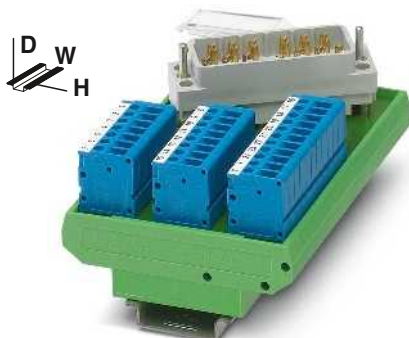

25-pos.,  
with front connection terminal blocks

ERIC

**Technical data**

max. 30 V DC  
(max. voltage between two intrinsically safe circuits: 60 V DC)  
500 mA  
-20 °C ... 50 °C  
any  
DIN EN 60079-11  
0.2 - 4 mm<sup>2</sup> / 0.2 - 2.5 mm<sup>2</sup> / 24 - 12  
77 mm / 58.5 mm

**Technical data**

max. 30 V DC  
(max. voltage between two intrinsically safe circuits: 60 V DC)  
500 mA  
-20 °C ... 50 °C  
any  
DIN EN 60079-11  
0.2 - 2.5 mm<sup>2</sup> / 0.2 - 2.5 mm<sup>2</sup> / 24 - 14  
112.5 mm / 52.5 mm

**Ordering data**

Type	Order No.	Pcs. / Pkt.
UMK- EC56/25/EX -R	2900112	1
UMK- EC56/25/EX -L	2900113	1

**Ordering data**

Type	Order No.	Pcs. / Pkt.
UMK- EC56/25/EX -FRONT 2,5V/R	2900114	1
UMK- EC56/25/EX -FRONT 2,5V/L	2900115	1

# System cabling for controllers

## Universal modules

### Modules with RJ45 connector

- 1:1 connection
- 8-pos., RJ45 connector
- Screw or push-in connection (direct plug-in technology)
- Connector housing led to separate connection terminal blocks

**Notes:**  
For marking systems (e.g., "ZB 22:UNBEDRUCKT"; Order No. 0811862) and mounting material, see Catalog 5.



**8-pos.**  
**With screw connection**



**8-pos.**  
**With push-in connection**

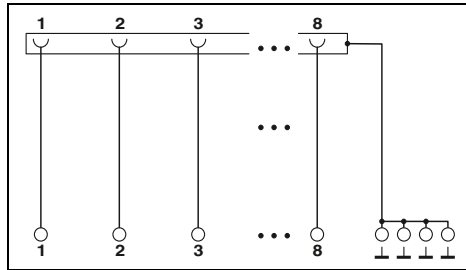

#### Technical data

48 V AC/DC  
1 A  
-20 °C ... 50 °C  
any  
DIN EN 50178  
0.2 - 4 mm<sup>2</sup> / 0.2 - 2.5 mm<sup>2</sup> / 24 - 12  
69 mm / 62 mm

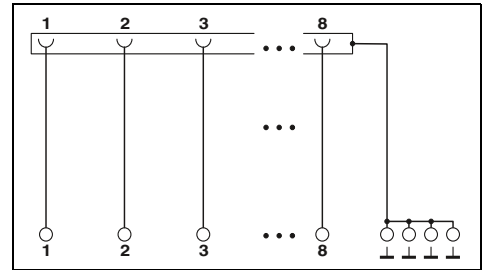

#### Technical data

48 V AC/DC  
1 A  
-20 °C ... 50 °C  
any  
EN 50178  
0.14 - 2.5 mm<sup>2</sup> / 0.14 - 2.5 mm<sup>2</sup> / 26 - 14  
75.8 mm / 63 mm

Operating voltage  
Max. perm. current (per branch)  
Ambient temperature (operation)  
Mounting position  
Standards/regulations  
Connection data solid / stranded / AWG  
Dimensions

H / D

#### Ordering data

Description	No. of pos.	Module width W
<b>VARIOFACE module, with RJ45 connector</b>		
With screw connection	8	26.90
With push-in connection	8	26.60

Type	Order No.	Pcs. / Pkt.
<b>VIP-3/SC/RJ45</b>	<b>2900701</b>	1

#### Ordering data

Type	Order No.	Pcs. / Pkt.
<b>VIP-3/PT/RJ45</b>	<b>2904290</b>	1

Modules with COMBICON connection

- The slim 10 and 18-pos. VARIOFACE SLIM-LINE modules connect the front connection terminal blocks to a COMBICON header. The corresponding COMBICON connectors (5.0 mm pitch) can be found in the COMBICON catalog, PCB connection technology.
- The 32-pos. module UMK-32 MDSTB/MKKDS 3/R connects screw connection terminal blocks with coded COMBICON plug-in screw connectors.

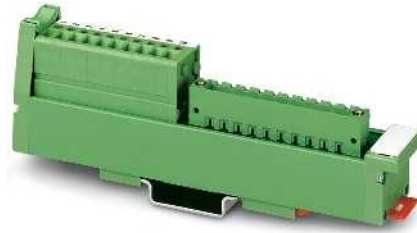

10 and 18-pos.  
With screw connection

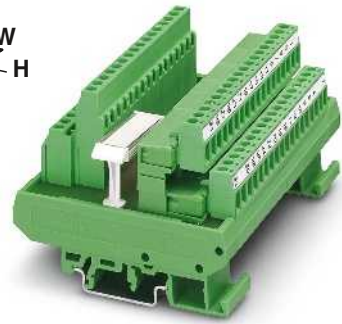

32-pos.  
With screw connection

ERC

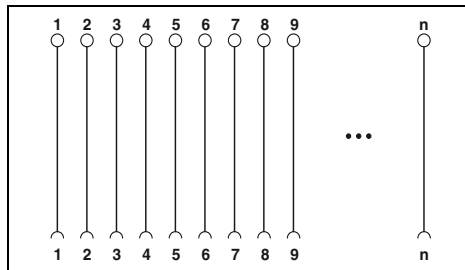

Technical data

250 V AC/DC  
2.5 A  
-10 °C ... 50 °C  
any  
IEC 60664, DIN EN 50178, IEC 62103  
45 mm / 25 mm

Ordering data

Type	Order No.	Pcs. / Pkt.
UM 25-10 MSTB/FRONT/Q	2959803	1
UM 25-18 MSTB/FRONT/Q	2959502	1

ERC

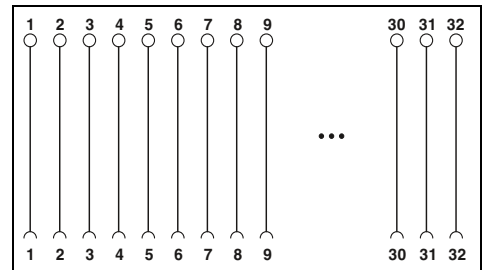

Technical data

250 V AC/DC  
3 A  
-20 °C ... 50 °C  
any  
IEC 60664, DIN EN 50178, IEC 62103  
58.5 mm / 112.5 mm

Ordering data

Type	Order No.	Pcs. / Pkt.
UMK-32 MDSTB/MKKDS3/R	2970196	1

Operating voltage  
Max. perm. current (per branch)  
Ambient temperature (operation)  
Mounting position  
Standards/regulations  
Dimensions

D / W

Description	No. of pos.	Module height H
VARIOFACE SLIM-LINE module, with a COMBICON header (without a COMBICON connector)	10	137.00
	18	217.00
VARIOFACE module, with COMBICON connector, coded	32	77.00

# System cabling for controllers

## Universal cables

### VIP – VARIOFACE Professional system cables with flat-ribbon connectors

- 1:1 connection
- 10 to 20-pos.
- Connectors as per IEC 60603-13
- In the desired lengths
- Individual serial number

#### Note:

Due to the enlarged outer contour of the molded connectors, module types with UM45 profile and three-level terminal blocks cannot be connected with the VIP-CAB-FLK... system cable.

The following module types (10 to 50-pos.) can be connected.

For example, for 20 positions:

- VIP-2/SC/FLK 20
- VIP-2/SC/FLK20/LED
- FLKM 20/ZFKDS
- UM45-FLK 20/ZFKDS

(double-level connection)

The VIP-CAB-FLK... system cables are not suitable for front adapters (see the dimensional drawing).

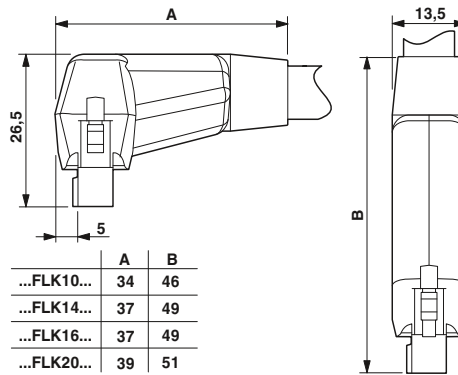

Unshielded



#### Technical data

Max. perm. operating voltage	< 50 V AC / 60 V DC
Max. perm. current carrying capacity per path	1 A
Max. conductor resistance	0.16 Ω/m
Ambient temperature (operation)	-20 °C ... 50 °C
Assembly	Insulation displacement, IEC 60352-4/DIN EN 60352-4
Conductor cross section	AWG 26 / 0.14 mm <sup>2</sup>
Outside diameter	10-position: 6.1 mm 14-position: 6.4 mm 16-position: 6.8 mm 20-position: 7.6 mm

#### Ordering data

Description	No. of pos.	Cable length	Type	Order No.	Pcs. / Pkt.
<b>Round cable, with two molded socket strips</b>	10	1 m	VIP-CAB-FLK10/0,14/1,0M	2318318	1
	10	2 m	VIP-CAB-FLK10/0,14/2,0M	2318334	1
	10	3 m	VIP-CAB-FLK10/0,14/3,0M	2318347	1
<b>Round cable, as above, in variable lengths (minimum ordering quantity five pieces)</b>	10		VIP-CAB-FLK10-0,14/...	2318376	1
<b>Round cable, with two molded socket strips</b>	14	1 m	VIP-CAB-FLK14/0,14/1,0M	2318392	1
	14	2 m	VIP-CAB-FLK14/0,14/2,0M	2318415	1
	14	3 m	VIP-CAB-FLK14/0,14/3,0M	2318428	1
<b>Round cable, as above, in variable lengths (minimum ordering quantity five pieces)</b>	14		VIP-CAB-FLK14-0,14/...	2318457	1
<b>Round cable, with two molded socket strips</b>	16	1 m	VIP-CAB-FLK16/0,14/1,0M	2318473	1
	16	2 m	VIP-CAB-FLK16/0,14/2,0M	2318499	1
	16	3 m	VIP-CAB-FLK16/0,14/3,0M	2318509	1
<b>Round cable, as above, in variable lengths (minimum ordering quantity five pieces)</b>	16		VIP-CAB-FLK16-0,14/...	2318538	1
<b>Round cable, with two molded socket strips</b>	20	1 m	VIP-CAB-FLK20/0,14/1,0M	2318554	1
	20	2 m	VIP-CAB-FLK20/0,14/2,0M	2318570	1
	20	3 m	VIP-CAB-FLK20/0,14/3,0M	2318583	1
<b>Round cable, as above, in variable lengths (minimum ordering quantity five pieces)</b>	20		VIP-CAB-FLK20-0,14/...	2318619	1

#### Ordering example for system cable:

– 10-pos. cable, 7.6 m long

Quantity	Order No.	Length [m]
1	2318376	7.6
		Min. 0.5 m
		Max. 100.0 m
		Increment 0.1 m

**VIP – VARIOFACE Professional system cables with flat-ribbon connectors**

- 1:1 connection
- 26 to 50-pos.
- Connectors as per IEC 60603-13
- In the desired lengths
- Individual serial number

**Note:**

Due to the enlarged outer contour of the molded connectors, module types with UM45 profile and three-level terminal blocks cannot be connected with the VIP-CAB-FLK... system cable.

The following module types (10 to 50-pos.) can be connected.

For example, for 20 positions:

- VIP-2/SC/FLK 20
- VIP-2/SC/FLK20/LED
- FLKM 20/ZFKDS
- UM45-FLK 20/ZFKDS

(double-level connection)

The VIP-CAB-FLK... system cables are not suitable for front adapters (see the dimensional drawing).

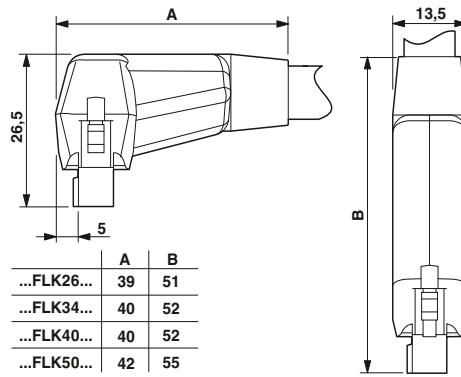

	A	B
...FLK26...	39	51
...FLK34...	40	52
...FLK40...	40	52
...FLK50...	42	55



Unshielded



Max. perm. operating voltage  
 Max. perm. current carrying capacity per path  
 Max. conductor resistance  
 Ambient temperature (operation)  
 Assembly

Conductor cross section  
 Outside diameter

26-position	8.3 mm
34-position	8.7 mm
40-position	9.9 mm
50-position	10.3 mm

**Technical data**

< 50 V AC / 60 V DC  
 1 A  
 0.16 Ω/m  
 -20 °C ... 50 °C  
 Insulation displacement, IEC 60352-4/DIN EN 60352-4

AWG 26 / 0.14 mm<sup>2</sup>

**Ordering data**

Description	No. of pos.	Cable length	Type	Order No.	Pcs. / Pkt.
<b>Round cable, with two molded socket strips</b>					
	26	1 m	VIP-CAB-FLK26/0,14/1,0M	2318635	1
	26	2 m	VIP-CAB-FLK26/0,14/2,0M	2318651	1
	26	3 m	VIP-CAB-FLK26/0,14/3,0M	2318664	1
<b>Round cable, as above, in variable lengths (minimum ordering quantity five pieces)</b>					
	26		VIP-CAB-FLK26-0,14/...	2318693	1
<b>Round cable, with two molded socket strips</b>					
	34	1 m	VIP-CAB-FLK34/0,14/1,0M	2318716	1
	34	2 m	VIP-CAB-FLK34/0,14/2,0M	2318732	1
	34	3 m	VIP-CAB-FLK34/0,14/3,0M	2318745	1
<b>Round cable, as above, in variable lengths (minimum ordering quantity five pieces)</b>					
	34		VIP-CAB-FLK34-0,14/...	2318774	1
<b>Round cable, with two molded socket strips</b>					
	40	1 m	VIP-CAB-FLK40/0,14/1,0M	2318790	1
	40	2 m	VIP-CAB-FLK40/0,14/2,0M	2318813	1
	40	3 m	VIP-CAB-FLK40/0,14/3,0M	2318826	1
<b>Round cable, as above, in variable lengths (minimum ordering quantity five pieces)</b>					
	40		VIP-CAB-FLK40-0,14/...	2318855	1
<b>Round cable, with two molded socket strips</b>					
	50	1 m	VIP-CAB-FLK50/0,14/1,0M	2318871	1
	50	2 m	VIP-CAB-FLK50/0,14/2,0M	2318897	1
	50	3 m	VIP-CAB-FLK50/0,14/3,0M	2318907	1
<b>Round cable, as above, in variable lengths (minimum ordering quantity five pieces)</b>					
	50		VIP-CAB-FLK50-0,14/...	2318936	1

**Ordering example for system cable:**

- 26-pos. cable, 12.6 m long

Quantity	Order No.	Length [m]
1	2318693	12.6
		Min. 0.5 m
		Max. 100.0 m
		Increment 0.1 m

# System cabling for controllers

## Universal cables

### System cable with a flat-ribbon cable connector and an open end

- 1:1 connection
- 10, 14, and 16-pos.
- Connectors as per IEC 60603-13
- Open end at the other end

The individual wires at the open end are marked (1, 2, 3, 4, ...) and fitted with a ferrule.

**Notes:**  
In the case of molded connectors, please observe the dimensional drawing and note, see page 600



Molded connectors, unshielded



Unshielded

ERC

ERC

#### Technical data

Max. perm. operating voltage	< 50 V AC / 60 V DC
Max. perm. current carrying capacity per path	1 A
Max. conductor resistance	0.16 Ω/m
Ambient temperature (operation)	-20 °C ... 50 °C
Assembly	Insulation displacement, IEC 60352-4/DIN EN 60352-4
Conductor cross section	AWG 26 / 0.14 mm <sup>2</sup>
Conductor structure: stranded wires / material	7 / Cu tin-plated
Outside diameter	10-position: 6.1 mm 14-position: 6.4 mm 16-position: 6.5 mm

#### Technical data

Max. perm. operating voltage	< 50 V AC / 60 V DC
Max. perm. current carrying capacity per path	1 A
Max. conductor resistance	0.16 Ω/m
Ambient temperature (operation)	-20 °C ... 50 °C
Assembly	Insulation displacement, IEC 60352-4/DIN EN 60352-4
Conductor cross section	AWG 26 / 0.14 mm <sup>2</sup>
Conductor structure: stranded wires / material	7 / Cu tin-plated
Outside diameter	6.1 mm 6.4 mm 6.5 mm

#### Ordering data

Description	No. of pos.	Cable length	Type	Order No.	Pcs. / Pkt.
<b>Round cable with an open end</b>	10	0.5 m			
	10	1 m			
	10	1.5 m			
	10	2 m			
	10	2.5 m			
	10	3 m			
	10	4 m			
	10	6 m			
	10	8 m			
	10	10 m			
<b>Round cable, as above, however in variable lengths</b>	10				
<b>Round cable with an open end</b>	14	0.5 m	VIP-CAB-FLK14/FR/OE/0,14/0,5M	2900122	1
	14	1 m	VIP-CAB-FLK14/FR/OE/0,14/1,0M	2900123	1
	14	1.5 m	VIP-CAB-FLK14/FR/OE/0,14/1,5M	2900125	1
	14	2 m	VIP-CAB-FLK14/FR/OE/0,14/2,0M	2900126	1
	14	2.5 m			
	14	3 m	VIP-CAB-FLK14/FR/OE/0,14/3,0M	2900127	1
	14	4 m			
	14	6 m			
	14	8 m			
	14	10 m			
<b>Round cable, as above, however in variable lengths</b>	14				
<b>Round cable with an open end</b>	16	0.5 m	VIP-CAB-FLK16/FR/OE/0,14/0,5M	2900130	1
	16	1 m	VIP-CAB-FLK16/FR/OE/0,14/1,0M	2900131	1
	16	1.5 m	VIP-CAB-FLK16/FR/OE/0,14/1,5M	2900132	1
	16	2 m	VIP-CAB-FLK16/FR/OE/0,14/2,0M	2900133	1
	16	2.5 m			
	16	3 m	VIP-CAB-FLK16/FR/OE/0,14/3,0M	2900134	1
	16	4 m			
	16	6 m			
	16	8 m			
	16	10 m			
<b>Round cable, as above, however in variable lengths</b>	16				

#### Ordering data

Type	Order No.	Pcs. / Pkt.
CABLE-FLK10/OE/0,14/ 0,5M	2904073	1
CABLE-FLK10/OE/0,14/ 1,0M	2904074	1
CABLE-FLK10/OE/0,14/ 1,5M	2904075	1
CABLE-FLK10/OE/0,14/ 2,0M	2904076	1
CABLE-FLK10/OE/0,14/ 2,5M	2904077	1
CABLE-FLK10/OE/0,14/ 3,0M	2904078	1
CABLE-FLK10/OE/0,14/ 4,0M	2904079	1
CABLE-FLK10/OE/0,14/ 6,0M	2904080	1
CABLE-FLK10/OE/0,14/ 8,0M	2904081	1
CABLE-FLK10/OE/0,14/10,0M	2904082	1
CABLE-FLK10-OE-0,14/...	2904331	1
CABLE-FLK14/OE/0,14/ 50	2305761	1
CABLE-FLK14/OE/0,14/ 100	2305253	1
CABLE-FLK14/OE/0,14/ 150	2305266	1
CABLE-FLK14/OE/0,14/ 200	2305279	1
CABLE-FLK14/OE/0,14/ 250	2305282	1
CABLE-FLK14/OE/0,14/ 300	2305295	1
CABLE-FLK14/OE/0,14/ 400	2305774	1
CABLE-FLK14/OE/0,14/ 600	2305787	1
CABLE-FLK14/OE/0,14/ 800	2305790	1
CABLE-FLK14/OE/0,14/1000	2305800	1
CABLE-FLK14/OE/0,14/...	2305732	1
CABLE-FLK16/OE/0,14/ 0,5M	2318127	1
CABLE-FLK16/OE/0,14/ 1,0M	2318130	1
CABLE-FLK16/OE/0,14/ 1,5M	2318143	1
CABLE-FLK16/OE/0,14/ 2,0M	2318156	1
CABLE-FLK16/OE/0,14/ 2,5M	2318169	1
CABLE-FLK16/OE/0,14/ 3,0M	2318172	1
CABLE-FLK16/OE/0,14/ 4,0M	2318185	1
CABLE-FLK16/OE/0,14/ 6,0M	2318198	1
CABLE-FLK16/OE/0,14/ 8,0M	2318208	1
CABLE-FLK16/OE/0,14/10,0M	2318211	1
CABLE-FLK16/OE/0,14/...	2318224	1

**System cable with a flat-ribbon cable connector and an open end**

- 1:1 connection
- 20 and 50-pos.
- Connectors as per IEC 60603-13
- Open end at the other end

The individual wires at the open end are marked (1, 2, 3, 4, ...) and fitted with a ferrule.



Molded connectors, unshielded



Unshielded

**Notes:**

In the case of molded connectors, please observe the dimensional drawing and note, see page 600

ERIC

**Technical data**

Max. perm. operating voltage	< 50 V AC / 60 V DC
Max. perm. current carrying capacity per path	1 A
Max. conductor resistance	0.16 Ω/m
Ambient temperature (operation)	-20 °C ... 50 °C
Assembly	Insulation displacement, IEC 60352-4/DIN EN 60352-4
Conductor cross section	AWG 26 / 0.14 mm <sup>2</sup>
Conductor structure: stranded wires / material	7 / Cu tin-plated
Outside diameter	
	20-position
	50-position
	7.6 mm
	10.3 mm

ERIC

**Technical data**

Max. perm. operating voltage	< 50 V AC / 60 V DC
Max. perm. current carrying capacity per path	1 A
Max. conductor resistance	0.16 Ω/m
Ambient temperature (operation)	-20 °C ... 50 °C
Assembly	Insulation displacement, IEC 60352-4/DIN EN 60352-4
Conductor cross section	AWG 26 / 0.14 mm <sup>2</sup>
Conductor structure: stranded wires / material	7 / Cu tin-plated
Outside diameter	
	7.6 mm
	10.3 mm

**Ordering data**

Description	No. of pos.	Cable length	Type	Order No.	Pcs. / Pkt.	
<b>Round cable with an open end</b>	20	0.5 m	VIP-CAB-FLK20/FR/OE/0,14/1,0M	2900139	1	
	20	1 m				
	20	1.5 m				
	20	2 m	VIP-CAB-FLK20/FR/OE/0,14/2,0M	2900142	1	
	20	2.5 m	VIP-CAB-FLK20/FR/OE/0,14/3,0M	2900143	1	
	20	3 m				
	20	4 m				
	20	6 m				
	20	8 m				
	20	10 m				
<b>Round cable, as above, however in variable lengths</b>	20					
<b>Round cable with an open end</b>	50	0.5 m	VIP-CAB-FLK50/FR/OE/0,14/1,0M	2900147	1	
	50	1 m				
	50	1.5 m				
	50	2 m	VIP-CAB-FLK50/FR/OE/0,14/2,0M	2900149	1	
	50	2.5 m	VIP-CAB-FLK50/FR/OE/0,14/3,0M	2900150	1	
	50	3 m				
	50	4 m				
	50	6 m				
	50	8 m				
	50	10 m				
	<b>Round cable, as above, however in variable lengths</b>	50				

**Ordering data**

Type	Order No.	Pcs. / Pkt.
CABLE-FLK20/OE/0,14/ 50	2305826	1
CABLE-FLK20/OE/0,14/ 100	2305305	1
CABLE-FLK20/OE/0,14/ 150	2305318	1
CABLE-FLK20/OE/0,14/ 200	2305321	1
CABLE-FLK20/OE/0,14/ 250	2305334	1
CABLE-FLK20/OE/0,14/ 300	2305347	1
CABLE-FLK20/OE/0,14/ 400	2305839	1
CABLE-FLK20/OE/0,14/ 600	2305842	1
CABLE-FLK20/OE/0,14/ 800	2305855	1
CABLE-FLK20/OE/0,14/1000	2305868	1
CABLE-FLK20/OE/0,14/...	2305745	1
CABLE-FLK50/OE/0,14/ 50	2305871	1
CABLE-FLK50/OE/0,14/ 100	2305350	1
CABLE-FLK50/OE/0,14/ 150	2305363	1
CABLE-FLK50/OE/0,14/ 200	2305376	1
CABLE-FLK50/OE/0,14/ 250	2305389	1
CABLE-FLK50/OE/0,14/ 300	2305392	1
CABLE-FLK50/OE/0,14/ 400	2305884	1
CABLE-FLK50/OE/0,14/ 600	2305897	1
CABLE-FLK50/OE/0,14/ 800	2305907	1
CABLE-FLK50/OE/0,14/1000	2305910	1
CABLE-FLK50/OE/0,14/...	2305758	1



# System cabling for controllers

## Universal cables

### System cable with flat-ribbon cable connector

#### Standard lengths

Pre-assembled round cables are used to connect the PLC front adapters to the corresponding VARIOFACE controller boards.

The following versions are available with 14 and 50 positions:

- Unshielded
- Shielded
- Halogen-free

Connector strips are fitted on both ends of the cables in accordance with IEC 60603-13/DIN 41651 (1:1 connection).

In case of shielded cables, a cable end with a ferrule is additionally provided as a shield connection (length: approx. 0.5 m; cable H05V-K 1 mm<sup>2</sup>, black).

Special lengths are defined using an order key, refer to page 608.



Unshielded

ERC

#### Technical data

Max. perm. operating voltage	< 50 V AC / 60 V DC
Max. perm. current carrying capacity per path	1 A
Max. conductor resistance	0.16 Ω/m
Ambient temperature (operation)	-20 °C ... 50 °C
Shield	-
Assembly	Insulation displacement, IEC 60352-4/DIN EN 60352-4
Conductor cross section	AWG 26 / 0.14 mm <sup>2</sup>
Conductor structure: stranded wires / material	7 / Cu tin-plated
Outside diameter	14-position: 6.4 mm 50-position: 10.3 mm

#### Ordering data

Description	No. of pos.	Cable length	Type	Order No.	Pcs. / Pkt.
<b>Assembled round cable<sup>1)</sup>, with two 14-pos. socket strips in fixed lengths, for transfer of eight channels among other things</b>					
	14	0.3 m	FLK 14/EZ-DR/ 30/KONFEK	2295729	5
	14	0.5 m	FLK 14/EZ-DR/ 50/KONFEK	2288901	5
	14	1 m	FLK 14/EZ-DR/ 100/KONFEK	2288914	1
	14	1.5 m	FLK 14/EZ-DR/ 150/KONFEK	2288927	1
	14	2 m	FLK 14/EZ-DR/ 200/KONFEK	2288930	1
	14	2.5 m	FLK 14/EZ-DR/ 250/KONFEK	2288943	1
	14	3 m	FLK 14/EZ-DR/ 300/KONFEK	2288956	1
	14	3.5 m	FLK 14/EZ-DR/ 350/KONFEK	2288969	1
	14	4 m	FLK 14/EZ-DR/ 400/KONFEK	2288972	1
	14	4.5 m	FLK 14/EZ-DR/ 450/KONFEK	2290847	1
	14	5 m	FLK 14/EZ-DR/ 500/KONFEK	2290834	1
	14	5.5 m	FLK 14/EZ-DR/ 550/KONFEK	2290850	1
	14	6 m	FLK 14/EZ-DR/ 600/KONFEK	2290863	1
	14	7 m			
	14	8 m	FLK 14/EZ-DR/ 800/KONFEK	2299563	1
	14	10 m	FLK 14/EZ-DR/1000/KONFEK	2299576	1
<b>Assembled round cable<sup>2)</sup>, with two 50-pos. socket strips in fixed lengths, for transfer of 32 channels among other things</b>					
	50	0.5 m	FLK 50/EZ-DR/ 50/KONFEK	2289065	5
	50	1 m	FLK 50/EZ-DR/ 100/KONFEK	2289078	1
	50	1.5 m	FLK 50/EZ-DR/ 150/KONFEK	2289081	1
	50	2 m	FLK 50/EZ-DR/ 200/KONFEK	2289094	1
	50	2.5 m	FLK 50/EZ-DR/ 250/KONFEK	2289104	1
	50	3 m	FLK 50/EZ-DR/ 300/KONFEK	2289117	1
	50	3.5 m	FLK 50/EZ-DR/ 350/KONFEK	2289120	1
	50	4 m	FLK 50/EZ-DR/ 400/KONFEK	2289133	1
	50	4.5 m	FLK 50/EZ-DR/ 450/KONFEK	2289573	1
	50	5 m	FLK 50/EZ-DR/ 500/KONFEK	2289586	1
	50	5.5 m	FLK 50/EZ-DR/ 550/KONFEK	2289599	1
	50	6 m	FLK 50/EZ-DR/ 600/KONFEK	2289609	1
	50	6.5 m	FLK 50/EZ-DR/ 650/KONFEK	2289612	1
	50	7 m	FLK 50/EZ-DR/ 700/KONFEK	2289625	1
	50	7.5 m	FLK 50/EZ-DR/ 750/KONFEK	2289638	1
	50	8 m	FLK 50/EZ-DR/ 800/KONFEK	2289641	1
	50	8.5 m	FLK 50/EZ-DR/ 850/KONFEK	2289654	1
	50	9 m	FLK 50/EZ-DR/ 900/KONFEK	2289667	1
	50	9.5 m	FLK 50/EZ-DR/ 950/KONFEK	2289670	1
	50	10 m	FLK 50/EZ-DR/1000/KONFEK	2289683	1



Shield connection at one end



Halogen-free (cable only)

ERC  
Applied for: cUL / UL

ERC

### Technical data

< 50 V AC / 60 V DC  
1 A  
0.16 Ω/m  
-20 °C ... 50 °C  
Tinned copper-braided shield, approx. 85% covering

Insulation displacement, IEC 60352-4/DIN EN 60352-4

AWG 26 / 0.14 mm<sup>2</sup>  
7 / Cu tin-plated

6.7 mm  
11 mm

### Technical data

< 50 V AC / 60 V DC  
1 A  
0.16 Ω/m  
-20 °C ... 50 °C  
-

Insulation displacement, IEC 60352-4/DIN EN 60352-4

AWG 26 / 0.14 mm<sup>2</sup>  
7 / Cu tin-plated

6.4 mm  
10.3 mm

### Ordering data

Type	Order No.	Pcs. / Pkt.
FLK 14/EZ-DR/ 50/KONFEK/S	2296977	1
FLK 14/EZ-DR/ 100/KONFEK/S	2296980	1
FLK 14/EZ-DR/ 150/KONFEK/S	2296993	1
FLK 14/EZ-DR/ 200/KONFEK/S	2297002	1
FLK 14/EZ-DR/ 300/KONFEK/S	2299013	1
FLK 14/EZ-DR/ 400/KONFEK/S	2299026	1
FLK 14/EZ-DR/ 600/KONFEK/S	2299039	1
FLK 14/EZ-DR/ 800/KONFEK/S	2299042	1
FLK 14/EZ-DR/1000/KONFEK/S	2299055	1
FLK 50/EZ-DR/ 50/KONFEK/S	2299097	1
FLK 50/EZ-DR/ 100/KONFEK/S	2299107	1
FLK 50/EZ-DR/ 150/KONFEK/S	2299110	1
FLK 50/EZ-DR/ 200/KONFEK/S	2299123	1
FLK 50/EZ-DR/ 300/KONFEK/S	2299136	1
FLK 50/EZ-DR/ 400/KONFEK/S	2299149	1
FLK 50/EZ-DR/ 600/KONFEK/S	2299152	1
FLK 50/EZ-DR/ 800/KONFEK/S	2299165	1
FLK 50/EZ-DR/1000/KONFEK/S	2299178	1

### Ordering data

Type	Order No.	Pcs. / Pkt.
FLK 14/EZ-DR/HF/ 50/KONFEK	2305952	1
FLK 14/EZ-DR/HF/ 100/KONFEK	2305965	1
FLK 14/EZ-DR/HF/ 150/KONFEK	2305978	1
FLK 14/EZ-DR/HF/ 200/KONFEK	2305981	1
FLK 14/EZ-DR/HF/ 250/KONFEK	2305994	1
FLK 14/EZ-DR/HF/ 300/KONFEK	2304759	1
FLK 14/EZ-DR/HF/ 400/KONFEK	2304762	1
FLK 14/EZ-DR/HF/ 500/KONFEK	2304717	1
FLK 14/EZ-DR/HF/ 600/KONFEK	2306003	1
FLK 14/EZ-DR/HF/ 700/KONFEK	2314011	1
FLK 14/EZ-DR/HF/ 800/KONFEK	2314024	1
FLK 14/EZ-DR/HF/1000/KONFEK	2314037	1
CABLE-FLK50/0,14/HF/ 0,5M	2314134	1
CABLE-FLK50/0,14/HF/ 1,0M	2314147	1
CABLE-FLK50/0,14/HF/ 1,5M	2314150	1
CABLE-FLK50/0,14/HF/ 2,0M	2314163	1
CABLE-FLK50/0,14/HF/ 2,5M	2314176	1
CABLE-FLK50/0,14/HF/ 3,0M	2314189	1
CABLE-FLK50/0,14/HF/ 4,0M	2314192	1
CABLE-FLK50/0,14/HF/ 5,0M	2314202	1
CABLE-FLK50/0,14/HF/ 6,0M	2314215	1
CABLE-FLK50/0,14/HF/ 7,0M	2314228	1
CABLE-FLK50/0,14/HF/ 8,0M	2314231	1
CABLE-FLK50/0,14/HF/10,0M	2314244	1

### Color code of system cables

Wire No.	PIN	Wire color
	1	Black
	2	Brown
	3	Red
	4	Orange
	5	Yellow
	6	Green
	7	Blue
	8	Violet
	9	Gray
10-pos.	10	White
	11	White-black
	12	White-brown
14-pos.	13	White-red
	14	White-orange
	15	White-yellow
16-pos.	16	White-green
	17	White-blue
	18	White-violet
20-pos.	19	White-gray
	20	Brown-black
	21	Brown-red
	22	Brown-orange
	23	Brown-yellow
	24	Brown-green
26-pos.	25	Brown-blue
	26	Brown-violet
	27	Brown-gray
	28	Brown-white
	29	Green-black
	30	Green-brown
	31	Green-red
	32	Green-orange
	33	Green-blue
34-pos.	34	Green-violet
	35	Green-gray
	36	Green-white
	37	Yellow-black
	38	Yellow-brown
	39	Yellow-red
40-pos.	40	Yellow-orange
	41	Yellow-blue
	42	Yellow-violet
	43	Yellow-gray
	44	Yellow-white
	45	Gray-black
	46	Gray-brown
	47	Gray-red
	48	Gray-orange
	49	Gray-yellow
50-pos.	50	Gray-green

1) Socket strips assembled straight at both ends.

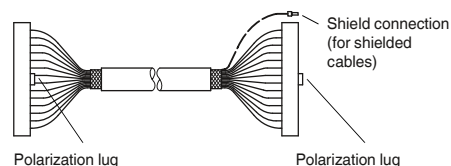

2) Socket strips assembled straight at one end and angled at the other.

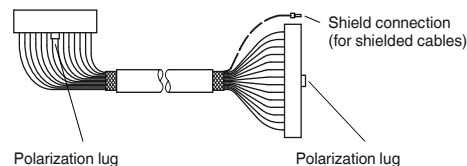

# System cabling for controllers

## Universal cables

### System cable with flat-ribbon cable connector

#### Standard lengths

Pre-assembled round cables to couple the VARIOFACE interface modules.

Connector strips are fitted on both ends of the cables in accordance with IEC 60603-13/DIN 41651 (1:1 connection).

Special lengths are defined using an order key, refer to page 608.

Notes:
<b>Outside diameter of the cable</b>
10-pos.: 6 mm
16-pos.: 6.5 mm
20-pos.: 7.6 mm
26-pos.: 7.8 mm
34-pos.: 10 mm



Unshielded

ERC

Applied for: cUL / UL

#### Technical data

Max. perm. operating voltage  
Max. perm. current carrying capacity per path  
Max. conductor resistance  
Ambient temperature (operation)  
Assembly

< 50 V AC / 60 V DC  
1 A  
0.16 Ω/m  
-20 °C ... 50 °C  
Insulation displacement, IEC 60352-4/DIN EN 60352-4

Conductor cross section  
Conductor structure: stranded wires / material

AWG 26 / 0.14 mm<sup>2</sup>  
7 / Cu tin-plated

#### Ordering data

Description	No. of pos.	Cable length	Type	Order No.	Pcs. / Pkt.
<b>Round cable<sup>1)</sup></b> , with two socket strips	10	0.5 m	FLK 10/EZ-DR/ 50/KONFEK	2299204	1
	10	1 m	FLK 10/EZ-DR/ 100/KONFEK	2299217	1
	10	1.5 m	FLK 10/EZ-DR/ 150/KONFEK	2299220	1
	10	2 m	FLK 10/EZ-DR/ 200/KONFEK	2299233	1
	10	3 m	FLK 10/EZ-DR/ 300/KONFEK	2299246	1
	10	4 m	FLK 10/EZ-DR/ 400/KONFEK	2299259	1
	10	6 m	FLK 10/EZ-DR/ 600/KONFEK	2299262	1
	10	8 m	FLK 10/EZ-DR/ 800/KONFEK	2299275	1
	10	10 m	FLK 10/EZ-DR/1000/KONFEK	2299288	1
	<b>Round cable<sup>1)</sup></b> , with two socket strips	16	0.5 m	FLK 16/EZ-DR/ 50/KONFEK	2299291
16		1 m	FLK 16/EZ-DR/ 100/KONFEK	2299301	1
16		1.5 m	FLK 16/EZ-DR/ 150/KONFEK	2299314	1
16		2 m	FLK 16/EZ-DR/ 200/KONFEK	2299327	1
16		3 m	FLK 16/EZ-DR/ 300/KONFEK	2299330	1
16		4 m	FLK 16/EZ-DR/ 400/KONFEK	2299343	1
16		6 m	FLK 16/EZ-DR/ 600/KONFEK	2299356	1
16		8 m	FLK 16/EZ-DR/ 800/KONFEK	2299369	1
16		10 m	FLK 16/EZ-DR/1000/KONFEK	2299372	1
<b>Round cable<sup>1)</sup></b> , with two socket strips	20	0.5 m	FLK 20/EZ-DR/ 50KONFEK	2296391	1
	20	1 m	FLK 20/EZ-DR/ 100KONFEK	2296401	1
	20	1.5 m	FLK 20/EZ-DR/ 150KONFEK	2296472	1
	20	2 m	FLK 20/EZ-DR/ 200KONFEK	2296485	1
	20	3 m	FLK 20/EZ-DR/ 300KONFEK	2296498	1
	20	4 m	FLK 20/EZ-DR/ 400KONFEK	2296508	1
	20	6 m	FLK 20/EZ-DR/ 600KONFEK	2296511	1
	20	8 m	FLK 20/EZ-DR/ 800KONFEK	2296524	1
	20	10 m	FLK 20/EZ-DR/1000KONFEK	2296537	1
	<b>Round cable<sup>1)</sup></b> , with two socket strips	26	0.5 m	FLK 26/EZ-DR/ 50/KONFEK	2299385
26		1 m	FLK 26/EZ-DR/ 100/KONFEK	2299398	1
26		1.5 m	FLK 26/EZ-DR/ 150/KONFEK	2299408	1
26		2 m	FLK 26/EZ-DR/ 200/KONFEK	2299411	1
26		3 m	FLK 26/EZ-DR/ 300/KONFEK	2299424	1
26		4 m	FLK 26/EZ-DR/ 400/KONFEK	2299437	1
26		6 m	FLK 26/EZ-DR/ 600/KONFEK	2299440	1
26		8 m	FLK 26/EZ-DR/ 800/KONFEK	2299453	1
26		10 m	FLK 26/EZ-DR/1000/KONFEK	2299466	1
<b>Round cable<sup>1)</sup></b> , with two socket strips		34	0.5 m	FLK 34/EZ-DR/ 50/KONFEK	2299479
	34	1 m	FLK 34/EZ-DR/ 100/KONFEK	2299482	1
	34	1.5 m	FLK 34/EZ-DR/ 150/KONFEK	2299495	1
	34	2 m	FLK 34/EZ-DR/ 200/KONFEK	2299505	1
	34	3 m	FLK 34/EZ-DR/ 300/KONFEK	2299518	1
	34	4 m	FLK 34/EZ-DR/ 400/KONFEK	2299521	1
	34	6 m	FLK 34/EZ-DR/ 600/KONFEK	2299534	1
	34	8 m	FLK 34/EZ-DR/ 800/KONFEK	2299547	1
	34	10 m	FLK 34/EZ-DR/1000/KONFEK	2299550	1

**System cable with flat-ribbon cable connector**

**Standard lengths**

Pre-assembled round cables are used to connect the PLC front adapters to the corresponding VARIOFACE controller boards.

Connector strips are fitted on both ends of the cables in accordance with IEC 60603-13/DIN 41651 (1:1 connection).

Special lengths are defined using an order key, refer to page 608.



Unshielded



**Technical data**

Max. perm. operating voltage	< 50 V AC / 60 V DC
Max. perm. current carrying capacity per path	1 A
Max. conductor resistance	0.16 Ω/m
Ambient temperature (operation)	-20 °C ... 50 °C
Assembly	Insulation displacement, IEC 60352-4/DIN EN 60352-4
Conductor cross section	AWG 26 / 0.14 mm <sup>2</sup>
Conductor structure: stranded wires / material	7 / Cu tin-plated
Outside diameter	9.9 mm
	40-position

**Ordering data**

Description	No. of pos.	Cable length	Type	Order No.	Pcs. / Pkt.
<b>Round cable<sup>2)</sup>, with two socket strips</b>					
	40	0.5 m	FLK 40/EZ-DR/ 50/KONFEK	2288985	5
	40	1 m	FLK 40/EZ-DR/ 100/KONFEK	2288998	1
	40	1.5 m	FLK 40/EZ-DR/ 150/KONFEK	2289007	1
	40	2 m	FLK 40/EZ-DR/ 200/KONFEK	2289010	1
	40	2.5 m	FLK 40/EZ-DR/ 250/KONFEK	2289023	1
	40	3 m	FLK 40/EZ-DR/ 300/KONFEK	2289036	1
	40	3.5 m	FLK 40/EZ-DR/ 350/KONFEK	2289049	1
	40	4 m	FLK 40/EZ-DR/ 400/KONFEK	2289052	1
	40	6 m	FLK 40/EZ-DR/ 600/KONFEK	2299589	1
	40	8 m	FLK 40/EZ-DR/ 800/KONFEK	2299592	1
	40	10 m	FLK 40/EZ-DR/1000/KONFEK	2299602	1

1) Socket strips assembled straight at both ends.

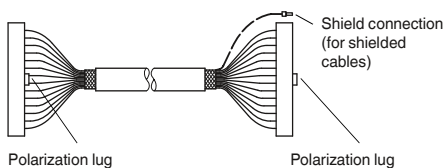

2) Socket strips assembled straight at one end and angled at the other.

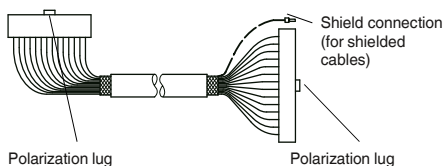

# System cabling for controllers

## Universal cables

### System cable with flat-ribbon cable connector

#### Special lengths

Pre-assembled **round cables** for connecting, e.g., PLC front adapters to the corresponding VARIOFACE termination boards. The cables are assembled with connector strips at both ends according to IEC 60603-13/DIN 41651. For shielded cables, a cable end with ferrule is available additionally as a shielded connection (length: approx. 0.5 m; cable: H05V-K 1 mm<sup>2</sup>, black).

The order key for special lengths is described using three features.

The order of the features is as follows:

- Cable type
- Assembly
- Length in meters

There are two order keys, one for unshielded round cables, FLK EZ-DR/.../.../..., and one for shielded round cables, FLK EZ-DR-S/.../.../.... To ensure clear specification when ordering, the features are described in detail below:

#### Cable type

- This specifies the number of individual conductors of the specific cable.

#### Assembly

- None, the cable is not assembled at either end;
- 10-pos. socket strip at both ends, the cable is assembled with 10-pos. connectors at both ends (1:1 connection);

- 14-pos. socket strip at both ends, the cable is assembled with 14-pos. connectors at both ends (1:1 connection); and so on up to
- 50-pos. socket strip at both ends, the cable is assembled with 50-pos. connectors at both ends (1:1 connection);
- 14-pos. socket strip at one end, 16-pos. socket strip at one end, the cable is assembled with a 14-pos. connector at one end and a 16-pos. connector at the other end (for SIMATIC S7; no 1:1 connection).

#### Features of permissible assemblies:

Assembly	Unshielded round cables FLK EZ-DR/.../.../....								Shielded round cables FLK EZ-DR-S/.../.../....			
	10-pos.	14-pos.	16-pos.	20-pos.	26-pos.	34-pos.	40-pos.	50-pos.	14-pos.	16-pos.	40-pos.	50-pos.
No assembly	10U/C00/...	14U/C00/...	16U/C00/...	20U/C00/...	26U/C00/...	34U/C00/...	40U/C00/...	50U/C00/...	14S/C00/...	16S/C00/...	40S/C00/...	50S/C00/...
10-pos. socket strip at both ends	10U/C55/... <sup>1)</sup>											
14-pos. socket strip at both ends		14U/C23/... <sup>1)</sup>							14S/C23/... <sup>1)</sup>			
16-pos. socket strip at both ends			16U/C58/... <sup>1)</sup>							16S/C58/... <sup>1)</sup>		
20-pos. socket strip at both ends				20U/C61/... <sup>1)</sup>								
26-pos. socket strip at both ends					26U/C63/... <sup>1)</sup>							
34-pos. socket strip at both ends						34U/C65/... <sup>1)</sup>						
40-pos. socket strip at both ends							40U/C30/... <sup>2)</sup>				40S/C30/... <sup>2)</sup>	
50-pos. socket strip at both ends								50U/C38/... <sup>2)</sup>				50S/C38/... <sup>2)</sup>
14-pos. socket strip at one end; 16-pos. socket strip at one end		14U/C52/... <sup>1)</sup>							14S/C52/... <sup>1)</sup>			

<sup>1)</sup> Socket strips assembled straight at both ends.

<sup>2)</sup> Socket strips assembled straight at one end and angled at the other.

<sup>3)</sup> Socket strips assembled straight at one end and angled at the other.

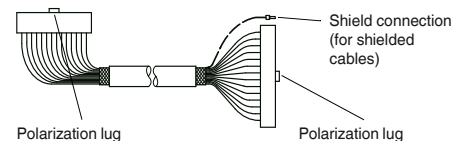
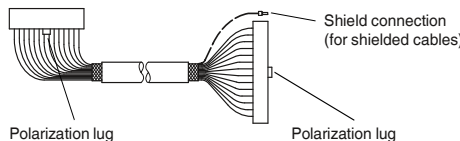
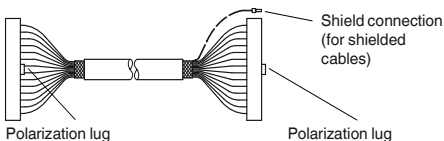

#### Ordering example for unshielded round cable:

- Unshielded 50-pos. round cable, assembled with two 50-pos. socket strips, 11.5 m long

Quantity	Order No.	Cable type	Assembly	Length [m] <sup>4)</sup>
1	2295059	50U 10U ≙ 10-pos. unshielded 14U ≙ 14-pos. unshielded 16U ≙ 16-pos. unshielded 20U ≙ 20-pos. unshielded 26U ≙ 26-pos. unshielded 34U ≙ 34-pos. unshielded 40U ≙ 40-pos. unshielded 50U ≙ 50-pos. unshielded	C38 C00 ≙ No assembly C55 ≙ 10-pos. socket strip at both ends C23 ≙ 14-pos. socket strip at both ends C52 ≙ 14-pos. socket strip at one end, 16-pos. socket strip at the other (for S7) C58 ≙ 16-pos. socket strip at both ends C61 ≙ 20-pos. socket strip at both ends C63 ≙ 26-pos. socket strip at both ends C65 ≙ 34-pos. socket strip at both ends C30 ≙ 40-pos. socket strip at both ends C38 ≙ 50-pos. socket strip at both ends	11.50 <sup>4)</sup> Min. 0.20 m

#### Ordering example for shielded round cable:

- Shielded 14-pos. round cable, assembled with two 14-pos. socket strips, 12.75 m long

Quantity	Order No.	Cable type	Assembly	Length [m] <sup>4)</sup>
1	2295046	14S 14S ≙ 14-pos. shielded 16S ≙ 16-pos. shielded 40S ≙ 40-pos. shielded 50S ≙ 50-pos. shielded	C23 C00 ≙ No assembly C23 ≙ 14-pos. socket strip at both ends C52 ≙ 14-pos. socket strip at one end, 16-pos. socket strip at the other (for S7) C58 ≙ 16-pos. socket strip at both ends C30 ≙ 40-pos. socket strip at both ends C38 ≙ 50-pos. socket strip at both ends	12.75 <sup>4)</sup> Min. 0.20 m



Unshielded



Shielded

ERC

Technical data

Max. perm. operating voltage	< 50 V AC / 60 V DC
Max. perm. current carrying capacity per path	1 A
Max. conductor resistance	0.16 Ω/m
Ambient temperature (operation)	-20 °C ... 50 °C
Shield	-
Conductor cross section	AWG 26 / 0.14 mm <sup>2</sup>
Conductor structure: stranded wires / material	7 / Cu tin-plated

Ordering data

Description	No. of pos.	Cable length
Unshielded round cable, as above, but in variable lengths of type "FLK EZ-DR/14U/C52/..."		

Type	Order No.	Pcs. / Pkt.
FLK EZ-DR.../.../...	2295059	1

ERC

Technical data

Max. perm. operating voltage	< 50 V AC / 60 V DC
Max. perm. current carrying capacity per path	1 A
Max. conductor resistance	0.16 Ω/m
Ambient temperature (operation)	-20 °C ... 50 °C
Shield	Tinned copper-braided shield, approx. 85% covering
Conductor cross section	AWG 26 / 0.14 mm <sup>2</sup>
Conductor structure: stranded wires / material	7 / Cu tin-plated

Ordering data

Type	Order No.	Pcs. / Pkt.
FLK EZ-DR-S.../.../...	2295046	1

# System cabling for controllers

## Universal cables

### System cable with DSUB socket and pin strip

#### Standard lengths

Pre-assembled shielded round cables to connect the control level with the corresponding VARIOFACE interface modules.

Assembly with D-SUB strips as per IEC 60807-2/DIN 41652, (1:1 connection).

- D-SUB socket strip on one end and D-SUB pin strip on the other
- D-SUB sockets on both ends
- DSUB pin strips on both ends
- Cable outlet: straight
- Screw connection: 2 UNC 4-40 screws

Special lengths and assembly versions are defined using an order key, refer to page 612.



Socket strip at one end and pin strip at the other



Technical data	
Max. perm. operating voltage	125 V AC/DC
Max. perm. current carrying capacity per path	2 A
Max. conductor resistance	0.09 Ω/m
Ambient temperature (operation)	-20 °C ... 50 °C
Shield	Tinned copper-braided shield, approx. 85% covering
Insertion/withdrawal cycles	> 200
Conductor cross section	AWG 24 / 0.25 mm <sup>2</sup>
Outside diameter	
	9-position 7,5 mm
	15-position 9 mm
	25-position 10.5 mm
	37-position 12.5 mm
	50-position 13.5 mm

Ordering data					
Description	No. of pos.	Cable length	Type	Order No.	Pcs. / Pkt.
<b>Shielded round cable, fitted with two D-SUB strips, various numbers of positions and lengths</b>					
	9	0.5 m	CABLE-D 9SUB/B/S/ 50/KONFEK/S	2299987	1
	9	1 m	CABLE-D 9SUB/B/S/100/KONFEK/S	2299990	1
	9	1.5 m	CABLE-D 9SUB/B/S/150/KONFEK/S	2300009	1
	9	2 m	CABLE-D 9SUB/B/S/200/KONFEK/S	2302010	1
	9	3 m	CABLE-D 9SUB/B/S/300/KONFEK/S	2302023	1
	9	4 m	CABLE-D 9SUB/B/S/400/KONFEK/S	2302036	1
	9	6 m	CABLE-D 9SUB/B/S/600/KONFEK/S	2302049	1
	15	0.5 m	CABLE-D15SUB/B/S/ 50/KONFEK/S	2302052	1
	15	1 m	CABLE-D15SUB/B/S/100/KONFEK/S	2302065	1
	15	1.5 m	CABLE-D15SUB/B/S/150/KONFEK/S	2302078	1
	15	2 m	CABLE-D15SUB/B/S/200/KONFEK/S	2302081	1
	15	3 m	CABLE-D15SUB/B/S/300/KONFEK/S	2302094	1
	15	4 m	CABLE-D15SUB/B/S/400/KONFEK/S	2302104	1
	15	6 m	CABLE-D15SUB/B/S/600/KONFEK/S	2302117	1
	25	0.5 m	CABLE-D25SUB/B/S/ 50/KONFEK/S	2302120	1
	25	1 m	CABLE-D25SUB/B/S/100/KONFEK/S	2302133	1
	25	1.5 m	CABLE-D25SUB/B/S/150/KONFEK/S	2302146	1
	25	2 m	CABLE-D25SUB/B/S/200/KONFEK/S	2302159	1
	25	3 m	CABLE-D25SUB/B/S/300/KONFEK/S	2302162	1
	25	4 m	CABLE-D25SUB/B/S/400/KONFEK/S	2302175	1
	25	6 m	CABLE-D25SUB/B/S/600/KONFEK/S	2302188	1
	37	0.5 m	CABLE-D37SUB/B/S/ 50/KONFEK/S	2302191	1
	37	1 m	CABLE-D37SUB/B/S/100/KONFEK/S	2302201	1
	37	1.5 m	CABLE-D37SUB/B/S/150/KONFEK/S	2302214	1
	37	2 m	CABLE-D37SUB/B/S/200/KONFEK/S	2302227	1
	37	3 m	CABLE-D37SUB/B/S/300/KONFEK/S	2302230	1
	37	4 m	CABLE-D37SUB/B/S/400/KONFEK/S	2302243	1
	37	6 m	CABLE-D37SUB/B/S/600/KONFEK/S	2302256	1
	37	8 m			
	37	10 m			
	37	15 m			
	37	20 m			
	50	0.5 m	CABLE-D50SUB/B/S/ 50/KONFEK/S	2302269	1
	50	1 m	CABLE-D50SUB/B/S/100/KONFEK/S	2302272	1
	50	1.5 m	CABLE-D50SUB/B/S/150/KONFEK/S	2302285	1
	50	2 m	CABLE-D50SUB/B/S/200/KONFEK/S	2302298	1
	50	3 m	CABLE-D50SUB/B/S/300/KONFEK/S	2302308	1
	50	4 m	CABLE-D50SUB/B/S/400/KONFEK/S	2302311	1
	50	6 m	CABLE-D50SUB/B/S/600/KONFEK/S	2302324	1





Socket strip at both ends



Pin strip at both ends



### Technical data

125 V AC/DC  
2 A  
0.09 Ω/m  
-20 °C ... 50 °C  
Tinned copper-braided shield, approx. 85% covering

> 200  
AWG 24 / 0.25 mm<sup>2</sup>

7.5 mm  
9 mm  
10.5 mm  
12 mm  
13.5 mm

### Ordering data

Type	Order No.	Pcs. / Pkt.
CABLE-D 9SUB/B/B/100/KONFEK/S	2305415	1
CABLE-D 9SUB/B/B/200/KONFEK/S	2305428	1
CABLE-D 9SUB/B/B/300/KONFEK/S	2305431	1
CABLE-D15SUB/B/B/100/KONFEK/S	2305444	1
CABLE-D15SUB/B/B/200/KONFEK/S	2305457	1
CABLE-D15SUB/B/B/300/KONFEK/S	2305460	1
CABLE-D25SUB/B/B/100/KONFEK/S	2305473	1
CABLE-D25SUB/B/B/200/KONFEK/S	2305486	1
CABLE-D25SUB/B/B/300/KONFEK/S	2305499	1
CABLE-D37SUB/B/B/ 100/KONFEK/S	2305509	1
CABLE-D37SUB/B/B/ 200/KONFEK/S	2305512	1
CABLE-D37SUB/B/B/ 300/KONFEK/S	2305525	1
CABLE-D37SUB/B/B/ 400/KONFEK/S	2900759	1
CABLE-D37SUB/B/B/ 600/KONFEK/S	2900760	1
CABLE-D37SUB/B/B/ 800/KONFEK/S	2900761	1
CABLE-D37SUB/B/B/1000/KONFEK/S	2900762	1
CABLE-D37SUB/B/B/1500/KONFEK/S	2900763	1
CABLE-D37SUB/B/B/2000/KONFEK/S	2900764	1
CABLE-D50SUB/B/B/100/KONFEK/S	2305541	1
CABLE-D50SUB/B/B/200/KONFEK/S	2305554	1
CABLE-D50SUB/B/B/300/KONFEK/S	2305567	1

### Technical data

125 V AC/DC  
2 A  
0.09 Ω/m  
-20 °C ... 50 °C  
Tinned copper-braided shield, approx. 85% covering

> 200  
AWG 24 / 0.25 mm<sup>2</sup>

7.5 mm  
9 mm  
10.5 mm  
12 mm  
13.5 mm

### Ordering data

Type	Order No.	Pcs. / Pkt.
CABLE-D 9SUB/S/S/100/KONFEK/S	2305570	1
CABLE-D 9SUB/S/S/200/KONFEK/S	2305583	1
CABLE-D 9SUB/S/S/300/KONFEK/S	2305596	1
CABLE-D15SUB/S/S/100/KONFEK/S	2305606	1
CABLE-D15SUB/S/S/200/KONFEK/S	2305619	1
CABLE-D15SUB/S/S/300/KONFEK/S	2305622	1
CABLE-D25SUB/S/S/100/KONFEK/S	2305635	1
CABLE-D25SUB/S/S/200/KONFEK/S	2305648	1
CABLE-D25SUB/S/S/300/KONFEK/S	2305651	1
CABLE-D37SUB/S/S/100/KONFEK/S	2305664	1
CABLE-D37SUB/S/S/200/KONFEK/S	2305677	1
CABLE-D37SUB/S/S/300/KONFEK/S	2305680	1
CABLE-D50SUB/S/S/100/KONFEK/S	2305693	1
CABLE-D50SUB/S/S/200/KONFEK/S	2305703	1
CABLE-D50SUB/S/S/300/KONFEK/S	2305716	1

Color code of the system cables  
CABLE-D...SUB/...

No. of cores	PIN	Core color
	1	white
	2	brown
	3	green
	4	yellow
	5	gray
	6	pink
	7	blue
	8	red
9-pos.	9	black
	10	violet
	11	gray-pink
	12	red-blue
	13	white-green
	14	brown-green
15-pos.	15	white-yellow
	16	yellow-brown
	17	white-gray
	18	gray-brown
	19	white-pink
	20	pink-brown
	21	white-blue
	22	brown-blue
	23	white-red
	24	brown-red
25-pos.	25	white-black
	26	brown-black
	27	gray-green
	28	yellow-gray
	29	pink-green
	30	yellow-pink
	31	green-blue
	32	yellow-blue
	33	green-red
	34	yellow-red
	35	green-black
	36	yellow-black
37-pos.	37	gray-blue
	38	pink-blue
	39	gray-red
	40	pink-red
	41	gray-black
	42	pink-black
	43	blue-black
	44	red-black
	45	white-brown-black
	46	yellow-green-black
	47	gray-pink-black
	48	blue-red-black
	49	white-green-black
50-pos.	50	green-brown-black

# System cabling for controllers

## Universal cables

### System cable with D-SUB socket and pin strip

#### Special lengths

Pre-assembled shielded **round cables** for connecting VARIOFACE termination boards. The cables are assembled with D-SUB strips in accordance with IEC 60807-2/DIN 41652.

The order key is defined by three features. The features in the appropriate sequence are:

- Cable type
- Assembly
- Length in meters

There are three assembly variants of the shielded round cable:

- CABLE D-SUB-S/.../.../... D-SUB socket strip on one end and D-SUB pin strip on the other
- CABLE D-SUB-B-B-S/.../.../... D-SUB socket strip at both ends

- CABLE D-SUB-S-S-S/.../.../... D-SUB pin strip at both ends  
The features necessary for clear identification of an order are described below:

#### Cable type

- The number of individual conductors of the cable is defined here.

#### Assembly

- (example for CABLE D-SUB-S/.../.../...)
- None, the cable is not assembled at either end
- 9-pos. D-SUB socket strip at one end and 9-pos. D-SUB pin strip at the other end, the cable connects (1:1) a 9-pos. D-SUB socket and pin strip

- 15-pos. D-SUB socket strip at one end 15-pos. D-SUB pin strip at the other end, the cable connects (1:1) a 15-pos. D-SUB socket and pin strip; or up to
- 50-pos. D-SUB socket strip at one end 50-pos. D-SUB pin strip at the other end, the cable connects (1:1) a 50-pos. D-SUB socket and pin strip.

#### Ordering example for round cable assembled with pin strip on one end and socket strip on the other end

- Unshielded 25-pos. round cable, assembled with one 25-pos. D-SUB socket strip and one 25-pos. D-SUB pin strip, 11.5 mm long

Quantity	Order No.	Cable type	Assembly	Length [m] <sup>1)</sup>
1	2302340	25S 09S ≙ 9-pos. shielded 15S ≙ 15-pos. shielded 25S ≙ 25-pos. shielded 37S ≙ 37-pos. shielded 50S ≙ 50-pos. shielded	C36 C00 ≙ no assembly C01 ≙ 9-pos. D-SUB socket strip at one end 9-pos. D-SUB pin strip at one end C28 ≙ 15-pos. D-SUB socket strip at one end 15-pos. D-SUB pin strip at one end C36 ≙ 25-pos. D-SUB socket strip at one end 25-pos. D-SUB pin strip at one end C43 ≙ 37-pos. D-SUB socket strip at one end 37-pos. D-SUB pin strip at one end C49 ≙ 50-pos. D-SUB socket strip at one end 50-pos. D-SUB pin strip at one end	11.50 <sup>1)</sup> min. 0.20 m

#### Ordering example for round cable assembled with socket strip at both ends

- Shielded 37-pos. round cable, assembled with two 37-pos. D-SUB socket strips, 12.75 m long

Quantity	Order No.	Cable type	Assembly	Length [m] <sup>1)</sup>
1	2302421	37S 09S ≙ 9-pos. shielded 15S ≙ 15-pos. shielded 25S ≙ 25-pos. shielded 37S ≙ 37-pos. shielded 50S ≙ 50-pos. shielded	C44 C00 ≙ no assembly C22 ≙ 9-pos. D-SUB socket strip at both ends C29 ≙ 15-pos. D-SUB socket strip at both ends C37 ≙ 25-pos. D-SUB socket strip at both ends C44 ≙ 37-pos. D-SUB socket strip at both ends C50 ≙ 50-pos. D-SUB socket strip at both ends	12.75 <sup>1)</sup> min. 0.20 m

#### Ordering example for round cable assembled with pin strip at both ends

- Shielded 15-pos. round cable, assembled with two 15-pos. D-SUB pin strips, 8.5 m long

Quantity	Order No.	Cable type	Assembly	Length [m] <sup>1)</sup>
1	2302434	15S 09S ≙ 9-pos. shielded 15S ≙ 15-pos. shielded 25S ≙ 25-pos. shielded 37S ≙ 37-pos. shielded 50S ≙ 50-pos. shielded	C71 C00 ≙ no assembly C70 ≙ 9-pos. D-SUB pin strip at both ends C71 ≙ 15-pos. D-SUB pin strip at both ends C72 ≙ 25-pos. D-SUB pin strip at both ends C73 ≙ 37-pos. D-SUB pin strip at both ends C74 ≙ 50-pos. D-SUB pin strip at both ends	8.50 <sup>1)</sup> min. 0.20 m



Shielded



#### Technical data

Max. perm. operating voltage	125 V AC/DC
Max. perm. current carrying capacity per path	2 A
Max. conductor resistance	0.09 Ω/m
Ambient temperature (operation)	-20 °C ... 50 °C
Shield	Tinned copper-braided shield, approx. 85% covering
Insertion/withdrawal cycles	> 200
Conductor cross section	AWG 24 / 0.25 mm <sup>2</sup>

#### Ordering data

Description	No. of pos.	Cable length	Type	Order No.	Pcs. / Pkt.
<b>Assembled round cable</b> , in variable lengths, <b>pin strip on one end and socket strip on the other end</b>			CABLE D-SUB-S/.../.../...	2302340	1
<b>Assembled round cable</b> , in variable lengths, <b>socket strip on both ends</b>			CABLE D-SUB-B-B-S/.../.../...	2302421	1
<b>Assembled round cable</b> , in variable lengths, <b>pin strip on both ends</b>			CABLE D-SUB-S-S-S/.../.../...	2302434	1

# System cabling for controllers

## Universal cables

### System cable with D-SUB socket or pin strip and one open end

- 1:1 connection
- D-SUB socket or pin strip at one end
- Connector according to IEC 60807-2/DIN 41652
- Gland: 2 UNC 4-40 screws
- Open end at the other end
- Individual wire marking: 1, 2, 3, 4, etc.
- Individual wires fitted with ferrules
- Shield connection: H05V-K 1 mm<sup>2</sup> cable, black, 0.5 m in length



Socket strip at one end and open end at the other end



Pin strip at one end and open end at the other end



Max. perm. operating voltage  
Max. perm. current carrying capacity per path  
Max. conductor resistance  
Ambient temperature (operation)  
Shield

125 V AC/DC  
2 A  
0.09 Ω/m  
-20 °C ... 50 °C  
Tinned copper-braided shield, approx. 85% covering

Insertion/withdrawal cycles  
Conductor cross section  
Outside diameter

> 200  
AWG 24 / 0.25 mm<sup>2</sup>  
9-position 7.5 mm  
15-position 9 mm  
25-position 10.5 mm

125 V AC/DC  
2 A  
0.09 Ω/m  
-20 °C ... 50 °C  
Tinned copper-braided shield, approx. 85% covering

> 200  
AWG 24 / 0.25 mm<sup>2</sup>  
7.5 mm  
9 mm  
10.5 mm

### Ordering data

### Ordering data

Description	No. of pos.	Cable length	Type	Order No.	Pcs. / Pkt.	Type	Order No.	Pcs. / Pkt.
Round cable with an open end	9	0.5 m	CABLE-D- 9SUB/F/OE/0,25/S/0,5M	2926014	1	CABLE-D- 9SUB/M/OE/0,25/S/0,5M	2926360	1
	9	1 m	CABLE-D- 9SUB/F/OE/0,25/S/1,0M	2926027	1	CABLE-D- 9SUB/M/OE/0,25/S/1,0M	2926373	1
	9	1.5 m	CABLE-D- 9SUB/F/OE/0,25/S/1,5M	2926030	1	CABLE-D- 9SUB/M/OE/0,25/S/1,5M	2926386	1
	9	2 m	CABLE-D- 9SUB/F/OE/0,25/S/2,0M	2926043	1	CABLE-D- 9SUB/M/OE/0,25/S/2,0M	2926399	1
	9	3 m	CABLE-D- 9SUB/F/OE/0,25/S/3,0M	2926056	1	CABLE-D- 9SUB/M/OE/0,25/S/3,0M	2926409	1
	9	4 m	CABLE-D- 9SUB/F/OE/0,25/S/4,0M	2926069	1	CABLE-D- 9SUB/M/OE/0,25/S/4,0M	2926412	1
	9	6 m	CABLE-D- 9SUB/F/OE/0,25/S/6,0M	2926072	1	CABLE-D- 9SUB/M/OE/0,25/S/6,0M	2926425	1
Round cable, as above, however in variable lengths	9		CABLE-D- 9SUB-F-OE-0,25-S/...	2900903	1	CABLE-D- 9SUB-M-OE-0,25-S/...	2900909	1
Round cable with an open end	15	0.5 m	CABLE-D-15SUB/F/OE/0,25/S/0,5M	2926085	1	CABLE-D-15SUB/M/OE/0,25/S/0,5M	2926438	1
	15	1 m	CABLE-D-15SUB/F/OE/0,25/S/1,0M	2926098	1	CABLE-D-15SUB/M/OE/0,25/S/1,0M	2926441	1
	15	1.5 m	CABLE-D-15SUB/F/OE/0,25/S/1,5M	2926108	1	CABLE-D-15SUB/M/OE/0,25/S/1,5M	2926454	1
	15	2 m	CABLE-D-15SUB/F/OE/0,25/S/2,0M	2926111	1	CABLE-D-15SUB/M/OE/0,25/S/2,0M	2926467	1
	15	3 m	CABLE-D-15SUB/F/OE/0,25/S/3,0M	2926124	1	CABLE-D-15SUB/M/OE/0,25/S/3,0M	2926470	1
	15	4 m	CABLE-D-15SUB/F/OE/0,25/S/4,0M	2926137	1	CABLE-D-15SUB/M/OE/0,25/S/4,0M	2926483	1
	15	6 m	CABLE-D-15SUB/F/OE/0,25/S/6,0M	2926140	1	CABLE-D-15SUB/M/OE/0,25/S/6,0M	2926496	1
Round cable, as above, however in variable lengths	15		CABLE-D-15SUB-F-OE-0,25-S/...	2900905	1	CABLE-D-15SUB-M-OE-0,25-S/...	2900910	1
Round cable with an open end	25	0.5 m	CABLE-D-25SUB/F/OE/0,25/S/0,5M	2926153	1	CABLE-D-25SUB/M/OE/0,25/S/0,5M	2926506	1
	25	1 m	CABLE-D-25SUB/F/OE/0,25/S/1,0M	2926166	1	CABLE-D-25SUB/M/OE/0,25/S/1,0M	2926519	1
	25	1.5 m	CABLE-D-25SUB/F/OE/0,25/S/1,5M	2926179	1	CABLE-D-25SUB/M/OE/0,25/S/1,5M	2926522	1
	25	2 m	CABLE-D-25SUB/F/OE/0,25/S/2,0M	2926182	1	CABLE-D-25SUB/M/OE/0,25/S/2,0M	2926535	1
	25	3 m	CABLE-D-25SUB/F/OE/0,25/S/3,0M	2926195	1	CABLE-D-25SUB/M/OE/0,25/S/3,0M	2926548	1
	25	4 m	CABLE-D-25SUB/F/OE/0,25/S/4,0M	2926205	1	CABLE-D-25SUB/M/OE/0,25/S/4,0M	2926551	1
	25	6 m	CABLE-D-25SUB/F/OE/0,25/S/6,0M	2926218	1	CABLE-D-25SUB/M/OE/0,25/S/6,0M	2926564	1
Round cable, as above, however in variable lengths	25		CABLE-D-25SUB-F-OE-0,25-S/...	2900906	1	CABLE-D-25SUB-M-OE-0,25-S/...	2900911	1

Special lengths of D-SUB cable with open ends can be configured using separate order numbers.

**Ordering example:**

One system cable assembled with a 37-pos. D-SUB socket strip and one open end, 12.75 m in length:

**1 pcs. 2900907/12,75**



Socket strip at one end and open end at the other end



Pin strip at one end and open end at the other end



**Technical data**

Max. perm. operating voltage	125 V AC/DC
Max. perm. current carrying capacity per path	2 A
Max. conductor resistance	0.09 Ω/m
Ambient temperature (operation)	-20 °C ... 50 °C
Shield	Tinned copper-braided shield, approx. 85% covering
Insertion/withdrawal cycles	> 200
Conductor cross section	AWG 24 / 0.25 mm <sup>2</sup>
Outside diameter	
	37-position 12 mm
	50-position 13.5 mm



**Technical data**

Max. perm. operating voltage	125 V AC/DC
Max. perm. current carrying capacity per path	2 A
Max. conductor resistance	0.09 Ω/m
Ambient temperature (operation)	-20 °C ... 50 °C
Shield	Tinned copper-braided shield, approx. 85% covering
Insertion/withdrawal cycles	> 200
Conductor cross section	AWG 24 / 0.25 mm <sup>2</sup>
Outside diameter	
	12 mm
	13.5 mm

**Ordering data**

Type	Order No.	Pcs. / Pkt.
<b>Round cable with an open end</b>		
37 0.5 m CABLE-D-37SUB/F/OE/0,25/S/0,5M	2926221	1
37 1 m CABLE-D-37SUB/F/OE/0,25/S/1,0M	2926234	1
37 1.5 m CABLE-D-37SUB/F/OE/0,25/S/1,5M	2926247	1
37 2 m CABLE-D-37SUB/F/OE/0,25/S/2,0M	2926250	1
37 3 m CABLE-D-37SUB/F/OE/0,25/S/3,0M	2926263	1
37 4 m CABLE-D-37SUB/F/OE/0,25/S/4,0M	2926276	1
37 6 m CABLE-D-37SUB/F/OE/0,25/S/6,0M	2926289	1
<b>Round cable, as above, however in variable lengths</b>		
37 CABLE-D-37SUB-F-OE-0,25-S/...	2900907	1
<b>Round cable with an open end</b>		
50 0.5 m CABLE-D-50SUB/F/OE/0,25/S/0,5M	2926292	1
50 1 m CABLE-D-50SUB/F/OE/0,25/S/1,0M	2926302	1
50 1.5 m CABLE-D-50SUB/F/OE/0,25/S/1,5M	2926315	1
50 2 m CABLE-D-50SUB/F/OE/0,25/S/2,0M	2926328	1
50 3 m CABLE-D-50SUB/F/OE/0,25/S/3,0M	2926331	1
50 4 m CABLE-D-50SUB/F/OE/0,25/S/4,0M	2926344	1
50 6 m CABLE-D-50SUB/F/OE/0,25/S/6,0M	2926357	1
<b>Round cable, as above, however in variable lengths</b>		
50 CABLE-D-50SUB-F-OE-0,25-S/...	2900908	1

**Ordering data**

Type	Order No.	Pcs. / Pkt.
<b>Round cable with an open end</b>		
CABLE-D-37SUB/M/OE/0,25/S/0,5M	2926577	1
CABLE-D-37SUB/M/OE/0,25/S/1,0M	2926580	1
CABLE-D-37SUB/M/OE/0,25/S/1,5M	2926593	1
CABLE-D-37SUB/M/OE/0,25/S/2,0M	2926603	1
CABLE-D-37SUB/M/OE/0,25/S/3,0M	2926616	1
CABLE-D-37SUB/M/OE/0,25/S/4,0M	2926629	1
CABLE-D-37SUB/M/OE/0,25/S/6,0M	2926632	1
<b>Round cable, as above, however in variable lengths</b>		
CABLE-D-37SUB-M-OE-0,25-S/...	2900912	1
<b>Round cable with an open end</b>		
CABLE-D-50SUB/M/OE/0,25/S/0,5M	2926645	1
CABLE-D-50SUB/M/OE/0,25/S/1,0M	2926658	1
CABLE-D-50SUB/M/OE/0,25/S/1,5M	2926661	1
CABLE-D-50SUB/M/OE/0,25/S/2,0M	2926674	1
CABLE-D-50SUB/M/OE/0,25/S/3,0M	2926687	1
CABLE-D-50SUB/M/OE/0,25/S/4,0M	2926690	1
CABLE-D-50SUB/M/OE/0,25/S/6,0M	2926700	1
<b>Round cable, as above, however in variable lengths</b>		
CABLE-D-50SUB-M-OE-0,25-S/...	2900913	1

# System cabling for controllers

## Universal cables

### System cable with a 56-pos. ELCO/EDAC connector and an open end

Assembled system cable for connecting 56-pos. EDAC connectors from the 516 series or ELCO connectors from the 8016 series.

- Series 516 EDAC socket connector at one end
- Metal housing with lateral cable outlet
- Coding sockets in location 1 by default
- Open end at the other end
- Single wire marking: 1, 2, 3, ... 53, 54, Y, Z (see pin assignment)
- Shield connection on both ends:  
H05V-K 1 mm<sup>2</sup> cable, black, length: 0.5 m

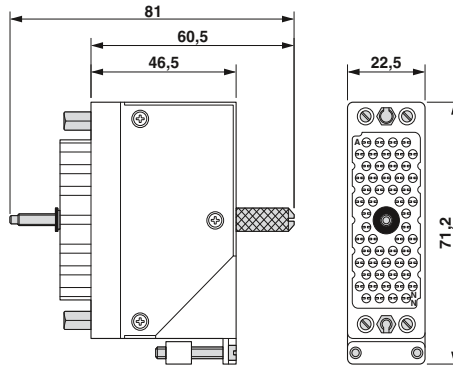

56-pos. system cable

ERC

Notes:
The system cables are designed specifically for the UMK-EC56/56-XOR (2975900) and UMK-EC56/56-XOL (2975890) modules.
When using the UMK-EC56/FRONT 2,5V/R (2976161) or UMK-EC56/FRONT 2,5V/L (2976158) modules, the coding sockets must be adapted accordingly.
Observe the module and system cable layouts.

Max. perm. operating voltage  
Max. perm. current carrying capacity per path  
Max. conductor resistance  
Ambient temperature (operation)  
Shield

**Technical data**  
25 V AC / 60 V DC  
1.5 A  
0.056 Ω/m  
-20 °C ... 60 °C  
Tinned copper-braided shield, approx. 85% covering

Conductor cross section  
Conductor structure: stranded wires / material

AWG 22 / 0.34 mm<sup>2</sup>  
19 / Cu uninsulated

#### Pin assignment

Single wire marking	EDAC socket connector	Single wire marking	EDAC socket connector
Z	Z	31	m
1	A	32	n
2	B	33	p
3	C	34	r
4	D	35	s
5	E	36	t
6	F	37	u
7	H	38	v
8	J	39	w
9	K	40	x
10	L	41	y
11	M	42	z
12	N	43	AA
13	P	44	BB
14	R	45	CC
15	S	46	DD
16	T	47	EE
17	U	48	FF
18	V	49	HH
19	W	50	JJ
20	X	51	KK
21	a	52	LL
22	b	53	MM
23	c	54	NN
24	d	Y	Y
25	e		
26	f		
27	h		
28	j		
29	k		
30	l		

Description	No. of pos.	Cable length
Shielded round cable, assembled with EDAC socket connector at one end and an open end at the other	56	1 m
	56	2 m
	56	4 m
	56	6 m
	56	8 m
	56	10 m
	56	15 m
	56	20 m

Shielded round cable, as above, but in variable lengths	56	
---	----	--

Ordering data		
Type	Order No.	Pcs. / Pkt.
CABLE-EC56/F/OE/0,34/S/ 1,0M	2903395	1
CABLE-EC56/F/OE/0,34/S/ 2,0M	2903396	1
CABLE-EC56/F/OE/0,34/S/ 4,0M	2903397	1
CABLE-EC56/F/OE/0,34/S/ 6,0M	2903398	1
CABLE-EC56/F/OE/0,34/S/ 8,0M	2903399	1
CABLE-EC56/F/OE/0,34/S/10,0M	2903400	1
CABLE-EC56/F/OE/0,34/S/15,0M	2903401	1
CABLE-EC56/F/OE/0,34/S/20,0M	2903402	1
CABLE-EC56-F-OE-0,34-S/...	2904025	1

## System cable with 56-pos. EDAC/ELCO connector

Assembled system cable for connecting 56-pos. EDAC connectors from the 516 series or ELCO connectors from the 8016 series.

- Series 516 EDAC socket connectors at both ends
- Metal housing with lateral cable outlet
- Coding sockets in location 1 by default
- Shield connection at both ends:  
H05V-K 1 mm<sup>2</sup> cable, black, length: 0.5 m

### Notes:

The system cables are designed specifically for the UMK-EC56/56-XOR (2975900) and UMK-EC56/56-XOL (2975890) modules.

When using the UMK-EC56/FRONT 2,5V/R (2976161) or UMK-EC56/FRONT 2,5V/L (2976158) modules, the coding sockets must be adapted accordingly.

Observe the module and system cable layouts.

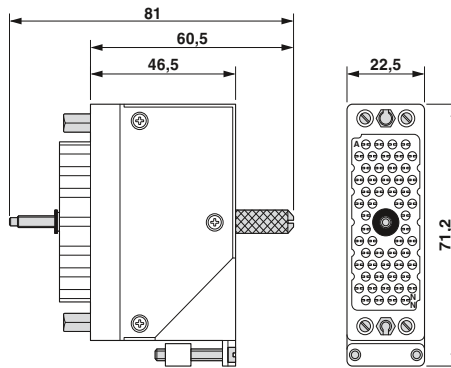

Max. perm. operating voltage  
Max. perm. current carrying capacity per path  
Max. conductor resistance  
Ambient temperature (operation)  
Shield

Conductor cross section  
Conductor structure: stranded wires / material

### Technical data

25 V AC / 60 V DC  
1.5 A  
0.056 Ω/m  
-20 °C ... 60 °C  
Tinned copper-braided shield, approx. 85% covering

AWG 22 / 0.34 mm<sup>2</sup>  
19 / Cu uninsulated

### Ordering data

Description	No. of pos.	Cable length
Shielded round cable, assembled in various lengths with EDAC socket connectors at both ends	56	

Type	Order No.	Pcs. / Pkt.
CABLE-EC56-F-F-0,34-S/...	2906066	1

### Ordering example for system cable:

– 56-pos. cable, 13.50 m long

Quantity    Order No.    Length [m]

1	2906066	13.50
	Min.	0.5 m
	Max.	100.0 m
	Increment	0.1 m



# System cabling for controllers

## Potential distributors

### Modules as compact potential distributors

The VIP-2/.../PDM... modules offer the following features:

- Two potential levels
- Separate supply
- Screw or push-in connection
- Consecutive marking
- With fuse as an option

The modules UMK-PVB and UMK-PVB 6 have three or six potential levels.

**Notes:**  
Marking systems and mounting material  
See Catalog 5



With screw connection and 2 potential levels

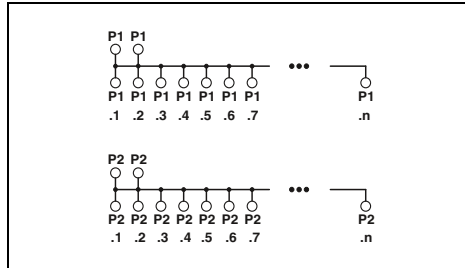

#### Technical data

Operating voltage	250 V AC/DC
Max. perm. current (per branch)	15 A
Total current	30 A (per potential)
Ambient temperature (operation)	-20 °C ... 50 °C
Mounting position	any
Standards/regulations	IEC 60664, DIN EN 50178, IEC 62103
Supply connection data solid / stranded / AWG	0.2 - 6 mm <sup>2</sup> / 0.2 - 4 mm <sup>2</sup> / 24 - 10
Distribution connection data solid / stranded / AWG	0.2 - 4 mm <sup>2</sup> / 0.2 - 2.5 mm <sup>2</sup> / 24 - 12
Dimensions	H / D 65.5 mm / 50 mm

#### Ordering data

Description	No. of pos.	Module width W
<b>VARIOFACE module</b> , with two busbars (P1, P2) for potential distribution, per potential:		
2 power terminals/8 distributor terminal blocks		50.00
2 power terminals/12 distributor terminal blocks		70.40
2 power terminals/16 distributor terminal blocks		90.80
2 power terminals/24 distributor terminal blocks		131.50
<b>VARIOFACE module</b> , with two busbars (P1, P2) for potential distribution, per potential:		
2 power terminals/8 distributor terminal blocks		41.90
2 power terminals/12 distributor terminal blocks		57.10
2 power terminals/16 distributor terminal blocks		67.30
2 power terminals/24 distributor terminal blocks		97.70
<b>VARIOFACE module</b> with 2 busbars for potential distribution		
- 2 power terminals/8 distributor terminal blocks		97.70
<b>VARIOFACE module</b> , with three busbars (+, -, PE) for potential distribution, per potential:		
(+) two power terminals/48 distributor terminal blocks		168.80
(-) two power terminals/24 distributor terminal blocks		
(PE) 2 power terminals/72 distributor terminal blocks		
<b>VARIOFACE module</b> , with six busbars (P1 to P6) for potential distribution, per potential:		
2 power terminals/12 distributor terminal blocks		123.80



With push-in connection and 2 potential levels

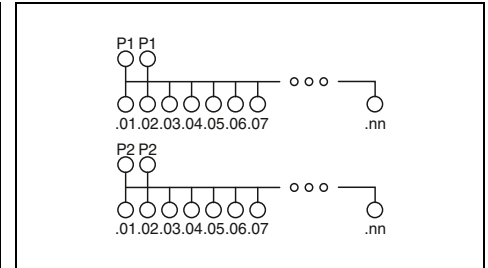

#### Technical data

Operating voltage	250 V AC/DC
Max. perm. current (per branch)	15 A
Total current	30 A (per potential)
Ambient temperature (operation)	-20 °C ... 50 °C
Mounting position	any
Standards/regulations	IEC 60664, DIN EN 50178, IEC 62103
Supply connection data solid / stranded / AWG	0.25 - 6 mm <sup>2</sup> / 0.25 - 4 mm <sup>2</sup> / 24 - 10
Distribution connection data solid / stranded / AWG	0.14 - 2.5 mm <sup>2</sup> / 0.14 - 2.5 mm <sup>2</sup> / 26 - 14
Dimensions	H / D 75.8 mm / 63 mm

#### Ordering data

Type	Order No.	Pcs. / Pkt.
<b>VIP-2/SC/PDM-2/16</b>	<b>2315256</b>	1
<b>VIP-2/SC/PDM-2/24</b>	<b>2315269</b>	1
<b>VIP-2/SC/PDM-2/32</b>	<b>2315272</b>	1
<b>VIP-2/SC/PDM-2/48</b>	<b>2903717</b>	1
<b>VIP-3/PT/PDM-2/16</b>	<b>2903797</b>	1
<b>VIP-3/PT/PDM-2/24</b>	<b>2903798</b>	1
<b>VIP-3/PT/PDM-2/32</b>	<b>2903799</b>	1
<b>VIP-3/PT/PDM-2/48</b>	<b>2903800</b>	1

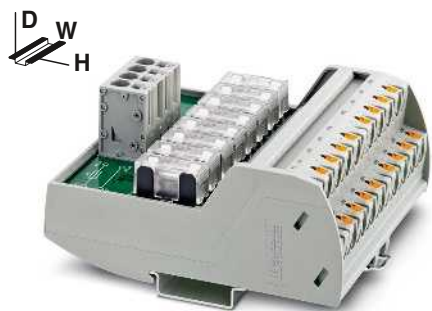

With push-in connection and 2 potential levels and eight 6.3 A fuses

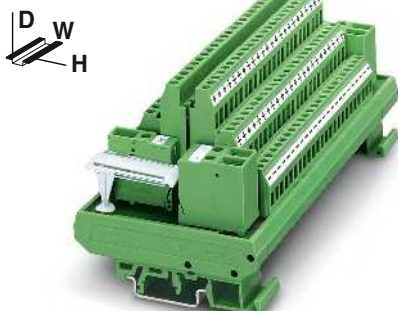

With screw connection and 3 potential levels

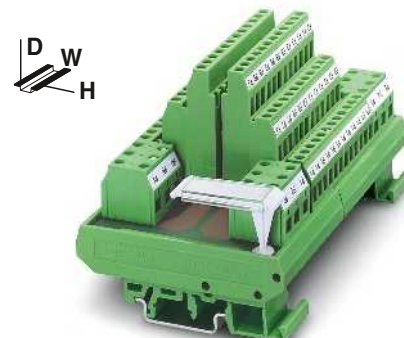

With screw connection and 6 potential levels

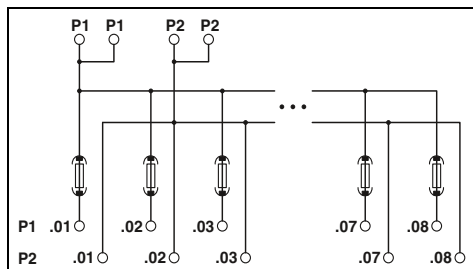

### Technical data

250 V AC/DC  
6.3 A (fuse limited)  
30 A (per potential)  
-20 °C ... 60 °C  
any  
IEC 60664, DIN EN 50178, IEC 62103  
0.2 - 10 mm<sup>2</sup> / 0.2 - 6 mm<sup>2</sup> / 24 - 8

0.14 - 2.5 mm<sup>2</sup> / 0.14 - 2.5 mm<sup>2</sup> / 26 - 14

109.8 mm / 51 mm

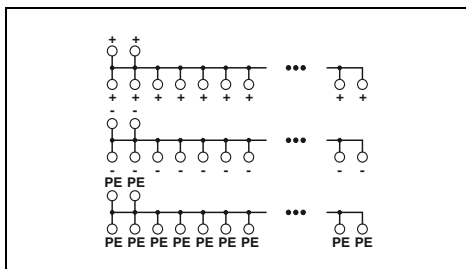

### Technical data

250 V AC/DC  
16 A  
16 A (per potential)  
-20 °C ... 50 °C  
any  
IEC 60664, DIN EN 50178, IEC 62103  
0.5 - 6 mm<sup>2</sup> / 0.5 - 4 mm<sup>2</sup> / 20 - 10

0.2 - 4 mm<sup>2</sup> / 0.2 - 2.5 mm<sup>2</sup> / 24 - 12

77 mm / 72 mm

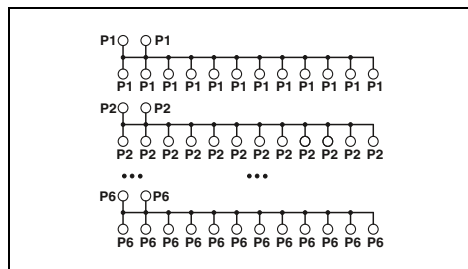

### Technical data

250 V AC/DC  
16 A  
16 A (per potential)  
-20 °C ... 50 °C  
any  
IEC 60664, DIN EN 50178, IEC 62103  
0.2 - 6 mm<sup>2</sup> / 0.2 - 4 mm<sup>2</sup> / 24 - 10

0.2 - 4 mm<sup>2</sup> / 0.2 - 2.5 mm<sup>2</sup> / 24 - 12

77 mm / 72 mm

### Ordering data

Type	Order No.	Pcs. / Pkt.
VIP-2/PT/PDM-2/16/FU 6.3A	2903603	1

### Ordering data

Type	Order No.	Pcs. / Pkt.
UMK- PVB	2971302	1

### Ordering data

Type	Order No.	Pcs. / Pkt.
UMK- PVB 6	2972136	1

# System cabling for controllers

## Tables, dimensional drawings

### Modules for IEC 60603/DIN 41612 connectors

Cable housing suitable for snap-in locking:

Manufacturer	Type F 32 and 48-pos.	
HARTING	Types "B" and "D"	

Cable housing suitable for screw locking:

Manufacturer	Type C, 64-pos.	Type D, 32-pos.
ERNI	KSG 173...	KSG 173...
AMP	826196-1	826196-1

Cable housing suitable for screw locking:

Manufacturer	Type E, 48-pos.	Type F, 32 and 48-pos.
ERNI	KSG 173...	KSG 203...
AMP	-	826198-1

### Modules for ELCO connectors

Dimensional drawing for UMK-EC38/38-XOL

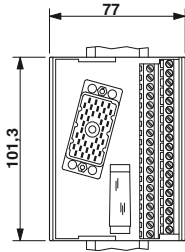

Dimensional drawing for UMK-EC38/38-XOR

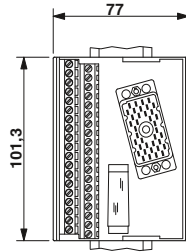

Dimensional drawing for UMK-EC56/56-XOL

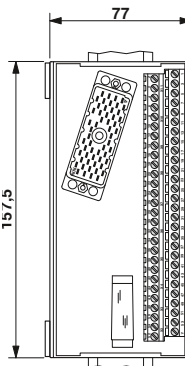

Dimensional drawing for UMK-EC56/56-XOR

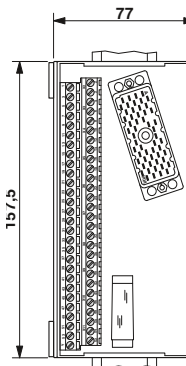

Dimensional drawing for UMK-EC56/Front 2,5V/R

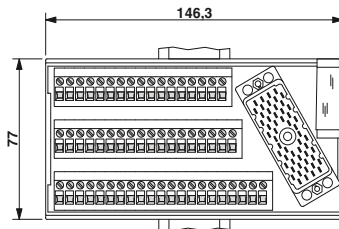

Dimensional drawing for UMK-EC56/Front 2,5V/L

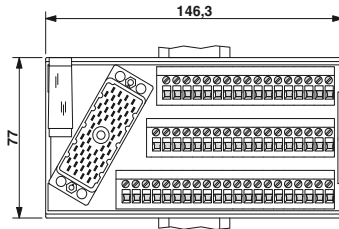

Dimensional drawing for UMK-EC56/32-XOL

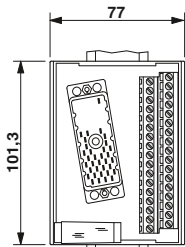

Dimensional drawing for UMK-EC56/32-XOR

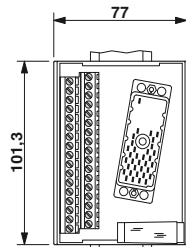

Pin assignment UMK-EC38/38...

Terminal block	Pin strip
1	A
2	B
3	C
4	D
5	E
6	F
7	H
8	J
9	K
10	L
11	M
12	N
13	P
14	R
15	S
16	T
17	U
18	V
19	W
20	X
21	Y
22	Z
23	AA
24	BB
25	DD
26	EE
27	FF
28	HH
29	JJ
30	KK
31	LL
32	MM
33	NN
34	PP
35	RR
36	SS
37	TT
CC	CC

Pin assignment UMK-EC56/56...

Terminal block	Pin strip
Z	Z
1	A
2	B
3	C
4	D
5	E
6	F
7	H
8	J
9	K
10	L
11	M
12	N
13	P
14	R
15	S
16	T
17	U
18	V
19	W
20	X
21	a
22	b
23	c
24	d
25	e
26	f
27	h
28	j
29	k
30	l
31	m
32	n
33	p
34	r
35	s
36	t
37	u
38	v
39	w
40	x
41	y
42	z
43	AA
44	BB
45	CC
46	DD
47	EE
48	FF
49	HH
50	JJ
51	KK
52	LL
53	MM
54	NN
Y	Y (shield)

Modules for ELCO connectors with protection type Ex i

Pin assignment  
UMK-EC56/Front 2,5V/...

Terminal block	ELCO connector
X	N.C.
1	A
2	B
3	C
4	D
5	E
6	F
7	H
8	J
9	K
10	L
11	M
12	N
13	P
14	R
15	S
16	T
17	U
18	V
19	W
20	X
21	a
22	b
23	c
24	d
25	e
26	f
27	h
28	j
29	k
30	l
31	m
32	n
33	p
34	r
35	s
36	t
37	u
38	v
39	w
40	x
41	y
42	z
43	AA
44	BB
45	CC
46	DD
47	EE
48	FF
49	HH
50	JJ
51	KK
52	LL
53	MM
54	NN
Y	Y (shield)

Pin assignment  
UMK-EC56/32-...

Terminal block	ELCO connector
1	A
2	B
3	C
4	D
5	E
6	F
7	H
8	J
9	K
10	L
11	M
12	N
13	P
14	R
15	S
16	T
17	U
18	V
19	W
20	X
21	Z
22	a
23	b
24	c
25	d
26	e
27	f
28	h
29	j
30	k
31	l
32	m
Y	NN + Y

Dimensional drawing for  
UMK-EC90/32/EX-XUL

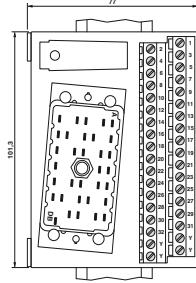

Dimensional drawing for  
UMK-EC90/32/EX-XUR

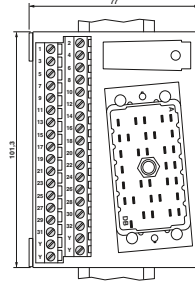

Dimensional drawing for  
UMK-EC56/25/EX-L

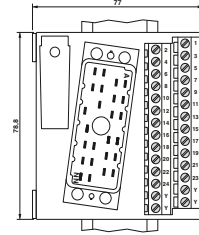

Dimensional drawing for  
UMK-EC56/25/EX-R

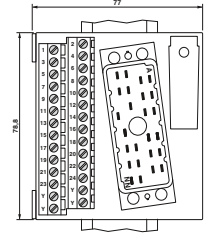

Dimensional drawing for  
UMK-EC90/32/EX-XOL

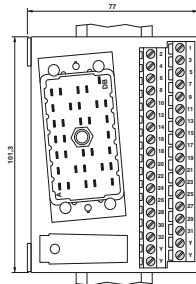

Dimensional drawing for  
UMK-EC90/32/EX-XOR

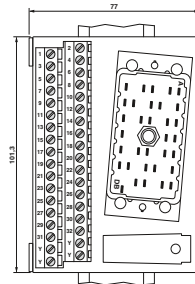

Dimensional drawing for UMK-EC 56/25/EX/Front 2,5 V/L

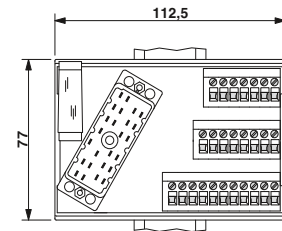

Dimensional drawing for UMK-EC 56/25/EX/Front 2,5 V/R

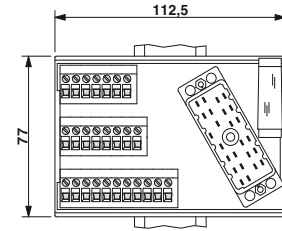

Pin assignment  
UMK-EC90/32/EX-...

Terminal block	Pin strip	Channel
1	H	
2	J	1
3	L	
4	M	2
5	P	
6	X	3
7	Z	
8	AA	4
9	AC	
10	AD	5
11	AM	
12	ON	6
13	AR	
14	AS	7
15	AU	
16	BC	8
17	AZ	
18	BA	9
19	BJ	
20	BK	10
21	BM	
22	BN	11
23	BR	
24	BY	12
25	CA	
26	CB	13
27	CD	
28	CE	14
29	CN	
30	CP	15
31	CS	
32	CT	16
Y	DB	

Pin assignment  
UMK-EC 56/25/EX-...

Terminal block	Pin strip	Channel
1	C	
2	D	1
3	E	
4	F	2
5	N	
6	P	3
7	R	
8	S	4
9	a	
10	b	5
11	d	
12	j	6
13	k	
14	l	7
15	s	
16	t	8
17	u	
18	v	9
19	BB	
20	CC	10
21	DD	
22	EE	11
23	MM	
24	NN	12
Y	Y	

## Quality in quantity

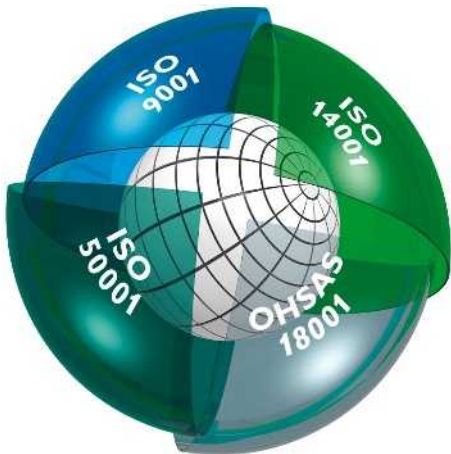

### Integrated management system

The aim of the Phoenix Contact integrated management system is to coordinate all the requirements regarding products, processes, and organization.

Statutory and regulatory requirements, as well as those of international standards and our customers, are met and, in some cases, even exceeded in all phases of the product lifecycle.

The Phoenix Contact management system is monitored by internationally recognized independent bodies each year to ensure that quality, environmental protection, energy efficiency, and occupational safety have been integrated in conformance with the relevant requirements. Certification in accordance with international standards ISO 9001, ISO 14001, ISO 50001, and BS OHSAS 18001 is the result of our corporate philosophy of meeting the needs of our customers, staff, and environment as best as possible. They serve as the basis for innovative products with the familiar high Phoenix quality standard, actively practiced environmental protection through efficient production and products that conserve resources, and responsibility in the field of occupational health and safety. It goes without saying that we integrate all further requirements of standards, international approvals or special customer requirements into our company processes.

This system provides a building block for the success of the Phoenix Contact Group and its products and services.

### CE marking

CE marking was introduced as an important instrument for the free movement of goods and services within the single European market. By attaching the mark to a product, the manufacturer confirms that it complies with all applicable European Union (EU) directives. EC directives describe the product properties with regard to device safety and avoiding danger. These are legally binding regulations of the European Union (EU). In other words, compliance with the requirements is a **statutory condition for**

### marketing the product within the EU.

Where applicable, the products that our company currently manufactures fall within the scope of the following directives:

- 2006/95/EC and 2014/35/EU  
Electrical equipment designed for use within certain voltage limits (Low-Voltage Directive)
- 2004/108/EC and 2014/30/EU  
Electromagnetic compatibility (EMC Directive)
- 2004/22/EC and 2014/32/EU  
Measuring instruments
- 2006/42/EC  
Safety of machinery (Machinery Directive)
- 94/9/EC and 2014/34/EU  
Equipment and protective systems intended for use in potentially explosive areas (ATEX Directive)
- 1999/5/EC  
R&TTE Directive and 2014/53/EU  
Radio Equipment Directive

The standards upon which the specified directives are based have been part of our standard of development for a long time. This guarantees conformance with European directives. The numbers of the directives indicate their version at the time of publication. In the event of changes to directives and/or standards, our products will undergo conformity assessment again in good time and a new declaration of conformity will be issued promptly. The current declarations for each product can also be found in our download area.

The EMC Directive occupies a special place among the European directives listed. It defines electromagnetic compatibility as a fundamental property of devices based on mandatory guidelines. European Law therefore acknowledges the electromagnetic compatibility of devices and systems as an important condition for error-free operation of machinery and systems. Phoenix Contact is one of the leading international companies in surge protection, and therefore possesses broad expertise in EMC. This expertise and the experience gained over years of developing and applying industrial interface and communication technology have resulted in our products having an extremely high standard of quality with regard to electromagnetic compatibility. It was with a view to providing other companies with this expertise that our associate company, Phoenix Testlab, was founded. Phoenix Testlab GmbH is an independent, accredited service provider offering EMC testing that conforms to European standards. At Phoenix Testlab, devices are also tested with regard to their electrical safety, mechanical influences, and their behavior in relation to environmental influences. Furthermore, Phoenix Testlab is a “Notified Body” in

accordance with EMC Directive 2004/108/EC and according to R&TTE Directive 1999/5/EC for radio and telecommunications terminal equipment. As a “Telecom Certification Body” (TCB), Phoenix Testlab may also approve these products for markets in the USA, Canada, and Japan.

### Standards and regulations

All relevant standards and regulations are used as the basis for the development and maintenance of our products.

International standards are subject to continuous changes as a result of harmonization and new developments. In line with this process, the current version of all standards that are relevant to our products is documented in the product area on our website at

[www.phoenixcontact.net/products](http://www.phoenixcontact.net/products).

### Online product information service on the web

Phoenix Contact's product range is growing constantly.

Due to our commitment to product monitoring, all products are subject to improvement.

The Internet is an ideal platform to quickly communicate new product developments and improvements to the market.

You can quickly access the relevant Phoenix Contact website for your region via [www.phoenixcontact.com](http://www.phoenixcontact.com). Here, you will always find the latest overview of products, solutions, and services from Phoenix Contact. This includes technical documents, such as data sheets and user manuals, the latest driver and demo software, plus a means of contacting the appropriate contact person directly.



## Shock protection

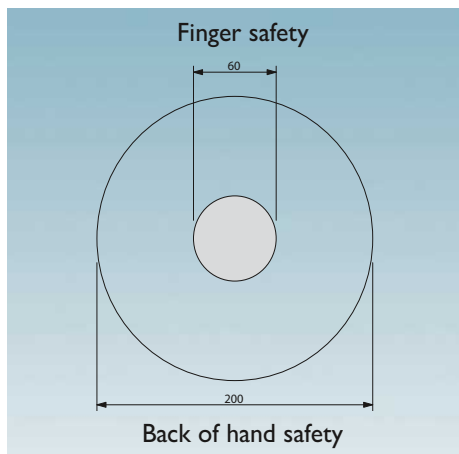

Example: pressure actuation

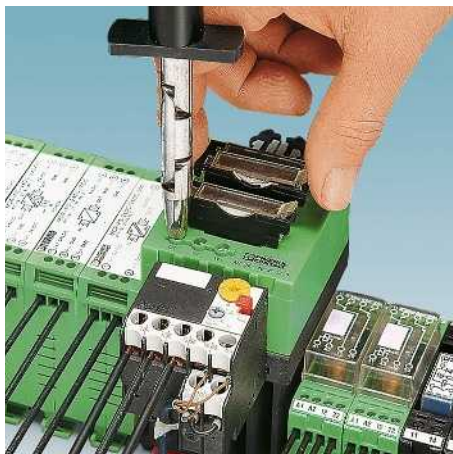

Finger safety



Back of hand safety

The accident prevention regulations BGV A 2 issued by the German employer's liability insurance association for precision mechanics and electrical engineering apply to the operators of electrical systems and are aimed at the prevention of electrical accidents by means of special safety requirements.

These regulations contain specifications regarding the safety distances for work, operation, and occasional handling in the proximity of "live parts" in low-voltage systems up to 1000 V ~ or 1500 V –.

- Work with live parts is only permitted once they have been de-energized.
- Operational activities are only permitted in the vicinity of live parts if these parts are de-energized or are protected against direct contact (§ 6). The following safety measures apply when working in the vicinity of live parts:
- Provision of the de-energized state for the duration of the work
- Ensure shock protection is in place in the form of covers or barriers during the work
- Assurance that the permitted proximity limits will not be violated (§ 7).

The term "occasional handling" has been introduced for the operation of elements such as pushbuttons, rocker arms or rotary buttons in the proximity of live parts.

According to VDE 0105-1, this is covered by "operation with partial protection against direct contact".

Detailed specifications for "occasional handling" can be found in DIN VDE 0106-100. This specifies to what degree live parts in the proximity of operating elements are to be protected against contact. The basis for this is the definition of a "protection area for occasional handling"; this is the area into which the user must reach in order to handle the machine.

The most important thing is that an area formed by an even envelope curve 30 mm in radius must surround the live parts. This area must be **touch proof**, i.e., the live parts of the electrical device must not be within reach of the VDE test finger according to IEC 60529/DIN VDE 0470-1 (test finger).

Back of hand safety is specified for the "rest of the area" up to 100 mm around the operating element. **Back of hand safety** means that when a force of 50 N is applied to a ball with a diameter of 50 mm, this does not come into contact with the live parts of the equipment. No special measures for ensuring contact safety are stipulated outside this area.

Note: systems and equipment that are operated with SELV up to 25 V ~ or 60 V – are considered to be protected against "direct contact".

According to § 5, Subsection 4 of the BGV A 2 regulations, there is no need to test the condition of the system prior to initial startup if the company has confirmation from the manufacturer or installer that the electrical systems and equipment conform to BGV A 2. The confirmation required relates to systems and equipment that have been installed and are ready for operation and can only be issued by the installer or installation company. The manufacturer of the electrical equipment can only issue a confirmation that products have been produced in accordance with the relevant electrotechnical DIN VDE regulations stipulated in BGV A 2. The installer must bear this in mind when selecting the equipment to be used.

In the field of connection technology, Phoenix Contact offers a wide range of products that are touch proof or that can be protected against contact using covers. Depending on the conditions, all of this

must be taken into account when selecting the individual types of terminal block and accessories.

## Quality features of insulating housing

### Thermoplastics

The majority of our insulating housing is made from thermoplastic materials. Roughly speaking, these can be divided into amorphous and semi-crystalline substances. Thermoplastics are processed using the efficient and environmentally-friendly injection molding process. They have good recycling properties and can be re-used. We use many materials that are modified in different ways to meet the demanding requirements that electrical and electronic modules, devices, and systems have to meet with regard to their mechanical, thermal, and electrical properties.

### Behavior of plastics under the influence of temperature (operating temperatures, mechanical influences)

All plastics undergo a process referred to as thermal aging when they are subjected to heat over long periods. This process causes changes in the mechanical and electrical properties of the material. External influences, e.g., radiation, additional mechanical, chemical or electrical stresses, amplify this effect. Special tests on samples can yield characteristic data which provides a good means of drawing comparisons between different plastics. However, applying these characteristics to an evaluation of molded plastic parts is only possible to a limited extent, and can only give the designer a rough guide when it comes to selecting a plastic material. This catalog uses the following assessment criteria: the **RTI value** according to UL746B/ANSI 746 B (elec. based on electric strength) and the **Ti value** according to IEC 60216-1 (based on a 50% reduction in tensile strength after 20,000 hours).

IEC 60947-7-1/EN 60947-7-1 specifies a permissible temperature increase of 45 K for terminal blocks under nominal load. Phoenix Contact terminal blocks meet this requirement.

The properties of plastics are not only affected by the influence of heat as described above; they also undergo changes as a result of cold influences. When subjected to cold as well as low levels of humidity, plastics become increasingly brittle with the result that they are no longer capable of withstanding the same mechanical loads. As the table on the right shows, the plastics concerned can be used down to a temperature of -40°C, but only without a mechanical load. As far as the products presented in the catalog are concerned, it is the ambient temperature specified in each case that is to be regarded as definitive for operation. Regardless of the plastics used, this may be subject to further restrictions (e.g., limited to -20°C) as a result of the components used or other restrictive

parameters.

At very low temperatures, this means that any form of mechanical load on the plastic components must be avoided (e.g., mounting of products on/removal of products from the DIN rail, actuation of terminal points, locking/ejection of relays from bases, prizing out of jumpers, bending of cables and lines, etc.), as there is always an associated risk of damage. Unless otherwise indicated, it is recommended that you carry out the specified mounting/operational tasks in a temperature range from -10°C to +40°C.

### Inflammability characteristics of plastics (UL 94)

The inflammability tests for plastics have been defined by the Underwriters Laboratory (USA) in regulation UL 94. This applies to all usage ranges, but in particular to electrical engineering. A horizontal or vertical test is carried out at the test laboratory to determine the inflammability of the plastic material with a naked flame. In order of increasing flame-retardant behavior, the evaluation classes are HB, V2, V1, V0, and 5V. Test results are recorded on “yellow cards” and are published annually in the **Recognized Component Directory**.

### Thermoplastics: non-reinforced polyamide, PA

We use the modern, semi-crystalline polyamide insulation material, which has now become an essential component in electrical engineering and electronics. It has long occupied a leading position and is authorized for use by the relevant approval authorities such as the CSA, NEMKO, KEMA, PTB, SEV, UL, VDE, etc.

Polyamide also has excellent electrical, mechanical, chemical, and other properties, even at high operating temperatures. Brief peak temperatures up to approximately 200°C are permitted as a result of heat aging stabilization. Depending on the type (PA 4.6, 6.6, 6.10, etc.), its melting point is in the region of 215°C to 295°C.

Polyamide absorbs moisture from its surroundings, on average 2.8%. However, this moisture is not in the form of crystallization water in the plastic itself, but chemically bonded H<sub>2</sub>O groups in the molecule structure. This makes the plastic flexible and resistant to breakage, even at temperatures as low as -40°C. According to UL 94, PA belongs to inflammability class V2 to V0.

### Thermoplastics: polyester, PBT

We use the semi-crystalline thermoplastic polyester in non-reinforced and fiberglass-reinforced variants for special applications which require increased dimensional and form stability.

In addition to the high operating temperature, the material is characterized by excellent mechanical strength and hardness, and does not absorb moisture from its surroundings. PBT is therefore particularly suitable for strips, for example, which are soldered onto PCBs and subsequently have to pass a burn-in test while they are subjected to heat. According to UL 94, PBT belongs to inflammability class V2 to V0.

### Thermoplastics: polycarbonate, PC

Polycarbonate combines many advantages such as rigidity, impact strength, transparency, dimensional stability, good insulation properties, and resistance to heat.

This amorphous material only absorbs moisture to a very limited degree, and is used for items such as large, rigid electronic component housing.

In its transparent form, polycarbonate is particularly suitable for use as a material for cover profiles or marking materials.

PC has good resistance properties against mineral acids, saturated aliphatic hydrocarbons, gasoline, greases, and oils.

The material is less resistant to solvents, benzene, lyes, acetone, and ammonia. Strain cracks may result from contact with certain chemicals.

According to UL 94, PC belongs to inflammability class V2 to V0.

### Thermoplastics: polycarbonate fiber-reinforced, PC-F

Compared to non-reinforced materials, fiber-reinforced polycarbonates feature greater rigidity, impact strength, and operating temperature. In other respects, their properties are largely identical to those of non-reinforced polycarbonate.



**Thermoplastics: ABS**

We use the thermoplastic molding compound ABS for products which must have good impact and notched impact properties in addition to high mechanical stability and rigidity. The products are resistant to chemicals and stress cracking due to their special surface quality and hardness.

The characteristic thermal properties provide good dimensional stability at both low and high temperatures. Products made from ABS can be coated with metallic surfaces, e.g., nickel.

The inflammability class of the molding compound used is HB to V0 according to UL 94.

Properties	Unit/level	Polyamide PA	Polyester PBT	Polycarbonate PC	Polycarbonate PC-F	ABS
Operating temperature RTI */**	°C	≤ 105	≤ 105	≤ 125	≤ 120	≤ 80
Minimum temperature (without mechanical load)	°C	-40	-40	-40	-40	-40
Electric strength acc. to IEC 60243-1/DIN VDE 0303-21	kV/cm	600	400	> 300		850
Resistance to creepage IEC 60112/DIN VDE 0303-1	CTI...M	550	225	175		200
	CTI...	600	225	175	175	600
Tropical and termite resistance		Good	Good	Good		
Specific contact resistance IEC 60093/VDE 0303 Part 30; IEC 60167/VDE 0303 Part 31	Ω cm	10 <sup>12</sup>	10 <sup>16</sup>	> 10 <sup>16</sup>	> 10 <sup>14</sup>	10 <sup>14</sup>
Surface resistance IEC 60093/VDE 0303 Part 30; IEC 60167/VDE 0303 Part 31	Ω	10 <sup>10</sup>	10 <sup>13</sup>	> 10 <sup>14</sup>		10 <sup>13</sup>
Inflammability class according to UL 94		V2-V0	V0	V2-V0	V0	HB - V0

\* According to UL 746 B/ANSI 746 B (elec.)

\*\* Minimum value

**Dimensions**

**Dimensions: Width/Height/Depth**



The dimensions “**Width/Height/Depth**” are defined as follows for all DIN-rail-mountable products in the INTERFACE range:

- **Width**: measurement taken along the DIN rail
- **Height**: measurement taken across the DIN rail
- **Depth**: measurement taken starting from the mounting plate and including the NS 35/7,5 DIN rail (EN 60715)

The width, height, and depth never change, even if the products shown in this catalog happen to be photographed from two different perspectives (horizontal or vertical).

To make things easier for you, one of the above two symbols has been included next to each product photo:

**EMC: Class A product:**

In accordance with statutory regulations, our products are indicated with this footnote if they are intended for use in industrial environments. This means that the permitted limit values for residential applications may be exceeded in the event of conducted and emitted disturbance variables. In such cases, the operator may have to take additional safety measures in order to ensure electromagnetic compatibility in residential applications.

**Note:**

Subject to changes that serve the purpose of technical progress.

## Connection cross section

The rated cross section of terminal blocks must be specified by the manufacturer according to IEC 60947-7-1. The rated cross section is the maximum conductor cross section that can be connected in single, multi or fine-strand versions subject to specific thermal, mechanical, and electrical requirements.

The manufacturer must also specify the **rated connection capacity**, i.e., the area of the conductor that can be connected, as well as the number of conductors that can be connected simultaneously and the necessary preparation of the conductor ends. The conductors can be **solid (single or multi-**

**strand) or stranded (fine-strand).**

These values can be found in the product-specific technical data.

The rated connection capacity of Phoenix Contact terminal blocks usually exceeds standard requirements, which specify that it must only be possible to connect one conductor with one of the two next smallest cross sections, excluding the rated cross section (standardized for the cross section range from 0.2 to 35 mm<sup>2</sup>).

In addition, conductors with a rated cross section can usually be wired with ferrules with plastic sleeve.

Phoenix Contact terminal blocks are

designed to allow copper cables to be connected to them without any special treatment. "Special treatment" or the use of ferrules – both permitted according to IEC 60947-7-1 – are not required. If ferrules are nevertheless used to protect stranded conductors against splicing, the connection capacity of the stranded conductor is generally reduced by one level.

## Structure and dimensions of connecting cables

Cross section [mm <sup>2</sup> ]	Single-strand		Multi-strand		Fine-strand		Gauge No. AWG	American Wire Gauge [AWG]					
	Diameter max. dimension	Number of wires	Diameter max. dimension	Number of wires (minimum number)	Diameter max. dimension	Number of wires (guide value)		Solid wires			Stranded wires		
								[Ø mm]	[circ. mils]	[mm <sup>2</sup> ]	[Ø mm]	[circ. mils]	[mm <sup>2</sup> ]
0.2	0.5	1	–	–	–	–	24	0.51	404	0.21	–	–	–
0.5	0.9	1	1.1	7	1.1	16	20	0.81	1022	0.52	0.97	1111	0.56
0.75	1.0	1	1.2	7	1.3	24	18	1.02	1620	0.82	1.16	1600	0.82
1	1.2	1	1.4	7	1.5	32	(17)	1.15	2050	1.04	–	–	–
–	–	–	–	–	–	–	16	1.29	2580	1.31	1.50	2580	1.32
1.5	1.5	1	1.7	7	1.8	30	(15)	1.45	3260	1.65	–	–	–
–	–	–	–	–	–	–	14	1.63	4110	2.08	1.85	4100	2.09
2.5	1.9	1	2.2	7	2.3	50	(13)	1.83	5180	2.63	–	–	–
–	–	–	–	–	–	–	12	2.05	6530	3.31	2.41	6500	3.32
4	2.4	1	2.7	7	2.9	56	(11)	2.30	8230	4.17	–	–	–
–	–	–	–	–	–	–	10	2.59	10380	5.26	2.95	10530	5.37
6	2.9	1	3.3	7	3.9	84	(9)	2.91	13100	6.63	–	–	–
–	–	–	–	–	–	–	8	3.26	16510	8.37	3.73	16625	8.48

## Tightening torque of terminal block screws

IEC 60947-1/EN 60947-1, modified, Table 4 specifies tightening torques for screw connections based on the screw size for electrical and mechanical type tests.

### Extract from IEC 60947-1/EN 60947-1, Table 4

The torque according to IEC and the recommended torque for Phoenix Contact terminal blocks are specified

Thread	Head screw with slot	
	Torque	Recommended tightening torque
	[Nm]	[Nm]
M2.5 (M2.6)	0.4	0.4-0.5
M3	0.5	0.5-0.6
M3.5	0.8	0.8-1.0
M4	1.2	1.2-1.5

















































## Current carrying capacity

Standard IEC 60947-7-1/EN 60947-7-1/DIN VDE 0611-1 specifies the test currents for the individual conductor cross sections listed in the adjacent table. The corresponding currents are listed with the connection data for the individual terminal blocks. The type tests of terminal blocks are based on this data.

### Test currents according to IEC 60947-7-1/EN 60947-7-1, Table 5

Rated cross section	[mm <sup>2</sup> ]	0.2	0.5	0.75	1.0	1.5	2.5	4	6	10	16
Test current	[A]	4	6	9	13.5	17.5	24	32	41	57	76

## Certification bodies and safety marks

Certification bodies and approvals	Country code	 Explosion protection	Country code	Ship classification societies	Country code
 IECEE CB Scheme (in combination with certifying body)	International	  International Electrotechnical Commission	International	 Bureau Veritas	FR
 CENELEC Certification Agreement (CCA inspection report) (in combination with certifying body)	EU	 DEKRA DEKRA Certification B.V.	NL	 Germanischer Lloyd AG	DE
 Canadian Standards Association (CSA)	CA	 Physikalisch-Technische Bundesanstalt	DE	 Lloyd's Register of Shipping	GB
 Canadian Standards Association (CSA) - CSA approval for the USA -	US	 KIWA Nederland B.V.	NL	 Nippon Kaiji Kyokai	JP
 Canadian Standards Association. (CSA) Combined logo - CSA approval for Canada and the USA -	CA US	 QS Schaffhausen AG	CH	 Det Norske Veritas	NO
 Underwriters Laboratories Inc. (UL)	US	 VTT Expert Services Oy	FI	 Polski Rejestr Statków	PL
 Underwriters Laboratories Inc. (UL) - UL approval for Canada -	CA	 IBEXU Institut für Sicherheitstechnik GmbH	DE	 Russian Maritime Register of Shipping	RU
 Underwriters Laboratories Inc. (UL) Combined logo - UL approval for the USA and Canada -	US CA	 TÜV Rheinland do Brasil	BR	 Korean Register of Shipping	KR
 INSIEME PER LA QUALITA'E LA SICUREZZA	IT	 Technischer Überwachungsverein Nord	DE	 American Bureau of Shipping	US
 Eurasian Conformity	BY KZ RU	 DEKRA EXAM GmbH	DE		
 DEKRA Certification B.V.	NL	 Canadian Standards Association (CSA)	CA		
 Österreichischer Verband für Elektrotechnik	AT	 Canadian Standards Association (CSA) - CSA approval for the USA -	US		
 electrosuisse SEV Verband für Elektro-, Energie- und Informationstechnik	CH	 Canadian Standards Association. (CSA) Combined logo - CSA approval for Canada and the USA -	CA US		
 Verband Deutscher Elektrotechniker e.V. (VDE) - Approval of drawings - Reports with production monitoring	DE	 Underwriters Laboratories Inc. (UL)	US		
 Berufsgenossenschaft (BG) GS - Geprüfte Sicherheit	DE	 Underwriters Laboratories Inc. (UL) - UL approval for Canada -	CA		
 Intertek ETL Listed - Approval for the USA -	US	 Underwriters Laboratories Inc. (UL) Combined logo - UL approval for the USA and Canada -	US CA		
 Intertek ETL Listed - Approval for Canada -	CA	 FM Approvals	US		
 Intertek ETL Listed - Approval for the USA and Canada -	US CA	 Eurasian Conformity for Ex-products	BY KZ RU		
 TÜV Rheinland Industrie Service GmbH	DE				
 China Compulsory Certificate	CN				



For up-to-date modifications or supplements  
to the catalog contents, please visit:  
**[phoenixcontact.net/webcode/#0132](http://phoenixcontact.net/webcode/#0132)**



## Данный компонент на территории Российской Федерации

### Вы можете приобрести в компании MosChip.

Для оперативного оформления запроса Вам необходимо перейти по данной ссылке:

<http://moschip.ru/get-element>

Вы можете разместить у нас заказ для любого Вашего проекта, будь то серийное производство или разработка единичного прибора.

В нашем ассортименте представлены ведущие мировые производители активных и пассивных электронных компонентов.

Нашей специализацией является поставка электронной компонентной базы двойного назначения, продукции таких производителей как XILINX, Intel (ex.ALTERA), Vicor, Microchip, Texas Instruments, Analog Devices, Mini-Circuits, Amphenol, Glenair.

Сотрудничество с глобальными дистрибьюторами электронных компонентов, предоставляет возможность заказывать и получать с международных складов практически любой перечень компонентов в оптимальные для Вас сроки.

На всех этапах разработки и производства наши партнеры могут получить квалифицированную поддержку опытных инженеров.

Система менеджмента качества компании отвечает требованиям в соответствии с ГОСТ Р ИСО 9001, ГОСТ РВ 0015-002 и ЭС РД 009

### Офис по работе с юридическими лицами:

105318, г.Москва, ул.Щербаковская д.3, офис 1107, 1118, ДЦ «Щербаковский»

Телефон: +7 495 668-12-70 (многоканальный)

Факс: +7 495 668-12-70 (доб.304)

E-mail: [info@moschip.ru](mailto:info@moschip.ru)

Skype отдела продаж:

moschip.ru

moschip.ru\_4

moschip.ru\_6

moschip.ru\_9