

# Series 14

## Characteristics

The compact 22.5 mm Series 14 enables space-saving installations and is especially suited for:

- Flush design
- Raised design
- PCB (with adaptor)

The low level switching element is laid out for low current applications.

## Functions

The Series 14 incorporates the following functions:

- Indicator
- Pushbutton
- Illuminated pushbutton
- Mushroom-head pushbutton
- Keylock switch
- Selector switch
- Buzzer

## Market segments

The EAO Series 14 is especially suited for applications in the segments:

- Public transportation
- Machinery and Automation
- Construction machines and special-purpose vehicles
- Lifting and moving
- Panel building

Please refer to the EAO website to obtain detailed information regarding this series [www.products.eao.com](http://www.products.eao.com)  
Configure a product to your exact needs and request a quotation.





**Overview****Flush design**

Indicator	4
Buzzer	5
Illuminated pushbutton	6
Mushroom-head pushbutton	9
Keylock switch	14
Selector switch	16

**Raised design**

Indicator	18
Buzzer	20
Illuminated pushbutton	21
Mushroom-head pushbutton	24
Keylock switch	29
Selector switch	31

**Accessories** 33**Drawings** 55**Technical data** 56**Marking** 59**Application guidelines** 63**Index** 64

# 14 Flush design

## Indicator, IP 67



Product can differ from the current configuration.



Dimensions [mm]  
 L = Solder terminal,  
 L1 = Solder terminal 2.8 x 0.5 mm,  
 H = Universal terminal 2.0 x 0.5 mm

### Additional Information

- For front dimension Ø 35 mm
- For LED element fitting information see «Application guidelines»



Mounting cut-outs [mm]

### Equipment consisting of (schematic overview)



Each Part Number listed below includes all the black components shown in the 3D-drawing.

*To obtain a complete unit, please select the red components from the pages shown.*

Terminal	Part No.	Component layout	Wiring diagram	Weight
				
<b>Indicator actuator</b>				
Solder 2.8 x 0.5 mm	<b>14-040.002</b>		1	0.050 kg
Solder	<b>14-040.005</b>		1	0.050 kg
Universal 2.0 x 0.5 mm	<b>14-041.006</b>	1	1	0.050 kg

The component layouts you will find from page 55



## Buzzer, IP 40

### Equipment consisting of (schematic overview)



Buzzer



Pressure ring



Fixing nut

Each Part Number listed below includes all the black components shown in the 3D-drawing.



Dimensions [mm]



Product can differ from the current configuration.



Mounting cut-outs [mm]

### Additional Information

- Further information see «Technical data»
- The colour of anodized aluminium parts can vary due to technical production reasons
- For PCB application use adaptor Part-No. 31-942

Operating voltage	Front cap	Terminal	Part No.	Wiring diagram	Weight
 <p><b>Buzzer, Front dimension Ø 35 mm</b></p>	Aluminium black anodized	Solder 2.8 x 0.5 mm	<b>14-810.910</b>	1	0.016 kg
	Aluminium natural anodiset	Solder 2.8 x 0.5 mm	<b>14-810.918</b>	1	0.016 kg



Wiring diagram 1

# 14 Flush design

## Illuminated pushbutton, IP 67



Product can differ from the current configuration.



Dimensions [mm]  
 L = Solder terminal,  
 L1 = Solder terminal 2.8 x 0.5 mm,  
 H = Universal terminal 2.0 x 0.5 mm,  
 H1 = Universal-Solder terminal

### Additional Information

- For front dimension Ø 35 mm
- For LED element fitting information see «Application guidelines»



Mounting cut-outs [mm]

### Equipment consisting of (schematic overview)



Each Part Number listed below includes all the black components shown in the 3D-drawing.

To obtain a complete unit, please select the red components from the pages shown.

Switching system	Contacts	Diode 1N4007	Switching action	Terminal	Part No.	Component layout	Wiring diagram	Weight		
 <b>Illuminated pushbutton actuator</b>										
Low-level element	1 NC		B	Universal 2.0 x 0.5 mm	<b>14-436.036</b>	1	1	0.015 kg		
			C	Universal 2.0 x 0.5 mm	<b>14-476.036</b>	1	2	0.015 kg		
	1 NC + 1 NO		B	Universal 2.0 x 0.5 mm	<b>14-433.036</b>	1	3	0.015 kg		
			C	Universal 2.0 x 0.5 mm	<b>14-473.036</b>	1	4	0.015 kg		
	1 NO		B	Universal 2.0 x 0.5 mm	<b>14-435.036</b>	1	5	0.015 kg		
			C	Universal 2.0 x 0.5 mm	<b>14-475.036</b>	1	6	0.015 kg		
	2 NC		B	Universal 2.0 x 0.5 mm	<b>14-432.036</b>	1	7	0.015 kg		
			C	Universal 2.0 x 0.5 mm	<b>14-472.036</b>	1	8	0.015 kg		
	2 NO		B	Universal 2.0 x 0.5 mm	<b>14-431.036</b>	1	9	0.015 kg		
			C	Universal 2.0 x 0.5 mm	<b>14-471.036</b>	1	10	0.015 kg		
Snap-action switching element	1 NC + 1 NO	1	B	Universal-Solder	<b>14-743.0292</b>	1	11	0.014 kg		
			C	Universal-Solder	<b>14-747.0292</b>	1	12	0.014 kg		
		2	B	Universal-Solder	<b>14-744.0292</b>	1	13	0.014 kg		
			C	Universal-Solder	<b>14-748.0292</b>	1	14	0.014 kg		
			B	Solder 2.8 x 0.5 mm	<b>14-131.022</b>		24	0.013 kg		
			B	Solder	<b>14-131.0252</b>		15	0.013 kg		
			C	Solder 2.8 x 0.5 mm	<b>14-271.022</b>		25	0.013 kg		
			C	Solder	<b>14-271.0252</b>		16	0.013 kg		
			2 NC + 2 NO	2	B	Universal-Solder	<b>14-746.0292</b>	1	17	0.016 kg
					B	Solder	<b>14-132.0252</b>		18	0.015 kg

Switching system	Contacts	Diode 1N4007	Switching action	Terminal	Part No.	Component layout	Wiring diagram	Weight
Snap-action switching element	2 NC + 2 NO		C	Solder	<b>14-272.0252</b>		19	0.015 kg
	3 NC + 3 NO		B	Solder	<b>14-133.0252</b>		20	0.017 kg
			C	Solder	<b>14-273.0252</b>		21	0.017 kg
			B	Solder	<b>14-134.0252</b>		22	0.019 kg
	4 NC + 4 NO		C	Solder	<b>14-274.0252</b>		23	0.019 kg

Contacts: NC = Normally closed, NO = Normally open  
 Switching action: B = Momentary, C = Maintain  
 The component layouts you will find from page 55



# 14 Flush design



Wiring diagram 22

Wiring diagram 23



Wiring diagram 24

Wiring diagram 25



## Mushroom-head pushbutton, IP 67

### Equipment consisting of (schematic overview)

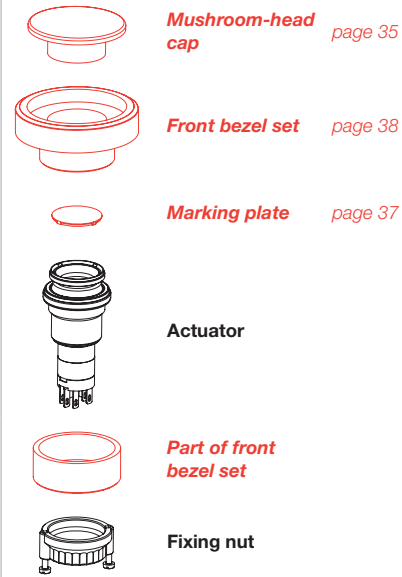

Each Part Number listed below includes all the black components shown in the 3D-drawing.

To obtain a complete unit, please select the red components from the pages shown.



Dimensions [mm]  
 L = Solder terminal,  
 L1 = Solder terminal 2.8 x 0.5 mm,  
 H = Universal terminal 2.0 x 0.5 mm



Product can differ from the current configuration.



Mounting cut-outs [mm]

### Additional Information

- For front dimension Ø 50 mm
- To obtain IP 67 use marking plate Part No. 704.609.9

Switching system	Contacts	Switching action	Terminal	Part No.	Component layout	Wiring diagram	Weight
 Low-level element	1 NC	B	Universal 2.0 x 0.5 mm	<b>14-436.036</b>	1	1	0.015 kg
		C	Universal 2.0 x 0.5 mm	<b>14-476.036</b>	1	2	0.015 kg
	1 NC + 1 NO	B	Universal 2.0 x 0.5 mm	<b>14-433.036</b>	1	3	0.015 kg
		C	Universal 2.0 x 0.5 mm	<b>14-473.036</b>	1	4	0.015 kg
	1 NO	B	Universal 2.0 x 0.5 mm	<b>14-435.036</b>	1	5	0.015 kg
		C	Universal 2.0 x 0.5 mm	<b>14-475.036</b>	1	6	0.015 kg
	2 NC	B	Universal 2.0 x 0.5 mm	<b>14-432.036</b>	1	7	0.015 kg
		C	Universal 2.0 x 0.5 mm	<b>14-472.036</b>	1	8	0.015 kg
	2 NO	B	Universal 2.0 x 0.5 mm	<b>14-431.036</b>	1	9	0.015 kg
		C	Universal 2.0 x 0.5 mm	<b>14-471.036</b>	1	10	0.015 kg
Snap-action switching element	1 NC + 1 NO	B	Solder	<b>14-131.0252</b>	11		0.013 kg
		B	Solder 2.8 x 0.5 mm	<b>14-131.022</b>	19		0.013 kg
		C	Solder	<b>14-271.0252</b>	12		0.013 kg
		B	Solder 2.8 x 0.5 mm	<b>14-271.022</b>	20		0.013 kg
	2 NC + 2 NO	B	Solder	<b>14-132.0252</b>	13		0.013 kg
		C	Solder	<b>14-272.0252</b>	14		0.013 kg
	3 NC + 3 NO	B	Solder	<b>14-133.0252</b>	15		0.013 kg
		C	Solder	<b>14-273.0252</b>	16		0.013 kg
	4 NC + 4 NO	B	Solder	<b>14-134.0252</b>	17		0.013 kg
		C	Solder	<b>14-274.0252</b>	18		0.013 kg

Contacts: NC = Normally closed, NO = Normally open  
 Switching action: B = Momentary, C = Maintain  
 The component layouts you will find from page 55

# 14 Flush design

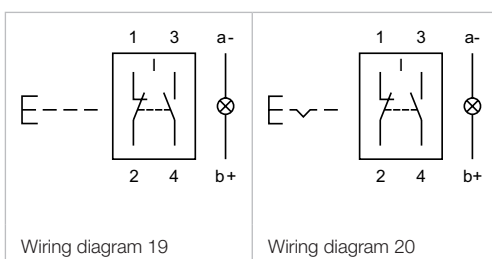
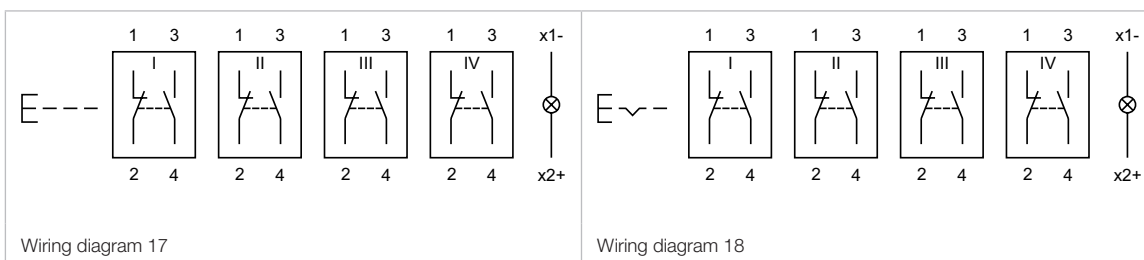

## Illuminated mushroom head pushbutton, IP 67

**Equipment consisting of (schematic overview)**

-  **Mushroom-head cap** *page 36*
-  **Front bezel set** *page 38*
-  **Marking plate** *page 37*
-  **Single-LED** *page 48*
-  **Actuator**
-  **Part of front bezel set**
-  **Fixing nut**



Dimensions [mm]  
 L = Solder terminal,  
 L1 = Solder terminal 2.8 x 0.5 mm,  
 H = Universal terminal 2.0 x 0.5 mm,  
 H1 = Universal-Solder terminal



Product can differ from the current configuration.



Mounting cut-outs [mm]

**Additional Information**

- For front dimension Ø 50 mm
- For LED element fitting information see «Application guidelines»
- To obtain IP 67 use marking plate Part No. 704.609.9

Each Part Number listed below includes all the black components shown in the 3D-drawing.

To obtain a complete unit, please select the red components from the pages shown.

Switching system	Contacts	Diode 1N4007	Switching action	Terminal	Part No.	Component layout	Wiring diagram	Weight	
 Low-level element	1 NC		B	Universal 2.0 x 0.5 mm	<b>14-436.036</b>	1	1	0.015 kg	
			C	Universal 2.0 x 0.5 mm	<b>14-476.036</b>	1	2	0.015 kg	
	1 NC + 1 NO		B	Universal 2.0 x 0.5 mm	<b>14-433.036</b>	1	3	0.015 kg	
			C	Universal 2.0 x 0.5 mm	<b>14-473.036</b>	1	4	0.015 kg	
	1 NO		B	Universal 2.0 x 0.5 mm	<b>14-435.036</b>	1	5	0.015 kg	
			C	Universal 2.0 x 0.5 mm	<b>14-475.036</b>	1	6	0.015 kg	
	2 NC		B	Universal 2.0 x 0.5 mm	<b>14-432.036</b>	1	7	0.015 kg	
			C	Universal 2.0 x 0.5 mm	<b>14-472.036</b>	1	8	0.015 kg	
	2 NO		B	Universal 2.0 x 0.5 mm	<b>14-431.036</b>	1	9	0.015 kg	
			C	Universal 2.0 x 0.5 mm	<b>14-471.036</b>	1	10	0.015 kg	
Snap-action switching element	1 NC + 1 NO	1	B	Universal 2.0 x 0.5 mm	<b>14-743.0292</b>	1	11	0.014 kg	
			C	Universal 2.0 x 0.5 mm	<b>14-747.0292</b>	1	12	0.014 kg	
		2	B	Universal 2.0 x 0.5 mm	<b>14-744.0292</b>	1	13	0.014 kg	
			C	Universal 2.0 x 0.5 mm	<b>14-748.0292</b>	1	14	0.014 kg	
				B	Solder	<b>14-131.0252</b>		15	0.013 kg
				B	Solder 2.8 x 0.5 mm	<b>14-131.022</b>		24	0.013 kg
				C	Solder	<b>14-271.0252</b>		16	0.013 kg
				C	Solder 2.8 x 0.5 mm	<b>14-271.022</b>		25	0.013 kg
	2 NC + 2 NO	2	B	Universal 2.0 x 0.5 mm	<b>14-746.0292</b>	1	17	0.014 kg	

# 14 Flush design

Switching system	Contacts	Diode 1N4007	Switching action	Terminal	Part No.	Component layout	Wiring diagram	Weight
Snap-action switching element	2 NC + 2 NO		B	Solder	<b>14-132.0252</b>		18	0.013 kg
			C	Solder	<b>14-272.0252</b>		19	0.013 kg
	3 NC + 3 NO		B	Solder	<b>14-133.0252</b>		20	0.013 kg
			C	Solder	<b>14-273.0252</b>		21	0.013 kg
	4 NC + 4 NO		B	Solder	<b>14-134.0252</b>		22	0.013 kg
			C	Solder	<b>14-274.0252</b>		23	0.013 kg

Contacts: NC = Normally closed, NO = Normally open  
 Switching action: B = Momentary, C = Maintain  
 The component layouts you will find from page 55





# 14 Flush design

## Keylock switch 2 positions, IP 65



Product can differ from the current configuration.



Dimensions [mm]  
 L = Solder terminal,  
 L1 = Solder terminal 2.8 x 0.5 mm,  
 H = Universal terminal 2.0 x 0.5 mm

### Additional Information

- For front dimension  $\varnothing 35$  mm
- Front plastic black
- The standard lock: KABA 1001
- Two keys are supplied with each key lock switch
- Optional lock numbers on request

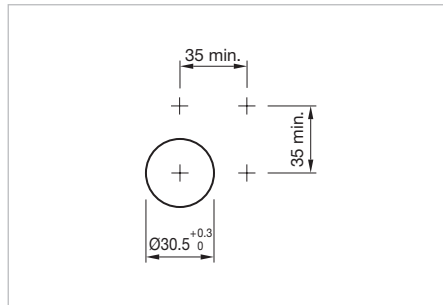

Mounting cut-outs [mm]



Switching positions (A = Rest, B = Momentary, C = Maintained)

### Equipment consisting of (schematic overview)



Each Part Number listed below includes all the black components shown in the 3D-drawing.

To obtain a complete unit, please select the red components from the pages shown.

Switching system	Contacts	Switching action	Switching angle	Key remove	Terminal	Part No.	Component layout	Wiring diagram	Weight	
 <b>Keylock switch actuator 2 positions</b>	2 NO	A - B	B = 42°	A	Universal 2.0 x 0.5 mm	<b>14-437.036K</b>	1	1	0.030 kg	
		1 NC + 1 NO	A - B	B = 42°	A	Universal 2.0 x 0.5 mm	<b>14-438.036K</b>	1	2	0.030 kg
	A - C		C = 90°	A + C	Universal 2.0 x 0.5 mm	<b>14-412.036K</b>	1	3	0.030 kg	
			A	Universal 2.0 x 0.5 mm	<b>14-415.036K</b>	1	3	0.030 kg		
			C	Universal 2.0 x 0.5 mm	<b>14-418.036K</b>	1	3	0.030 kg		
	2 NO	A - C	C = 90°	A + C	Universal 2.0 x 0.5 mm	<b>14-411.036K</b>	1	4	0.030 kg	
				A	Universal 2.0 x 0.5 mm	<b>14-414.036K</b>	1	4	0.030 kg	
				C	Universal 2.0 x 0.5 mm	<b>14-417.036K</b>	1	4	0.030 kg	
	Snap-action switching element	1 NC + 1 NO	A - B	B = 42°	A	Solder 2.8 x 0.5 mm	<b>14-141.022K</b>		5	0.029 kg
					A	Solder	<b>14-141.025K2</b>		5	0.029 kg
2 NC + 2 NO		A - B	B = 42°	A	Solder	<b>14-142.025K2</b>		6	0.031 kg	
				A	Solder	<b>14-143.025K2</b>		7	0.033 kg	
3 NC + 3 NO		A - B	B = 42°	A	Solder	<b>14-144.025K2</b>		8	0.035 kg	
4 NC + 4 NO		A - B	B = 42°	A	Solder	<b>14-135.025K2</b>		9	0.029 kg	
				A + C	Solder	<b>14-235.025K2</b>		9	0.029 kg	
				C	Solder	<b>14-335.025K2</b>		9	0.029 kg	
	A + C			Solder 2.8 x 0.5 mm	<b>14-135.022K</b>		9	0.029 kg		
1 NC + 1 NO	A - C	C = 90°	A	Solder 2.8 x 0.5 mm	<b>14-235.022K</b>		9	0.029 kg		

Switching system	Contacts	Switching action	Switching angle	Key remove	Terminal	Part No.	Component layout	Wiring diagram	Weight
Snap-action switching element	1 NC + 1 NO	A - C	C = 90°	C	Solder 2.8 x 0.5 mm	<b>14-335.022K</b>		9	0.029 kg
	2 NC + 2 NO	A - C	C = 90°	A + C	Solder	<b>14-136.025K2</b>		10	0.031 kg
				A	Solder	<b>14-236.025K2</b>		10	0.031 kg
				C	Solder	<b>14-336.025K2</b>		10	0.031 kg
	3 NC + 3 NO	A - C	C = 90°	A + C	Solder	<b>14-137.025K2</b>		11	0.033 kg
				A	Solder	<b>14-237.025K2</b>		11	0.033 kg
				C	Solder	<b>14-337.025K2</b>		11	0.033 kg
	4 NC + 4 NO	A - C	C = 90°	A + C	Solder	<b>14-138.025K2</b>		12	0.035 kg
				A	Solder	<b>14-238.025K2</b>		12	0.035 kg
				C	Solder	<b>14-338.025K2</b>		12	0.035 kg

Contacts: NC = Normally closed, NO = Normally open  
 Switching action: B = Momentary, C = Maintain  
 The component layouts you will find from page 15



# 14 Flush design

## Selector switch 2 positions, IP 67



Product can differ from the current configuration.



Dimensions [mm]  
 L = Solder terminal,  
 L1 = Solder terminal 2.8 x 0.5 mm,  
 H = Universal terminal 2.0 x 0.5 mm

### Additional Information

- For front dimension  $\varnothing 35$  mm
- Non-illuminative

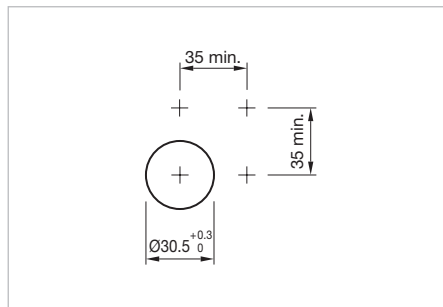

Mounting cut-outs [mm]



Switching positions (A = Rest, B = Momentary, C = Maintained)

### Equipment consisting of (schematic overview)



Each Part Number listed below includes all the black components shown in the 3D-drawing.

To obtain a complete unit, please select the red components from the pages shown.

Lever	Switching system	Contacts	Switching action	Switching angle	Terminal	Part No.	Component layout	Wiring diagram	Weight
 <p><b>Selector switch actuator 2 positions</b></p>	Plastic black short	1 NC + 1 NO	A - B	B = 42°	Universal 2.0 x 0.5 mm	<b>14-517.0360</b>	1	1	0.025 kg
			A - C	C = 90°	Universal 2.0 x 0.5 mm	<b>14-522.0360</b>	1	2	0.025 kg
		2 NC	A - C	C = 90°	Universal 2.0 x 0.5 mm	<b>14-521.0360</b>	1	3	0.025 kg
			2 NO	A - B	B = 42°	Universal 2.0 x 0.5 mm	<b>14-515.0360</b>	1	4
		2 NO	A - C	C = 90°	Universal 2.0 x 0.5 mm	<b>14-520.0360</b>	1	5	0.025 kg
			1 NC + 1 NO	A - B	B = 42°	Solder 2.8 x 0.5 mm	<b>14-501.0220</b>	6	0.024 kg
	A - B	B = 42°		Solder	<b>14-501.02502</b>	6	0.024 kg		
	A - C	C = 90°		Solder 2.8 x 0.5 mm	<b>14-506.0220</b>	7	0.024 kg		
	A - C	C = 90°		Solder	<b>14-506.02502</b>	7	0.024 kg		
	Snap-action switching element	2 NC + 2 NO	A - B	B = 42°	Solder	<b>14-502.02502</b>	8	0.026 kg	
			A - C	C = 90°	Solder	<b>14-507.02502</b>	9	0.026 kg	
		3 NC + 3 NO	A - B	B = 42°	Solder	<b>14-503.02502</b>	10	0.028 kg	
A - C			C = 90°	Solder	<b>14-508.02502</b>	11	0.028 kg		
4 NC + 4 NO	A - C	C = 90°	Solder	<b>14-509.02502</b>	12	0.030 kg			

Contacts: NC = Normally closed, NO = Normally open  
 Switching action: B = Momentary, C = Maintain  
 The component layouts you will find from page 55



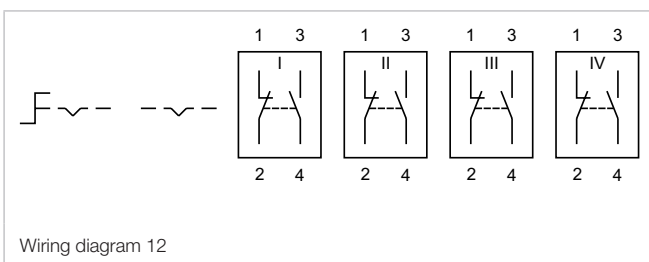
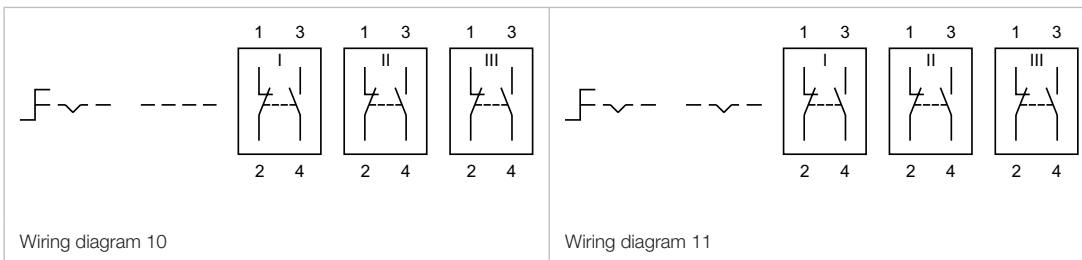
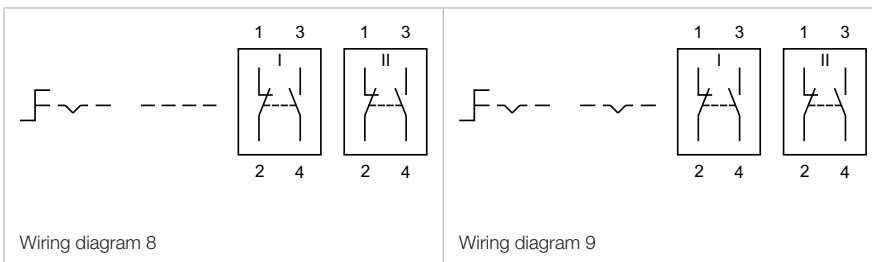
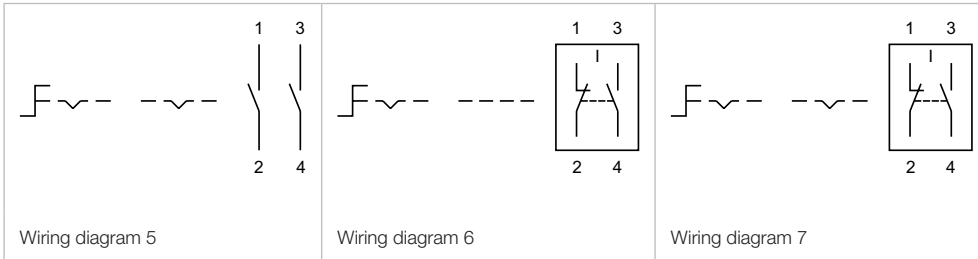
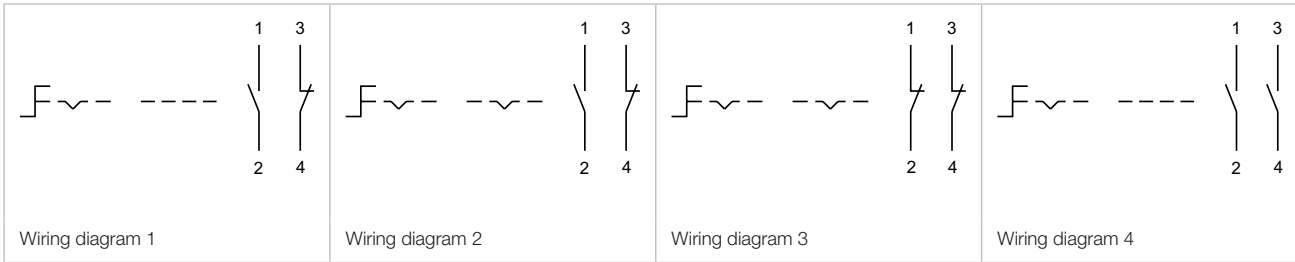

# 14 Raised design

## Indicator full face illumination, IP 67



Product can differ from the current configuration.



Dimensions [mm]  
 L = Solder terminal,  
 L1 = Solder terminal 2.8 x 0.5 mm,  
 H = Universal terminal 2.0 x 0.5 mm,  
 H1 = Universal-Solder terminal

### Additional Information

- For front dimension  $\varnothing 29$  mm
- For LED element fitting information see «Application guidelines»

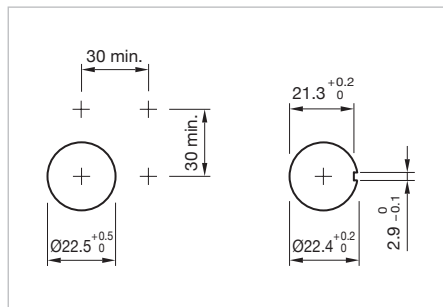

Mounting cut-outs [mm]  
 Other mounting cut-outs see «Drawings»

### Equipment consisting of (schematic overview)



Each Part Number listed below includes all the black components shown in the 3D-drawing.

To obtain a complete unit, please select the red components from the pages shown.

Diode 1N4007	Terminal	Part No.	Component layout	Wiring diagram	Weight
 <p><b>Indicator actuator full-face illumination</b></p>	1	Universal 2.0 x 0.5 mm	14-741.006	1	0.011 kg
	2	Universal 2.0 x 0.5 mm	14-742.006	2	0.011 kg
		Solder 2.8 x 0.5 mm	14-030.002	3	0.010 kg
		Solder	14-030.005	3	0.010 kg
		Universal 2.0 x 0.5 mm	14-031.006	1	3

The component layouts you will find from page 55

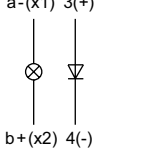
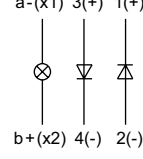
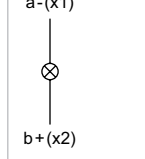
<p>a-(x1) 3(+)</p>  <p>b+(x2) 4(-)</p> <p>Wiring diagram 1</p>	<p>a-(x1) 3(+) 1(+)</p>  <p>b+(x2) 4(-) 2(-)</p> <p>Wiring diagram 2</p>	<p>a-(x1)</p>  <p>b+(x2)</p> <p>Wiring diagram 3</p>
---	---	---

## Indicator front illumination, IP 67

### Equipment consisting of (schematic overview)



Each Part Number listed below includes all the black components shown in the 3D-drawing.

To obtain a complete unit, please select the red components from the pages shown.



Dimensions [mm]  
 L = Solder terminal,  
 L1 = Solder terminal 2.8 x 0.5 mm,  
 H = Universal terminal 2.0 x 0.5 mm



Product can differ from the current configuration.



Mounting cut-outs [mm]  
 Other mounting cut-outs see «Drawings»

### Additional Information

- For front dimension  $\varnothing 29$  mm
- For LED element fitting information see «Application guidelines»

Terminal	Part No.	Component layout	Wiring diagram	Weight
				
<b>Indicator actuator front illumination</b>				
Solder 2.8 x 0.5 mm	<b>14-040.002</b>		1	0.050 kg
Solder	<b>14-040.005</b>		1	0.050 kg
Universal 2.0 x 0.5 mm	<b>14-041.006</b>	1	1	0.050 kg

The component layouts you will find from page 55

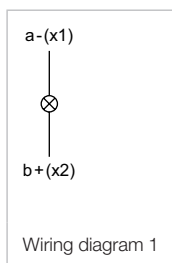

# 14 Raised design

## Buzzer, IP 65



Product can differ from the current configuration.



Dimensions [mm]

### Equipment consisting of (schematic overview)



Buzzer



Fixing nut

Each Part Number listed below includes all the black components shown in the 3D-drawing.

### Additional Information

- Further information see «Technical data»
- For PCB application use adaptor Part-No. 31-942

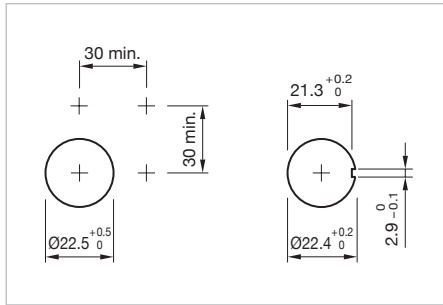

Mounting cut-outs [mm]  
Other mounting cut-outs see «Drawings»

Operating voltage	Front cap	Terminal	Part No.	Wiring diagram	Weight
 <p><b>Buzzer, Front dimension Ø 29 mm</b></p>	Plastic black	Solder 2.8 x 0.5 mm	<b>14-810.002</b>	1	0.016 kg
	Brass nickel-plated	Solder 2.8 x 0.5 mm	<b>14-810.902</b>	1	0.016 kg

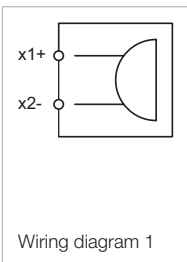

## Illuminated pushbutton, IP 67

### Equipment consisting of (schematic overview)



Each Part Number listed below includes all the black components shown in the 3D-drawing.

To obtain a complete unit, please select the red components from the pages shown.



Dimensions [mm]  
 L = Solder terminal,  
 L1 = Solder terminal 2.8 x 0.5 mm,  
 H = Universal terminal 2.0 x 0.5 mm,  
 H1 = Universal-Solder terminal



Mounting cut-outs [mm]  
 Other mounting cut-outs see «Drawings»



Product can differ from the current configuration.

### Additional Information

- For front dimension Ø 29 mm
- For LED element fitting information see «Application guidelines»

Switching system	Contacts	Diode 1N4007	Switching action	Terminal	Part No.	Component layout	Wiring diagram	Weight
 <b>Illuminated pushbutton actuator</b>								
Low-level element	1 NC		B	Universal 2.0 x 0.5 mm	<b>14-436.036</b>	1	1	0.015 kg
			C	Universal 2.0 x 0.5 mm	<b>14-476.036</b>	1	2	0.015 kg
	1 NC + 1 NO		B	Universal 2.0 x 0.5 mm	<b>14-433.036</b>	1	3	0.015 kg
			C	Universal 2.0 x 0.5 mm	<b>14-473.036</b>	1	4	0.015 kg
	1 NO		B	Universal 2.0 x 0.5 mm	<b>14-435.036</b>	1	5	0.015 kg
			C	Universal 2.0 x 0.5 mm	<b>14-475.036</b>	1	6	0.015 kg
	2 NC		B	Universal 2.0 x 0.5 mm	<b>14-432.036</b>	1	7	0.015 kg
			C	Universal 2.0 x 0.5 mm	<b>14-472.036</b>	1	8	0.015 kg
	2 NO		B	Universal 2.0 x 0.5 mm	<b>14-431.036</b>	1	9	0.015 kg
			C	Universal 2.0 x 0.5 mm	<b>14-471.036</b>	1	10	0.015 kg
Snap-action switching element	1 NC + 1 NO	1	B	Universal-Solder	<b>14-743.0292</b>	1	11	0.014 kg
			C	Universal-Solder	<b>14-747.0292</b>	1	12	0.014 kg
		2	B	Universal-Solder	<b>14-744.0292</b>	1	13	0.014 kg
			C	Universal-Solder	<b>14-748.0292</b>	1	14	0.014 kg
			B	Solder 2.8 x 0.5 mm	<b>14-131.022</b>		24	0.013 kg
			B	Solder	<b>14-131.0252</b>		15	0.013 kg
	2 NC + 2 NO	2	C	Solder 2.8 x 0.5 mm	<b>14-271.022</b>		25	0.013 kg
			C	Solder	<b>14-271.0252</b>		16	0.013 kg
			B	Universal-Solder	<b>14-746.0292</b>	1	17	0.016 kg
			B	Solder	<b>14-132.0252</b>		18	0.015 kg

# 14 Raised design

Switching system	Contacts	Diode 1N4007	Switching action	Terminal	Part No.	Component layout	Wiring diagram	Weight
Snap-action switching element	2 NC + 2 NO		C	Solder	<b>14-272.0252</b>		19	0.015 kg
	3 NC + 3 NO		B	Solder	<b>14-133.0252</b>		20	0.017 kg
			C	Solder	<b>14-273.0252</b>		21	0.017 kg
			B	Solder	<b>14-134.0252</b>		22	0.019 kg
	4 NC + 4 NO		C	Solder	<b>14-274.0252</b>		23	0.019 kg

Contacts: NC = Normally closed, NO = Normally open  
 Switching action: B = Momentary, C = Maintain  
 The component layouts you will find from page 55





# 14 Raised design

## Mushroom-head pushbutton, IP 67



Product can differ from the current configuration.



Dimensions [mm]  
 L = Solder terminal,  
 L1 = Solder terminal 2.8 x 0.5 mm,  
 H = Universal terminal 2.0 x 0.5 mm

### Additional Information

- For front dimension Ø 40 mm



Mounting cut-outs [mm]

### Equipment consisting of (schematic overview)



Each Part Number listed below includes all the black components shown in the 3D-drawing.

To obtain a complete unit, please select the red components from the pages shown.

Switching system	Contacts	Switching action	Terminal	Part No.	Component layout	Wiring diagram	Weight
 <b>Mushroom-head pushbutton actuator</b>							
Low-level element	1 NC	B	Universal 2.0 x 0.5 mm	<b>14-436.036</b>	1	1	0.015 kg
		C	Universal 2.0 x 0.5 mm	<b>14-476.036</b>	1	2	0.015 kg
	1 NC + 1 NO	B	Universal 2.0 x 0.5 mm	<b>14-433.036</b>	1	3	0.015 kg
		C	Universal 2.0 x 0.5 mm	<b>14-473.036</b>	1	4	0.015 kg
	1 NO	B	Universal 2.0 x 0.5 mm	<b>14-435.036</b>	1	5	0.015 kg
		C	Universal 2.0 x 0.5 mm	<b>14-475.036</b>	1	6	0.015 kg
	2 NC	B	Universal 2.0 x 0.5 mm	<b>14-432.036</b>	1	7	0.015 kg
		C	Universal 2.0 x 0.5 mm	<b>14-472.036</b>	1	8	0.015 kg
	2 NO	B	Universal 2.0 x 0.5 mm	<b>14-431.036</b>	1	9	0.015 kg
		C	Universal 2.0 x 0.5 mm	<b>14-471.036</b>	1	10	0.015 kg
Snap-action switching element	1 NC + 1 NO	B	Solder 2.8 x 0.5 mm	<b>14-131.022</b>	19		0.013 kg
		B	Solder	<b>14-131.0252</b>	11		0.013 kg
		C	Solder 2.8 x 0.5 mm	<b>14-271.022</b>	20		0.013 kg
		C	Solder	<b>14-271.0252</b>	12		0.013 kg
	2 NC + 2 NO	B	Solder	<b>14-132.0252</b>	13		0.015 kg
		C	Solder	<b>14-272.0252</b>	14		0.015 kg
	3 NC + 3 NO	B	Solder	<b>14-133.0252</b>	15		0.017 kg
		C	Solder	<b>14-273.0252</b>	16		0.017 kg
	4 NC + 4 NO	B	Solder	<b>14-134.0252</b>	17		0.019 kg
		C	Solder	<b>14-274.0252</b>	18		0.019 kg

Contacts: NC = Normally closed, NO = Normally open  
 Switching action: B = Momentary, C = Maintain  
 The component layouts you will find from page 55



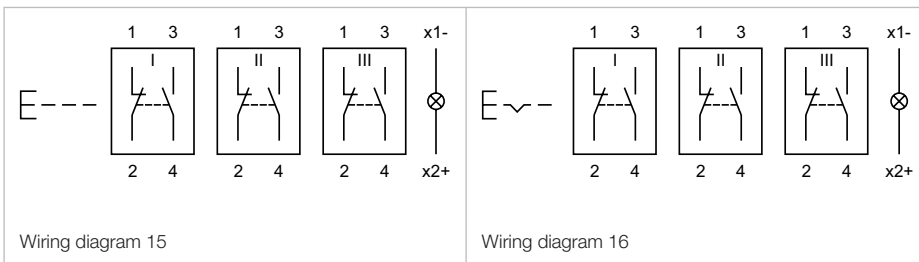
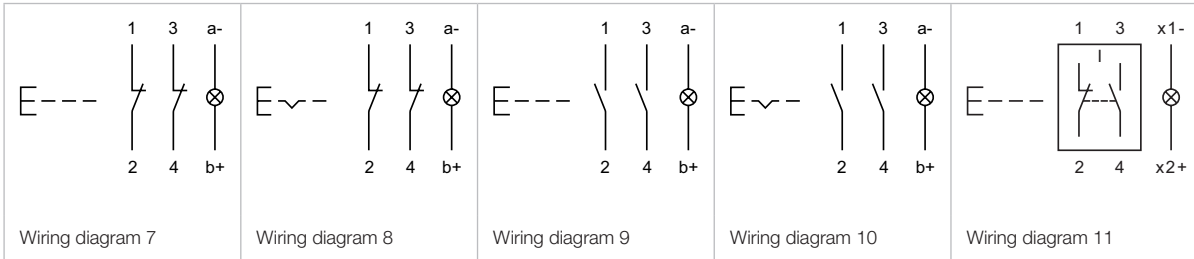

# 14 Raised design

## Illuminated mushroom head pushbutton, IP 67



Product can differ from the current configuration.



Dimensions [mm]  
 L = Solder terminal,  
 L1 = Solder terminal 2.8 x 0.5 mm,  
 H = Universal terminal 2.0 x 0.5 mm,  
 H1 = Universal-Solder terminal

### Additional Information

- For front dimension  $\varnothing$  29 mm
- For LED element fitting information see «Application guidelines»



Mounting cut-outs [mm]

### Equipment consisting of (schematic overview)



Each Part Number listed below includes all the black components shown in the 3D-drawing.

To obtain a complete unit, please select the red components from the pages shown.

Switching system	Contacts	Diode 1N4007	Switching action	Terminal	Part No.	Component layout	Wiring diagram	Weight		
 Mushroom-head pushbutton actuator illuminated	Low-level element	1 NC	B	Universal 2.0 x 0.5 mm	<b>14-436.036</b>	1	1	0.015 kg		
			C	Universal 2.0 x 0.5 mm	<b>14-476.036</b>	1	2	0.015 kg		
		1 NC + 1 NO	B	Universal 2.0 x 0.5 mm	<b>14-433.036</b>	1	3	0.015 kg		
			C	Universal 2.0 x 0.5 mm	<b>14-473.036</b>	1	4	0.015 kg		
		1 NO	B	Universal 2.0 x 0.5 mm	<b>14-435.036</b>	1	5	0.015 kg		
			C	Universal 2.0 x 0.5 mm	<b>14-475.036</b>	1	6	0.015 kg		
		2 NC	B	Universal 2.0 x 0.5 mm	<b>14-432.036</b>	1	7	0.015 kg		
			C	Universal 2.0 x 0.5 mm	<b>14-472.036</b>	1	8	0.015 kg		
		2 NO	B	Universal 2.0 x 0.5 mm	<b>14-431.036</b>	1	9	0.015 kg		
			C	Universal 2.0 x 0.5 mm	<b>14-471.036</b>	1	10	0.015 kg		
	Snap-action switching element	1 NC + 1 NO	1	B	Universal-Solder	<b>14-743.0292</b>	1	11	0.014 kg	
				C	Universal-Solder	<b>14-747.0292</b>	1	12	0.014 kg	
2			B	Universal-Solder	<b>14-744.0292</b>	1	13	0.014 kg		
			C	Universal-Solder	<b>14-748.0292</b>	1	14	0.014 kg		
			B	Solder 2.8 x 0.5 mm	<b>14-131.022</b>		24	0.013 kg		
			B	Solder	<b>14-131.0252</b>		15	0.013 kg		
			C	Solder 2.8 x 0.5 mm	<b>14-271.022</b>		25	0.013 kg		
			C	Solder	<b>14-271.0252</b>		16	0.013 kg		
			2 NC + 2 NO	2	B	Universal-Solder	<b>14-746.0292</b>	1	17	0.016 kg
					B	Solder	<b>14-132.0252</b>		18	0.015 kg
		C	Solder	<b>14-272.0252</b>		19	0.015 kg			

Switching system	Contacts	Diode 1N4007	Switching action	Terminal	Part No.	Component layout	Wiring diagram	Weight
Snap-action switching element	3 NC + 3 NO		B	Solder	<b>14-133.0252</b>		20	0.017 kg
			C	Solder	<b>14-273.0252</b>		21	0.017 kg
	4 NC + 4 NO		B	Solder	<b>14-134.0252</b>		22	0.019 kg
			C	Solder	<b>14-274.0252</b>		23	0.019 kg

Contacts: NC = Normally closed, NO = Normally open  
 Switching action: B = Momentary, C = Maintain  
 The component layouts you will find from page 55

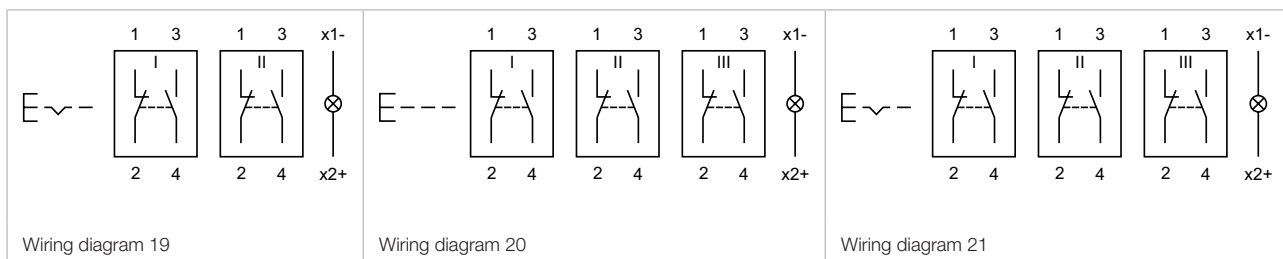
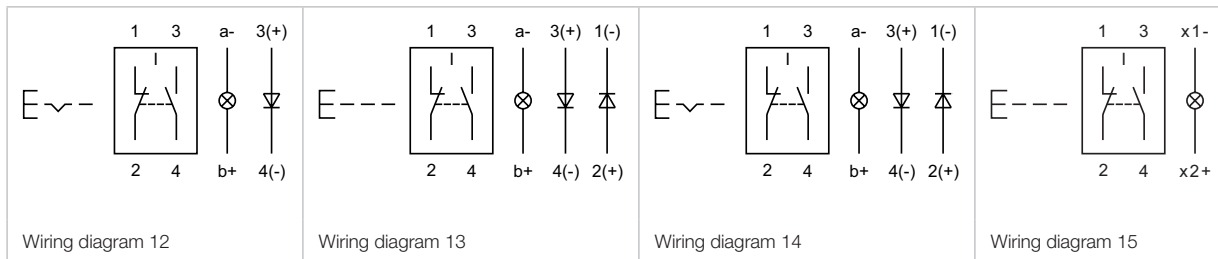

# 14 Raised design



## Keylock switch 2 positions, IP 65

### Equipment consisting of (schematic overview)

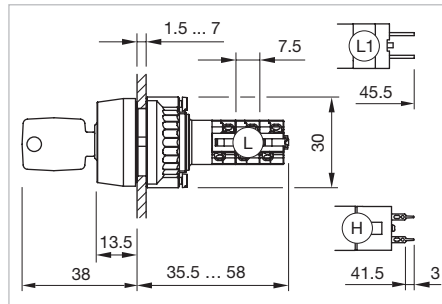

Dimensions [mm]  
 L = Solder terminal,  
 L1 = Solder terminal 2.8 x 0.5 mm,  
 H = Universal terminal 2.0 x 0.5 mm



Product can differ from the current configuration.

Each Part Number listed below includes all the black components shown in the 3D-drawing.

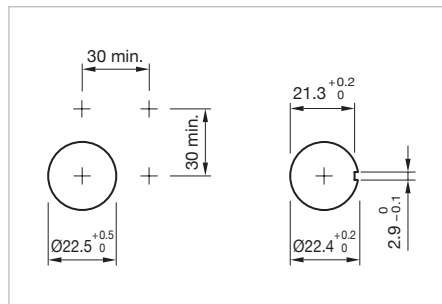

Mounting cut-outs [mm]  
 Other mounting cut-outs see «Drawings»

### Additional Information

- Front plastic black
- Frontring aluminium natural anodized
- The standard lock: KABA 1001
- Two keys are supplied with each key lock switch
- Optional lock numbers on request
- The colour of anodized aluminium parts can vary due to technical production reasons

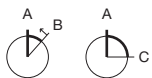

Switching positions (A = Rest, B = Momentary, C = Maintained)

Switching system	Contacts	Switching action	Switching angle	Key remove	Terminal	Part No.	Component layout	Wiring diagram	Weight
 <p><b>Keylock switch actuator 2 positions, Front dimension Ø 29 mm</b></p>									
Low-level element	2 NO	A - B	B = 42°	A	Universal 2.0 x 0.5 mm	<b>14-437.036K</b>	1	1	0.030 kg
	1 NC + 1 NO	A - B	B = 42°	A	Universal 2.0 x 0.5 mm	<b>14-438.036K</b>	1	2	0.030 kg
		A - C	C = 90°	A + C	Universal 2.0 x 0.5 mm	<b>14-412.036K</b>	1	3	0.030 kg
			A	Universal 2.0 x 0.5 mm	<b>14-415.036K</b>	1	3	0.030 kg	
	C	Universal 2.0 x 0.5 mm	<b>14-418.036K</b>	1	3	0.030 kg			
	2 NO	A - C	C = 90°	A + C	Universal 2.0 x 0.5 mm	<b>14-411.036K</b>	1	4	0.030 kg
		A	Universal 2.0 x 0.5 mm	<b>14-414.036K</b>	1	4	0.030 kg		
C		Universal 2.0 x 0.5 mm	<b>14-417.036K</b>	1	4	0.030 kg			
Snap-action switching element	1 NC + 1 NO	A - B	B = 42°	A	Solder 2.8 x 0.5 mm	<b>14-141.022K</b>		5	0.029 kg
		A	Solder	<b>14-141.025K2</b>		5	0.029 kg		
	2 NC + 2 NO	A - B	B = 42°	A	Solder	<b>14-142.025K2</b>		6	0.031 kg
	3 NC + 3 NO	A - B	B = 42°	A	Solder	<b>14-143.025K2</b>		7	0.033 kg
	4 NC + 4 NO	A - B	B = 42°	A	Solder	<b>14-144.025K2</b>		8	0.035 kg
	1 NC + 1 NO	A - C	C = 90°	A + C	Solder	<b>14-135.025K2</b>		9	0.029 kg
		A	Solder	<b>14-235.025K2</b>		9	0.029 kg		
C		Solder	<b>14-335.025K2</b>		9	0.029 kg			

# 14 Raised design

Switching system	Contacts	Switching action	Switching angle	Key remove	Terminal	Part No.	Component layout	Wiring diagram	Weight
Snap-action switching element	1 NC + 1 NO	A - C	C = 90°	A + C	Solder 2.8 x 0.5 mm	<b>14-135.022K</b>		9	0.029 kg
				A	Solder 2.8 x 0.5 mm	<b>14-235.022K</b>		9	0.029 kg
				C	Solder 2.8 x 0.5 mm	<b>14-335.022K</b>		9	0.029 kg
	2 NC + 2 NO	A - C	C = 90°	A + C	Solder	<b>14-136.025K2</b>		10	0.031 kg
				A	Solder	<b>14-236.025K2</b>		10	0.031 kg
				C	Solder	<b>14-336.025K2</b>		10	0.031 kg
	3 NC + 3 NO	A - C	C = 90°	A + C	Solder	<b>14-137.025K2</b>		11	0.033 kg
				A	Solder	<b>14-237.025K2</b>		11	0.033 kg
				C	Solder	<b>14-337.025K2</b>		11	0.033 kg
	4 NC + 4 NO	A - C	C = 90°	A + C	Solder	<b>14-138.025K2</b>		12	0.035 kg
				A	Solder	<b>14-238.025K2</b>		12	0.035 kg
				C	Solder	<b>14-338.025K2</b>		12	0.035 kg

Contacts: NC = Normally closed, NO = Normally open  
 Switching action: B = Momentary, C = Maintain  
 The component layouts you will find from page 55

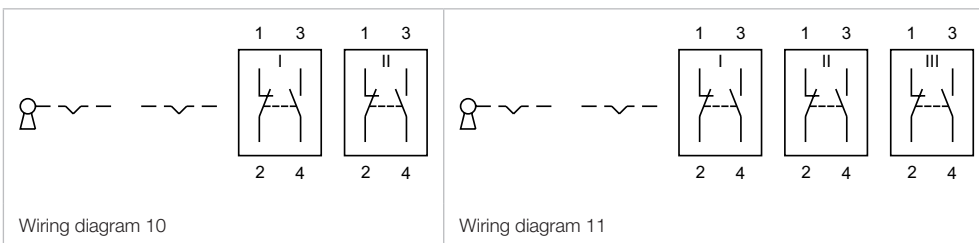
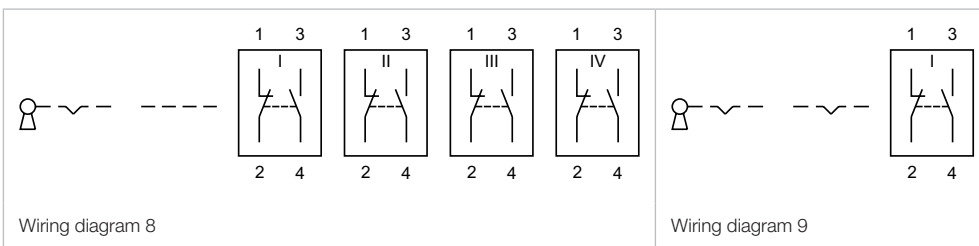
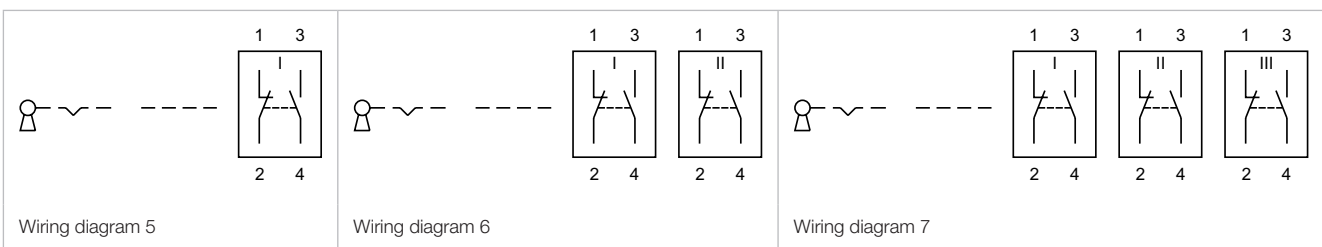

## Selector switch 2 positions, IP 67

### Equipment consisting of (schematic overview)



Dimensions [mm]  
 L = Solder terminal,  
 L1 = Solder terminal 2.8 x 0.5 mm,  
 H = Universal terminal 2.0 x 0.5 mm



Product can differ from the current configuration.

Each Part Number listed below includes all the black components shown in the 3D-drawing.

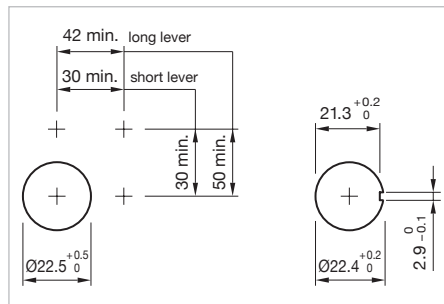

Mounting cut-outs [mm]  
 Other mounting cut-outs see «Drawings»

### Additional Information

- Non-illuminative
- Frontring aluminium natural anodized
- The colour of anodized aluminium parts can vary due to technical production reasons

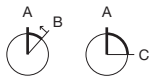

Switching positions (A = Rest, B = Momentary, C = Maintained)

Lever	Switching system	Contacts	Switching action	Switching angle	Terminal	Part No.	Component layout	Wiring diagram	Weight
	Plastic black short	1 NC + 1 NO	A - B	B = 42°	Universal 2.0 x 0.5 mm	<b>14-517.0360</b>	1	1	0.025 kg
			A - C	C = 90°	Universal 2.0 x 0.5 mm	<b>14-522.0360</b>	1	2	0.025 kg
		2 NC	A - C	C = 90°	Universal 2.0 x 0.5 mm	<b>14-521.0360</b>	1	3	0.025 kg
		2 NO	A - B	B = 42°	Universal 2.0 x 0.5 mm	<b>14-515.0360</b>	1	4	0.025 kg
			A - C	C = 90°	Universal 2.0 x 0.5 mm	<b>14-520.0360</b>	1	5	0.025 kg
		Snap-action switching element	1 NC + 1 NO	A - B	B = 42°	Solder 2.8 x 0.5 mm	<b>14-501.0220</b>	6	0.024 kg
				A - B	B = 42°	Solder	<b>14-501.02502</b>	6	0.024 kg
				A - C	C = 90°	Solder 2.8 x 0.5 mm	<b>14-506.0220</b>	7	0.024 kg
				A - C	C = 90°	Solder	<b>14-506.02502</b>	7	0.024 kg
			2 NC + 2 NO	A - B	B = 42°	Solder	<b>14-502.02502</b>	8	0.026 kg
	A - C	C = 90°	Solder	<b>14-507.02502</b>	9	0.026 kg			
	3 NC + 3 NO	A - B	B = 42°	Solder	<b>14-503.02502</b>	10	0.028 kg		
		A - C	C = 90°	Solder	<b>14-508.02502</b>	11	0.028 kg		
	4 NC + 4 NO	A - C	C = 90°	Solder	<b>14-509.02502</b>	12	0.030 kg		

# 14 Raised design

Lever	Switching system	Contacts	Switching action	Switching angle	Terminal	Part No.	Component layout	Wiring diagram	Weight	
	<b>Selector switch actuator 2 positions, Front dimension Ø 29 mm</b>									
	Plastic black long	Low-level element	1 NC + 1 NO	A - C	C = 90°	Universal 2.0 x 0.5 mm	<b>14-572.0360</b>	1	2	0.025 kg
			2 NO	A - C	C = 90°	Universal 2.0 x 0.5 mm	<b>14-570.0360</b>	1	5	0.025 kg
	Snap-action switching element	1 NC + 1 NO	A - C	C = 90°	Solder 2.8 x 0.5 mm	<b>14-556.0220</b>		7	0.024 kg	
			A - C	C = 90°	Solder	<b>14-556.02502</b>		7	0.024 kg	
A - C			C = 90°	Solder	<b>14-557.02502</b>		9	0.026 kg		

Contacts: NC = Normally closed, NO = Normally open  
 Switching action: B = Momentary, C = Maintain  
 The component layouts you will find from page 55

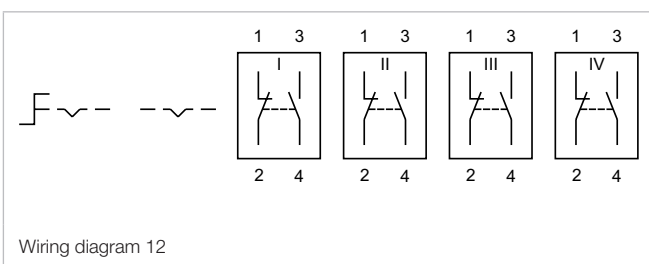
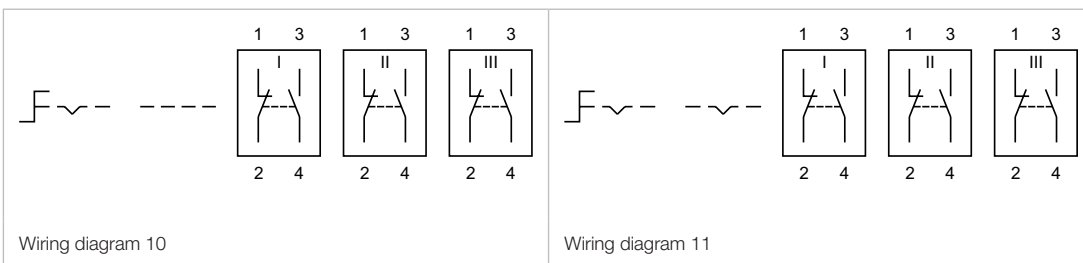
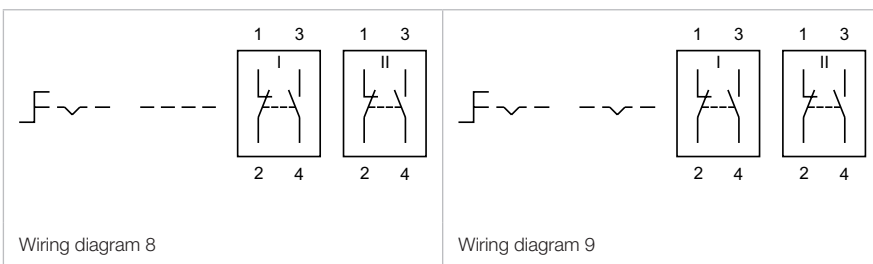



Front

Lens plastic

Additional Information

- To obtain IP 67 use marking plate Part No. 704.609.X

Product attribute	Dimension	Lens	Symbol	Part No.	Weight
 <p><b>Lens plastic round flat</b></p>					
non-illuminative	Ø 23.7 mm	black opaque		<b>704.602.0</b>	0.001 kg
illuminative	Ø 23.7 mm	red transparent		<b>704.602.2</b>	0.001 kg
		yellow transparent		<b>704.602.4</b>	0.001 kg
		green transparent		<b>704.602.5</b>	0.001 kg
		blue transparent		<b>704.602.6</b>	0.001 kg
		colourless transparent		<b>704.602.7</b>	0.001 kg
 <p><b>Lens plastic round flat</b></p>					
illuminative	Ø 23.7 mm	colourless transparent	Ring	<b>704.602.7A01</b>	0.001 kg

Lens plastic increased

Additional Information

- To obtain IP 67 use marking plate Part No. 704.610.X

Product attribute	Dimension	Lens	Part No.	Weight
 <p><b>Lens plastic round increased</b></p>				
illuminative	Ø 23.7 mm	red transparent	<b>704.611.2</b>	0.002 kg
		yellow transparent	<b>704.611.4</b>	0.002 kg
		green transparent	<b>704.611.5</b>	0.002 kg
		colourless transparent	<b>704.611.7</b>	0.002 kg

# 14 Accessories

## Lens metal with dot

### Additional Information

- To obtain IP 67 use marking plate Part No. 704.609.X
- The colour of anodized aluminium parts can vary due to technical production reasons

Product attribute	Dimension	Lens	Part No.	Weight
 <b>Lens metal with spot round</b>				
illuminative	Ø 23.7 mm	Aluminium black anodized	<b>704.601.01</b>	0.001 kg
		Aluminium red anodized	<b>704.601.21</b>	0.001 kg
		Aluminium gold anodized	<b>704.601.41</b>	0.001 kg
		Aluminium olive-green anodized	<b>704.601.51</b>	0.001 kg
		Aluminium blue anodized	<b>704.601.61</b>	0.001 kg
		Aluminium natural anodized	<b>704.601.81</b>	0.001 kg
		Stainless-steel natural	<b>704.601.91</b>	0.001 kg

## Lens metal

### Additional Information

- To obtain IP 67 use marking plate Part No. 704.609.X
- The colour of anodized aluminium parts can vary due to technical production reasons

Product attribute	Dimension	Lens	Part No.	Weight
 <b>Lens metal round</b>				
non-illuminative	Ø 23.7 mm	Aluminium black anodized	<b>704.601.0</b>	0.001 kg
		Aluminium red anodized	<b>704.601.2</b>	0.001 kg
		Aluminium gold anodized	<b>704.601.4</b>	0.001 kg
		Aluminium olive-green anodized	<b>704.601.5</b>	0.001 kg
		Aluminium blue anodized	<b>704.601.6</b>	0.001 kg
		Aluminium natural anodized	<b>704.601.8</b>	0.001 kg
		Stainless-steel natural	<b>704.601.9</b>	0.001 kg

**Lens cap, Plastic**

**Additional Information**

- To obtain IP 67 use marking plate Part No. 704.608.X

Product attribute	Lens cap	Part No.	Weight	
 <p><b>Lens cap round, Front dimension Ø 29 mm</b></p>				
	illuminative	Plastic red	<b>704.603.2</b>	0.003 kg
		Plastic yellow	<b>704.603.4</b>	0.003 kg
		Plastic green	<b>704.603.5</b>	0.003 kg
		Plastic blue	<b>704.603.6</b>	0.003 kg
		Plastic colourless	<b>704.603.7</b>	0.003 kg

**Mushroom-head cap, Plastic**

**Additional Information**

- To obtain IP 67 use marking plate Part No. 704.609.9

Mushroom-head cap	Part No.	Weight	
 <p><b>Mushroom-head cap, Front dimension Ø 40 mm</b></p>			
	black opaque	<b>704.604.0</b>	0.001 kg
	red opaque	<b>704.604.2</b>	0.001 kg
	yellow opaque	<b>704.604.4</b>	0.001 kg
	green opaque	<b>704.604.5</b>	0.001 kg

# 14 Accessories

## Mushroom-head cap illuminated, Plastic

### Additional Information

- To obtain IP 67 use marking plate  
Part No. 704.609.9

Mushroom-head cap	Part No.	Weight
	<b>Mushroom-head cap illuminated, Front dimension Ø 40 mm</b>	
red transparent	<b>704.614.2</b>	0.007 kg
yellow transparent	<b>704.614.4</b>	0.007 kg
green transparent	<b>704.614.5</b>	0.007 kg
blue transparent	<b>704.614.6</b>	0.007 kg
colourless transparent	<b>704.614.7</b>	0.007 kg

## Marking plate

Marking plate illumination	Marking plate	Part No.	Weight
	<b>Marking plate for lens plastic and metal</b>		
non-illuminative	black opaque	<b>704.609.0</b>	0.001 kg
	<b>Marking plate for lens plastic and metal</b>		
LED	colourless transparent ripped	<b>704.609.7</b>	0.001 kg
	<b>Marking plate for lens plastic and metal</b>		
LED and filament lamp	white translucent	<b>704.609.9</b>	0.001 kg
	<b>Legend plate for lens plastic</b>		
Halo illumination	white translucent	<b>704.609.9A01</b>	0.001 kg

**Marking plate mushroom-head cap**

Marking plate	Part No.	Weight
 <p><b>Marking plate for mushroom-head cap</b></p>		
white translucent	<b>704.609.9</b>	0.001 kg

**Marking cap lens increased**

Marking cap illumination	Marking cap	Part No.	Weight
 <p><b>Marking cap for lens plastic increased</b></p>			
LED	colourless transparent ripped	<b>704.610.7</b>	0.001 kg
 <p><b>Marking cap for lens plastic increased</b></p>			
LED and filament lamp	white translucent	<b>704.610.9</b>	0.001 kg

**Marking cap for lens cap, Plastic**

Marking cap illumination	Marking cap	Part No.	Weight
 <p><b>Marking cap for lens cap</b></p>			
LED	colourless transparent ripped	<b>704.608.7</b>	0.002 kg
 <p><b>Marking cap for lens cap</b></p>			
LED and filament lamp	white translucent	<b>704.608.9</b>	0.002 kg

# 14 Accessories

## Front bezel set

### Additional Information

- The colour of anodized aluminium parts can vary due to technical production reasons

Mounting cut-out	Front ring	Part No.	Weight
 <p><b>Front bezel set, flush design, Front dimension Ø 35 mm</b></p>			
	Aluminium black anodized	<b>14-955.0</b>	0.015 kg
	Aluminium natural anodized	<b>14-955.1</b>	0.015 kg
	Stainless-steel natural	<b>14-955.9</b>	0.033 kg

## Front bezel mushroom

### Additional Information

- The colour of anodized aluminium parts can vary due to technical production reasons



Mounting cut-outs [mm]

Mounting cut-out	Front ring	Part No.	Weight
 <p><b>Front bezel set for mushroom-head pushbutton, flush design, Front dimension Ø 50 mm</b></p>			
	Aluminium natural anodized	<b>14-958.8</b>	0.042 kg
	Aluminium black anodized	<b>14-958.0</b>	0.042 kg

**Front bezel set with protective membrane, IP 67**

**Additional Information**

- For illuminated pushbutton for front protection IP 67
- Front ring to be mounted with a torque of 40 Ncm onto actuator
- Before assembling remove the flat gasket of the switch
- The colour of anodized aluminium parts can vary due to technical production reasons

Product attribute	Front ring	Part No.	Weight
 <p><b>Front bezel set with protective membrane, flush design, Front dimension Ø 35 mm</b></p>			
with transparent silicone membrane	Aluminium natural anodized	<b>14-955.3</b>	0.015 kg
	Aluminium black anodized	<b>14-955.4</b>	0.015 kg
with transparent silicone membrane, resistant to sea water	Stainless-steel natural	<b>14-955.9E</b>	0.033 kg

**Front ring**

**Additional Information**

- The colour of anodized aluminium parts can vary due to technical production reasons

Front ring	Part No.	Weight
 <p><b>Front ring, Front dimension Ø 29 mm</b></p>		
Plastic black	<b>704.600.0</b>	0.003 kg
Aluminium natural anodized	<b>704.600.1</b>	0.005 kg
Aluminium black anodized	<b>704.600.1A</b>	0.005 kg
Plastic light-grey	<b>704.600.6</b>	0.003 kg
Stainless-steel natural	<b>704.600.9</b>	0.006 kg

# 14 Accessories

## Front ring for mushroom-head pushbutton

### Additional Information

- The colour of anodized aluminium parts can vary due to technical production reasons

Front ring	Part No.	Weight
 <p><b>Front ring for mushroom-head pushbutton, Front dimension Ø 29 mm</b></p>		
Plastic black	<b>704.600.0</b>	0.003 kg
Aluminium natural anodized	<b>704.600.1</b>	0.005 kg
Aluminium black anodized	<b>704.600.1A</b>	0.005 kg
Plastic light-grey	<b>704.600.6</b>	0.003 kg
Stainless-steel natural	<b>704.600.9</b>	0.006 kg

## Front protective cap, IP 68

### Additional Information

- For Indicator and Illuminated pushbutton for IP 68 protection

Product attribute	Material	Colour	Optics	Part No.	Weight
 <p><b>Front protective cap</b></p>					
only together with lenses Part No. 704.602.X, 704.601.X and front rings Part No. 704.600.X	Silicone	colourless	transparent	<b>704.953.0</b>	0.002 kg



**Front protective ring, IP 67**

**Additional Information**

- For illuminated pushbutton with front illumination for IP 67 protection
- Front protective ring to be mounted with a torque of 40 Ncm onto actuator

Product attribute	Material	Colour	Part No.	Weight
 <p><b>Front protective ring</b></p>				
with transparent silicone membrane (extent resistant to sea water), temperature resistance -40 °C ... +85 °C	Brass	chrome	<b>704.600.2</b>	0.005 kg
with transparent silicone membrane (extent resistant to sea water), temperature resistance -40 °C ... +85 °C	Aluminium	natural anodized	<b>704.600.3</b>	0.005 kg
with transparent Pebax membrane, temperature resistance -40 °C ... +85 °C	Aluminium	natural anodized	<b>704.600.5/A</b>	0.005 kg

**Legend frame**

**Additional Information**

- The colour of anodized aluminium parts can vary due to technical production reasons

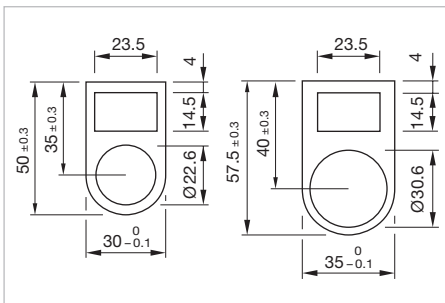

Dimensions [mm]

Product attribute	Dimension	Material	Colour	Mounting type	Part No.	Weight
 <p><b>Legend frame</b></p>						
for raised design	30 x 50 x 0.75 mm	Aluminium	black anodized	adhesive	<b>704.968.2</b>	0.001 kg
for flush design	35 x 57.5 x 0.75 mm	Aluminium	black anodized	adhesive	<b>704.968.3</b>	0.001 kg

# 14 Accessories

## Legend plate

### Additional Information

- For legend frame Part No.704.968.2 and 704.968.3
- The colour of anodized aluminium parts can vary due to technical production reasons

Dimension	Material	Colour	Mounting type	Part No.	Weight
 <p><b>Legend plate for legend frame</b></p>	Aluminium	natural anodized	adhesive	<b>704.968.0</b>	0.001 kg
		black anodized	adhesive	<b>704.968.1</b>	0.001 kg

**Protective cover flush design, IP 65**

**Additional Information**

- Hinged
- Front panel thickness reduces by 2 mm
- The dimensions of the mounting cut-outs are shown in the product details
- Please note that bigger minimum distances are necessary
- The colour of anodized aluminium parts can vary due to technical production reasons



Dimensions [mm]

Product attribute	Mounting cut-out	Material	Colour	Optics	Part No.	Weight
 <p><b>Protective cover round, flush design</b></p> <p>with means for sealing, for pushbutton</p>	Ø 30.5 mm	Plastic	colourless	transparent	<b>704.925.7</b>	0.006 kg
 <p><b>Protective cover round, flush design</b></p> <p>not with means for sealing, with spring fitted, with window, for pushbutton</p>	Ø 30.5 mm	Aluminium	natural anodized		<b>704.928.18</b>	0.019 kg
 <p><b>Protective cover round, flush design</b></p> <p>with means for sealing, for pushbutton and selector switch short lever</p>	Ø 30.5 mm	Aluminium	natural anodized		<b>704.928.28</b>	0.019 kg
 <p><b>Protective cover round, flush design</b></p> <p>with means for sealing, for pushbutton and selector switch short lever</p>	Ø 30.5 mm	Aluminium	natural anodized		<b>704.928.38</b>	0.019 kg

# 14 Accessories

## Protection cover, raised design, IP 65

### Additional Information

- Hinged, with means for sealing
- Protection cover Part No. 704.925.2 only for selector switches in basic position A applicable
- Front panel thickness reduces by 3 mm
- The dimensions of the mounting cut-outs are shown in the product details
- Please note that bigger minimum distances are necessary



Dimensions [mm]

Product attribute	Mounting cut-out	Material	Optics	Part No.	Weight
 <p><b>Protection cover round, raised design</b></p>					
for pushbutton	Ø 22.5 mm	Plastic	transparent	<b>704.925.0</b>	0.007 kg
with spring fitted, for pushbutton	Ø 22.5 mm	Plastic	transparent	<b>704.925.3</b>	0.007 kg
 <p><b>Protection cover round, raised design</b></p>					
for selector switch	Ø 22.5 mm	Plastic	transparent	<b>704.925.2</b>	0.007 kg

## Blind plug, IP 65

### Additional Information

- The dimensions of the mounting cut-outs are shown in the product details
- Please note that bigger minimum distances are necessary



Dimensions [mm]

Dimension	Mounting cut-out	Material	Colour	Part No.	Weight
 <p><b>Blind plug</b></p>					
Ø 28 mm	Ø 22.5 mm	Plastic	black	<b>704.960.4</b>	0.004 kg
 <p><b>Blind plug</b></p>					
Ø 36 mm	Ø 30.5 mm	Plastic	black	<b>704.964.8</b>	0.007 kg

**Spare key****Additional Information**

- For standard lock: KABA 1001
- Optional lock numbers on request

Part No.	Weight
 <b>Spare key</b>	
14-987.1001	0.006 kg

# 14 Accessories

## Rear side

### PCB plug-in base

#### Additional Information

- PCB plug-in base pins right-angle: With the extendable mounting the distance between plug-in base and PCB can be varied up to 3 mm



Abmessungen [mm]

Product attribute	Pins	Terminal	Part No.	Component layout	Weight
 <p><b>PCB plug-in base</b> for low level switching element</p>	axial	PCB	<b>31-940</b>	2	0.002 kg
 <p><b>PCB plug-in base</b> for low level switching element</p>	right-angled	PCB	<b>31-941</b>	3	0.004 kg
 <p><b>PCB plug-in base</b> for snap-action switching element 2.8 mm</p>	axial	PCB	<b>31-942</b>	4	0.002 kg

The component layouts you will find from page 55

**Flat receptacle**

Product attribute	Part No.	Weight
 <p><b>Flat receptacle</b></p> <p>2.0 x 0.5 mm plug-in terminal</p>	<b>31-945</b>	0.001 kg
 <p><b>Flat receptacle</b></p> <p>2.8 x 0.5 mm plug-in terminal</p>	<b>31-946</b>	0.001 kg

**Insulation sleeve**

Product attribute	Part No.	Weight
 <p><b>Insulation sleeve</b></p> <p>Cover plug-in terminals for snap-action switching element 2.8 mm</p>	<b>01-928</b>	0.001 kg
 <p><b>Insulation sleeve</b></p> <p>for flat receptacle 2.0 mm</p>	<b>31-928</b>	0.001 kg
 <p><b>Insulation sleeve</b></p> <p>for flat receptacle 2.8 mm</p>	<b>31-929</b>	0.001 kg

**Terminal cover**

**Additional Information**

- For snap-action switching element

Part No.	Weight
 <p><b>Terminal cover for snap-action switching element 16</b></p>	0.010 kg
<b>01-929</b>	

# 14 Accessories

## Illumination

### Single-LED, T5.5

#### Additional Information

- For LED element fitting information see «Application guidelines»
- When using AC/DC types with AC operation, slight flickering can occur
- Luminous intensity data of the LEDs on direct voltage
- Electrical and optical data are measured at 25 °C
- The specified versions are built with a protection diode (half wave rectifier) in series and the LED
- Luminosity and wave length scattering caused by LED manufacturing processes may cause slight variations in the illumination
- For supply voltages above 48V, a voltage reduction element (external series resistor or transformer) must be used
- Due to high surface temperatures, the series resistors must be soldered directly to the terminals of the equipment (use a terminal plate)



Dimensions [mm]

LED colour	Operating voltage	Operation current	Lumi. intensity	Dom. wavelength	Part No.	Weight
 <p><b>Single-LED</b></p>						
red	6 VDC +10 %	15 mA ±15 %	350 mcd	630 nm	<b>10-2106.3142</b>	0.001 kg
	12 VAC/DC +10 %	7/14 mA ±15 %	330 mcd	630 nm	<b>10-2109.1062</b>	0.001 kg
	24 VAC/DC +10 %	7/14 mA ±15 %	330 mcd	630 nm	<b>10-2112.1062</b>	0.001 kg
	28 VAC/DC +10 %	7/14 mA ±15 %	330 mcd	630 nm	<b>10-2113.1062</b>	0.001 kg
	48 VAC/DC +10 %	4/8 mA ±15 %	200 mcd	630 nm	<b>10-2119.1042</b>	0.001 kg
yellow	6 VDC +10 %	15 mA ±15 %	300 mcd	587 nm	<b>10-2106.3144</b>	0.001 kg
	12 VAC/DC +10 %	7/14 mA ±15 %	280 mcd	587 nm	<b>10-2109.1064</b>	0.001 kg
	24 VAC/DC +10 %	7/14 mA ±15 %	280 mcd	587 nm	<b>10-2112.1064</b>	0.001 kg
	28 VAC/DC +10 %	7/14 mA ±15 %	280 mcd	587 nm	<b>10-2113.1064</b>	0.001 kg
	48 VAC/DC +10 %	4/8 mA ±15 %	180 mcd	587 nm	<b>10-2119.1044</b>	0.001 kg
green	6 VDC +10 %	7 mA ±15 %	1050 mcd	525 nm	<b>10-2106.3145</b>	0.001 kg
	12 VAC/DC +10 %	4/7 mA ±15 %	1050 mcd	525 nm	<b>10-2109.1065</b>	0.001 kg
	24 VAC/DC +10 %	4/7 mA ±15 %	1050 mcd	525 nm	<b>10-2112.1065</b>	0.001 kg
	28 VAC/DC +10 %	4/7 mA ±15 %	1050 mcd	525 nm	<b>10-2113.1065</b>	0.001 kg
	48 VAC/DC +10 %	2/4 mA ±15 %	600 mcd	525 nm	<b>10-2119.1045</b>	0.001 kg
blue	6 VDC +10 %	15 mA ±15 %	680 mcd	470 nm	<b>10-2106.3146</b>	0.001 kg
	12 VAC/DC +10 %	7/14 mA ±15 %	650 mcd	470 nm	<b>10-2109.1066</b>	0.001 kg
	24 VAC/DC +10 %	7/14 mA ±15 %	650 mcd	470 nm	<b>10-2112.1066</b>	0.001 kg
	28 VAC/DC +10 %	7/14 mA ±15 %	650 mcd	470 nm	<b>10-2113.1066</b>	0.001 kg
	48 VAC/DC +10 %	4/8 mA ±15 %	400 mcd	470 nm	<b>10-2119.1046</b>	0.001 kg



LED colour	Operating voltage	Operation current	Lumi. intensity	Dom. wavelength	Part No.	Weight
white	6 VDC +10 %	6 mA ±15 %	900 mcd	x0.31/y0.32 nm	<b>10-2106.3149</b>	0.001 kg
	12 VAC/DC +10 %	3/6 mA ±15 %	900 mcd	x0.31/y0.32 nm	<b>10-2109.1069</b>	0.001 kg
	24 VAC/DC +10 %	2.5/5 mA ±15 %	750 mcd	x0.31/y0.32 nm	<b>10-2112.1069</b>	0.001 kg
	28 VAC/DC +10 %	2.5/5 mA ±15 %	750 mcd	x0.31/y0.32 nm	<b>10-2113.1069</b>	0.001 kg
	48 VAC/DC +10 %	2/4 mA ±15 %	600 mcd	x0.31/y0.32 nm	<b>10-2119.1049</b>	0.001 kg

## Filament lamp, T5.5

Operating voltage	Operation current	Part No.	Weight
 <p><b>Filament lamp</b></p>			
6 VAC/DC	200 mA	<b>10-1106.1369</b>	0.001 kg
12 VAC/DC	50 mA	<b>10-1109.1279</b>	0.001 kg
12 VAC/DC	100 mA	<b>10-1109.1329</b>	0.001 kg
24 VAC/DC	25 mA	<b>10-1112.1199</b>	0.001 kg
24 VAC/DC	50 mA	<b>10-1112.1279</b>	0.001 kg
28 VAC/DC	40 mA	<b>10-1113.1249</b>	0.001 kg
30 VAC/DC	40 mA	<b>10-1114.1249</b>	0.001 kg
36 VAC/DC	35 mA	<b>10-1116.1229</b>	0.001 kg
48 VAC/DC	25 mA	<b>10-1119.1199</b>	0.001 kg

## Series resistor

### Additional Information

- Only for filament lamp 48 VAC, 25 mA
- For lamp voltage reduction
- Keep to the country specific safety instructions
- Due to high surface temperatures, the series resistor must not be soldered directly to the terminals of the equipment (use a terminal plate)

Operating voltage	Resistance	Part No.	Weight
 <p><b>Series resistor</b></p>			
110 VAC	2.7 kOhm	<b>02-904.0</b>	0.003 kg
125 VAC	3.3 kOhm	<b>02-904.1</b>	0.003 kg
145 VAC	4.7 kOhm	<b>02-904.3</b>	0.003 kg
240 VAC	10 kOhm	<b>02-904.7</b>	0.003 kg

# 14 Accessories

## Terminal plate empty

### Additional Information

- For fitting with series resistors

Product attribute	Dimension	Part No.	Weight
 <b>Terminal plate empty</b>			
5 spaces	62.5 x 60 x 15 mm	<b>02-912.1</b>	0.025 kg
10 spaces	125 x 60 x 15 mm	<b>02-912.2</b>	0.045 kg
15 spaces	187.6 x 60 x 15 mm	<b>02-912.3</b>	0.090 kg
20 spaces	250 x 60 x 15 mm	<b>02-912.4</b>	0.095 kg

Mounting

Positioning insert



Mounting cut-outs [mm]

Part No.	Weight
 <p><b>Positioning insert</b></p>	
14-910	0.001 kg

Anti-twist ring

Part No.	Weight
 <p><b>Anti-twist ring, flush design</b></p>	
704.954.0	0.002 kg

# 14 Accessories

## Reducing ring

### Additional Information

- You need to install two reduction rings
- For mounting of Ø 22.5 mm device into Ø 30.5 mm mounting cut-out
- The colour of anodized aluminium parts can vary due to technical production reasons

Material	Colour	Part No.	Weight
 <p><b>Reducing ring</b></p>			
Aluminium	black anodized	<b>704.960.0</b>	0.004 kg
	natural anodized	<b>704.960.8</b>	0.004 kg

## Lens plug

### Additional Information

- For mounting and dismantling of lens round, flush design

Part No.	Weight
 <p><b>Lens plug for round lens, flush design</b></p>	
<b>700.006.0</b>	0.003 kg

## Lamp remover

### Additional Information

- ▲ **Caution:** A switching process might be released when replacing the lamp

Part No.	Weight
 <p><b>Lamp remover</b></p>	
<b>02-906</b>	0.002 kg

## Enclosure, IP 66

### Additional Information

- Cover lead-sealable
- Openings for cable gland M16 or M20



Dimensions [mm]

Product attribute	Dimension	Material	Colour	Part No.	Weight
 <p><b>Enclosure</b></p>					
with mounting cut-out 1 x Ø 22.5 mm, with anti-twist device	L 94 x B 94 x H 81 mm	Plastic	grey, similar RAL 7035	<b>704.945.1</b>	0.211 kg
 <p><b>Enclosure</b></p>					
with mounting cut-out 2 x Ø 22.5 mm, with anti-twist device	L 130 x B 94 x H 81 mm	Plastic	grey, similar RAL 7035	<b>704.945.2</b>	0.251 kg
 <p><b>Enclosure</b></p>					
with mounting cut-out 3 x Ø 22.5 mm, with anti-twist device	L 180 x B 94 x H 81 mm	Plastic	grey, similar RAL 7035	<b>704.945.3</b>	0.313 kg
 <p><b>Enclosure</b></p>					
with mounting cut-out 4 x Ø 22.5 mm, with anti-twist device	L 180 x B 182 x H 110 mm	Plastic	grey, similar RAL 7035	<b>704.945.4</b>	0.572 kg
 <p><b>Enclosure</b></p>					
with mounting cut-out 6 x Ø 22.5 mm, with anti-twist device	L 180 x B 182 x H 110 mm	Plastic	grey, similar RAL 7035	<b>704.945.5</b>	0.568 kg

# 14 Accessories

## Cable gland, IP 68

### Additional Information

- With traction relief

Product attribute	Thread	Material	Colour	Part No.	Weight
 <p><b>Cable gland</b></p>					
Clamping range Ø 6 ... 12 mm, thread length 9 mm	M20 x 1.5	Plastic	grey	<b>704-945.6</b>	0.011 kg
Clamping range Ø 4 ... 10 mm, thread length 8 mm	M16 x 1.5	Plastic	grey	<b>61-9481.6</b>	0.007 kg

## Drawings



# 14 Technical data

## Actuator with snap-action switching element

### Switching system

Self-cleaning, double-break, snap action switching system (with contact gap 2 x 0.5 mm).  
1 normally closed or 1 normally open contact per element.  
Snap-action switching elements with soldering terminals at the sides: up to 4 switching element can be on a pushbutton (max. 4 normally closed and 4 normally open contacts).  
Snap-action switching element with axial plug-in terminals 2.8 mm stackable, only 1 switching element can be on a pushbutton.

### Material

#### Material of contact

Gold plated silver

#### Switch housing

Plug-in-/soldering terminal  
Diallylphthalate DAP, Polyamide 66, Polysulfone, heat-resistant and self-extinguishing  
Soldering terminal: PA 6.6 Ultramide

#### Actuator housing

Polyamide

### Mechanical characteristics

#### Terminals

Snap-action switching element with tinned soldering terminals at the sides:  
Max. wire diameter 2 wires à 1.2 mm  
max. wire cross-section of stranded cable 1x 1 mm<sup>2</sup>

Snap-action switching element with axial plug-in terminals, which can also be used as soldering terminals: Plug-in terminal 2.8 x 0.5 mm

Soldering terminal:

Max. wire diameter 2 wires of 1 mm

Max. wire cross-section of stranded cable 2 x 0.75 mm<sup>2</sup> or 1 x 1.0 mm<sup>2</sup>

#### Tightening torque

for fixing nut max. 25 Ncm

#### Actuating torque

Measured at the key or lever of the keylock- or selector switch 2.5 Ncm ... 5.5 Ncm, depending on the number of switching elements

#### Actuating force

Maintain 5 N ... 8 N

Momentary 3 N ... 6 N

depending on the number of switching elements

#### Actuating travel

Illuminated pushbutton: 3 mm

Switch actuator 2 positions:

Momentary action 1 x ca. 42° deflection momentary action

Maintained action 1 x ca. 90° deflection maintained action

### Rebound time

≤ 5 ms

### Mechanical lifetime

Momentary action 2 million Cycles of operation

Maintained action 1 million Cycles of operation

### Electrical characteristics

#### Standards

The devices comply with: EN IEC 61058-1

#### Rated voltage

250 VAC as per EN IEC 61058-1-15

#### Contact resistance

New state ≤ 50 mΩ as per DIN IEC 60512-2-4

#### Electrostatic discharge (ESD)

Keylock switch 15 kV

#### Rated current

5 A

#### Conventional free air thermal current I<sub>th</sub>

5 A

The maximum current in continuous operation and at ambient temperature not exceeding the quoted maximum values.

#### Switch rating

250 VAC, 5 A (cosφ 1)

250 VAC, 3 A (cosφ 0.3)

Switch rating AC (cosφ 0.7)

Voltage 12 VAC 250 VAC

Current 3 A 2 A

Switch rating DC (inductive) L:R = 30 ms

Voltage 24 VDC 60 VDC 110 VDC 220 VDC

Current 2 A 0.7 A 0.2 A 0.1 A

#### Electric strength

3000 VAC, 50 Hz, 1 min. between all terminals and earth, as per EN IEC 61058-1-15

#### Isolation resistance

> 7 MΩ between the open contacts at 500 VDC, as per EN IEC 61058-1-15 (reinforced insulation)

#### Protection class

II

### Environmental conditions

#### Storage temperature

-40 °C ... +85 °C

#### Service temperature

-25 °C ... +55 °C

For indicators and illuminated pushbuttons mounted as a block, make sure the heat can escape freely.



### Protection degree

as per EN IEC 60529  
 Indicator front side IP 67  
 Illuminated pushbutton front side IP 67  
 Mushroom-head pushbutton front side IP 67  
 Selector switch front side IP 67  
 Keylock switch IP 65 front side

### Shock resistance

(semi-sinusoidal)  
 max. 150 m/s<sup>2</sup>, pulse width 11 ms, 3-axis, as per  
 EN IEC 60068-2-27

### Vibration resistance

(sinusoidal)  
 max. 100 m/s<sup>2</sup> at 10 Hz ... 500 Hz, as per EN IEC 60068-2-6

### Climate resistance

Damp heat state as per EN IEC 60068-2-30  
 Damp heat cyclic as per EN IEC 60068-2-78

### Approvals

#### Approbations

CB (IEC 61058)  
 CSA  
 CQC  
 ENEC (EN 61058)  
 Germanischer Lloyd  
 UL

#### Declaration of conformity

CE

## Actuator with low level switching element

### Switching system

This low level switching element was designed for switching low powers in electronic circuits. The mechanism assures reliable switching of loads ranging from a few  $\mu\text{A}/\mu\text{V}$  up to 100 mA/42 VAC/DC.

Single-break momentary contact, as normally open or normally closed with 4 independent points of contact. 2 momentary contacts per switching element; combination of normally open and normally closed is possible.

Special features are the long life, extremely short rebound time and stable contact resistance.

### Material

#### Material of contact

Gold plated

#### Switch housing

Polysulfone, heat-resistant and self-extinguishing

#### Actuator housing

Polyamide

### Mechanical characteristics

#### Terminals

The universal terminals permit these units to be mounted on printed circuit boards (PCB). These terminals can also be used as soldering or plug-in terminals.

For these terminals we can also supply a plug-in base which, when soldered on to the board, enables the switch to be plugged in.

Soldering terminal:

Max. wire diameter 2 wires of 1 mm

Max. wire cross-section of stranded cable 2 x 0.75 mm<sup>2</sup>

Plug-in terminal: 2.0 x 0.5 mm

#### Tightening torque

for fixing nut max. 25 Ncm

### Actuating torque

Measured at the key or lever of the keylock- or selector switch 2.5 Ncm ... 5.5 Ncm, depending on the number of switching elements

### Actuating force

3 ... 4 N, depending on the number of switching elements

### Actuating travel

Illuminated pushbutton: 3 mm

Switch actuator 2 positions:

Momentary action 1 x ca. 42° deflection momentary action

Maintained action 1 x ca. 90° deflection maintained action

### Rebound time

typical < 100  $\mu\text{s}$

### Mechanical lifetime

Momentary action 5 million cycles of operation

Maintained action 1 million cycles of operation

### Electrical characteristics

#### Contact resistance

New state  $\leq 50 \text{ m}\Omega$  as per DIN IEC 60512-2-4

#### Electrostatic discharge (ESD)

Keylock switch 15 kV

#### Switch rating

10  $\mu\text{A}$ , 100  $\mu\text{V}$  to 100 mA at 42 VAC/VDC

#### Electric strength

3000 VAC, 50 Hz, 1 min. between all terminals and earth, as per EN IEC 61058-1-15

#### Protection class

II

# 14 Technical data

## Environmental conditions

### Storage temperature

-40 °C ... +85 °C

### Service temperature

-25 °C ... +55 °C

For indicators and illuminated pushbuttons mounted as a block, make sure the heat can escape freely.

### Protection degree

as per EN IEC 60529

Indicator front side IP 67

Illuminated pushbutton front side IP 67

Mushroom-head pushbutton front side IP 67

Selector switch front side IP 67

Keylock switch IP 65 front side

### Shock resistance

(semi-sinusoidal)

max. 150 m/s<sup>2</sup>, pulse width 11 ms, 3-axis, as per

EN IEC 60068-2-27

## Buzzer

### Buzzer system

#### System

Piezo disc

#### Material

#### Buzzer case

Polyamide

#### Front cap

Plastic Polyamide

Metal Nickel-plated brass (sea-water proof)

### Mechanical characteristics

#### Terminals

Plug-in terminal 2.8 x 0.5 mm

#### Tightening torque

for fixing nut max. 25 Ncm

### Electrical characteristics

#### Frequency (tone)

approx. 2.8 kHz continuous tone only

#### Sound pressure

95 db (A) ±8 dB at a distance of 0.1 m

#### Operation Voltage/Current

Operation Voltage 24 VDC ±10 %

Operation Current ≤ 25 mA

### Environmental conditions

#### Storage temperature

-40 °C ... +85 °C

#### Operating temperature

-25 °C ... +55 °C

#### Protection degree

as per EN IEC 60529, frontside

Buzzer flush design front side IP 40

Buzzer raised design front side IP 65

### Approvals

#### Approbations

CQC

EMC

#### Declaration of conformity

CE

*EAO reserves the right to alter specifications without further notice.*

## General notes

### 1. Engraving

In addition to the most commonly used world languages, in DIN1451-3 close spacing, other typefaces are available as Scandinavian, Slavic, Greek, Russian and Polish. The engraved marking caps and plates are filled with black or white colour. Standard height of letters is 3 mm. If the height is not specified, we will supply 3mm engraved letters.

### 2. Hot stamping

Standard legends and ISO symbols are hot stamped. For larger series it is worth considering markings by means of hot stamping. We will be pleased to advise you.

## Engraving marking cap for Indicator round, full face illumination

All dimensions in mm

Height of letters	Number of lines	Number of letters per line (target value)			Line spacing
		b1	b2	b3	
h		b1	b2	b3	d
3	3	11	10	9	4.6
4	2	8	7	-	6.6
8	1	4	-	-	-



The gap between two words results in each case a letter less.

## Engraving marking cap for Indicator and illuminated Pushbutton round, front illumination

All dimensions in mm

Height of letters	Number of lines	Number of letters per line (target value)			Line spacing
		b1	b2	b3	
h		b1	b2	b3	d
3	3	9	9	7	4.6
4	2	7	6	-	6.6
8	1	3	-	-	-



The gap between two words results in each case a letter less.

# 14 Marking

## Engraving legend plates

All dimensions in mm

Dimension	Devices mounting style	Height of letters	Number of lines	Number of letters per line (target value)	Image
		<b>h</b>			
30 x 50	round, raised	3	2	12	B1
30 x 50	round, raised	4	1	7	B1
30 x 50	round, raised	8	1	4	B1
35 x 57.5	round, flush	3	2	12	B2
35 x 57.5	round, flush	4	1	7	B2
35 x 57.5	round, flush	8	1	4	B2

B1

B2



The gap between two words results in each case a letter less.

## Standard texts for marking plates and marking caps for Indicator and Illuminated Pushbutton

Height of letters 6 mm

















I Part No. 704.609.912001	II Part No. 704.609.912002	III Part No. 704.609.912003	O Part No. 704.609.912004
EIN Part No. 704.609.912005	AUS Part No. 704.609.912006	AUF Part No. 704.609.912007	AB Part No. 704.609.912008
START Part No. 704.609.912009	STOP Part No. 704.609.912010	HAND Part No. 704.609.912011	AUTO Part No. 704.609.912012
ZU Part No. 704.609.912013	ON Part No. 704.609.912014	OFF Part No. 704.609.912015	ARRET Part No. 704.609.912016
MARCHE Part No. 704.609.912017	RESET Part No. 704.609.912018		

## Symbols for marking plates and marking caps for Indicator and Illuminated Pushbutton

All marking plates with the printed article-numbers are available for flat lenses, marking cap only on request.

 <b>Part No. 704.609.910001</b> Direction of linear rectilinear motion (also for $\rightarrow \updownarrow$ )	 <b>Part No. 704.609.910002</b> Linear motion in 2 directions (also for $\downarrow$ )	 <b>Part No. 704.609.910003</b> Interrupted linear motion $\updownarrow$ (also for $\leftarrow \leftarrow \updownarrow$ )	 <b>Part No. 704.609.910004</b> Limited linear motion (also for $\leftarrow \updownarrow$ )
 <b>Part No. 704.609.910005</b> Limited linear motion and return	 <b>Part No. 704.609.910006</b> Oscillating linear motion (continuous)	 <b>Part No. 704.609.910007</b> Direction of continuous rotation (right)	 <b>Part No. 704.609.9100071</b> Direction of continuous rotation (left)
 <b>Part No. 704.609.910008</b> Rotation in 2 directions	 <b>Part No. 704.609.910009</b> Direction of interrupted rotation (right)	 <b>Part No. 704.609.9100091</b> Direction of interrupted rotation (left)	 <b>Part No. 704.609.910010</b> Limited rotation (right)
 <b>Part No. 704.609.9100101</b> Limited rotation (left)	 <b>Part No. 704.609.910011</b> Limited rotation and return	 <b>Part No. 704.609.910012</b> Oscillating rotary movement (continuous)	 <b>Part No. 704.609.910013</b> Direction of spindle rotation
 <b>Part No. 704.609.910014</b> One revolution	 <b>Part No. 704.609.910015</b> Number of revolutions per minute (spindle speed)	 <b>Part No. 704.609.910016</b> Feed	 <b>Part No. 704.609.910017</b> Feed per revolution
 <b>Part No. 704.609.910018</b> Feed per minute	 <b>Part No. 704.609.910019</b> Reduced feed	 <b>Part No. 704.609.910020</b> Rapid feed	 <b>Part No. 704.609.910021</b> Normal feed
 <b>Part No. 704.609.910022</b> Direction of feed (orientation not specified)	 <b>Part No. 704.609.910024</b> Transverse feed	 <b>Part No. 704.609.910025</b> Vertical feed	 <b>Part No. 704.609.910026</b> Rapid traverse
 <b>Part No. 704.609.910027</b> Threading	 <b>Part No. 704.609.910028</b> Increase of value (speed, for instance)	 <b>Part No. 704.609.910029</b> Decrease of value (speed, for instance)	 <b>Part No. 704.609.910030</b> Speed of planing cut
 <b>Part No. 704.609.910031</b> Speed of turning cut	 <b>Part No. 704.609.910032</b> Speed of drilling cut	 <b>Part No. 704.609.910033</b> Speed of milling cut (similar symbol for speed of grinding)	 <b>Part No. 704.609.910034</b> Conventional milling
 <b>Part No. 704.609.910035</b> Climb milling (down milling)	 <b>Part No. 704.609.910041</b> Electric motor	 <b>Part No. 704.609.910042</b> Rectangular work table or slide element	 <b>Part No. 704.609.910043</b> Round work table or rotating element
 <b>Part No. 704.609.910044</b> Turning spindle	 <b>Part No. 704.609.910045</b> Drilling spindle	 <b>Part No. 704.609.910046</b> Milling spindle	 <b>Part No. 704.609.910047</b> Schleifscheibenfutter
 <b>Part No. 704.609.910048</b> Pump (general symbol)	 <b>Part No. 704.609.910049</b> Cooling pump	 <b>Part No. 704.609.910050</b> Lubricant pump	 <b>Part No. 704.609.910051</b> Hydraulic system pump
 <b>Part No. 704.609.910052</b> Hydraulic motor	 <b>Part No. 704.609.910053</b> Tracer	 <b>Part No. 704.609.910061</b> Stepless regulation	 <b>Part No. 704.609.910062</b> Adjustable

# 14 Marking

 <p><b>Part No. 704.609.9100631</b> Lock or tighten</p>	 <p><b>Part No. 704.609.9100632</b> Lock or tighten</p>	 <p><b>Part No. 704.609.9100641</b> Unlock, unclamp</p>	 <p><b>Part No. 704.609.9100642</b> Unlock, unclamp</p>
 <p><b>Part No. 704.609.910065</b> Brake on</p>	 <p><b>Part No. 704.609.910066</b> Brake off</p>	 <p><b>Part No. 704.609.910067</b> Automatic (or semi-automatic) cycle</p>	 <p><b>Part No. 704.609.910068</b> Hand control</p>
 <p><b>Part No. 704.609.910069</b> Start, on</p>	 <p><b>Part No. 704.609.910070</b> Stop, off</p>	 <p><b>Part No. 704.609.910071</b> Start and stop with same button</p>	 <p><b>Part No. 704.609.910072</b> In action as long as button is operated</p>
 <p><b>Part No. 704.609.910074</b> Engaging (mechanical start)</p>	 <p><b>Part No. 704.609.910075</b> Disengaging (mechanical stop)</p>	 <p><b>Part No. 704.609.910076</b> Close lock-nut</p>	 <p><b>Part No. 704.609.910077</b> Open lock-nut</p>
 <p><b>Part No. 704.609.910078</b> Engage sensor</p>	 <p><b>Part No. 704.609.910079</b> Disengage sensor</p>	 <p><b>Part No. 704.609.910080</b> Change speed only in stopped position</p>	 <p><b>Part No. 704.609.910081</b> Change speed only in motion</p>
 <p><b>Part No. 704.609.910091</b> Shear pin construction</p>	 <p><b>Part No. 704.609.910092</b> Danger (high voltage)!</p>	 <p><b>Part No. 704.609.910093</b> Caution!</p>	 <p><b>Part No. 704.609.910094</b> Main switch</p>
 <p><b>Part No. 704.609.910101</b> Coolant fluid</p>	 <p><b>Part No. 704.609.910102</b> Machine lighting</p>	 <p><b>Part No. 704.609.910103</b> Weight</p>	 <p><b>Part No. 704.609.910104</b> Filter opening</p>
 <p><b>Part No. 704.609.910105</b> Overflow</p>	 <p><b>Part No. 704.609.910106</b> Drain</p>	 <p><b>Part No. 704.609.910107</b> Oil, lubricant</p>	 <p><b>Part No. 704.609.910108</b> Blast</p>
 <p><b>Part No. 704.609.910109</b> Suction</p>			

## Suppressor circuits

When switching inductive loads such as relays, DC motors, and DC solenoids, it is always important to absorb surges (e.g. with a diode) to protect the contacts. When these inductive loads are switched off, a counter emf can severely damage switch contacts and greatly shorten lifetime.

Fig. 1 shows an inductive load with a free-wheeling diode connected in parallel. This free-wheeling diode provides a path for the inductor current to flow when the current is interrupted by the switch. Without this free-wheeling diode, the voltage across the coil will be limited only by dielectric breakdown voltages of the circuit or parasitic elements of the coil. This voltage can be kilovolts in amplitude even when nominal circuit voltages are low (e.g. 12VDC) see Fig. 2.

The free-wheeling diode should be chosen so that the reverse breakdown voltage is greater than the voltage driving the inductive load. The DC blocking voltage ( $V_R$ ) of the free-wheeling diode can be found in the datasheet of a diode. The forward current should be equal or greater than the maximum current flowing through the load.

**To get an efficient protection, the free-wheeling diode must be connected as close as possible to the inductive load!**

Switching with inductive load  
Fig. 1

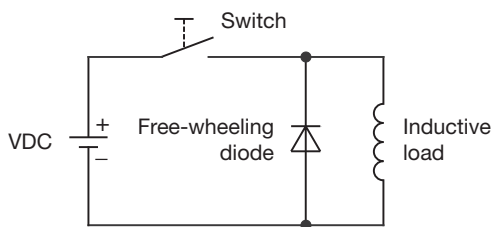

Counter EMF  
over load without free-wheeling diode  
Fig. 2



## LED polarity

When fitting the LED elements the polarity has to correspond with the respective terminals, (+) goes to +.

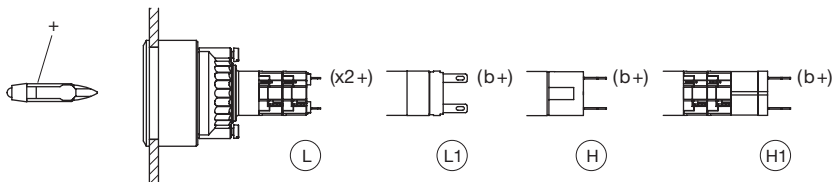

L = Solder terminal, L1 = Solder terminal 2.0 x 0.5 mm  
H = Universal terminal, H1 = Universal-Solder terminal

# 14 Index

## Index from Part No.

Part No.	Page	Part No.	Page	Part No.	Page	Part No.	Page	Part No.	Page	Part No.	Page
01-928	47	14-133.0252	27	14-411.036K	14	14-501.0220	31	704.600.0	39	704.960.4	44
01-929	47	14-134.0252	7	14-411.036K	29	14-501.02502	16	704.600.0	40	704.960.8	52
02-904.0	49	14-134.0252	9	14-412.036K	14	14-501.02502	31	704.600.1	39	704.964.8	44
02-904.1	49	14-134.0252	12	14-412.036K	29	14-502.02502	16	704.600.1	40	704.968.0	42
02-904.3	49	14-134.0252	22	14-414.036K	14	14-502.02502	31	704.600.1A	39	704.968.1	42
02-904.7	49	14-134.0252	24	14-414.036K	29	14-503.02502	16	704.600.1A	40	704.968.2	41
02-906	52	14-134.0252	27	14-415.036K	14	14-503.02502	31	704.600.2	41	704.968.3	41
02-912.1	50	14-135.022K	14	14-415.036K	29	14-506.0220	16	704.600.3	41		
02-912.2	50	14-135.022K	30	14-417.036K	14	14-506.0220	31	704.600.5/A	41		
02-912.3	50	14-135.025K2	14	14-417.036K	29	14-506.02502	16	704.600.6	39		
02-912.4	50	14-135.025K2	29	14-418.036K	14	14-506.02502	31	704.600.6	40		
10-1106.1369	49	14-136.025K2	15	14-418.036K	29	14-507.02502	16	704.600.9	39		
10-1109.1279	49	14-136.025K2	30	14-431.036	6	14-507.02502	31	704.600.9	40		
10-1109.1329	49	14-137.025K2	15	14-431.036	9	14-508.02502	16	704.601.0	34		
10-1112.1199	49	14-137.025K2	30	14-431.036	11	14-508.02502	31	704.601.01	34		
10-1112.1279	49	14-138.025K2	15	14-431.036	21	14-509.02502	16	704.601.2	34		
10-1113.1249	49	14-138.025K2	30	14-431.036	24	14-509.02502	31	704.601.21	34		
10-1114.1249	49	14-141.022K	14	14-431.036	26	14-515.0360	16	704.601.4	34		
10-1116.1229	49	14-141.022K	29	14-432.036	6	14-515.0360	31	704.601.41	34		
10-1119.1199	49	14-141.025K2	14	14-432.036	9	14-517.0360	16	704.601.5	34		
10-2106.3142	48	14-141.025K2	29	14-432.036	11	14-517.0360	31	704.601.51	34		
10-2106.3144	48	14-142.025K2	14	14-432.036	21	14-520.0360	16	704.601.6	34		
10-2106.3145	48	14-142.025K2	29	14-432.036	24	14-520.0360	31	704.601.61	34		
10-2106.3146	48	14-143.025K2	14	14-432.036	26	14-521.0360	16	704.601.8	34		
10-2106.3149	49	14-143.025K2	29	14-433.036	6	14-521.0360	31	704.601.81	34		
10-2109.1062	48	14-144.025K2	14	14-433.036	9	14-522.0360	16	704.601.9	34		
10-2109.1064	48	14-144.025K2	29	14-433.036	11	14-522.0360	31	704.601.91	34		
10-2109.1065	48	14-235.022K	14	14-433.036	21	14-556.0220	32	704.602.0	33		
10-2109.1066	48	14-235.022K	30	14-433.036	24	14-556.02502	32	704.602.2	33		
10-2109.1069	49	14-235.025K2	14	14-433.036	26	14-557.02502	32	704.602.4	33		
10-2112.1062	48	14-235.025K2	29	14-435.036	6	14-570.0360	32	704.602.5	33		
10-2112.1064	48	14-236.025K2	15	14-435.036	9	14-572.0360	32	704.602.6	33		
10-2112.1065	48	14-236.025K2	30	14-435.036	11	14-741.006	18	704.602.7	33		
10-2112.1066	48	14-237.025K2	15	14-435.036	21	14-742.006	18	704.602.7A01	33		
10-2112.1069	49	14-237.025K2	30	14-435.036	24	14-743.0292	6	704.603.2	35		
10-2113.1062	48	14-238.025K2	15	14-435.036	26	14-743.0292	11	704.603.4	35		
10-2113.1064	48	14-238.025K2	30	14-436.036	6	14-743.0292	21	704.603.5	35		
10-2113.1065	48	14-271.022	6	14-436.036	9	14-743.0292	26	704.603.6	35		
10-2113.1066	48	14-271.022	9	14-436.036	11	14-744.0292	6	704.603.7	35		
10-2113.1069	49	14-271.022	11	14-436.036	21	14-744.0292	11	704.604.0	35		
10-2119.1042	48	14-271.022	21	14-436.036	24	14-744.0292	21	704.604.2	35		
10-2119.1044	48	14-271.022	24	14-436.036	26	14-744.0292	26	704.604.4	35		
10-2119.1045	48	14-271.022	26	14-437.036K	14	14-746.0292	6	704.604.5	35		
10-2119.1046	48	14-271.0252	6	14-437.036K	29	14-746.0292	11	704.608.7	37		
10-2119.1049	49	14-271.0252	9	14-438.036K	14	14-746.0292	21	704.608.9	37		
14-030.002	18	14-271.0252	11	14-438.036K	29	14-746.0292	26	704.609.0	36		
14-030.005	18	14-271.0252	21	14-471.036	6	14-747.0292	6	704.609.7	36		
14-031.006	18	14-271.0252	24	14-471.036	9	14-747.0292	11	704.609.9	36		
14-040.002	4	14-271.0252	26	14-471.036	11	14-747.0292	21	704.609.9	37		
14-040.002	19	14-272.0252	7	14-471.036	21	14-747.0292	26	704.609.9A01	36		
14-040.005	4	14-272.0252	9	14-471.036	24	14-748.0292	6	704.610.7	37		
14-040.005	19	14-272.0252	12	14-471.036	26	14-748.0292	11	704.610.9	37		
14-041.006	4	14-272.0252	22	14-472.036	6	14-748.0292	21	704.611.2	33		
14-041.006	19	14-272.0252	24	14-472.036	9	14-748.0292	26	704.611.4	33		
14-131.022	6	14-272.0252	26	14-472.036	11	14-810.002	20	704.611.5	33		
14-131.022	9	14-273.0252	7	14-472.036	21	14-810.902	20	704.611.7	33		
14-131.022	11	14-273.0252	9	14-472.036	24	14-810.910	5	704.614.2	36		
14-131.022	21	14-273.0252	12	14-472.036	26	14-810.918	5	704.614.4	36		
14-131.022	24	14-273.0252	22	14-473.036	6	14-910	51	704.614.5	36		
14-131.022	26	14-273.0252	24	14-473.036	9	14-955.0	38	704.614.6	36		
14-131.0252	6	14-273.0252	27	14-473.036	11	14-955.1	38	704.614.7	36		
14-131.0252	9	14-274.0252	7	14-473.036	21	14-955.3	39	704.925.0	44		
14-131.0252	11	14-274.0252	9	14-473.036	24	14-955.4	39	704.925.2	44		
14-131.0252	21	14-274.0252	12	14-473.036	26	14-955.9	38	704.925.3	44		
14-131.0252	24	14-274.0252	22	14-475.036	6	14-955.9E	39	704.925.7	43		
14-131.0252	26	14-274.0252	24	14-475.036	9	14-958.0	38	704.928.18	43		
14-132.0252	6	14-274.0252	27	14-475.036	11	14-958.8	38	704.928.28	43		
14-132.0252	9	14-335.022K	15	14-475.036	21	14-987.1001	45	704.928.38	43		
14-132.0252	12	14-335.022K	30	14-475.036	24	31-928	47	704.945.1	53		
14-132.0252	21	14-335.025K2	14	14-475.036	26	31-929	47	704.945.2	53		
14-132.0252	24	14-335.025K2	29	14-476.036	6	31-940	46	704.945.3	53		
14-132.0252	26	14-336.025K2	15	14-476.036	9	31-941	46	704.945.4	53		
14-133.0252	7	14-336.025K2	30	14-476.036	11	31-942	46	704.945.5	53		
14-133.0252	9	14-337.025K2	15	14-476.036	21	31-945	47	704.945.6	54		
14-133.0252	12	14-337.025K2	30	14-476.036	24	31-946	47	704.953.0	40		
14-133.0252	22	14-338.025K2	15	14-476.036	26	61-9481.6	54	704.954.0	51		
14-133.0252	24	14-338.025K2	30	14-501.0220	16	700.006.0	52	704.960.0	52		



## Данный компонент на территории Российской Федерации

### Вы можете приобрести в компании MosChip.

Для оперативного оформления запроса Вам необходимо перейти по данной ссылке:

<http://moschip.ru/get-element>

Вы можете разместить у нас заказ для любого Вашего проекта, будь то серийное производство или разработка единичного прибора.

В нашем ассортименте представлены ведущие мировые производители активных и пассивных электронных компонентов.

Нашей специализацией является поставка электронной компонентной базы двойного назначения, продукции таких производителей как XILINX, Intel (ex.ALTERA), Vicor, Microchip, Texas Instruments, Analog Devices, Mini-Circuits, Amphenol, Glenair.

Сотрудничество с глобальными дистрибьюторами электронных компонентов, предоставляет возможность заказывать и получать с международных складов практически любой перечень компонентов в оптимальные для Вас сроки.

На всех этапах разработки и производства наши партнеры могут получить квалифицированную поддержку опытных инженеров.

Система менеджмента качества компании отвечает требованиям в соответствии с ГОСТ Р ИСО 9001, ГОСТ РВ 0015-002 и ЭС РД 009

### Офис по работе с юридическими лицами:

105318, г.Москва, ул.Щербаковская д.3, офис 1107, 1118, ДЦ «Щербаковский»

Телефон: +7 495 668-12-70 (многоканальный)

Факс: +7 495 668-12-70 (доб.304)

E-mail: [info@moschip.ru](mailto:info@moschip.ru)

Skype отдела продаж:

moschip.ru

moschip.ru\_4

moschip.ru\_6

moschip.ru\_9