

**Variable Transformers
Series 500 • 5.0 Amperes**



500 Series

Versatility, compactness and durability are included in the many designed-in features of the STACO 501C Series Variable Transformers. These transformers operate from 120 volt input lines and are rated at 5 amperes for constant current loads and 7 amperes for constant impedance loads at line voltage. The coil tapping arrangement permits output voltage of 0 to line voltage or 17% above line voltage on constant current line conditions. This unit's Faston® terminals are easily converted to screw connections with the terminal adapter kits supplied with each unit.

The STACO 511 is ideal for OEM applications with its panel mount, fixed shaft design and even smaller envelope than the

501C. It can be single point or four point mounted. The four point mounting is the same as the 501-C.

Either unit can be operated from 50-2000 hertz without derating.

Motor driven units are available and identified by the prefix "M" in the type number. The synchronous motor is designed for operation on 120 volt, 50/60 Hertz single phase lines and draws approximately 0.3 amperes. If a motor driven model is ordered, be sure to prefix the part number with the desired travel time from 0 to maximum of 5, 15, 30, or 60 seconds.

PART NO.	WIRING	INPUT		OUTPUT				SHAFT ROTATION FOR VOLTAGE INCREASE	TERMINAL CONNECTIONS (For increasing Voltage) As Viewed from Base End			SCHEMATIC (Pg 8 & 9)	NET WT. LBS.	(Max) MOTOR DRIVEN	
		VOLTS	HERTZ	VOLTS	CONSTANT CURRENT LOAD		CONSTANT IMPEDANCE LOAD		Input	Jumper*	Output				
					MAX AMPS	MAX KVA	MAX AMPS								MAX KVA
501C M501C+	Single Phase	120	50/60	0-120	5.0	0.60	7.0	0.84	CW	1-4	—	4-3	10	5 1/4	12
				0-140	5.0	0.70	—	—	CCW	1-4	—	1-3			
									CW	4-5	—	4-3			
									CCW	1-2	—	1-3			
501C-2 M501C-2+	Single Phase Series	240	50/60	0-240	5.0	1.2	7.0	1.68	CW	1-1	4-4	3-3	10 & 4	11 1/2	20
				0-280	5.0	1.4	—	—	CCW	4-4	1-1	3-3			
									CW	5-5	4-4	3-3			
									CCW	2-2	1-1	3-3			
	Three Phase Open Deltart	120 ++	50/60	0-120	5.0	1.04	7.0	1.46	CW	1-4-1	4-4	3-4-3	10 & 5	15 1/2	26
				0-140	5.0	1-21	—	—	CCW	4-1-4	1-1	3-1-3			
									CW	5-4-5	4-4	3-4-3			
									CCW	2-1-2	1-1	3-1-3			
501C-3 M501C-3+	Three Phase Wye	240 ++	50/60	0-240	5.0	2.08	7.0	2.91	CW	1-1-1	4-4-4	3-3-3	10 & 6	15 1/2	26
			60	0-280	5.0	2.43	—	—	CCW	4-4-4	1-1-1	3-3-3			
							CW	5-5-5	4-4-4	3-3-3					
							CCW	2-2-2	1-1-1	3-3-3					
3PN501B	Single Phase	120	50/60	0-140	5.0 ‡	0.70	—	—	CW	LINE CORD & RECEPTACLE			3	7 3/4	
511	Single Phase	120	50/60	0-120	5.0	0.60	7.0	0.84	CW	1-4	—	4-3	8	4 1/2	
				0-140	5.0	0.70	—	—	CCW	4-2	—	4-4			

‡ Unit is fused for the constant current rating at the factory.

• Jumper provided in the standard common position and should be moved or removed as required.

++ Line to line voltage

†† If ganged units are used in a system that ordinarily has a common neutral or ground between source and load, the neutral or ground must be connected to the common terminals of the variable transformer assembly. If the system has no neutral, the load must be balanced or the transformers will be damaged.

+ Motor driven units use terminal connections for CCW increasing voltage as viewed from the base end. See figure 23 on page 9 for motor wiring.

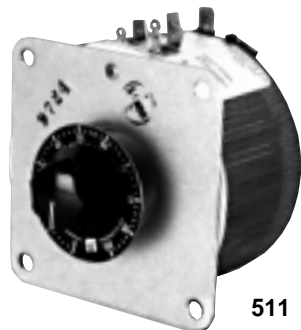

511

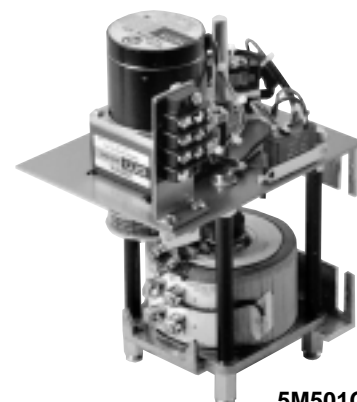
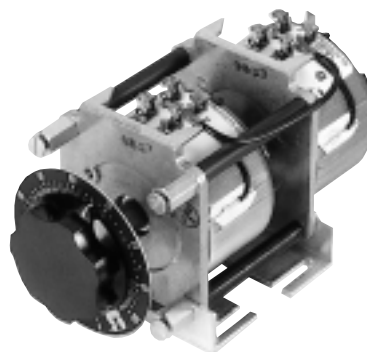

5M501C

500 Series

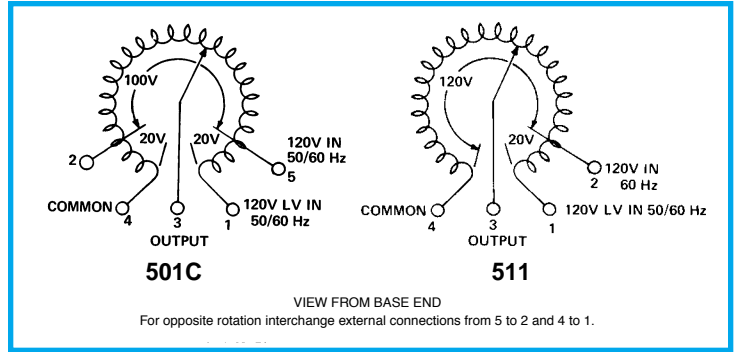
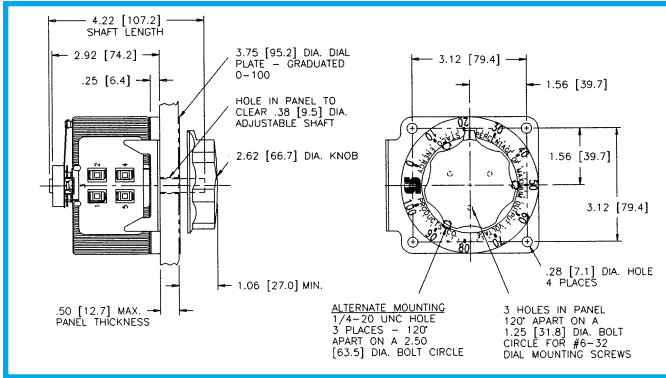

501C Single Unit

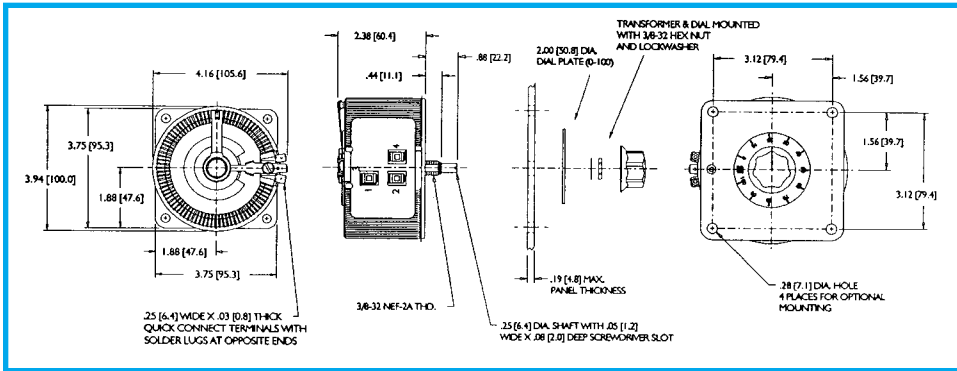

511 Single Unit

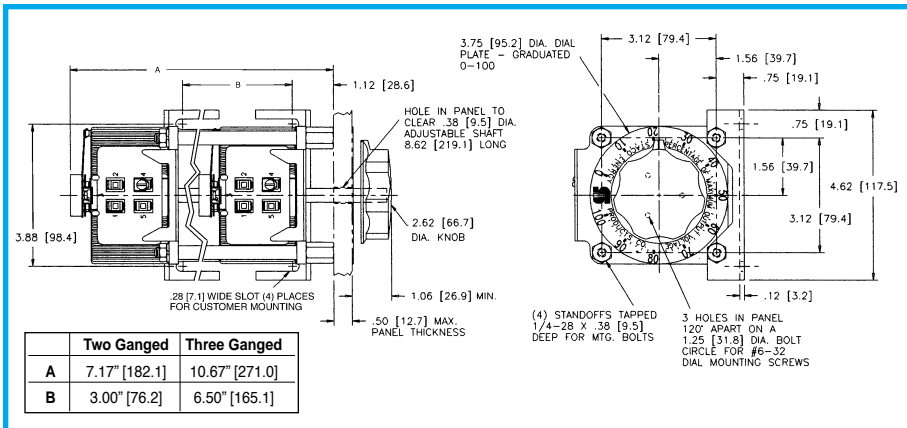

Two and Three Ganged, Manual

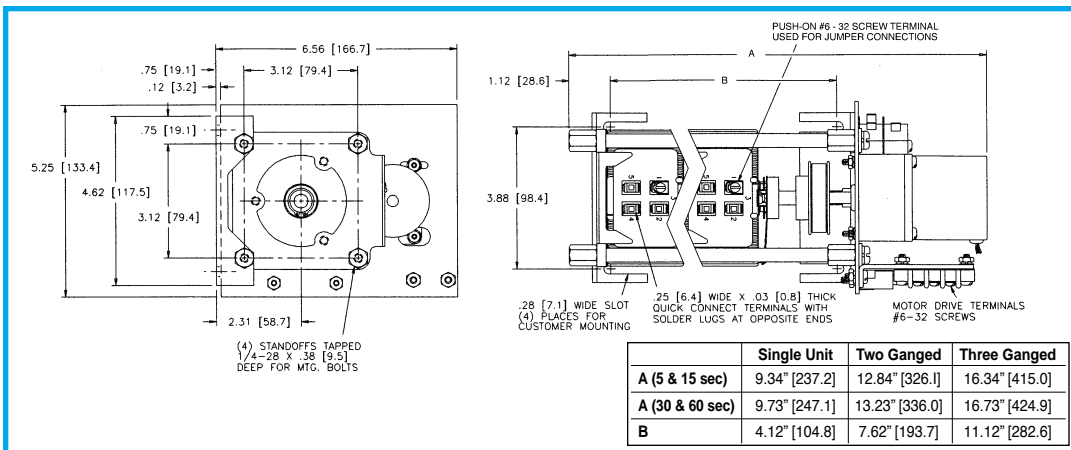

Motorized Single, Two and Three Ganged

Данный компонент на территории Российской Федерации

Вы можете приобрести в компании MosChip.

Для оперативного оформления запроса Вам необходимо перейти по данной ссылке:

<http://moschip.ru/get-element>

Вы можете разместить у нас заказ для любого Вашего проекта, будь то серийное производство или разработка единичного прибора.

В нашем ассортименте представлены ведущие мировые производители активных и пассивных электронных компонентов.

Нашей специализацией является поставка электронной компонентной базы двойного назначения, продукции таких производителей как XILINX, Intel (ex.ALTERA), Vicor, Microchip, Texas Instruments, Analog Devices, Mini-Circuits, Amphenol, Glenair.

Сотрудничество с глобальными дистрибьюторами электронных компонентов, предоставляет возможность заказывать и получать с международных складов практически любой перечень компонентов в оптимальные для Вас сроки.

На всех этапах разработки и производства наши партнеры могут получить квалифицированную поддержку опытных инженеров.

Система менеджмента качества компании отвечает требованиям в соответствии с ГОСТ Р ИСО 9001, ГОСТ РВ 0015-002 и ЭС РД 009

Офис по работе с юридическими лицами:

105318, г.Москва, ул.Щербаковская д.3, офис 1107, 1118, ДЦ «Щербаковский»

Телефон: +7 495 668-12-70 (многоканальный)

Факс: +7 495 668-12-70 (доб.304)

E-mail: info@moschip.ru

Skype отдела продаж:

moschip.ru

moschip.ru_4

moschip.ru_6

moschip.ru_9