

### Applications

- Clock Driver for Optical Systems
- VSAT
- Point-to-Point Radio
- Test Equipment & Sensors



QFN 4x4mm 24L

### Product Features

- Frequency Range: 11 - 17 GHz
- Power: 27 dBm P1dB
- Gain: 27 dB
- Output TOI: 34 dBm
- Attenuation Range: 14 dB
- Bias:  $V_d = 6\text{ V}$ ,  $I_d = 210\text{ mA}$ ,  $V_g = -0.7\text{ V}$  Typical
- Package Dimensions: 4.0 x 4.0 x 0.85 mm

### Functional Block Diagram

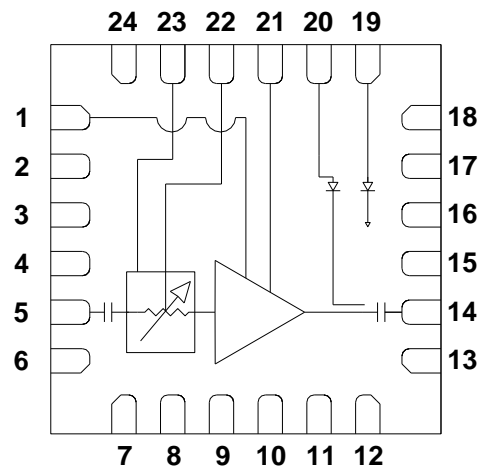

### General Description

The TriQuint TGA2565-SM is a medium power variable gain amplifier to be used as a driver amplifier in linear Ka band applications. The TGA2565-SM operates from 11 to 17 GHz and is designed using TriQuint's PHEMT production process.

The TGA2565-SM typically provides 27 dBm of power with 27 dB of small signal gain and 34 dBm of output TOI. The attenuation range is typically 14 dB. Internal attenuators and power detector circuitry allow the user to monitor and / or control output power.

The TGA2565-SM is available in a low-cost, surface mount 24 lead 4x4 mm QFN package and is ideally suited for Clock Driver applications, specifically designed for 11.3, 14.5, and 16.5 GHz clock frequencies.

Lead-free and RoHS compliant.  
Evaluation Boards are available upon request.

### Pin Configuration

Pin #	Symbol
1	Vg
2, 3, 4, 6, 7, 8, 9, 10, 11, 12, 13, 15, 16, 17, 18	N/C
5	RF IN
14	RF OUT
19	Vref
20	Vdet
21	Vd
22	Gain_Ctrl
23	Vpos
24, 25	GND

### Ordering Information

Part No.	ECCN	Description
TGA2565-SM	EAR99	11-17 GHz MPA

Standard T/R size = 500 pieces on a 7" reel.

### Specifications

#### Absolute Maximum Ratings

Parameter	Rating
Drain Voltage, Vd	+6.5 V
Drain Current, Id	450 mA
Gate Voltage, Vg	-3 to 0 V
Gate Current, Ig	-30 to 30 mA
Gain_Control Voltage, Gain_Ctrl	-3.6 to 3.6 V
Attenuator Circuit Voltage, Vpos	-3.6 to 2.3 V
Detector Circuit Power Supply, Vsupply	1 V ≤ Vsupply ≤ 4.9 V + 2mA * Rext
Power Dissipation, Pdiss	2.93 W
RF Input Power, CW, 50Ω, T = 25°C	18 dBm
Channel Temperature, Tch	200 °C
Mounting Temperature (30 Seconds)	260 °C
Storage Temperature	-40 to 150 °C

Operation of this device outside the parameter ranges given above may cause permanent damage. These are stress ratings only, and functional operation of the device at these conditions is not implied.

Rext is the value of the external resistor used on the detector circuit shown as R1, R2 in the application circuit diagram shown on page 7.

#### Electrical Specifications

Test conditions unless otherwise noted: 25°C, Vd = 6 V, Idq = 210 mA, Gain\_Ctrl = 0 V, Vpos = 2 V. Vg = -0.7 V typical.

Parameter	Min	Typical	Max	Units
Operational Frequency Range	11		16.5	GHz
Gain		27		dB
Attenuation Range		14		dB
Input Return Loss		10		dB
Output Return Loss		10		dB
Output Power @ 1dB Gain Compression (max gain)		27		dBm
Output TOI		34		dBm
Gain Temperature Coefficient (@ max gain)		-0.028		dB/°C
Power Temperature Coefficient (@ max gain)		0.03		dB/°C

#### Recommended Operating Conditions

Parameter	Min	Typical	Max	Units
Vd		6		V
Idq (quiescent current)		210		mA
Id_drive (current under RF drive)		350		mA
Vg		-0.7		V
Gain_Ctrl		0		V
Vpos		2		V
Vsupply		6		V

Electrical specifications are measured at specified test conditions. Specifications are not guaranteed over all recommended operating conditions.

### Specifications

#### Thermal and Reliability Information

Parameter	Condition	Rating
Thermal Resistance, $\theta_{JC}$ , measured to back of package	Tbase = 85 °C	$\theta_{JC} = 32.2$ °C/W
Channel Temperature (Tch), and Median Lifetime (Tm)	Tbase = 85 °C, Vd = 6 V, Idq = 210 mA, Pdiss = 1.26 W	Tch = 126 °C Tm = 1.8 E+7 Hrs
Channel Temperature (Tch), and Median Lifetime (Tm) Under RF Drive	Tbase = 85 °C, Vd = 6 V, Id = 350 mA, Pout = 27 dBm, Pdiss = 1.6 W	Tch = 137 °C Tm = 4.6 E+6 Hrs

#### Notes

1. Channel operating temperature will directly affect the device median lifetime (Tm). For maximum life, it is recommended that channel temperatures be maintained at the lowest possible levels.
2. To calculate the temperature rise, calculate the dissipated power and multiply by  $\theta_{JC}$ .
3. Channel temperature must not exceed maximum ratings.

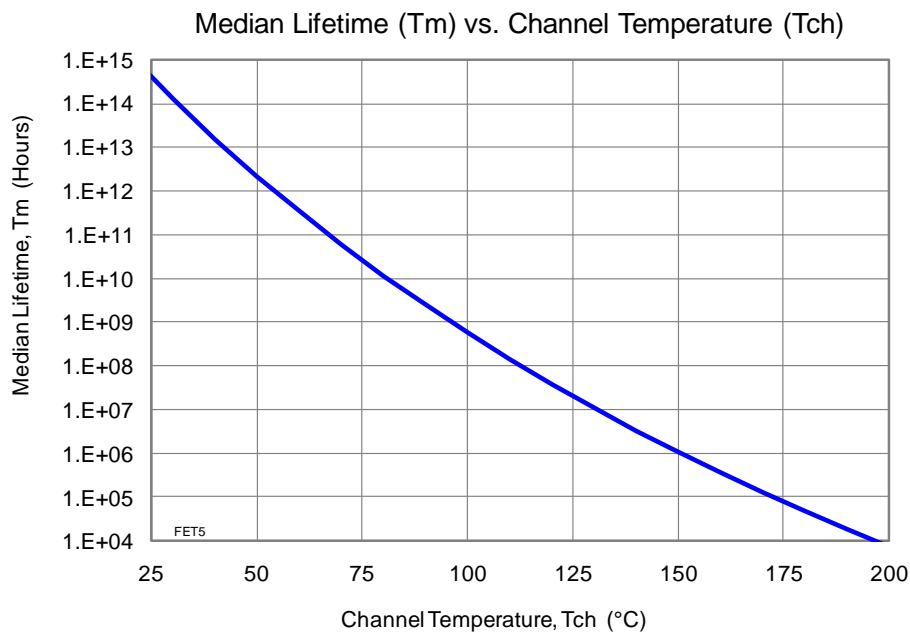

**Typical Performance**

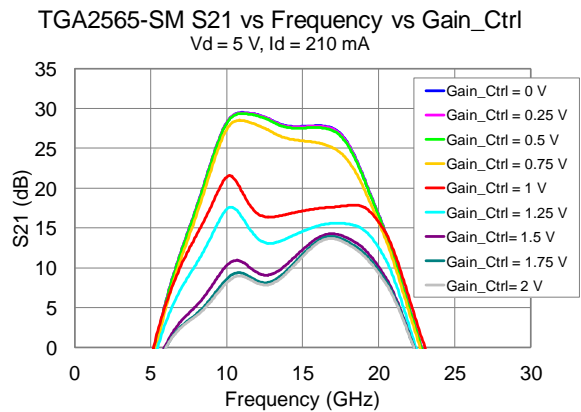
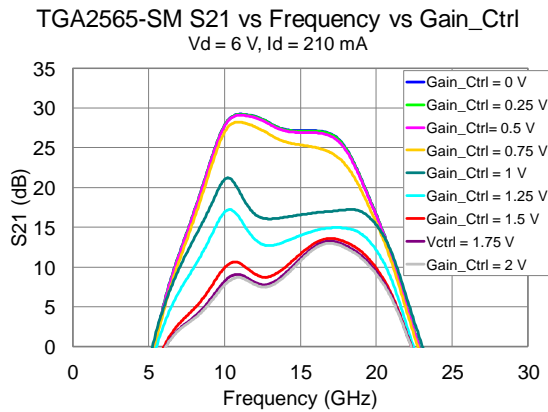
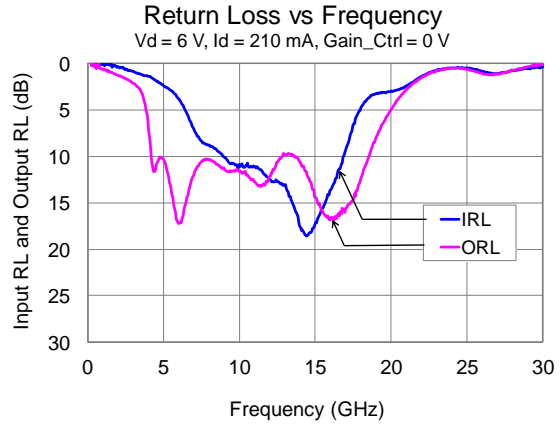
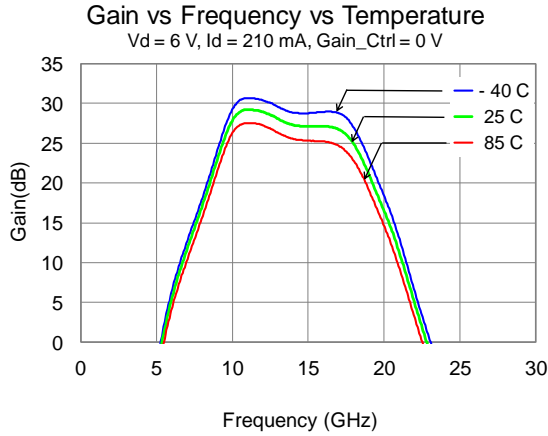

**Typical Performance**

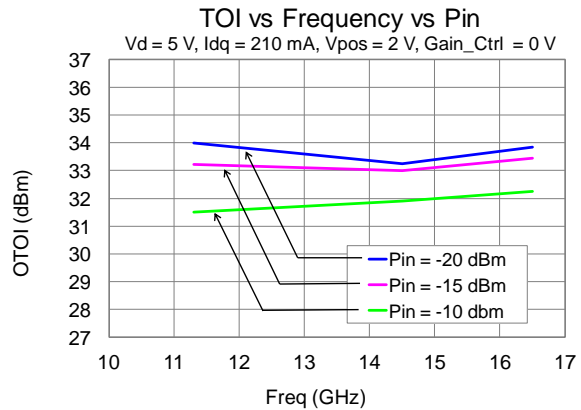
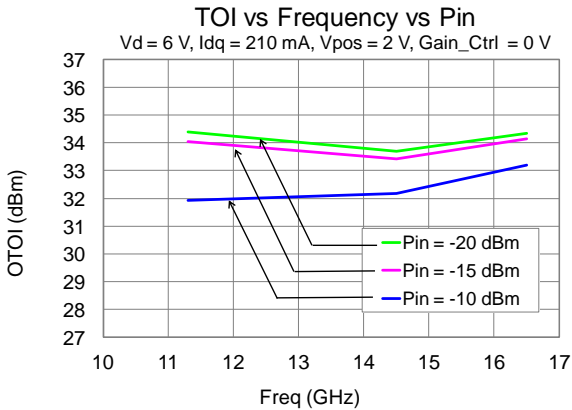
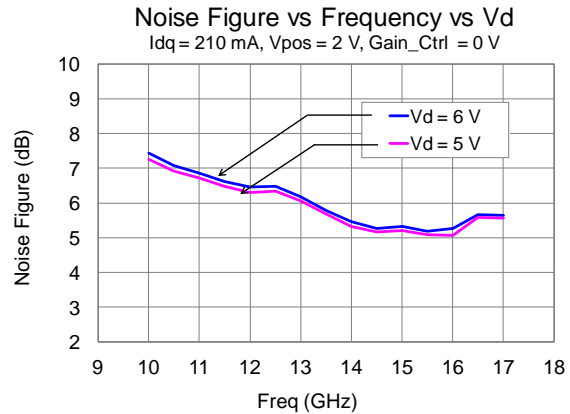
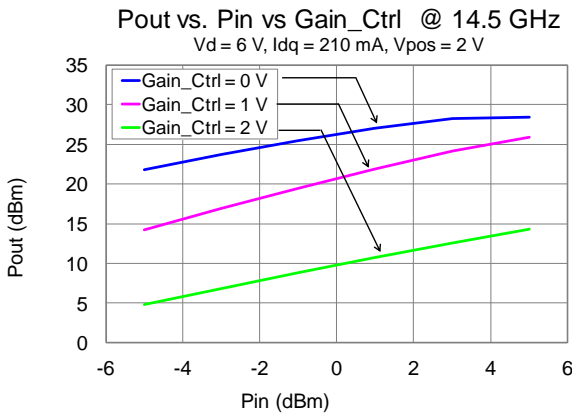
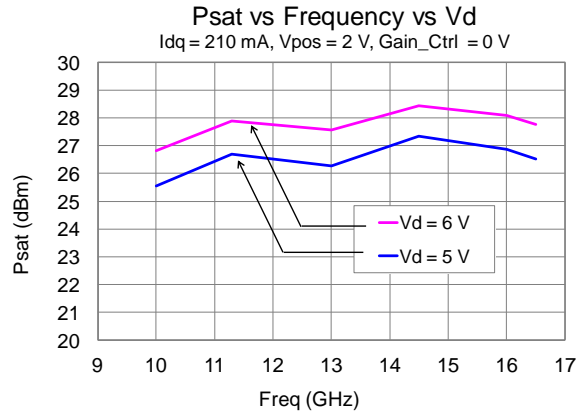
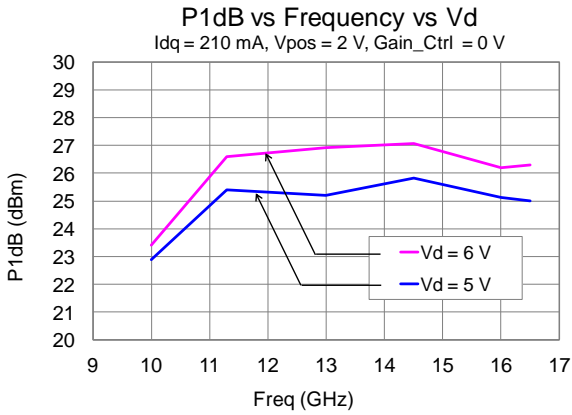

**Typical Performance**

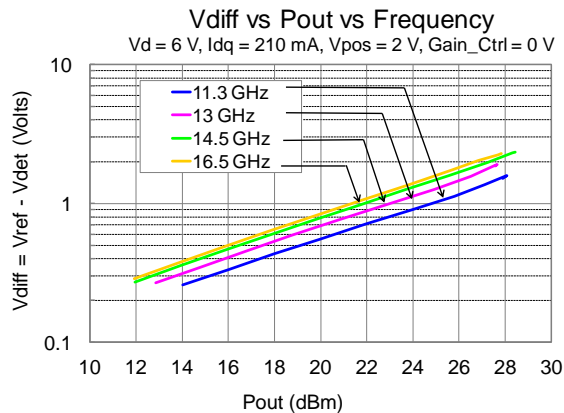
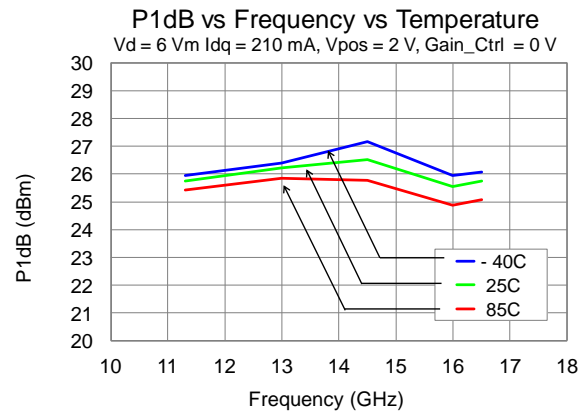
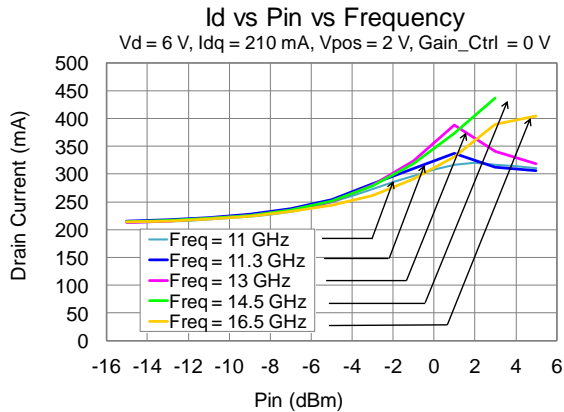
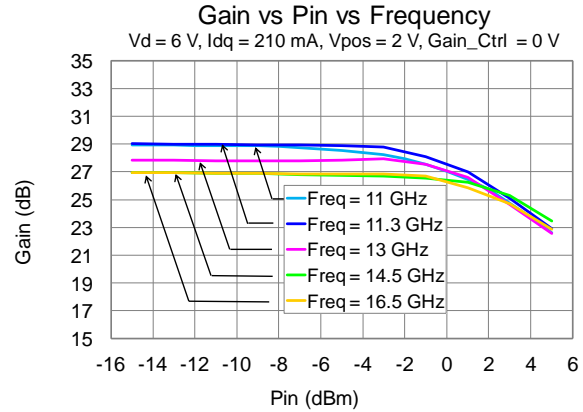
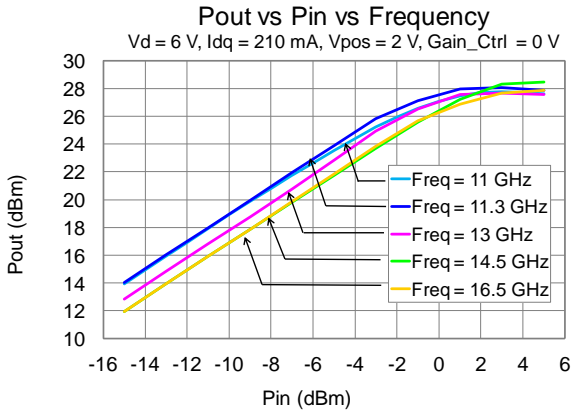

### Application Circuit

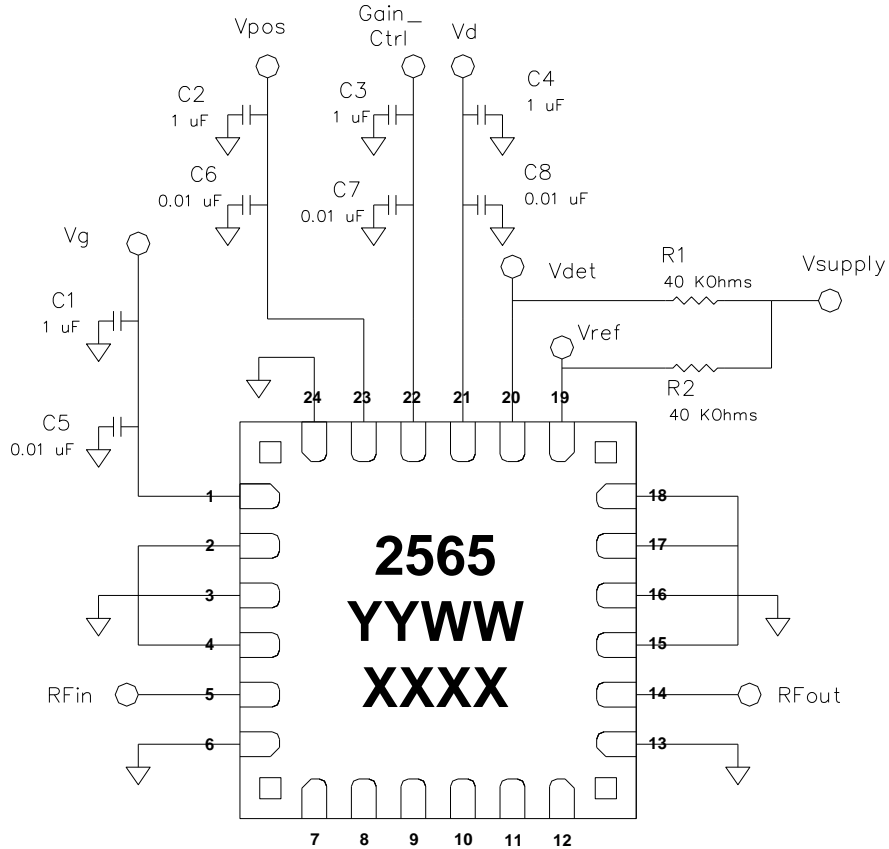

#### Bias-up Procedure

Set Vg to -1.5 V
Set Vd to 6 V
Set Vpos to 2 V
Set Gain_Ctrl to 0 V
Adjust Vg more positive until quiescent Id = 210 mA, Vg ~ -0.7 V Typical
Apply RF signal
Gain can be adjusted using Gain_Ctrl. Max gain: Gain_Ctrl=0 V. Min Gain: Gain_Ctrl = 2 V

#### Bias-down Procedure

Turn off RF supply
Reduce Vg to -1.5 V
Set Vd to 0 V
Reduce Gain_Ctrl to 0 V
Reduce Vpos to 0 V

The monitored voltage difference, Vdiff, between Vref and Vdet can be used to track output power. Vsupply can be turned on or off at any point in time.

## Pin Description

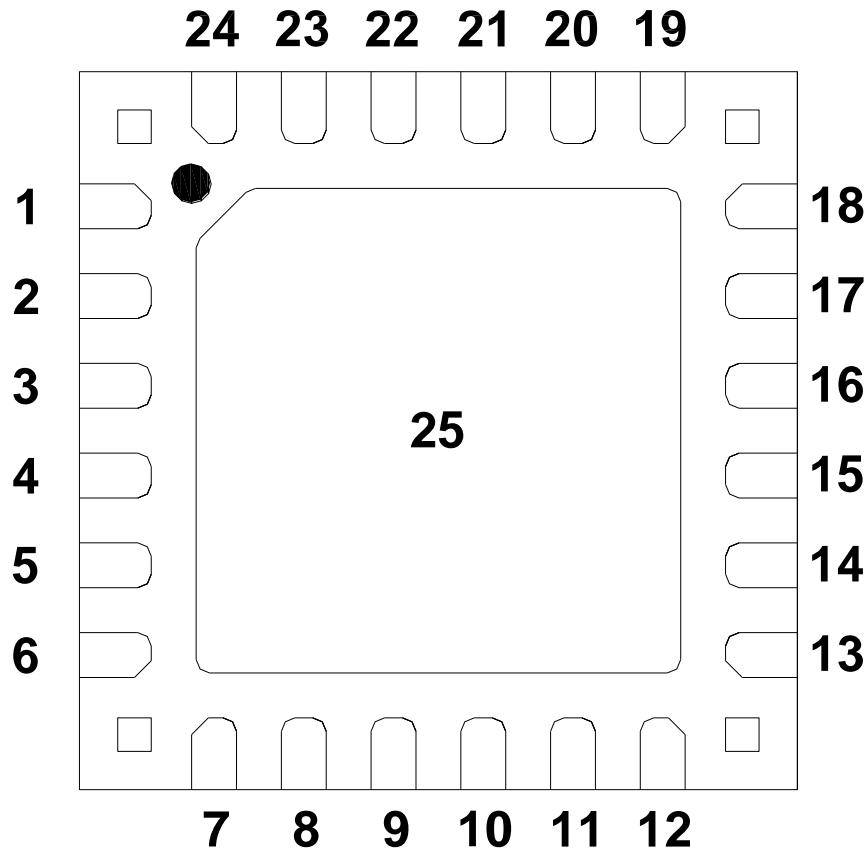

Top View

Pin	Symbol	Description
1	Vg	Gate voltage. Bias network is required; see Application Circuit on page 7 as an example.
2, 3, 4, 6, 7, 8, 9, 10, 11, 12, 13, 15, 16, 17, 18	N/C	No internal connection; must be grounded on PCB.
5	RF IN	RF Input.
14	RF OUT	RF Output.
19	Vref	Reference voltage for power detector circuitry
20	Vdet	Detector voltage for power detector circuitry. "Vdiff" = Vref – Vdet
21	Vd	Drain voltage. Bias network is required; see Application Circuit on page 7 as an example.
22	Gain_Ctrl	Gain Control voltage to control variable adjustable attenuator
23	Vpos	+2 V applied to adjustable attenuator circuit.
24, 25	GND	Pin 25 = Backside paddle; must be grounded on PCB. Multiple vias should be employed to minimize inductance and thermal resistance; see Mounting Configuration on page 11 for suggested footprint.



**Applications Information**

**PC Board Layout**

Top RF layer is 0.008" thick Rogers RO4003,  $\epsilon_r = 3.38$ . Metal layers are 1-oz copper.

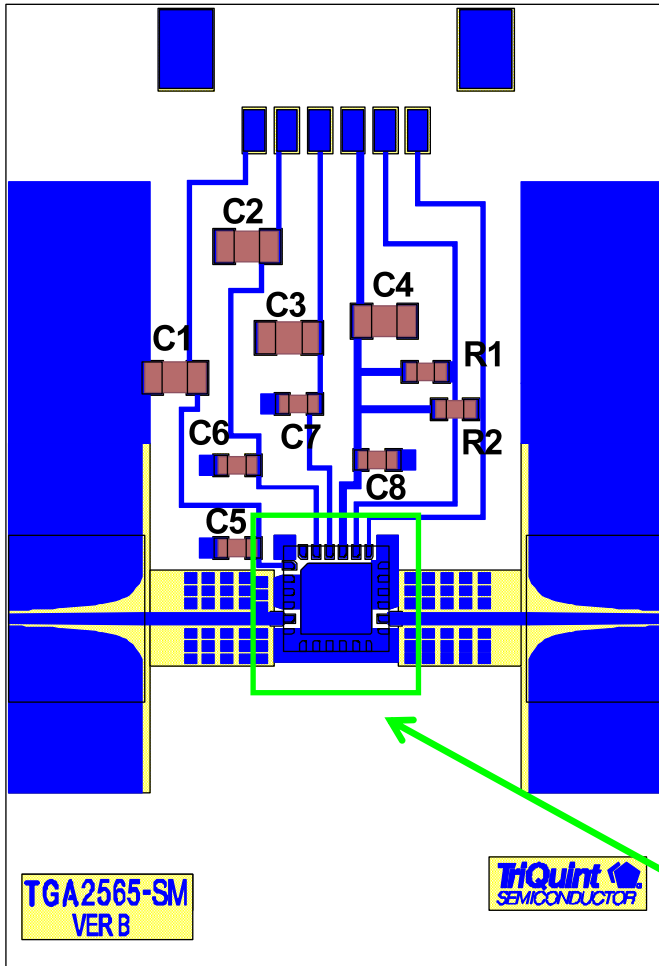

The pad pattern shown has been developed and tested for optimized assembly at TriQuint Semiconductor. The PCB land pattern has been developed to accommodate lead and package tolerances. Since surface mount processes vary from company to company, careful process development is recommended.

The TGA2565-SM has an internal power detector circuit that can be utilized to monitor and / or control the output power of the device. The device output power is proportional to the difference between the Vdet and Vref pins, as shown in the graph of Vdiff vs Pout, shown on page 6. Each device will have a slightly different detector voltage for a given output power, so the user is encouraged to perform a power training routine for each device.

The TGA2565-SM also has a built-in attenuator to control the gain of the device. The Gain\_Ctrl pin can be set at different values for different applications. The power detector circuit and the built-in attenuator can be combined in a feedback loop to control the output power of the device over time and temperature.

For more information, please refer to the [TGA2565-SM](#) product information page.

Detail is on page 11

**Bill of Material**

Ref Des	Value	Description	Manufacturer	Part Number
C1,C2,C3,C4	1 uF	Cap, 0805, 25V, X7R	various	
C5,C6,C7,C8	0.01 uF	Cap, 0603, 25V, X7R	various	
R1, R2 *	40 KOhms	Resistor, 0603, 25V, 5%	various	

**Mechanical Information**

**Package Information and Dimensions**

All dimensions are in millimeters.

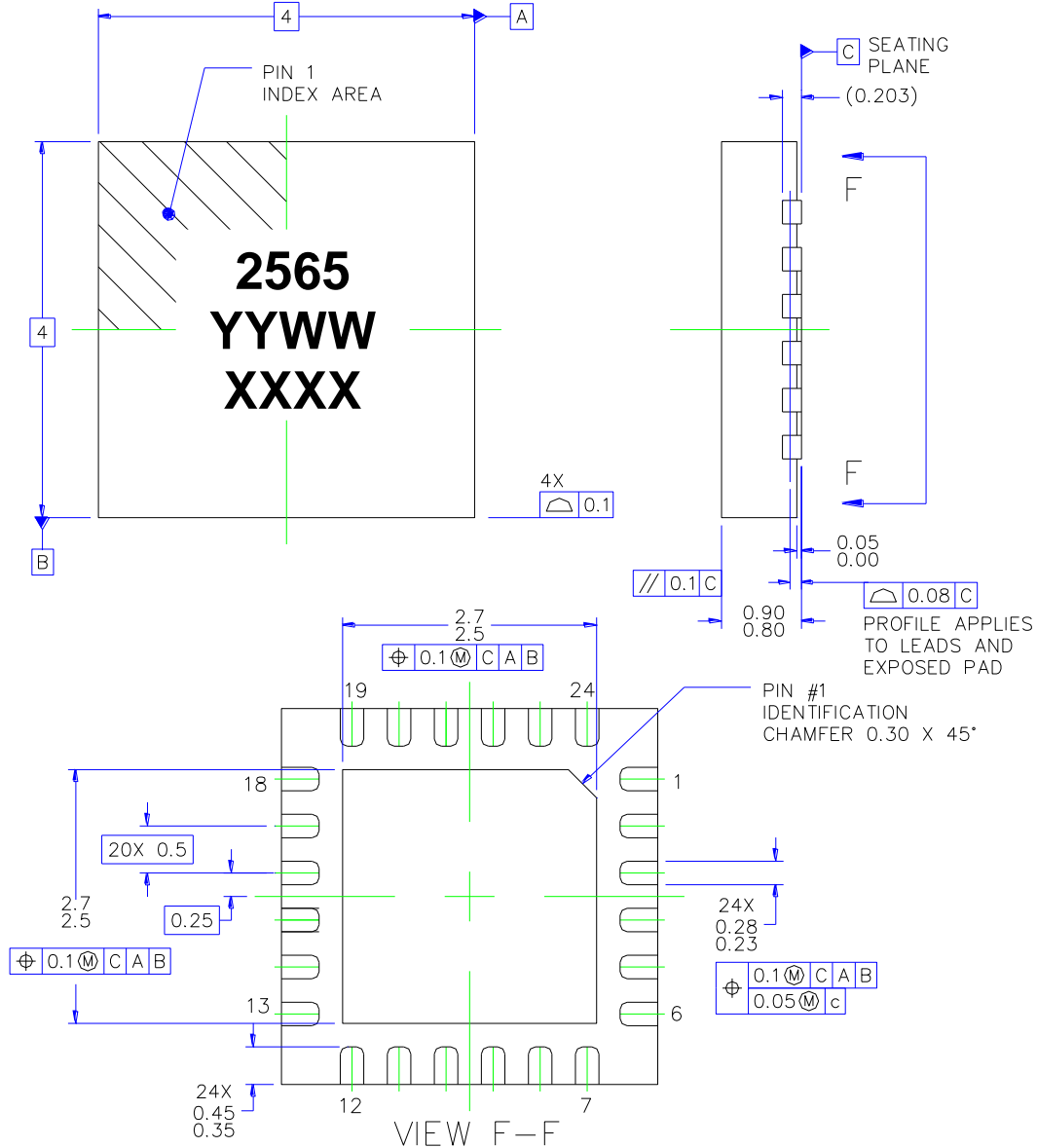

This package is lead-free/RoHS-compliant with a copper alloy base (CDA194), and the plating material on the leads is 100% matte Sn annealed. It is compatible with both lead-free (maximum 260 °C reflow temperature) and tin-lead (maximum 245 °C reflow temperature) soldering processes.

The TGA2565-SM will be marked with the “2565” designator and a lot code marked below the part designator. The “YY” represents the last two digits of the year the part was manufactured, the “WW” is the work week, and the “XXXX” is an auto-generated number.

### Mechanical Information

#### Mounting Configuration

All dimensions are in millimeters.

Notes:

1. Ground vias are critical for the proper performance of this device.
2. Filled or un-filled vias are acceptable.
3. Via diameter 252 um (10 mils)
4. Via spacing 508um (20 mils)
5. 1 oz copper specified for plating on via walls

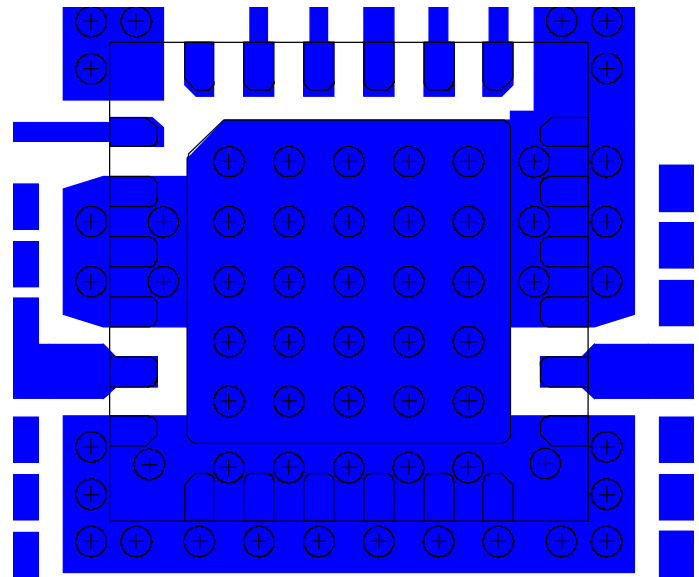

### Tape and Reel Information

Tape and reel specifications for this part are also available on the TriQuint website in the “Application Notes” section under the “SAW Filters” tab.

Standard T/R size = 500 pieces on a 7 x 0.5” reel.

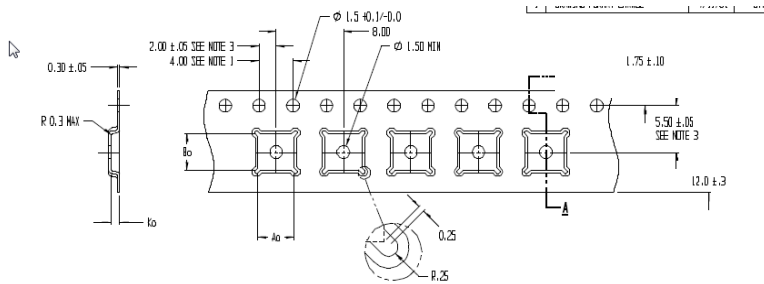

### CARRIER AND COVER TAPE DIMENSIONS

Part	Feature	Symbol	Size (in)	Size (mm)
Cavity	Length	A0	0.171	4.35
	Width	B0	0.171	4.35
	Depth	K0	0.043	1.1
	Pitch	P1	0.315	8.0
Distance Between Centerline	Cavity to Perforation Length Direction	P2	0.079	2.0
	Cavity to Perforation Width Direction	F	0.217	5.5
Cover Tape	Width	C	0.374	9.5
Carrier Tape	Width	W	0.472	12.0

**Product Compliance Information**

**ESD Information**



**Caution! ESD-Sensitive Device**

ESD Rating: Class 0  
 Value: 150 V  
 Test: Human Body Model (HBM)  
 Standard: JEDEC Standard JESD22-A114

**MSL Rating**

Level MSL3 at +260 °C convection reflow  
 The part is rated Moisture Sensitivity Level TBD at 260°C per JEDEC standard IPC/JEDEC J-STD-020.

**ECCN**

US Department of Commerce EAR99

**Solderability**

Compatible with the latest version of J-STD-020, Lead free solder, 260°C

This part is compliant with EU 2002/95/EC RoHS directive (Restrictions on the Use of Certain Hazardous Substances in Electrical and Electronic Equipment).

This product also has the following attributes:

- Lead Free
- Halogen Free (Chlorine, Bromine)
- Antimony Free
- TBBP-A (C<sub>15</sub>H<sub>12</sub>Br<sub>4</sub>O<sub>2</sub>) Free
- PFOS Free
- SVHC Free

**Recommended Soldering Temperature Profile**

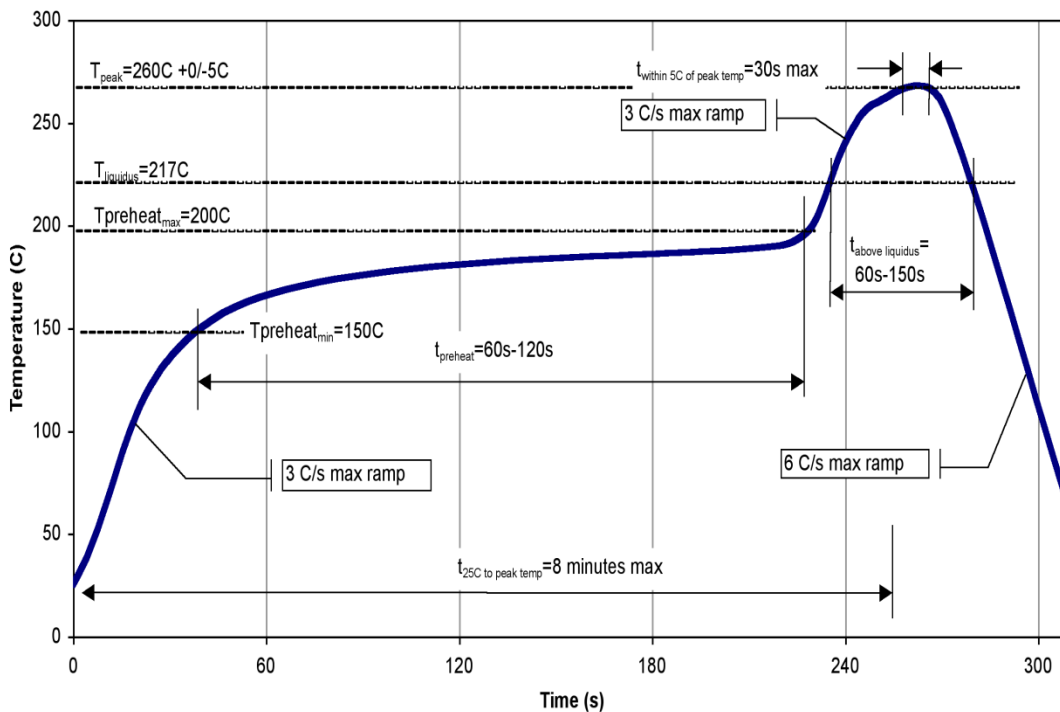

## Contact Information

For the latest specifications, additional product information, worldwide sales and distribution locations, and information about TriQuint:

**Web:** [www.triquint.com](http://www.triquint.com)  
**Email:** [info-sales@tqs.com](mailto:info-sales@tqs.com)

**Tel:** +1.972.994.8465  
**Fax:** +1.972.994.8504

For technical questions and application information:

**Email:** [info-networks@tqs.com](mailto:info-networks@tqs.com)

## Important Notice

The information contained herein is believed to be reliable. TriQuint makes no warranties regarding the information contained herein. TriQuint assumes no responsibility or liability whatsoever for any of the information contained herein. TriQuint assumes no responsibility or liability whatsoever for the use of the information contained herein. The information contained herein is provided "AS IS, WHERE IS" and with all faults, and the entire risk associated with such information is entirely with the user. All information contained herein is subject to change without notice. Customers should obtain and verify the latest relevant information before placing orders for TriQuint products. The information contained herein or any use of such information does not grant, explicitly or implicitly, to any party any patent rights, licenses, or any other intellectual property rights, whether with regard to such information itself or anything described by such information.

TriQuint products are not warranted or authorized for use as critical components in medical, life-saving, or life-sustaining applications, or other applications where a failure would reasonably be expected to cause severe personal injury or death.

## Данный компонент на территории Российской Федерации

### Вы можете приобрести в компании MosChip.

Для оперативного оформления запроса Вам необходимо перейти по данной ссылке:

<http://moschip.ru/get-element>

Вы можете разместить у нас заказ для любого Вашего проекта, будь то серийное производство или разработка единичного прибора.

В нашем ассортименте представлены ведущие мировые производители активных и пассивных электронных компонентов.

Нашей специализацией является поставка электронной компонентной базы двойного назначения, продукции таких производителей как XILINX, Intel (ex.ALTERA), Vicor, Microchip, Texas Instruments, Analog Devices, Mini-Circuits, Amphenol, Glenair.

Сотрудничество с глобальными дистрибьюторами электронных компонентов, предоставляет возможность заказывать и получать с международных складов практически любой перечень компонентов в оптимальные для Вас сроки.

На всех этапах разработки и производства наши партнеры могут получить квалифицированную поддержку опытных инженеров.

Система менеджмента качества компании отвечает требованиям в соответствии с ГОСТ Р ИСО 9001, ГОСТ РВ 0015-002 и ЭС РД 009

### Офис по работе с юридическими лицами:

105318, г.Москва, ул.Щербаковская д.3, офис 1107, 1118, ДЦ «Щербаковский»

Телефон: +7 495 668-12-70 (многоканальный)

Факс: +7 495 668-12-70 (доб.304)

E-mail: [info@moschip.ru](mailto:info@moschip.ru)

Skype отдела продаж:

moschip.ru

moschip.ru\_4

moschip.ru\_6

moschip.ru\_9