

# Bridgetek Pte Ltd

## VM816C Datasheet

### Embedded Video Engine Credit Card Board

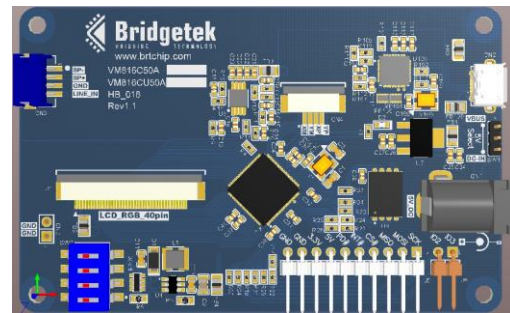

## 1 Introduction

The VM816C are development modules for Bridgetek's BT816, which are used to develop and demonstrate the functionality of the BT816 Embedded Video Engine, EVE. There are 2 variations of the modules. The SPI variation of the module behaves as a SPI slave, and requires a SPI Master for proper micro-controller interfacing and system integration. The USB variation of the module behaves as a USB slave, and requires control from a USB host.

Customers can order a module PCBA together with a 5.0" LCD panel pre-assembled and tested at factory, or order a module PCBA only. For the module PCBA, users can also connect to different LCD screens as long as they meet the BT816 technical specification and fit the LCD connector.

- VM816C50A-D, SPI version with 5.0" LCD
- VM816CU50A-D, USB version with 5.0" LCD
- VM816C50A-N, SPI version with 4.3/5.0/7.0" LCD connector but no display
- VM816CU50A-N, USB version with 4.3/5.0/7.0" LCD connector but no display

## 1.1 Features

The VM816C utilises the Bridgetek BT816 Embedded Video Engine. Graphic, audio and touch features of the BT816 can be accessed with the VM816C. For a full list of the BT816's features, refer to the [BT81X Datasheet](#).

The VM816C has the following features:

- Ready to use LCD module
- Options with or without 5" LCDs supporting resistive touch with pressure sensing
- On board LCD backlight LED Driver
- Supports mono audio output
- Supports single or quad SPI (for VM816C50A modules)
- On board audio power amplifier and audio connector for external speaker support
- Flexible power supply. Powered by SPI host connector, or via USB Micro-B port, or via a 2.1mm DC power jack
- On board 16M Byte IC Flash Memory
- Support USB high speed connection to PC or other USB host (for VM816CU50A modules)

Neither the whole nor any part of the information contained in, or the product described in this manual, may be adapted or reproduced in any material or electronic form without the prior written consent of the copyright holder. This product and its documentation are supplied on an as-is basis and no warranty as to their suitability for any particular purpose is either made or implied. Bridgetek Pte Ltd will not accept any claim for damages howsoever arising as a result of use or failure of this product. Your statutory rights are not affected. This product or any variant of it is not intended for use in any medical appliance, device or system in which the failure of the product might reasonably be expected to result in personal injury. This document provides preliminary information that may be subject to change without notice. No freedom to use patents or other intellectual property rights is implied by the publication of this document. Bridgetek Pte Ltd, 178 Paya Lebar Road, #07-03, Singapore 409030. Singapore Registered Company Number: 201542387H

## 2 Ordering Information

**Note:** The modules (Table 2-1) below require a 5V/1A power supply. It is NOT provided in the development kit, but is offered as an optional accessory (Table 2-2), with the following part types:

Part No.	Description
VM816C50A-N	Credit Card Size VM816C module, with 3.3V SPI/QSPI interface, with FPC/FFC 40 LCD connector. No display is provided.
VM816C50A-D	Credit Card Size VM816C module, with 3.3V SPI/QSPI interface, with FPC/FFC 40 LCD connector. Includes 5 inch 800x480 TFT LCD display with resistive touch panel.
VM816CU50A-N	Credit Card Size VM816C module, with USB2.0 to PC or other USB host, with FPC/FFC 40 LCD connector. No display is provided.
VM816CU50A-D	Credit Card Size VM816C module, with USB2.0 to PC or other USB host, with FPC/FFC 40 LCD connector. Includes 5 inch 800x480 TFT LCD display with resistive touch panel.

**Table 2-1 – Ordering information**

Part No.	Description
VA-PSU-UK1	Accessory - UK Model 5V/1A USB Power Supply (Mfr # JX-B0520C-1-B)
VA-PSU-US1	Accessory - US Model 5V/1A USB Power Supply (Mfr # JX-B0520B-1-B)
VA-PSU-EU1	Accessory - EU Model 5V/1A USB Power Supply (Mfr # JX-B0520A-1-B)
VA800A-SPI	Accessory - High Speed Micro USB to SPI adapter for BASIC boards based on FT232H MPSSE design
CleO-SPK1	Accessory - CleO speaker enclosure with connecting wires

**Table 2-2 – Accessories**

---

## **Table of Contents**

<b>1</b>	<b>Introduction .....</b>	<b>1</b>
1.1	<b>Features .....</b>	<b>1</b>
<b>2</b>	<b>Ordering Information .....</b>	<b>2</b>
<b>3</b>	<b>Hardware Description .....</b>	<b>4</b>
3.1	<b>VM816C board .....</b>	<b>4</b>
3.2	<b>Physical Descriptions .....</b>	<b>5</b>
3.2.1	PCB layout.....	5
3.2.2	VM816C Connectors.....	6
<b>4</b>	<b>Board Schematics.....</b>	<b>9</b>
<b>5</b>	<b>Hardware Setup Guide .....</b>	<b>12</b>
5.1	<b>Power Configuration .....</b>	<b>12</b>
5.2	<b>Backlight LED current Configuration .....</b>	<b>12</b>
5.3	<b>VM816C50A Hardware Setup .....</b>	<b>12</b>
5.4	<b>VM816CU50A Hardware Setup .....</b>	<b>14</b>
<b>6</b>	<b>Mechanical Dimensions .....</b>	<b>15</b>
<b>7</b>	<b>Specifications.....</b>	<b>16</b>
7.1	<b>Optical Specification .....</b>	<b>16</b>
<b>8</b>	<b>Contact Information.....</b>	<b>17</b>
	<b>Appendix A – References .....</b>	<b>19</b>
	<b>Document References .....</b>	<b>19</b>
	<b>Acronyms and Abbreviations .....</b>	<b>19</b>
	<b>Appendix B - List of Figures and Tables .....</b>	<b>20</b>
	<b>List of Figures .....</b>	<b>20</b>
	<b>List of Tables.....</b>	<b>20</b>
	<b>Appendix C – Revision History .....</b>	<b>21</b>

### 3 Hardware Description

Please refer to section [3.2.2](#) for connector settings. Some VM816C jumpers must be set to work properly with your system.

#### 3.1 VM816C board

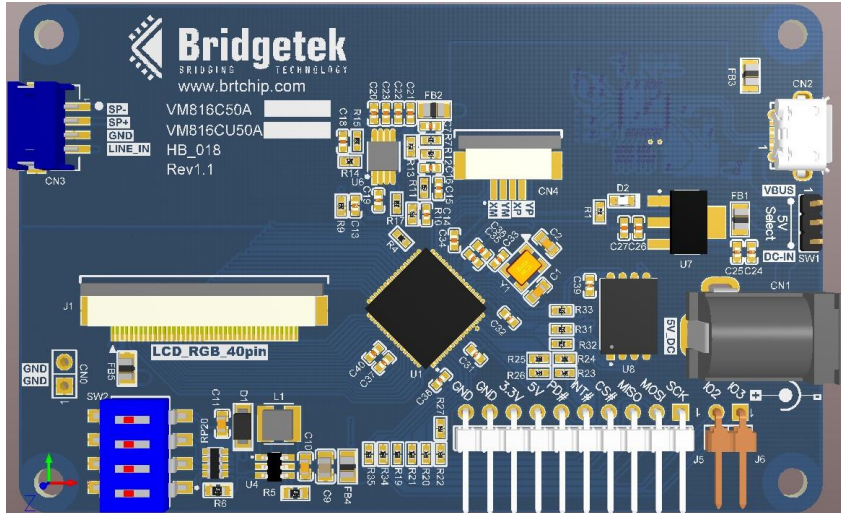

**Figure 3-1 – VM816CU50A board top view**

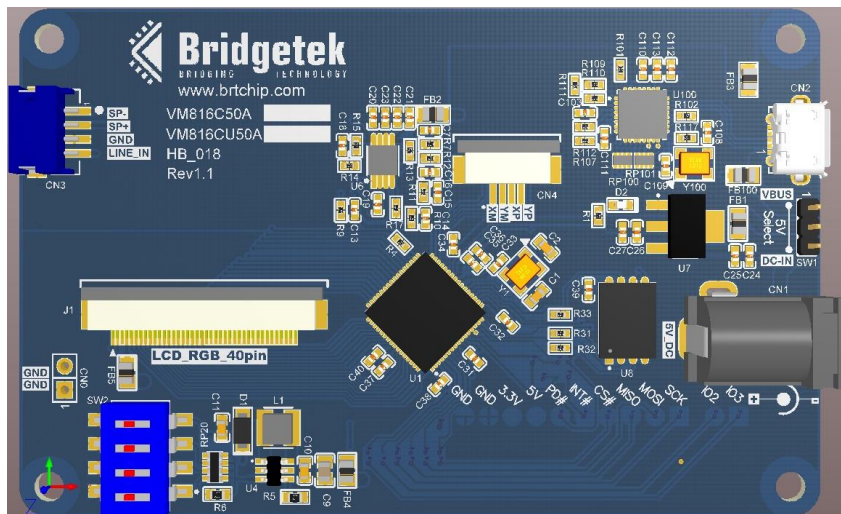

**Figure 3-2 – VM816CU50A board top view**

The main functions of the VM816C are as follows:

- Micro USB, SPI connector or 2.1mm DC power jack for power supply
- 3.3V regulator : Takes 5V input and outputs 3.3V for on-board circuits
- WVGA(800x480) TFT LCD touch screen panel (for VM816C50A-D/VM816CU50A-D module)
- LCD backlight driver. On board back light driver has over voltage protection (OVP) of 35V, and maximum drive current 100mA.
- 3 stage audio filter and power amplifier
- Audio connector for external speaker support
- On board 16M Byte IC Flash memory



- FT4222 USB bridge which supports connection to PC and other USB host (for VM816CU50A-N/VM816CU50A-D module)

## 3.2 Physical Descriptions

### 3.2.1 PCB layout

The VM816C is an 85.6mm x 54.1mm, four-layer printed circuit board. Board thickness is approximately 1.6mm.

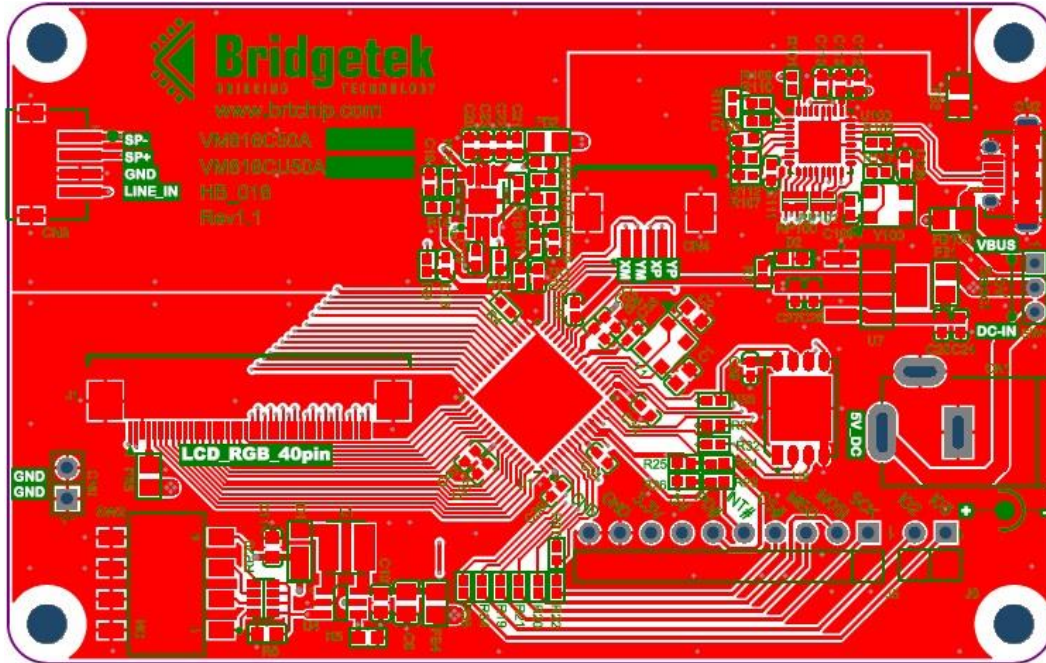

Figure 3-3 – VM816C board top layer

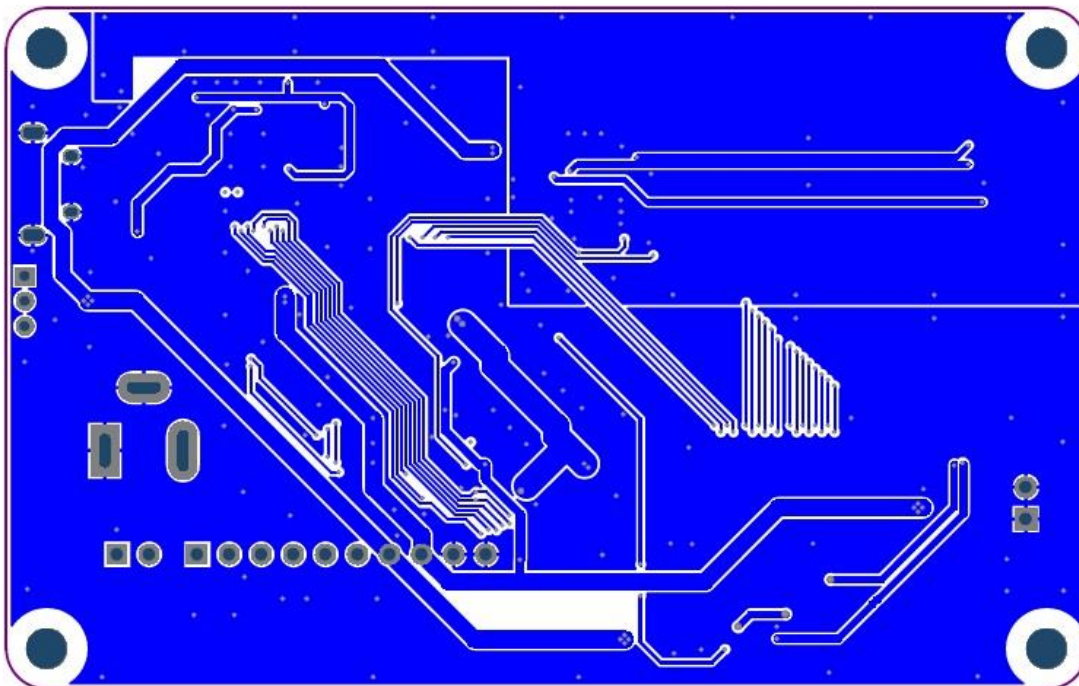

Figure 3-4 – VM816C board bottom layer

### 3.2.2 VM816C Connectors

Connectors and jumpers are described in the following sections.

- **CN1 - 2.1mm DC power jack**

2.1mm DC power jack for 5V power input to the board. Alternative to Micro USB connector.

Pin No.	Name	Type	Description
1	GND	P	Ground
2	GND	P	Ground
3	DC_IN	P	DC power supply (5V)

**Table 3-1 – CN1 Pinout**

- **CN2 - Micro USB receptical**

This receptical is strictly for 5V input to power the board. There is no USB Functionality.

Pin No.	Name	Type	Description
1	VBUS	P	USB power supply (5V)
2	USB_D_N	I/O	USB D- data line
3	UDB_D_P	I/O	USB D+ data line
4	NC	NA	No connection
5	GND	P	Ground

**Table 3-2 – CN2 Pinout**

- **CN3 – Audio connector**

VM816C supports mono audio output through CN3. A readymade speaker module (*CleO-SPK1*) is available from Bridgetek. Visit Bridgetek’s [on-line shop](#) for more information.

Pin No.	Name	Description
1	SP-	Audio speaker out negative
2	SP+	Audio speaker out positive
3	Audio GND	Audio Ground
4	LINE_IN	External audio line in

**Table 3-3 – CN3 Pinout**

- **CN4 – External RTP Flex cable connector**

External RTP connector is provided in order to support LCD with external resistive touch function.

Pin No.	Name	Description
1	XM	Resistive touch panel X left
2	YM	Resistive touch panel Y down
3	XP	Resistive touch panel X right
4	YP	Resistive touch panel Y up

**Table 3-4 – CN4 Pinout**

- **J1 - LCD Flex Cable connector**

This connector is the interface between the BT816 IC and the LCD Module.

Signal	Pin No	Description
LED K	1	LED-
LED A	2	LED+
DISP	31	LCD Display Enable
HSYNC	32	LCD Horizontal Sync
VSYNC	33	LCD Vertical Sync
DCLK	30	LCD Pixel Clock
DE	34	LCD Data Enable
R0	5	Bit 0 of Red RGB signals
R1	6	Bit 1 of Red RGB signals
R2	7	Bit 2 of Red RGB signals
R3	8	Bit 3 of Red RGB signals
R4	9	Bit 4 of Red RGB signals
R5	10	Bit 5 of Red RGB signals
R6	11	Bit 6 of Red RGB signals
R7	12	Bit 7 of Red RGB signals
G0	13	Bit 0 of Green RGB signals
G1	14	Bit 1 of Green RGB signals
G2	15	Bit 2 of Green RGB signals
G3	16	Bit 3 of Green RGB signals
G4	17	Bit 4 of Green RGB signals
G5	18	Bit 5 of Green RGB signals
G6	19	Bit 6 of Green RGB signals
G7	20	Bit 7 of Green RGB signals
B0	21	Bit 0 of Blue RGB signals
B1	22	Bit 1 of Blue RGB signals
B2	23	Bit 2 of Blue RGB signals
B3	24	Bit 3 of Blue RGB signals
B4	25	Bit 4 of Blue RGB signals
B5	26	Bit 5 of Blue RGB signals
B6	27	Bit 6 of Blue RGB signals
B7	28	Bit 7 of Blue RGB signals
XP	37	Resistive touch panel X right
YM	38	Resistive touch panel Y down
XM	39	Resistive touch panel X left
YP	40	Resistive touch panel Y up
3V3	4	3V3 Power

Signal	Pin No	Description
GND	3,29,36	Ground
NC	35	No connect

**Table 3-5 – J1 Pinout**

• **J5 - SPI Interface**

This is the interface where the SPI control and data signals are routed. There are also power and ground pins on this interface. J5 can be supported by the [VA800A-SPI](#) module. Please note this interface is not available in USB version VM816CU50A.

Pin No.	Name	Type	Description
1	SCK	I	SPI Clock input
2	MOSI	I/O	SPI Single mode: SPI MOSI input SPI Dual/Quad mode: SPI data line 0
3	MISO	I/O	SPI Single mode: SPI MISO output SPI Dual/Quad mode: SPI data line 1
4	CS#	I	SPI slave select input , active low
5	INT#	OD	Host interrupt open drain output, active low. On board 10kΩ pull-up to 3.3V.
6	PD#	I	Active low power down input.
7	5V	P	5V power supply
8	3V3	P	3.3V power supply
9	GND	P	Ground
10	GND	P	Ground

**Table 3-6 – J5 Pinout**

• **J6- SPI Interface (continue)**

J6 provides additional 2 signal lines for general purpose or Quad-SPI function. Please note this interface is not available in USB version VM816CU50A.

Pin No	Name	Type	Description
1	IO3	I/O	SPI Single mode: General purpose IO 1 SPI Quad mode: SPI data line 3
2	IO2	I/O	SPI Single mode: General purpose IO 0 SPI Quad mode: SPI data line 2

**Table 3-7 – J6 Pinout**

• **SW1 – Power source select**

SW1 is jumper option for users to select 5V power supply from either CN1 2.1mm DC power jack or CN2 Micro USB receptical.

Pin Option	Description
1-2	Power from CN1 2.1mm DC power jack, DC_IN
2-3	Power from CN2 Micro USB receptical, VBUS

**Table 3-8 – SW1 Pin options**







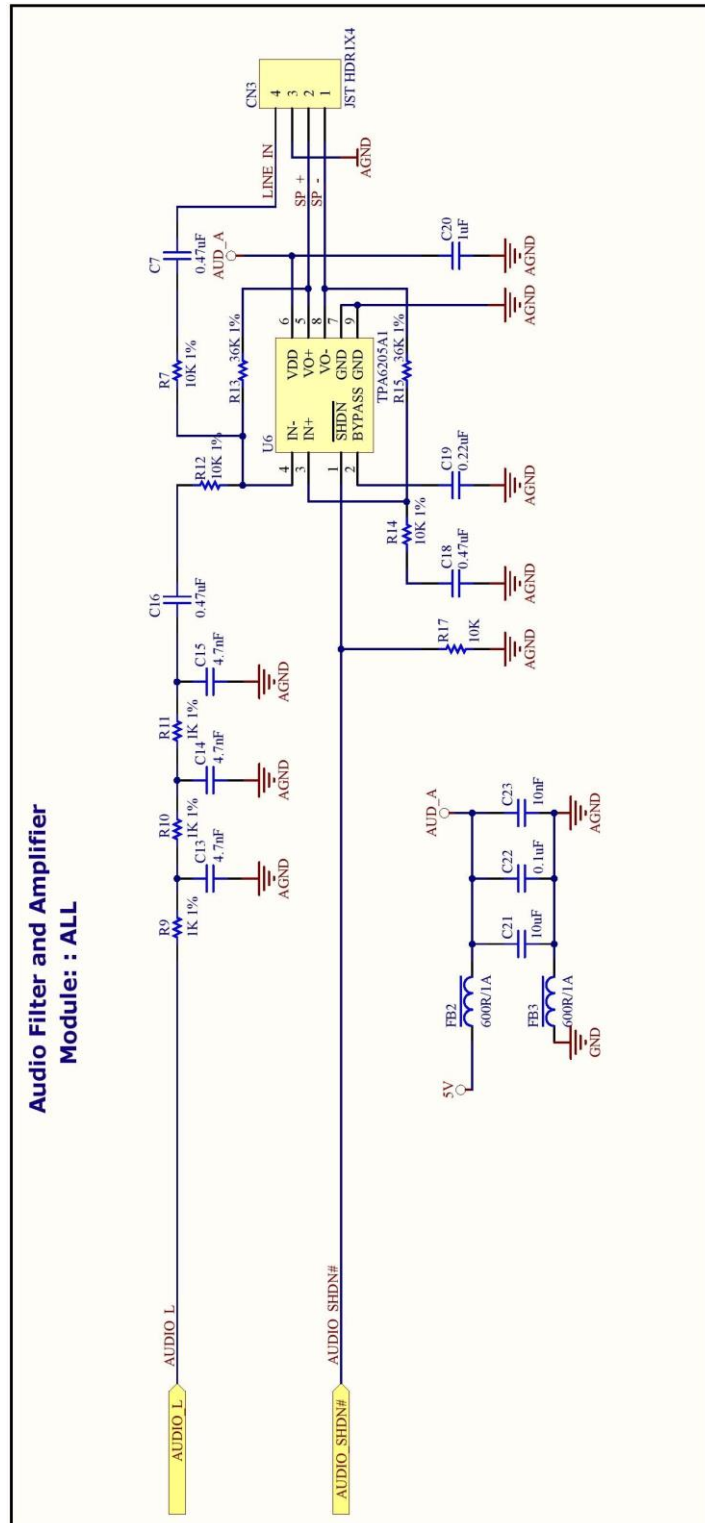

**Figure 4-3 – Audio Circuit**

## 5 Hardware Setup Guide

### 5.1 Power Configuration

There are 3 methods of powering the VM816C board.

- 1) USB Power(5V) - Connect USB power through micro-USB cable to CN2
- 2) DC IN(5V) - Connect 5V to CN1
- 3) J5 Power(5V) - Connect 5V to J5 pin 7

The following table summarises how to power the VM816C board using the various methods.

Power Method	CN2	CN1	J5 Pin 7	SW1
USB Power	5V	N/C	N/C	Short pin 1-2
DC IN(5V)	N/C	5V	N/C	Short pin 2-3
J5 Power(5V)	N/C	N/C	5V	Open

**Table 5-1 – Board power configuration**

### 5.2 Backlight LED current Configuration

The VM816C module has a backlight LED driver circuit on-board. The driver takes 5V as an input power source, and the regulator produces the output voltage so that the desired total output current can be drawn by the backlight LED. Users can select backlight current up to a maximum of 100mA by controlling switch SW2. By default, with all the 4 switches in SW2 turning OFF, resistor R6 (15 Ohm) is setting the minimum backlight current at 20mA. Switches in SW2 are connecting to array resistor RP20 (4 x 15 Ohm), turning ON each switch could provide additional backlight current of 20mA per switch.

### 5.3 VM816C50A Hardware Setup

To give a quick start with the VM816C50A development board, a Windows based Sample Application and additional demo applications are provided for users to experiment with and experience the BT816 in the VM816C system. The following paragraphs provide a short description for development procedures.

MPSSE is a “multi-purpose synchronous serial engine” interface available in some FTDI devices (e.g. FT2232D, FT232H, FT2232H and FT4232H). This engine allows users to bridge from a USB port on a PC to an SPI interface. Sample code is available for driving the BT816 over this interface with a FT232H device that has been integrated into a cable. This device is available in the VA800A-SPI board, or C232HM-EDHSL-0(5V) cable or C232HM-DDHSL-0(3.3V) cable.

VA800A-SPI is a MPSSE module accessory which can connect to the VM816C50A modules directly. Detailed information of VA800A-SPI can be found at: [VA800A-SPI USB 2.0 Hi-Speed to MPSSE SPI Module Datasheet](#).

More information about MPSSE cables may be found at: [C232HM USB 2.0 Hi-Speed to MPSSE Cable Datasheet](#).

In this section it is assumed the 5V version of the MPSSE cable (FTDI part no C232HM-EDHSL-0) is used. If the 3.3V version of the MPSSE cable (FTDI part no C232HM-DDHSL-0) is available, the setup is similar except for the power pin connection which requires an additional 5V power source to connect to CN2 or CN1. Refer to table 5-1 for board power configuration.

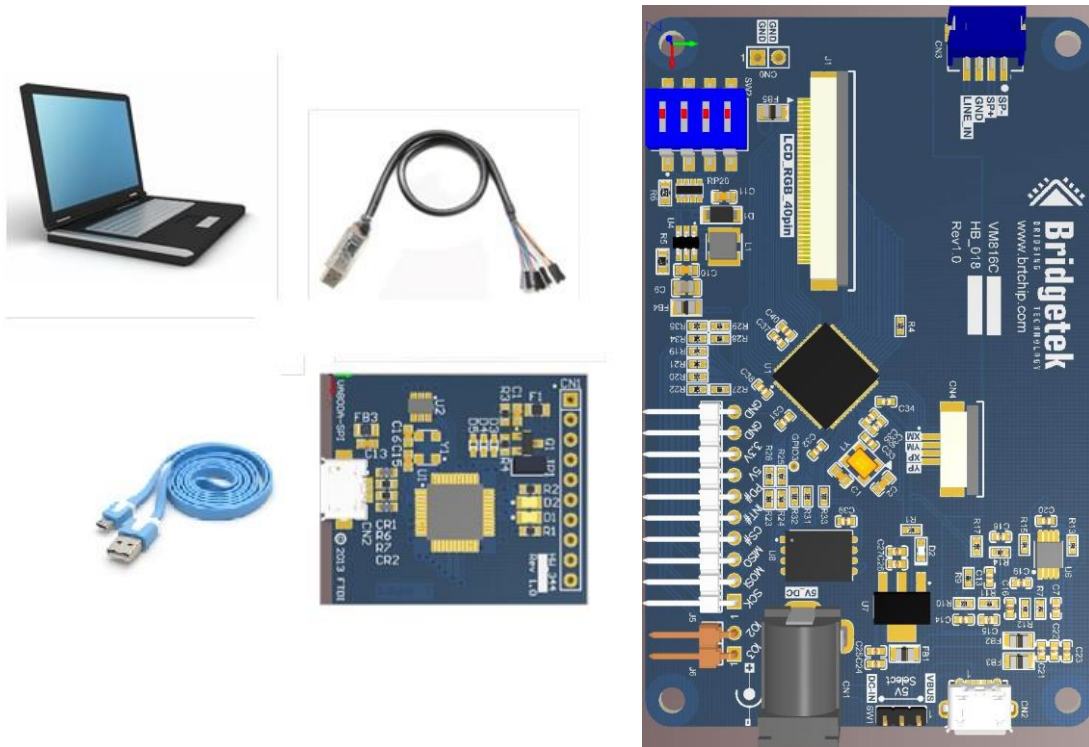

**Figure 5-1 – VM816C connects to PC via VA800A-SPI or MPSSE cable**

**Hardware Setup VA800A-SPI**

- Connect the VA800A-SPI to the VM816C50A module in the correct orientation (pin1 to pin1 aligned).
- Connect the USB cable from the VA800A-SPI to the PC USB host port.
- VA800A-SPI will supply power to VM816C50A after the MPSSE driver is properly loaded and the USB host has completed USB device configuration.

**Hardware Setup MPSSE Cable**

- Connect MPSSE leads to VM816C50A board’s J5 (SPI interface) in accordance with Table 5-2
- Plug the MPSSE cable to the PC USB host port

**Software Setup**

- Download PC based MPSSE software libraries. The MPSSE cable and driver information can be found at <http://www.ftdichip.com/Products/Cables/USBMPSSE.htm>.
- Launch the Sample Application based on MPSSE from the PC

The [BT81X Programming Guide](#) describes the programming code and formats used by the BT81X. The Sample Application is a well-formatted and documented program that illustrates the Programming Guide, and provides numerous design examples and reference code demonstrations.

J5 Pin number	J5 Signal	MPSSE pin number	MPSSE Signal	MPSSE Lead Color
1	SCK	2	SK	ORANGE
2	MOSI	3	DO	YELLOW
3	MISO	4	DI	GREEN
4	CS#	5	CS	BROWN
5	INT#	7	GPIOL1	PURPLE

J5 Pin number	J5 Signal	MPSSE pin number	MPSSE Signal	MPSSE Lead Color
6	PD#	9	GPIOL3	BLUE
7	5V	1	VCC	RED
8	3V3	-	-	-
9	GND	10	GND	Black
10	GND	-	-	-

**Table 5-2 – MPSSE cable (C232HM-EDHSL-0) connection**

## 5.4 VM816CU50A Hardware Setup

Hardware setup for USB version module VM816CU50A is simple since there is on-board FT4222 USB bridge circuit.

### **Hardware Setup USB Cable**

- Connect the USB cable from the VM816CU50A USB port to the PC USB host port.

### **Software Setup**

- The [BT81X Programming Guide](#) describes the programming code and formats used by the BT81X. The Sample Application is a well-formatted and documented program that illustrates the Programming Guide, and provides numerous design examples and reference code demonstrations.



## 6 Mechanical Dimensions

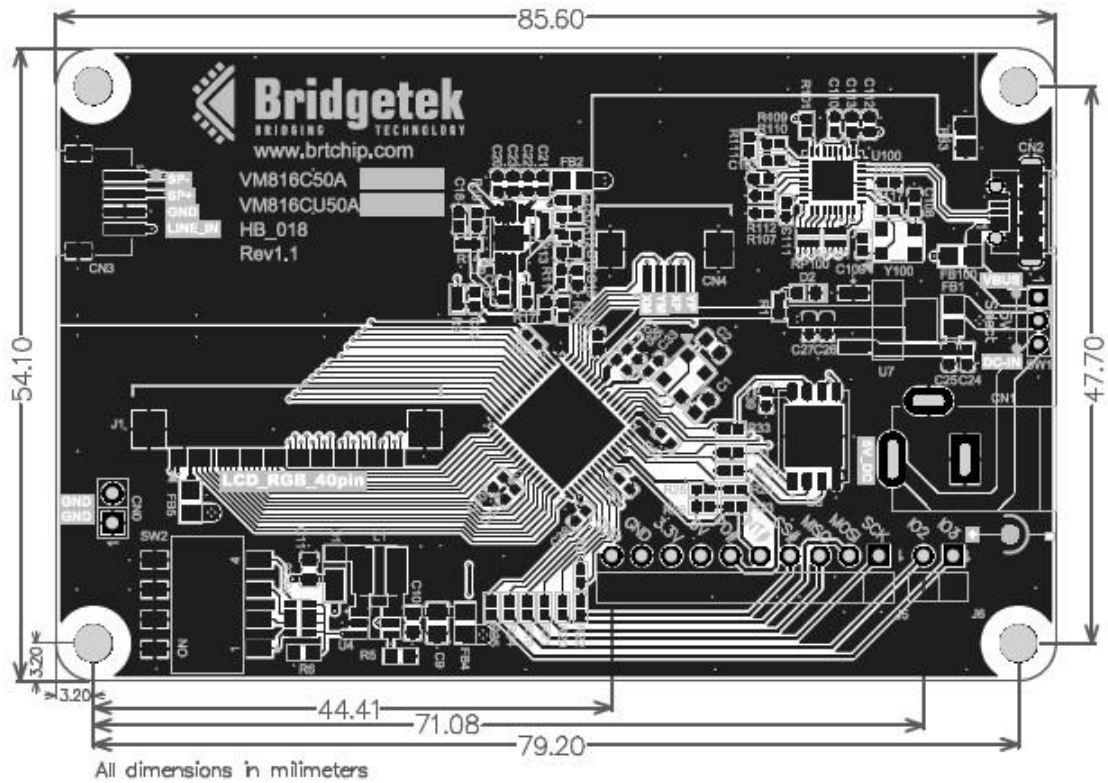

**Figure 6-1 – PCB mechanical dimensions**

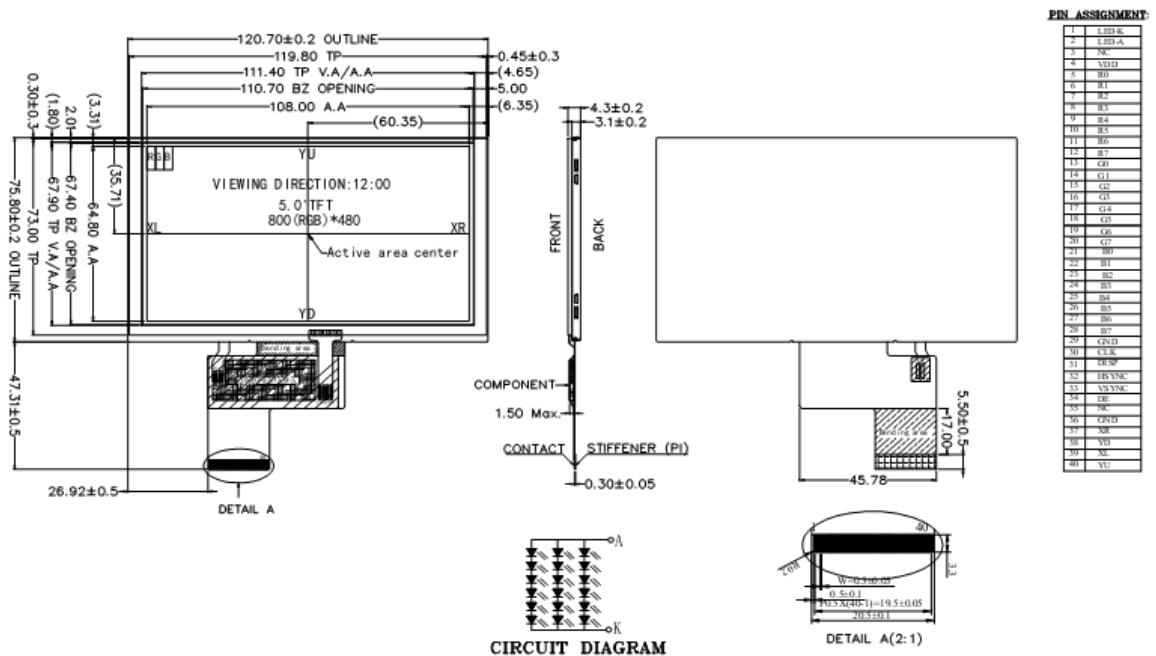

**Figure 6-2 – 5" WVGA LCD dimensions**

## 7 Specifications

### 7.1 Optical Specification

Item	Symbol	Condition	Min.	Typ.	Max.	Unit	Note	
Brightness (With TP)	Bp	$\theta=0^\circ$ $\Phi=0^\circ$		400	-	Cd/m <sup>2</sup>	1	
Uniformity	$\Delta$ Bp		75	-	-	%	1,2	
Viewing Angle	3:00	Cr $\geq$ 10	-	60	-	Deg	3	
	6:00		-	45	-			
	9:00		-	60	-			
	12:00		-	60	-			
Contrast Ratio	Cr		300	500		-	4	
Response Time	T <sub>r</sub>	$\theta=0^\circ$ $\Phi=0^\circ$	-	10	-	ms	5	
	T <sub>f</sub>		-	10	-	ms		
Color of CIE Coordinate	W	x		0.28		-	1,6	
		y		0.33		-		
	R	x		0.51		-		
		y		0.34		-		
	G	x	$\theta=0^\circ$ $\Phi=0^\circ$		0.31			-
		y			0.56			-
	B	x			0.15			-
		y			0.14			-
NTSC Ratio	S		50	60	-	%		

Note: The parameter is slightly changed by temperature, driving voltage and material

Note 1: The data are measured after LEDs are turned on for 5 minutes. LCM displays full white. The brightness is the average value of 9 measured spots. Measurement equipment PR-705 ( $\Phi$ 8mm)

Measuring condition:

- Measuring surroundings: Dark room.
- Measuring temperature: Ta=25°C.
- Adjust operating voltage to get optimum contrast at the center of the display.

Measured value at the center point of LCD panel after more than 5 minutes while backlight turning on.

**Table 7-1 – 5" TFT Optical Specification**

## 8 Contact Information

### Head Quarters – Singapore

Bridgetek Pte Ltd  
178 Paya Lebar Road, #07-03  
Singapore 409030  
Tel: +65 6547 4827  
Fax: +65 6841 6071

E-mail (Sales) [sales.apac@brtchip.com](mailto:sales.apac@brtchip.com)  
E-mail (Support) [support.apac@brtchip.com](mailto:support.apac@brtchip.com)

### Branch Office - Glasgow, United Kingdom

Bridgetek Pte. Ltd.  
Unit 1, 2 Seaward Place, Centurion Business Park  
Glasgow G41 1HH  
United Kingdom  
Tel: +44 (0) 141 429 2777  
Fax: +44 (0) 141 429 2758

E-mail (Sales) [sales.emea@brtchip.com](mailto:sales.emea@brtchip.com)  
E-mail (Support) [support.emea@brtchip.com](mailto:support.emea@brtchip.com)

### Branch Office – Taipei, Taiwan

Bridgetek Pte Ltd, Taiwan Branch  
2 Floor, No. 516, Sec. 1, Nei Hu Road, Nei Hu District  
Taipei 114  
Taiwan, R.O.C.  
Tel: +886 (2) 8797 5691  
Fax: +886 (2) 8751 9737

E-mail (Sales) [sales.apac@brtchip.com](mailto:sales.apac@brtchip.com)  
E-mail (Support) [support.apac@brtchip.com](mailto:support.apac@brtchip.com)

### Branch Office – Vietnam

Bridgetek VietNam Company Limited  
Lutaco Tower Building, 5th Floor, 173A Nguyen Van  
Troj,  
Ward 11, Phu Nhuan District,  
Ho Chi Minh City, Vietnam  
Tel : 08 38453222  
Fax : 08 38455222

E-mail (Sales) [sales.apac@brtchip.com](mailto:sales.apac@brtchip.com)  
E-mail (Support) [support.apac@brtchip.com](mailto:support.apac@brtchip.com)

### Web Site

<http://brtchip.com/>

### Distributor and Sales Representatives

Please visit the Sales Network page of the [Bridgetek Web site](#) for the contact details of our distributor(s) and sales representative(s) in your country.

System and equipment manufacturers and designers are responsible to ensure that their systems, and any Bridgetek Pte Ltd (BRT Chip) devices incorporated in their systems, meet all applicable safety, regulatory and system-level performance requirements. All application-related information in this document (including application descriptions, suggested Bridgetek devices and other materials) is provided for reference only. While Bridgetek has taken care to assure it is accurate, this information is subject to customer confirmation, and Bridgetek disclaims all liability for system designs and for any applications assistance provided by Bridgetek. Use of Bridgetek devices in life support and/or safety applications is entirely at the user's risk, and the user agrees to defend, indemnify and hold harmless Bridgetek from any and all damages, claims, suits or expense resulting from such use. This document is subject to change without notice. No freedom to use patents or other intellectual property rights is implied by the publication of this document. Neither the whole nor any part of the information contained in, or the product described in this document, may be adapted or reproduced in any material or electronic form without the prior written consent of the copyright holder. Bridgetek Pte Ltd, 178 Paya Lebar Road, #07-03, Singapore 409030. Singapore Registered Company Number: 201542387H.

---

## Appendix A – References

### Document References

For module documentations, please refer to the URL below:

<http://brtchip.com/m-eve2/>

[BT81X Datasheet](#)

[BT81X Programming Guide](#)

[VA800A-SPI Datasheet](#)

[C232HM USB 2.0 Hi-Speed to MPSSE Cable Datasheet](#)

[D2xx Programmers Guide](#)

[AN\\_108 Command Processor for MPSSE and MCU Host Bus Emulation Modes](#)

[AN\\_245 VM800CB-Sample App-PC Introduction](#)

### Acronyms and Abbreviations

Terms	Description
EVE	Embedded Video Engine
LCD	Liquid Crystal Display
MPSSE	Multi Purpose Synchronous Serial Engine
PC	Personal Computer
SPI	Serial Peripheral Interface
TFT	Thin Film Transistor
USB	Universal Serial Bus

---

## Appendix B - List of Figures and Tables

### List of Figures

Figure 4-1 - BT816 and LCD circuit .....	9
Figure 4-2 – SPI Interface and FT4222 USB Bridge Circuit .....	10
Figure 4-3 – Audio Circuit .....	11
Figure 5-1 – VM816C connects to PC via VA800A-SPI or MPSSE cable .....	13
Figure 6-1 – PCB mechanical dimensions .....	15
Figure 6-2 – 5” WVGA LCD dimensions .....	15

### List of Tables

Table 2-1 – Ordering information .....	2
Table 3-1 – CN1 Pinout .....	6
Table 3-2 – CN2 Pinout .....	6
Table 3-3 – CN3 Pinout .....	6
Table 5-1 – Board power configuration .....	12
Table 5-2 – MPSSE cable (C232HM-EDHSL-0) connection .....	14
Table 7-1 – 5” TFT Optical Specification .....	16

---

## Appendix C – Revision History

Document Title: VM810C EVE2 Credit Card Module Datasheet  
Document Reference No.: BRT\_000232  
Clearance No.: BRT#130  
Product Page: <http://brtchip.com/m-eve2/>  
Document Feedback: [Send Feedback](#)

Revision	Changes	Date
1.0	Initial Release	2018-08-15



## Данный компонент на территории Российской Федерации

### Вы можете приобрести в компании MosChip.

Для оперативного оформления запроса Вам необходимо перейти по данной ссылке:

<http://moschip.ru/get-element>

Вы можете разместить у нас заказ для любого Вашего проекта, будь то серийное производство или разработка единичного прибора.

В нашем ассортименте представлены ведущие мировые производители активных и пассивных электронных компонентов.

Нашей специализацией является поставка электронной компонентной базы двойного назначения, продукции таких производителей как XILINX, Intel (ex.ALTERA), Vicor, Microchip, Texas Instruments, Analog Devices, Mini-Circuits, Amphenol, Glenair.

Сотрудничество с глобальными дистрибьюторами электронных компонентов, предоставляет возможность заказывать и получать с международных складов практически любой перечень компонентов в оптимальные для Вас сроки.

На всех этапах разработки и производства наши партнеры могут получить квалифицированную поддержку опытных инженеров.

Система менеджмента качества компании отвечает требованиям в соответствии с ГОСТ Р ИСО 9001, ГОСТ РВ 0015-002 и ЭС РД 009

### Офис по работе с юридическими лицами:

105318, г.Москва, ул.Щербаковская д.3, офис 1107, 1118, ДЦ «Щербаковский»

Телефон: +7 495 668-12-70 (многоканальный)

Факс: +7 495 668-12-70 (доб.304)

E-mail: [info@moschip.ru](mailto:info@moschip.ru)

Skype отдела продаж:

moschip.ru

moschip.ru\_4

moschip.ru\_6

moschip.ru\_9