

FEATURES

Passive: no dc bias required
Input IP3: 20 dBm typical, downconverter
LO to RF isolation: 30 dB typical
Wide IF bandwidth: dc to 8 GHz
12-terminal, ceramic, 2.90 mm × 2.90 mm LCC

APPLICATIONS

Point to point radios
Point to multipoint radios and very small aperture terminals (VSATs)
Test equipment and sensors
Military end use

GENERAL DESCRIPTION

The HMC774ALC3B is a general-purpose, double balanced mixer in a leadless, RoHS compliant, surface-mount package that can be used as an upconverter or a downconverter between 7 GHz and 34 GHz. This mixer requires no external components or matching circuitry. The HMC774ALC3B provides excellent LO to RF isolation and LO to IF isolation due to optimized balun structures.

FUNCTIONAL BLOCK DIAGRAM

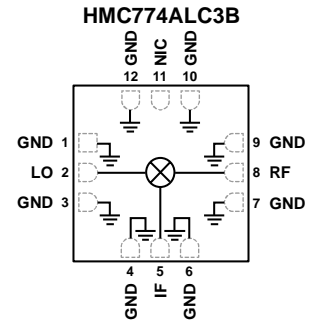

Figure 1.

The mixer operates best with a LO drive level of 15 dBm (typical). The HMC774ALC3B eliminates the need for wire bonding, allowing the use of surface-mount manufacturing techniques.

TABLE OF CONTENTS

Features 1

Applications 1

Functional Block Diagram 1

General Description 1

Revision History 2

Specifications 3

 7 GHz to 20 GHz Frequency Range 3

 20 GHz to 34 GHz Frequency Range 3

Absolute Maximum Ratings 4

 Thermal Resistance 4

 ESD Caution 4

Pin Configuration and Function Descriptions 5

 Interface Schematics 5

Typical Performance Characteristics 6

 Downconverter, IF = 500 MHz, Upper Sideband 6

 Downconverter, IF = 500 MHz, Lower Sideband 8

 Downconverter, IF = 3000 MHz, Upper Sideband 10

 Downconverter, IF = 3000 MHz, Lower Sideband 11

 Downconverter, IF = 8000 MHz, Upper Sideband 12

 Downconverter, IF = 8000 MHz, Lower Sideband 13

 Upconverter, IF = 500 MHz, Upper Sideband 14

 Upconverter, IF = 500 MHz, Lower Sideband 15

 Upconverter, IF = 3000 MHz, Upper Sideband 16

 Upconverter, IF = 3000 MHz, Lower Sideband 17

 Upconverter, IF = 8000 MHz, Upper Sideband 18

 Upconverter, IF = 8000 MHz, Lower Sideband 19

 IF Bandwidth, LO = 28 GHz, Upper Sideband 20

 IF Bandwidth, LO = 34 GHz, Lower Sideband 21

 Isolation and Return Loss 22

 Spurious Performance 23

Theory of Operation 24

Applications Information 25

 Evaluation Board 25

Outline Dimensions 27

 Ordering Guide 27

REVISION HISTORY

6/2018—Rev. 0 to Rev. A

Change to General Description Section and Features Section... 1

Change to Table 1 and Table 2 3

Change to Table 5 5

Changed Downconverter, IF = 500 MHz Section to
Downconverter, IF = 500 MHz, Upper Sideband Section 6

Changes to Figure 7 to Figure 12 6

Changes to Figure 13 7

Added Figure 14; Renumbered Sequentially 7

Added Downconverter, IF = 500 MHz, Lower Sideband
Section 8

Added Figure 15 to Figure 20 8

Added Figure 21 and Figure 22 9

Added Downconverter, IF = 3000 MHz, Upper Sideband
Section 10

Changes to Figure 23 and Figure 24 10

Added Downconverter, IF = 3000 MHz, Upper Sideband
Section 10

Added Figure 25 to Figure 28 10

Added Downconverter, IF = 3000 MHz, Lower Sideband
Section 11

Added Figure 29 to Figure 34 11

Added Downconverter, IF = 8000 MHz, Upper Sideband
Section 12

Added Figure 35 to Figure 40 12

Added Downconverter, IF = 8000 MHz, Lower Sideband
Section 13

Added Figure 41 to Figure 46 13

Changed Upconverter, IF = 500 MHz Section to Upconverter,
IF = 500 MHz, Upper Sideband Section 14

Added Figure 48, Figure 49, Figure 51, and Figure 52 14

Added Upconverter, IF = 500 MHz, Lower Sideband
Section 15

Added Figure 54, Figure 55, Figure 57 and Figure 58 15

Added Upconverter, IF = 3000 MHz, Upper Sideband
Section 16

Added Figure 59 to Figure 62 16

Added Upconverter, IF = 3000 MHz, Lower Sideband
Section 17

Added Figure 63 to Figure 66 17

Added Upconverter, IF = 8000 MHz, Upper Sideband
Section 18

Added Figure 67 to Figure 70 18

Added Upconverter, IF = 8000 MHz, Lower Sideband
Section 19

Added Figure 71 to Figure 74 19

Changed IF Bandwidth Section to IF Bandwidth, LO = 28 GHz,
Upper Sideband Section 20

Added Figure 75 to Figure 80 20

Added IF Bandwidth, LO = 34 GHz, Lower Sideband
Section 20

Added Figure 81 to Figure 86 21

Changes to Spurious Performance Section and Table 6 23

Added Table 7; Renumbered Sequentially 23

2/2018—Revision 0: Initial Version

SPECIFICATIONS

7 GHz TO 20 GHz FREQUENCY RANGE

Measurements are performed in downconverter mode at $T_A = 25^\circ\text{C}$, IF frequency (f_{IF}) = 500 MHz, RF power (P_{RF}) = -10 dBm, LO power (P_{LO}) = +15 dBm, and upper sideband (USB) with 50 Ω system, unless otherwise noted.

Table 1.

Parameter	Symbol	Min	Typ	Max	Unit
FREQUENCY RANGE					
Radio Frequency	f_{RF}	7		20	GHz
Intermediate Frequency	f_{IF}	DC		8	GHz
Local Oscillator	f_{LO}	7		34	GHz
LO DRIVE LEVEL		11	15	17	dBm
RF PERFORMANCE					
Downconverter					
Conversion Loss			10	15	dB
Input Third-Order Intercept	IP3	12.5	20		dBm
Input Second-Order Intercept	IP2		48		dBm
Input 1 dB Compression Point	P1dB		12		dB
Single Sideband Noise Figure	SSB NF		12		dB
Isolation					
RF to IF		7	9		dB
LO to RF		28	30		dB
LO to IF		20.5	23		dB
Upconverter					
Conversion Loss			10		dB
Input Third-Order Intercept	IP3		27		dBm

20 GHz TO 34 GHz FREQUENCY RANGE

Measurements are performed in downconverter mode at $T_A = 25^\circ\text{C}$, $f_{IF} = 500$ MHz, $P_{RF} = -10$ dBm, $P_{LO} = +15$ dBm, and lower sideband with 50 Ω system, unless otherwise noted.

Table 2.

Parameter	Symbol	Min	Typ	Max	Unit
FREQUENCY RANGE					
Radio Frequency	f_{RF}	20		34	GHz
Intermediate Frequency	f_{IF}	DC		8	GHz
Local Oscillator	f_{LO}	20		34	GHz
LO DRIVE LEVEL		11	15	17	dBm
RF PERFORMANCE					
Downconverter					
Conversion Loss			12	15.5	dB
Input Third-Order Intercept	IP3	17	20		dBm
Input Second-Order Intercept	IP2		40		dBm
Input 1 dB Compression Point	P1dB		13		dB
Single Sideband Noise Figure	SSB NF		12		dB
Isolation					
RF to IF		25	30		dB
LO to RF		27.5	33		dB
LO to IF		30	40		dB
Upconverter					
Conversion Loss			9		dB
Input Third-Order Intercept	IP3		23		dBm

ABSOLUTE MAXIMUM RATINGS

Table 3.

Parameter	Rating
RF Input Power when LO = 18 dBm	21 dBm
LO Drive	25 dBm
IF Input Power when LO = 18 dBm	21 dBm
LO and RF DC Source and Sink Current	55 mA
IF Port Maximum Sink and Source Current	3 mA
Maximum Channel Temperature	175°C
Maximum Junction Temperature	165°C
Continuous Power Dissipation, P_{DISS} ($T_A = 85^\circ\text{C}$, Derate 2.9 mW/°C Above 85°C)	189 mW
Operating Temperature Range	-40°C to +85°C
Storage Temperature Range	-65°C to +150°C
Lead Temperature Range	-65°C to +150°C
Reflow Temperature	260°C
Electrostatic Discharge (ESD) Sensitivity	
Human Body Model (HBM)	Class 1C (1.5 kV)
Field Induced Charge Device Model (FICDM)	Class IV (1.25 kV)

Stresses at or above those listed under Absolute Maximum Ratings may cause permanent damage to the product. This is a stress rating only; functional operation of the product at these or any other conditions above those indicated in the operational section of this specification is not implied. Operation beyond the maximum operating conditions for extended periods may affect product reliability.

THERMAL RESISTANCE

Thermal performance is directly linked to printed circuit board (PCB) design and operating environment. Careful attention to PCB thermal design is required.

θ_{JA} is the thermal resistance value that is measured from junction to air, and θ_{JC} is the thermal resistance value that is measured from junction to case (package).

Table 4. Thermal Resistance

Package Type ¹	θ_{JA}	θ_{JC}	Unit
E-12-4	120	274	°C/W

¹ See JEDEC standard JESD51-2 for additional information on optimizing the thermal impedance (PCB with 3 × 3 vias).

ESD CAUTION



ESD (electrostatic discharge) sensitive device. Charged devices and circuit boards can discharge without detection. Although this product features patented or proprietary protection circuitry, damage may occur on devices subjected to high energy ESD. Therefore, proper ESD precautions should be taken to avoid performance degradation or loss of functionality.

PIN CONFIGURATION AND FUNCTION DESCRIPTIONS

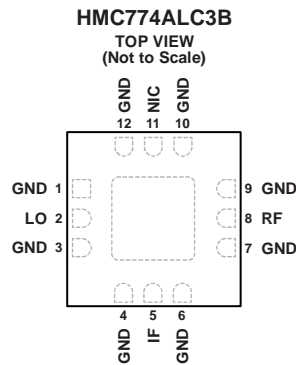

- NOTES**
1. NIC = NOT INTERNALLY CONNECTED. THESE PINS CAN BE CONNECTED TO RF AND DC GROUND. PERFORMANCE IS NOT AFFECTED.
 2. EXPOSED PAD. THE EXPOSED PAD MUST BE CONNECTED TO THE RF AND DC GROUND OF THE PCB.

13897-002

Figure 2. Pin Configuration

Table 5. Pin Function Descriptions

Pin No.	Mnemonic	Description
1, 3, 4, 6, 7, 9, 10, 12	GND	Ground. These pins must be connected to the RF and dc ground of the PCB. See Figure 3 for the interface schematic.
2	LO	Local Oscillator Port. This pin is dc-coupled and matched to 50 Ω. For the maximum dc current capability of this pin, see the Absolute Maximum Ratings section. See Figure 4 for the interface schematic.
5	IF	Intermediate Frequency Port. For applications not requiring operation to dc, dc block this port externally using a series capacitor of a value chosen to pass the necessary IF frequency range. For operation to dc, this pin must not source or sink more than 3 mA of current or die malfunction and possible die failure can result. See Figure 5 for the interface schematic.
8	RF	Radio Frequency Port. This pin is dc-coupled and matched to 50 Ω. For the maximum dc current capability of this pin, see the Absolute Maximum Ratings section. See Figure 6 for the interface schematic.
11	NIC	Not Internally Connected. These pins can be connected to RF and dc ground. Performance is not affected.
	EPAD	Exposed Pad. The exposed pad must be connected to the RF and dc ground of the PCB.

INTERFACE SCHEMATICS



Figure 3. GND Interface Schematic

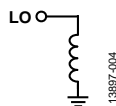

Figure 4. LO Interface Schematic

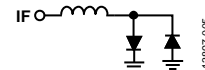

Figure 5. IF Interface Schematic

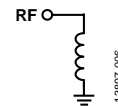

Figure 6. RF Interface Schematic

TYPICAL PERFORMANCE CHARACTERISTICS
DOWNCONVERTER, IF = 500 MHz, UPPER SIDEBAND

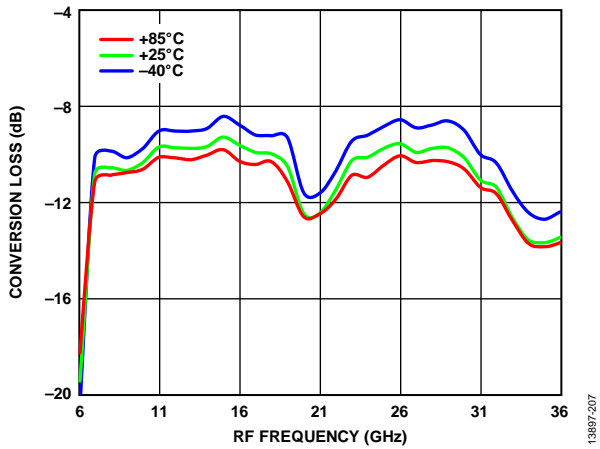

Figure 7. Conversion Loss vs. RF Frequency over Various Temperatures, $P_{LO} = 15 \text{ dBm}$

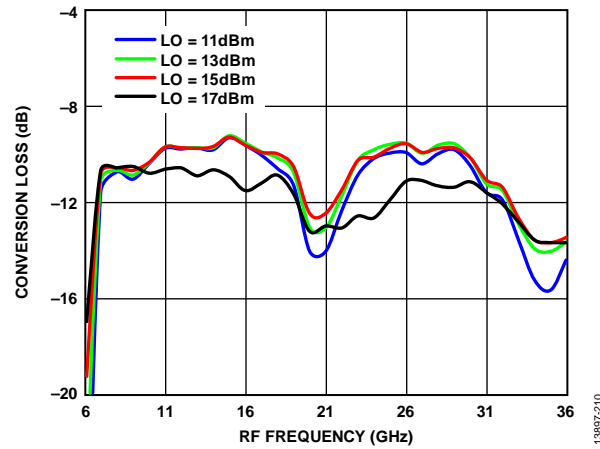

Figure 10. Conversion Loss vs. RF Frequency over LO Drives

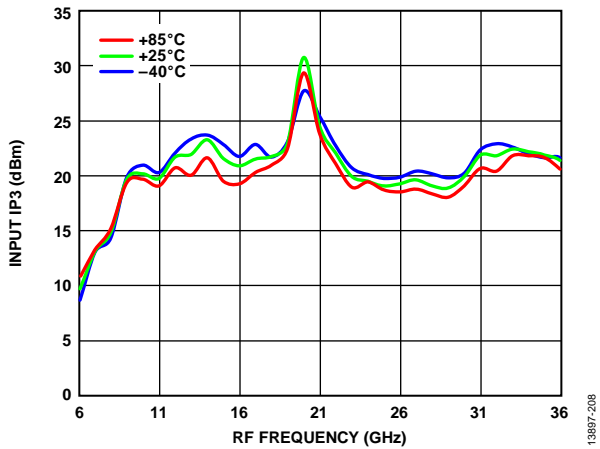

Figure 8. Input IP3 vs. RF Frequency over Various Temperatures, $P_{LO} = 15 \text{ dBm}$

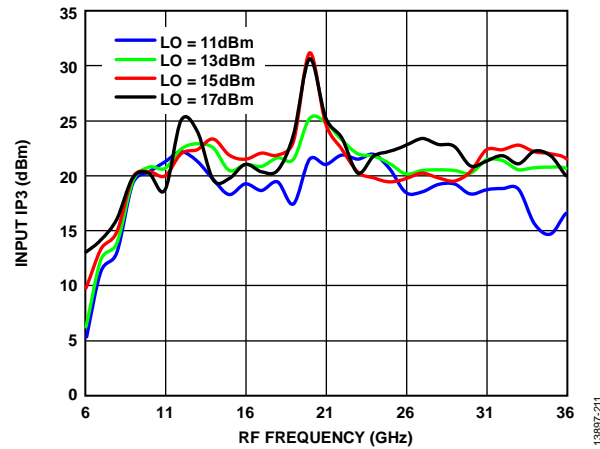

Figure 11. Input IP3 vs. RF Frequency over Various LO Drives

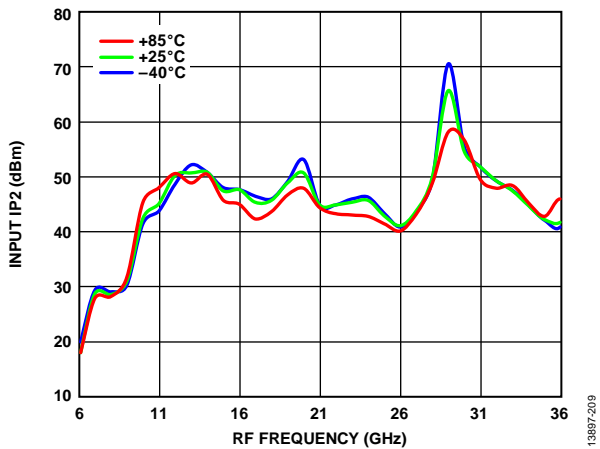

Figure 9. Input IP2 vs. RF Frequency over Various Temperatures, $P_{LO} = 15 \text{ dBm}$

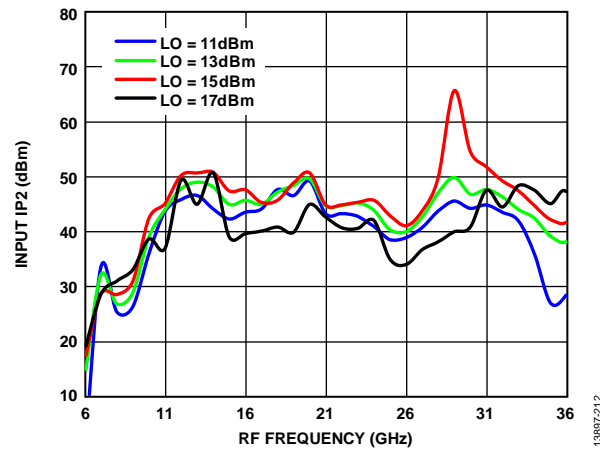

Figure 12. Input IP2 vs. RF Frequency over Various LO Drives

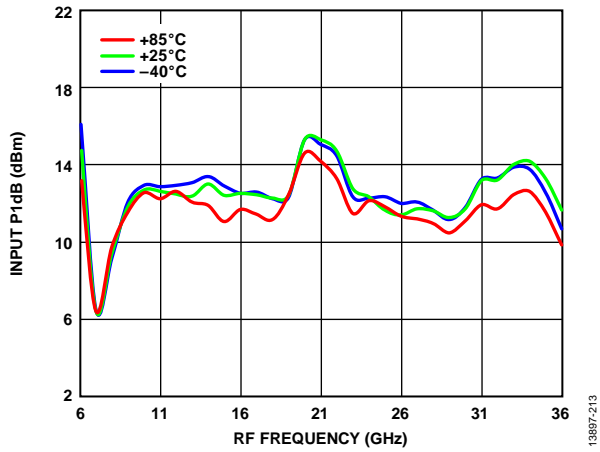

Figure 13. Input P1dB vs. RF Frequency over Various Temperatures, $P_{LO} = 15 \text{ dBm}$

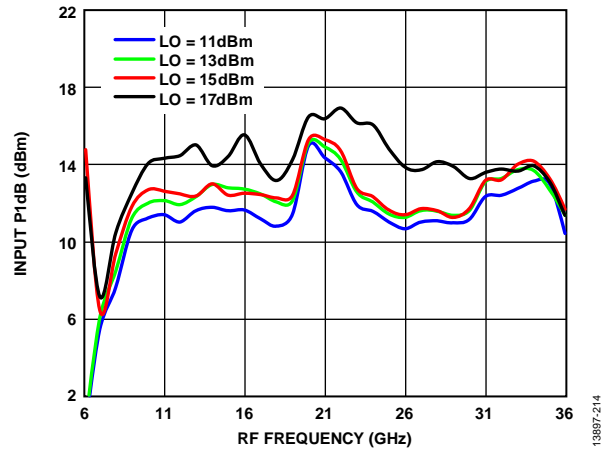

Figure 14. Input P1dB vs. RF Frequency over Various LO Drives

DOWNCONVERTER, IF = 500 MHz, LOWER SIDEBAND

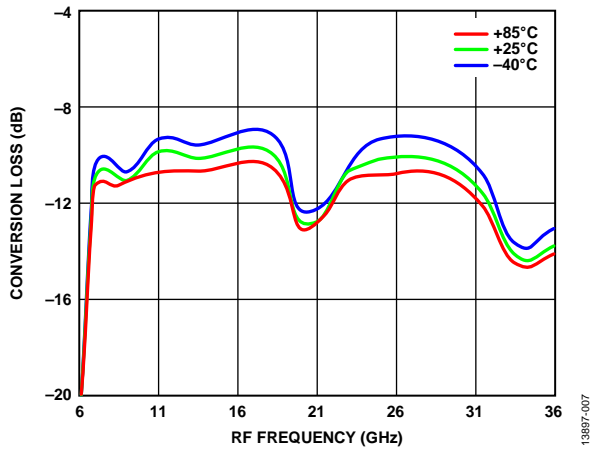

Figure 15. Conversion Loss vs. RF Frequency over Various Temperatures, $P_{LO} = 15 \text{ dBm}$

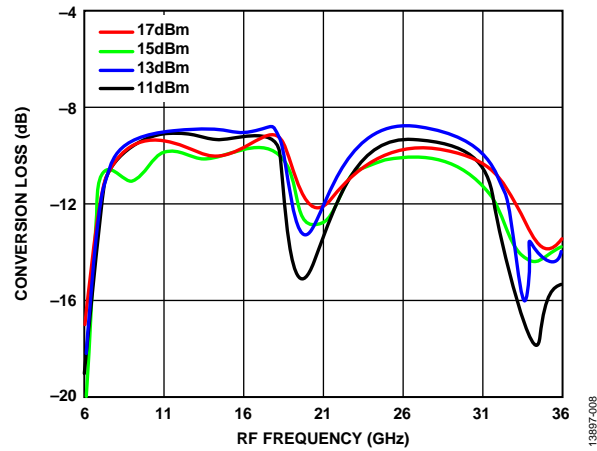

Figure 18. Conversion Loss vs. RF Frequency over LO Drives

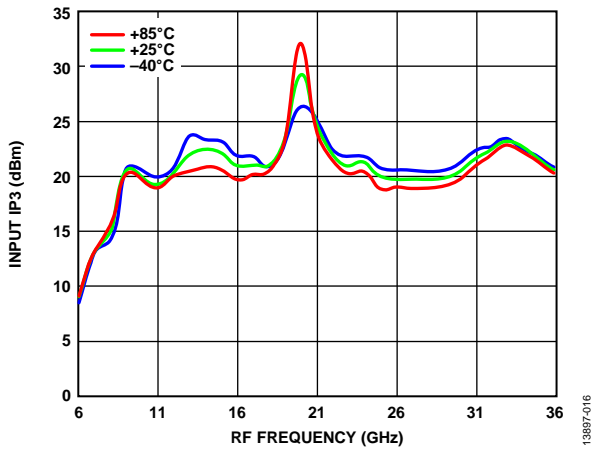

Figure 16. Input IP3 vs. RF Frequency over Various Temperatures, $P_{LO} = 15 \text{ dBm}$

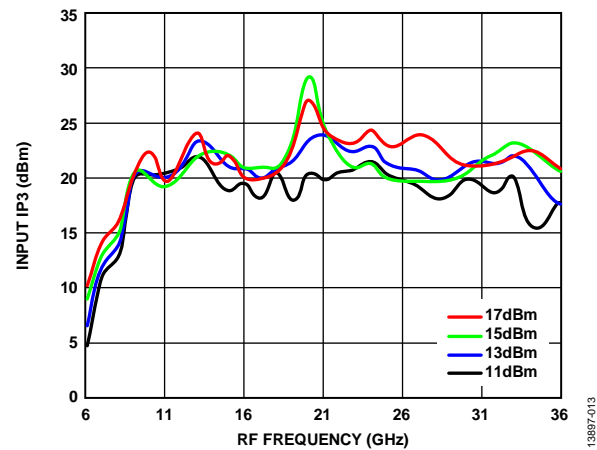

Figure 19. Input IP3 vs. RF Frequency over Various LO Drives

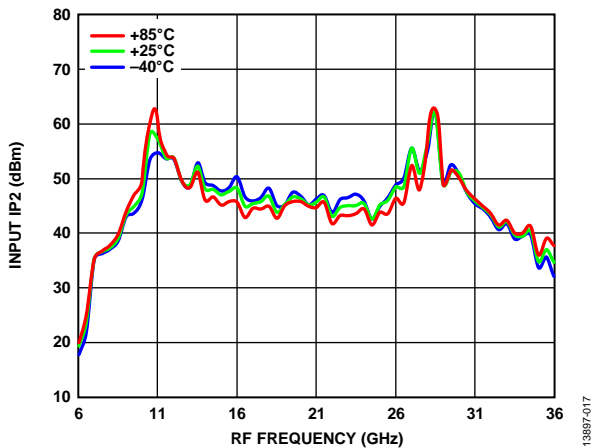

Figure 17. Input IP2 vs. RF Frequency over Various Temperatures, $P_{LO} = 15 \text{ dBm}$

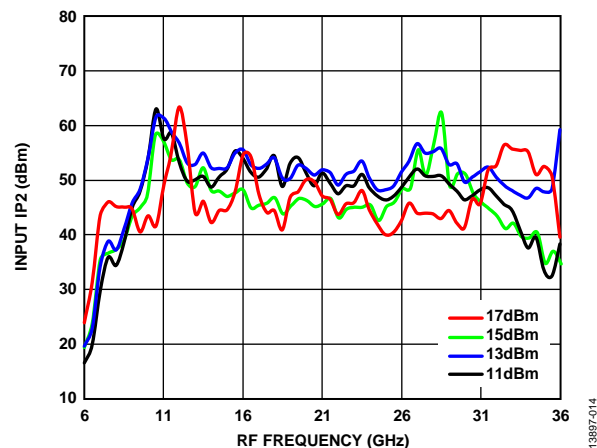

Figure 20. Input IP2 vs. RF Frequency over Various LO Drives

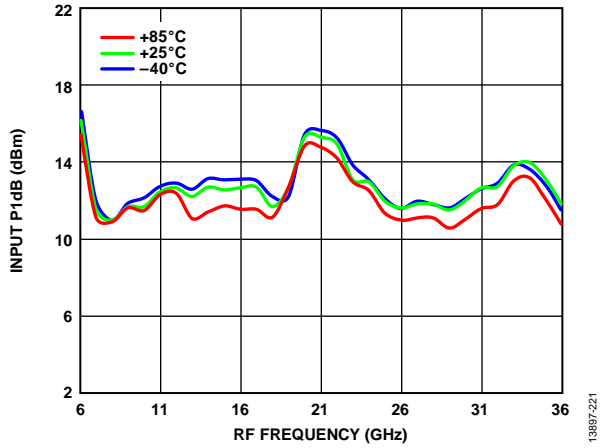

Figure 21. Input P1dB vs. RF Frequency over Various Temperatures, $P_{LO} = 15 \text{ dBm}$

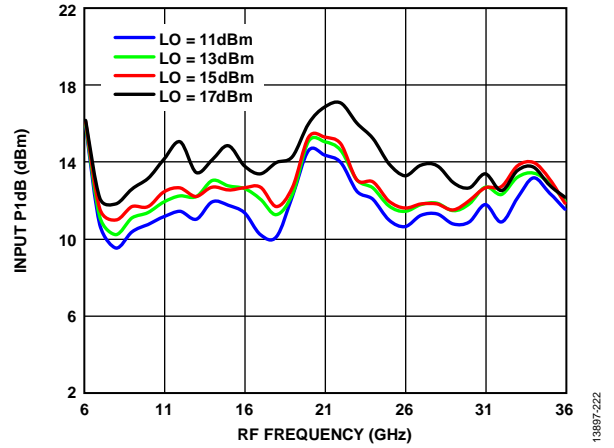

Figure 22. Input P1dB vs. RF Frequency over Various LO Drives

DOWNCONVERTER, IF = 3000 MHz, UPPER SIDEBAND

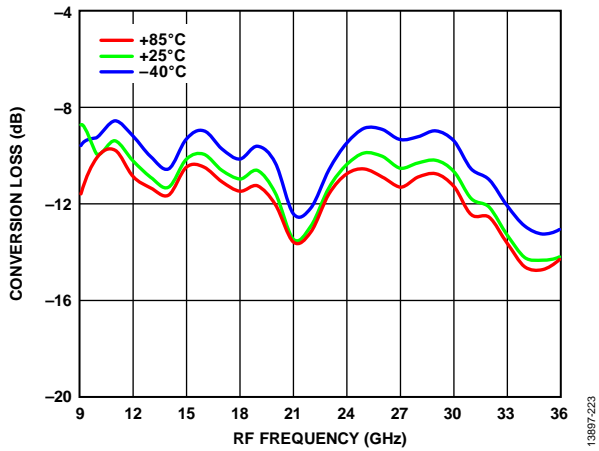

Figure 23. Conversion Loss vs. RF Frequency over Various Temperatures, $P_{LO} = 15 \text{ dBm}$

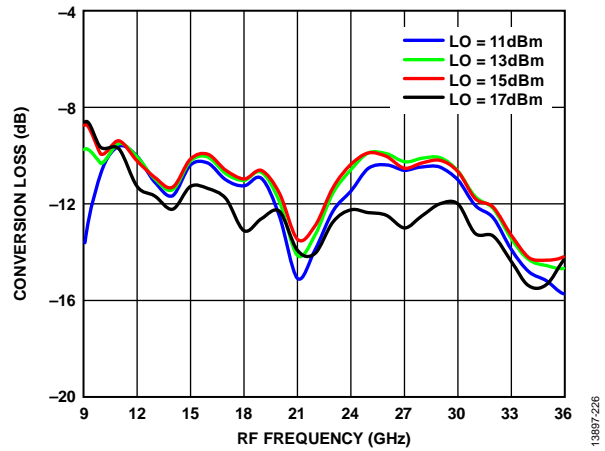

Figure 26. Conversion Loss vs. RF Frequency over Various LO Drives

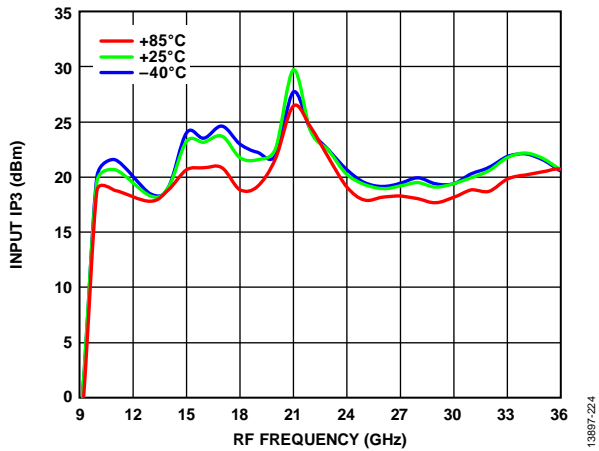

Figure 24. Input IP3 vs. RF Frequency over Various Temperatures, $P_{LO} = 15 \text{ dBm}$

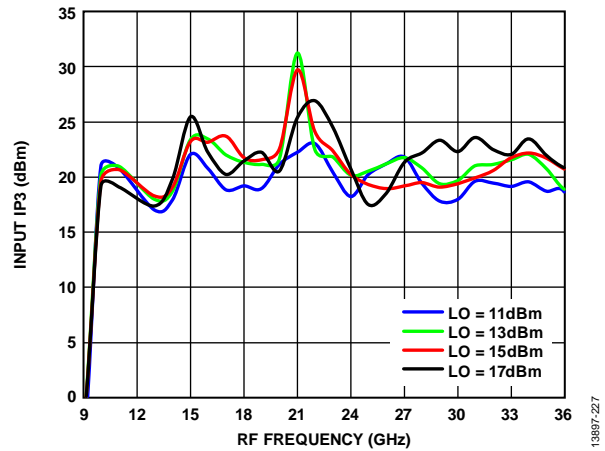

Figure 27. Input IP3 vs. RF Frequency over Various LO Drives

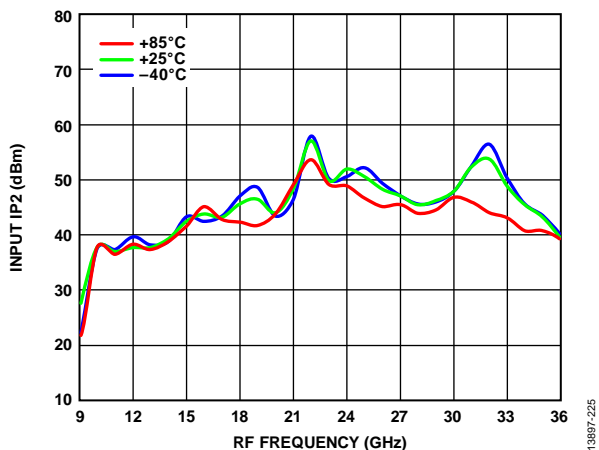

Figure 25. Input IP2 vs. RF Frequency over Various Temperatures, $P_{LO} = 15 \text{ dBm}$

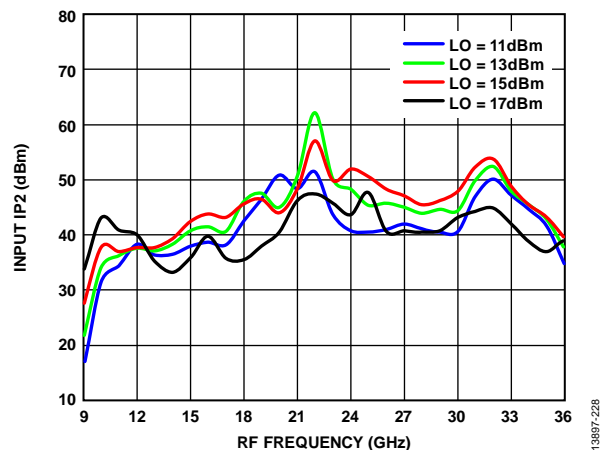

Figure 28. Input IP2 vs. RF Frequency over Various LO Drives

DOWNCONVERTER, IF = 3000 MHz, LOWER SIDEBAND

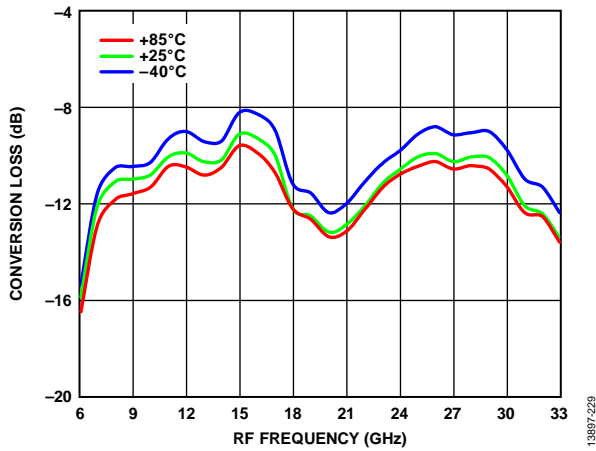

Figure 29. Conversion Loss vs. RF Frequency over Various Temperatures, $P_{LO} = 15 \text{ dBm}$

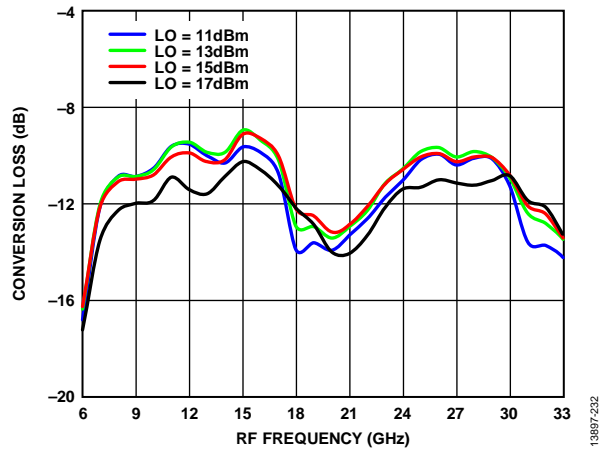

Figure 32. Conversion Loss vs. RF Frequency over Various LO Drives

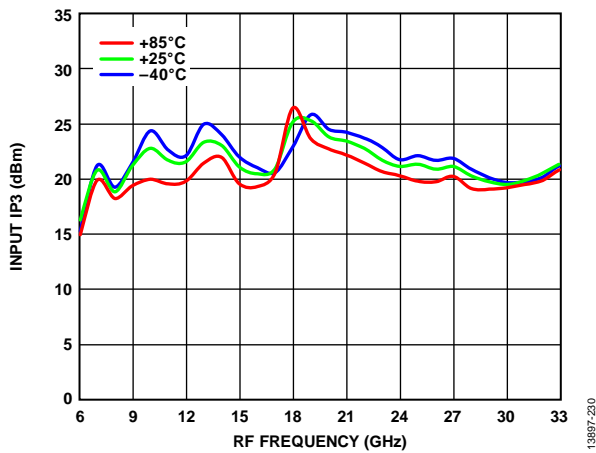

Figure 30. Input IP3 vs. RF Frequency over Various Temperatures, $P_{LO} = 15 \text{ dBm}$

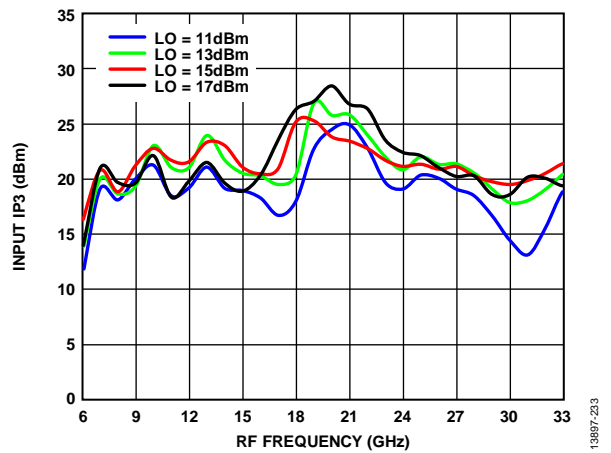

Figure 33. Input IP3 vs. RF Frequency over Various LO Drives

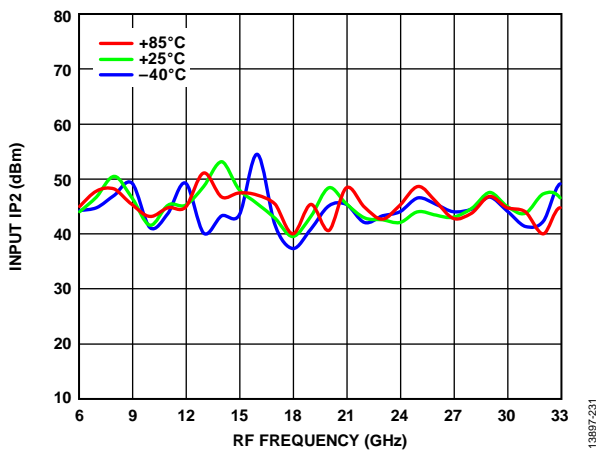

Figure 31. Input IP2 vs. RF Frequency over Various Temperatures, $P_{LO} = 15 \text{ dBm}$

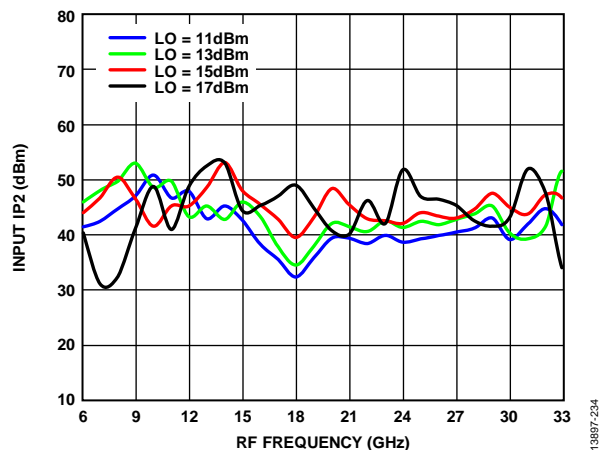

Figure 34. Input IP2 vs. RF Frequency over Various LO Drives

DOWNCONVERTER, IF = 8000 MHz, UPPER SIDEBAND

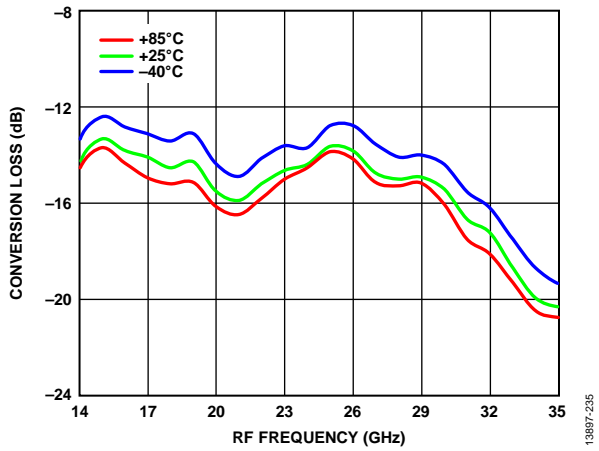

Figure 35. Conversion Loss vs. RF Frequency over Various Temperatures, $P_{LO} = 15 \text{ dBm}$

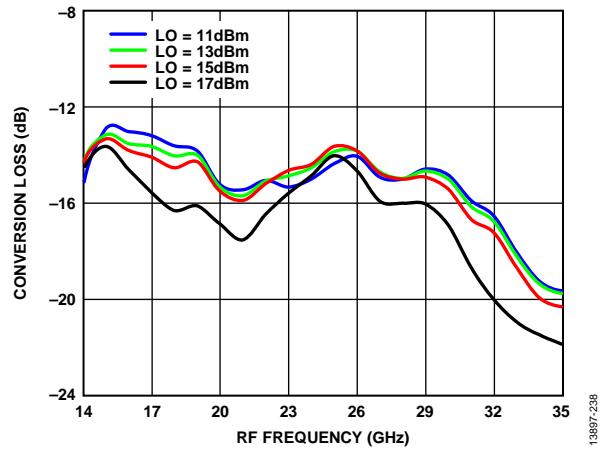

Figure 38. Conversion Loss vs. RF Frequency over Various LO Drives

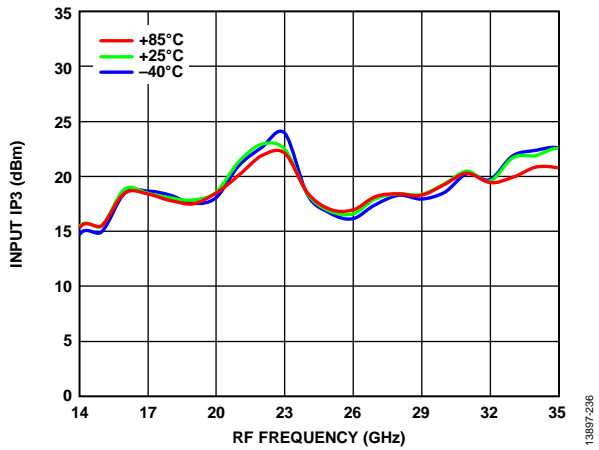

Figure 36. Input IP3 vs. RF Frequency over Various Temperatures, $P_{LO} = 15 \text{ dBm}$

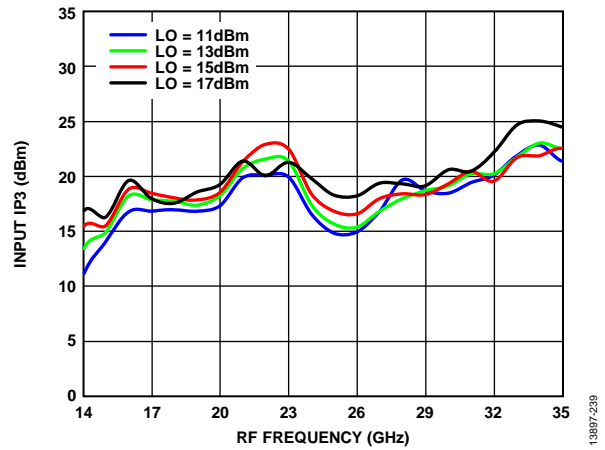

Figure 39. Input IP3 vs. RF Frequency over Various LO Drives

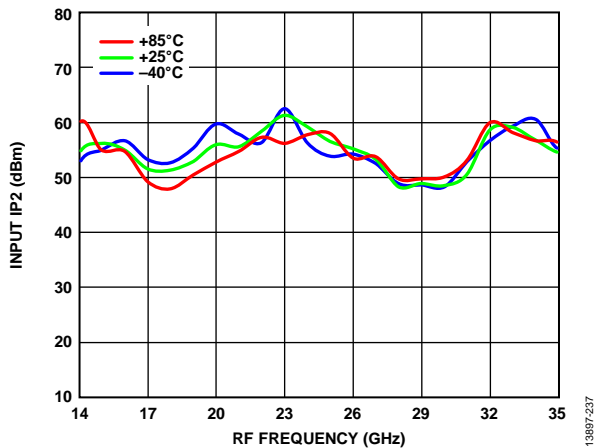

Figure 37. Input IP2 vs. RF Frequency over Various Temperatures, $P_{LO} = 15 \text{ dBm}$

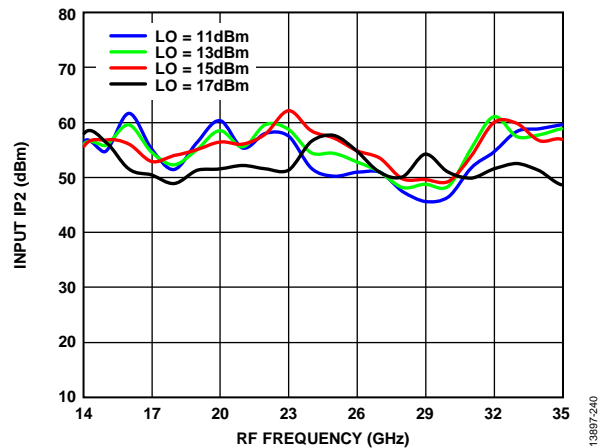

Figure 40. Input IP2 vs. RF Frequency over Various LO Drives

DOWNCONVERTER, IF = 8000 MHz, LOWER SIDEBAND

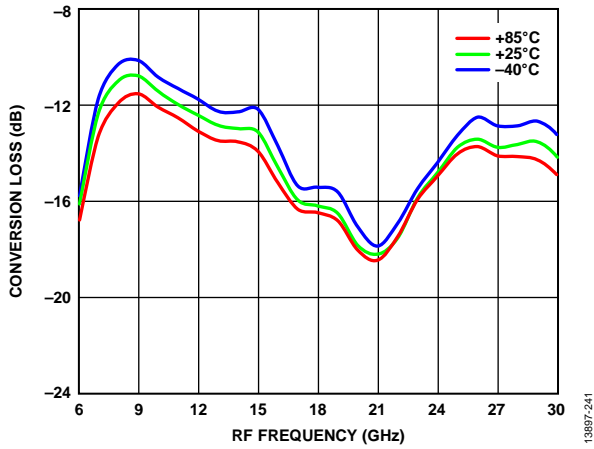

Figure 41. Conversion Loss vs. RF Frequency over Various Temperatures, $P_{LO} = 15$ dBm

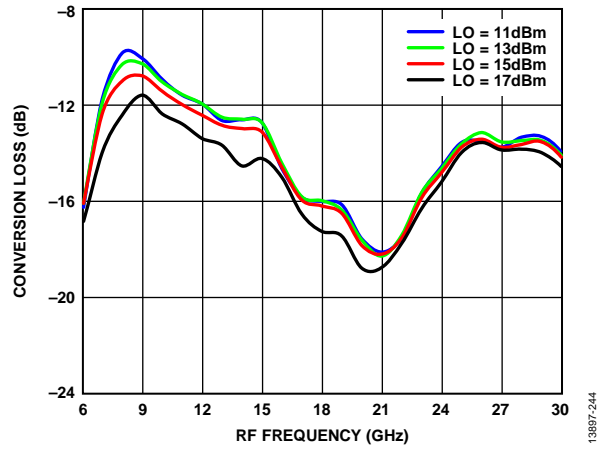

Figure 44. Conversion Loss vs. RF Frequency over Various LO Drives

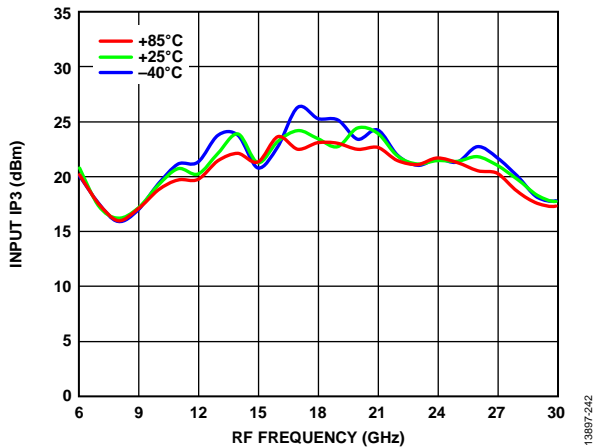

Figure 42. Input IP3 vs. RF Frequency over Various Temperatures, $P_{LO} = 15$ dBm

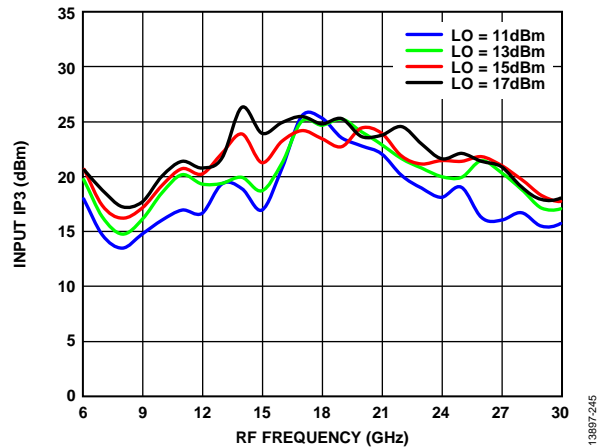

Figure 45. Input IP3 vs. RF Frequency over Various LO Drives

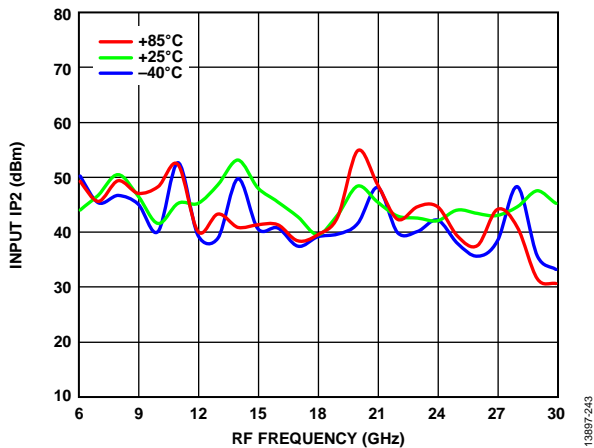

Figure 43. Input IP2 vs. RF Frequency over Various Temperatures, $P_{LO} = 15$ dBm

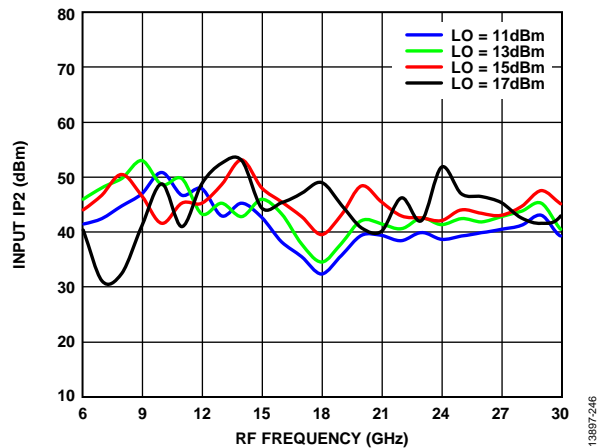

Figure 46. Input IP2 vs. RF Frequency over Various LO Drives

UPCONVERTER, IF = 500 MHz, UPPER SIDEBAND

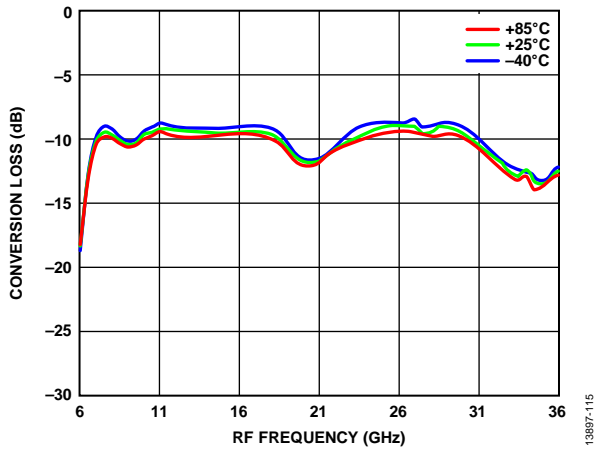

Figure 47. Conversion Loss vs. RF Frequency over Various Temperatures, $P_{LO} = 15 \text{ dBm}$

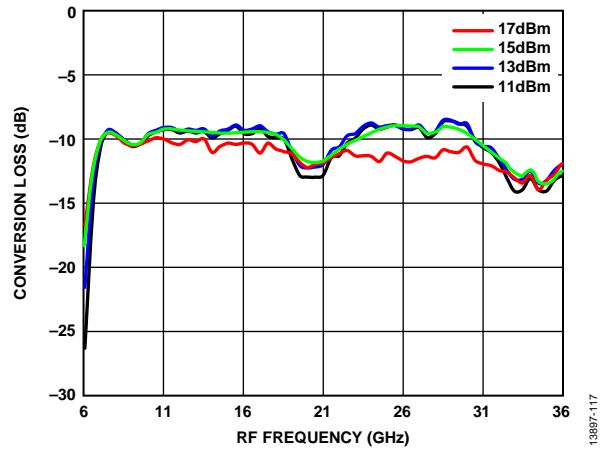

Figure 50. Conversion Loss vs. RF Frequency over LO Drives

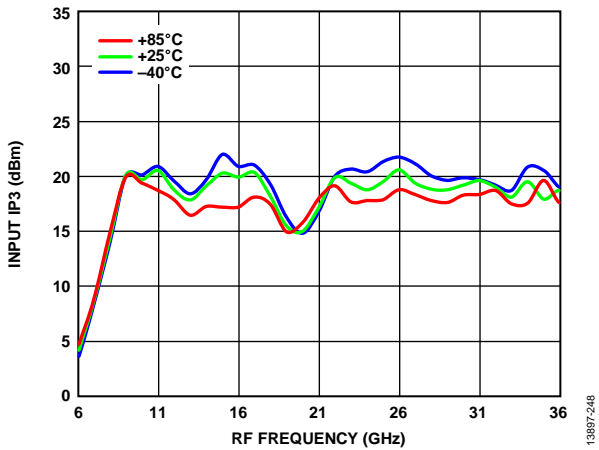

Figure 48. Input IP3 vs. RF Frequency over Various Temperatures, $P_{LO} = 15 \text{ dBm}$

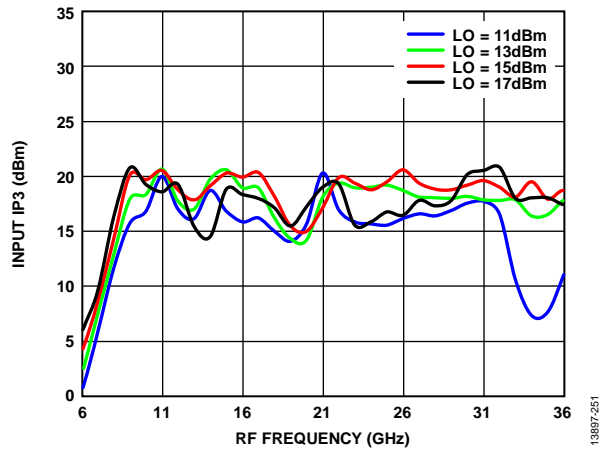

Figure 51. Input IP3 vs. RF Frequency over Various LO Drives

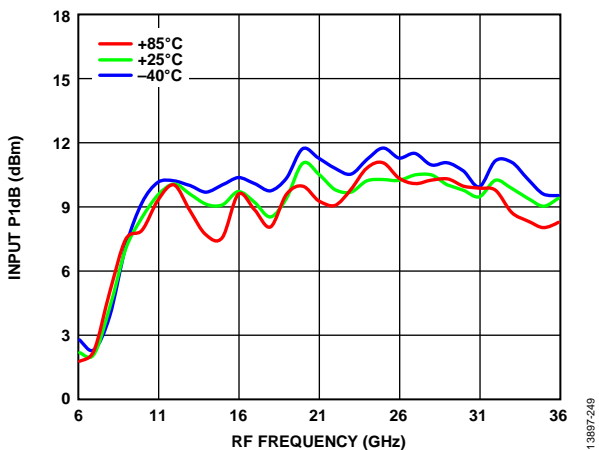

Figure 49. Input P1dB vs. RF Frequency over Various Temperatures, $P_{LO} = 15 \text{ dBm}$

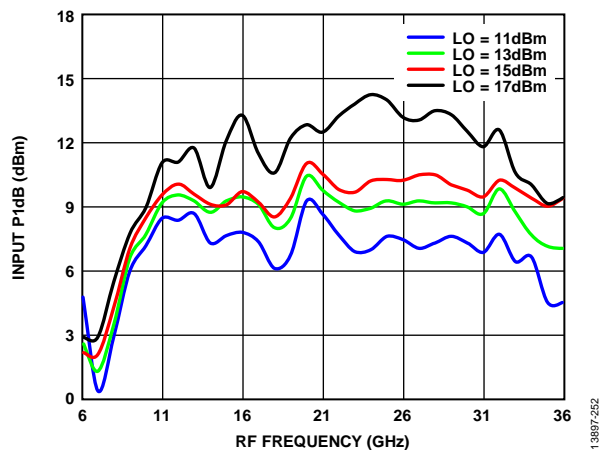

Figure 52. Input P1dB vs. RF Frequency over Various LO Drives

UPCONVERTER, IF = 500 MHz, LOWER SIDEBAND

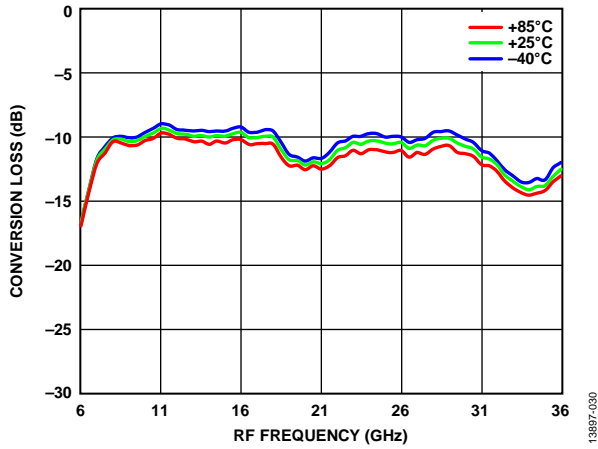

Figure 53. Conversion Loss vs. RF Frequency over Various Temperatures, $P_{LO} = 15$ dBm

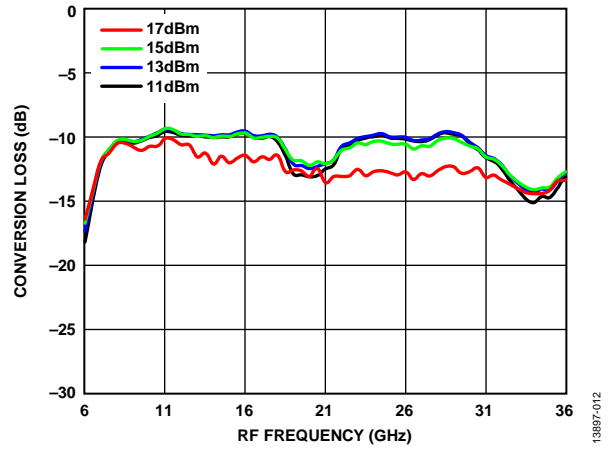

Figure 56. Conversion Loss vs. RF Frequency over LO Drives

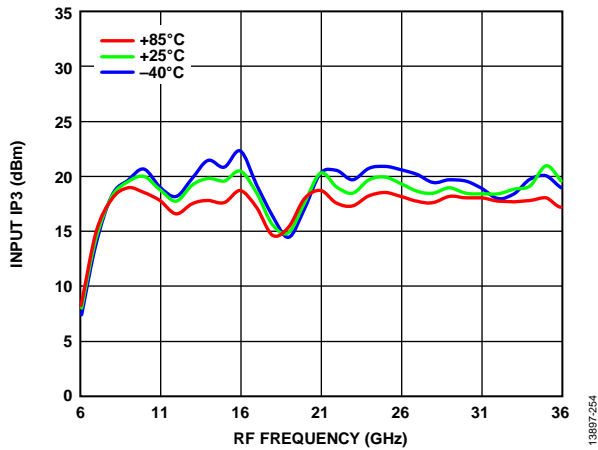

Figure 54. Input IP3 vs. RF Frequency over Various Temperatures, $P_{LO} = 15$ dBm

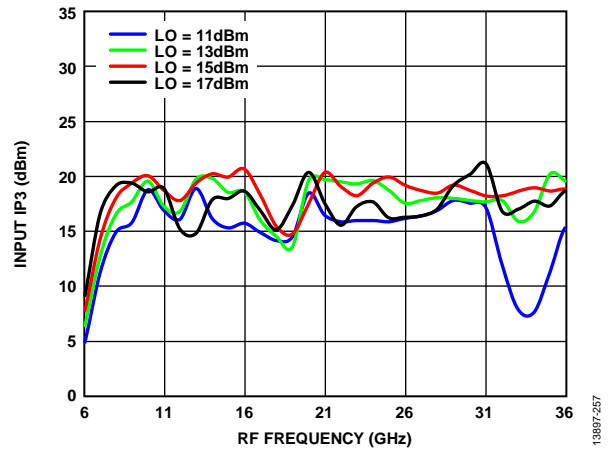

Figure 57. Input IP3 vs. RF Frequency over Various LO Drives

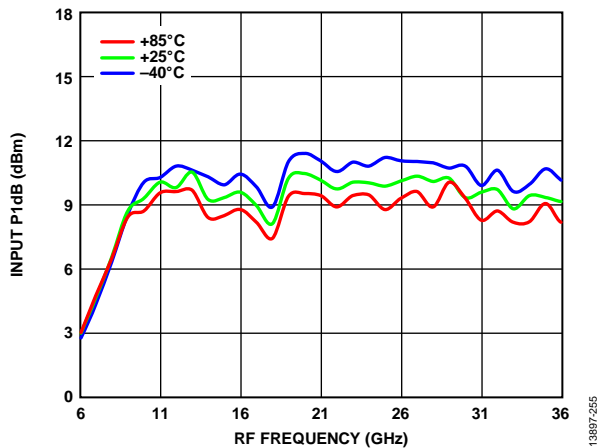

Figure 55. Input P1dB vs. RF Frequency over Various Temperatures, $P_{LO} = 15$ dBm

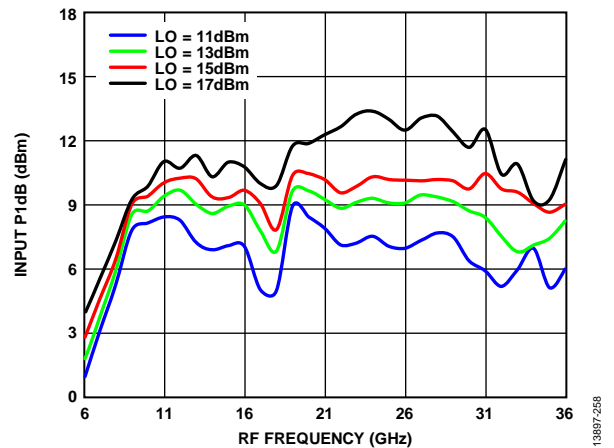

Figure 58. Input P1dB vs. RF Frequency over Various LO Drives

UPCONVERTER, IF = 3000 MHz, UPPER SIDEBAND

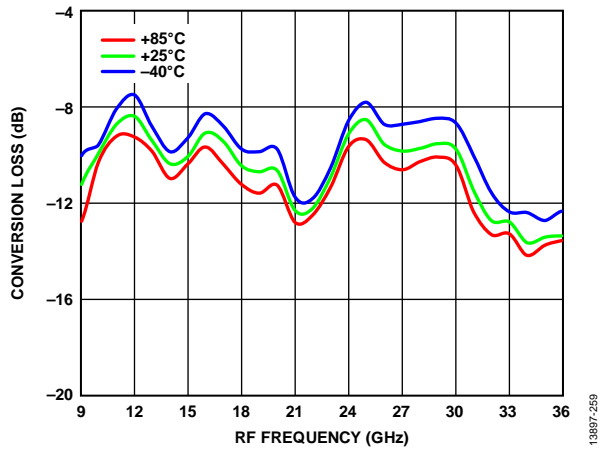

Figure 59. Conversion Loss vs. RF Frequency over Various Temperatures, $P_{LO} = 15 \text{ dBm}$

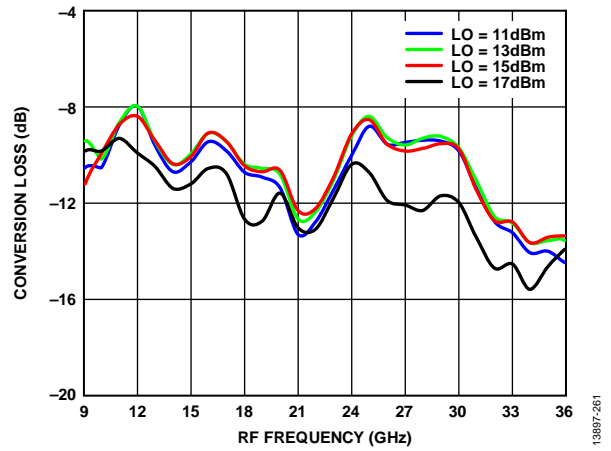

Figure 61. Conversion Loss vs. RF Frequency over LO Drives

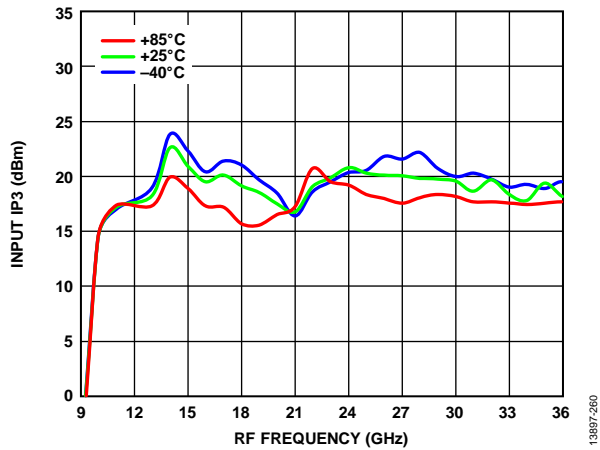

Figure 60. Input IP3 vs. RF Frequency over Various Temperatures, $P_{LO} = 15 \text{ dBm}$

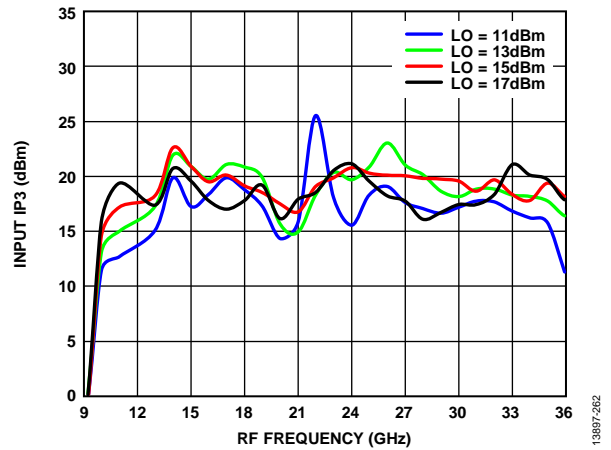

Figure 62. Input IP3 vs. RF Frequency over Various LO Drives

UPCONVERTER, IF = 3000 MHz, LOWER SIDEBAND

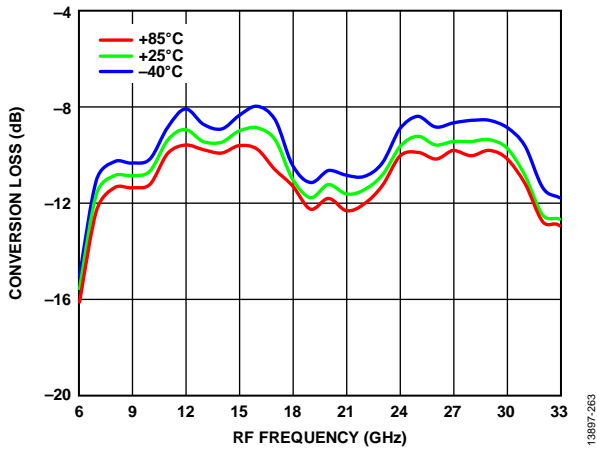

Figure 63. Conversion Loss vs. RF Frequency over Various Temperatures, $P_{LO} = 15 \text{ dBm}$

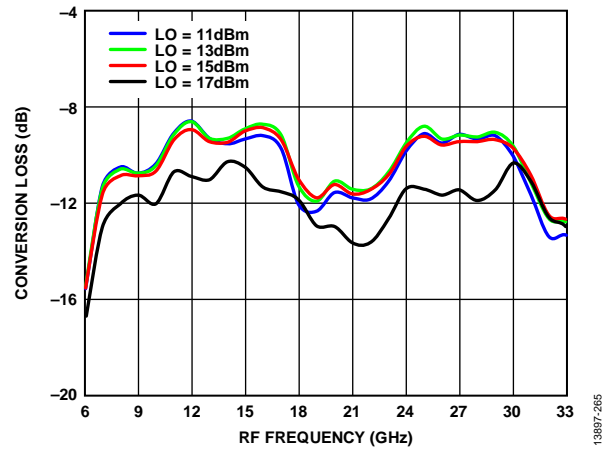

Figure 65. Conversion Loss vs. RF Frequency over LO Drives

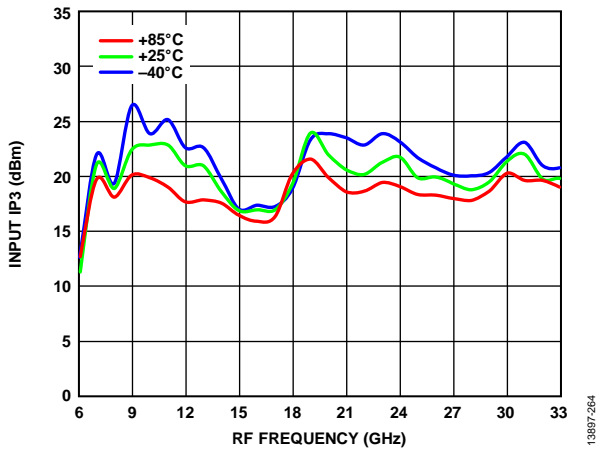

Figure 64. Input IP3 vs. RF Frequency over Various Temperatures, $P_{LO} = 15 \text{ dBm}$

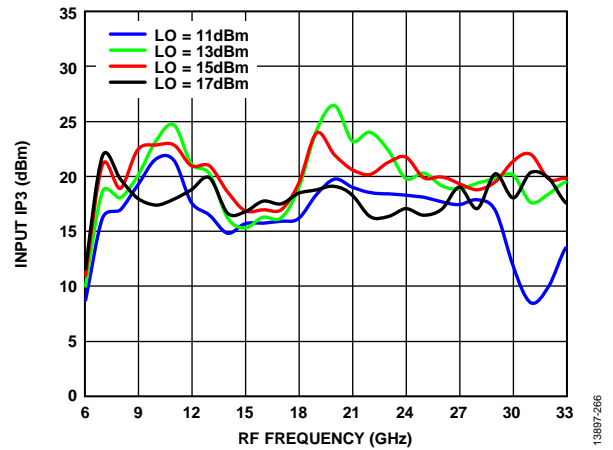

Figure 66. Input IP3 vs. RF Frequency over Various LO Drives

UPCONVERTER, IF = 8000 MHz, UPPER SIDEBAND

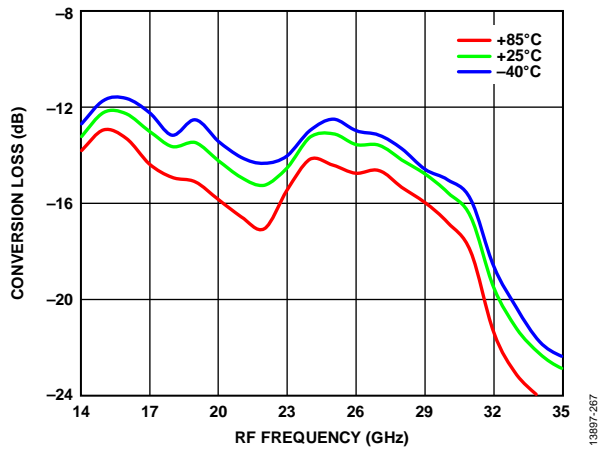

Figure 67. Conversion Loss vs. RF Frequency over Various Temperatures, $P_{LO} = 15 \text{ dBm}$

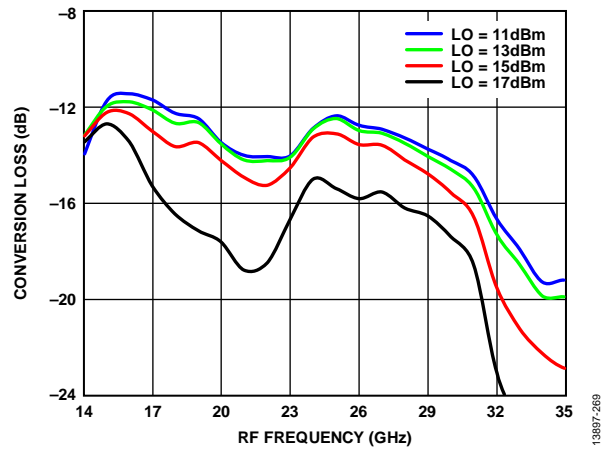

Figure 69. Conversion Loss vs. RF Frequency over LO Drives

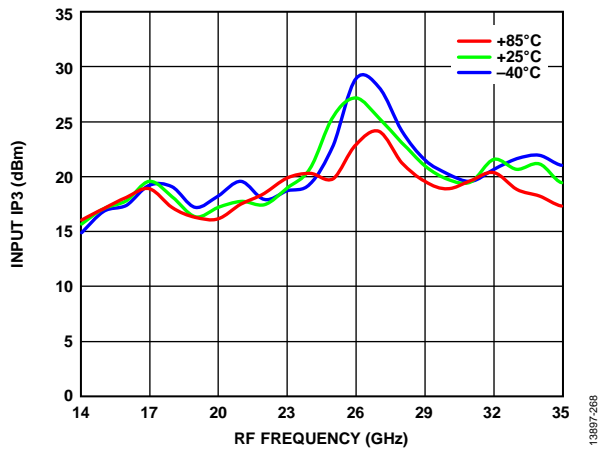

Figure 68. Input IP3 vs. RF Frequency over Various Temperatures, $P_{LO} = 15 \text{ dBm}$

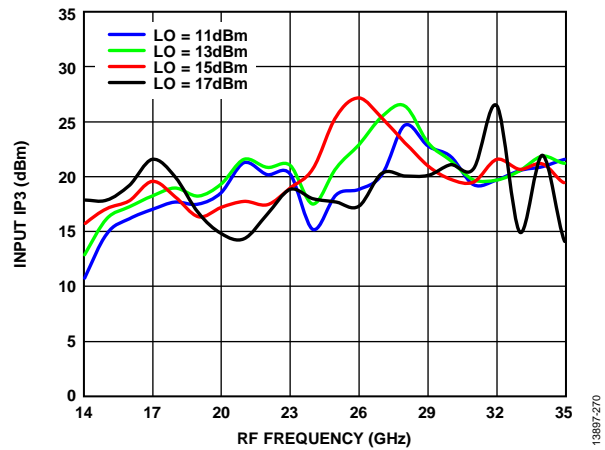

Figure 70. Input IP3 vs. RF Frequency over Various LO Drives

UPCONVERTER, IF = 8000 MHz, LOWER SIDEBAND

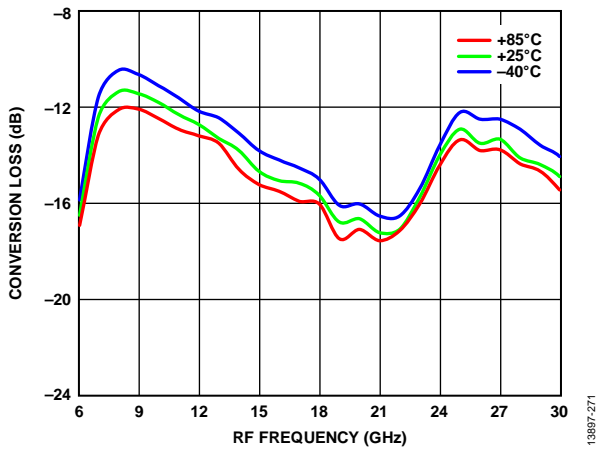

Figure 71. Conversion Loss vs. RF Frequency over Various Temperatures, $P_{LO} = 15 \text{ dBm}$

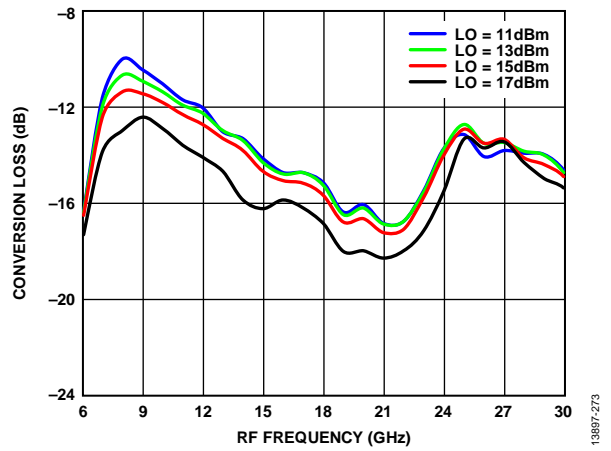

Figure 73. Conversion Loss vs. RF Frequency over LO Drives

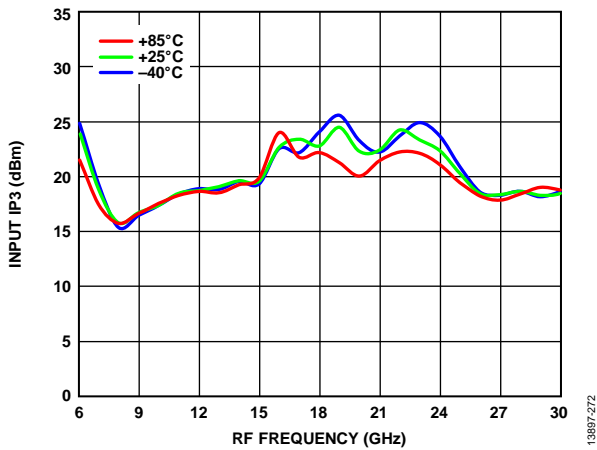

Figure 72. Input IP3 vs. RF Frequency over Various Temperatures, $P_{LO} = 15 \text{ dBm}$

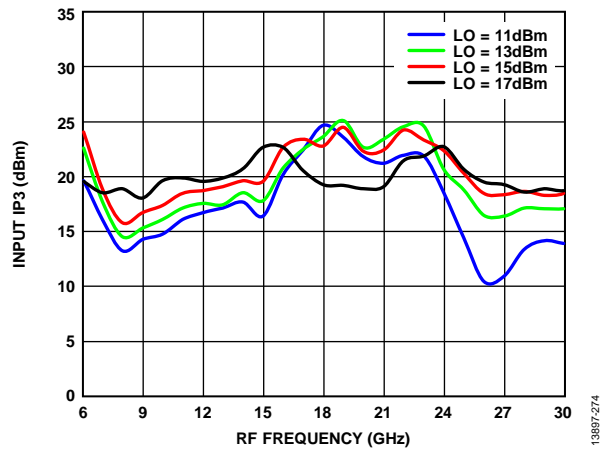

Figure 74. Input IP3 vs. RF Frequency over Various LO Drives

IF BANDWIDTH, LO = 28 GHz, UPPER SIDEBAND

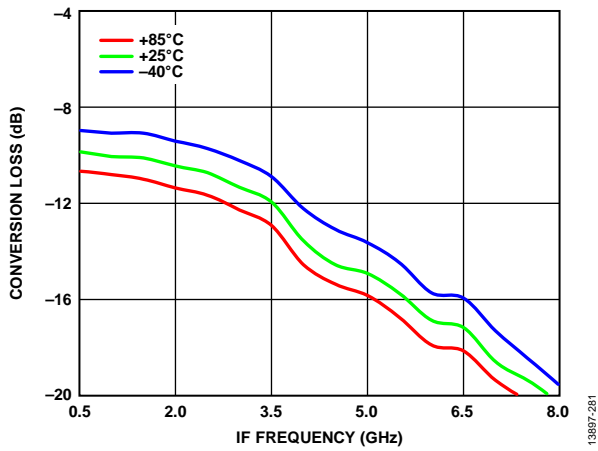

Figure 75. Conversion Loss vs. IF Frequency over Various Temperatures, $P_{LO} = 15 \text{ dBm}$

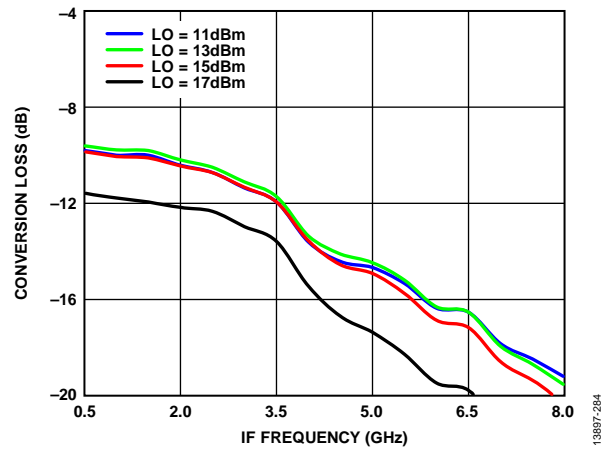

Figure 78. Conversion Loss vs. IF Frequency over Various LO Drives

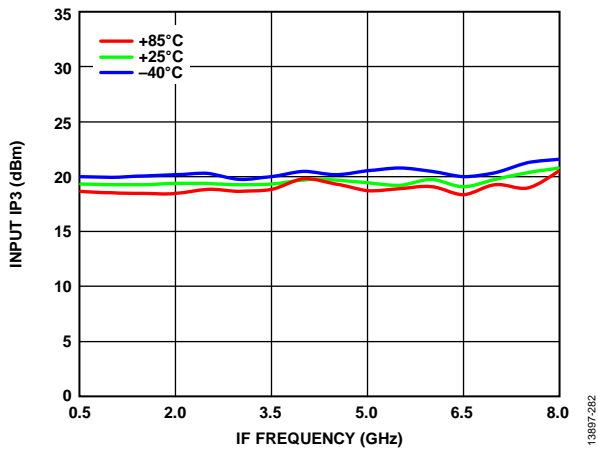

Figure 76. Input IP3 vs. IF Frequency over Various Temperatures, $P_{LO} = 15 \text{ dBm}$

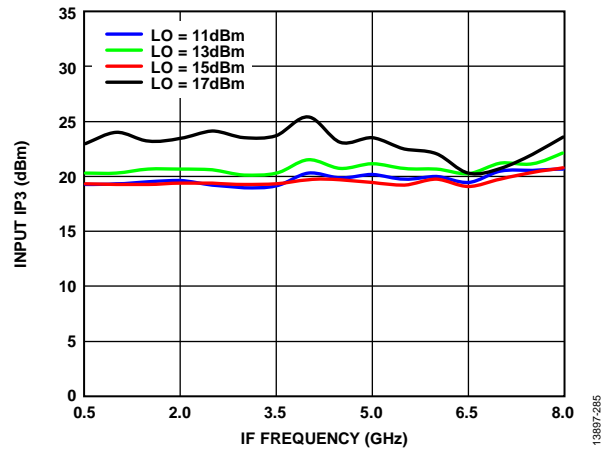

Figure 79. Input IP3 vs. IF Frequency over Various LO Drives

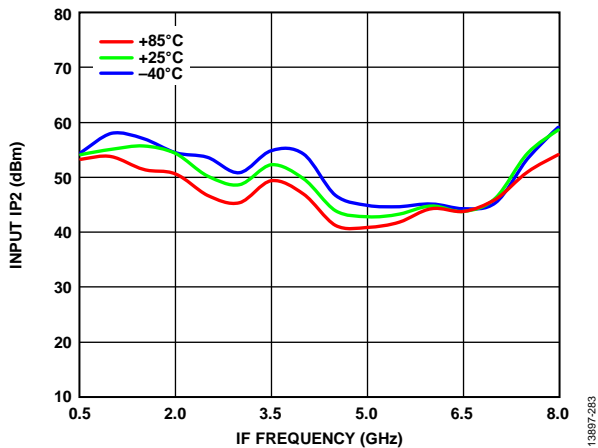

Figure 77. Input IP2 vs. IF Frequency over Various Temperatures, $P_{LO} = 15 \text{ dBm}$

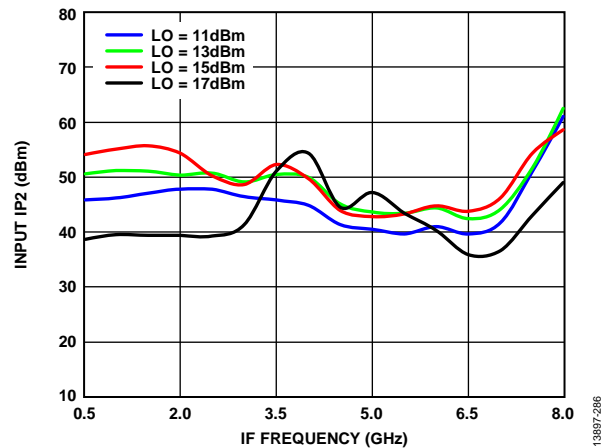

Figure 80. Input IP2 vs. IF Frequency over Various LO Drives

IF BANDWIDTH, LO = 34 GHz, LOWER SIDEBAND

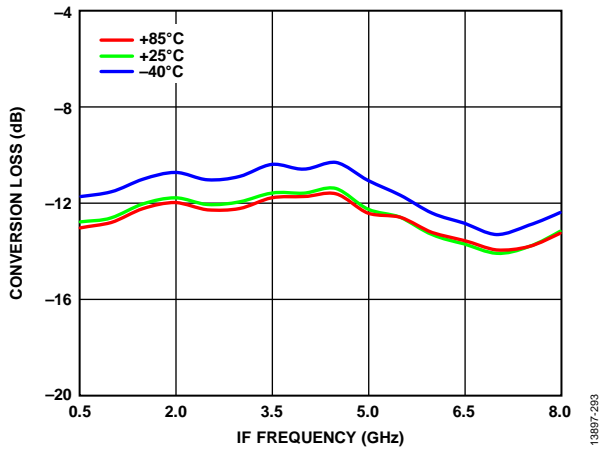

Figure 81. Conversion Loss vs. IF Frequency over Various Temperatures, $P_{LO} = 15 \text{ dBm}$

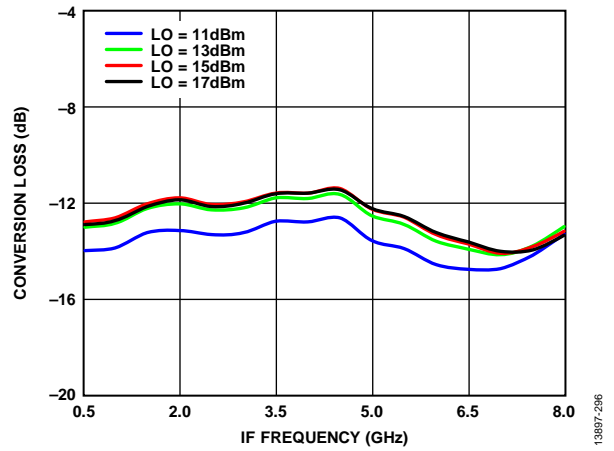

Figure 84. Conversion Loss vs. IF Frequency over Various LO Drives

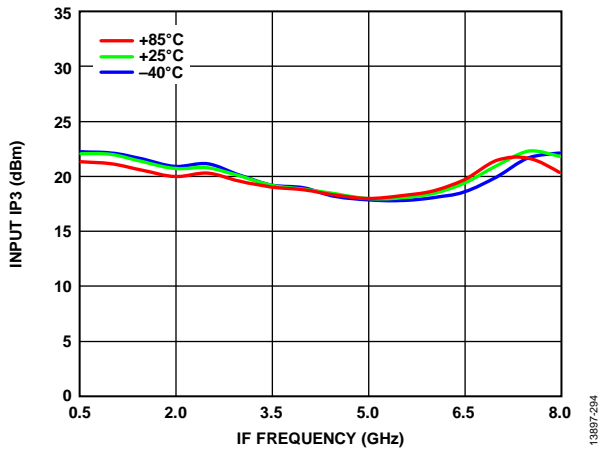

Figure 82. Input IP3 vs. IF Frequency over Various Temperatures, $P_{LO} = 15 \text{ dBm}$

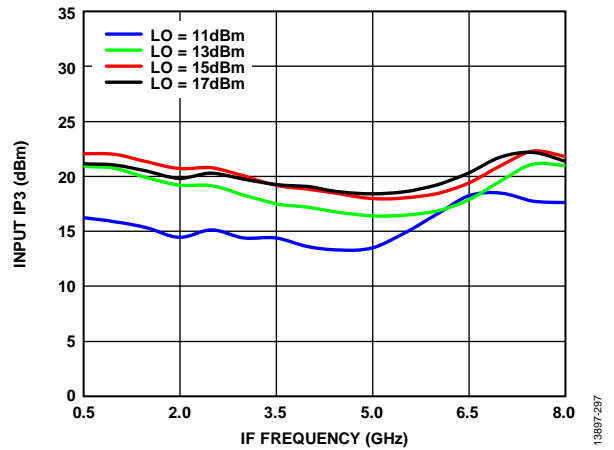

Figure 85. Input IP3 vs. IF Frequency over Various LO Drives

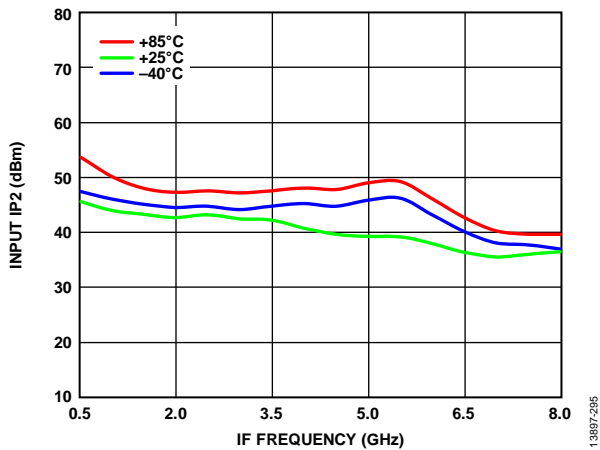

Figure 83. Input IP2 vs. IF Frequency over Various Temperatures, $P_{LO} = 15 \text{ dBm}$

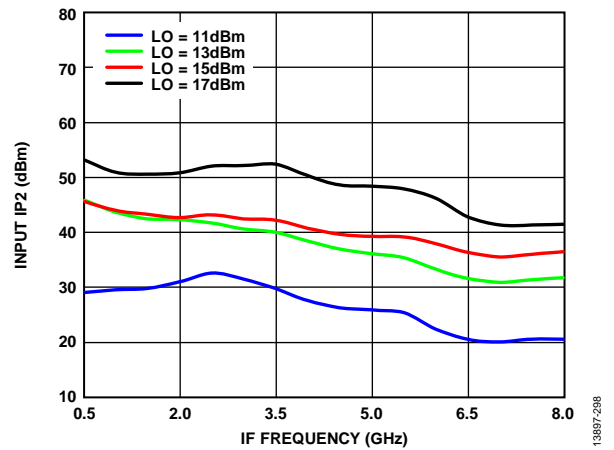

Figure 86. Input IP2 vs. IF Frequency over Various LO Drives

ISOLATION AND RETURN LOSS

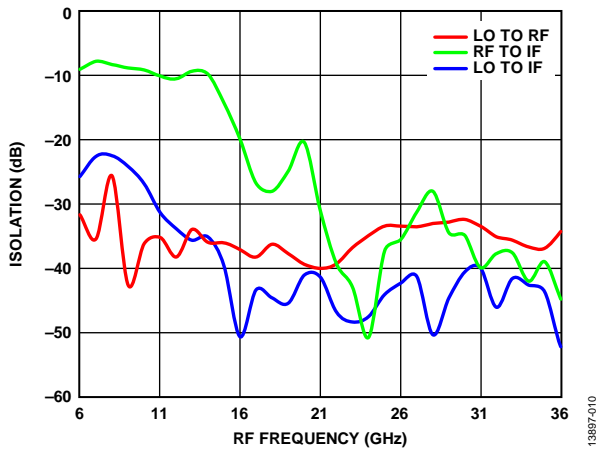

Figure 87. Isolation vs. RF Frequency for Various Isolations

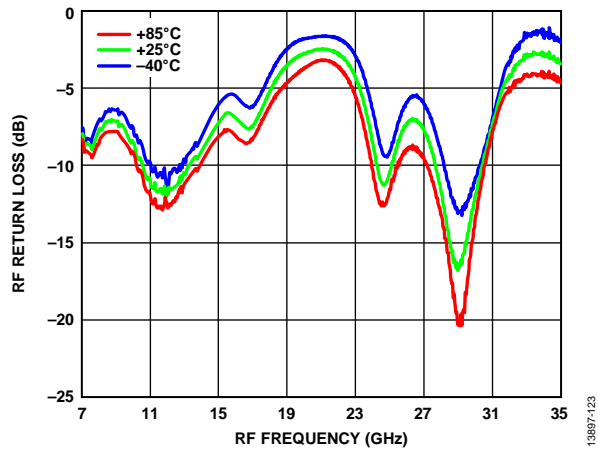

Figure 90. RF Return Loss vs. RF Frequency over Various Temperatures at $f_{LO} = 7 \text{ GHz}$, $P_{LO} = 15 \text{ dBm}$

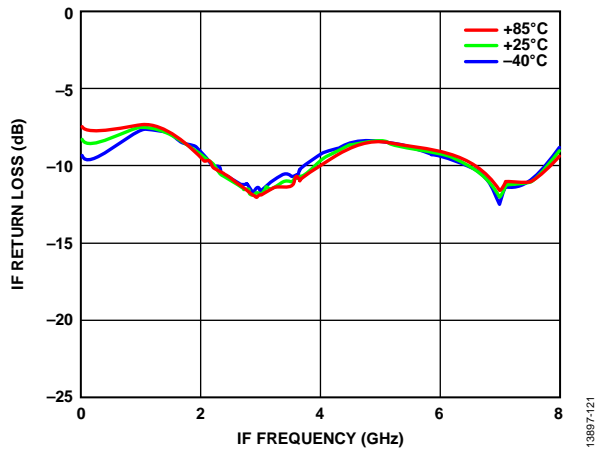

Figure 88. IF Return Loss vs. IF Frequency over Various Temperatures at $f_{LO} = 7 \text{ GHz}$, $P_{LO} = 15 \text{ dBm}$

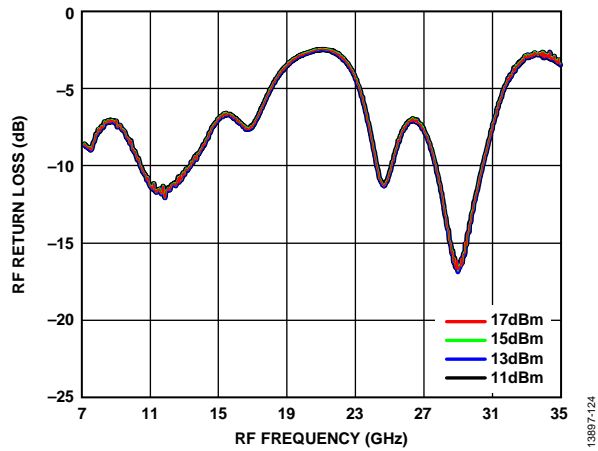

Figure 91. RF Return Loss vs. RF Frequency over Various LO Drives at $f_{LO} = 7 \text{ GHz}$

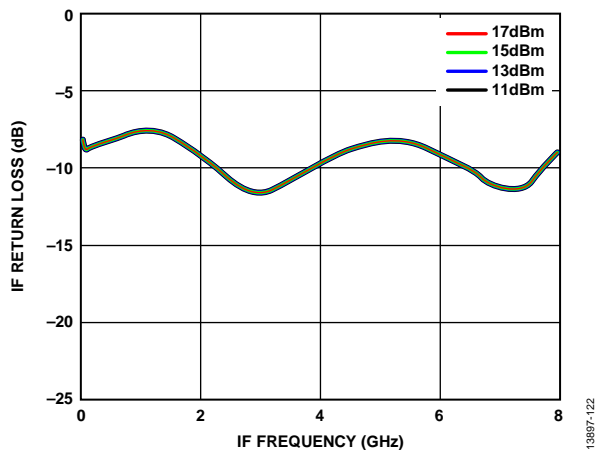

Figure 89. IF Return Loss vs. IF Frequency over Various LO Drives at $f_{LO} = 7 \text{ GHz}$, $T_A = 25^\circ\text{C}$

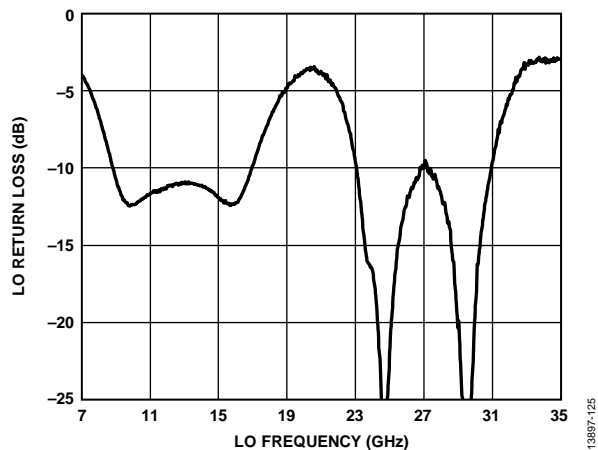

Figure 92. LO Return Loss vs. LO Frequency at $T_A = 25^\circ\text{C}$, $P_{LO} = 15 \text{ dBm}$

SPURIOUS PERFORMANCE

LO Harmonics

When measuring the LO harmonics, the 15 dBm LO input power is applied at various LO frequencies.

All values are in decibels below the LO power level measured at the RF port. N/A means not applicable.

Table 6. LO Frequency vs. N × LO Spur at RF Port

LO Frequency (GHz)	N × LO Spur at RF Port			
	1	2	3	4
8	33	29	50	46
10	41	34	69	47
18	36	59	N/A	N/A
28	32	N/A	N/A	N/A

All values are in decibels below the LO power level measured at the IF port. N/A means not applicable.

Table 7. LO Frequency vs. N × LO Spur at IF Port

LO Frequency (GHz)	N × LO Spur at IF Port			
	1	2	3	4
8	49	73	97	113
10	55	80	100	118
18	68	110	N/A	N/A
28	65	N/A	N/A	N/A

M × N Spurious Outputs

Mixer spurious products are measured in decibels from either below the RF or the IF output power level. N/A means not applicable.

RF = 17.5 GHz at -10 dBm, and LO = 18 GHz at +15 dBm are applied. Spur values are (M × RF) - (N × LO).

		N × LO				
		0	1	2	3	4
M × RF	0	N/A	13	40	N/A	N/A
	1	18	0	54	50	N/A
	2	62	74	63	72	63
	3	N/A	66	75	71	74
	4	N/A	N/A	63	74	86

IF = 0.5 GHz at -10 dBm, and LO = 18 GHz at +15 dBm are applied. Spur values are (M × IF) + (N × LO).

		N × LO				
		0	1	2	3	4
M × IF	-4	86	79	66	N/A	N/A
	-3	88	59	65	N/A	N/A
	-2	67	39	62	N/A	N/A
	-1	38	0	21	N/A	N/A
	0	N/A	2	26	N/A	N/A
	+1	38	0	18	N/A	N/A
	+2	67	40	53	N/A	N/A
	+3	84	65	60	N/A	N/A
	+4	87	77	60	N/A	N/A

THEORY OF OPERATION

The HMC774ALC3B is a general-purpose, double balanced mixer that can be used as an upconverter or a downconverter from 7 GHz to 34 GHz.

When used as a downconverter, the HMC774ALC3B downconverts RF between 7 GHz and 34 GHz to IF between dc and 8 GHz.

When used as an upconverter, the HMC774ALC3B upconverts IF between dc and 8 GHz to RF between 7 GHz and 34 GHz.

APPLICATIONS INFORMATION

EVALUATION BOARD

Figure 93 and Figure 94 show the top and cross sectional views of the evaluation board, which uses 4-layer construction, with a copper thickness of 0.5 oz (0.7 mil) and dielectric materials between each copper layer.

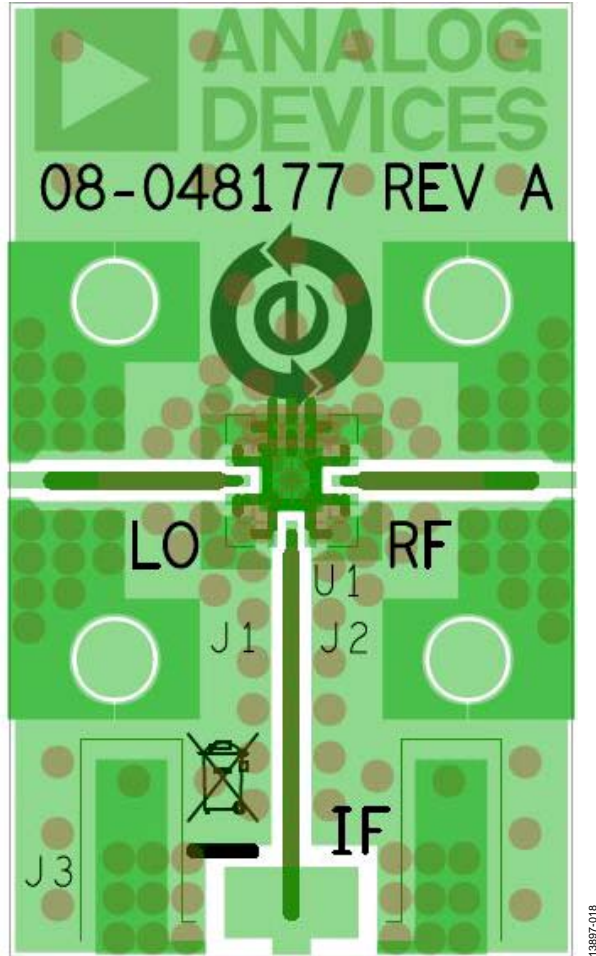

Figure 93. Evaluation Board Layout Top View



Figure 94. Evaluation Board Cross Sectional View

All RF traces are routed on Layer 1, and all other remaining layers are ground planes that provide a solid ground for RF transmission lines. The top dielectric material is Rogers 4350, offering low loss performance. The prepreg material in the middle sticks core layers together, which includes an Isola 370HR layer with copper traces above and below. Both the prepreg material and the Isola 370HR core layer are used to achieve required board finish thickness.

The RF transmission lines are designed using a coplanar waveguide (CPWG) model with a width of 18 mil and ground spacing of 13 mil for a characteristic impedance of 50 Ω. For optimal RF and thermal grounding, as many plated through vias as possible are arranged around the transmission lines and under the exposed pad of the package.

Figure 95 shows the actual EV1HMC774ALC3B evaluation board with component placement. Because the EV1HMC774ALC3B is a passive device, there is no requirement for external components. The LO, RF, and IF pins are internally dc-coupled. Use an external series capacitor when an operation is not required. Choose a value that stays within the necessary frequency range for each port. When an operation to dc is required, do not exceed the source and sink current ratings specified in the Absolute Maximum Ratings section.

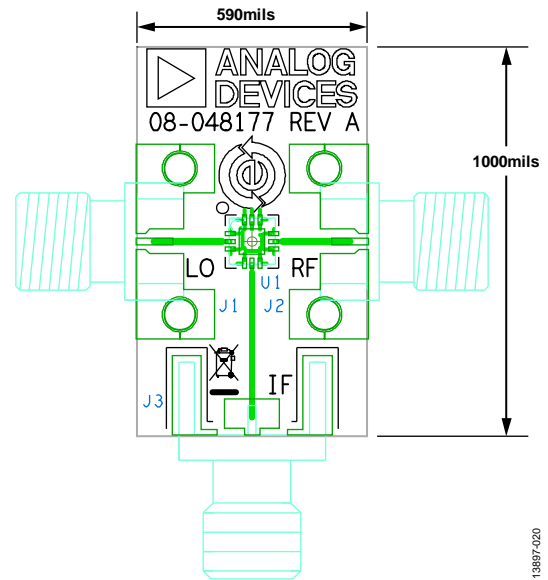

Figure 95. EV1HMC774ALC3B Evaluation Board

The EV1HMC774ALC3B evaluation board shown in Figure 95 is available for order from the Analog Devices, Inc., website at www.analog.com.

Figure 96 shows the Pb-free reflow solder profile.

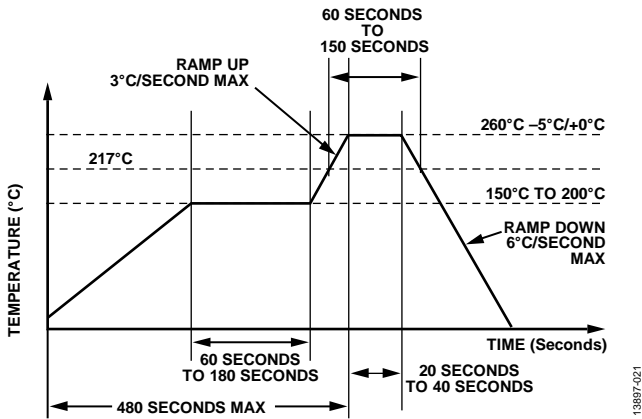

Figure 96. Pb-Free Reflow Solder Profile

Figure 97 shows the evaluation board schematic, and Table 8 lists the bill of materials for the EV1HMC774ALC3B evaluation board shown in Figure 95.

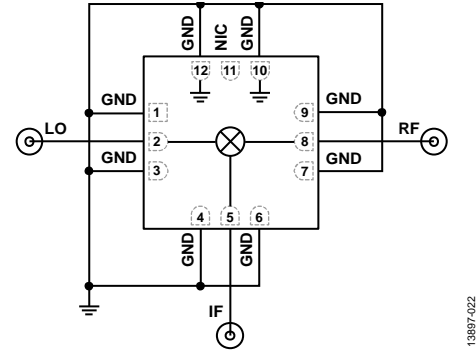

Figure 97. EV1HMC774ALC3B Evaluation Board Schematic

Table 8. Bill of Materials for the EV1HMC774ALC3B Evaluation Board

Component	Description
J1, J2	2.92 mm connector
J3	SMA connector
U1	HMC774ALC3B
PCB ¹	08-048177 Evaluation PCB

¹ 108-047919 is the raw bare PCB identifier. Reference the EV1HMC774ALC3B part number when ordering the complete evaluation PCB.

OUTLINE DIMENSIONS

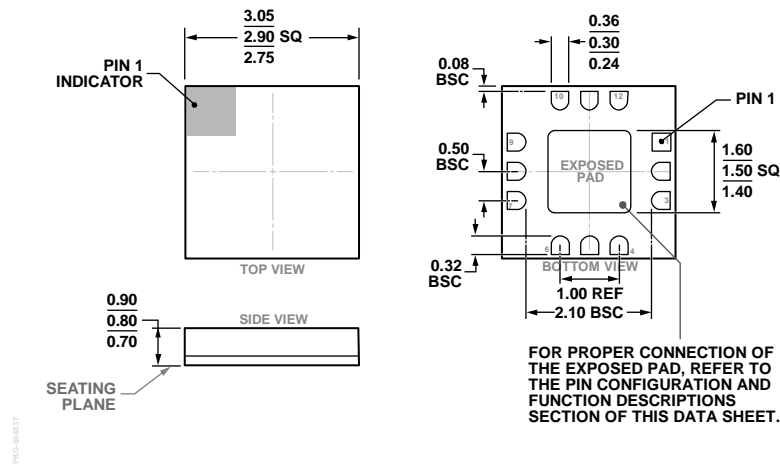

Figure 98. 12-Terminal Ceramic Leadless Chip Carrier [LCC] (E-12-4)
Dimensions shown in millimeters

ORDERING GUIDE

Model ¹	Temperature Range	Moisture Sensitivity Level (MSL) Rating ²	Package Description	Package Option
HMC774ALC3B	-40°C to +85°C	MSL3	12-Terminal Ceramic Leadless Chip Carrier [LCC]	E-12-4
HMC774ALC3BTR	-40°C to +85°C	MSL3	12-Terminal Ceramic Leadless Chip Carrier [LCC]	E-12-4
HMC774ALC3BTR-R5	-40°C to +85°C	MSL3	12-Terminal Ceramic Leadless Chip Carrier [LCC]	E-12-4
EV1HMC774ALC3B			Evaluation PCB Assembly	

¹ All models are RoHS Compliant Parts.

² See Figure 96 for the peak reflow temperature.

Данный компонент на территории Российской Федерации

Вы можете приобрести в компании MosChip.

Для оперативного оформления запроса Вам необходимо перейти по данной ссылке:

<http://moschip.ru/get-element>

Вы можете разместить у нас заказ для любого Вашего проекта, будь то серийное производство или разработка единичного прибора.

В нашем ассортименте представлены ведущие мировые производители активных и пассивных электронных компонентов.

Нашей специализацией является поставка электронной компонентной базы двойного назначения, продукции таких производителей как XILINX, Intel (ex.ALTERA), Vicor, Microchip, Texas Instruments, Analog Devices, Mini-Circuits, Amphenol, Glenair.

Сотрудничество с глобальными дистрибьюторами электронных компонентов, предоставляет возможность заказывать и получать с международных складов практически любой перечень компонентов в оптимальные для Вас сроки.

На всех этапах разработки и производства наши партнеры могут получить квалифицированную поддержку опытных инженеров.

Система менеджмента качества компании отвечает требованиям в соответствии с ГОСТ Р ИСО 9001, ГОСТ РВ 0015-002 и ЭС РД 009

Офис по работе с юридическими лицами:

105318, г.Москва, ул.Щербаковская д.3, офис 1107, 1118, ДЦ «Щербаковский»

Телефон: +7 495 668-12-70 (многоканальный)

Факс: +7 495 668-12-70 (доб.304)

E-mail: info@moschip.ru

Skype отдела продаж:

moschip.ru

moschip.ru_4

moschip.ru_6

moschip.ru_9