

FEATURES/BENEFITS

- Random and zero-cross models available for all applications
- Low zero-cross turn-on voltage
- Input and output protection and control LED standard
- IP20 touch-proof flaps
- Connectors for power wiring and heat sinks available
- Designed in conformity with EN60947-4-3 (IEC947-4-3) and EN60950/VDE0805 (Reinforced Insulation)



IP20 touch-proof flaps

Part No.	Load Voltage	Load Current	Control Voltage	Switch Type
SH24D25	12-275 Vac	25A	3-32 Vdc	Zero Cross
SH24A25	12-275 Vac	25A	20-265 Vac/dc	Zero Cross
SH24D35	12-275 Vac	35A	3-32 Vdc	Zero Cross
SH24A35	12-275 Vac	35A	20-265 Vac/dc	Zero Cross
SH24D50	12-275 Vac	50A	3-32 Vdc	Zero Cross
SH24R50	12-275 Vac	50A	3-32 Vdc	Random
SH24R75	12-275 Vac	75A	3-32 Vdc	Random
SH24D75	12-275 Vac	75A	3-32 Vdc	Zero Cross
SH24D95	12-275 Vac	95A	3-32 Vdc	Zero Cross
SH24D125	12-275 Vac	125A	3-32 Vdc	Zero Cross
SH48R35	24-510 Vac	35A	3.5-32 Vdc	Random
SH48D35	24-510 Vac	35A	3.5-32 Vdc	Zero Cross
SH48A35	24-510 Vac	35A	20-265 Vac/dc	Zero Cross
SH48R50	24-510 Vac	50A	3.5-32 Vdc	Random
SH48D50	24-510 Vac	50A	3.5-32 Vdc	Zero Cross
SH48A50	24-510 Vac	50A	20-265 Vac/dc	Zero Cross
SH48R75	24-510 Vac	75A	3.5-32 Vdc	Random
SH48D75	24-510 Vac	75A	3.5-32 Vdc	Zero Cross
SH48A75	24-510 Vac	75A	20-265 Vac/dc	Zero Cross
SH48R95	24-510 Vac	95A	3.5-32 Vdc	Random
SH48D95	24-510 Vac	95A	3.5-32 Vdc	Zero Cross
SH48A95	24-510 Vac	95A	20-265 Vac/dc	Zero Cross
SH48R125	24-510 Vac	125A	3.5-32 Vdc	Random
SH48D125	24-510 Vac	125A	3.5-32 Vdc	Zero Cross
SH48A125	24-510 Vac	125A	20-265 Vac/dc	Zero Cross
SH60D50	24-690 Vac	50A	3.5-32 Vdc	Zero Cross
SH60D75	24-690 Vac	75A	3.5-32 Vdc	Zero Cross
SH60D95	24-690 Vac	95A	3.5-32 Vdc	Zero Cross
SH60D125	24-690 Vac	125A	3.5-32 Vdc	Zero Cross

TYPICAL APPLICATION

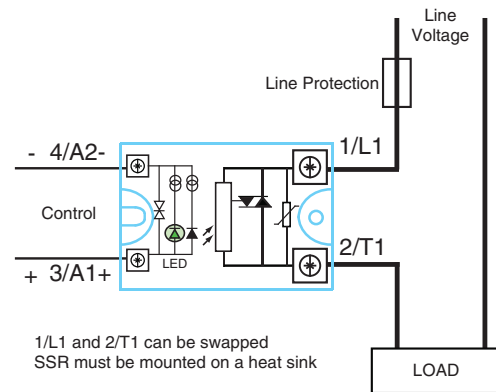

Figure 1a — SHXXDXX relays

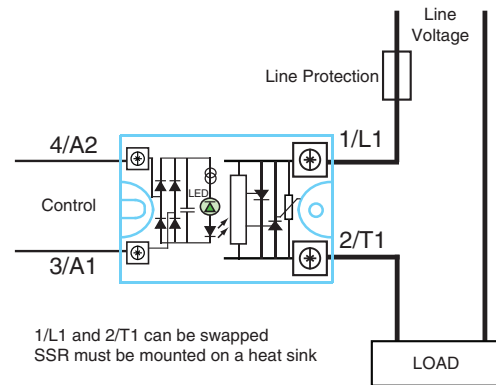

Figure 1b — SHXXAXX relays



Figure 1c — SHXXRXX relays

ELECTRICAL SPECIFICATIONS
(+25°C ambient temperature unless otherwise specified)

INPUT (CONTROL) SPECIFICATIONS

	Min	Max	Units
Input Current Range			
SHXXR/D (except SH60)	10	13	mA
SHXXA	5	10	mA
SH60		12	mA
Must Turn-Off Voltage			
SHXXR/D		2.0	Vdc
SHXXA		5.0	Vdc
Reverse Voltage Protection (R/D)			
		32	V
Clamping Voltage (R/D)			
		36	V
Input Immunity (EN61000-4-4)			
		2	kV
Input Immunity (EN61000-4-5)			
		2	kV

MECHANICAL SPECIFICATION



Dimensions in inches (mm)
Weight: 2.82 oz. (80g)

Figure 2

CONTROL CHARACTERISTICS

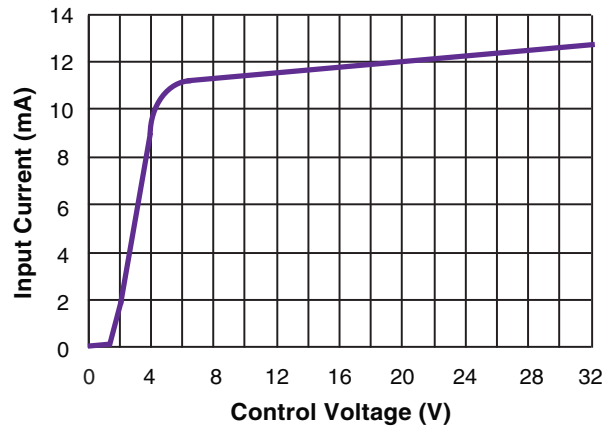

Figure 3a — SH24R/D, SH48R/D relays

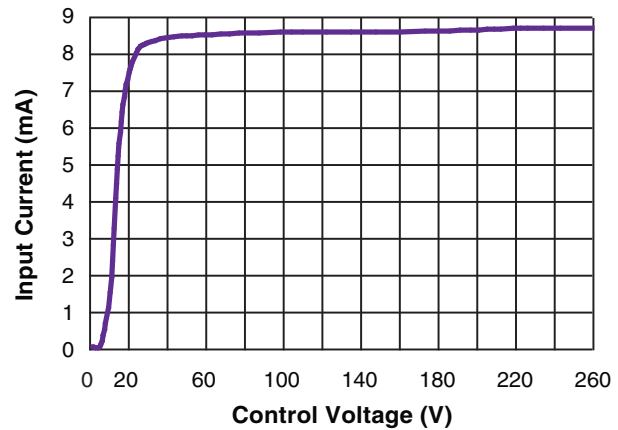

Figure 3b — SH24A, SH48A relays

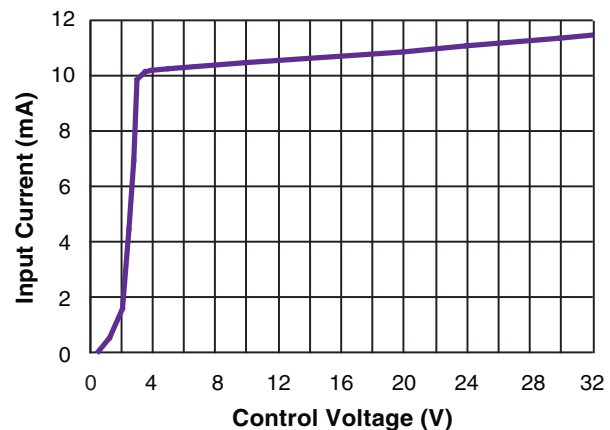

Figure 3c — SH60D relays

ELECTRICAL SPECIFICATIONS (+25°C ambient temperature unless otherwise specified)			
OUTPUT (LOAD) SPECIFICATIONS			
	Min	Max	Units
Peak Voltage (VDR Clamping)			
SH24	(450)	600	V _{peak}
SH48	(950)	1200	V _{peak}
SH60		1600	V _{peak}
Load Current Range (Resistive)			
25 output current	.005	25	Arms
35 output current	.005	40	Arms
50 output current	.005	60	Arms
75 output current	.005	90	Arms
95 output current	.005	110	Arms
125 output current	.005	150	Arms
Maximum Surge Current Rating (Non-Repetitive)			
25 output current		350	A
35 output current		500	A
50 output current		720	A
75 output current		1200	A
95 output current		1700	A
125 output current		2200	A
On-State Voltage Drop			
		0.9	V
Output Power Dissipation (Max)			
25 output current	0.9x0.9xI + 0.016xI ² W		
35 output current	0.9x0.9xI + 0.015xI ² W		
50 output current	0.9x0.9xI + 0.012xI ² W		
75 output current	0.9x0.9xI + 0.0045xI ²		W
95 output current	0.9x0.9xI + 0.0035xI ²		W
125 output current	0.9x0.9xI + 0.002xI ² W		
Zero-Cross Window (Typical)			
SHXXR		NA	
SHXXD/A		±12	Vac
Off-State Leakage Current			
SHXXR		3	mA
SHXXD/A		1	mA
Turn-On Time (60 Hz)			
SHXXR		0.04	ms
SHXXD		8.3	ms
SHXXA		24.9	ms
Turn-Off Time (60 Hz)			
SHXXR/D		8.3	ms
SHXXA		24.9	ms
Off-State dv/dt			
		500	V/μs
Maximum di/dt (Non-Repetitive)			
		50	A/μs
Operating Frequency			
SHXXR	0.1	400	Hz
SHXXD/A	0.1	800	Hz
I²t for fuse matching (<10ms)			
25 output current		600	A ² s
35 output current		1250	A ² s
50 output current		2500	A ² s
75 output current		7200	A ² s
95 output current		14400	A ² s
125 output current		24000	A ² s
Junction-Case Thermal Resistance			
25 output current		1.7	°C/W
35 output current		0.6	°C/W
50 output current		0.45	°C/W
75 output current		0.4	°C/W
95 output current		0.3	°C/W
125 output current		0.25	°C/W
Conducted Immunity Level			
IEC/EN61000-4-4 (bursts)			
SH24		2kV criterion A	
SH48/SH60		4kV criterion A	
IEC/EN61000-4-5 (surge)			
SH24		2kV criterion A	
SH48		4kV criterion A	
SH60		4kV criterion A (with external VDR)	



Figure 4a — 25A output current



Figure 4b — 35A output current



Figure 4c — 50A output current



Figure 4d — 75A output current



Figure 4e — 95A output current

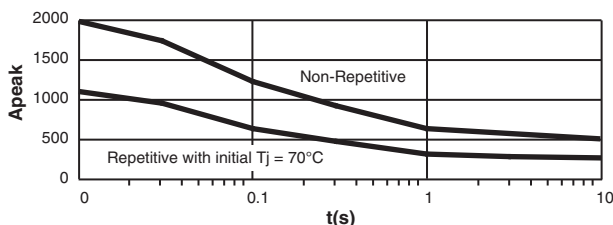

Figure 4f — 125A output current

GENERAL SPECIFICATIONS
(+25°C ambient temperature unless otherwise specified)

ENVIRONMENTAL SPECIFICATIONS

	Min	Max	Units
Operating Temperature			
Up to 35 output current	-55	+80	°C
Above 35 output current	-40	+80	°C

Storage Temperature			
Up to 35 output current	-55	+125	°C
Above 35 output current	-40	+125	°C

Ambient Humidity		40 to 85	%
------------------	--	----------	---

Input-Output Isolation	4000		Vrms
------------------------	------	--	------

Output-Case Isolation	4000		Vrms
-----------------------	------	--	------

Insulation Resistance @500Vdc	1000		MΩ
----------------------------------	------	--	----

Rated Impulse Voltage		4000	V
-----------------------	--	------	---

Protection Level (CEI529)		IP20	
---------------------------	--	------	--

Vibration (10–55 Hz according to CEI68)		1.5	mm
---	--	-----	----

Shock (according to CD168)		30/50	g
----------------------------	--	-------	---

Housing Material	PA6 UL94VO		
------------------	------------	--	--

Baseplate	Aluminum, nickel-plated		
-----------	-------------------------	--	--

THERMAL CURVES



Figure 5a — 25A output power



Figure 5b — 35A output power

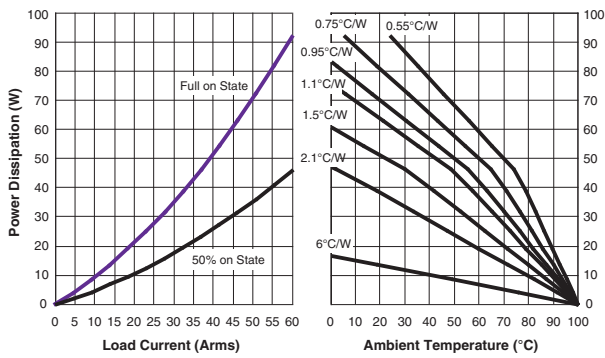

Figure 5c — 50A output power

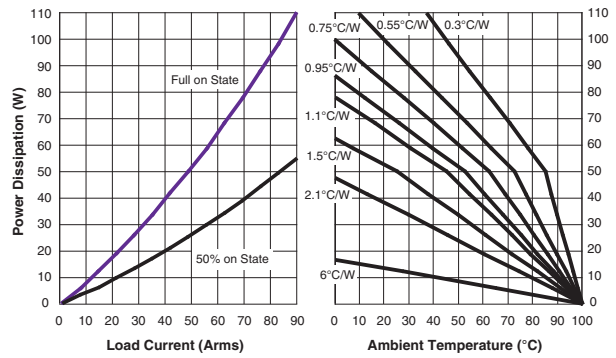

Figure 5d — 75A output power

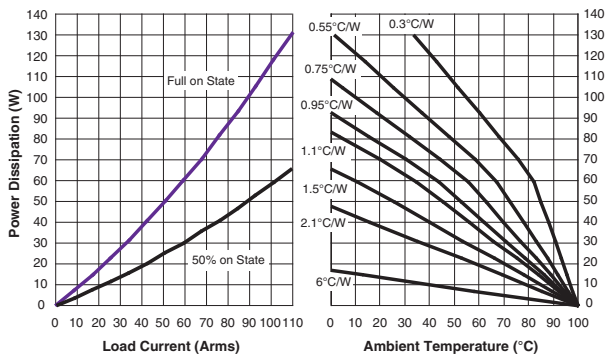

Figure 5e — 95A output power

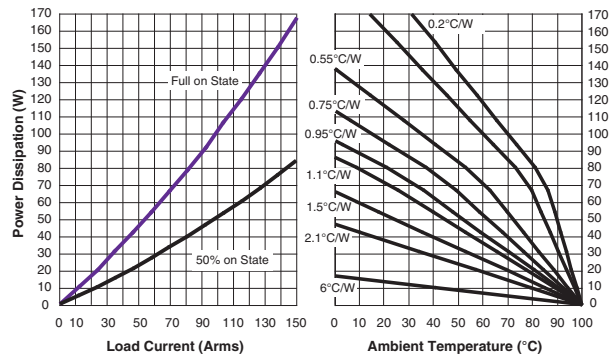

Figure 5f — 125A output power

12°C/W corresponds to a relay without heat sink
6°C/W corresponds to a relay mounted on a DIN-rail adaptor (Teledyne P/N DL12)

OPTIONAL CONNECTIONS



Directly with wires,
with or without ferrules



With tips
(ring terminals)







With special adaptation for
high-voltage relays

CONTROL WIRING

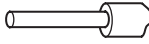
Number of Wires				Screwdriver Type	Recommended Torque
1		2			
Solid (no ferrule)	Fine Stranded (with ferrule)	Solid (no ferrule)	Fine Stranded (with ferrule)		N.m
					
AWG18...AWG14	AWG18...AWG14	AWG18...AWG14	AWG18...AWG14		

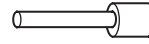
POWER WIRING

Number of Wires				Screwdriver Type	Recommended Torque
1		2			
Solid (no ferrule)	Fine Stranded (with ferrule)	Solid (no ferrule)	Fine Stranded (with ferrule)		N.m
					
AWG16...AWG8	AWG16...AWG10	AWG16...AWG8	AWG16...AWG10		

Power with tips



Options

Fastons: Call us



Special kit for high current

AWG2 / 35mm²



AWG0 / 50mm²



 2–2.5°C/W
Teledyne P/N FW151

 1.1°C/W
Teledyne P/N FW108

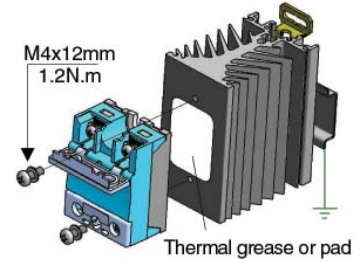
 0.3°C/W
Teledyne P/N FW031

Thermal grease or pad

 DIN Rail Adapter
Teledyne P/N DL12

Mounting
HIPpak SSRs must be mounted on heat sinks. A large range of heat sinks is available. For heat-sink mounting, use thermal grease or a thermal pad with high conductivity specified by Teledyne.

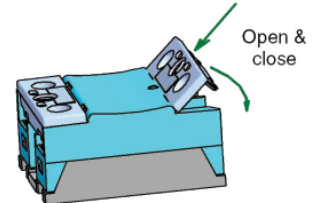
 Thermal Pad
Teledyne P/N –12

Removable IP20 touch-proof

Typical Loads (Random)

SH relays with random turn-on are designed for high inductive loads or phase angle control applications.

Our data sheet lists nominal current of power thyristors corresponding to a resistive load (AC-51).

Depending on the loads, check the inrush current at turn ON and possible overvoltages at turn OFF.

Main applications:

- AC-55b — Incandescent or infrared lamps. Inrush current is generally 10 times I_n during few 10ms. Random relays often use in-phase angle controllers or soft-starters with the right control.
- AC-53 — Three-phase motors. 2 or 3 random turn-on relays can drive such motors.
- AC-56a — Transformer loads. Very high inrush current up to 100 times I_n . Use a random turn-on SSR like the SH.

The table below lists recommended current values for proper lifetime expectancy.

SSR Model	AC-53 Current (motor)	AC-55b Current (lamp)	AC-55b Current (transformer)	AC-55b Current (capacitor)
12A	2.5A	2.5A	0.4A	XXX
25A	5A	5A	1A	XXX
35A	9A	9A	2A	XXX
50A	12A	12A	3A	13A
75A	16A	16A	6A	24A
95A	24A	24A	9A	36A
125A	32A	32A	12A	48A

Typical Loads (Zero-Cross)

SH relays with zero-cross turn-on are designed for most types of loads.

Our data sheet lists the AC-51 current value corresponding to resistive loads.

For other loads, check the inrush current at turn ON and possible overvoltages at turn OFF:

- AC-55b — Incandescent lamps. Inrush current is generally 10 times I_n during few 10ms.
- AC-55a — Electric discharge lamp. These loads often have overcurrent at turn ON and overvoltage at turn OFF, so use 400VAC SSR on 230VAC mains.
- AC-58 — One-pole motors. These loads often have overcurrent at turn ON and overvoltage at turn OFF, so use 400VAC SSR on 230VAC mains and adapt the SSR current to the starting current of the motor.
- AC-53 — Three-phase motors. 2 or 3 SH zero-cross relays can drive these motors, but generally use E3P/E3PT or other three-phase relays or SH random range.
- AC-56a — Transformer loads. Very high inrush current up to 100 times I_n . Use SH random relay or peak control SSR.
- AC-56b — Capacitor loads with very high current at turn ON and overvoltage at turn OFF. Our high-voltage relays are well adapted for high inrush current.

Protection

- To protect the SSR against a short-circuit of the load, use a fuse with a I^2t value = $1/2 I^2t$ value specified.

EMC

Immunity:

- Our data sheets list the immunity level of our SSRs according to the main standards for these products: IEC/EN61000-4-4 and IEC/EN61000-4-5. You can compare the high immunity level with other products on the market.

Emission:

- Teledyne SSRs are designed in compliance with standards for class A equipment (Industry).
- Use of this product in domestic environments may cause radio interference. In this case the user may be required to employ additional devices to reduce noise. SSRs are complex devices that must be interconnected with other equipment (loads, cables, etc.) to form a system. Because the other equipment or interconnections may not be under Teledyne's control, it shall be the responsibility of the system integrator to ensure that systems containing SSRs comply with the requirement of any rules and regulations applicable at the system level.
- In phase angle applications, a filter adapted to the load must be necessary.
- The very low zero-cross voltage of SH relays (<12V) improves the conducted emission level in comparison with most other SSRs on the market with zero-cross voltages often higher than 50V.

Данный компонент на территории Российской Федерации

Вы можете приобрести в компании MosChip.

Для оперативного оформления запроса Вам необходимо перейти по данной ссылке:

<http://moschip.ru/get-element>

Вы можете разместить у нас заказ для любого Вашего проекта, будь то серийное производство или разработка единичного прибора.

В нашем ассортименте представлены ведущие мировые производители активных и пассивных электронных компонентов.

Нашей специализацией является поставка электронной компонентной базы двойного назначения, продукции таких производителей как XILINX, Intel (ex.ALTERA), Vicor, Microchip, Texas Instruments, Analog Devices, Mini-Circuits, Amphenol, Glenair.

Сотрудничество с глобальными дистрибьюторами электронных компонентов, предоставляет возможность заказывать и получать с международных складов практически любой перечень компонентов в оптимальные для Вас сроки.

На всех этапах разработки и производства наши партнеры могут получить квалифицированную поддержку опытных инженеров.

Система менеджмента качества компании отвечает требованиям в соответствии с ГОСТ Р ИСО 9001, ГОСТ РВ 0015-002 и ЭС РД 009

Офис по работе с юридическими лицами:

105318, г.Москва, ул.Щербаковская д.3, офис 1107, 1118, ДЦ «Щербаковский»

Телефон: +7 495 668-12-70 (многоканальный)

Факс: +7 495 668-12-70 (доб.304)

E-mail: info@moschip.ru

Skype отдела продаж:

moschip.ru

moschip.ru_4

moschip.ru_6

moschip.ru_9