

25V NPN SILICON PLANARR MEDIUM POWER TRANSISTOR

Features

- $BV_{CEO} > 25V$
- Maximum Continuous Current $I_{C(cont)} = 4A$
- Up to 20A Peak Current
- Low Saturation Voltage
- $P_D = 1W$
- **Lead-Free Finish; RoHS compliant (Note 1 & 2)**
- **Halogen and Antimony Free. "Green" Device (Note 3)**
- **Qualified to AEC-Q101 Standards for High Reliability**

Mechanical Data

- Case: E-Line (TO-92 Compatible)
- UL Flammability Rating 94V-0
- Moisture Sensitivity: Level 1 per J-STD-020
- Terminals: Matte Tin Finish
- Weight: 0.159 grams (approximate)

Applications

- LED Backlight Converters
- Emergency Lighting
- DC-DC Converters

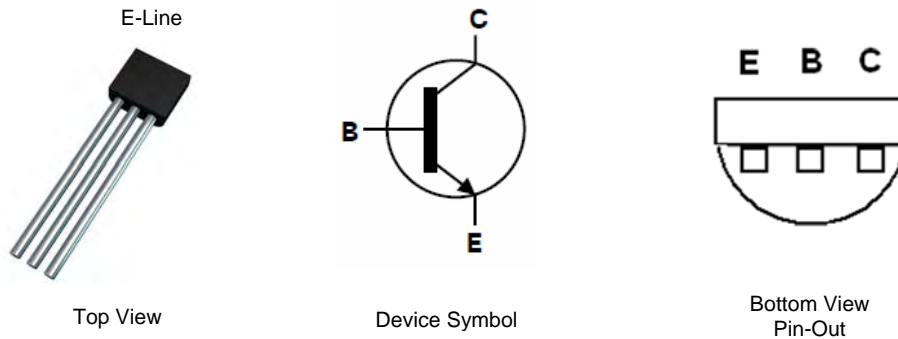

Ordering Information (Note 4)

Part Number	Marking	Case	Quantity
ZTX1049ASTZ	ZTX1049A	E-Line	2,000 per box on tape
ZTX1049A	ZTX1049A	E-Line	4,000 loose

- Notes:
1. EU Directive 2002/95/EC (RoHS) & 2011/65/EU (RoHS 2) compliant. All applicable RoHS exemptions applied.
 2. See <http://www.diodes.com> for more information about Diodes Incorporated's definitions of Halogen and Antimony free, "Green" and Lead-Free.
 3. Halogen and Antimony free "Green" products are defined as those which contain <900ppm bromine, <900ppm chlorine (<1500ppm total Br + Cl) and <1000ppm antimony compounds.
 4. For packaging details, go to our website at <http://www.diodes.com>.

Marking Information

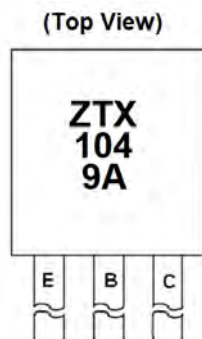

ZTX1049A = Product type Marking Code

Maximum Ratings (@T_A = +25°C, unless otherwise specified.)

Characteristic	Symbol	Value	Unit
Collector-Base Voltage	V _{CB0}	80	V
Collector-Emitter Voltage	V _{CEO}	25	V
Emitter-Base Voltage	V _{EBO}	5	V
Continuous Collector Current	I _C	4	A
Peak Pulse Current	I _{CM}	20	A
Base Current	I _B	500	mA

Thermal Characteristics

Characteristic	Symbol	Value	Unit
Power Dissipation (Note 5)	P _D	1	W
Thermal Resistance, Junction to Ambient (Note 5)	R _{θJA}	175	°C/W
Thermal Resistance, Junction to Leads	R _{θJL}	63.75	°C/W
Operating and Storage Temperature Range	T _J , T _{STG}	-55 to +200	°C

Notes: 5. For devices mounted in a typical manner on a P.C.B. with copper equal to 1 inch square minimum.

Thermal Characteristics

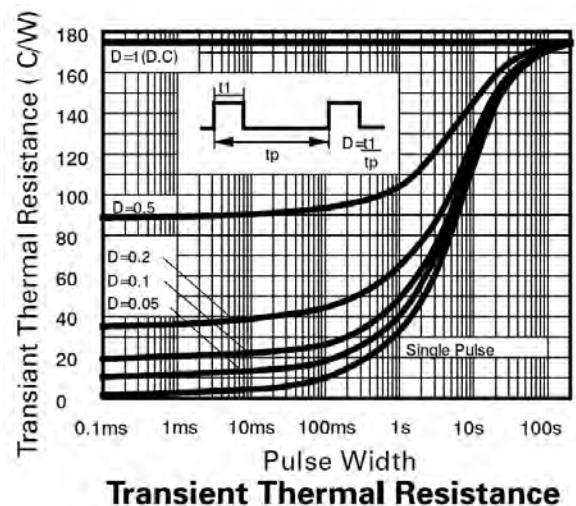
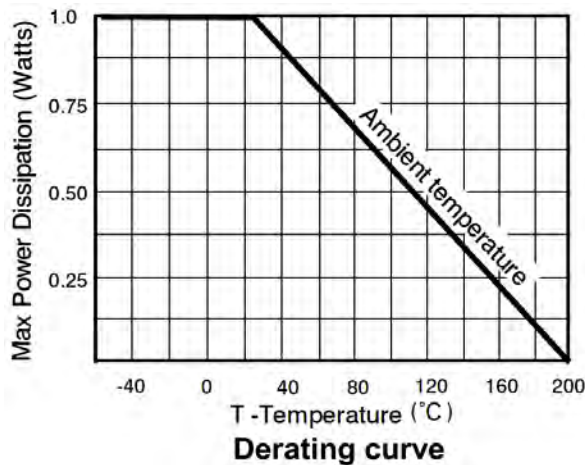

Electrical Characteristics (@T_A = +25°C, unless otherwise specified.)

Characteristic	Symbol	Min	Typ	Max	Unit	Test Condition
Collector-Base Breakdown Voltage	BV _{CBO}	80	120	—	V	I _C = 100μA
Collector-Emitter Breakdown Voltage	BV _{CES}	80	120	—	V	I _C = 100μA
Collector-Emitter Breakdown Voltage	BV _{CEO}	25	30	—	V	I _C = 10mA
Collector-Emitter Breakdown Voltage	BV _{CEV}	80	120	—	V	I _C = 100μA, V _{EB} = 1V
Emitter-Base Breakdown Voltage	BV _{EBO}	5	8.75	—	V	I _E = 100μA
Collector Cut-off Current	I _{CBO}	—	0.3	10	nA	V _{CB} = 50V
Collector Emitter Cut-off Current	I _{CES}	—	0.3	10	nA	V _{CES} = 50V
Emitter Cut-off Current	I _{EBO}	—	0.3	10	nA	V _{EB} = 4V
Collector-Emitter Saturation Voltage (Note 6)	V _{CE(sat)}	—	30 60 125 155	45 80 180 220	mV	I _C = 500mA, I _B = 10mA I _C = 1A, I _B = 10mA I _C = 2A, I _B = 10mA I _C = 4A, I _B = 50mA
Base-Emitter Saturation Voltage (Note 6)	V _{BE(sat)}	—	890	950	mV	I _C = 4A, I _B = 50mA
Base-Emitter Turn-On Voltage (Note 6)	V _{BE(on)}	—	820	900	mV	I _C = 4A, V _{CE} = 2V
DC Current Gain (Note 6)	h _{FE}	250 300 300 200 35	430 450 450 350 70	— — 1200 — —	—	I _C = 10mA, V _{CE} = 2V I _C = 0.5A, V _{CE} = 2V I _C = 1A, V _{CE} = 2V I _C = 4A, V _{CE} = 2V I _C = 20A, V _{CE} = 2V
Current Gain-Bandwidth Product (Note 6)	f _T	—	180	—	MHz	V _{CE} = 10V, I _C = 50mA f = 50MHz
Output Capacitance (Note 6)	C _{obo}	—	45	60	pF	V _{CB} = 10V, f = 1MHz
Turn-On Times	t _{on}	—	125	—	ns	I _C = 4A, I _B = 40mA, V _{CC} = 10V
Turn-Off Times	t _{off}	—	380	—	ns	I _C = 4A, I _B = 40mA, V _{CC} = 10V

Notes: 6. Measured under pulsed conditions. Pulse width ≤ 300 μs. Duty cycle ≤ 2%

Typical Characteristics

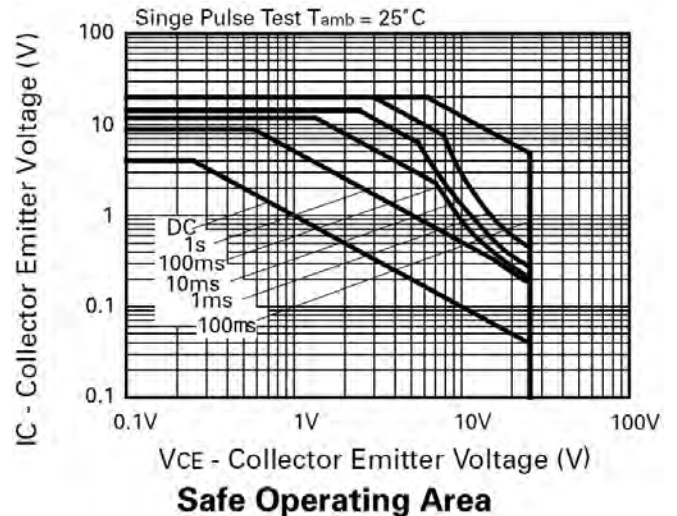
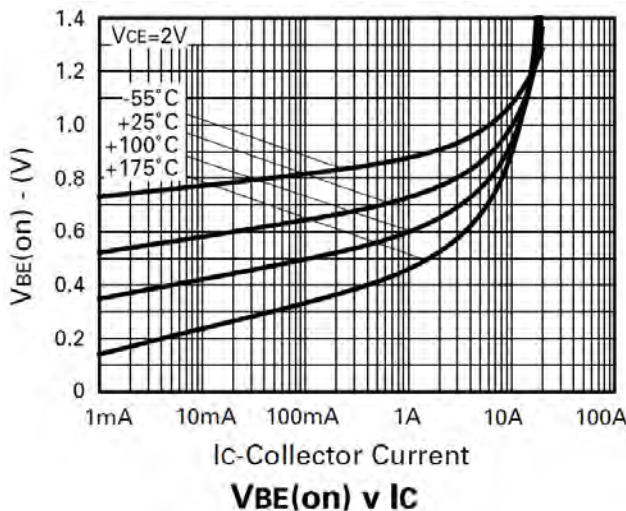
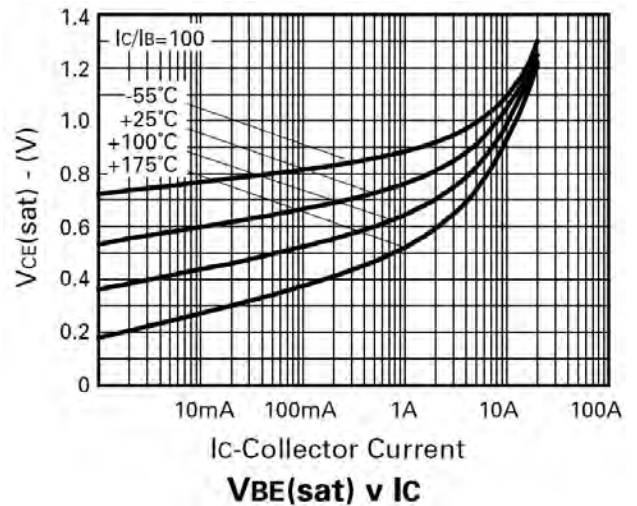
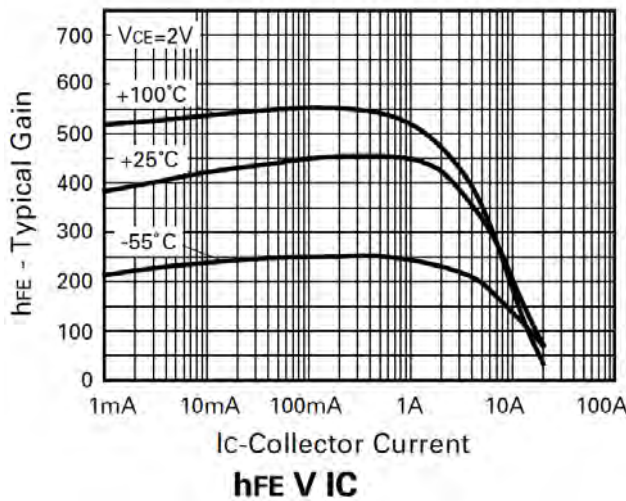
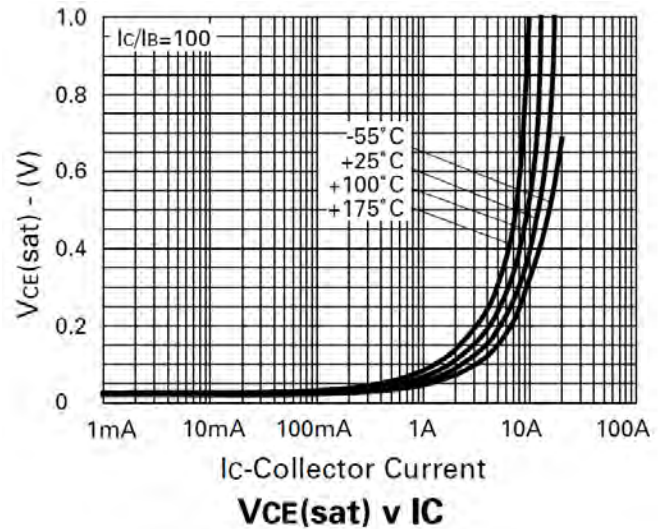
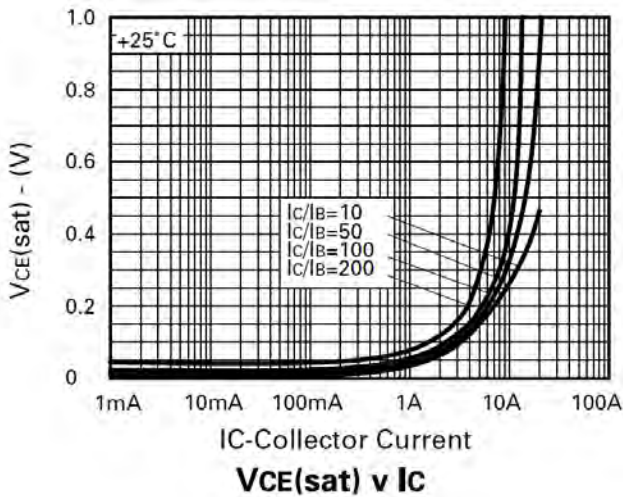

Package Outline Dimensions

Please see AP02002 at <http://www.diodes.com/datasheets/ap02002.pdf> for latest version.

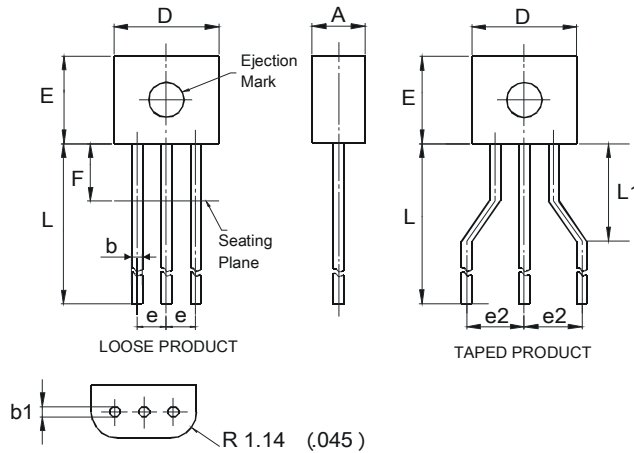

E-Line			
Dim	Min	Max	Typ
A	2.16	2.41	-
b	0.41	0.495	-
b1	0.41	0.495	-
D	4.37	4.77	-
E	3.61	4.01	-
e	-	-	1.27
e2	-	-	2.54
F	-	2.50	-
L	13.00	13.97	-
L1	2.50	3.50	-
All Dimensions in mm			

IMPORTANT NOTICE

DIODES INCORPORATED MAKES NO WARRANTY OF ANY KIND, EXPRESS OR IMPLIED, WITH REGARDS TO THIS DOCUMENT, INCLUDING, BUT NOT LIMITED TO, THE IMPLIED WARRANTIES OF MERCHANTABILITY AND FITNESS FOR A PARTICULAR PURPOSE (AND THEIR EQUIVALENTS UNDER THE LAWS OF ANY JURISDICTION).

Diodes Incorporated and its subsidiaries reserve the right to make modifications, enhancements, improvements, corrections or other changes without further notice to this document and any product described herein. Diodes Incorporated does not assume any liability arising out of the application or use of this document or any product described herein; neither does Diodes Incorporated convey any license under its patent or trademark rights, nor the rights of others. Any Customer or user of this document or products described herein in such applications shall assume all risks of such use and will agree to hold Diodes Incorporated and all the companies whose products are represented on Diodes Incorporated website, harmless against all damages.

Diodes Incorporated does not warrant or accept any liability whatsoever in respect of any products purchased through unauthorized sales channel. Should Customers purchase or use Diodes Incorporated products for any unintended or unauthorized application, Customers shall indemnify and hold Diodes Incorporated and its representatives harmless against all claims, damages, expenses, and attorney fees arising out of, directly or indirectly, any claim of personal injury or death associated with such unintended or unauthorized application.

Products described herein may be covered by one or more United States, international or foreign patents pending. Product names and markings noted herein may also be covered by one or more United States, international or foreign trademarks.

LIFE SUPPORT

Diodes Incorporated products are specifically not authorized for use as critical components in life support devices or systems without the express written approval of the Chief Executive Officer of Diodes Incorporated. As used herein:

A. Life support devices or systems are devices or systems which:

1. are intended to implant into the body, or
2. support or sustain life and whose failure to perform when properly used in accordance with instructions for use provided in the labeling can be reasonably expected to result in significant injury to the user.

B. A critical component is any component in a life support device or system whose failure to perform can be reasonably expected to cause the failure of the life support device or to affect its safety or effectiveness.

Customers represent that they have all necessary expertise in the safety and regulatory ramifications of their life support devices or systems, and acknowledge and agree that they are solely responsible for all legal, regulatory and safety-related requirements concerning their products and any use of Diodes Incorporated products in such safety-critical, life support devices or systems, notwithstanding any devices- or systems-related information or support that may be provided by Diodes Incorporated. Further, Customers must fully indemnify Diodes Incorporated and its representatives against any damages arising out of the use of Diodes Incorporated products in such safety-critical, life support devices or systems.

Copyright © 2012, Diodes Incorporated

www.diodes.com

Данный компонент на территории Российской Федерации

Вы можете приобрести в компании MosChip.

Для оперативного оформления запроса Вам необходимо перейти по данной ссылке:

<http://moschip.ru/get-element>

Вы можете разместить у нас заказ для любого Вашего проекта, будь то серийное производство или разработка единичного прибора.

В нашем ассортименте представлены ведущие мировые производители активных и пассивных электронных компонентов.

Нашей специализацией является поставка электронной компонентной базы двойного назначения, продукции таких производителей как XILINX, Intel (ex.ALTERA), Vicor, Microchip, Texas Instruments, Analog Devices, Mini-Circuits, Amphenol, Glenair.

Сотрудничество с глобальными дистрибьюторами электронных компонентов, предоставляет возможность заказывать и получать с международных складов практически любой перечень компонентов в оптимальные для Вас сроки.

На всех этапах разработки и производства наши партнеры могут получить квалифицированную поддержку опытных инженеров.

Система менеджмента качества компании отвечает требованиям в соответствии с ГОСТ Р ИСО 9001, ГОСТ РВ 0015-002 и ЭС РД 009

Офис по работе с юридическими лицами:

105318, г.Москва, ул.Щербаковская д.3, офис 1107, 1118, ДЦ «Щербаковский»

Телефон: +7 495 668-12-70 (многоканальный)

Факс: +7 495 668-12-70 (доб.304)

E-mail: info@moschip.ru

Skype отдела продаж:

moschip.ru

moschip.ru_4

moschip.ru_6

moschip.ru_9