

FINEMET® [Catalog]

# FINEMET® EMC Components



As IT and electronic devices become small and improve its performance, issues of electromagnetic noise are addressed. EMC regulations for those devices have been tightened and, consequently, need for high efficiency noise reduction components is urged for electronic devices.

Hitachi Metals Ltd. provides a series of high efficiency EMC components using FINEMET<sup>®</sup>, the first nanocrystalline soft magnetic material in the world, to meet this requirements.

The FINEMET<sup>®</sup> EMC components offer superior technical solution for electromagnetic noise suppression, size reduction and low energy loss for your application.

---

## CONTENTS

---

|   |    |
|---|----|
| What is FINEMET <sup>®</sup> ?, FINEMET <sup>®</sup> EMC Components ..... | 3  |
| <b>Common Mode Chokes</b> .....   | 4  |
| <b>For DC and single-phase AC power lines</b>                             |    |
| ○ Single-phase FM-A coils .....   | 5  |
| ○ Single-phase FM coils .....   | 8  |
| ○ Single-phase VL coils .....   | 10 |
| <b>For three-phase AC power lines</b>                                     |    |
| ○ Three-phase FM-A coils .....  | 11 |
| ○ Three-phase FM coils .....  | 13 |
| ○ Three-phase FM-H coils .....  | 15 |
| ○ Three-phase FN coils .....  | 16 |
| <b>Common Mode Choke Cores</b> .....                                      | 18 |
| <b>For signal lines, DC and single-phase AC power lines</b>               |    |
| ○ FT-3KM K series .....   | 20 |
| ○ FT-3KL V series .....   | 21 |
| <b>For three-phase AC power lines</b>                                     |    |
| ○ FT-3KM N series .....   | 22 |
| <b>For signal lines, DC and AC power lines and Output filters</b>         |    |
| ○ FT-3KM F series .....   | 23 |
| ○ FT-3KL F series .....   | 25 |
| ○ FT-3KM S series .....   | 27 |
| <b>Surge Absorber Cores</b> .....   | 28 |
| <b>For small handling power</b>   |    |
| ○ FINEMET <sup>®</sup> Beads .....  | 29 |
| <b>For medium-large handling power</b>                                    |    |
| ○ MP series .....   | 30 |

---

## What is FINEMET®?

The first nanocrystalline soft magnetic material in the world developed by Hitachi Metals, Ltd.

The precursor material of FINEMET® is amorphous metal obtained by rapid quenching the molten metal, consisting of Fe, Si, B and small amounts of Cu and Nb. By applying heat treatment to the alloy at higher temperature than its crystallization temperature, this alloy forms Nano-Crystalline structure (grain size of approximately 10 nanometer).

Provided with both high saturation magnetic flux density and high permeability.

FINEMET® has high saturation magnetic flux density (more than 1T) comparable to Fe-based amorphous metal and high permeability (over 10,000 at 100kHz) comparable to Co-based amorphous metal. It has the advantages of both Fe based and Co based amorphous metals.

Excellent temperature characteristics.

FINEMET® has very high Curie temperature (570°C) which results in small permeability variation (less than +/-10%) at a temperature range from -40 to +150°C.

Less affected by mechanical stress, and very low audible noise emission.

FINEMET's permeability and core loss are hardly affected by mechanical stress due to near-zero magnetostriction (less than  $10^{-6}$ ). Furthermore, its low magnetostriction significantly reduces audible noise emission when the voltage and current applied to the core at audible frequency range.

## FINEMET® EMC Components

### Common Mode Chokes



Single-phase FM-A coils



Single-phase FM coils  
Single-phase VL coils



Three-phase FM-A coils



Three-phase FM coils



Three-phase FM-H coils



Three-phase FN coils

### Surge Absorber Cores



FINEMET® Beads



MP series

### Common Mode Choke Cores



FT-3KM K series  
FT-3KM V series



FT-3KM N series



FT-3KM F series  
FT-3KL F series



FT-3KM S series



# Common Mode Chokes

## Features

FINEMET® common mode chokes (CMC) have superior characteristics when compared with Mn-Zn ferrite chokes. Those characteristics are as follows:

- 1) Having high permeability and low Q factor, FINEMET® CMC has higher impedance over a wide frequency range, which result in offering excellent noise suppression performance at wide frequency range.  
When FINEMET® and Mn-Zn ferrite chokes have same inductance at 100kHz, FINEMET® chokes show impedance two times higher than that of Mn-Zn ferrite chokes. Furthermore, since FINEMET® chokes require fewer windings to obtain the same inductance as Mn-Zn ferrite chokes, stray capacitance can be reduced and it allows high impedance at higher frequencies than 1 MHz (Figure 1).
- 2) Their frequency characteristics of impedance are not significantly affected by temperature change. As a result, it offers high noise suppression effect over a wide temperature range (Figure 2, 3).

## Applications

Air conditioner, elevator, liquid pump, inverters, NC machine, welding equipment, AC servo, UPS, personal computer, computer peripherals, copy machine, networking equipment, broadcast equipment, medical equipment, etc.

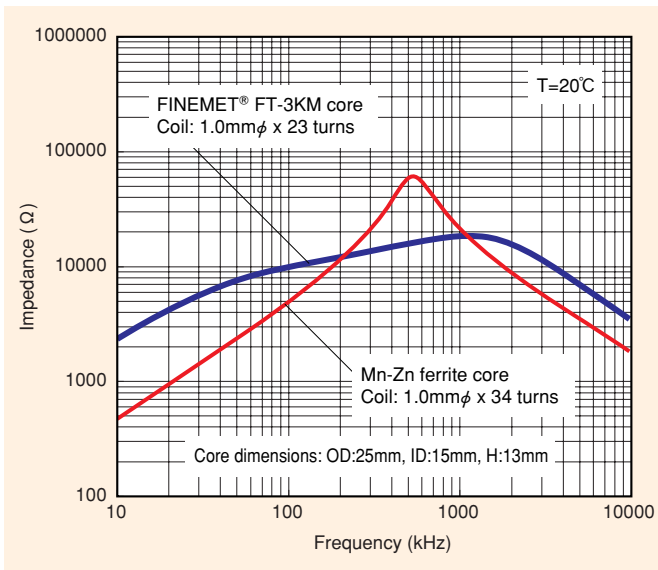

Figure 1. Comparison of impedance (8mH at 100kHz)



Figure 2. Temperature dependence of impedance for FINEMET® common mode chokes



Figure 3. Temperature dependence of impedance for Mn-Zn ferrite common mode chokes



## Common Mode Chokes

For DC and single-phase AC power lines

### Single-phase FM-A coils

FM-A series single-phase common mode chokes are cost economical version of FM series (P.8) that use a new manufacturing process and new structure.



Table 1. Standard Specifications

| Item                        | Specification  |
|-----------------------------|--|
| Rated voltage               | AC250V or DC250V                                       |
| Insulation voltage rating   | AC2kV for 1min. or AC2.4kV for 3 sec. (line-line)      |
| Insulation resistance       | Over 100MΩ after applying DC500V for 1min. (line-line) |
| Insulation grade            | Class B (130°C)  |
| Temperature rise            | Refer to each specification                            |
| Operating temperature range | -40°C – +130°C (including temperature rise of core)    |

- No Ozone Layer Depleting Chemicals are used in these products or in their manufacturing process.
- \* Note 1: The temperature rise in the above table is a projected value based on temperature rise by the heat of the coil when the rated current (DC or 50/60Hz) in the table below is conducted.
- \* Note 2: The temperature rise is affected by the mounting condition on the circuit board and the amount of harmonic distortion on the load current. Please make sure the temperature of the coil and the terminals not to exceed the operating temperature range.

Table 2. Product code, part name and specifications

| Product code | P/N            | Rated current (A) | Z  (kΩ) 100kHz MIN. | L (mH) 100kHz REF. | Wire diameter (mm) | Finished dimensions (mm) |        |        |        |        | Weight (g) TYP. | DC resistance (mΩ) MAX. | Temp.rise (°C) | Shape |
|--------------|----------------|-------------------|---------------------|--------------------|--------------------|--------------------------|--------|--------|--------|--------|-----------------|-------------------------|----------------|-------|
|              |                |                   |                     |                    |                    | A MAX.                   | B MAX. | C MAX. | F REF. | G REF. |                 |                         |                |       |
| F1AH0713     | FM-A083V692PF  | 8                 | 6.9                 | 8.1                | 1.4                | 34                       | 30.5   | 37     | 10     | 26     | 64              | 25                      | 45             | Fig.4 |
| F1AH0714     | FM-A103V402PF  | 10                | 4.0                 | 4.7                | 1.6                | 36                       | 30.5   | 37     | 10     | 26     | 63              | 15                      | 45             | Fig.4 |
| F1AH0592     | FM-A104V103PF  | 10                | 10.0                | 11.8               | 1.6                | 42                       | 32     | 43     | 10     | 28     | 102             | 19                      | 45             | Fig.4 |
| F1AH0872     | FM-A153V332PF  | 15                | 3.3                 | 3.9                | 1.7                | 38                       | 33     | 37     | 18     | 16     | 70              | 12                      | 60             | Fig.4 |
| F1AH0717     | FM-A154V442PF  | 15                | 4.4                 | 5.2                | 1.9                | 42                       | 32     | 44     | 10     | 28     | 98              | 9                       | 45             | Fig.4 |
| F1AH0873     | FM-A154V722PF  | 15                | 7.2                 | 8.5                | 1.7                | 42                       | 32     | 44     | 10     | 28     | 102             | 14                      | 60             | Fig.4 |
| F1AH0718     | FM-A204V262PF  | 20                | 2.6                 | 3.1                | 2.2                | 44                       | 32     | 44     | 20     | 28     | 102             | 6                       | 45             | Fig.4 |
| F1AH0599     | FM-A205V852PF  | 20                | 8.5                 | 10.0               | 2.2                | 52                       | 43     | 60     | 18     | 34     | 202             | 12                      | 60             | Fig.4 |
| F1AH0719     | FM-A254V132PF  | 25                | 1.3                 | 1.6                | 2.4                | 44                       | 32     | 45     | 20     | 28     | 95              | 4                       | 45             | Fig.4 |
| F1AH0722     | FM-A255V242PF  | 25                | 2.4                 | 2.9                | 2.6                | 52                       | 43     | 55     | 18     | 34     | 163             | 5                       | 45             | Fig.4 |
| F1AH0591     | FM-A305V212PF  | 30                | 2.1                 | 2.5                | 3.0                | 57                       | 43     | 60     | 18     | 34     | 188             | 3                       | 45             | Fig.4 |
| F1AH0874     | FM-A054V173YPF | 5                 | 17.0                | 20.9               | 1.0                | 43                       | 34     | —      | 15     | 35     | 75              | 60                      | 30             | Fig.5 |
| F1AH0723     | FM-A083V692YPF | 8                 | 6.9                 | 8.1                | 1.4                | 38                       | 32     | —      | 13     | 30     | 64              | 25                      | 45             | Fig.5 |
| F1AH0875     | FM-A083V942YPF | 8                 | 9.4                 | 11.0               | 1.3                | 39                       | 34     | —      | 13     | 30     | 66              | 33                      | 50             | Fig.5 |
| F1AH0876     | FM-A084V173YPF | 8                 | 17.0                | 20.9               | 1.3                | 43                       | 34     | —      | 15     | 35     | 98              | 38                      | 45             | Fig.5 |
| F1AH0724     | FM-A103V402YPF | 10                | 4.0                 | 4.7                | 1.6                | 38                       | 33     | —      | 13     | 30     | 63              | 15                      | 45             | Fig.5 |
| F1AH0726     | FM-A104V103YPF | 10                | 10.0                | 11.8               | 1.6                | 43                       | 35     | —      | 15     | 35     | 102             | 19                      | 45             | Fig.5 |
| F1AH0877     | FM-A153V332YPF | 15                | 3.3                 | 3.9                | 1.7                | 38                       | 33     | —      | 13     | 30     | 70              | 12                      | 60             | Fig.5 |
| F1AH0727     | FM-A154V442YPF | 15                | 4.4                 | 5.2                | 1.9                | 43                       | 35     | —      | 15     | 35     | 98              | 9                       | 45             | Fig.5 |
| F1AH0878     | FM-A154V722YPF | 15                | 7.2                 | 8.5                | 1.7                | 43                       | 34     | —      | 15     | 35     | 102             | 14                      | 60             | Fig.5 |
| F1AH0879     | FM-A205V852YPF | 20                | 8.5                 | 10.0               | 2.2                | 57                       | 45     | —      | 40     | 27     | 202             | 12                      | 60             | Fig.5 |

- UL94 V-0 certified resin is used for these cores and base plates.
- Lead-free solder is used for the winding coils.
- Custom made products are available.



For safety and the proper usage, you are requested to approve our product specifications or to transact the approval sheet for product specifications before ordering. This catalog and its contents are subject to change without notice.

# Common Mode Chokes

For DC and single-phase AC power lines



Figure 4. FM-A□□□V□□□PF



Figure 5. FM-A□□□V□□□YPF



Figure 6. Circuit diagram

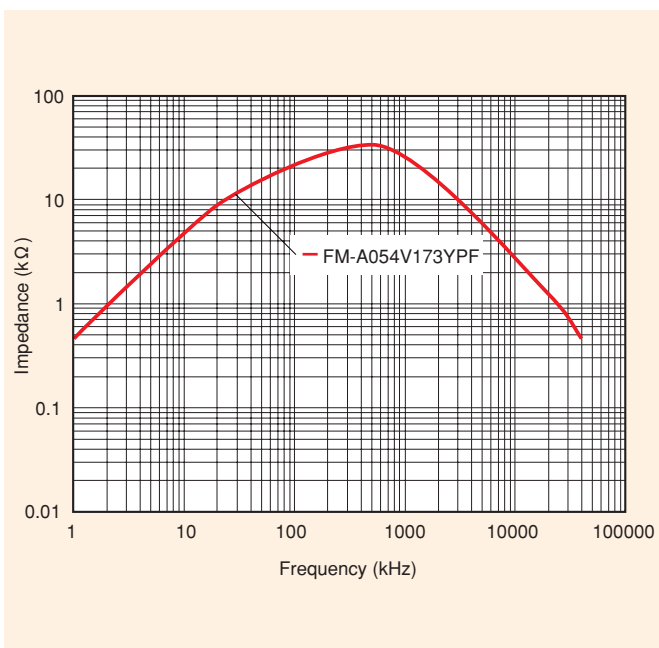

Figure 7. Frequency dependence of impedance for single-phase FM-A coils with rated current 5A



Figure 8. Frequency dependence of impedance for single-phase FM-A coils with rated current 8A





Figure 9. Frequency dependence of impedance for single-phase FM-A coils with rated current 10A



Figure 10. Frequency dependence of impedance for single-phase FM-A coils with rated current 15A



Figure 11. Frequency dependence of impedance for single-phase FM-A coils with rated current 20A



Figure 12. Frequency dependence of impedance for single-phase FM-A coils with rated current 25A-30A



## Common Mode Chokes

For DC and single-phase AC power lines



# Single-phase FM coils

FM series single-phase common mode chokes are compact in size and have excellent electromagnetic noise suppression properties.

Table 3. Standard Specifications

| Item                        | Specification  |
|-----------------------------|--|
| Rated voltage               | AC250V or DC250V                                       |
| Insulation voltage rating   | AC1.5kV for 1min. or AC1.8kV for 3 sec. (line-line)    |
| Insulation resistance       | Over 100MΩ after applying DC500V for 1min. (line-line) |
| Insulation grade            | Class E (120°C)  |
| Temperature rise            | *45°C  |
| Operating temperature range | -40°C – +120°C (including temperature rise of core)    |

- No Ozone Layer Depleting Chemicals are used in these products or in their manufacturing process.
- \* Note 1: The temperature rise in the above table is a projected value based on temperature rise by the heat of the coil when the rated current (DC or 50/60Hz) in the table below is conducted.
- \* Note 2: The temperature rise is affected by the mounting condition on the circuit board and the amount of harmonic distortion on the load current. Please make sure the temperature of the coil and the terminals not to exceed the operating temperature range.

Table 4. Product code, part name and specifications

| Product code | P/N           | Rated current (A) | L (mH)     |             | Wire diameter (mm) | Finished dimensions (mm) |        |        |        | Weight (g) TYP. | DC resistance (mΩ) MAX. | Shape  |
|--------------|---------------|-------------------|------------|-------------|--------------------|--------------------------|--------|--------|--------|-----------------|-------------------------|--------|
|              |               |                   | 10kHz MIN. | 100kHz MIN. |                    | A MAX.                   | B MAX. | F REF. | G REF. |                 |                         |        |
| F1AH0866     | FM02W752MPF   | 2                 | 31.0       | 5.0         | 0.4                | 16                       | 12     | 5      | 11     | 4.2             | 135                     | Fig.13 |
| F1AH0813     | FM03C782MBPF  | 3                 | 28.1       | 7.8         | 0.7                | 31                       | 25     | 7      | 22     | 30              | 80                      | Fig.13 |
| F1AH0814     | FM03D382MBPF  | 3                 | 15.0       | 3.8         | 0.8                | 29                       | 25     | 7      | 17     | 24              | 40                      | Fig.13 |
| F1AH0790     | FM05E572MBPF  | 5                 | 22.0       | 5.7         | 1.1                | 33                       | 32     | 7      | 24     | 55              | 30                      | Fig.13 |
| F1AH0815     | FM05F852MBPF  | 5                 | 39.1       | 8.5         | 1.1                | 37                       | 32     | 7      | 28     | 66              | 40                      | Fig.13 |
| F1AH0816     | FM08E242MBPF  | 8                 | 9.3        | 2.4         | 1.4                | 36                       | 32     | 7      | 24     | 51              | 12                      | Fig.13 |
| F1AH0817     | FM10G752MBPF  | 10                | 29.3       | 7.5         | 1.4                | 50                       | 32     | 7      | 25     | 107             | 20                      | Fig.13 |
| F1AH0818     | FM10I113MBPF  | 10                | 44.4       | 10.6        | 1.5                | 50                       | 37     | 10     | 32     | 150             | 25                      | Fig.13 |
| F1AH0819     | FM15F162MBPF  | 15                | 6.2        | 1.6         | 1.9                | 42                       | 34     | 7      | 28     | 120             | 6                       | Fig.13 |
| F1AH0820     | FM15G462MBPF  | 15                | 18.0       | 4.6         | 1.8                | 51                       | 34     | 7      | 25     | 122             | 10                      | Fig.13 |
| F1AH0821     | FM15I682MBPF  | 15                | 26.9       | 6.8         | 1.9                | 53                       | 39     | 10     | 32     | 168             | 12                      | Fig.13 |
| F1AH0822     | FM20G242MBPF  | 20                | 9.4        | 2.4         | 2.0                | 52                       | 35     | 7      | 25     | 117             | 6                       | Fig.13 |
| F1AH0823     | FM20I382MBPF  | 20                | 13.7       | 3.8         | 2.1                | 54                       | 42     | 10     | 32     | 162             | 7                       | Fig.13 |
| F1AH0880     | FM25G142MBPF  | 25                | 5.6        | 1.4         | 2.3                | 54                       | 37     | 7      | 25     | 155             | 4                       | Fig.13 |
| F1AH0825     | FM25I292MBPF  | 25                | 10.3       | 2.9         | 2.3                | 55                       | 43     | 10     | 32     | 166             | 5                       | Fig.13 |
| F1AH0826     | FM10G752MYBPF | 10                | 29.3       | 7.5         | 1.4                | 55                       | 34     | 27     | 37     | 108             | 20                      | Fig.14 |
| F1AH0827     | FM10I113MYBPF | 10                | 44.4       | 10.6        | 1.5                | 55                       | 40     | 27     | 37     | 151             | 25                      | Fig.14 |
| F1AH0828     | FM15G462MYBPF | 15                | 18.0       | 4.6         | 1.8                | 55                       | 37     | 27     | 37     | 123             | 10                      | Fig.14 |
| F1AH0829     | FM15I682MYBPF | 15                | 26.9       | 6.8         | 1.9                | 55                       | 42     | 27     | 37     | 171             | 12                      | Fig.14 |
| F1AH0830     | FM20G242MYBPF | 20                | 9.4        | 2.4         | 2.0                | 55                       | 38     | 27     | 37     | 118             | 6                       | Fig.14 |
| F1AH0831     | FM20I382MYBPF | 20                | 13.7       | 3.8         | 2.1                | 55                       | 45     | 27     | 37     | 162             | 7                       | Fig.14 |
| F1AH0832     | FM20S562MYBPF | 20                | 22.5       | 5.6         | 2.4                | 71                       | 41     | 40     | 50     | 295             | 9                       | Fig.14 |
| F1AH0833     | FM25G142MYBPF | 25                | 5.6        | 1.4         | 2.3                | 55                       | 40     | 27     | 37     | 156             | 4                       | Fig.14 |
| F1AH0834     | FM25I292MYBPF | 25                | 10.3       | 2.9         | 2.3                | 55                       | 46     | 27     | 37     | 167             | 5                       | Fig.14 |
| F1AH0835     | FM30S192MYBPF | 30                | 7.5        | 1.9         | 2.0x2              | 73                       | 42     | 40     | 50     | 273             | 4                       | Fig.14 |
| F1AH0836     | FM40S122MYBPF | 40                | 5.0        | 1.2         | 1.9x3              | 73                       | 42     | 40     | 50     | 253             | 2                       | Fig.14 |

- UL94 V-0 certified resin is used for these cores and base plates.
- Lead-free solder is used for the winding coils.
- Custom made products are available.

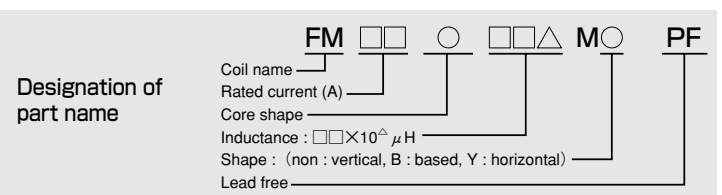





Figure 13. FM□□□□□MBPF



Figure 14. FM□□□□□MYBPF



Figure 15. Circuit diagram



Figure 16. Frequency dependence of impedance for single-phase FM coils with rated current 2A-3A



Figure 17. Frequency dependence of impedance for single-phase FM coils with rated current 5A-8A



Figure 18. Frequency dependence of impedance for single-phase FM coils with rated current 10A



Figure 19. Frequency dependence of impedance for single-phase FM coils with rated current 15A



Figure 20. Frequency dependence of impedance for single-phase FM coils with rated current 20A



Figure 21. Frequency dependence of impedance for single-phase FM coils with rated current 25A-40A



# Common Mode Chokes

For DC and single-phase AC power lines



## Single-phase VL coils

Single-phase VL coils using FT-3KL material maintain excellent noise suppression properties even under high bias current and have high durability against vibration.

Table 5. Standard Specifications

| Item                        | Specification  |
|-----------------------------|--|
| Rated voltage               | AC250V or DC250V                                       |
| Insulation voltage rating   | AC1.5kV for 1min. or AC1.8kV for 3 sec. (line-line)    |
| Insulation resistance       | Over 100MΩ after applying DC500V for 1min. (line-line) |
| Insulation grade            | Class E (120°C)  |
| Temperature rise            | *45°C  |
| Operating temperature range | -40°C – +120°C (including temperature rise of core)    |

- No Ozone Layer Depleting Chemicals are used in these products or in their manufacturing process.
- \* Note 1: The temperature rise in the above table is a projected value based on temperature rise by the heat of the coil when the rated current (DC or 50/60Hz) in the table below is conducted.
- \* Note 2: The temperature rise is affected by the mounting condition on the circuit board and the amount of harmonic distortion on the load current. Please make sure the temperature of the coil and the terminals not to exceed the operating temperature range.

Table 6. Product code, part name and specifications

| Product code | P/N             | Rated current (A) | Z  (Ω) 100kHz MIN. | Wire diameter (mm) | Finished dimensions (mm) |        |        |        | Weight (g) TYP. | DC resistance (mΩ) | Shape  |
|--------------|-----------------|-------------------|--------------------|--------------------|--------------------------|--------|--------|--------|-----------------|--------------------|--------|
|              |                 |                   |                    |                    | A MAX.                   | B MAX. | F REF. | G REF. |                 |                    |        |
| F1AH0973     | FM-VL12H980MYPF | 12                | 98                 | 1.2                | 18                       | 19     | 10     | 15     | 9               | 4.0                | Fig.22 |
| F1AH0974     | FM-VL18T351MYPF | 18                | 347                | 1.4                | 27                       | 20     | 16     | 19     | 22              | 5.3                | Fig.22 |
| F1AH0975     | FM-VL25E211MYPF | 25                | 207                | 2.2                | 37                       | 25     | 18     | 28     | 48              | 2.4                | Fig.22 |

- UL94 V-0 certified resin is used for these cores and base plates.
- Lead-free solder is used for the winding coils.
- Custom made products are available.

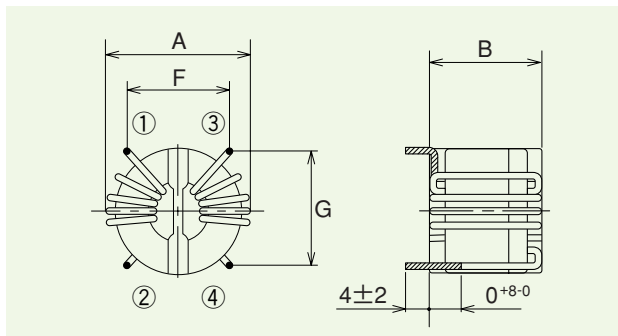

Figure 22. Single-phase VL coils



Figure 23. Circuit diagram

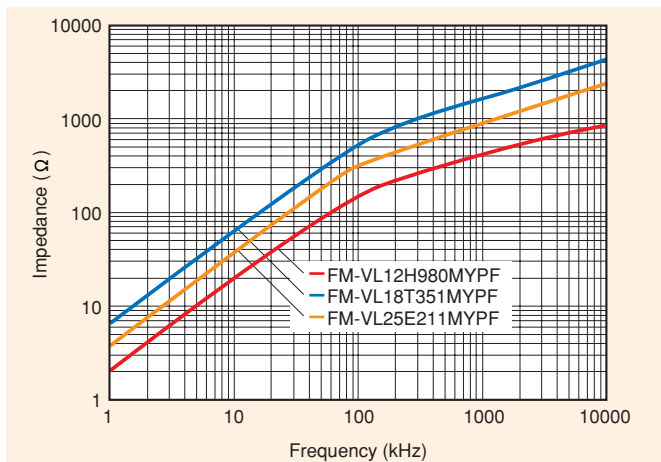

Figure 24. Frequency dependence of impedance for single-phase VL coils

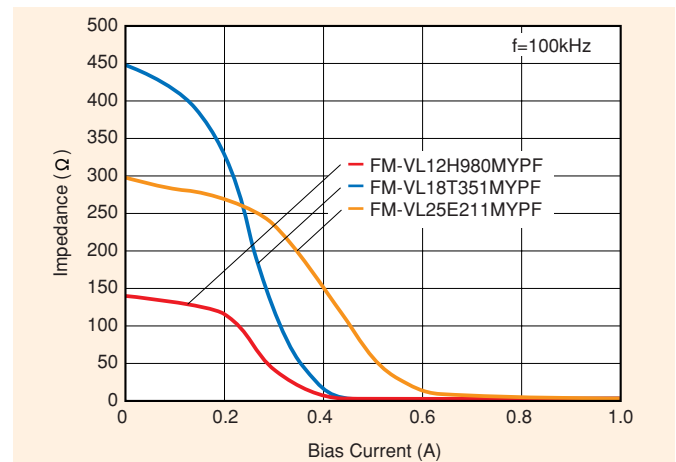

Figure 25. DC superposed characteristics of impedance for single-phase VL coils



## Common Mode Chokes

For three-phase AC power lines

### Three-phase FM-A coils

FM-A series three-phase common mode chokes are cost economical version of FM series (P.13) that use a new manufacturing process and new structure.



Table 7. Standard Specifications

| Item                        | Specification  |
|-----------------------------|--|
| Rated voltage               | AC250V   |
| Insulation voltage rating   | AC2kV for 1min. or AC2.4kV for 3 sec. (line-line)      |
| Insulation resistance       | Over 100MΩ after applying DC500V for 1min. (line-line) |
| Insulation grade            | Class B (130°C)  |
| Temperature rise            | *60°C  |
| Operating temperature range | -40°C – +130°C (including temperature rise of core)    |

- No Ozone Layer Depleting Chemicals are used in these products or in their manufacturing process.
- \* Note 1: The temperature rise in the above table is a projected value based on temperature rise by the heat of the coil when the rated current (DC or 50/60Hz) in the table below is conducted.
- \* Note 2: The temperature rise is affected by the mounting condition on the circuit board and the amount of harmonic distortion on the load current. Please make sure the temperature of the coil and the terminals not to exceed the operating temperature range.

Table 8. Product code, part name and specifications

| Product code | P/N             | Rated current (A) | Z  (kΩ) 100kHz MIN. | L (mH) 100kHz REF. | Wire diameter (mm) | Finished dimensions (mm) |        |        |        |        | Weight (g) TYP. | DC resistance (mΩ) MAX. | Shape  |
|--------------|-----------------|-------------------|---------------------|--------------------|--------------------|--------------------------|--------|--------|--------|--------|-----------------|-------------------------|--------|
|              |                 |                   |                     |                    |                    | A MAX.                   | B MAX. | C MAX. | F REF. | G REF. |                 |                         |        |
| F1AH0737     | FM-A051T502PF   | 5                 | 5.0                 | 5.9                | 0.9                | 35                       | 28     | —      | 30     | 15     | 40              | 36                      | Fig.26 |
| F1AH0728     | FM-A081T202PF   | 8                 | 2.0                 | 2.3                | 1.1                | 35                       | 28     | —      | 30     | 15     | 39              | 17                      | Fig.26 |
| F1AH0738     | FM-A082T852PF   | 8                 | 8.5                 | 10.1               | 1.3                | 45                       | 35     | —      | 40     | 20     | 103             | 26                      | Fig.26 |
| F1AH0739     | FM-A102T602PF   | 10                | 6.0                 | 7.1                | 1.5                | 45                       | 35     | —      | 40     | 20     | 109             | 17                      | Fig.26 |
| F1AH0893     | FM-A152T232PF   | 15                | 2.3                 | 2.7                | 1.7                | 45                       | 35     | —      | 40     | 20     | 99              | 8                       | Fig.26 |
| F1AH0740     | FM-A153T452PF   | 15                | 4.5                 | 5.3                | 1.8                | 56                       | 38     | —      | 50     | 25     | 153             | 11                      | Fig.26 |
| F1AH0733     | FM-A203T242PF   | 20                | 2.4                 | 2.9                | 2.1                | 56                       | 38     | —      | 50     | 25     | 154             | 6                       | Fig.26 |
| F1AH0741     | FM-A204T442PF   | 20                | 4.4                 | 5.3                | 2.2                | 63                       | 46     | —      | 56     | 28     | 236             | 9                       | Fig.26 |
| F1AH0734     | FM-A253T152PF   | 25                | 1.5                 | 1.8                | 2.4                | 56                       | 38     | —      | 50     | 25     | 158             | 4                       | Fig.26 |
| F1AH0735     | FM-A254T312PF   | 25                | 3.1                 | 3.7                | 2.4                | 63                       | 46     | —      | 56     | 28     | 236             | 6                       | Fig.26 |
| F1AH0736     | FM-A304T212PF   | 30                | 2.1                 | 2.4                | 2.6                | 63                       | 47     | —      | 56     | 28     | 232             | 5                       | Fig.26 |
| F1AH0881     | FM-A082T852VBPF | 8                 | 8.5                 | 10.1               | 1.3                | 45                       | 33     | 45     | 20     | 26     | 105             | 26                      | Fig.27 |
| F1AH0882     | FM-A102T602VBPF | 10                | 6.0                 | 7.1                | 1.5                | 45                       | 33     | 45     | 20     | 26     | 111             | 17                      | Fig.27 |
| F1AH0883     | FM-A152T232VBPF | 15                | 2.3                 | 2.7                | 1.7                | 45                       | 33     | 45     | 20     | 26     | 101             | 8                       | Fig.27 |

- UL94 V-0 certified resin is used for these cores and base plates.
- Lead-free solder is used for the winding coils.
- Custom made products are available.



# Common Mode Chokes

For three-phase AC power lines

Three-phase FM-A coils

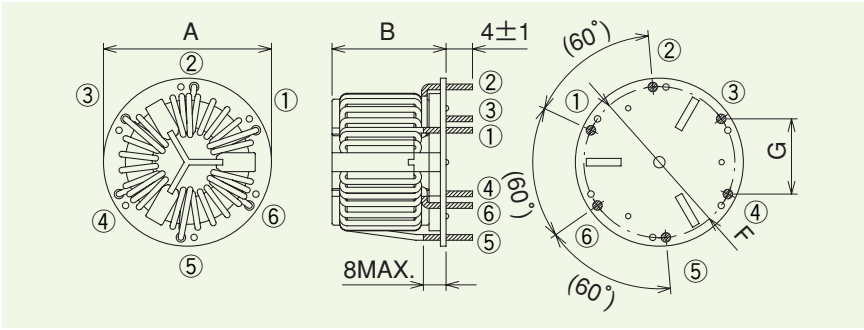

Figure 26. FM-A□□□T□□□PF



Figure 28. Circuit diagram



Figure 27. FM-A□□□T□□□VBPF

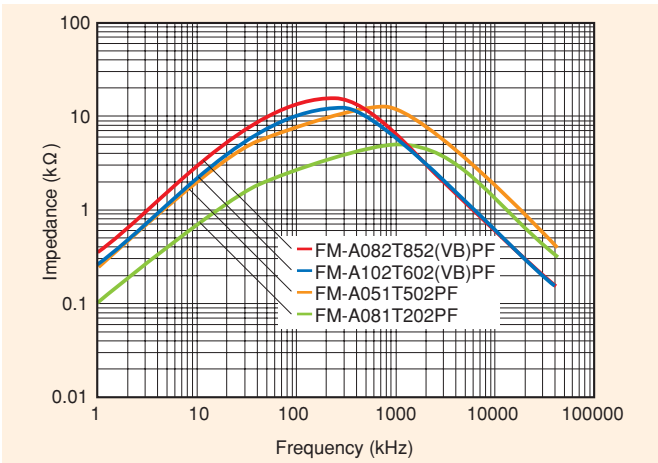

Figure 29. Frequency dependence of impedance for three-phase FM-A coils with rated current 5A-10A

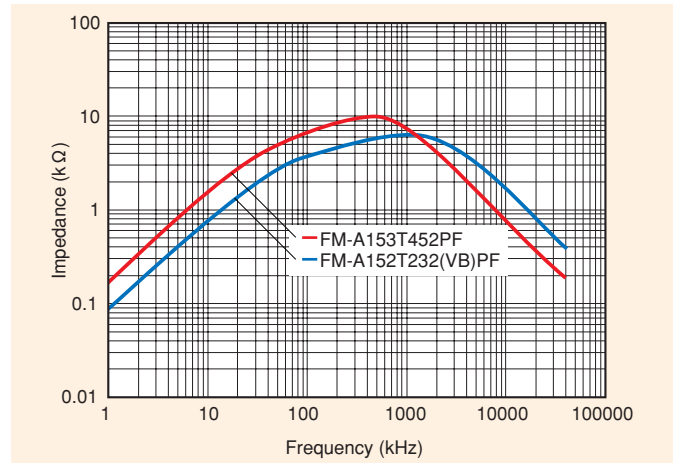

Figure 30. Frequency dependence of impedance for three-phase FM-A coils with rated current 15A

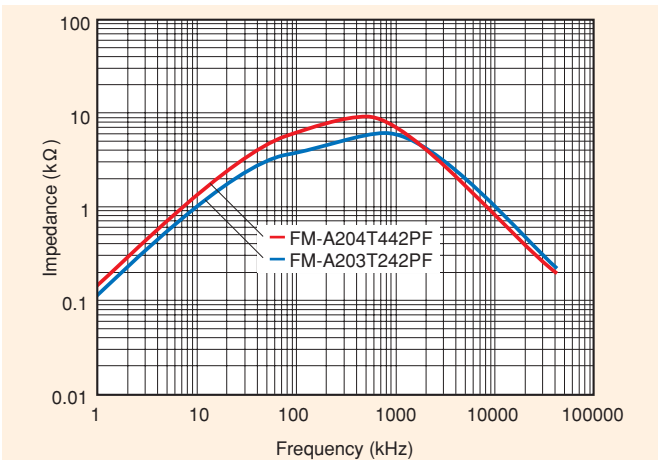

Figure 31. Frequency dependence of impedance for three-phase FM-A coils with rated current 20A

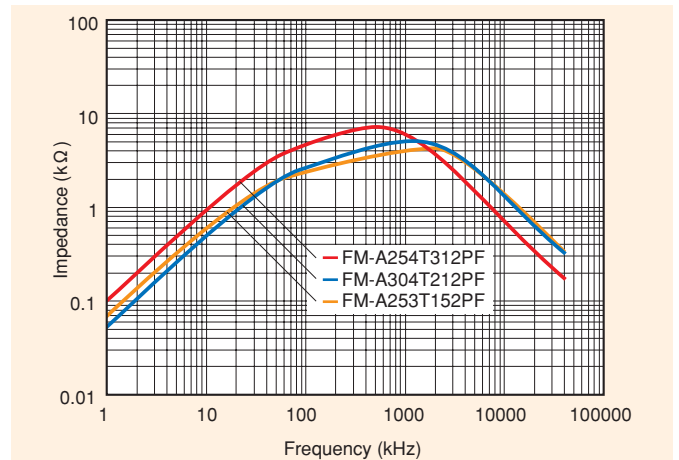

Figure 32. Frequency dependence of impedance for three-phase FM-A coils with rated current 25A-30A



## Common Mode Chokes

For three-phase AC power lines

# Three-phase FM coils

FM series three-phase common mode chokes are compact in size and have excellent electromagnetic noise suppression properties.



Table 9. Standard Specifications

| Item                        | Specification  |
|-----------------------------|--|
| Rated voltage               | AC250V   |
| Insulation voltage rating   | AC2kV for 1min. or AC2.4kV for 3 sec. (line-line)      |
| Insulation resistance       | Over 100MΩ after applying DC500V for 1min. (line-line) |
| Insulation grade            | Class E (120°C)  |
| Temperature rise            | *60°C  |
| Operating temperature range | -40°C – +120°C (including temperature rise of core)    |

- No Ozone Layer Depleting Chemicals are used in these products or in their manufacturing process.
- \* Note 1: The temperature rise in the above table is a projected value based on temperature rise by the heat of the coil when the rated current (DC or 50/60Hz) in the table below is conducted.
- \* Note 2: The temperature rise is affected by the mounting condition on the circuit board and the amount of harmonic distortion on the load current. Please make sure the temperature of the coil and the terminals not to exceed the operating temperature range.

Table 10. Product code, part name and specifications

| Product code | P/N           | Rated current (A) | L (mH)     |             | Wire diameter (mm) | Finished dimensions (mm) |        |        |        | Weight (g) TYP. | DC resistance (mΩ) MAX. | Shape  |
|--------------|---------------|-------------------|------------|-------------|--------------------|--------------------------|--------|--------|--------|-----------------|-------------------------|--------|
|              |               |                   | 10kHz MIN. | 100kHz MIN. |                    | A MAX.                   | B MAX. | F REF. | G REF. |                 |                         |        |
| F1AH0837     | FM03R832MBPF  | 3                 | 32.6       | 8.3         | 0.7                | 34                       | 25     | 30     | 12     | 40              | 98                      | Fig.33 |
| F1AH0838     | FM05R302MBPF  | 5                 | 12.0       | 3.0         | 0.9                | 34                       | 25     | 30     | 12     | 47              | 32                      | Fig.33 |
| F1AH0839     | FM10J462MBPF  | 10                | 16.6       | 4.6         | 1.4                | 61                       | 37     | 50     | 35     | 155             | 20                      | Fig.33 |
| F1AH0840     | FM15J322MBPF  | 15                | 11.5       | 3.2         | 1.8                | 61                       | 37     | 50     | 35     | 180             | 10                      | Fig.33 |
| F1AH0841     | FM20J172MBPF  | 20                | 6.2        | 1.7         | 2.1                | 61                       | 38     | 50     | 35     | 165             | 6                       | Fig.33 |
| F1AH0842     | FM20N242MBPF  | 20                | 8.6        | 2.4         | 2.3                | 66                       | 39     | 60     | 40     | 241             | 6                       | Fig.33 |
| F1AH0843     | FM20O472MBPF  | 20                | 16.8       | 4.7         | 2.0                | 89                       | 42     | 75     | 45     | 335             | 12                      | Fig.33 |
| F1AH0844     | FM25J112MBPF  | 25                | 4.1        | 1.1         | 2.3                | 63                       | 37     | 50     | 35     | 174             | 4                       | Fig.33 |
| F1AH0845     | FM25O302MBPF  | 25                | 10.7       | 3.0         | 2.3                | 89                       | 43     | 75     | 45     | 345             | 8                       | Fig.33 |
| F1AH0846     | FM30K252MBPF* | 30                | 8.8        | 2.5         | 2.5                | 74                       | 49     | 64     | 32     | 375             | 6                       | Fig.34 |
| F1AH0847     | FM30O232MBPF  | 30                | 8.2        | 2.3         | 2.6                | 89                       | 40     | 75     | 45     | 390             | 6                       | Fig.33 |
| F1AH0848     | FM40K142MBPF* | 40                | 5.0        | 1.4         | 2.7                | 78                       | 49     | 64     | 32     | 345             | 4                       | Fig.34 |
| F1AH0849     | FM50K601MBPF* | 50                | 2.2        | 0.6         | 2.8                | 74                       | 49     | 64     | 32     | 303             | 3                       | Fig.34 |

- UL94 V-0 certified resin is used for these cores and base plates.
- Lead-free solder is used for the winding coils.
- Custom made products are available.
- \* Temperature rise: 80°C(projected value)



# Common Mode Chokes

For three-phase AC power lines

Three-phase FM coils



Figure 33. FM□□□□□□MBPF



Figure 35. Circuit diagram



Figure 34. FM□□K□□□□MBPF



Figure 36. Frequency dependence of impedance for three-phase FM coils with rated current 3A-10A



Figure 37. Frequency dependence of impedance for three-phase FM coils with rated current 15A-20A



Figure 38. Frequency dependence of impedance for three-phase FM coils with rated current 25A-30A



Figure 39. Frequency dependence of impedance for three-phase FM coils with rated current 40A-50A



# Common Mode Chokes

For three-phase AC power lines

## Three-phase FM-H coils

FM-H coils are compact common mode chokes having excellent noise suppression properties for three-phase AC 400V power lines.



Three-phase FM-H coils

Table 11. Standard Specifications

| Item                        | Specification  |
|-----------------------------|--|
| Rated voltage               | AC415V   |
| Insulation voltage rating   | AC2kV for 1min. or AC2.4kV for 3 sec. (line-line)      |
| Insulation resistance       | Over 100MΩ after applying DC500V for 1min. (line-line) |
| Insulation grade            | Class B (130°C)  |
| Temperature rise            | *60°C  |
| Operating temperature range | -40°C - +130°C (including temperature rise of core)    |

- The above specifications are in accordance with Electrical Appliance and Material Control Law, UL, CSA and IEC standards.
- No Ozone Layer Depleting Chemicals are used in these products or in their manufacturing process.
- \* Note 1: The temperature rise in the above table is a projected value based on temperature rise by the heat of the coil when the rated current (DC or 50/60Hz) in the table below is conducted.
- \* Note 2: The temperature rise is affected by the mounting condition on the circuit board and the amount of harmonic distortion on the load current. Please make sure the temperature of the coil and the terminals not to exceed the operating temperature range.

Table 12. Product code, part name and specifications

| Product code | P/N            | Rated current (A) | L (mH)     |             | Wire diameter (mm) | Finished dimensions (mm) |        |        |        | Weight (g) TYP. | DC resistance (mΩ) MAX. |
|--------------|----------------|-------------------|------------|-------------|--------------------|--------------------------|--------|--------|--------|-----------------|-------------------------|
|              |                |                   | 10kHz MIN. | 100kHz MIN. |                    | A MAX.                   | B MAX. | F REF. | G REF. |                 |                         |
| F1AH0884     | FM-H15O672MBPF | 15                | 24.1       | 6.7         | 1.8                | 85                       | 52     | 75     | 40     | 370             | 17.0                    |
| F1AH0885     | FM-H20O472MBPF | 20                | 16.8       | 4.7         | 2.2                |                          |        |        |        | 410             | 9.5                     |
| F1AH0886     | FM-H25O302MBPF | 25                | 10.7       | 3.0         | 2.4                |                          |        |        |        | 410             | 6.5                     |
| F1AH0887     | FM-H30O232MBPF | 30                | 8.2        | 2.3         | 2.8                |                          |        |        |        | 440             | 4.5                     |

- UL94 V-0 certified resin is used for these cores and base plates.
- Lead-free solder is used for the winding coils.
- Custom made products are available.



Figure 40. FM-H□□□□□PF



Figure 41. Circuit diagram



Figure 42. Frequency dependence of impedance



For safety and the proper usage, you are requested to approve our product specifications or to transact the approval sheet for product specifications before ordering. This catalog and its contents are subject to change without notice.

## Common Mode Chokes

For three-phase AC power lines

### Three-phase FN coils

FN coils made with FT-3KM F series cores (P23) are compact three phase common modes chokes having excellent noise suppression properties for rated current over 100 Ampere.



Table 13. Standard Specifications

| Item                        | Specification   |
|-----------------------------|---|
| Rated voltage               | AC600V  |
| Insulation voltage rating   | AC2kV for 1min. or AC2.4kV for 3 sec. (line-line)   |
| Insulation resistance       | Over 100MΩ after applying DC500V for 1min. (line-line)  |
| Temperature rise (coil)     | Refer to each specification   |
| Operating temperature range | Coil : -30°C - +120°C (including temperature rise of core)<br>Terminal : -30°C - +80°C (including temperature rise of core) |

- The above specifications are in accordance with Electrical Appliance and Material Control Law, UL, CSA and IEC standards.
- No Ozone Layer Depleting Chemicals are used in these products or in their manufacturing process.
- \* Note 1: The temperature rise in the above table is a projected value based on temperature rise by the heat of the coil when the rated current (DC or 50/60Hz) in the table below is conducted.
- \* Note 2: The temperature rise is affected by the mounting condition on the circuit board and the amount of harmonic distortion on the load current. Please make sure the temperature of the coil and the terminals not to exceed the operating temperature range.

Table 14. Product code, part name and specifications

| Product code | P/N         | Rated current (A) | L (mH)     |             | Finished dimensions (mm) |      |        |        |     | Weight (kg) TYP. | DC resistance (mΩ) MAX. | Temp. rise (°C) |
|--------------|-------------|-------------------|------------|-------------|--------------------------|------|--------|--------|-----|------------------|-------------------------|-----------------|
|              |             |                   | 10kHz REF. | 100kHz ±30% | A ±1                     | B ±1 | C MAX. | F REF. | H   |                  |                         |                 |
| F1AH0033     | FN100I102MB | 100               | 4.5        | 1.2         | 320                      | 160  | 150    | 24.5   | M8  | 4                | 1.0                     | 60              |
| F1AH0039     | FN100I202MB | 100               | 9.0        | 2.3         | 350                      | 160  | 150    | 24.5   | M8  | 5                | 1.3                     | 60              |
| F1AH0034     | FN150I102MB | 150               | 4.5        | 1.2         | 320                      | 160  | 150    | 27.0   | M8  | 4                | 0.7                     | 60              |
| F1AH0040     | FN150J202MB | 150               | 13.0       | 3.2         | 400                      | 210  | 200    | 45.0   | M10 | 8                | 1.3                     | 60              |
| F1AH0035     | FN200J102MB | 200               | 5.0        | 1.2         | 400                      | 210  | 200    | 45.0   | M10 | 8                | 0.7                     | 60              |
| F1AH0041     | FN200J202MB | 200               | 10.0       | 2.4         | 400                      | 210  | 200    | 45.0   | M10 | 9                | 0.8                     | 60              |
| F1AH0036     | FN300J102MB | 300               | 5.0        | 1.2         | 450                      | 210  | 200    | 45.0   | M10 | 11               | 0.4                     | 70              |
| F1AH0042     | FN300J202MB | 300               | 10.0       | 2.5         | 520                      | 210  | 200    | 45.0   | M10 | 15               | 0.8                     | 70              |
| F1AH0679     | FN600K152MB | 600               | 5.0        | 1.5         | 650                      | 300  | 270    | 63.0   | M16 | 32               | 0.2                     | 70              |

- Custom made products are available.
- These are lead-free products.

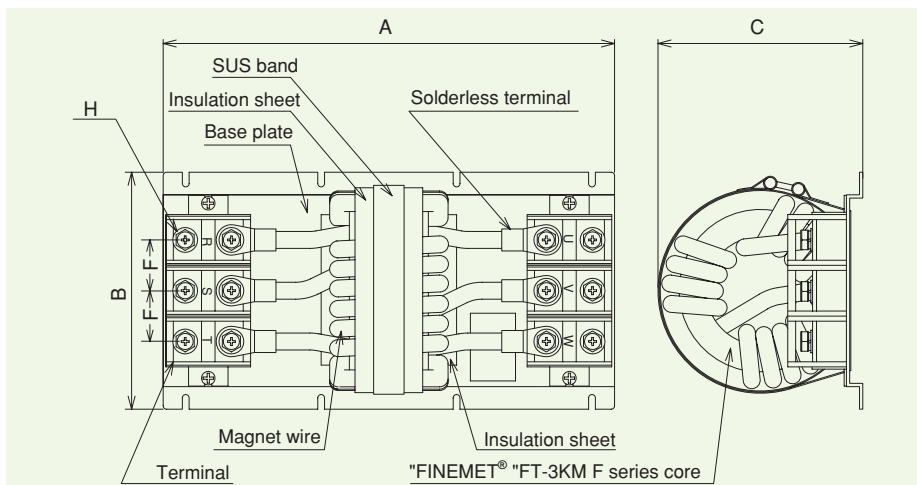

Figure 43. FN coil



Figure 44. Circuit diagram







Figure 45. Frequency dependence of impedance for three-phase FN coils with rated current 100A



Figure 46. Frequency dependence of impedance for three-phase FN coils with rated current 150A



Figure 47. Frequency dependence of impedance for three-phase FN coils with rated current 200A



Figure 48. Frequency dependence of impedance for three-phase FN coils with rated current 300A

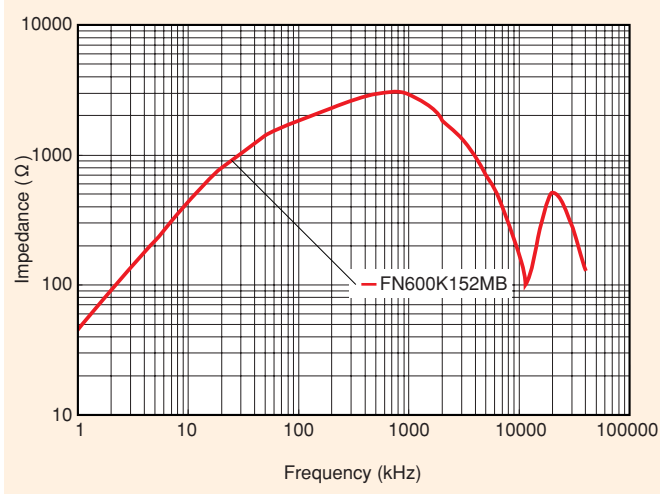

Figure 49. Frequency dependence of impedance for three-phase FN coils with rated current 600A



# Common Mode Choke Cores

In the product line of FINEMET® common mode choke cores, there are two types of cores made of (1) high permeability material "FT-3KM" and (2) high saturation-field material "FT-3KL". Both cores have high impedance in wide frequency range.

## Features for cores made of "FT-3KM"

The cores made of high permeability FT-3KM have the following advantages over commonly used Mn-Zn ferrite cores:

- Four times higher impedance due to high impedance permeability,
  - The real part of complex permeability ( $\mu_r'$ ) at 100kHz and 20°C reaches more than twice as high as that of Mn-Zn ferrite cores. The impedance relative permeability ( $\mu_{rZ}$ ) including imaginary part of complex permeability ( $\mu_r''$ ) reaches more than four times as high as that of Mn-Zn ferrite cores.
  - The cores shows following benefits (Table 15, Figure 50, 51):
    - The coils have four times higher impedance with same winding turns.
    - Winding turns can be 1/2 reduced to obtain same impedance.
    - Reducing winding turns allow significant reduction of stray capacitance, which result in having large impedance in high frequency range.
- Stable magnetic properties against temperature change. Inductance and impedance of the common mode chokes are very stable against temperature change due to high Curie temperature. (Figure 52, 53).

Table 15. Comparison of magnetic and physical properties between FINEMET® and Mn-Zn ferrite

|   |       | FT-3KM            | FT-3KL            | Mn-Zn ferrite      |
|---|-------|-------------------|-------------------|--------------------|
| Initial permeability, $\mu_r'$                                | 20°C  | 17,000            | 17,000            | 5,300              |
|   | 100°C | 18,000            | 15,000            | 7,000              |
| Impedance permeability, $\mu_{rZ}$                            | 20°C  | 26,900            | 18,500            | 5,300              |
|   | 100°C | 27,100            | 16,000            | 7,000              |
| Saturation magnetic flux density, $B_s^*$ (T)                 | 20°C  | 1.23              | 1.23              | 0.44               |
|   | 100°C | 1.20              | 1.20              | 0.27               |
| Residual magnetic flux density, $B_r^*$ (T)                   | 20°C  | 0.62              | 0.06              | 0.10               |
|   | 100°C | 0.59              | 0.04              | 0.06               |
| Coercive force, $H_c^*$ (A/m)                                 | 20°C  | 2.5               | 0.6               | 8.0                |
|   | 100°C | 2.7               | 0.6               | 4.9                |
| Curie temperature, $T_c$ (°C)                                 |       | 570               | 570               | 150                |
| Saturation magnetostriction, $\lambda_s$ [ $\times 10^{-6}$ ] |       | $\approx 0.0$     | $\approx 0.0$     | -1.1               |
| Electrical resistivity, $\rho$ ( $\mu \Omega \cdot m$ )       |       | 1.2               | 1.2               | $1.0 \times 10^6$  |
| Density, $d$ (kg/m <sup>3</sup> )                             |       | $7.3 \times 10^3$ | $7.3 \times 10^3$ | $4.85 \times 10^3$ |

\* DC magnetic properties at 800A/m



Figure 50.  $\mu_{rZ}$ ,  $\mu_r'$  and  $\mu_r''$  for FINEMET® FT-3KM



Figure 51.  $\mu_{rZ}$ ,  $\mu_r'$  and  $\mu_r''$  for Mn-Zn ferrite



Figure 52. Temperature dependence of impedance permeability ( $\mu_{rZ}$ ) for FINEMET® FT-3KM



Figure 53. Temperature dependence of impedance permeability ( $\mu_{rZ}$ ) for Mn-Zn ferrite



### Features for cores made of "FT-3KL"

The cores made of FT-3KL with high saturation-field property have the following advantages:

- 1) High saturation-field and low residual magnetic flux density in B-H curve

The cores have excellent DC superposed characteristics due to its high permeability and high saturation-field property in B-H curve (Figure 54, 55).

The cores can suppress surge current with high volt-second due to high maximum induction swing ( $\Delta B_m$ ) resulting from low residual magnetic flux density (Figure 56).

- 2) High impedance over wide frequency range.

These cores have excellent performance in noise reduction in wide frequency range from conduction noise to radiation noise. In particular, these cores show high performance in noise reduction at 1MHz-100MHz due to higher impedance than other materials (Figure 57).



Figure 54. DC-BH Curves



Figure 55. DC superposed characteristics of impedance permeability,  $\mu_r Z$

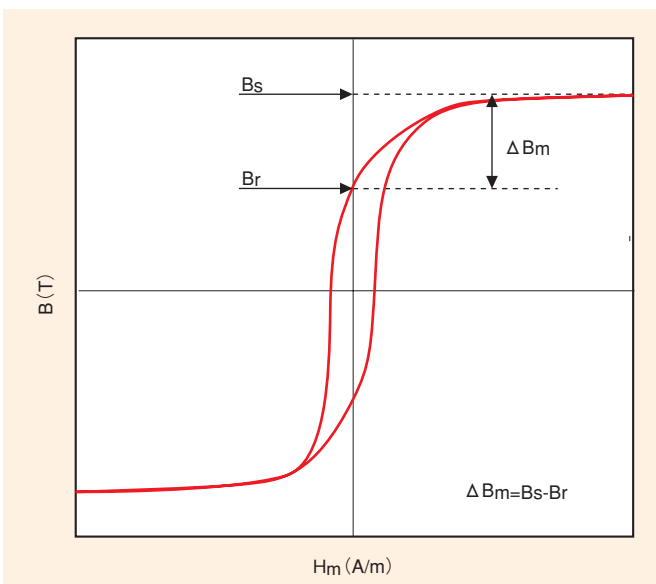

Figure 56. Maximum induction swing,  $\Delta B_m$

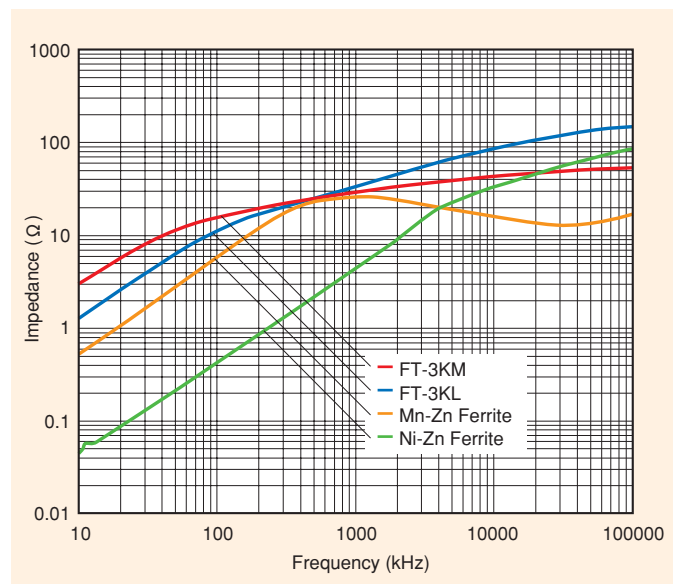

Figure 57. Frequency dependence of impedance



## Common Mode Choke Cores

For signal lines, DC and single-phase AC power lines

### ● FT-3KM K series

FT-3KM K series cores made of FT-3KM material are for common mode chokes for signal lines, DC and single-phase AC power lines.



Table 16. Product code, part name and specifications

| Product code | P/N           | Finished dimensions (mm) |                |                |                |           |           |           | $A_e$<br>(mm <sup>2</sup> )<br>TYP. | $L_m$<br>(mm)<br>TYP. | Weight<br>(g)<br>TYP. | AL value ( $\mu\text{H}/\text{N}^2$ ) |                      |
|--------------|---------------|--------------------------|----------------|----------------|----------------|-----------|-----------|-----------|-------------------------------------|-----------------------|-----------------------|---------------------------------------|----------------------|
|              |               | A<br>$\pm 0.7$           | B<br>$\pm 0.7$ | C<br>$\pm 0.5$ | D<br>$\pm 0.7$ | E<br>REF. | F<br>REF. | G<br>REF. |                                     |                       |                       | 10kHz<br>MIN.                         | 100kHz<br>$\pm 30\%$ |
| F1AH0538     | FT-3KM K1208A | 13.0                     | 7.1            | 6.0            | 10.7           | 2.6       | —         | 1.8       | 7.7                                 | 30.3                  | 2.9                   | 18.2                                  | 5.8                  |
| F1AH0692     | FT-3KM K1208C | 13.5                     | 12.5           | 6.8            | 15.5           | 3.0       | —         | 1.5       | 13.3                                | 31.7                  | 4.5                   | 24.0                                  | 8.8                  |
| F1AH0654     | FT-3KM K1812A | 20.2                     | 8.1            | 10.3           | 13.1           | 3.5       | —         | 2.5       | 11.3                                | 47.1                  | 5.8                   | 14.7                                  | 5.3                  |
| F1AH0693     | FT-3KM K1912C | 21.1                     | 13.3           | 10.0           | 18.3           | 3.5       | —         | 2.5       | 24.4                                | 48.9                  | 13.0                  | 28.2                                  | 10.6                 |
| F1AH0694     | FT-3KM K2313D | 25.2                     | 15.1           | 11.5           | 20.7           | 4.0       | —         | 2.8       | 43.9                                | 57.3                  | 23.0                  | 41.6                                  | 15.3                 |
| F1AH0695     | FT-3KM K2214B | 24.2                     | 10.6           | 12.0           | 16.2           | 4.0       | —         | 2.8       | 22.2                                | 56.5                  | 13.0                  | 22.2                                  | 8.1                  |
| F1AH0696     | FT-3KM K2515D | 27.2                     | 15.6           | 13.0           | 21.2           | 3.5       | —         | 2.8       | 46.3                                | 62.8                  | 26.0                  | 41.6                                  | 15.3                 |
| F1AH0697     | FT-3KM K2818E | 30.4                     | 18.0           | 15.8           | 24.0           | 3.5       | 1.5       | 3.0       | 55.5                                | 72.3                  | 37.0                  | 43.4                                  | 15.9                 |
| F1AH0699     | FT-3KM K3819D | 40.4                     | 15.5           | 16.8           | 23.5           | 4.0       | 2.0       | 4.0       | 87.9                                | 89.5                  | 68.0                  | 55.5                                  | 20.4                 |
| F1AH0700     | FT-3KM K3824G | 40.6                     | 23.0           | 21.4           | 31.0           | 4.0       | 2.0       | 4.0       | 105.0                               | 97.4                  | 87.0                  | 61.0                                  | 24.4                 |
| F1AH0701     | FT-3KM K5328E | 56.4                     | 19.0           | 24.6           | 29.0           | 5.5       | 2.0       | 5.0       | 127.5                               | 114.7                 | 155.0                 | 62.5                                  | 25.0                 |

- UL94 V-0 certified resin (130°C of heat resistance) is used for these core cases.
- No Ozone Layer Depleting Chemicals are used in these products or in their manufacturing process.
- $A_e$ : effective cross-section area,  $L_m$ : mean magnetic path length



Figure 58. FT-3KM K series core



## Common Mode Choke Cores

For signal lines, DC and single-phase AC power lines

### ● FT-3KL V series

FT-3KL V series cores made of FT-3KL material are for common mode chokes for signal lines, DC and single-phase AC power lines.

Having both high impedance and high saturation-field property, these cores shows high performance in reduction of radiation noise.

With new design of inner structure, these cores have high durability against vibration.



Table 17. Product code, part name and specifications

| Product code | P/N           | Finished dimensions (mm) |           |           |           |      |      |      | $A_e$<br>(mm <sup>2</sup> )<br>TYP. | $L_m$<br>(mm)<br>TYP. | Weight<br>(g)<br>TYP. | AL value ( $\mu\text{H}/\text{N}^2$ ) |            |
|--------------|---------------|--------------------------|-----------|-----------|-----------|------|------|------|-------------------------------------|-----------------------|-----------------------|---------------------------------------|------------|
|              |               | A                        | B         | C         | D         | E    | F    | G    |                                     |                       |                       | 10kHz                                 | 100kHz     |
|              |               | $\pm 0.7$                | $\pm 0.7$ | $\pm 0.5$ | $\pm 0.7$ | REF. | REF. | REF. |                                     |                       |                       | MIN.                                  | $\pm 30\%$ |
| F1AH0970     | FT-3KL V1208C | 13.5                     | 12.5      | 6.8       | 15.5      | 3.0  | —    | 1.5  | 13.7                                | 31.9                  | 4.5                   | 8.7                                   | 9.1        |
| F1AH0971     | FT-3KL V1912C | 21.1                     | 13.3      | 10.0      | 18.3      | 3.5  | —    | 2.5  | 25.4                                | 48.9                  | 13.0                  | 10.5                                  | 11.1       |
| F1AH0972     | FT-3KL V2515D | 27.2                     | 15.6      | 13.0      | 21.2      | 3.5  | —    | 2.8  | 47.3                                | 63.3                  | 26.0                  | 15.1                                  | 16.0       |

- UL94 V-0 certified resin (130°C of heat resistance) is used for these core cases.
- No Ozone Layer Depleting Chemicals are used in these products or in their manufacturing process.
- $A_e$ : effective cross-section area,  $L_m$ : mean magnetic path length



Figure 59. FT-3KL V series core



Figure 60. Frequency dependence of impedance for FT-3KL V series core



For safety and the proper usage, you are requested to approve our product specifications or to transact the approval sheet for product specifications before ordering. This catalog and its contents are subject to change without notice.

## Common Mode Choke Cores

For three-phase AC power lines

### ● FT-3KM N series

FT-3KM N series cores made of FT-3KM material are for common mode chokes for three-phase AC power lines.



Table 18. Product code, part name and specifications

| Product code | P/N           | Finished dimensions (mm) |           |           |           |      |      |      | $A_e$<br>(mm <sup>2</sup> )<br>TYP. | $L_m$<br>(mm)<br>TYP. | Weight<br>(g)<br>TYP. | AL value ( $\mu\text{H}/\text{N}^2$ ) |            |
|--------------|---------------|--------------------------|-----------|-----------|-----------|------|------|------|-------------------------------------|-----------------------|-----------------------|---------------------------------------|------------|
|              |               | A                        | B         | C         | D         | E    | F    | G    |                                     |                       |                       | 10kHz                                 | 100kHz     |
|              |               | $\pm 0.7$                | $\pm 0.7$ | $\pm 0.5$ | $\pm 0.7$ | REF. | REF. | REF. |                                     |                       |                       | MIN.                                  | $\pm 30\%$ |
| F1AH0702     | FT-3KM N2515D | 27.6                     | 16.0      | 12.6      | 22.0      | 3.2  | 1.0  | 3.0  | 46.9                                | 62.8                  | 28                    | 41.6                                  | 15.3       |
| F1AH0703     | FT-3KM N3320E | 35.6                     | 19.0      | 17.4      | 27.0      | 3.2  | 1.5  | 4.0  | 73.1                                | 73.3                  | 56                    | 49.7                                  | 19.9       |
| F1AH0704     | FT-3KM N4225E | 46.0                     | 19.0      | 21.0      | 27.0      | 4.0  | 3.0  | 4.0  | 95.6                                | 105.2                 | 95                    | 51.4                                  | 20.6       |
| F1AH0705     | FT-3KM N5034E | 54.0                     | 19.0      | 30.0      | 29.0      | 4.0  | —    | 5.0  | 90.0                                | 131.9                 | 110                   | 38.6                                  | 15.4       |
| F1AH0706     | FT-3KM N6442E | 68.0                     | 19.0      | 38.0      | 29.0      | 5.0  | —    | 5.0  | 123.8                               | 166.5                 | 184                   | 42.0                                  | 16.8       |
| F1AH0708     | FT-3KM N5434G | 58.0                     | 25.0      | 30.0      | 47.0      | 6.2  | 8.0  | 7.0  | 150.0                               | 138.0                 | 210                   | 61.4                                  | 24.5       |

- UL94 V-0 certified resin (130°C of heat resistance) is used for these core cases.
- No Ozone Layer Depleting Chemicals are used in these products or in their manufacturing process.
- $A_e$ : effective cross-section area,  $L_m$ : mean magnetic path length



Figure 61. FT-3KM N series core except FT-3KM N5434G



Figure 62. FT-3KM N5434G



## Common Mode Choke Cores

For signal lines, DC and AC power lines and Output filters

### ● FT-3KM F series

FT-3KM F series cores made of FT-3KM material are for common mode chokes for signal lines, DC and AC power lines.



Table 19. Product code, part name and specifications (Toroidal type: Figure 63)

| Product code | P/N            | Finished dimensions (mm) |          |           | A <sub>e</sub><br>(mm <sup>2</sup> )<br>TYP. | L <sub>m</sub><br>(mm)<br>TYP. | Weight<br>(g)<br>TYP. | AL value (μH/N <sup>2</sup> ) |               |
|--------------|----------------|--------------------------|----------|-----------|--|--------------------------------|-----------------------|-------------------------------|---------------|
|              |                | A                        | B        | C         |  |                                |                       | 10kHz                         | 100kHz        |
| F1AH0047     | FT-3KM F2515D  | 28.0±0.5                 | 16.8±0.7 | 12.8±0.5  | 46.9   | 62.8                           | 25                    | 42.0~100.0                    | 16.9±30%      |
| F1AH0048     | FT-3KM F3320E  | 35.8±0.5                 | 17.5±0.7 | 17.3±0.5  | 73.1   | 83.3                           | 49                    | 49.7~120.0                    | 19.9±30%      |
| F1AH0049     | FT-3KM F3724E  | 40.0±0.5                 | 17.6±0.7 | 21.1±0.5  | 73.1   | 95.8                           | 59                    | 43.0~100.0                    | 17.3±30%      |
| F1AH0050     | FT-3KM F4424G  | 46.5±0.6                 | 22.8±0.6 | 21.5±0.5  | 142.5  | 106.8                          | 123                   | 75.4~180.0                    | 30.2±30%      |
| F1AH0896     | FT-3KM F4535G  | 49.0±0.5                 | 25.0±0.7 | 31.0±0.5  | 75.0   | 125.7                          | 89                    | 34.0~ 80.0                    | 13.5±30%      |
| F1AH0897     | FT-3KM F4627H  | 50.0±0.7                 | 28.2±1.0 | 23.4±0.5  | 178.1  | 114.7                          | 168                   | 89.2~210.0                    | 35.1±30%      |
| F1AH0898     | FT-3KM F6045G  | 64.0±0.7                 | 25.0±1.0 | 41.0±0.7  | 112.5  | 164.9                          | 162                   | 39.0~ 90.0                    | 15.4±30%      |
| F1AH0899     | FT-3KM F7555G  | 79.0±0.7                 | 25.0±0.7 | 51.0±0.7  | 150.0  | 204.2                          | 267                   | 42.0~100.0                    | 16.6±30%      |
| F1AH0900     | FT-3KM F10080G | 104.0±0.7                | 25.0±0.7 | 76.0±0.7  | 138.8  | 285.1                          | 336                   | 30.0~ 65.0                    | 12.0±30%      |
| F1AH0901     | FT-3KM F140100 | 144.0±1.0                | 35.0±1.0 | 96.0±0.7  | 427.5  | 380.1                          | 1335                  | 63.0~150.0                    | 24.8±30%      |
| F1AH0024     | FT-3KM F200160 | 204.0±1.0                | 35.0±1.0 | 156.0±1.0 | 427.5  | 568.6                          | 1875                  | 42.0~100.0                    | 15.1+50%,-30% |

Table 20. Product code, part name and specifications (Base plate type: Figure 64, 65)

| Product code | P/N              | Finished dimensions (mm) |           |           |           |           |           |           |           |           |
|--------------|------------------|--------------------------|-----------|-----------|-----------|-----------|-----------|-----------|-----------|-----------|
|              |                  | A<br>MAX.                | B<br>MAX. | C<br>MAX. | D<br>±0.5 | E<br>±0.3 | F<br>±0.5 | G<br>±0.5 | H<br>±0.5 | K<br>MIN. |
| F1AH0026     | FT-3KM F6045GB   | 95.0                     | 26.0      | 78.0      | 80.0      | 12.5      | 72.0      | 50.0      | 7.0       | 39.5      |
| F1AH0903     | FT-3KM F7555GB   | 121.0                    | 30.0      | 100.0     | 100.0     | —         | —         | —         | —         | 50.0      |
| F1AH0904     | FT-3KM F10080GB  | 161.0                    | 32.0      | 122.0     | 140.0     | —         | —         | —         | —         | 75.0      |
| F1AH0029     | FT-3KM F11080GB  | 181.0                    | 26.0      | 131.0     | 150.0     | 12.5      | 124.0     | 100.0     | 20.0      | 74.0      |
| F1AH0905     | FT-3KM F140100PB | 181.0                    | 42.0      | 162.0     | 160.0     | —         | —         | —         | —         | 95.0      |
| F1AH0032     | FT-3KM F200160PB | 241.0                    | 42.0      | 217.0     | 220.0     | —         | —         | —         | —         | 155.0     |

|          | P/N              | A <sub>e</sub> (mm <sup>2</sup> )<br>TYP. | L <sub>m</sub> (mm)<br>TYP. | Weight (g)<br>TYP. | Applied screw |    | AL value (μH/N <sup>2</sup> ) |               | Shape  |
|----------|------------------|---|-----------------------------|--------------------|---------------|----|-------------------------------|---------------|--------|
|          |                  |   |                             |                    | I             | J  | 10kHz                         | 100kHz        |        |
| F1AH0026 | FT-3KM F6045GB   | 112.5                                     | 164.9                       | 193                | M4            | M5 | 39.0~ 90.0                    | 15.4±30%      | Fig.65 |
| F1AH0903 | FT-3KM F7555GB   | 150.0                                     | 204.2                       | 377                | —             | M6 | 42.0~100.0                    | 16.6±30%      | Fig.64 |
| F1AH0904 | FT-3KM F10080GB  | 138.8                                     | 285.1                       | 516                | —             | M6 | 30.0~ 65.0                    | 12.0±30%      | Fig.64 |
| F1AH0029 | FT-3KM F11080GB  | 213.8                                     | 300.8                       | 613                | M5            | M6 | 40.2~ 95.0                    | 16.1±30%      | Fig.65 |
| F1AH0905 | FT-3KM F140100PB | 427.5                                     | 380.1                       | 1595               | —             | M6 | 63.0~150.0                    | 24.8±30%      | Fig.64 |
| F1AH0032 | FT-3KM F200160PB | 427.5                                     | 568.6                       | 2235               | —             | M6 | 42.0~100.0                    | 15.1+50%,-30% | Fig.64 |

- UL94 V-0 certified resin (130°C of heat resistance) is used for these core cases.
- No Ozone Layer Depleting Chemicals are used in these products or in their manufacturing process.
- A<sub>e</sub>: effective cross-section area, L<sub>m</sub>: mean magnetic path length



Figure 63. Toroidal type



Figure 64. Base plate type  
The core is fixed onto the zinc-electroplated SPCC base by using SUS 304 stainless steel band.



Figure 65. Base combined type



For safety and the proper usage, you are requested to approve our product specifications or to transact the approval sheet for product specifications before ordering. This catalog and its contents are subject to change without notice.

# Common Mode Choke Cores

For signal lines, DC and AC power lines and Output filters

FT-3KM F series



Figure 66. Frequency dependence of impedance for FT-3KM F2515D and F3320E



Figure 67. Frequency dependence of impedance for FT-3KM F3724E and F4424G



Figure 68. Frequency dependence of impedance for FT-3KM F4535G and F4627H



Figure 69. Frequency dependence of impedance for FT-3KM F6045G(B) and F7555G(B)



Figure 70. Frequency dependence of impedance for FT-3KM F10080G(B) and F11080GB



Figure 71. Frequency dependence of impedance for FT-3KM F14100(PB) and F220160(PB)





## Common Mode Choke Cores

For signal lines, DC and AC power lines and Output filters

### ● FT-3KL F series

FT-3KL F series are common mode choke cores with high saturation-field property.

Having both high permeability and high saturation-field property, these cores show significant noise reduction even under high bias current.



Table 21. Product code, part name and specifications (Toroidal type: Figure 72)

| Product code | P/N            | Finished dimensions (mm) |          |          | A <sub>e</sub><br>(mm <sup>2</sup> )<br>TYP. | L <sub>m</sub><br>(mm)<br>TYP. | Weight<br>(g)<br>TYP. | AL value (μH/N <sup>2</sup> ) |          |
|--------------|----------------|--------------------------|----------|----------|--|--------------------------------|-----------------------|-------------------------------|----------|
|              |                | A                        | B        | C        |  |                                |                       | 10kHz                         | 100kHz   |
| F1AH0680     | FT-3KL F3320E  | 35.8±0.5                 | 17.5±0.7 | 17.3±0.5 | 73.1   | 83.3                           | 49                    | 17.8~33.0                     | 18.8±30% |
| F1AH0681     | FT-3KL F3724E  | 40.0±0.5                 | 17.6±0.7 | 21.1±0.5 | 73.1   | 95.8                           | 59                    | 15.4~28.7                     | 16.3±30% |
| F1AH0682     | FT-3KL F4535G  | 49.0±0.5                 | 25.0±0.7 | 31.0±0.5 | 75.0   | 125.7                          | 89                    | 12.1~22.4                     | 12.8±30% |
| F1AH0683     | FT-3KL F6045G  | 64.0±0.7                 | 25.0±1.0 | 41.0±0.7 | 107.3  | 166.0                          | 162                   | 13.1~24.3                     | 13.8±30% |
| F1AH0684     | FT-3KL F7555G  | 79.0±0.7                 | 25.0±0.7 | 51.0±0.7 | 146.3  | 205.0                          | 267                   | 14.4~26.8                     | 15.2±30% |
| F1AH0685     | FT-3KL F10080G | 104.0±0.7                | 25.0±0.7 | 76.0±0.7 | 138.3  | 285.1                          | 336                   | 9.8~18.3                      | 10.4±30% |
| F1AH0686     | FT-3KL F140100 | 144.0±1.0                | 35.0±1.0 | 96.0±0.7 | 427.5  | 380.1                          | 1335                  | 22.8~42.3                     | 24.0±30% |

Table 22. Product code, part name and specifications (Base plate type: Figure 73, 74)

| Product code | P/N              | Finished dimensions (mm) |           |           |           |           |           |           |           |           |
|--------------|------------------|--------------------------|-----------|-----------|-----------|-----------|-----------|-----------|-----------|-----------|
|              |                  | A<br>MAX.                | B<br>MAX. | C<br>MAX. | D<br>±0.5 | E<br>±0.3 | F<br>±0.5 | G<br>±0.5 | H<br>±0.5 | K<br>MIN. |
| F1AH0687     | FT-3KL F6045GB   | 95.0                     | 26.0      | 78.0      | 80.0      | 12.5      | 72.0      | 50.0      | 7.0       | 39.5      |
| F1AH0688     | FT-3KL F7555GB   | 121.0                    | 30.0      | 100.0     | 100.0     | —         | —         | —         | —         | 50.0      |
| F1AH0690     | FT-3KL F11080GB  | 181.0                    | 26.0      | 131.0     | 150.0     | 12.5      | 124.0     | 100.0     | 20.0      | 74.0      |
| F1AH0691     | FT-3KL F140100PB | 181.0                    | 42.0      | 162.0     | 160.0     | —         | —         | —         | —         | 95.0      |

|          | P/N              | A <sub>e</sub> (mm <sup>2</sup> )<br>TYP. | L <sub>m</sub> (mm)<br>TYP. | Weight (g)<br>TYP. | Applied screw |    | AL value (μH/N <sup>2</sup> ) |          | Shape  |
|----------|------------------|---|-----------------------------|--------------------|---------------|----|-------------------------------|----------|--------|
|          |                  |   |                             |                    | I             | J  | 10kHz                         | 100kHz   |        |
| F1AH0687 | FT-3KL F6045GB   | 107.3                                     | 166.0                       | 193                | M4            | M5 | 13.1~24.3                     | 13.8±30% | Fig.74 |
| F1AH0688 | FT-3KL F7555GB   | 146.3                                     | 205.0                       | 377                | —             | M6 | 14.4~26.8                     | 15.2±30% | Fig.73 |
| F1AH0690 | FT-3KL F11080GB  | 213.8                                     | 300.8                       | 613                | M5            | M6 | 14.4~26.7                     | 15.2±30% | Fig.74 |
| F1AH0691 | FT-3KL F140100PB | 427.5                                     | 380.1                       | 1595               | —             | M6 | 22.8~42.3                     | 24.0±30% | Fig.73 |

- UL94 V-0 certified resin (130°C of heat resistance) is used for these core cases.
- No Ozone Layer Depleting Chemicals are used in these products or in their manufacturing process.
- A<sub>e</sub>: effective cross-section area, L<sub>m</sub>: mean magnetic path length



Figure 72. Toroidal type



Figure 73. Base plate type  
The core is fixed onto the zinc-electroplated SPCC base by using SUS 304 stainless steel band.



Figure 74. Base combined type



For safety and the proper usage, you are requested to approve our product specifications or to transact the approval sheet for product specifications before ordering. This catalog and its contents are subject to change without notice.

# Common Mode Choke Cores

For signal lines, DC and AC power lines and Output filters

FT-3KL F series



Figure 75. Frequency dependence of impedance for FT-3KL F3320E and F3724E



Figure 76. Frequency dependence of impedance for FT-3KL F4535G and F6045G(B)



Figure 77. Frequency dependence of impedance for FT-3KL F7555G(B) and F10080G



Figure 78. Frequency dependence of impedance for FT-3KL F11080GB and F140100(PB)



## Common Mode Choke Cores

For signal lines, DC and AC power lines and Output filters



### ● FT-3KM S series

FT-3KM S series "square shaped" common mode choke cores are designed specifically for bus bar systems. Unlike toroidal cores, these square shaped cores allow utilizing space effectively in a switchboard. In addition, these cores are far lighter weight compare to Mn-Zn ferrite cores with the same performance.

Table 23. Product code, part name and specifications

| Product code | P/N             | A <sub>e</sub><br>(mm <sup>2</sup> )<br>TYP. | L <sub>m</sub><br>(mm)<br>TYP. | Weight<br>(g)<br>TYP. | AL value (μH/N <sup>2</sup> ) |           |
|--------------|-----------------|--|--------------------------------|-----------------------|-------------------------------|-----------|
|              |                 |  |                                |                       | 10kHz                         | 100kHz    |
| F1AH0545     | FT-3KM S10085HB | 112.5  | 290.1                          | 410                   | 21.9~ 51.2                    | 9.3±30%   |
| F1AH0572     | FT-3KM S11080HB | 271.9  | 303.8                          | 765                   | 50.6~118.1                    | 21.35±30% |

- UL94 V-0 certified resin (130°C of heat resistance) is used for these core cases.
- No Ozone Layer Depleting Chemicals are used in these products or in their manufacturing process.
- A<sub>e</sub>: effective cross-section area, L<sub>m</sub>: mean magnetic path length



Figure 79. FT-3KL V series core

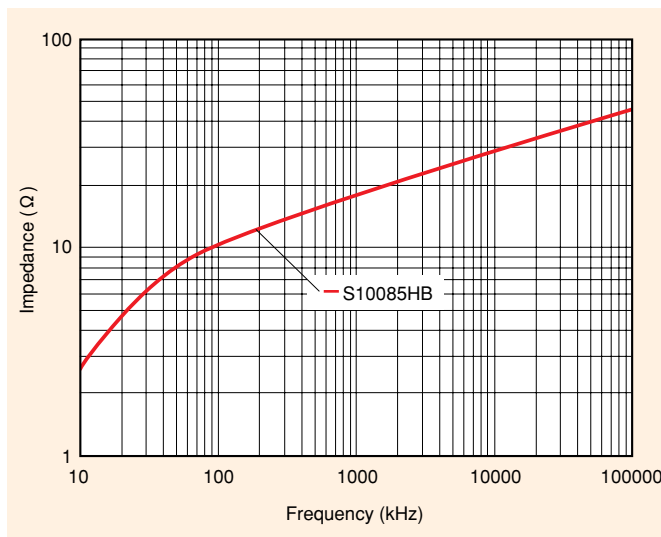

Figure 80. Frequency dependence of impedance for S10085HB



Figure 81. Frequency dependence of impedance for S11080HB



For safety and the proper usage, you are requested to approve our product specifications or to transact the approval sheet for product specifications before ordering. This catalog and its contents are subject to change without notice.

# Surge Absorber Cores

## Features

FINEMET<sup>®</sup> beads made of FT-3AM material and MP series saturable cores made of FT-3SH material are suitable for surge absorber used for medium to large handling power.

Having high saturation flux density ( $B_s=1.23T$ ) and low core loss (80Wkg at 100kHz,  $B_m=0.2T$ ), MP series cores are also suitable for saturable cores in magamp circuit driven below 150kHz.

Features of FT-3AM and FT-3SH cores:

- 1) The saturation magnetic flux density is twice as high as that of Co-based amorphous metal and three times higher than that of Ni-Zn ferrite. The pulse permeability and the core loss are comparable to Co-based amorphous metal. As a result, small-size cores using FT-3AM/FT-3SH offer higher performance in suppression of surge current and voltage.
- 2) The temperature characteristics of FINEMET<sup>®</sup> is very stable due to its high Curie temperature, (570°C). (Curie temperature of Co-based amorphous metal and Ni-Zn ferrite is around 200°C.)
- 3) Unlike Co-based amorphous metal, which has relatively large aging effects (decrease of permeability and increase of coercivity and core loss over time), the aging effects of FINEMET<sup>®</sup> is very small.

Table 24. Comparison of magnetic and physical properties among FT-3AM and conventional materials.

|   |       | FT-3AM            | FT-3SH            | Co-based amorphous | Ni-Zn ferrite      |
|---|-------|-------------------|-------------------|--------------------|--------------------|
| Saturation flux density, $B_s^*$ (T)                          | 20°C  | 1.23              | 1.23              | 0.60               | 0.38               |
|   | 100°C | 1.20              | 1.20              | 0.53               | 0.29               |
| Squareness ratio, $B_r/B_s^*$                                 | 20°C  | 0.50              | 0.90              | 0.80               | 0.71               |
|   | 100°C | 0.48              | 0.88              | 0.78               | 0.60               |
| Coercive force, $H_c^*$ (A/m)                                 | 20°C  | 2.5               | 0.60              | 0.30               | 30                 |
|   | 100°C | —                 | —                 | 0.29               | 20                 |
| Pulse permeability, $\mu_{rp}^{**}$                           |       | 3,500             | 4,000             | 4,500              | 500                |
| Core loss, $P_{cv}^{**}$ (J/m <sup>3</sup> )                  |       | 7.5               | 6.5               | 6.0                | 7.0                |
| Curie temperature, $T_c$ (°C)                                 |       | 570               | 570               | 210                | 200                |
| Saturation magnetostriction, $\lambda_s$ [ $\times 10^{-6}$ ] |       | $\simeq 0$        | $\simeq 0$        | $\simeq 0$         | -7.8               |
| Electrical resistivity, $\rho$ ( $\mu\Omega \cdot m$ )        |       | 1.2               | 1.2               | 1.3                | $1 \times 10^{12}$ |
| Density, $d$ (kg/m <sup>3</sup> )                             |       | $7.3 \times 10^3$ | $7.3 \times 10^3$ | $7.7 \times 10^3$  | $5.2 \times 10^3$  |

\*DC magnetic properties at 800A/m

\*\*Pulse width  $\tau_s=0.1 \mu s$  Operating magnetic flux density  $\Delta B=0.2T$

## Applications

1. Suppression of reverse recovery current and surge current from diode in switching mode power supplies or invertors.
2. Suppression of surge current at the moment of activation of switching diode, such as power MOS-FET.
3. Suppression of spike or ringing current generated in switching circuit.



## Surge Absorber Cores

For small handling power

### ● FINEMET® Beads

FINEMET® Beads made of FT-3AM material are small size bead cores which show excellent performance in suppression of various kinds of surge current, such as surge from a switching diode.



Table 25. Product code, part name and specifications (toroidal core)

| Product code | P/N            | Finished dimensions (mm) |          |          | $A_e$ (mm <sup>2</sup> )<br>TYP. | $L_m$ (mm)<br>TYP. | Weight (g)<br>TYP. | $2\phi_s$ ( $\mu$ Wb) MIN. |       | AL value ( $\mu$ H/N <sup>2</sup> )<br>100kHz |
|--------------|----------------|--------------------------|----------|----------|----------------------------------|--------------------|--------------------|----------------------------|-------|---|
|              |                | A                        | B        | C        |                                  |                    |                    | 25°C                       | 120°C |   |
| F1AH0432     | FT-3AM B3X *   | 4.0 MAX.                 | 5.0 MAX. | 1.6 TYP. | 1.13                             | 7.85               | 0.10               | 2.2                        | 2.0   | 2.0 MIN.                                      |
| F1AH0433     | FT-3AM B3AR ** | 4.0 MAX.                 | 7.0 MAX. | 1.6 TYP. | 1.88                             | 7.85               | 0.16               | 3.6                        | 3.4   | 3.3 MIN.                                      |
| F1AH0434     | FT-3AM B4AR ** | 5.0 MAX.                 | 7.0 MAX. | 1.6 TYP. | 3.75                             | 9.42               | 0.34               | 7.3                        | 6.9   | 5.5 MIN.                                      |

\* PBT

\*\* PPS

• UL94 V-0 certified resin is used for these core cases.

• No Ozone Layer Depleting Chemicals are used in these products or in their manufacturing process.

•  $A_e$ : effective cross-section area,  $L_m$ : mean magnetic path length



Figure 82. Toroidal core

Table 26. Product code, part name and specifications (lead wire core)

| Product code | P/N              | Finished dimensions (mm) |          |           |          |          |        |            |          | Weight (g)<br>TYP. |
|--------------|------------------|--------------------------|----------|-----------|----------|----------|--------|------------|----------|--------------------|
|              |                  | A                        | B        | C         | D        | E        | F      | G          | H        |                    |
| F1AH0675     | FT-3AM B4ARL-PF  | 5.0 MAX.                 | 7.0 REF. | 15.0 REF. | 3.0 MIN. | 7.0 MAX. | 5.0±1  | 1.0 $\phi$ | 2.0 MAX. | 0.52               |
| F1AH0676     | FT-3AM B4ARLY-PF | 5.0 MAX.                 | 7.0 MAX. | 3.0 MIN.  | 4.0±1    | —        | 15.0±1 | 1.0 $\phi$ | 2.8 MAX. | 0.56               |

•  $A_e$ ,  $L_m$ ,  $2\phi_s$ , AL value and core case are the same as FT-3AM B4AR.

• No Ozone Layer Depleting Chemicals are used in these products or in their manufacturing process.

• These are lead-free products.



Figure 83. Lead wire core



For safety and the proper usage, you are requested to approve our product specifications or to transact the approval sheet for product specifications before ordering. This catalog and its contents are subject to change without notice.

## Surge Absorber Cores

For medium-large handling power

# Saturable Core MP series

FINEMET® saturable cores MP series (using FT-3SH material) are suitable for surge absorber for medium to large handling power.

Having high saturation flux density ( $B_s=1.23T$ ) and low core loss (80W/kg at 100kHz,  $B_m=0.2T$ ), MP series cores are also suitable for saturable cores in magamp circuit driven below 150kHz.



Table 27. Standard Specifications

| Item                        | Specification                                       |
|-----------------------------|---|
| Operating temperature range | -20°C - +125°C (including temperature rise of core) |

Table 28. Product code, part name and specifications

| Product code | P/N          | Finished dimensions (mm) |           |           | $A_e$<br>(mm <sup>2</sup> )<br>TYP. | $L_m$<br>(mm)<br>TYP. | $2\phi_s$<br>( $\mu Wb$ )<br>MIN. | Weight<br>(g)<br>TYP. |
|--------------|--------------|--------------------------|-----------|-----------|-------------------------------------|-----------------------|-----------------------------------|-----------------------|
|              |              | A<br>TYP.                | B<br>TYP. | C<br>TYP. |                                     |                       |                                   |                       |
| F1AH0762     | MP1006LF3T * | 11.4                     | 6.4       | 4.8       | 7.6                                 | 25.4                  | 14.9                              | 1.9                   |
| F1AH0763     | MP1205LF3T   | 13.8                     | 6.6       | 6.8       | 6.0                                 | 31.4                  | 11.8                              | 1.9                   |
| F1AH0812     | MP1605VF3T * | 16.7                     | 6.6       | 8.3       | 10.0                                | 39.3                  | 19.6                              | 3.7                   |
| F1AH0770     | MP1903VF3T   | 21.2                     | 5.1       | 11.0      | 8.6                                 | 50.0                  | 16.9                              | 4.3                   |
| F1AH0772     | MP2303VF3T   | 24.9                     | 5.1       | 14.9      | 8.5                                 | 61.9                  | 16.7                              | 5.3                   |
| F1AH0773     | MP2705VF3T   | 29.5                     | 6.7       | 14.8      | 21.6                                | 68.9                  | 42.5                              | 10.0                  |
| F1AH0774     | MP3210VF3T   | 35.0                     | 11.5      | 19.9      | 40.7                                | 85.8                  | 80.0                              | 27.0                  |

- No Ozone Layer Depleting Chemicals are used in these products or in their manufacturing process.
- $A_e$ : effective cross-section area,  $L_m$ : mean magnetic path length,  $2\phi_s$ : total magnetic flux( $2 \times B_s \times A_e$ )

### Designation of part name

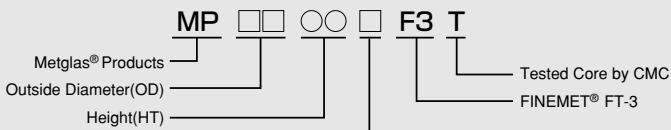

| Box material |          |             |         |
|--------------|----------|-------------|---------|
|              | Material | Flam. Class | R.T.I   |
| L            | Nylon    | UL94 V-0    | 130°C   |
|              | PBT*     | UL94 V-0*   | 140°C * |
| V            | PET      | UL94 V-0    | 155°C   |
|              | PBT*     | UL94 V-0*   | 140°C * |

\* PBT resin is used for core cases of MP1006LF3T and MP1605VF3T.



Figure 84. MP series core





## NOTICES

1. When designing a component using this product and applying the designed components in any system, use this product only in the guaranteed range specified by Hitachi Metals, Ltd. Do not use the product beyond guaranteed values specified by Hitachi Metals, Ltd. Hitachi Metals, Ltd. will not be responsible for any damage or accident when this product is used beyond guaranteed values specified by Hitachi Metals, Ltd. Even when the product is used within the specification given by Hitachi Metals, take appropriate measures for system, such as failsafe, to avoid any accident resulting in any bodily injury and/or property damage. It is the responsibility of a user to take such measures.
2. This product is designed to be used for general electronic devices (e.g. office machinery, communication devices, measurement devices, household appliances, etc.). Performance and safety of this product for applications in the special fields which require particularly high reliability and quality, and whose application is potentially life threatening or could lead to physical harm in the event of malfunction is not confirmed. Such fields may include: space science, aviation, nuclear energy, combustion control, transportation, safety devices and medical equipment. Be sure to examine the performance and safety when the product is used for these applications, and take appropriate measures for system, such as failsafe, to avoid any accident resulting in any bodily injury and/or property damage. It is the responsibility of a user to take such measures.
3. Take appropriate measures, such as using an overvoltage protective device to prevent high voltage surge from being applied to the product if direct lightning surge, inductive lightning surge, switching surge, etc. is likely to be applied to this product. This product may deteriorate in function when high-voltage surge is applied. It is the responsibility of a user to take such measures.
4. Do not use this product in devices under massive radiation, such as neutron rays. This product is not a radiation-proof and may result in deterioration of this product.
5. In no event shall Hitachi Metals, Ltd. be responsible for any claim, loss or damages caused by defect in design by user.
6. The products and their specifications are subject to change without notice. Please check the latest catalog, technical documents or specifications before your final design, procurement or use of the products.
7. No warranty, right or license in connection with any patent, trademark, copyright, or any other intellectual property right shall be, expressly or impliedly, given or granted to any party by Hitachi Metals, Ltd. under this catalog.
8. Please contact Soft Magnetic Materials and Components Business Unit, Hitachi Metals, Ltd., for any inquiry.

## Hitachi Metals, Ltd.

<http://www.hitachi-metals.co.jp>

### High-Grade Metals Company

Soft Magnetic Materials and Components Business Unit

#### Head Office

Shinagawa Season Terrace 2-70, Konan 1-chome,  
Minato-ku, Tokyo 108-0075, Japan  
Tel:+81-3-6774-3407 Fax:+81-3-3774-4308

### North America

#### Hitachi Metals America, LLC

##### Chicago Office

85W. Algonquin Road Suite 499 Arlington Heights,  
IL60005-4142, U.S.A.  
Tel:+1-847-364-7200 Fax:+1-847-364-7279

### Europe

#### Hitachi Metals Europe GmbH

##### Head Office

Immermannstrasse 14-16, 40210 Duesseldorf, Germany  
Tel:+49-211-16009-0 Fax:+49-211-16009-29

##### Mirano Branch Office

Via Modigliani 45, 20090 Segrate, Milano, Italy  
Tel:+39-02-7530188/7532613/7533782  
Fax:+39-02-7532558

### Asia

#### Hitachi Metals Hong Kong, Ltd.

Suites 1809-13 18/F, Tower 6 The Gateway,  
Harbour City, Tsimshatsui, Kowloon, Hong Kong  
Tel: +852-2724-4183 Fax: +852-2311-2095

#### Hitachi Metals Taiwan, Ltd.

##### Taipei Branch Office

11F, No.9 Xiangyang Road, Zhongzheng Dist.,  
Taipei, Taiwan  
Tel: +886-2-2311-2777 Fax: +886-2-2381-5210

#### Hitachi Metals (China), Ltd.

11F, Chong Hing Finance Center,  
No.288 Nan jing Road (W), Shanghai, China  
Tel: +86-21-3366-3000

#### Hitachi Metals (Thailand) Ltd. Bangkok Sales Office

Unit 13B, 13th Floor, Ploenchit Tower, 898 Ploenchit  
Road, Lumpini, Pathumwan, Bangkok 10330, Thailand  
Tel: +66-2-263-0889~0890 Fax: +66-2-263-0891

If you cannot reach the number above please contact  
Hitachi Metals, Ltd. in Tokyo below.  
Toll-free 0800-500-5055 (in Japan), Tel. +81-3-6774-3001

Do not duplicate any part of this catalog without written  
permission from Hitachi Metals, Ltd.



## Данный компонент на территории Российской Федерации

### Вы можете приобрести в компании MosChip.

Для оперативного оформления запроса Вам необходимо перейти по данной ссылке:

<http://moschip.ru/get-element>

Вы можете разместить у нас заказ для любого Вашего проекта, будь то серийное производство или разработка единичного прибора.

В нашем ассортименте представлены ведущие мировые производители активных и пассивных электронных компонентов.

Нашей специализацией является поставка электронной компонентной базы двойного назначения, продукции таких производителей как XILINX, Intel (ex.ALTERA), Vicor, Microchip, Texas Instruments, Analog Devices, Mini-Circuits, Amphenol, Glenair.

Сотрудничество с глобальными дистрибьюторами электронных компонентов, предоставляет возможность заказывать и получать с международных складов практически любой перечень компонентов в оптимальные для Вас сроки.

На всех этапах разработки и производства наши партнеры могут получить квалифицированную поддержку опытных инженеров.

Система менеджмента качества компании отвечает требованиям в соответствии с ГОСТ Р ИСО 9001, ГОСТ РВ 0015-002 и ЭС РД 009

### Офис по работе с юридическими лицами:

105318, г.Москва, ул.Щербаковская д.3, офис 1107, 1118, ДЦ «Щербаковский»

Телефон: +7 495 668-12-70 (многоканальный)

Факс: +7 495 668-12-70 (доб.304)

E-mail: [info@moschip.ru](mailto:info@moschip.ru)

Skype отдела продаж:

moschip.ru

moschip.ru\_4

moschip.ru\_6

moschip.ru\_9