

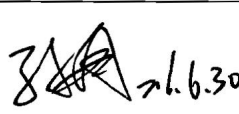

Product Specification

Product Name: T101VB01D01

Customer
Approved by Customer
Approved Date:

Designed By	Checked by	Approved By	
		R&D	QA
 6.6.30	 2016.6.30	 6.30	 6/30/16

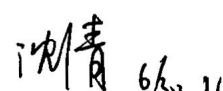
CONTENT

REVISION RECORD	3
1 OVERVIEW	4
2 FEATURES	4
3 GENERAL INFORMATION	4
4 MECHANICAL DRAWING	5
5 MODULE INTERFACE	6
5.1 TFT PIN DESCRIPTION.....	6
5.2 BACK-LIGHT UNIT.....	7
6 ABSOLUTE MAXIMUM RATING	8
6.1 ELECTRICAL ABSOLUTE RATING.....	8
7 ELECTRICAL CHARACTERISTICS	9
7.1 DC ELECTRICAL CHARACTERISTICS.....	9
7.2 AC ELECTRICAL CHARACTERISTICS.....	11
8 POWER ON/OFF SEQUENCE	13
9 OPTICAL CHARACTERISTICS	14
10 PACKAGE SPECIFICATION	17
11 ILLUSTRATION OF PRODUCT NAME	18
12 PRECAUTIONS FOR OPERATION AND STORAGE	18
12.1 PRECAUTIONS FOR OPERATION.....	19
12.2 SOLDERING.....	19
12.3 PRECAUTIONS FOR STORAGE.....	19
12.4 WARRANTY PERIOD.....	19

1 Overview

The specifications is a transmissive type color active matrix liquid crystal display (LCD) which uses amorphous thin film transistor (TFT) as switching devices. This product is composed of a TFT LCD panel, driver IC, FPC, and a backlight unit.

2 Features

- Panel Size: 10.1 inch
- Number of Pixels /Resolution: 1280×RGB×800
- Interface: LVDS
- RoHS and Halogen-Free Compliance
- Applications: Multimedia application and other hand application

3 General Information

NO.	ITEM	SPECIFICATION	UNIT
1	Dot Matrix	1280(W)×800(H)	Pixels
2	Dot Pitch	0.1695(W)×0.1695 (H)	mm
3	Active Area	216.96(W)×135.60(H)	mm
4	Module Size	229.46(W)×149.10(H)×4.56(T)	mm
5	Viewing Angle	6 O'clock	mm
6	Module Weight	190(MAX)	gram

4 Mechanical Drawing

Front side

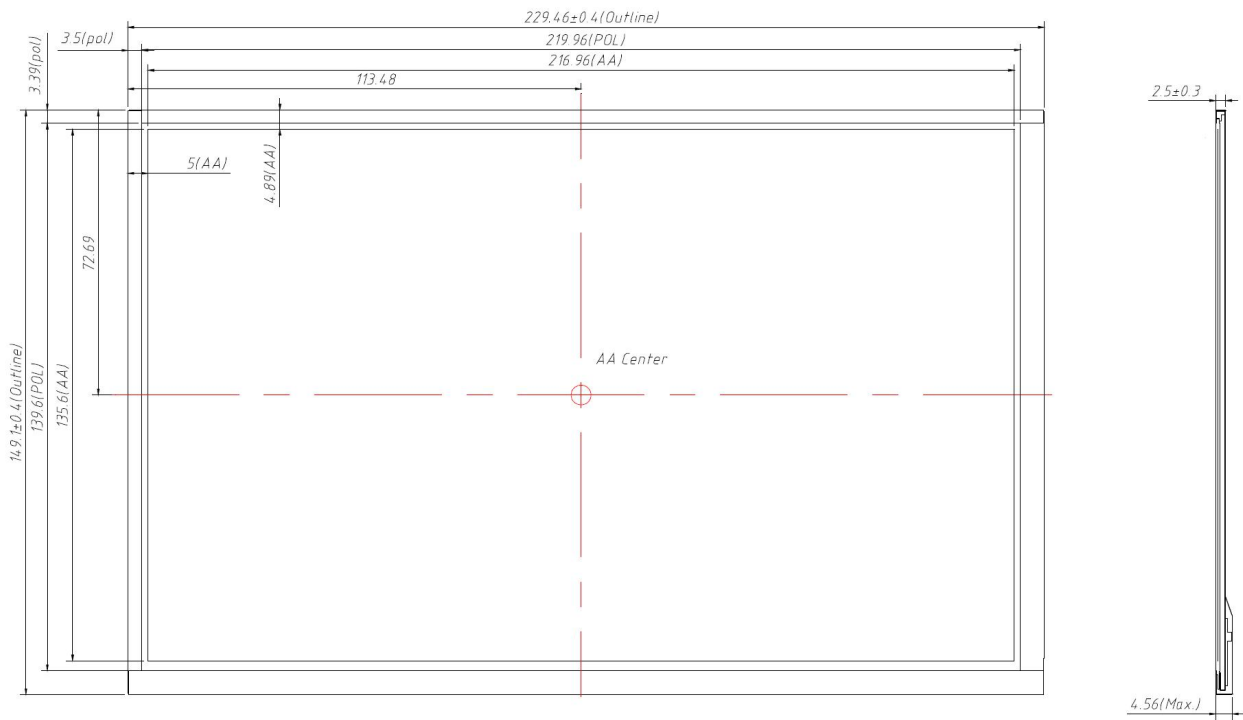

Back side

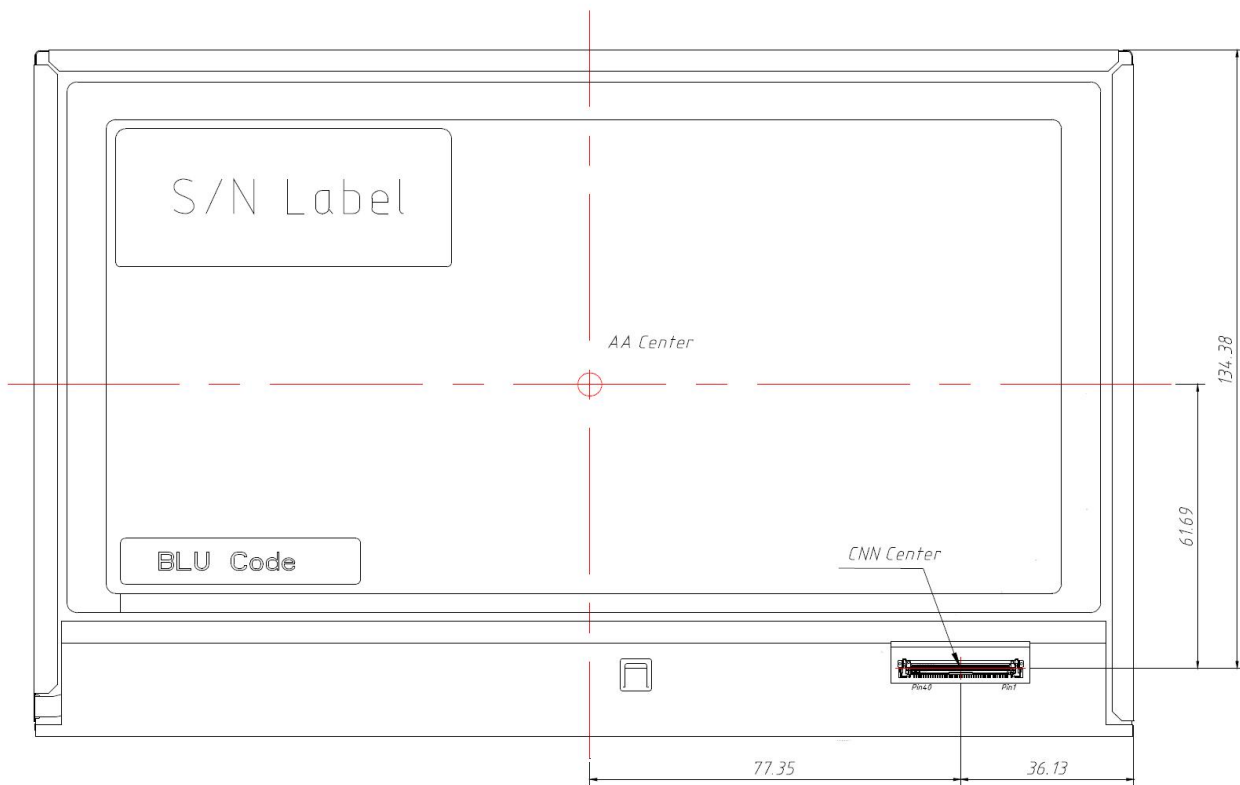

5 Module Interface

5.1 TFT PIN Description

Connector Name / Designation

Item	Description
Manufacturer / Type	Starconn / 300E40-0010RA-G3
Mating Receptacle / Type (Reference)	TBD or Compatible

Signal Pin Assignment

Pin #	Signal Name	Description	Remarks
1	NC	No Connection	-
2	VDD	Power Supply	-
3	VDD	Power Supply	-
4	VDD_EDID	VDD_EDID	-
5	SCL_EDID	SCL_EDID	-
6	SDA_EDID	SDA_EDID	-
7	NC	No Connection	-
8	LV0N	-LVDS Differential Data Input	-
9	LV0P	+LVDS Differential Data Input	-
10	GND	Ground	-
11	LV1N	-LVDS Differential Data Input	-
12	LV1P	+LVDS Differential Data Input	-
13	GND	Ground	-
14	LV2N	-LVDS Differential Data Input	-
15	LV2P	+LVDS Differential Data Input	-
16	GND	Ground	-
17	LVCLKN	-LVDS Differential Clock Input	-
18	LVCLKP	+LVDS Differential Clock Input	-
19	GND	Ground	-
20	LV3N	-LVDS Differential Data Input	-
21	LV3P	+LVDS Differential Data Input	-
22	GND	Ground	-
23	LED_GND	Ground for LED Driving	-
24	LED_GND	Ground for LED Driving	-
25	LED_GND	Ground for LED Driving	-
26	NC	No Connection	-

27	LED_PWM	PWM Input Signal for LED Driver	-
28	LED_EN	LED Enable Pin	-
29	NC	Reserved For CABC	-
30	NC	No Connection	-
31	LED_VCC	Power Supply for LED Driver	-
32	LED_VCC	Power Supply for LED Driver	-
33	LED_VCC	Power Supply for LED Driver	-
34	NC	No Connection	-
35	BIST	BIST pin	-
36	NC	No Connection	-
37	NC	No Connection	-
38	NC	No Connection	-
39	NC	No Connection	-
40	NC	No Connection	-

All input signals shall be low or Hi-Z state when VDD is off.

5.2 Back-Light Unit

Item	Symbol	Min.	Typ.	Max.	Units	Note
LED Input Voltage	V_{LED}	(6)	(12)	(21)	V	(2)
LED Power Consumption	P_{LED}	-	-	(2.5)	W	(2)
LED Forward Voltage	V_F	(2.9)	-	(3.2)	V	(2)
LED Forward Current	I_F	-	(20)	-	mA	
PWM Signal Voltage	V_{PWM_EN}	High	(3.0)	-	(3.6)	
		Low	(0)	-	(0.4)	
LED Enable Voltage	V_{LED_EN}	High	(3.0)	-	(3.6)	V
		Low	(0)	-	(0.4)	
Input PWM Frequency	FPWM	(1)	-	(2)	KHz	$D_{DIM} \geq 1\%$ (2)
		(2)	-	(5)		$D_{DIM} \geq 2.5\%$ (2)
		(5)	-	(10)		$D_{DIM} \geq 5\%$ (2)
		(10)	-	(20)		$D_{DIM} \geq 10\%$ (2)
LED Life Time	LT	(15,000)	-	-	Hours	(1)(2)

Note (1): The LED life time define as the estimated time to 50% degradation of initial luminous.

Note (2): Operating temperature 25°C, humidity 55%.

6 Absolute Maximum Rating

6.1 Electrical Absolute Rating

Item	Symbol	Min.	Max.	Unit	Note
Logic Supply Voltage	V _{DD}	-0.3	7	V	TA=25°C
Supply V _{LED} Voltage	V _{LED}	-0.3	24	V	

Note : The module may be destroyed and not be recovered while the absolute maximum rating values of this product have been exceeded.

Item	Symbol	Min.	Max.	Unit	Conditions
Operating Temperature	T _{OP}	-20	70	°C	(1),(2),(3)
Operating Humidity	H _{OP}	10	90	%RH	
Storage Temperature	T _{ST}	-30	80	°C	
Storage Humidity	H _{ST}	10	90	%RH	

Note :

- (1) Maximum Wet-Bulb temperature should be 39 degree C and no condensation.
- (2) When you apply the LCD module for OA system. Please make sure to keep the temperature of LCD module is less than 70°C
- (3)Storage /Operating temperature

Absolute Ratings of Environment of the LCD Module

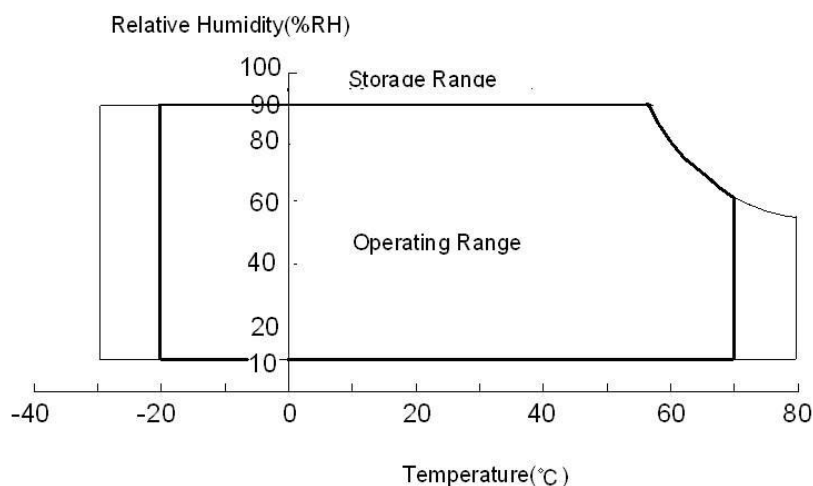

7 Electrical Characteristics

7.1 DC Electrical Characteristics

Item	Symbol	Min.	Typ.	Max.	Units	Note
LCD Drive Voltage (Logic)	VDD	(3.0)	(3.3)	(3.6)	V	(2),(4)
VDD Current	White Pattern	IDD	(0.27)	-	A	(3),(4)
VDD Power Consumption	White Pattern	PDD	-	(1.0)	W	
LED Power Consumption	PLED	-	-	(2.5)	W	
Rush Current	Irush	-	-	(1.5)	A	(1),(4),(5)
Allowable Logic/LCD Drive Ripple Voltage	VDDrp	-	-	(300)	mV	(4)

Note (1) Measure Condition

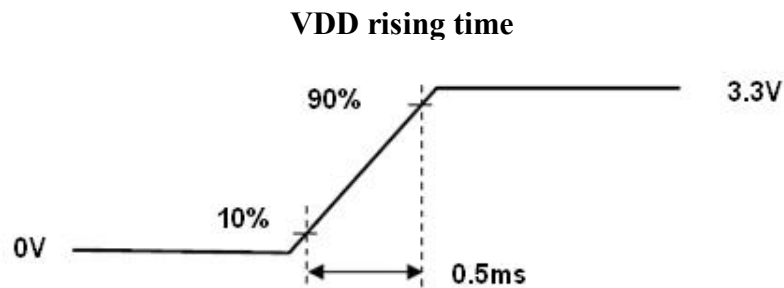

Note (2) VDD Power Dip Condition

If $V_{TH} < VDD \leq V_{min}$, then $t_{dR1} \leq 10ms$; when the voltage return to normal our panel must revive automatically.

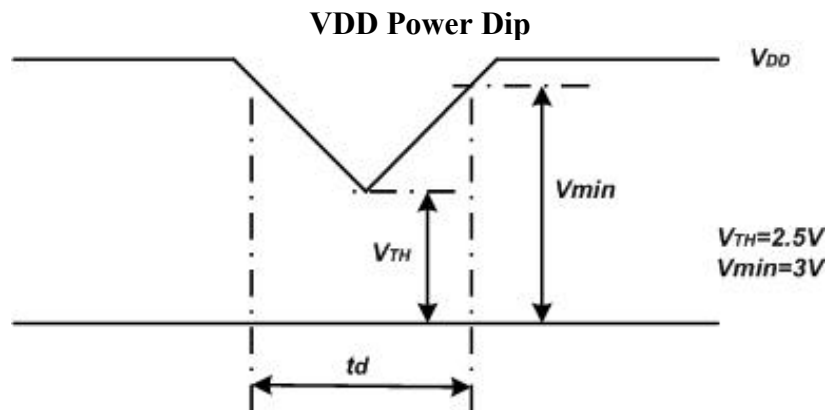

Note (3) Frame Rate=60Hz, VDD=3.3V, DC Current.

Note (4) Operating temperature 25°C, humidity 55%RH.

Note (5) The reference measurement circuit of rush current.

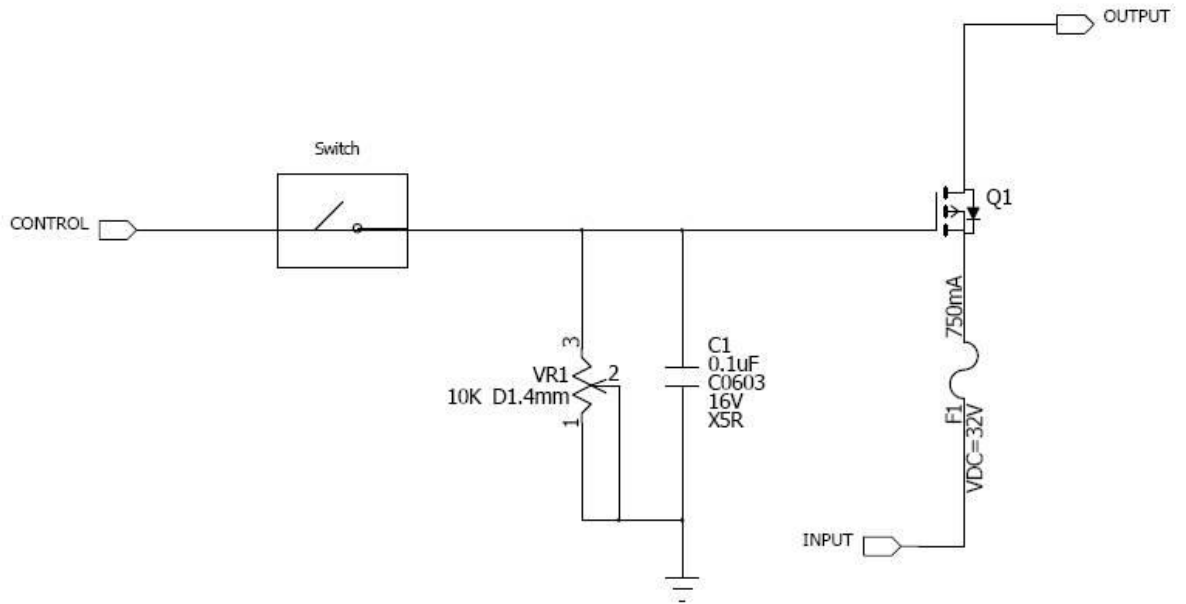

7.2 AC Electrical Characteristics

7.2.1 LVDS Receiver

Signal Electrical Characteristics For LVDS Receiver

LVDS Receiver Electrical Characteristics

Parameter	Symbol	Min.	Typ.	Max.	Unit	Conditions
Differential Input High	Vth	-	-	+100	mV	$V_{CM}=+1.2V$
Differential Input Low	Vtl	-100	-	-	mV	$V_{CM}=+1.2V$
Magnitude Differential Input	V	200	-	400	mV	-
Common Mode Voltage	V_{CM}	$0.3+(VID/2)$	-	$VDD-1.2-(VID/2)$	V	-
Common Mode Voltage	ΔV_{CM}	-	-	50	mV	$V_{CM}=+1.2V$

Note: (1) Input signals shall be low or Hi- resistance state when VDD is off.

(2) All electrical characteristics for LVDS signal are defined and shall be measured at the interface connector of LCD.

LVDS input characteristics are as follow

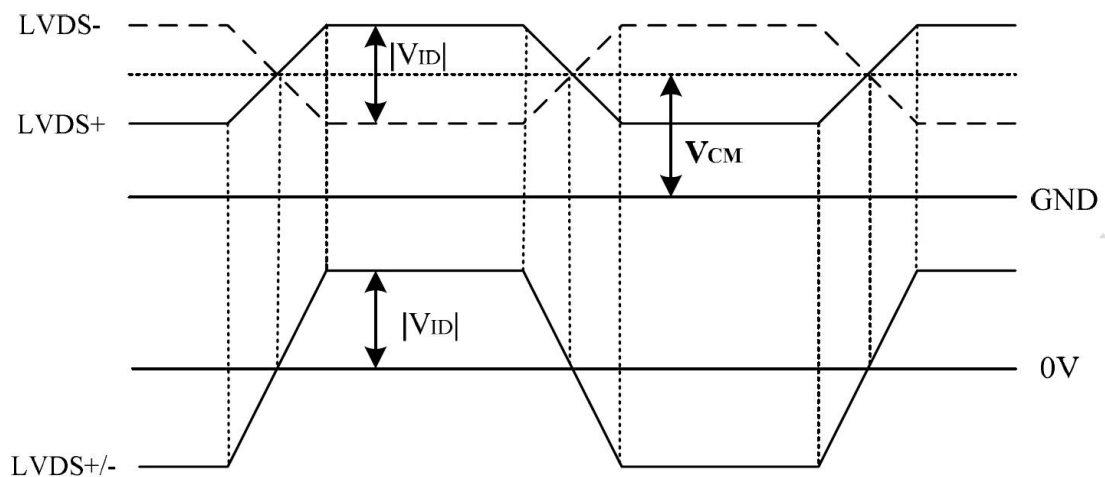

Data Mapping

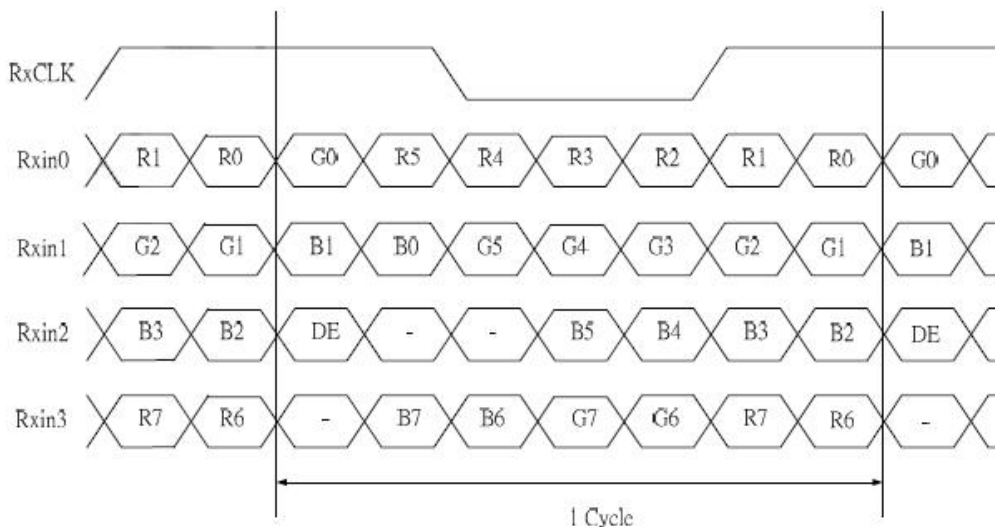

7.2.2 Interface Timings

Interface Timings

Parameter	Symbol	Unit	Min.	Typ.	Max.
Frame Rate	--	Hz	-	60	-
Frame Period	t_v	line	(815)	(823)	(1023)
Vertical Display Time	t_{vD}	line	800		
Vertical Blanking Time	$t_{vW}+t_{vBP}+t_{vFP}$	line	(15)	(23)	(33)
1 Line Scanning Time	t_H	clock	(1410)	(1440)	(1470)
Horizontal Display Time	t_{HD}	clock	1280		
Horizontal Blanking Time	$t_{HW}+t_{HBP}+t_{HFP}$	clock	(60)	(160)	(190)
Clock Rate	$1/T_C$	MHz	(68.9)	(71.1)	(73.4)

Timing Characteristics

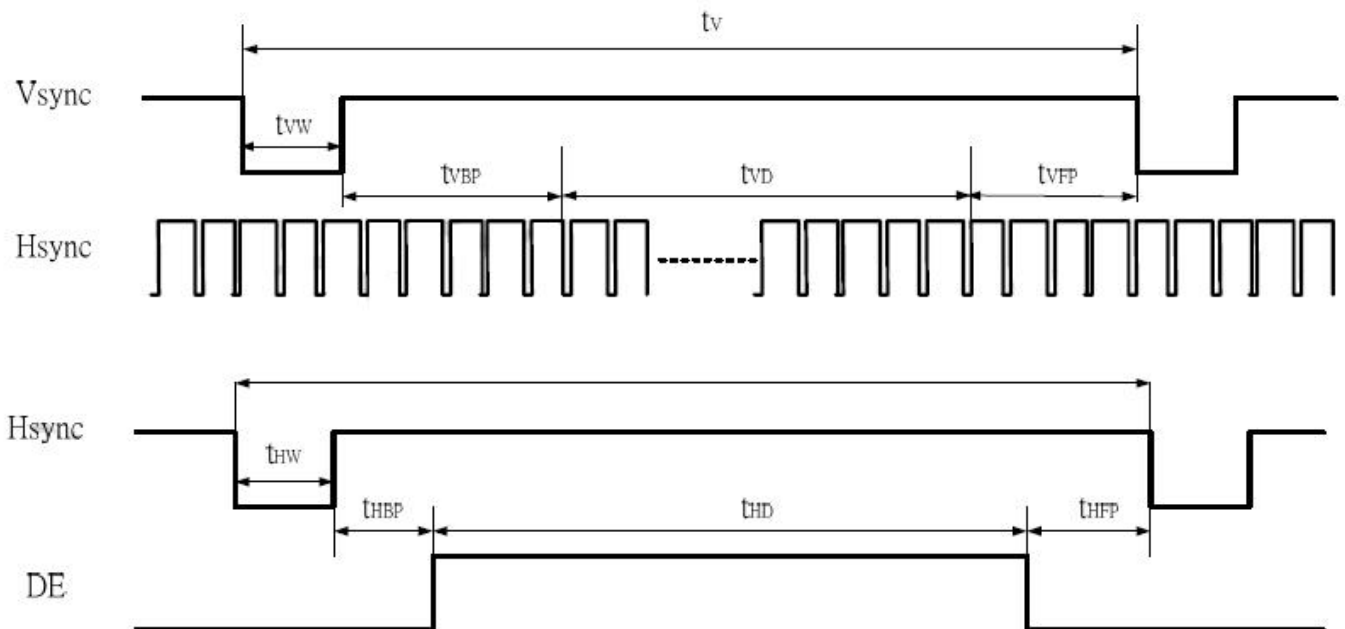

8 Power ON/OFF Sequence

VDD power on/off sequence is as follows. Interface signals are also shown in the chart. Signals from any system shall be Hi- resistance state or low level when VDD is off.

Power Sequence

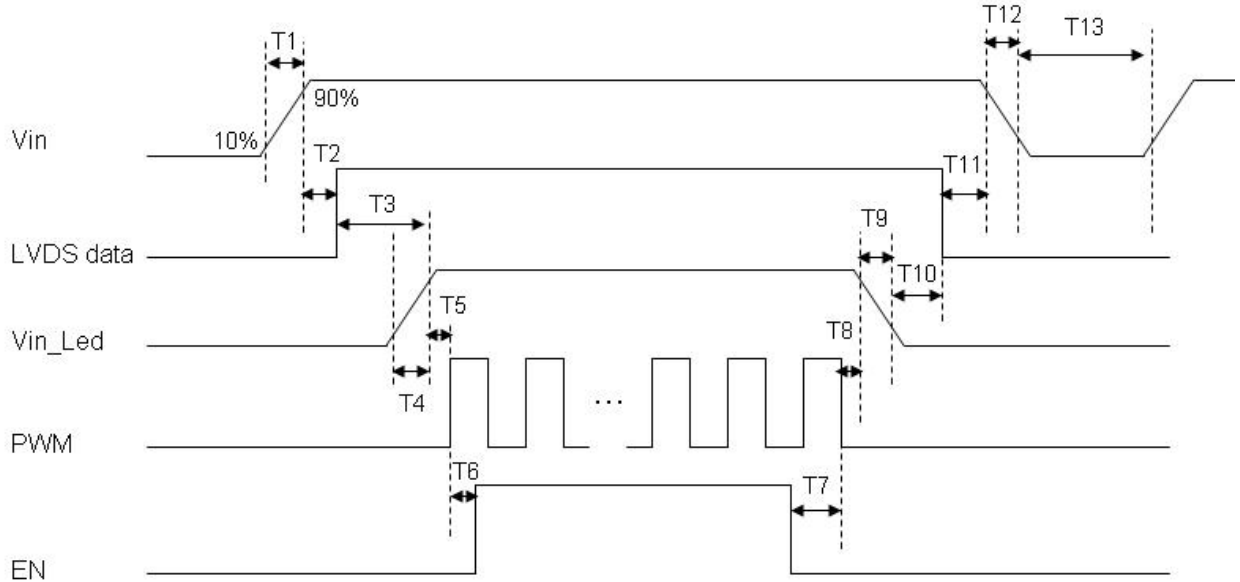

Power Sequencing Requirements

Parameter	Symbol	Unit	Min	Typ.	Max
VIN Rise Time	T1	ms	0.5	--	10
VIN Good to Signal Valid	T2	ms	30	--	90
Signal Valid to Backlight On	T3	ms	200	--	--
Backlight Power On Time	T4	ms	0.5	--	--
Backlight VDD Good to System PWM On	T5	ms	10	--	--
System PWM ON to Backlight Enable ON	T6	ms	10	--	--
Backlight Enable Off to System PWM Off	T7	ms	0	--	--
System PWM Off to B/L Power Disable	T8	ms	10	--	--
Backlight Power Off Time	T9	ms	0.5	10	30
Backlight Off to Signal Disable	T10	ms	200	--	--
Signal Disable to Power Down	T11	ms	0	--	50
VIN Fall Time	T12	ms	0.5	10	30
Power Off	T13	ms	500	--	--

9 Optical characteristics

The optical characteristics are measured under stable conditions as following notes

Item	Conditions		Min.	Typ.	Max.	Unit	Note
Viewing Angle (CR>10)	Horizontal	Left θ_{x-}	(75)	(85)	-	degree	(1),(2),(3)
		Right θ_{x+}	(75)	(85)	-		
	Vertical	Up θ_{y+}	(75)	(85)	-		
		Down θ_{y-}	(75)	(85)	-		
Contrast Ratio	Center		(600)	(800)	-	-	(1),(2),(4)
Response Time	Rising + Falling		-	(25)	(50)	ms	(1),(2),(5)
Color Chromaticity (CIE1931)	Red	x	Typ. -0.03	(0.561)	Typ. +0.03	-	(1),(2),(3) $\theta_x=\theta_y=0^\circ$
	Red	y		(0.334)		-	
	Green	x		(0.341)		-	
	Green	y		(0.568)		-	
	Blue	x		(0.161)		-	
	Blue	y		(0.129)		-	
	White	x		(0.313)		-	
	White	y		(0.329)		-	
NTSC	-		-	(45)	-	%	(1),(2),(3) $\theta_x=\theta_y=0^\circ$
White Luminance	Center		(300)	(350)	-	cd/m ²	(1),(2),(6)
Luminance Uniformity	9Points		(70)	(75)	-	%	(1),(2),(6)

Note (1). Measurement Setup:

The LCD module should be stabilized at given temperature(25°C) for 15 minutes to Avoid abrupt temperature change during measuring. In order to stabilize the luminance, the measurement should be executed after lighting backlight for 15 minutes in a windless room.

Measurement Setup

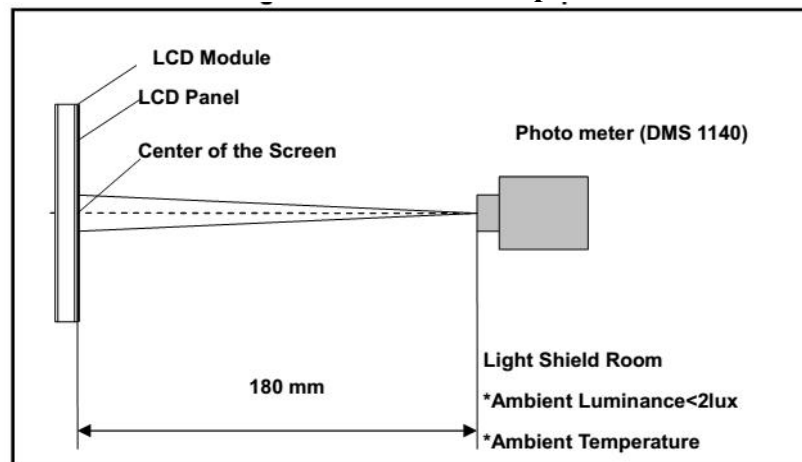

Note (2). The LED input parameter setting as:

V_LED: 12V

PWM_LED: duty 100 %

Note (3). Definition of Viewing Angle

Definition of Viewing Angle

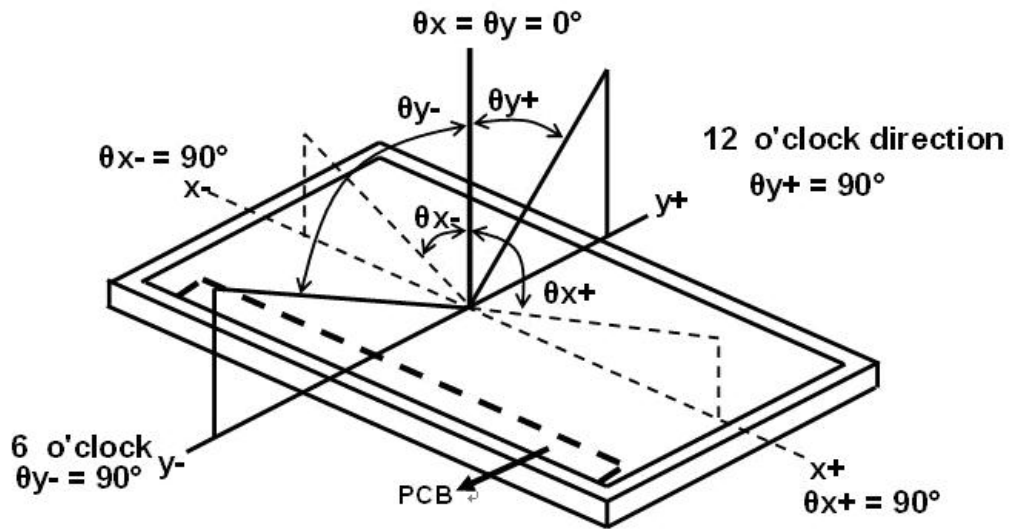

Note (4). Definition Of Contrast Ratio (CR)

The contrast ratio can be calculated by the following expression

$$\text{Contrast Ratio (CR)} = L_{255} / L_0$$

L63: Luminance of gray level 255, L0: Luminance of gray level 0

Note (5). Definition Of Response Time (TR, TF)

Definition of Response Time

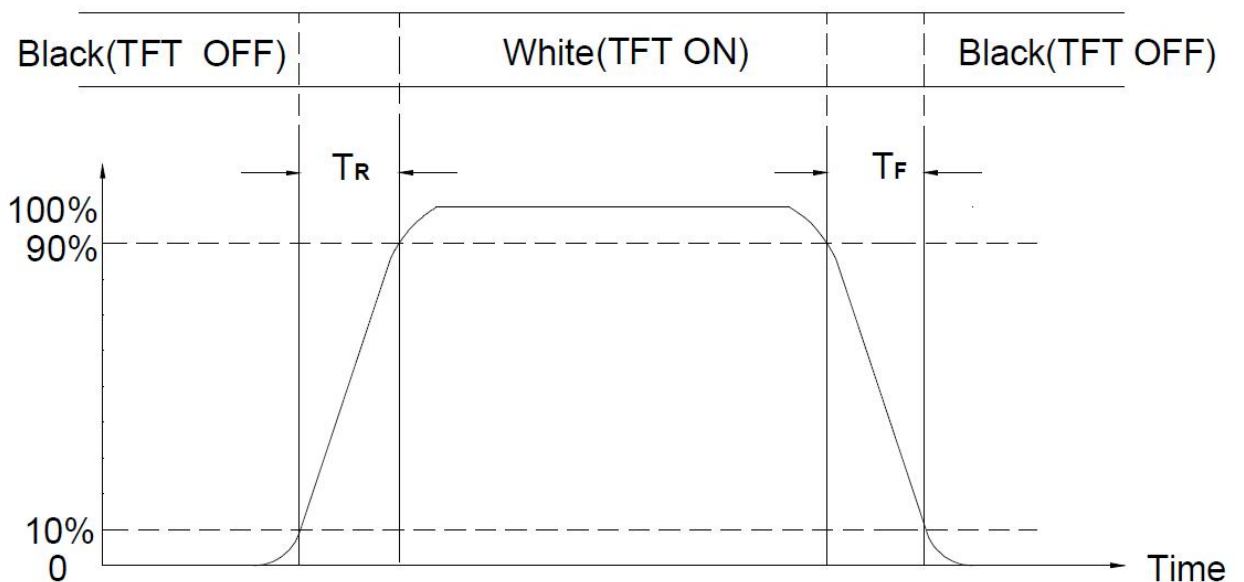

Note (6). Definition Of Luminance White

$$\text{Luminance uniformity} = \frac{\text{Min}(L1, L6, L7, L8, L9, L10, L11, L12, L13)}{\text{Max}(L1, L6, L7, L8, L9, L10, L11, L12, L13)} \times 100\%$$

H—Active area length V—Active area width

Measurement Locations

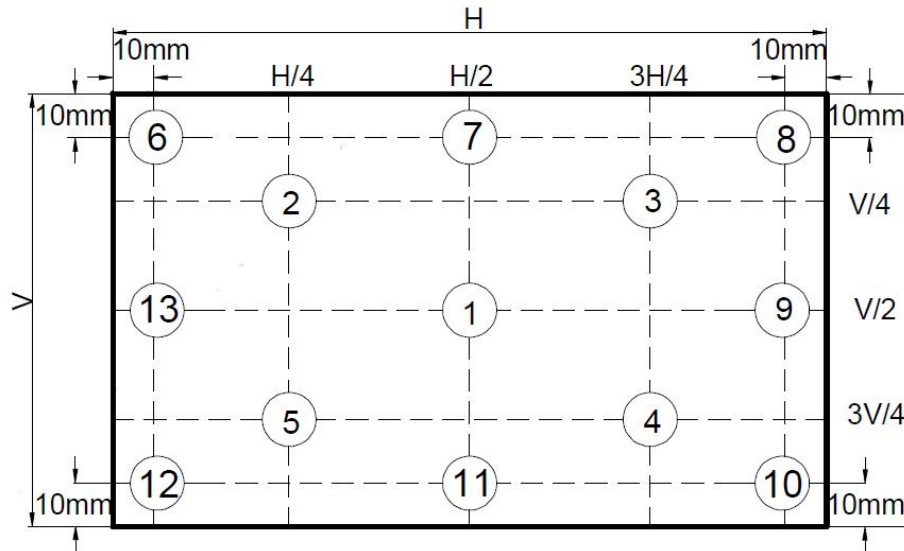

10 Package Specification

TBD

11 Illustration of Product Name

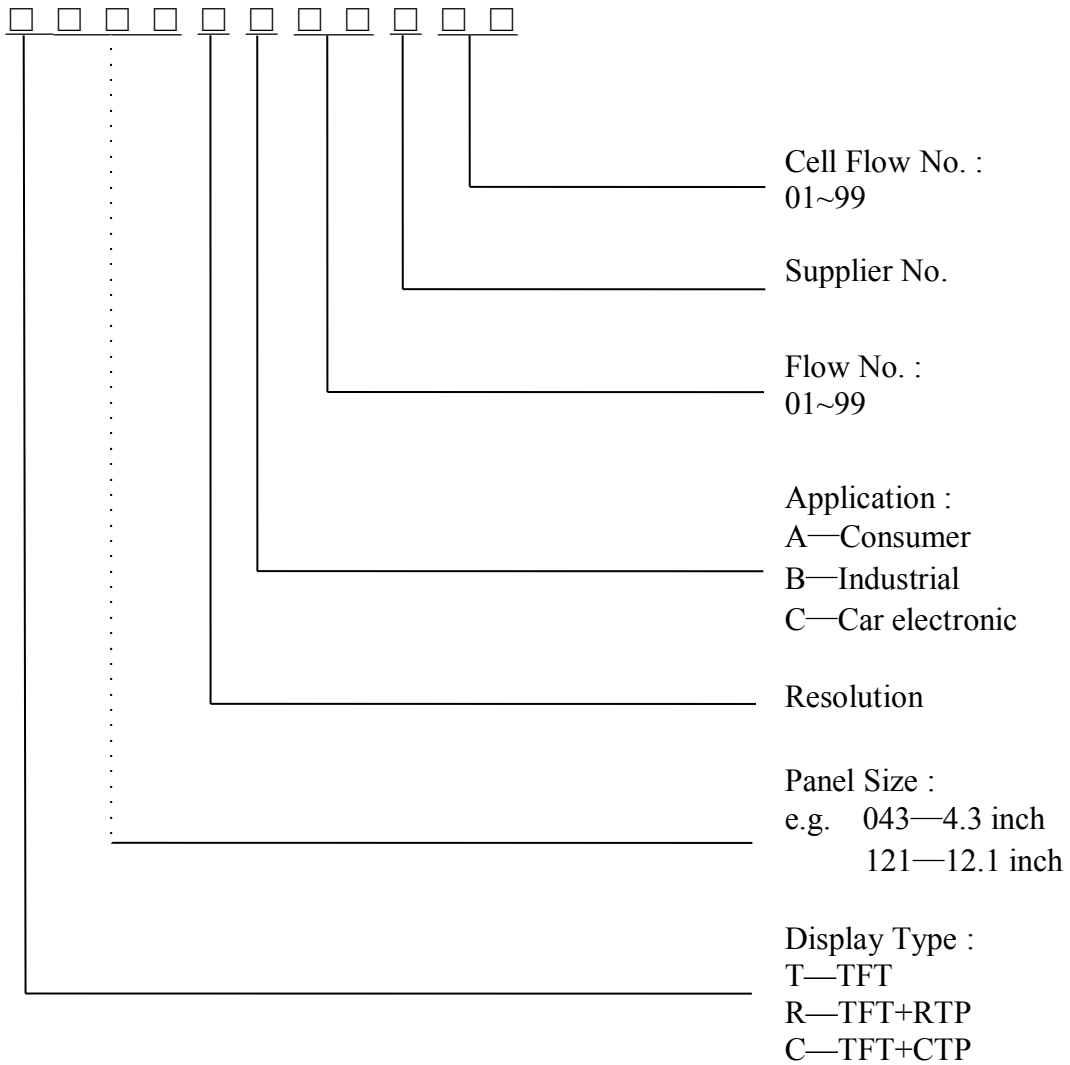

12 Precautions for operation and Storage

12.1 Precautions for Operation

- (1) Since the display panel is made of glass, do not apply any mechanical shock or impact or excessive force to it when installing the module. Any strong mechanical impact due to falling dropping etc. may cause damage (breakage or cracking).
- (2) If the display panel is damaged and the liquid crystal substance inside it leaks out, be sure not to get any in your mouth, if the substance comes into contact with your skin or clothes, promptly wash it off using soap and water.
- (3) The polarizer on the display surface is made of soft material and is easily scratched. Please take most care when handing. When the display surface is contaminated, please wipe it off gently by using moisten soft cloth with isopropyl alcohol, do not use water, ketone or aromatics. If still not completely clear, moisten cloth with isopropyl alcohol or ethyl alcohol solvents.
- (4) When handling the LCD module, please be sure that the body and the tools are properly grounded. And do not touch I/O pins with bare hands or contaminate I/O pins, it will cause disconnection or defective insulation of terminals.
- (5) Do not attempt to disassemble or process the LCD module.
- (6) The LCD Module is coated with a film to protect the display surface. Be care when peeling off this protective film since static electricity may be generated. To reduce the amount of static electricity generated, do not conduct assembly and other work under dry conditions.
- (7) Do not put one product on the other .Otherwise, it may cause the product to bescratched and/or change on cosmetic occur (ex. Newton ring).

12.2 Soldering

- (1) Soldering should be performed only on the I/O terminals.
- (2) Use soldering irons with proper grounding and no leakage.
- (3) Iron: no higher than 300°C and 3~4 sec during soldering.

12.3 Precautions for Storage

- (1) Please store LCD module in a dark place. Avoid exposure to sunlight, the light of fluorescent lamp or any ultraviolet ray.
- (2) Keep the environment temperature between 0°C and 40°C and the relative humidity less than 80%.Avoid high temperature and high humidity.
- (3) Keep the LCD modules stored in the room without acid ,alkali and harmful gas.

12.4 Warranty period

Visionox warrants for a period of 12 months from the shipping date when stored or used under normal condition.

Данный компонент на территории Российской Федерации

Вы можете приобрести в компании MosChip.

Для оперативного оформления запроса Вам необходимо перейти по данной ссылке:

<http://moschip.ru/get-element>

Вы можете разместить у нас заказ для любого Вашего проекта, будь то серийное производство или разработка единичного прибора.

В нашем ассортименте представлены ведущие мировые производители активных и пассивных электронных компонентов.

Нашей специализацией является поставка электронной компонентной базы двойного назначения, продукции таких производителей как XILINX, Intel (ex.ALTERA), Vicor, Microchip, Texas Instruments, Analog Devices, Mini-Circuits, Amphenol, Glenair.

Сотрудничество с глобальными дистрибьюторами электронных компонентов, предоставляет возможность заказывать и получать с международных складов практически любой перечень компонентов в оптимальные для Вас сроки.

На всех этапах разработки и производства наши партнеры могут получить квалифицированную поддержку опытных инженеров.

Система менеджмента качества компании отвечает требованиям в соответствии с ГОСТ Р ИСО 9001, ГОСТ РВ 0015-002 и ЭС РД 009

Офис по работе с юридическими лицами:

105318, г.Москва, ул.Щербаковская д.3, офис 1107, 1118, ДЦ «Щербаковский»

Телефон: +7 495 668-12-70 (многоканальный)

Факс: +7 495 668-12-70 (доб.304)

E-mail: info@moschip.ru

Skype отдела продаж:

moschip.ru

moschip.ru_4

moschip.ru_6

moschip.ru_9