

General Specifications

Electrical Capacity (Resistive Load)

Low/Logic Level: 50mA @ 24V DC

Other Ratings

Contact Resistance:	50 milliohms maximum
Insulation Resistance:	500 megohms minimum @ 250V DC
Dielectric Strength:	250V AC minimum for 1 minute minimum
Mechanical Life:	500,000 operations minimum
Electrical Life:	500,000 operations minimum
Nominal Operating Force:	1.96N for sculptured actuator 2.0N for piano actuator 3.0N for square & round flush actuators
Total Travel:	Flush Actuators .016" (0.4mm) Sculptured & Piano Actuators .031" (0.8mm)

Materials & Finishes

Actuator:	Polyamide
Case:	Glass fiber reinforced polyamide
Seal:	Nitrile butadiene rubber
Base:	Glass fiber reinforced polyester
Movable Contact:	Phosphor bronze with silver plating
Stationary Contacts:	Brass with silver plating
Terminals:	Brass with silver plating

Environmental Data

Operating Temperature Range:	-25°C through +85°C (-13°F through +185°F)
Humidity:	90 ~ 95% humidity for 96 hours @ 40°C (104°F)
Vibration:	10 ~ 55Hz with peak-to-peak amplitude of 1.5mm traversing the frequency range & returning in 1 minute; 3 right angled directions for 2 hours
Shock:	50G (490m/s ²) acceleration (tested in 6 right angled directions, with 5 shocks in each direction)

PCB Processing

Soldering:	Wave Soldering Recommended. See Profile A in Supplement section. Manual Soldering: See Profile A in Supplement section.
Cleaning:	Automated cleaning. See Cleaning specifications in Supplement section.

Standards & Certifications

The JF Series tactiles have not been tested for UL recognition or CSA certification. These switches are designed for use in a low-voltage, low-current, logic-level circuit. When used as intended in a logic-level circuit, the results do not produce hazardous energy.

Distinctive Characteristics

Extremely low profile of 5mm from PCB to top of switch.

Rubber seal construction prevents contact contamination and allows automated soldering and cleaning.

Minimal operating force and short stroke permit light touch operation.

Dome contact gives crisp tactile and audible feedback to positively indicate circuit transfer and assures high reliability and long life.

Wide choice of body shapes and colors.

Crimped terminals provide a spring type action to ensure secure mounting and prevent dislodging during wave soldering.

Space saving body dimensions provide for compact, side-by-side mounting on a standard grid.

Terminal spacing conforms to standard .100" (2.54mm) PCB grid.

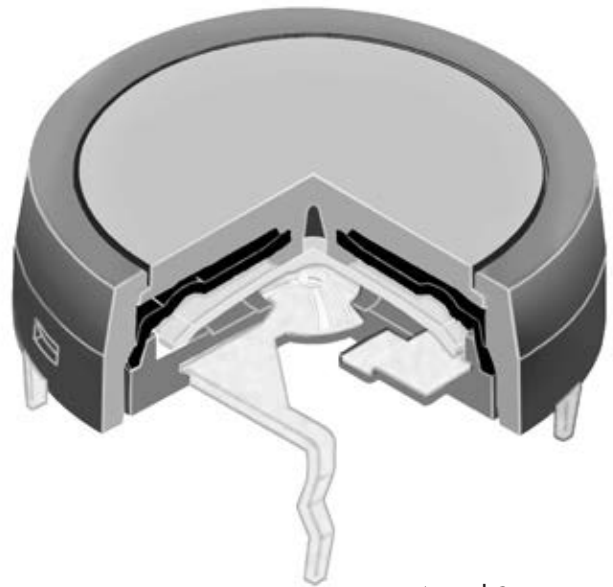

Actual Size



Common Bus Matrix

These single pole, single throw switches can be used in a keyboard matrix and, using strapped terminals, achieve a common bus electrical configuration on a single-sided PC board.

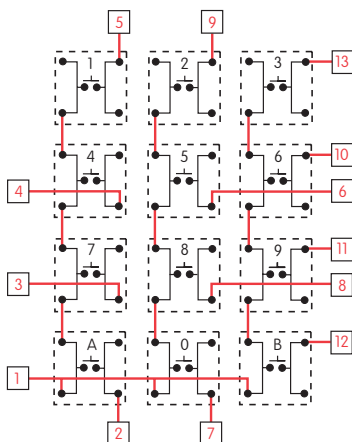

		PC Terminations												
		1	2	3	4	5	6	7	8	9	10	11	12	13
Keys (Switches)	1													
	2													
	3													
	4													
	5													
	6													
	7													
	8													
	9													
	0													
	A													
	B													

● = ON

X-Y Matrix

These single pole, single throw switches can be arranged on a single-sided PC board matrix with strapped terminals to achieve an X-Y type electrical interconnection.

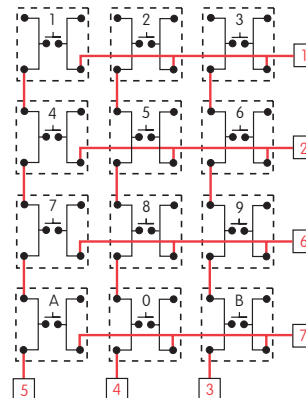

		PC Terminations						
		1	2	3	4	5	6	7
Keys (Switches)	1							
	2							
	3							
	4							
	5							
	6							
	7							
	8							
	9							
	0							
	A							
	B							

● = ON

Red = PCB Trace Black = Switch Circuit

TYPICAL SWITCH ORDERING EXAMPLE

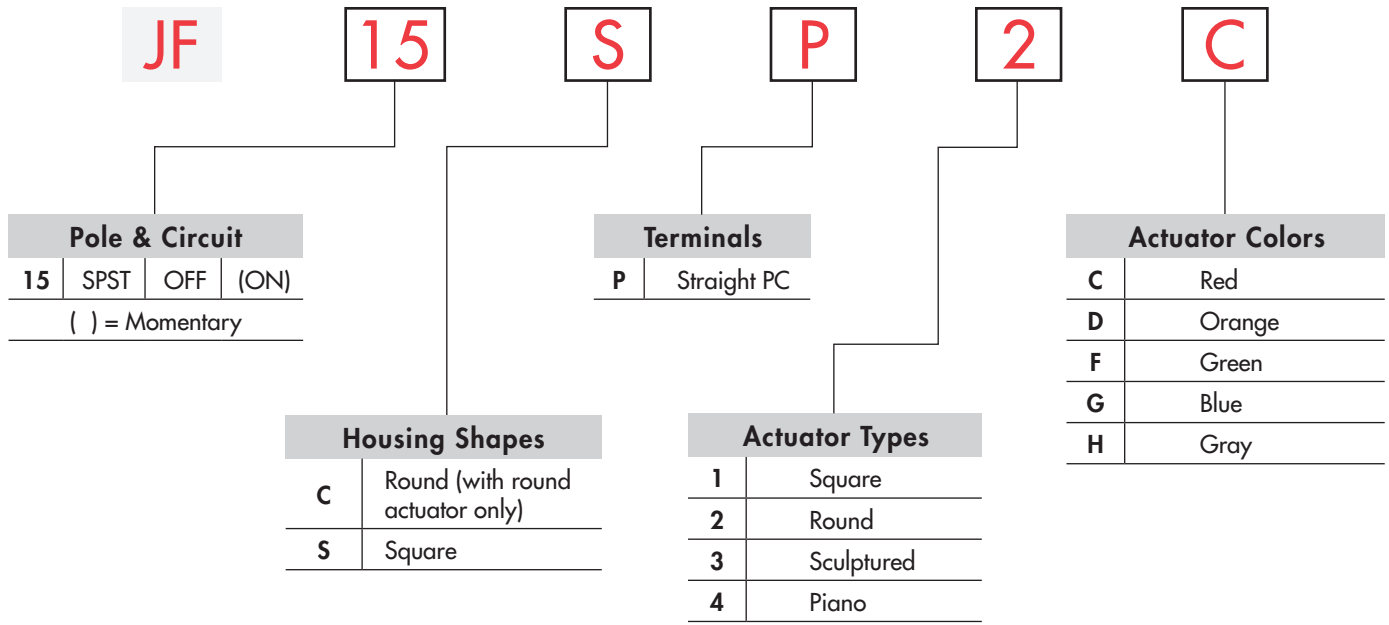

DESCRIPTION FOR TYPICAL ORDERING EXAMPLE

JF15SP2C

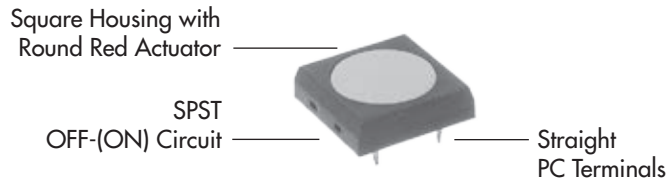

POLE & CIRCUIT

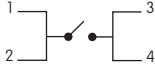
Pole	Model	Actuator Position () = Momentary		Switch Throw & Schematic	Note: Terminal numbers are shown on the switch.
		Normal	Down		
SP	JF15	OFF	(ON)	SPST 	

HOUSING SHAPES & ACTUATOR TYPES

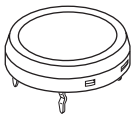
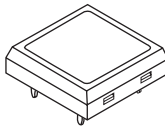
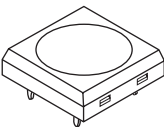
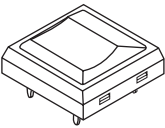
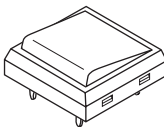
<p>C Round Housing</p>	<p>S Square Housing</p>			
<p>2 Round Actuator</p> 	<p>1 Square Actuator</p> 	<p>2 Round Actuator</p> 	<p>3 Sculptured Actuator</p> 	<p>4 Piano Actuator</p> 

Actuator Colors Available:

C Red

D Orange

F Green

G Blue

H Gray

Housing is Black

TERMINALS & PANEL DESIGN

P Straight PC

Additional details in Typical Switch Dimensions

Versatile panel arrangements can be made to fit individual design needs.

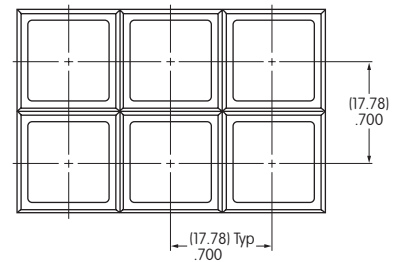
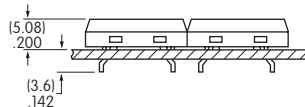
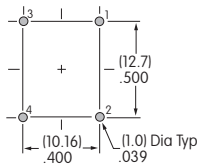
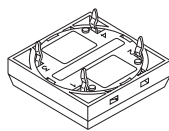

TYPICAL SWITCH DIMENSIONS

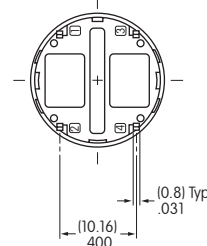
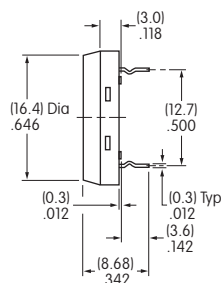
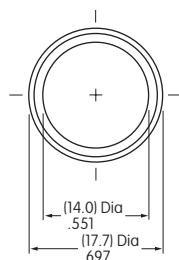

Round Actuator



JF15CP2C

Toggles
Rocker
Pushbuttons
Illuminated PB
Programmable
Keylocks
Rotaries
Slides
Tactiles
Tilt
Touch
Indicators
Accessories
Supplement

TYPICAL SWITCH DIMENSIONS

Square Actuator

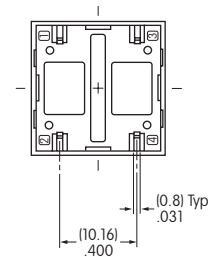
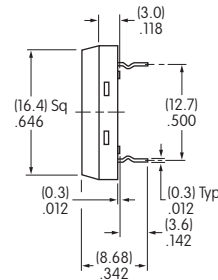
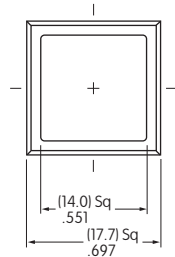

JF15SP1C

Round Actuator

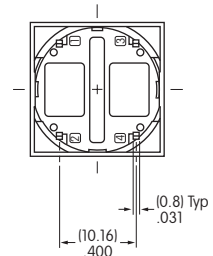
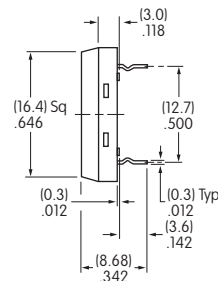
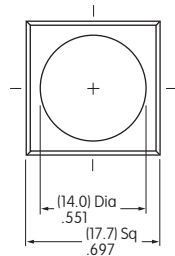
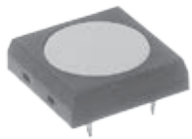

JF15SP2C

Sculptured Actuator

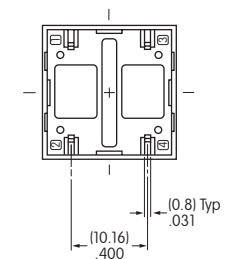
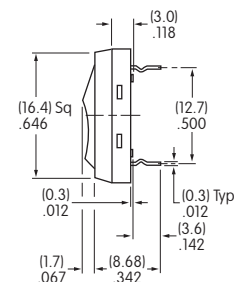
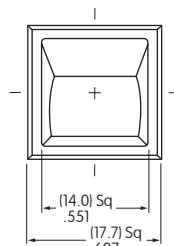

JF15SP3C

Piano Actuator

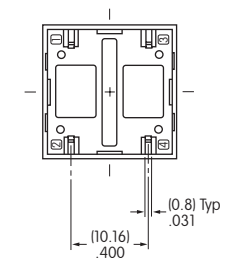
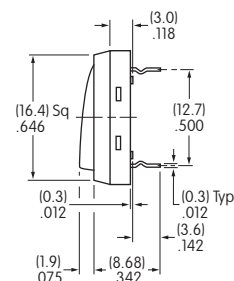
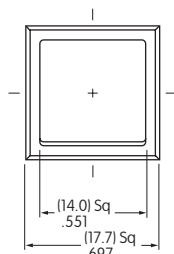
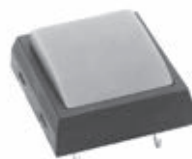

JF15SP4C

Toggles

Rockers

Pushbuttons

Illuminated PB

Programmable

Keylocks

Rotaries

Slides

Tactiles

Tilt

Touch

Indicators

Accessories

Supplement

LEGENDS

NKK Switches can provide custom legends for caps. Contact factory for more information.

Shaded Areas are Printable Areas

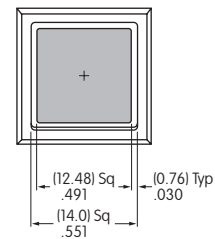
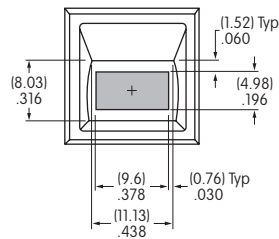
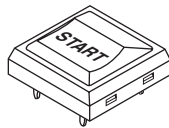
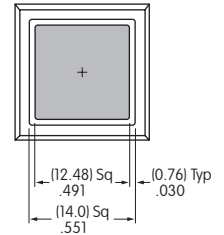
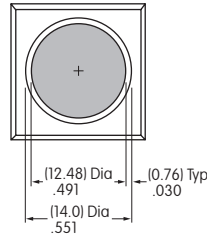
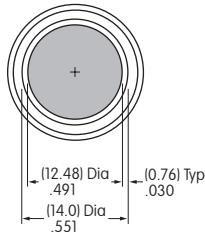
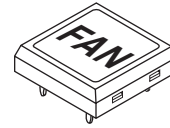

Recommended Print Methods: Screen Print or Pad Print. Epoxy based ink is recommended.

Mouser Electronics

Authorized Distributor

Click to View Pricing, Inventory, Delivery & Lifecycle Information:

NKK Switches:

[JF15SP3G](#) [JF15SP4C](#) [JF15SP4H](#) [JF15SP4D](#) [JF15SP2C](#) [JF15SP3F](#) [JF15SP1D](#) [JF15SP1H](#) [JF15SP1F](#)
[JF15SP3H](#) [JF15SP1C](#) [JF15SP1G](#) [JF15SP3C](#) [JF15CP2C](#) [JF15CP2H](#) [JF15CP2D](#) [JF15CP2F](#) [JF15CP2G](#)
[JF15SP2G](#) [JF15SP4G](#) [JF15SP1A](#) [JF15SP2D](#) [JF15SP2F](#) [JF15SP2H](#) [JF15SP3D](#) [JF15SP4F](#) [JF15CP2A](#)

Данный компонент на территории Российской Федерации

Вы можете приобрести в компании MosChip.

Для оперативного оформления запроса Вам необходимо перейти по данной ссылке:

<http://moschip.ru/get-element>

Вы можете разместить у нас заказ для любого Вашего проекта, будь то серийное производство или разработка единичного прибора.

В нашем ассортименте представлены ведущие мировые производители активных и пассивных электронных компонентов.

Нашей специализацией является поставка электронной компонентной базы двойного назначения, продукции таких производителей как XILINX, Intel (ex.ALTERA), Vicor, Microchip, Texas Instruments, Analog Devices, Mini-Circuits, Amphenol, Glenair.

Сотрудничество с глобальными дистрибьюторами электронных компонентов, предоставляет возможность заказывать и получать с международных складов практически любой перечень компонентов в оптимальные для Вас сроки.

На всех этапах разработки и производства наши партнеры могут получить квалифицированную поддержку опытных инженеров.

Система менеджмента качества компании отвечает требованиям в соответствии с ГОСТ Р ИСО 9001, ГОСТ РВ 0015-002 и ЭС РД 009

Офис по работе с юридическими лицами:

105318, г.Москва, ул.Щербаковская д.3, офис 1107, 1118, ДЦ «Щербаковский»

Телефон: +7 495 668-12-70 (многоканальный)

Факс: +7 495 668-12-70 (доб.304)

E-mail: info@moschip.ru

Skype отдела продаж:

moschip.ru

moschip.ru_4

moschip.ru_6

moschip.ru_9