

FEATURES

Conversion loss: 7 dB

LO to RF and IF isolation: 40 dB

Input IP3: 17 dBm

RoHS compliant, 24-terminal, 4 mm × 4 mm LCC package

APPLICATIONS

Microwave and very small aperture terminal (VSAT) radios

Test equipment

Military electronic warfare (EW); electronic countermeasure (ECM); and command, control, communications and intelligence (C3I)

GENERAL DESCRIPTION

The HMC129ALC4 is a general-purpose, double-balanced monolithic microwave integrated circuit (MMIC) mixer housed in a leadless Pb-free, RoHS compliant LCC package, that can be used as an upconverter or downconverter in the 4 GHz to 8 GHz band. The HMC129ALC4 is ideally suited for applications where small size, no dc bias, and consistent IC performance are required. This mixer can operate over a wide LO drive input of 9 dBm to

18 dBm. It performs equally well as a biphas modulator or demodulator. The HMC129ALC4 eliminates the need for wire bonding, allowing use of surface-mount manufacturing techniques.

FUNCTIONAL BLOCK DIAGRAM

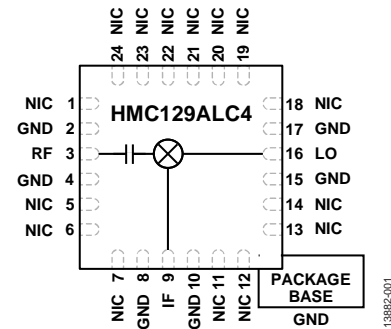

Figure 1.

TABLE OF CONTENTS

Features	1	Downconverter Performance	6
Applications.....	1	Upconverter Performance.....	8
Functional Block Diagram	1	Isolation and Return Loss	9
General Description	1	IF Bandwidth—Downconverter.....	11
Revision History	2	IF Bandwidth—Upconverter	12
Specifications.....	3	Spurious and Harmonics Performance	13
Absolute Maximum Ratings.....	4	Theory of Operation	14
Thermal Resistance	4	Applications Information	15
ESD Caution.....	4	Typical Application Circuit.....	15
Pin Configuration and Function Descriptions.....	5	Evaluation PCB Information	15
Interface Schematics.....	5	Outline Dimensions	16
Typical Performance Characteristics	6	Ordering Guide	16

REVISION HISTORY

7/2017—Revision 0: Initial Version

SPECIFICATIONS

$T_A = 25^\circ\text{C}$, IF = 100 MHz, LO = 15 dBm, upper side band. All measurements performed as a downconverter, unless otherwise noted, on the evaluation printed circuit board (PCB).

Table 1.

Parameter	Min	Typ	Max	Unit
FREQUENCY				
RF Pin	4		8	GHz
IF Pin	DC		3	GHz
LO Pin	4		8	GHz
LO DRIVE LEVEL	9	15	18	dBm
RADIO FREQUENCY (RF) PERFORMANCE				
Downconverter				
Conversion Loss		7	9	dB
Single Sideband (SSB) Noise Figure		7		dB
Input Third-Order Intercept (IIP3)	15	17		dBm
Input 1 dB Compression Point (IP1dB)		10		dBm
Input Second-Order Intercept (IIP2)		50		dBm
RF to IF Isolation		20		dB
LO to RF Isolation		40		dB
LO to IF Isolation	35	40		dB
Upconverter				
Conversion Loss		7		dB
Input Third-Order Intercept (IIP3)		17		dBm
Input 1 dB Compression Point (IP1dB)		7		dBm

ABSOLUTE MAXIMUM RATINGS

Table 2.

Parameter	Rating
RF Input Power	25 dBm
LO Input Power	27 dBm
IF Input Power	25 dBm
IF Source/Sink Current	6 mA
Reflow Temperature	260°C
Maximum Junction Temperature	175°C
Continuous Power Dissipation, P_{DISS} ($T_A = 85^\circ\text{C}$, Derate 5 mW/°C Above 85°C)	450 mW
Operating Temperature Range	-40°C to +85°C
Storage Temperature Range	-65°C to +150°C
Electrostatic Discharge (ESD) Sensitivity	
Human Body Model (HBM)	250 V
Field Induced Charged Device Model (FICDM)	500 V

Stresses at or above those listed under Absolute Maximum Ratings may cause permanent damage to the product. This is a stress rating only; functional operation of the product at these or any other conditions above those indicated in the operational section of this specification is not implied. Operation beyond the maximum operating conditions for extended periods may affect product reliability.

THERMAL RESISTANCE

Thermal performance is directly linked to PCB design and operating environment. Careful attention to PCB thermal design is required.

θ_{JA} is the natural convection junction to ambient thermal resistance measured in a one cubic foot sealed enclosure. θ_{JC} is the junction to case thermal resistance.

Table 3. Thermal Resistance

Package Type	θ_{JA}	θ_{JC}	Unit
E-24-1 ¹	120	200	°C/W

¹ Test Condition 1: JEDEC standard JESD51-2.

ESD CAUTION



ESD (electrostatic discharge) sensitive device. Charged devices and circuit boards can discharge without detection. Although this product features patented or proprietary protection circuitry, damage may occur on devices subjected to high energy ESD. Therefore, proper ESD precautions should be taken to avoid performance degradation or loss of functionality.

PIN CONFIGURATION AND FUNCTION DESCRIPTIONS

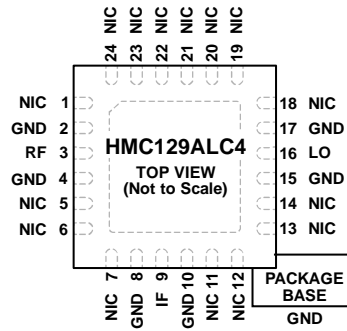

NOTES
 1. NIC = NOT INTERNALLY CONNECTED. THESE PINS CAN BE CONNECTED TO RF/DC GROUND. PERFORMANCE IS NOT AFFECTED.
 2. EXPOSED PAD. THE EXPOSED PAD MUST BE CONNECTED TO RF/DC GROUND.

Figure 2. Pin Configuration

Table 4. Pin Function Descriptions

Pin No.	Mnemonic	Description
1, 5, 6, 7, 11 to 14, 18 to 24	NIC	Not Internally Connected. These pins can be connected to RF/dc ground. Performance is not affected.
2, 4, 8, 10, 15, 17	GND	Ground. These pins and package bottom must be connect to RF/dc ground.
3	RF	Radio Frequency Port. This pin is ac-coupled and matched to 50 Ω.
9	IF	Intermediate Frequency Port. This pin is dc-coupled. For applications not requiring operation to dc, dc block this port externally using a series capacitor of a value chosen to pass the necessary IF frequency range. For operation to dc, this pin must not source/sink more than 6 mA of current or die malfunction and possible die failure may result.
16	LO EPAD	Local Oscillator Port. This pin is dc-coupled and matched to 50 Ω. Exposed Pad. The exposed pad must be connected to RF/dc ground.

INTERFACE SCHEMATICS



Figure 3. GND Interface Schematic

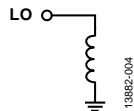

Figure 4. LO Interface Schematic

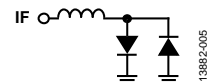

Figure 5. IF Interface Schematic

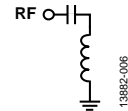

Figure 6. RF Interface Schematic

TYPICAL PERFORMANCE CHARACTERISTICS

DOWNCONVERTER PERFORMANCE

Downconverter performance at IF = 100 MHz, upper sideband (low-side LO).

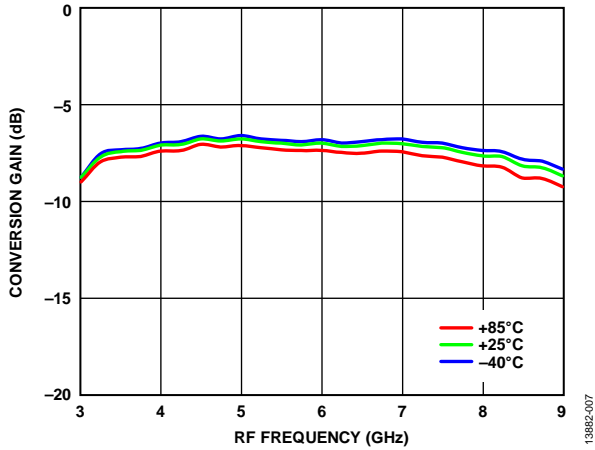

Figure 7. Conversion Gain vs. RF Frequency at Various Temperatures, LO = 15 dBm

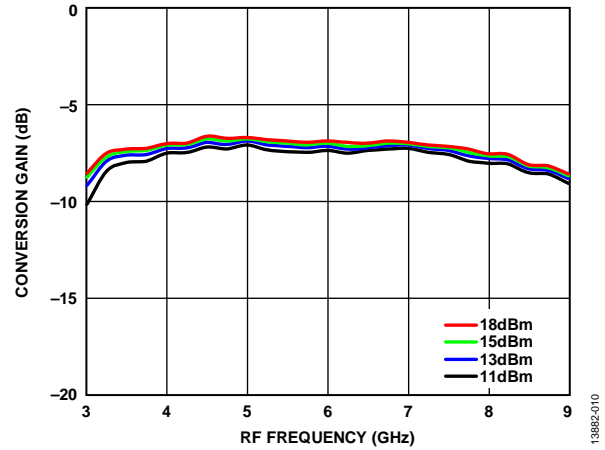

Figure 10. Conversion Gain vs. RF Frequency at Various LO Power Levels, $T_A = 25^\circ\text{C}$

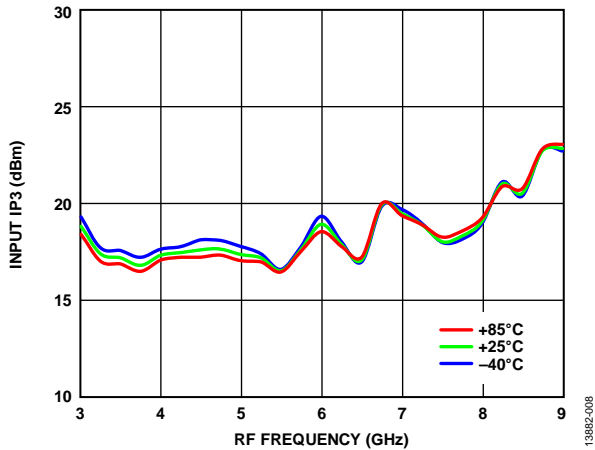

Figure 8. Input IP3 vs. RF Frequency at Various Temperatures, LO = 15 dBm

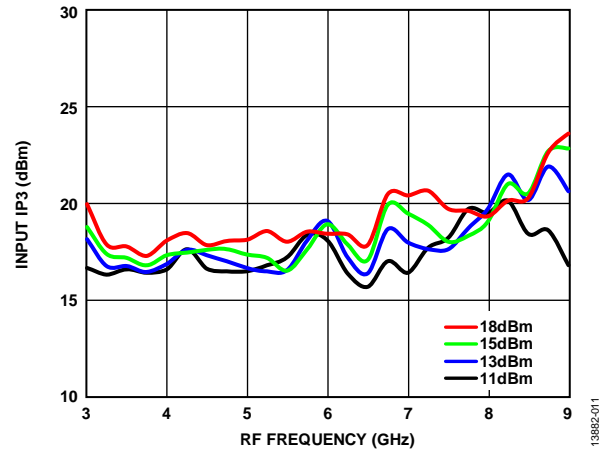

Figure 11. Input IP3 vs. RF Frequency at Various LO Power Levels, $T_A = 25^\circ\text{C}$

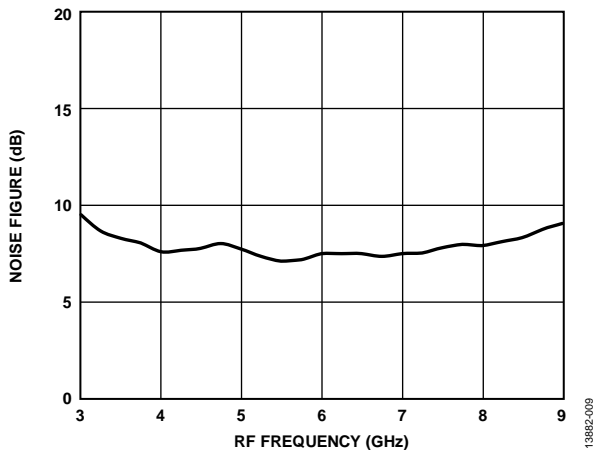

Figure 9. Noise Figure vs. RF Frequency at 25°C , LO = 15 dBm

Downconverter P1dB and IP2

IF = 100 MHz, upper sideband (low-side LO).

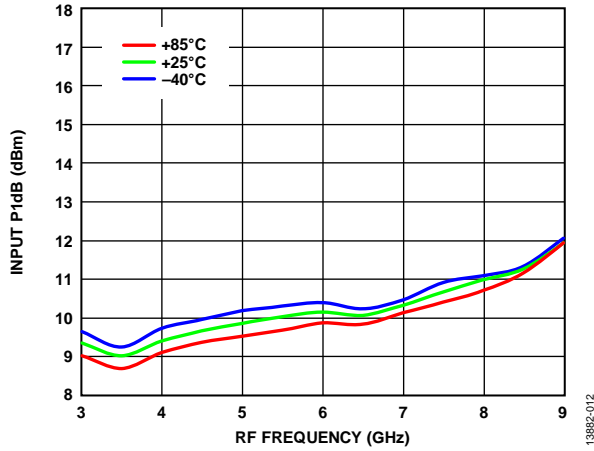

Figure 12. Input P1dB vs. RF Frequency at Various Temperatures, LO = 15 dBm

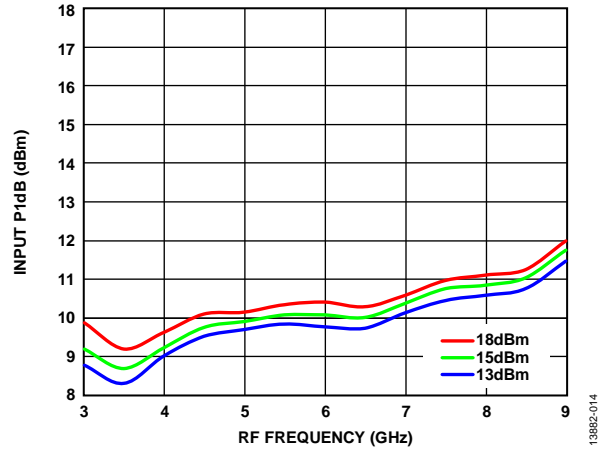

Figure 14. Input P1dB vs. RF Frequency at Various LO Power Levels, TA = 25°C

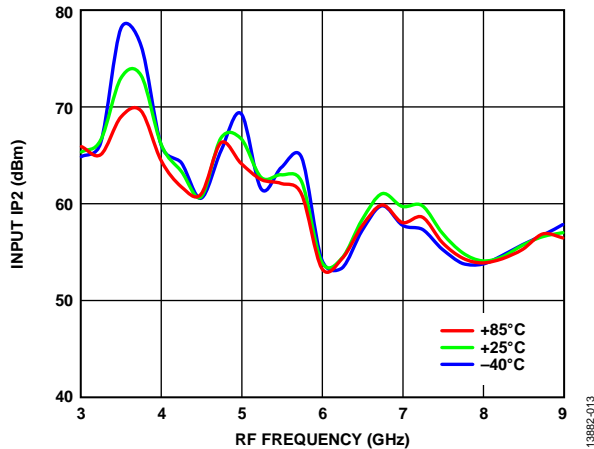

Figure 13. Input IP2 vs. RF Frequency at Various Temperatures, LO = 15 dBm

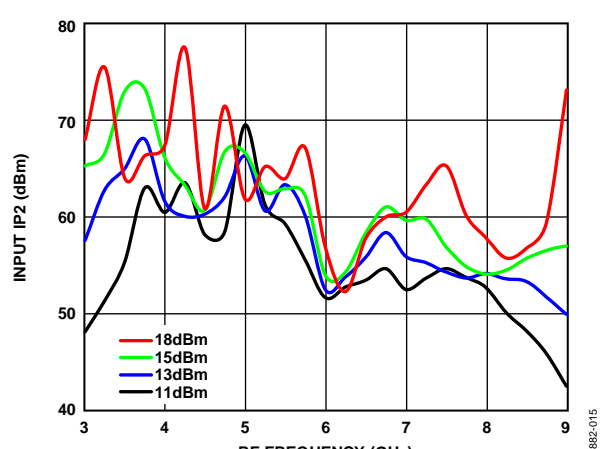

Figure 15. Input IP2 vs. RF Frequency at Various LO Power Levels, TA = 25°C

UPCONVERTER PERFORMANCE

Upconverter performance at IF = 100 MHz, upper sideband.

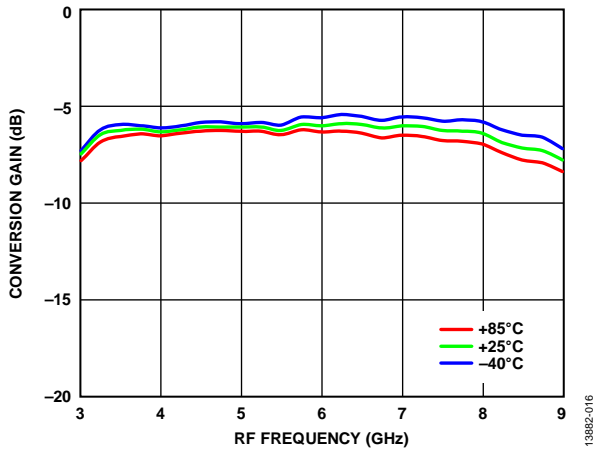

Figure 16. Conversion Gain vs. RF Frequency at Various Temperatures, LO = 15 dBm

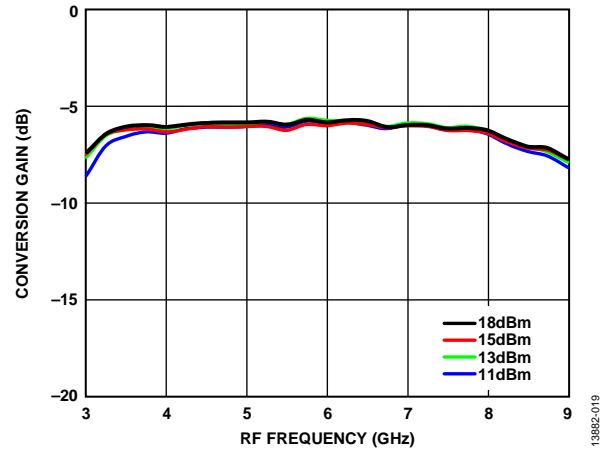

Figure 19. Conversion Gain vs. RF Frequency at Various LO Power Levels, $T_A = 25^\circ\text{C}$

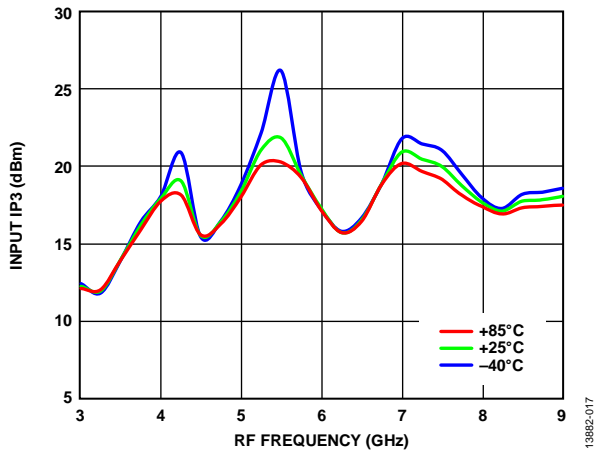

Figure 17. Input IP3 vs. RF Frequency at Various Temperatures, LO = 15 dBm

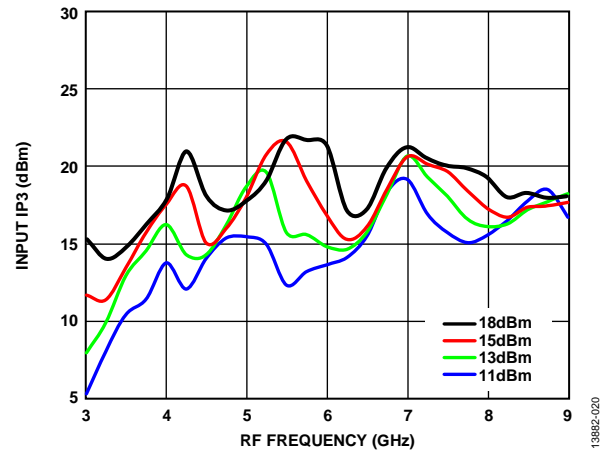

Figure 20. Input IP3 vs. RF Frequency at Various LO Power Levels, $T_A = 25^\circ\text{C}$

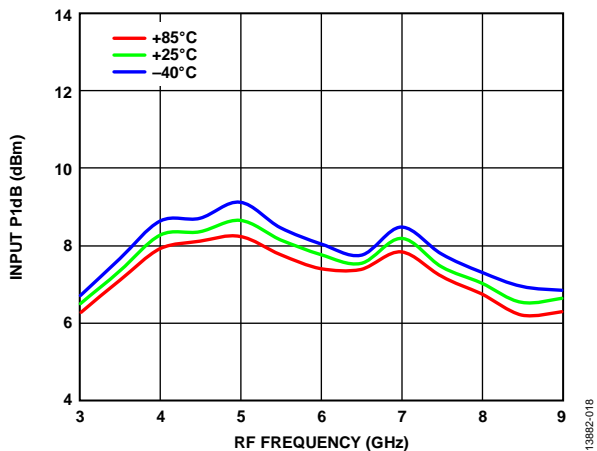

Figure 18. Input P1dB vs. RF Frequency at Various Temperatures, LO = 15 dBm

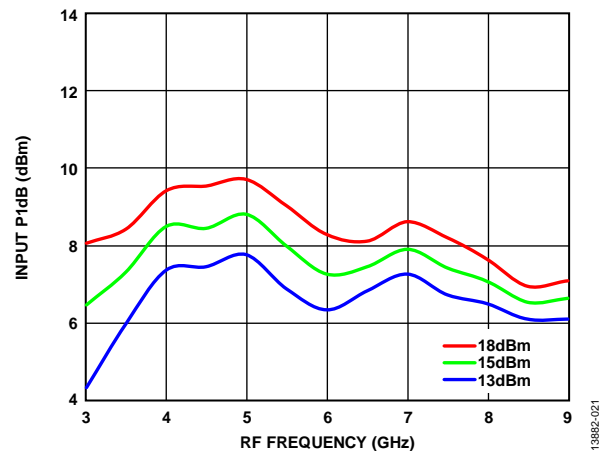

Figure 21. Input P1dB vs. RF Frequency at Various LO Power Levels, $T_A = 25^\circ\text{C}$

ISOLATION AND RETURN LOSS

Downconverter performance at IF = 100 MHz, upper sideband.

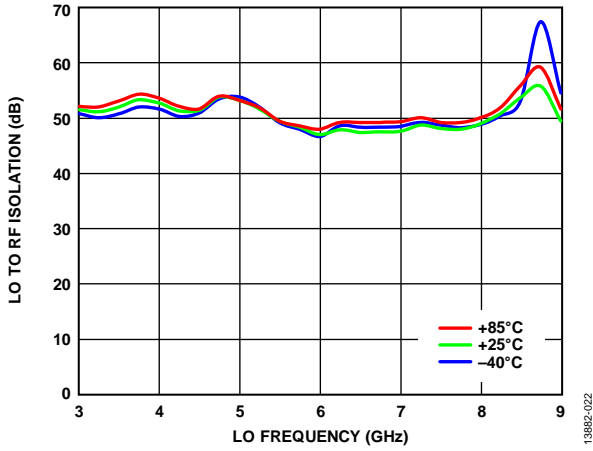

Figure 22. LO to RF Isolation vs. LO Frequency at Various Temperatures, LO = 15 dBm

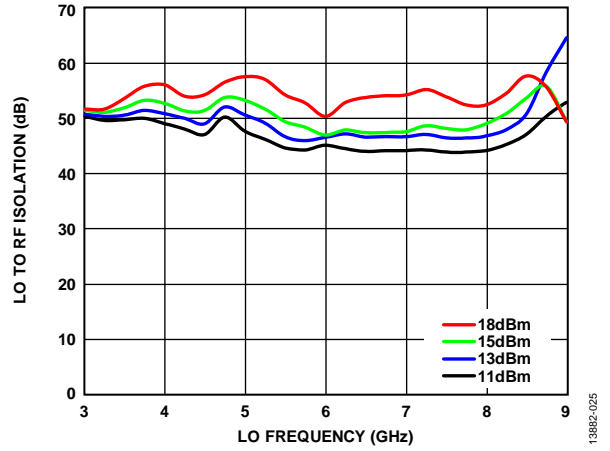

Figure 25. LO to RF Isolation vs. LO Frequency at Various LO Power levels, $T_A = 25^\circ\text{C}$

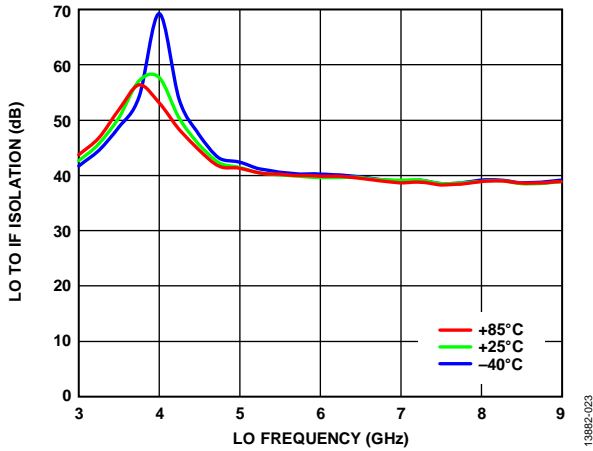

Figure 23. LO to IF Isolation vs. LO Frequency at Various Temperatures, LO = 15 dBm

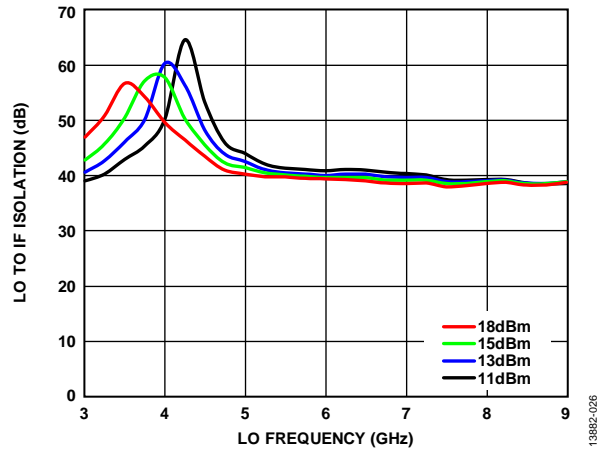

Figure 26. LO to IF Isolation vs. LO Frequency at Various LO Power Levels, $T_A = 25^\circ\text{C}$

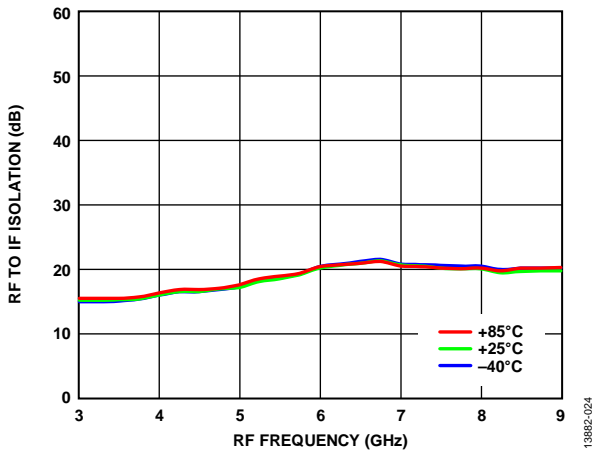

Figure 24. RF to IF Isolation vs. RF Frequency at Various Temperatures, LO = 15 dBm

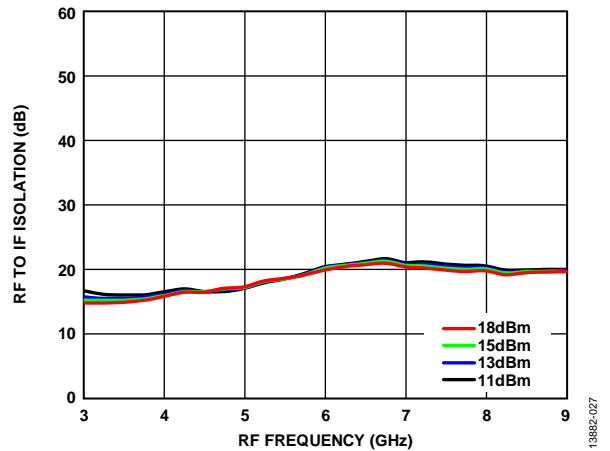

Figure 27. RF to IF Isolation vs. RF Frequency at Various LO Power Levels, $T_A = 25^\circ\text{C}$

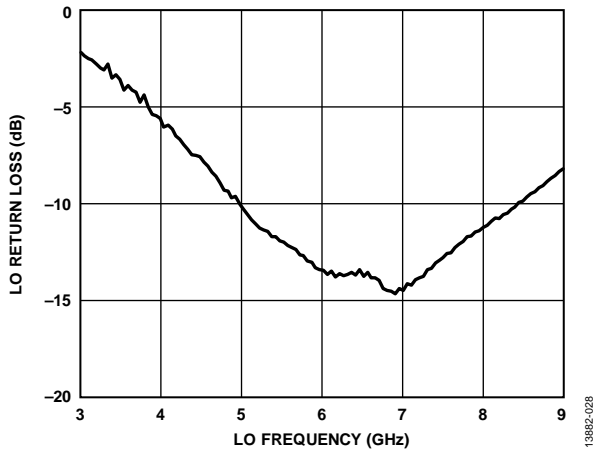

Figure 28. LO Return Loss vs. LO Frequency at 25°C, LO = 15 dBm

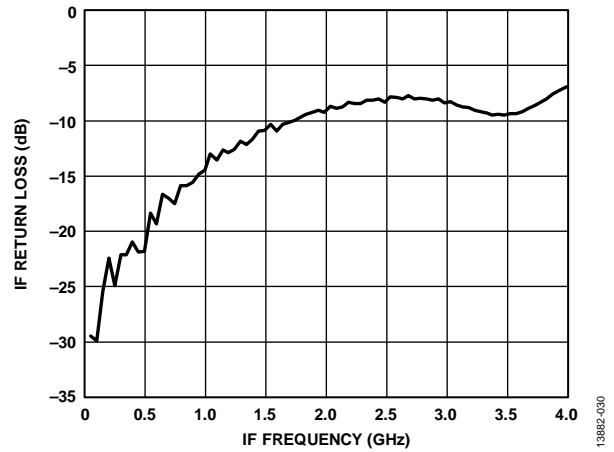

Figure 30. IF Return Loss vs. IF Frequency at 25°C, LO = 6 GHz, 15 dBm

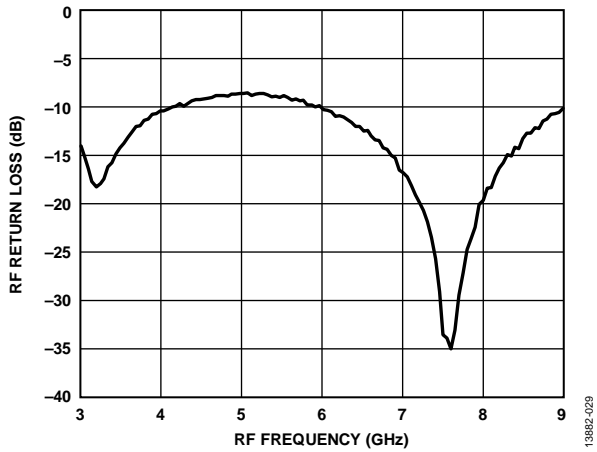

Figure 29. RF Return Loss vs. RF Frequency at 25°C, LO = 6 GHz, 15 dBm

IF BANDWIDTH—DOWNCONVERTER

Upper sideband, LO frequency = 6 GHz

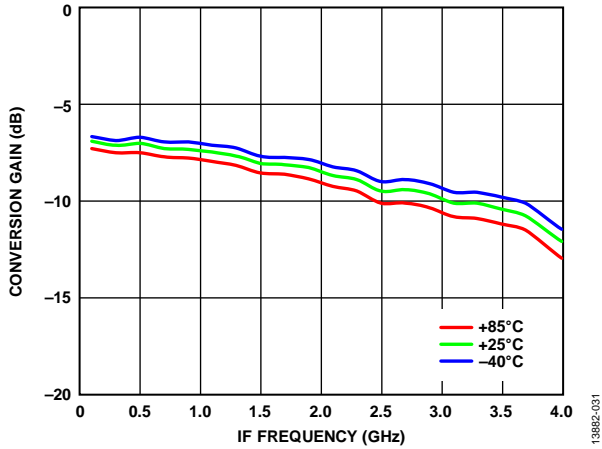

Figure 31. Conversion Gain vs. IF Frequency at Various Temperatures, LO = 15 dBm

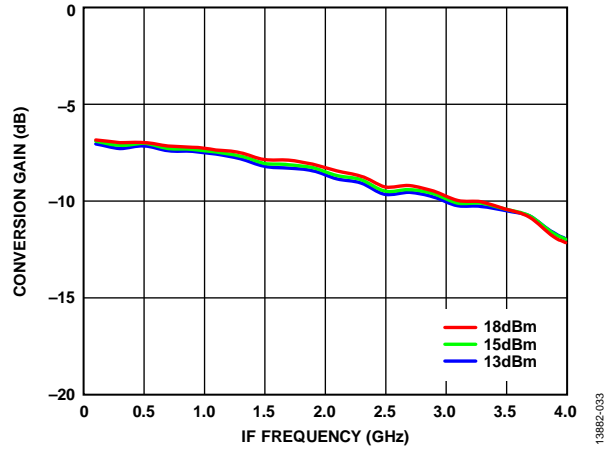

Figure 33. Conversion Gain vs. IF Frequency at Various LO Power Levels, $T_A = 25^\circ\text{C}$

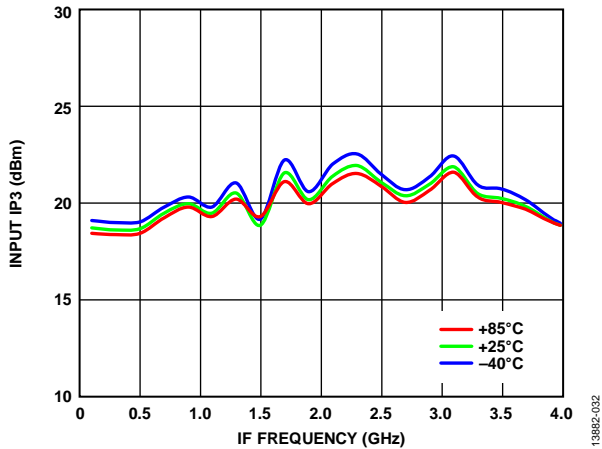

Figure 32. Input IP3 vs. IF Frequency at Various Temperatures, LO = 15 dBm

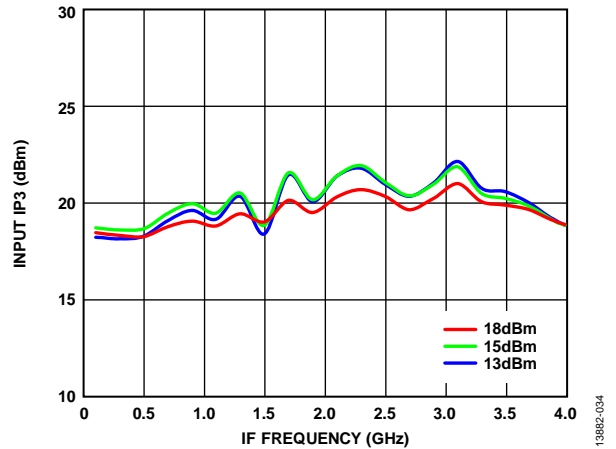

Figure 34. Input IP3 vs. IF Frequency at Various LO Power Levels, $T_A = 25^\circ\text{C}$

IF BANDWIDTH—UPCONVERTER

Upper sideband, LO frequency = 6 GHz.

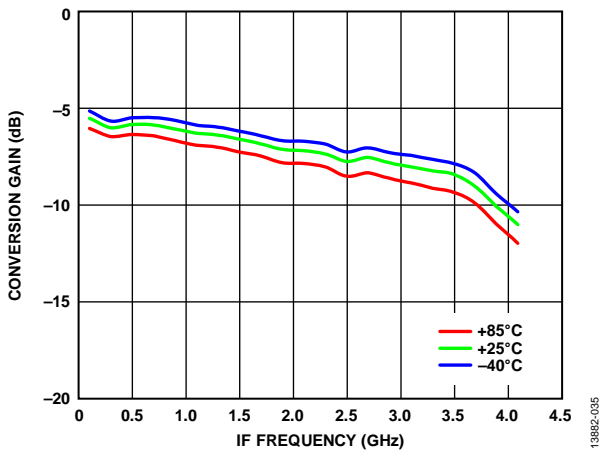

Figure 35. Conversion Gain vs. IF Frequency at Various Temperatures, LO = 15 dBm

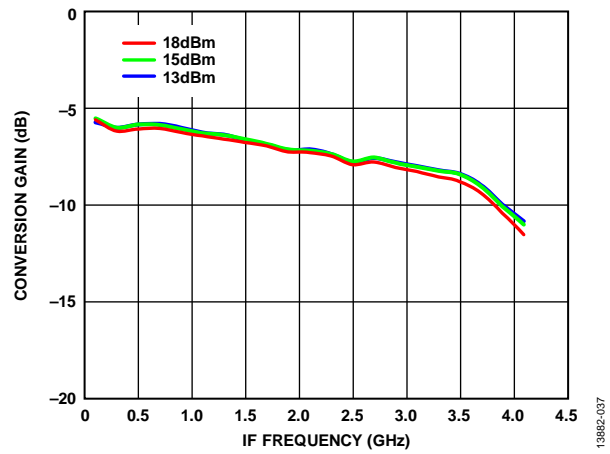

Figure 37. Conversion Gain vs. IF Frequency at Various LO Power Levels, TA = 25°C

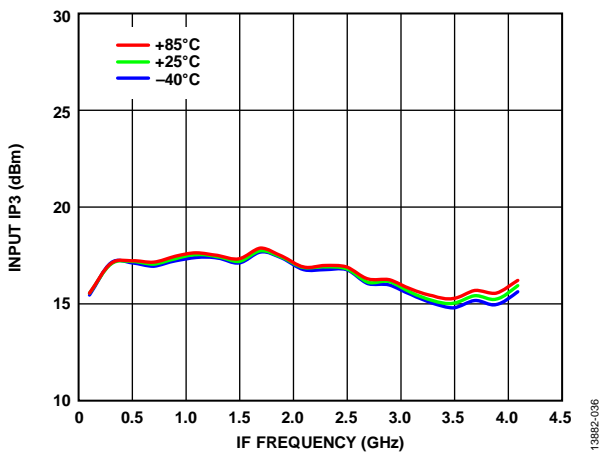

Figure 36. Input IP3 at vs. IF Frequency at Various Temperatures, LO = 15 dBm

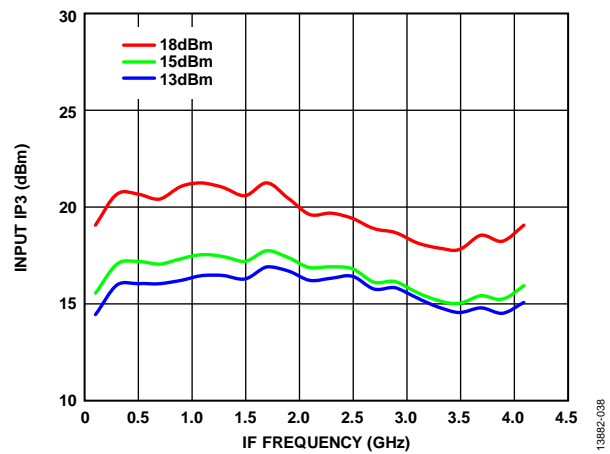

Figure 38. Input IP3 vs. IF Frequency at Various LO Power Levels, TA = 25°C

SPURIOUS AND HARMONICS PERFORMANCE

Mixer spurious products are measured in dBc from the IF output power level. N/A means not applicable.

Downconverter $M \times N$ Spurious Outputs

Spur values are $(M \times RF) - (N \times LO)$.

RF = 6.1GHz at -10 dBm , LO = 6 GHz at 15 dBm.

		N x LO				
		0	1	2	3	4
M x RF	0	N/A	7	34	30	53
	1	13	0	34	46	72
	2	85	66	68	65	88
	3	86	89	87	74	80
	4	84	85	89	92	101

Upconverter $M \times N$ Spurious Outputs

Spur values are $(M \times IF) + (N \times LO)$.

IF = 100 MHz at -10 dBm, LO = 6 GHz at 15 dBm.

		N x LO				
		0	1	2	3	4
M x IF	0	N/A	24	15	29	39
	1	74	0	30	39	53
	2	103	67	61	72	84
	3	102	64	85	88	85
	4	101	93	93	89	86

THEORY OF OPERATION

The HMC129ALC4 is a general-purpose, double-balanced mixer that can be used as an upconverter or a downconverter from 4 GHz to 8 GHz.

When used as a downconverter, the HMC129ALC4 downconverts radio frequencies (RF) between 4 GHz and 8 GHz to intermediate frequencies (IF) between dc and 3 GHz.

When used as an upconverter, the mixer upconverts intermediate frequencies between dc and 3 GHz to radio frequencies between 4 GHz and 8 GHz.

APPLICATIONS INFORMATION

TYPICAL APPLICATION CIRCUIT

Figure 39 shows the typical application circuit for the HMC129ALC4. The HMC129ALC4 is a passive device and does not require any external components. The LO pin is internally ac-coupled. The RF and IF pins are internally dc-coupled. When IF operation to dc is not required, using an external series capacitor is recommended, of a value chosen to pass the necessary IF frequency range. When IF operation to dc is required, do not exceed the IF source and sink current rating specified in the Absolute Maximum Ratings section.

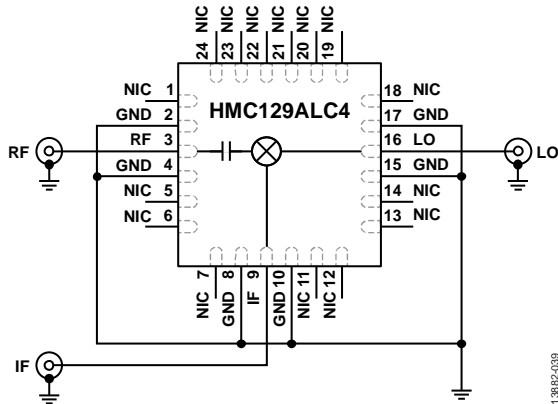

Figure 39. Typical Application Circuit

EVALUATION PCB INFORMATION

Use RF circuit design techniques for the circuit board used in the application. Ensure that signal lines have 50 Ω impedance, and connect the package ground leads and the exposed pad directly to the ground plane (see Figure 40). Use a sufficient number of via holes to connect the top and bottom ground planes. The evaluation circuit board shown in Figure 40 is available from Analog Devices, Inc., upon request.

Table 5. List of Materials for Evaluation PCB
EV1HMC129ALC4

Item	Description
J1 to J3	PCB mount SMA connector
U1	HMC129ALC4
PCB ¹	109726 evaluation board on Rogers 4350

¹ 109726 is the raw bare PCB identifier. Reference EV1HMC129ALC4 when ordering the complete evaluation PCB.

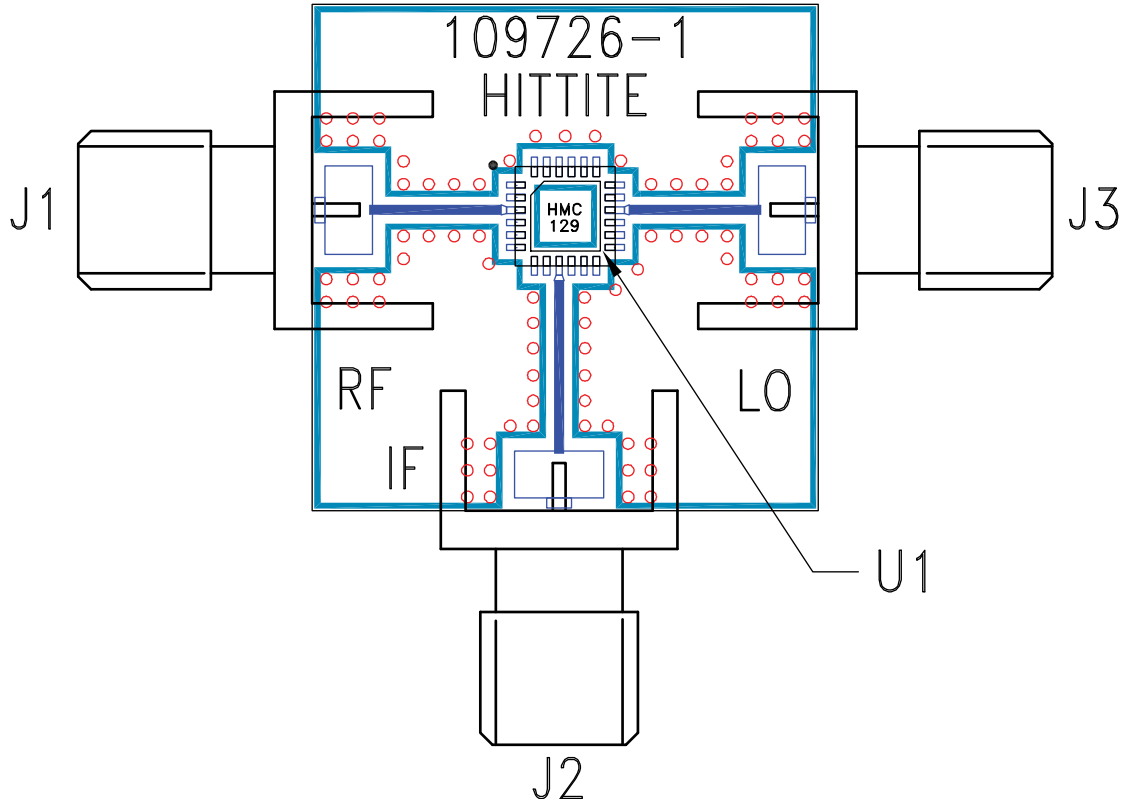

Figure 40. Evaluation PCB Top Layer

OUTLINE DIMENSIONS

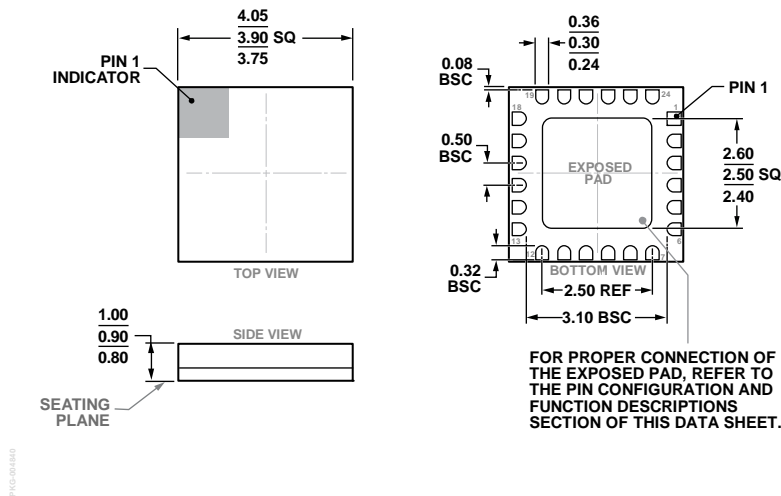

Figure 41. 24-Terminal Ceramic Leadless Chip Carrier (LCC)
(E-24-1)
Dimensions shown in millimeters

ORDERING GUIDE

Model ¹	Temperature Range	MSL Rating ²	Package Description	Package Option	Branding
HMC129ALC4	-40°C to +85°C	3	24-Terminal Ceramic LCC	E-24-1	H129A XXXX
HMC129ALC4TR	-40°C to +85°C	3	24-Terminal Ceramic LCC	E-24-1	H129A XXXX
HMC129ALC4TR-R5	-40°C to +85°C	3	24-Terminal Ceramic LCC	E-24-1	H129A XXXX
EV1HMC129ALC4			Evaluation PCB Assembly		

¹ The HMC129ALC4, HMC129ALC4TR, and HMC129ALC4TR-R5 are RoHS compliant.

² The peak reflow temperature is 260°C. See the Absolute Maximum Ratings section, Table 2.

Данный компонент на территории Российской Федерации

Вы можете приобрести в компании MosChip.

Для оперативного оформления запроса Вам необходимо перейти по данной ссылке:

<http://moschip.ru/get-element>

Вы можете разместить у нас заказ для любого Вашего проекта, будь то серийное производство или разработка единичного прибора.

В нашем ассортименте представлены ведущие мировые производители активных и пассивных электронных компонентов.

Нашей специализацией является поставка электронной компонентной базы двойного назначения, продукции таких производителей как XILINX, Intel (ex.ALTERA), Vicor, Microchip, Texas Instruments, Analog Devices, Mini-Circuits, Amphenol, Glenair.

Сотрудничество с глобальными дистрибьюторами электронных компонентов, предоставляет возможность заказывать и получать с международных складов практически любой перечень компонентов в оптимальные для Вас сроки.

На всех этапах разработки и производства наши партнеры могут получить квалифицированную поддержку опытных инженеров.

Система менеджмента качества компании отвечает требованиям в соответствии с ГОСТ Р ИСО 9001, ГОСТ РВ 0015-002 и ЭС РД 009

Офис по работе с юридическими лицами:

105318, г.Москва, ул.Щербаковская д.3, офис 1107, 1118, ДЦ «Щербаковский»

Телефон: +7 495 668-12-70 (многоканальный)

Факс: +7 495 668-12-70 (доб.304)

E-mail: info@moschip.ru

Skype отдела продаж:

moschip.ru

moschip.ru_4

moschip.ru_6

moschip.ru_9