

## SINGLE SUPPLY WIDE BAND 3ch VIDEO AMPLIFIER

### ■ GENERAL DESCRIPTION

The **NJM2580** is a wide band 3ch video amplifier, operated on a single supply voltage. It is suitable for Y, Pb, and Pr signal because frequency range is 50MHz.

The **NJM2580** is suitable for Set Top Box, AV amplifier, and other high quality AV systems.

### ■ PACKAGE OUTLINE

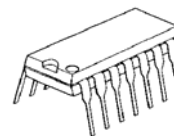

**NJM2580D**

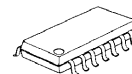

**NJM2580M**



**NJM2580V**

### ■ FEATURES

- Operating Voltage                   4.5 to 5.5V
- Wide frequency range            0dB at 50MHz typ.
- Internal 6dB Amplifier
- Internal 75Ω Driver Circuit (2-system drive)
- Power Save Circuit
- Bipolar Technology
- Package Outline                   DIP14, DMP14, SSOP14

### ■ BLOCK DIAGRAM

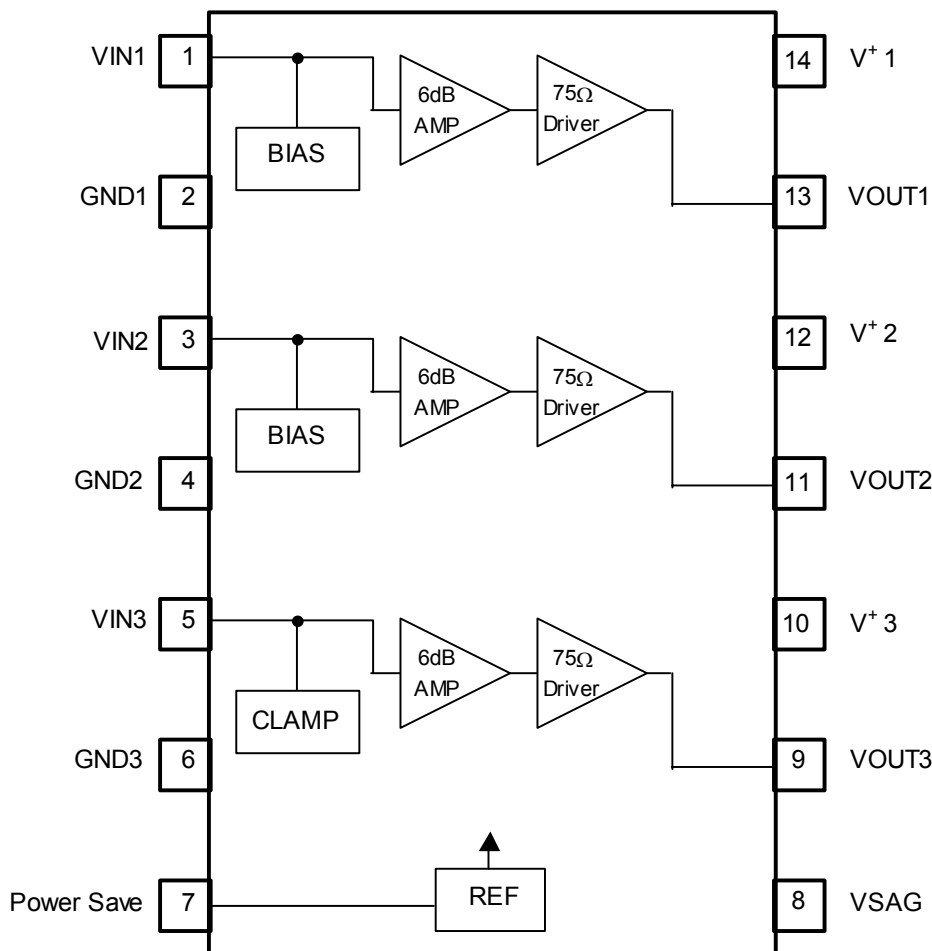

# NJM2580

## ■ ABSOLUTE MAXIMUM RATINGS

(Ta=25°C)

PARAMETERS	SYMBOL	RATINGS	UNIT
Supply Voltage	V <sup>+</sup>	12.0	V
Power Dissipation	P <sub>D</sub>	(DIP) 620 (DMP) 430 (SSOP)520 *	mW
Operating Temperature Range	Topr	-40 to +85	°C
Storage Temperature Range	Tstg	-40 to +150	°C

(Note) At on a board of EIA/JEDEC specification. (114.3 x 76.2 x 1.6mm Two layers, FR-4)

## ■ ELECTRICAL CHARACTERISTICS

(V<sup>+</sup>=5.0V, R<sub>L</sub>=150Ω, Ta=25°C)

PARAMETER	SYMBOL	TEST CONDITION	MIN.	TYP.	MAX.	UNIT
Operating Current	I <sub>CC</sub>	No signal	-	23.0	33.0	mA
Operating Current (Power Save)	I <sub>save</sub>	No signal, Power Save	-	-	1.2	mA
Maximum Output Voltage1	V <sub>om1</sub>	BIAS input Vin=1kHz, Sin signal, THD=1%,	2.4	3.0	-	Vp-p
Maximum Output Voltage2	V <sub>om2</sub>	CLAMP input Vin=1kHz, Sin signal, THD=1%,	2.2	2.4	-	Vp-p
Voltage Gain	G <sub>v</sub>	Vin=1MHz, 1.0Vp-p Sin signal	6.0	6.4	6.8	dB
Band Width	f		-	50	-	MHz
Frequency Characteristic	G <sub>f</sub>	Vin=50MHz / 1MHz, 1.0Vp-p, Sin signal	-	0	-	dB
Cross talk 1	CTB1	Vin=4.43MHz, 1.0Vp-p, Sin signal	-	-60	-50	dB
Cross talk 2	CTB2	Vin=50MHz, 1.0Vp-p, Sin signal	-	-40	-	dB
Differential Gain	DG	Vin=1.0Vpp 10step Video signal	-	0.3	-	%
Differential Phase	DP	Vin=1.0Vpp 10step Video signal	-	0.3	-	deg
S/N	SN <sub>v</sub>	Vin=1.0Vpp, 100% White Video signal	-	65	-	dB
Power Save Switch Change Voltage H Level	V <sub>thPH</sub>	IC Operating	2.0	-	V <sup>+</sup>	V
Power Save Switch Change Voltage L Level	V <sub>thPL</sub>	IC Waiting	0	-	0.6	V

## ■ MODE SWITCH FUNCTION

PIN	MODE	NOTES
Power Save	H	Power Save: OFF
	L	Power Save: ON (Mute)
	OPEN	Power Save: ON (Mute)

■ EQUIVALENT CIRCUIT (V+=5V)

PIN No.	NAME	INSIDE EQUIVALENT CIRCUIT	VOLTAGE
1 3	VIN1 VIN2		2.60V
5	VIN3		1.70V
13 11	VOUT1 VOUT2		2.55V
9	VOUT3		1.35V

# NJM2580

## ■ EQUIVALENT CIRCUIT (V+=5V)

PIN No.	NAME	INSIDE EQUIVALENT CIRCUIT	VOLTAGE
7	Power Save		0V
8	VSAG		1.40V
14 12 10	V <sup>+</sup> 1 V <sup>+</sup> 2 V <sup>+</sup> 3		5V
2 4 6	GND1 GND2 GND3		0V

## TEST CIRCUIT



# NJM2580

## APPLICATION CIRCUIT 1



## APPLICATION CIRCUIT 2



## ■ TYPICAL CHARACTERISTICS

### Voltage Gain vs. Frequency

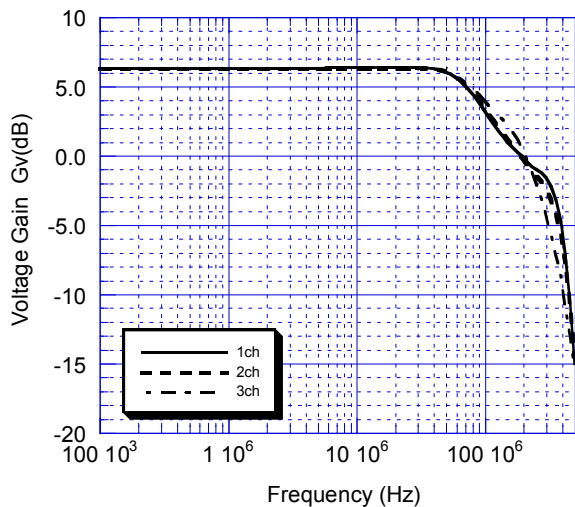

### Operating Current vs. Supply Voltage

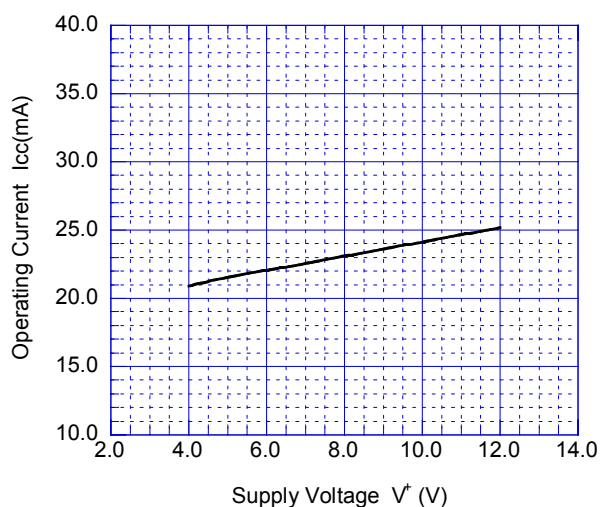

### Operating Current at Standby State vs. Supply Voltage

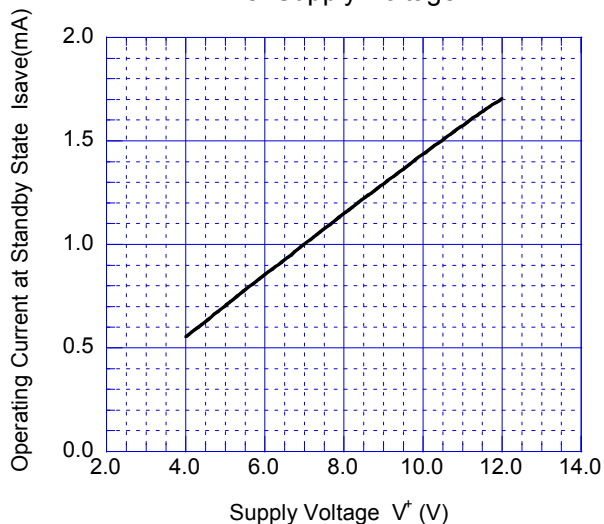

### Maximum Output Voltage Swing vs. Supply Voltage (BIAS Type Input)

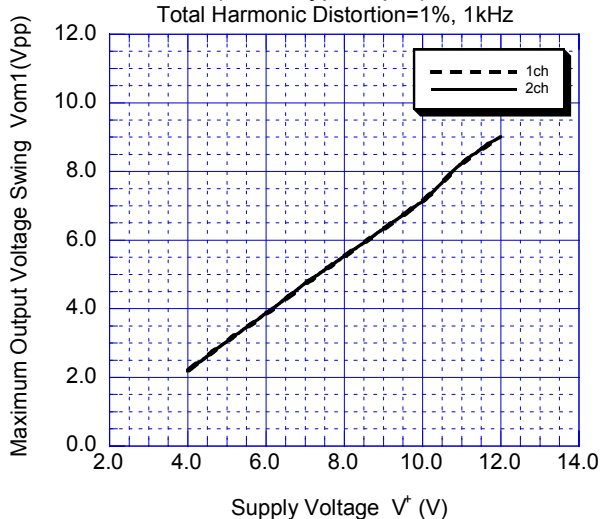

### Maximum Output Voltage Swing vs. Supply Voltage (CLAMP Type Input)

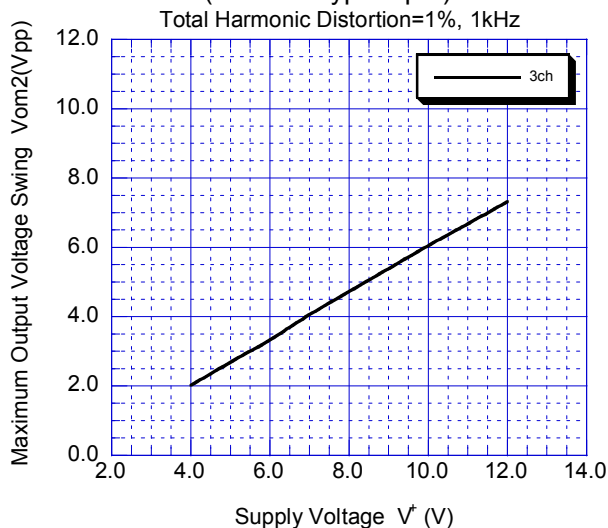

### Voltage Gain vs. Supply Voltage

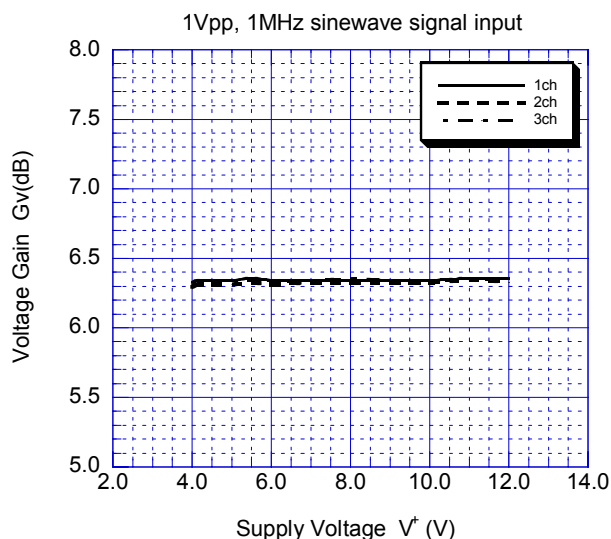

## TYPICAL CHARACTERISTICS

### Gain Frequency Characteristics vs. Supply Voltage

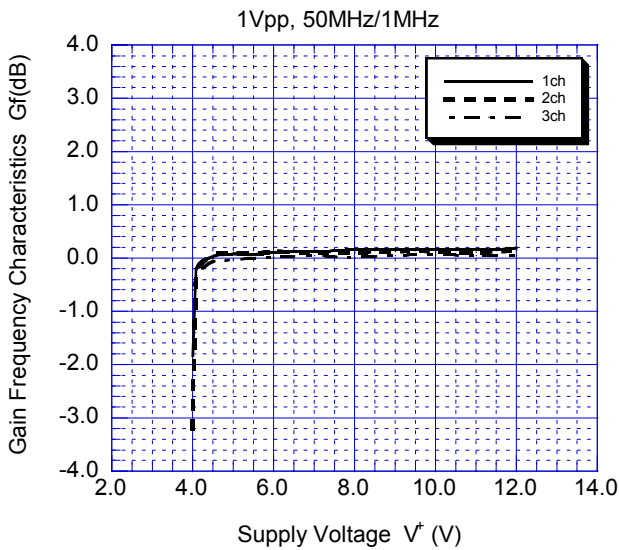

### Channel Gain Difference vs. Supply Voltage

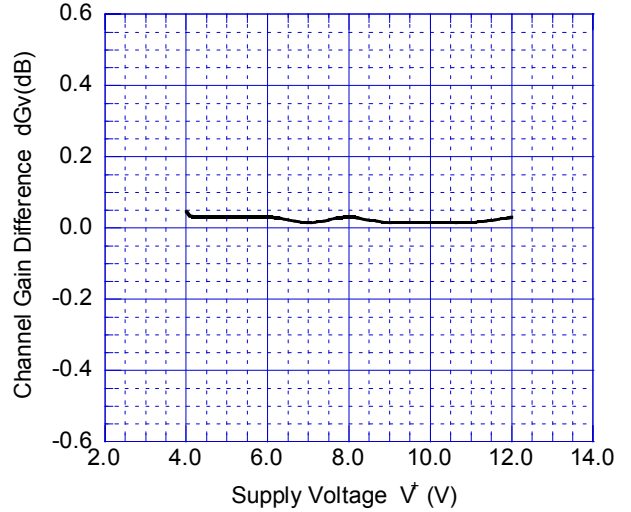

### Cross Talk 1 vs. Supply Voltage

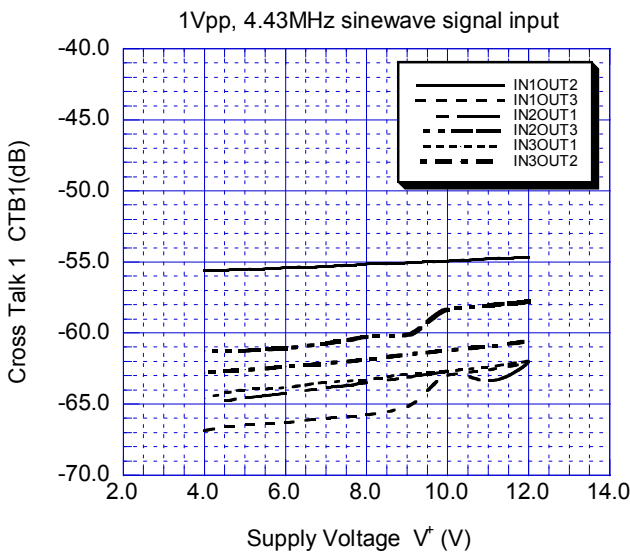

### Cross Talk 2 vs. Supply Voltage



### Differential Gain vs. Supply Voltage

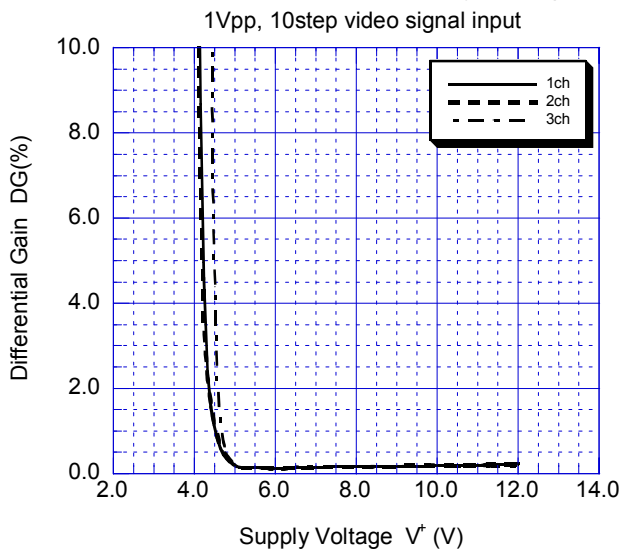

### Differential Phase vs. Supply Voltage

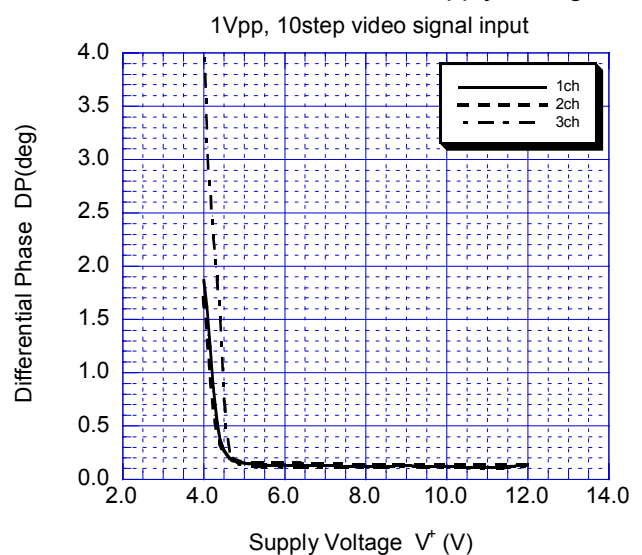



## ■ TYPICAL CHARACTERISTICS

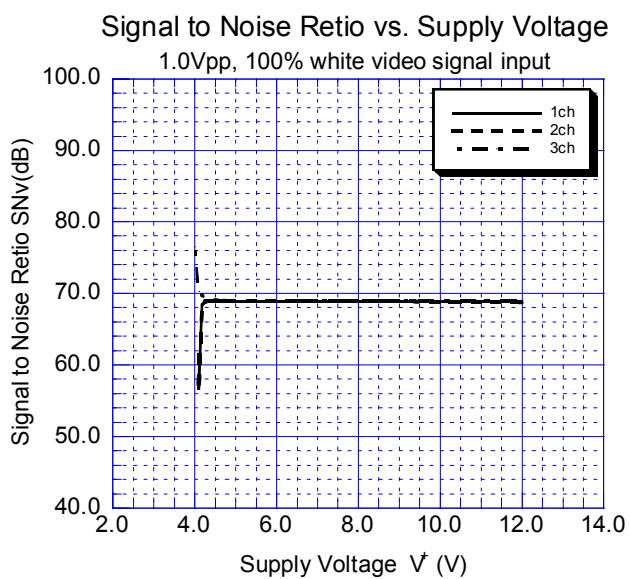

[CAUTION]  
The specifications on this data book are only given for information, without any guarantee as regards either mistakes or omissions. The application circuits in this data book are described only to show representative usages of the product and not intended for the guarantee or permission of any right including the industrial rights.

## Данный компонент на территории Российской Федерации

### Вы можете приобрести в компании MosChip.

Для оперативного оформления запроса Вам необходимо перейти по данной ссылке:

<http://moschip.ru/get-element>

Вы можете разместить у нас заказ для любого Вашего проекта, будь то серийное производство или разработка единичного прибора.

В нашем ассортименте представлены ведущие мировые производители активных и пассивных электронных компонентов.

Нашей специализацией является поставка электронной компонентной базы двойного назначения, продукции таких производителей как XILINX, Intel (ex.ALTERA), Vicor, Microchip, Texas Instruments, Analog Devices, Mini-Circuits, Amphenol, Glenair.

Сотрудничество с глобальными дистрибьюторами электронных компонентов, предоставляет возможность заказывать и получать с международных складов практически любой перечень компонентов в оптимальные для Вас сроки.

На всех этапах разработки и производства наши партнеры могут получить квалифицированную поддержку опытных инженеров.

Система менеджмента качества компании отвечает требованиям в соответствии с ГОСТ Р ИСО 9001, ГОСТ РВ 0015-002 и ЭС РД 009

### Офис по работе с юридическими лицами:

105318, г.Москва, ул.Щербаковская д.3, офис 1107, 1118, ДЦ «Щербаковский»

Телефон: +7 495 668-12-70 (многоканальный)

Факс: +7 495 668-12-70 (доб.304)

E-mail: [info@moschip.ru](mailto:info@moschip.ru)

Skype отдела продаж:

moschip.ru

moschip.ru\_4

moschip.ru\_6

moschip.ru\_9