

Digital Controllers E5□R

New DeviceNet-compatible models offer high-speed and high-precision as general-purpose Digital Controllers with an even broader range of application.



E5□R Series

E5AR



96 · 96 · 95 mm

E5ER



96 · 48 · 95 mm

Contents

Digital Controllers

E5AR	5
E5ER	19

Common to All Controllers

• Nomenclature	36
• Installation	37
• Drawing Out.....	38
• Wiring Precautions	38
• Initial Setup.....	39
• Specification Setting after Turning ON Power	40
• Error Display (Troubleshooting)	50
• Troubleshooting	51
• Peripheral Devices	52
• Precautions	53
• Warranty and Limitations of Liability	55
• Application Considerations.....	55

■ E5□R Selection Guide

Standard type

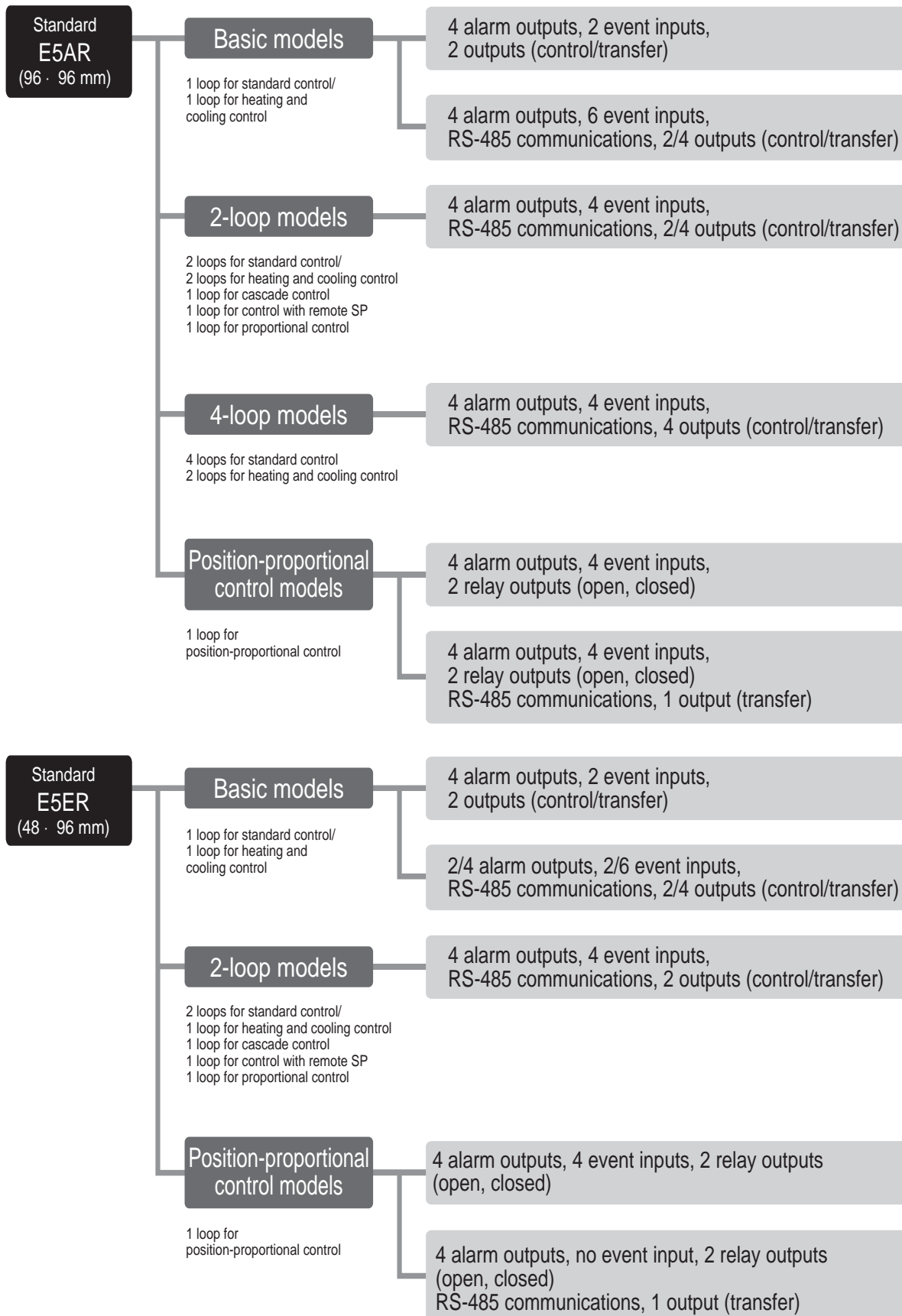

DeviceNet type

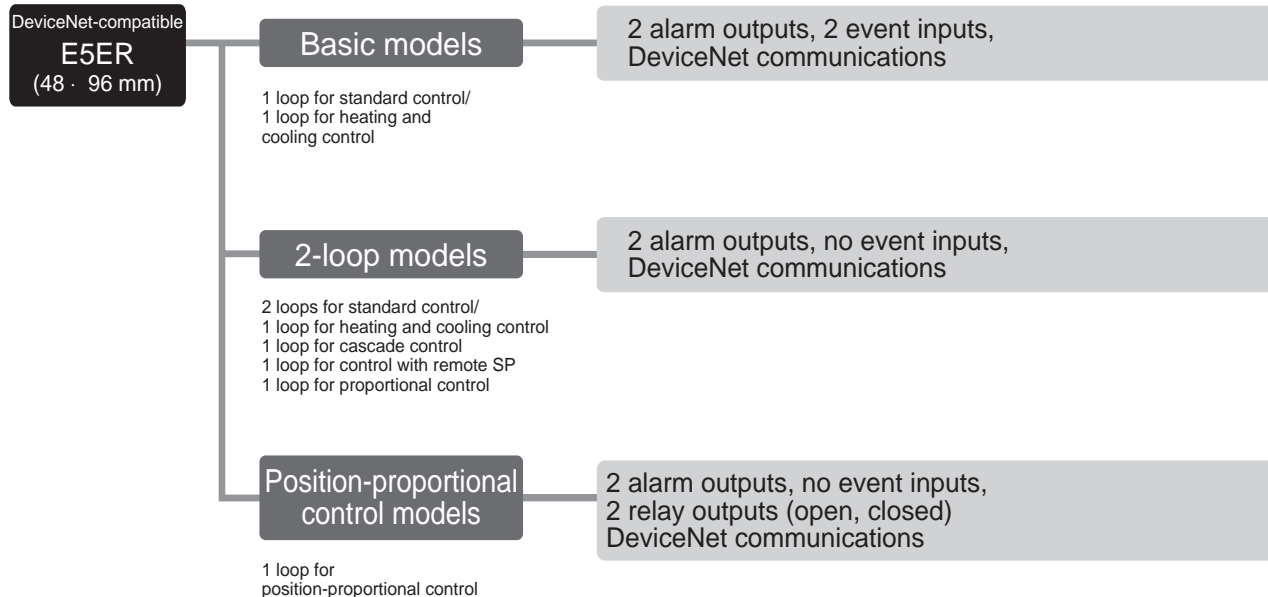
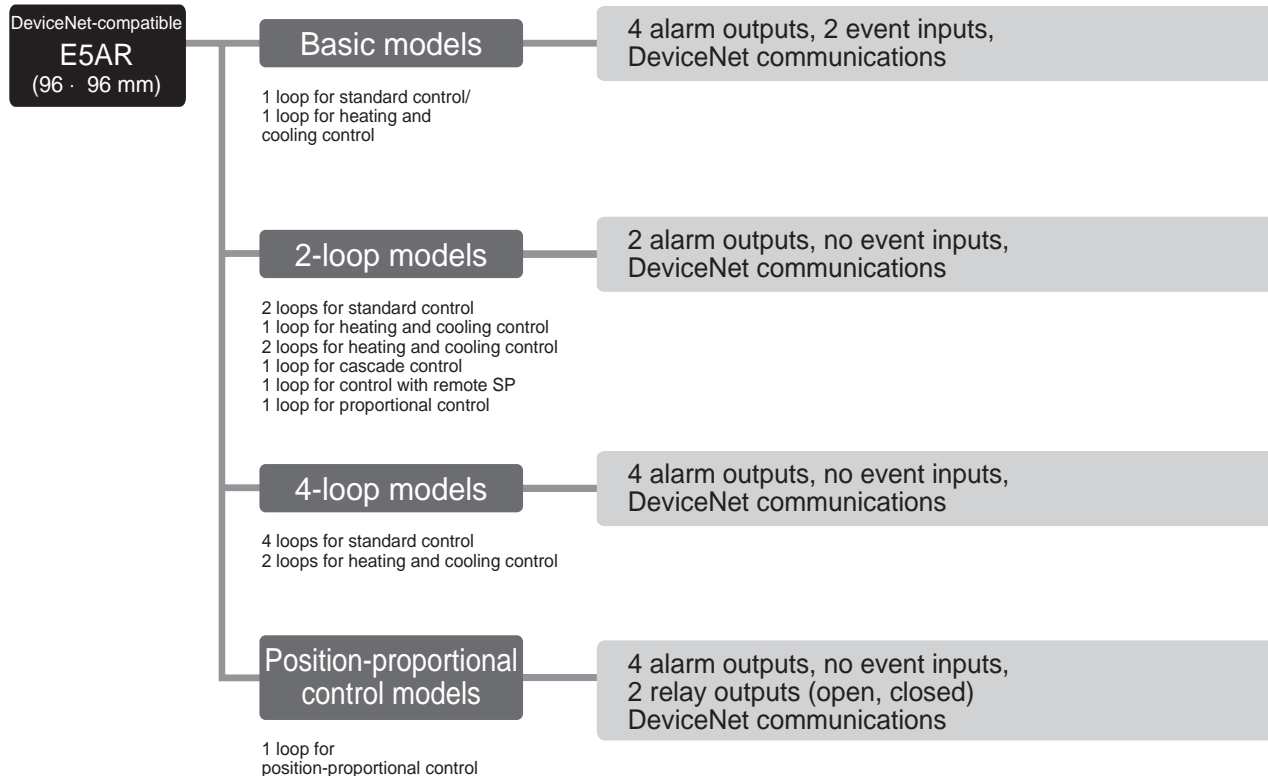



■ Applications

High-speed

Problem Lack of reasonably-priced controller for devices requiring high-speed response (e.g., ceramic heaters) resulting in using expensive machinery with unnecessary functions.

Solution

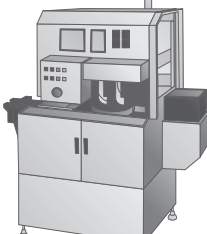
- Improved control performance with high-speed sampling at 50 ms.
- Moderately priced and easily operated.

Applications

- Bonding equipment
- Evaporation equipment
- Coil winding machinery

High-resolution

Problem Need for high-resolution measuring and monitoring of internal temperatures of devices while handling fluctuations at high-resolution.

Solution Greater input resolution with Pt sensor (0.01°C resolution)



Applications

- Semiconductor production lines (exposure, air-conditioning)
- Environmental testing equipment
- Vacuum heating furnace
- Sterilizing equipment
- Food processing machinery

■ Features

Easily Coordinate Control with PLCs Using Various I/O

• Up to 6 Event Inputs

Externally control bank switching (4/8 banks), RUN/STOP, auto/manual, SP mode, communications write enable/disable, and other operations with event inputs.

• Up to 2 Transfer Outputs

Externally output PVs, SPs, MVs, and ramp SP monitor values for each loop.

• Up to 4 Auxiliary Outputs

Externally output warnings for 11 alarm modes and input errors.

• RS-485 Serial Communications

Simply share data, such as PVs and SPs, with an OMRON PLC (without requiring special programming). Only settings are required.

• DeviceNet Communications

Perform high-speed data communications with the PLC without requiring special programming. Unified management of communications from a DeviceNet Configurator is also possible.

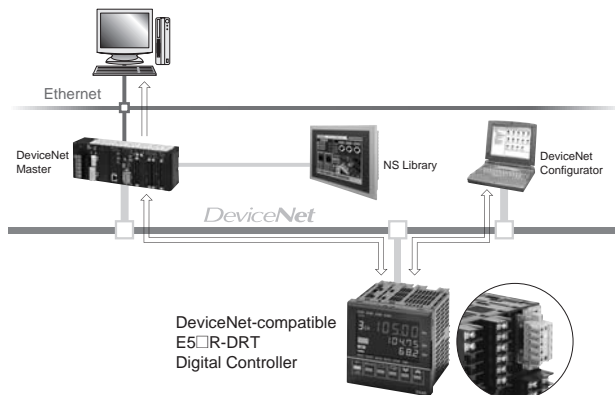

Control Up to 4 Loops with a Single Unit

Models with 1, 2, and 4 analog inputs are available (see note). Various control modes can also be selected in the software settings, including standard control, heating/cooling control, cascade control, position-proportional control, and remote SP control. This allows a single Unit to perform multipoint control (up to 4 loops for the E5AR, and up to 2 loops for the E5ER), cascade control, and proportional control.

Temperature, humidity, and pressure can be controlled simultaneously for up to 4 points from a single Unit, contributing to reduced costs and smaller panels.

Note: Models with 4 analog inputs are 96 x 96 mm (E5AR only).

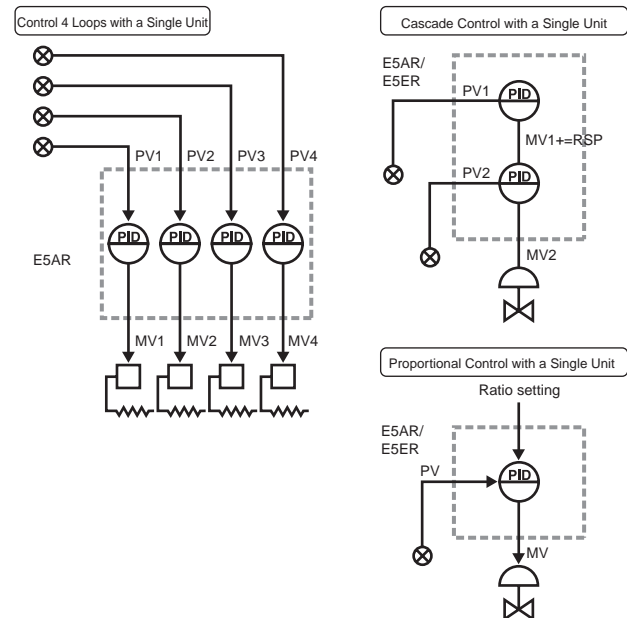

Digital Controllers E5AR

E5AR Digital Controllers offer high speed, high precision, and multiple I/O and use a 5-digit, 3-row LCD display for high visual clarity.

- A short sampling period of 50 ms enables use in applications requiring high-speed response.
- PV, SP, and MV data is displayed simultaneously in a 3-row, negative LCD display with a backlight.
- Bar graph to show MV (manipulated variable), valve opening, or deviation.
- Multiloop control, cascade control, and proportional control are possible with a single Controller.
- When using models with communications functions, initial settings can be downloaded and settings can be masked using Support Software (Thermo Tools).
- Equipped with calculation functions as a standard (e.g., square root calculation and broken-line approximation).
- DeviceNet Communications
Data setting and monitoring can be performed without special programming.



Model Number Structure

■ Model Number Legend

E5AR-□□□□□□□□□□-□□□□
1 2 3 4 5 6 7 8 9 10

1. Constant values/Program

None: Constant value

2. Control method

Blank: Standard or heating/cooling control

P: Position proportional control

3. Output 1

R: DPST-NO relay outputs

Q: Pulse voltage and pulse voltage/current outputs

C: Current and current outputs

4. Output 2

Blank: None

R: Relay outputs

Q: Pulse voltage and pulse voltage/current outputs

C: Current and current outputs

5. Auxiliary Outputs

Blank: None

4: 4PST-NO relay outputs

T: 2 transistor outputs

6. Optional Function 1

Blank: None

3: RS-485 communications

7. Optional Function 2

Blank: None

D: 4 event inputs

8. Input 1

B: Multi-input and 2 event inputs

F: Multi-input and FB (Potentiometer input)

W: Multi-input and multi-input

9. Input 2

Blank: None

W: Multi-input and multi-input

10. Communications Method

Blank: None

FLK: RS-485 (CompoWay F/MODBUS)

DRT: DeviceNet

Ordering Information

■ Digital Controllers

Standard Controllers

Size	Control type	Control mode	Outputs (control/transfer)	Optional functions			Model	
				Auxiliary outputs (SUB)	Event inputs	Serial communications		
96 × 96 mm	Basic control (1 loop)	Single-loop standard control Single-loop heating and cooling control	2 points: Pulse voltage and Pulse voltage/current	4	2	No	E5AR-Q4B	
			2 points: Current and Current				E5AR-C4B	
			2 points: Pulse voltage and Pulse voltage/current				RS-485	E5AR-Q43B-FLK (See note 2.)
			2 points: Current and Current					E5AR-C43B-FLK (See note 2.)
			2 points: Pulse voltage and Pulse voltage/current				6	E5AR-Q43DB-FLK (See note 2.)
			2 points: Current and Current					E5AR-C43DB-FLK (See note 2.)
			4 points: Pulse voltage and Pulse voltage/current and Current (2 points)					E5AR-QC43DB-FLK
	2-loop control	2-loop standard control Single-loop heating and cooling control Single-loop cascade control Single-loop control with remote SP Single-loop proportional control	2 points: Pulse voltage and Pulse voltage/current	4	4	RS-485	E5AR-Q43DW-FLK (See note 2.)	
			2 points: Current and Current				E5AR-C43DW-FLK (See note 2.)	
			4 points: Pulse voltage (2 points) and Pulse voltage/current (2 points)				E5AR-QQ43DW-FLK	
	4-loop control	4-loop standard control 2-loop heating and cooling control	4 points: Current output (4 points)	4	4	RS-485	E5AR-CC43DWW-FLK	
			4 points: Pulse voltage (2 points) and Pulse voltage/current (2 points)				E5AR-QQ43DWW-FLK (See note 2.)	
Position-proportional control (1 loop)	Single-loop position-proportional control	Relay output (1 open, 1 close)	4	4	No	E5AR-PR4DF		
		Relay output (1 open, 1 close) and 1 current (transfer) output				RS-485	E5AR-PRQ43DF-FLK	

Note 1: Specify the power supply specifications when ordering. Model numbers for 100 to 240 VAC are different from those for 24 VAC/VDC.

2: These models are for 100 to 240 VAC only.

DeviceNet-compatible Controllers

Size	Control type	Control mode	Outputs (control/transfer)	Optional functions			Model
				Auxiliary outputs (SUB)	Event inputs	DeviceNet communications	
96 × 96 mm	Basic control (1 loop)	1 loop for standard control Single-loop heating and cooling control	2 points: Pulse voltage and Pulse voltage/current	4	2	Yes	E5AR-Q4B-DRT
			2 points: Current and Current				E5AR-C4B-DRT
			4 points: Pulse voltage and Pulse voltage/current and Current (2 points)				E5AR-QC4B-DRT
	2-loop control	2-loop standard control 2-loop heating and cooling control Single-loop cascade control Single-loop control with remote SP Single-loop proportional control	4 points: Pulse voltage (2 points) and Pulse voltage/current (2 points)	4	None	Yes	E5AR-QQ4W-DRT
	4-loop control	4-loop standard control 2-loop heating and cooling control	4 points: Current (4 points)	4	None	Yes	E5AR-CC4WW-DRT
	Position-proportional control (1 loop)	Single-loop position-proportional control	Relay output (1 open, 1 close)	4	None	Yes	E5AR-PR4F-DRT
			Relay output (1 open, 1 close) and Current (transfer) output (1 point)				E5AR-PRQ4F-DRT

Note: Specify the power supply specifications when ordering. Model numbers for 100 to 240 VAC are different from those for 24 VAC/VDC.

Inspection Results

The Inspection Report can be ordered at the same time as the Digital Controller using the following model number.

Inspection Report (Sold Separately)

Descriptions	Model
Inspection Report for E5AR	E5AR-K

Terminal Cover (Sold Separately)

Descriptions	Model
Terminal Cover for E5AR	E53-COV14

Specifications

■ Ratings

Item	Supply voltage (See note 1.)	100 to 240 VAC, 50/60 Hz	24 VAC, 50/60 Hz; 24 VDC
Operating voltage range		85% to 110% of rated supply voltage	
Power consumption		22 VA max. (with maximum load)	15 VA/10 W max. (with maximum load)
Sensor input (See note 2.)		Thermocouple: K, J, T, E, L, U, N, R, S, B, W Platinum resistance thermometer: Pt100 Current input: 4 to 20 mA DC, 0 to 20 mA DC (including remote SP input) Voltage input: 1 to 5 VDC, 0 to 5 VDC, 0 to 10 VDC (including remote SP input) (Input impedance: 150 Ω for current input, approx. 1 MΩ for voltage input)	
Control output	Voltage (pulse) output	12 VDC, 40 mA max. with short-circuit protection circuit (E5AR-QQ□WW-□: 21 mA max.)	
	Current output	0 to 20 mA DC, 4 to 20 mA DC; load: 500 Ω max. (including transfer output) (Resolution: Approx. 54,000 for 0 to 20 mA DC; Approx. 43,000 for 4 to 20 mA DC)	
	Relay output	Position-proportional control type (open, closed) N.O., 250 VAC, 1 A (including inrush current)	
Auxiliary output		Relay Output N.O., 250 VAC, 1 A (resistive load) Transistor Output Maximum load voltage: 30 VDC; Maximum load current: 50 mA; Residual voltage: 1.5 V max.; Leakage current: 0.4 mA max.	
Potentiometer input		100 Ω to 2.5 kΩ	
Event input	Contact	Input ON: 1 kΩ max.; OFF: 100 kΩ min.	
	No-contact	Input ON: Residual voltage of 1.5 V max.; OFF: Leakage current of 0.1 mA max. Short-circuit: Approx. 4 mA	
Remote SP input		Refer to the information on sensor input.	
Transfer output		Refer to the information on control output.	
Control method		2-PID or ON/OFF control	
Setting method		Digital setting using front panel keys or setting using serial communications	
Indication method		7-segment digital display and single-lighting indicator Character Height No. 1 display: 12.8 mm; No. 2 display: 7.7 mm; No. 3 display: 7.7 mm	
Other functions		Depends on model.	
Ambient operating temperature		-10 to 55°C (with no icing or condensation) For 3 years of assured use: -10 to 50°C (with no icing or condensation)	
Ambient operating humidity		25% to 85%	
Storage temperature		-25 to 65°C (with no icing or condensation)	

Note 1: The supply voltage (i.e., 100 to 240 VAC or 24 VAC/VDC) depends on the model. Be sure to specify the required type when ordering.

Note 2: The Controller is equipped with multiple sensor input. Temperature input or analog input can be selected with the input type setting switch. There is basic insulation between power supply and input terminals, power supply and output terminals, and input and output terminals.

Input Ranges

The E5AR has multi-inputs. The default setting is 2 (K-type thermocouple, -200.0 to 1300.0°C or -300.0 to 2300.0°F).

Platinum Resistance Thermometer Input

Input		Pt100	
Range	°C	-200.0 to 850.0	-150.00 to 150.00
	°F	-300.0 to 1500.0	-199.99 to 300.00
Setting		0	1
Minimum setting unit (SP and alarm)		0.1	0.01
Input type setting switch		Set to TC.PT. 	

Thermocouple Input

Input		K		J		T	E	L	U	N	R	S	B	W
Range	°C	-200.0 to 1300.0	-20.0 to 500.0	-100.0 to 850.0	-20.0 to 400.0	-200.0 to 400.0	0.0 to 600.0	-100.0 to 850.0	-200.0 to 400.0	-200.0 to 1300.0	0.0 to 1700.0	0.0 to 1700.0	100.0 to 1800.0	0.0 to 2300.0
	°F	-300.0 to 2300.0	0.0 to 900.0	-100.0 to 1500.0	0.0 to 750.0	-300.0 to 700.0	0.0 to 1100.0	-100.0 to 1500.0	-300.0 to 700.0	-300.0 to 2300.0	0.0 to 3000.0	0.0 to 3000.0	300.0 to 3200.0	0.0 to 4100.0
Setting		2	3	4	5	6	7	8	9	10	11	12	13	14
Minimum setting unit (SP and alarm)		0.1												
Input type setting switch		Set to TC.PT. 												

Current/Voltage Input

Input	Current		Voltage		
	4 to 20 mA	0 to 20 mA	1 to 5 V	0 to 5 V	0 to 10 V
Range	Depending on the scaling settings, one of the following ranges will be displayed. -19999 to 99999 -1999.9 to 9999.9 -199.99 to 999.99 -19.999 to 99.999 -1.9999 to 9.9999				
Setting	15	16	17	18	19
Input type setting switch	Set to ANALOG. 				

■ Characteristics

Indication accuracy	Thermocouple input with cold junction compensation: ($\pm 0.1\%$ of PV or $\pm 1^\circ\text{C}$, whichever is greater) ± 1 digit max. (See note 1.) Thermocouple input without cold junction compensation: ($\pm 0.1\%$ FS or $\pm 1^\circ\text{C}$, whichever is smaller) ± 1 digit (See note 2.) Analog input: $\pm 0.1\%$ FS ± 1 digit max. Platinum resistance thermometer input: ($\pm 0.1\%$ of PV or $\pm 0.5^\circ\text{C}$, whichever is greater) ± 1 digit max. Position-proportional potentiometer input: $\pm 5\%$ FS ± 1 digit max.
Control mode	Standard control (heating or cooling control), heating/cooling control, standard control with remote SP (2-input models only), heating/cooling control with remote SP (2-input models only), cascade standard control (2-input models only), cascade heating/cooling control (2-input models only), proportional control (2-input models only), position-proportional control (control-valve control models only)
Control period	0.2 to 99.0 s (in units of 0.1 s) for time-proportioning control output
Proportional band (P)	0.00% to 999.99% FS (in units of 0.01% FS)
Integral time (I)	0.0 to 3,999.9 s (in units of 0.1 s)
Derivative time (D)	0.0 to 3,999.9 s (in units of 0.1 s)
Hysteresis	0.01% to 99.99% FS (in units of 0.01% FS)
Manual reset value	0.0% to 100.0% (in units of 0.1% FS)
Alarm setting range	-19,999 to 99,999 EU (See note 3.) (The decimal point position depends on the input type and the decimal point position setting.)
Input sampling period	50 ms
Insulation resistance	20 M Ω min. (at 500 VDC)
Dielectric strength	2,000 VAC, 50/60 Hz for 1 min (between charged terminals of different polarities)
Vibration resistance	10 to 55 Hz, 20 m/s ² for 10 min each in X, Y, and Z directions
Shock resistance	100 m/s ² , 3 times each in X, Y, and Z directions
Inrush current	100 to 240-VAC models: 50 A max. 24 VAC/VDC models: 30 A max.
Weight	E5AR: Controller only: Approx. 450 g; Mounting bracket: Approx. 60 g; Terminal cover: Approx. 30 g E5ER: Controller only: Approx. 330 g; Mounting bracket: Approx. 60 g; Terminal cover: Approx. 16 g
Degree of protection	Front panel: NEMA4X for indoor use (equivalent to IP66); Rear case: IP20; Terminals: IP00
Memory protection	Non-volatile memory (number of writes: 100,000)
Applicable standards	UL3121-1, CSA C22.2 No. 1010-1 EN61010-1 (IEC61010-1): Pollution degree 2/overvoltage category 2
EMC	EMI: EN61326 Radiated Interference Electromagnetic Field Strength: EN55011 Group 1 Class A Noise Terminal Voltage: EN55011 Group 1 Class A EMS: EN61326 ESD Immunity: EN61000-4-2: 4 kV contact discharge (level 2) 8 kV air discharge (level 3) Electromagnetic Immunity: EN61000-4-3: 10 V/m (amplitude-modulated, 80 MHz to 1 GHz, 1.4 GHz to 2 GHz) (level 3) Burst Noise Immunity: EN61000-4-4: 2 kV power line (level 3) 2 kV output line (relay output) (level 4) 1 kV measurement line, I/O signal line (level 4) 1 kV communications line (level 3) Conducted Disturbance Immunity: EN61000-4-6: 3 V (0.15 to 80 MHz) (level 3) Surge Immunity: EN61000-4-5: 1 kV line to line (power line, output line (relay output)) (level 2) 2 kV line to ground (power line, output line (relay output)) (level 3) Power Frequency Magnetic Field Immunity: EN61000-4-8: 30 A/m (50 Hz) continuous field Voltage Dip/Interrupting Immunity: EN61000-4-11: 0.5 cycle, 100% (rated voltage)

- Note 1:** K-, T-, or N-type thermocouple at -100°C max.: $\pm 2^\circ\text{C} \pm 1$ digit max.
U- or L-type thermocouple: $\pm 2^\circ\text{C} \pm 1$ digit max.
B-type thermocouple at 400°C max.: No accuracy specification.
R- or S-type thermocouple at 200°C max.: $\pm 3^\circ\text{C} \pm 1$ digit max.
W-type thermocouple: ($\pm 0.3\%$ of PV or $\pm 3^\circ\text{C}$, whichever is greater) ± 1 digit max.
- 2:** U- or L-type thermocouple: $\pm 1^\circ\text{C} \pm 1$ digit
R- or S-type thermocouple at 200°C max.: $\pm 1.5^\circ\text{C} \pm 1$ digit
- 3:** "EU" (Engineering Unit) represents the unit after scaling. If a temperature sensor is used it is either $^\circ\text{C}$ or $^\circ\text{F}$.

■ Communications Specifications

RS-485 Serial Communications

Transmission path connection	Multiple points
Communications method	RS-485 (two-wire, half duplex)
Synchronization method	Start-stop synchronization
Baud rate	9,600, 19,200, or 384,000 bps
Transmission code	ASCII (CompoWay/F), RTU Remote Terminal Unit (MODBUS)
Data bit length	7 or 8 bits
Stop bit length	1 or 2 bits
Error detection	Vertical parity (none, even, odd) Block check character (BCC) Start-stop synchronization data format
Flow control	None
Interface	RS-485
Retry function	None

DeviceNet

Item		Specifications			
Communications protocol		Conforms to DeviceNet			
Communications functions	Remote I/O communications	<ul style="list-style-type: none"> • Master-slave connections (polling, bit-strobe, COS, or cyclic) • Conform to DeviceNet specifications. 			
	I/O allocations	<ul style="list-style-type: none"> • Can allocate any I/O data from the Configurator. • Can allocate any data, such as parameters specific to the DeviceNet and the Digital Controller variable area. • Up to 2 blocks for the IN Area, up to a total of 100 words. • One block for the OUT Area, up to 100 words (first word is always allocated to Output Enable Bits). 			
	Message communications	<ul style="list-style-type: none"> • Explicit message communications • CompoWay/F communications commands can be sent (commands are sent in explicit message format). 			
Connection format		Combination of multidrop and T-branch connections (for trunk and drop lines)			
Baud rate		DeviceNet: 500, 250, or 125 kbps, or automatic detection of master baud rate			
Communications media		Special 5-wire cable (2 signal lines, 2 power lines, and 1 shield line)			
Communications distance	Baud rate	Network length	Drop line length	Total drop line length	
	500 kbps	100 m max. (100 m max.)	6 m max.	39 m max.	
	250 kbps	250 m max. (100 m max.)	6 m max.	78 m max.	
	125 kbps	500 m max. (100 m max.)	6 m max.	156 m max.	
	The values in parentheses apply when Thin Cables are used.				
Supply voltage		DeviceNet power supply: 24 VDC			
Allowable voltage range		DeviceNet power supply: 11 to 25 VDC			
Current consumption		50 mA max. (24 VDC)			
Maximum number of nodes that can be connected		64 (includes Configurator when used)			
Maximum number of slaves that can be connected		63			
Error control		CRC error detection			
Power supply		Power supplied from DeviceNet communications connector.			

Wiring Terminals

■ E5AR Standard Controller Connections

E5AR-Q4B

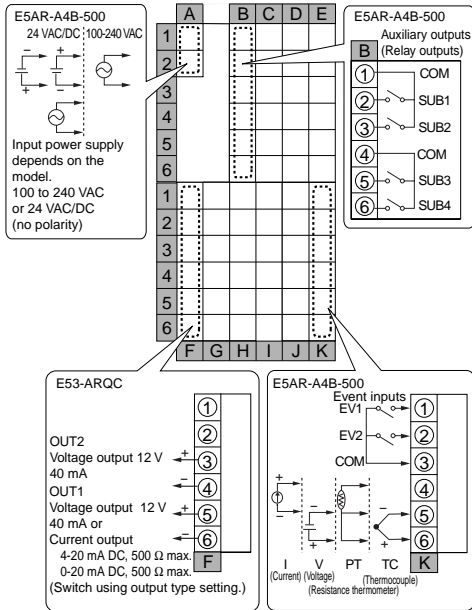

E5AR-C4B

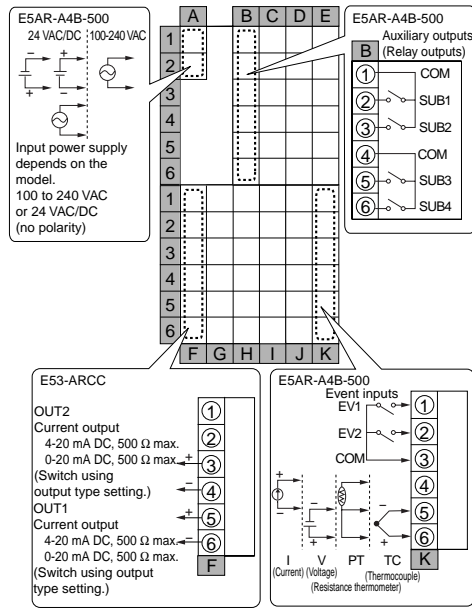

E5AR-Q43B-FLK

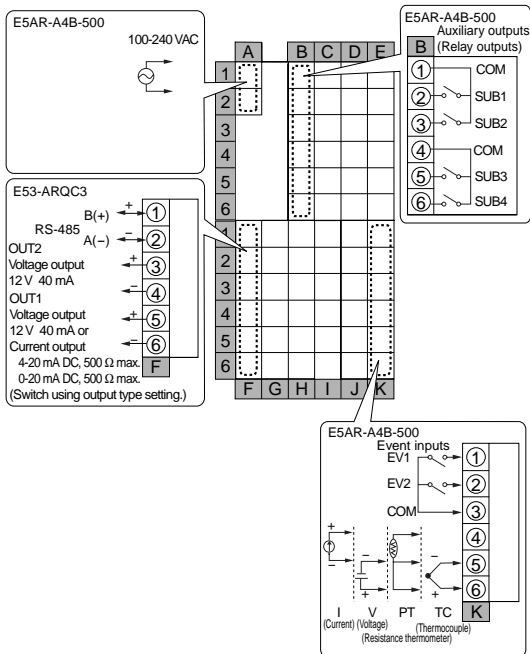

E5AR-C43B-FLK

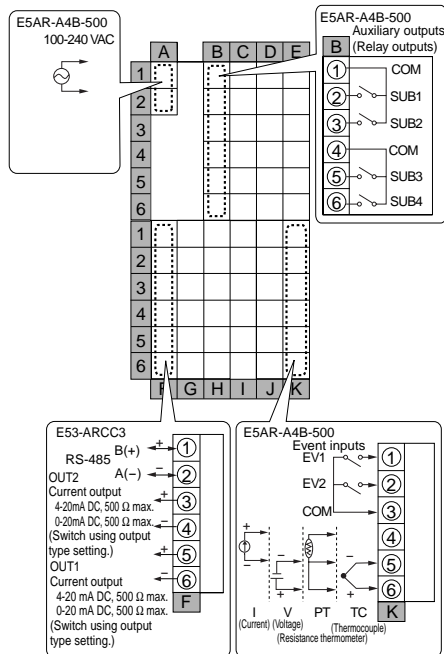

E5AR-Q43DB-FLK

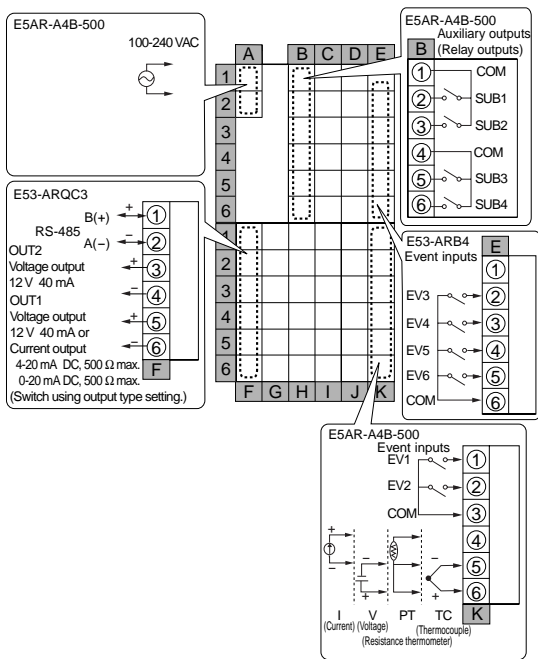

E5AR-C43DB-FLK

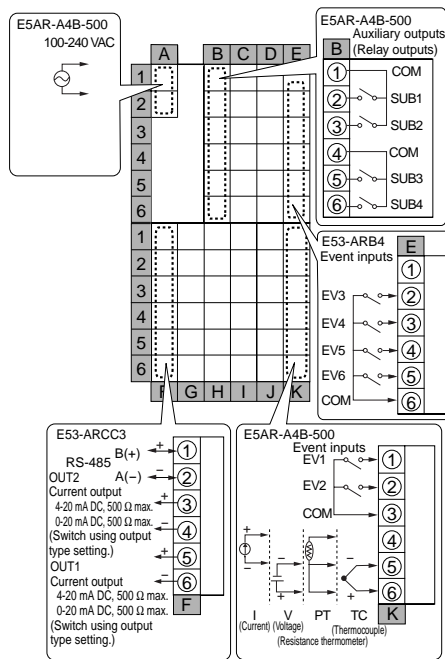

E5AR-QC43DB-FLK

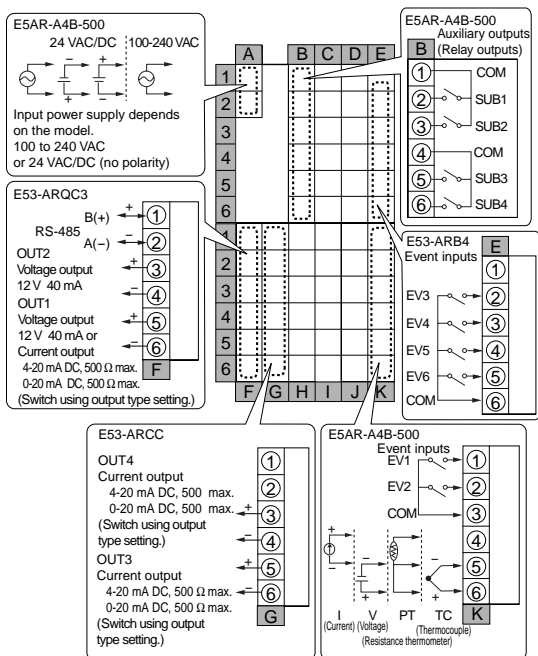

E5AR-Q43DW-FLK (2-loop Control)

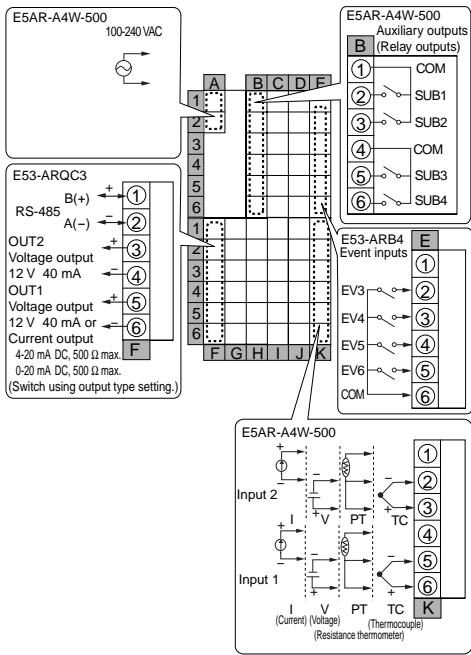

E5AR-C43DW-FLK (2-loop Control)

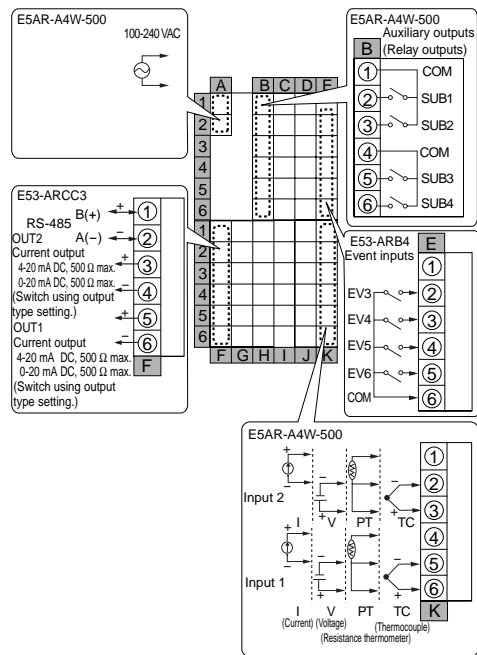

E5AR-QQ43DW-FLK (2-loop Control)

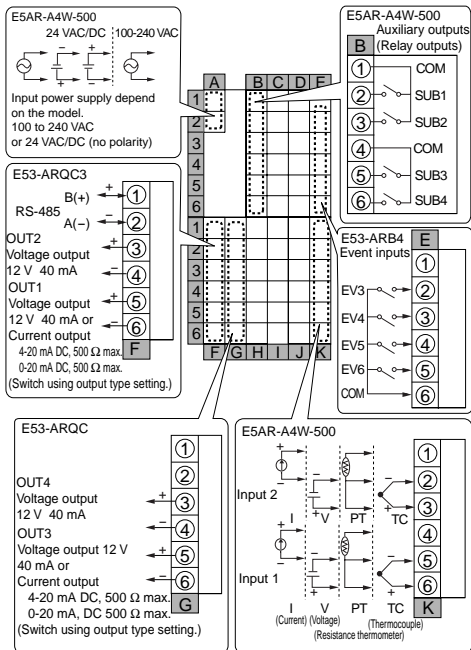

E5AR-CC43DWW-FLK (4-loop Control)

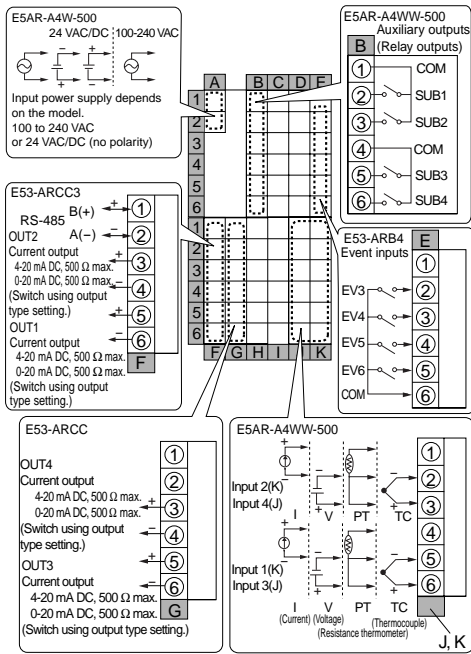

E5AR-QQ43DWW-FLK (4-loop Control)

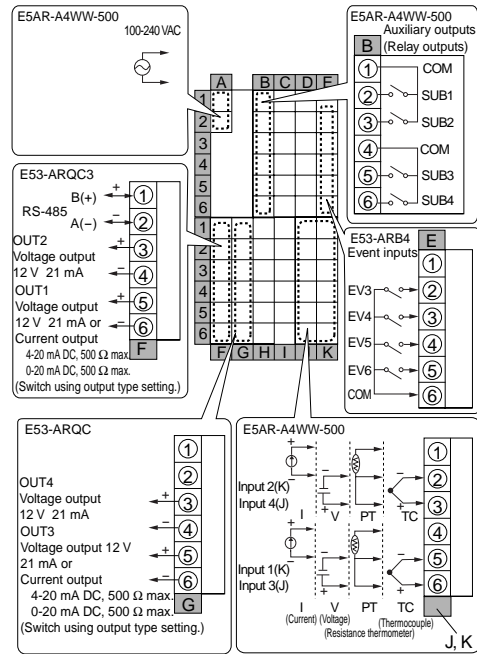

E5AR-PR4DF

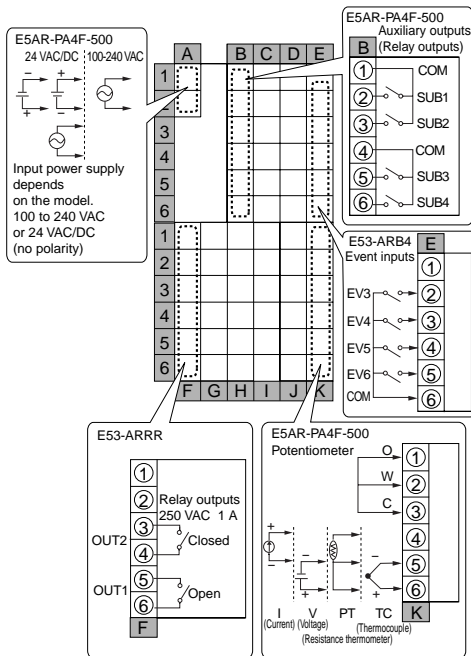

E5AR-PRQ43DF-FLK

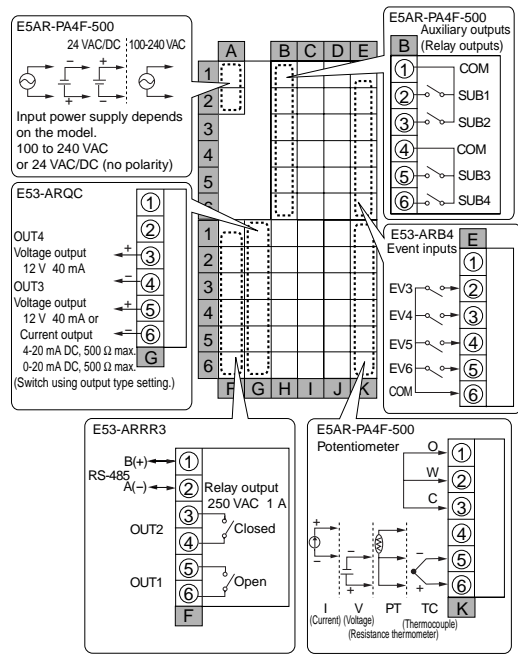

E5AR DeviceNet-compatible Controller Connections

E5AR-Q4B-DRT

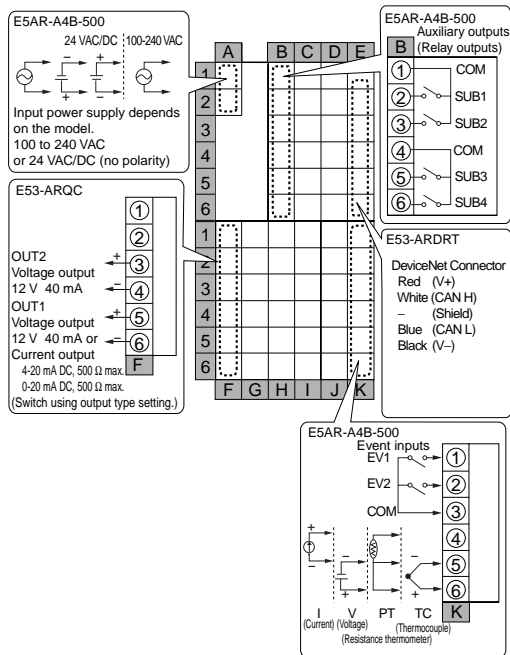

E5AR-C4B-DRT

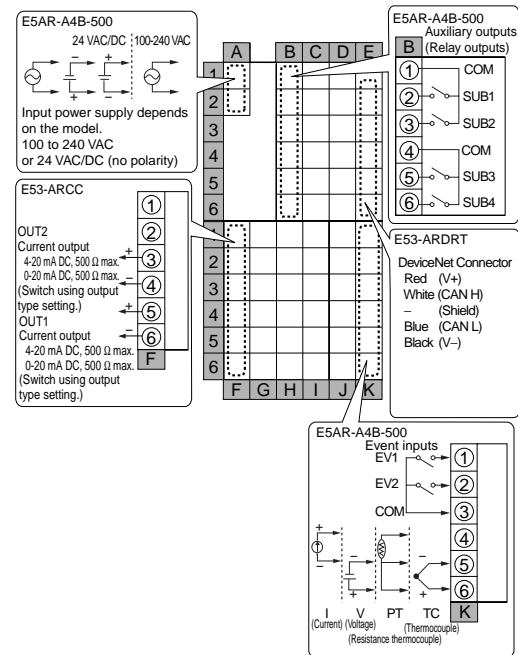

E5AR-QC4B-DRT

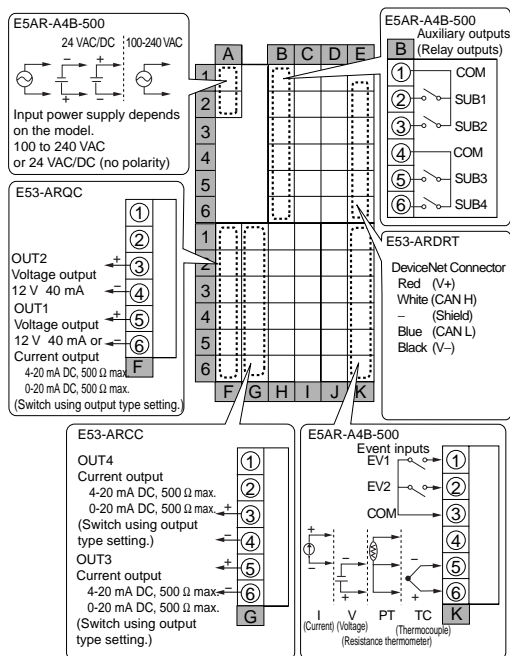

E5AR-QQ4W-DRT (2-loop Control)

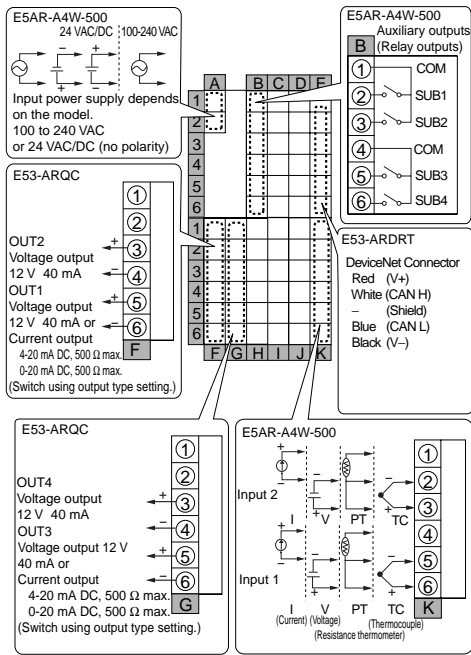

E5AR-CC4WW-DRT (4-loop Control)

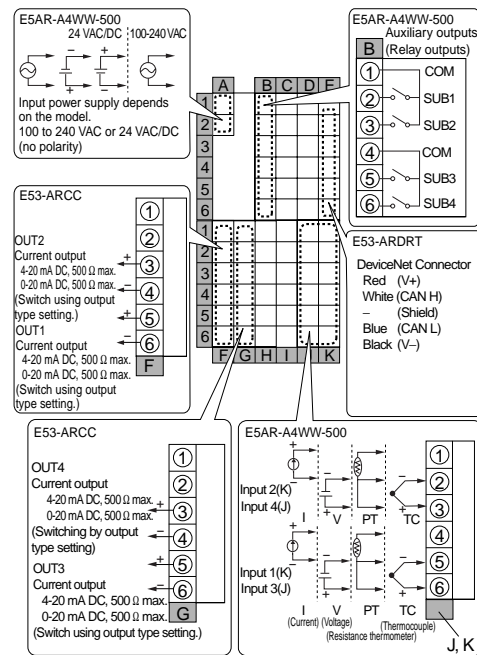

E5AR-PR4F-DRT

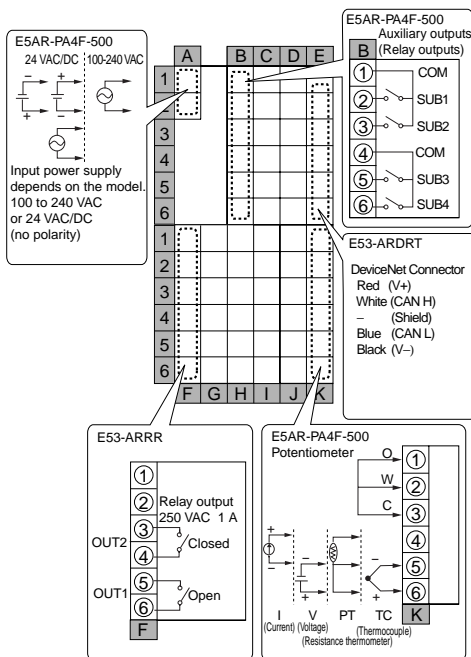

E5AR-PRQ4F-DRT

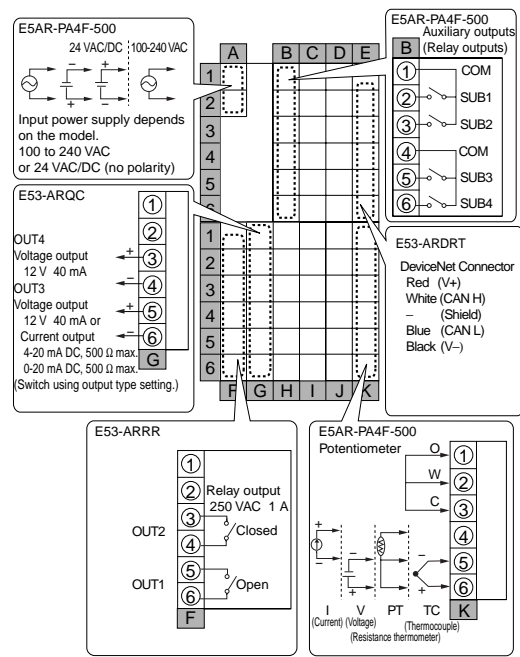

Dimensions

Note: All units are in millimeters unless otherwise indicated.

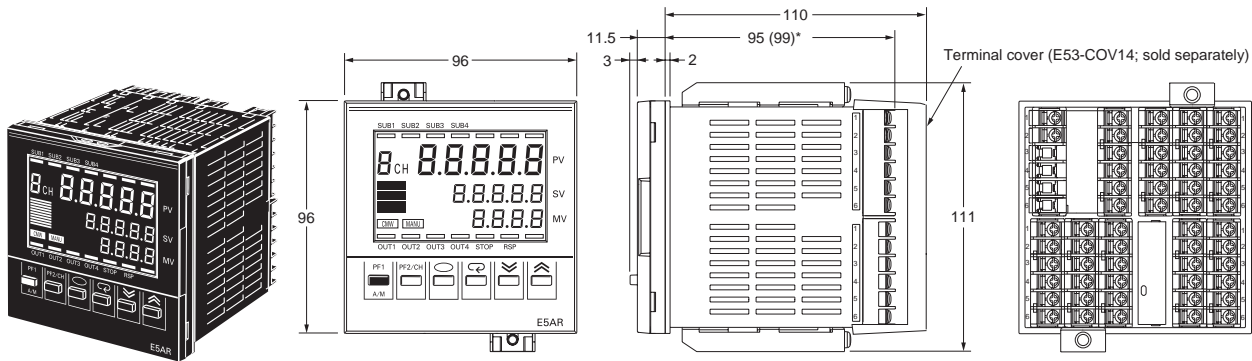

Panel Cutouts

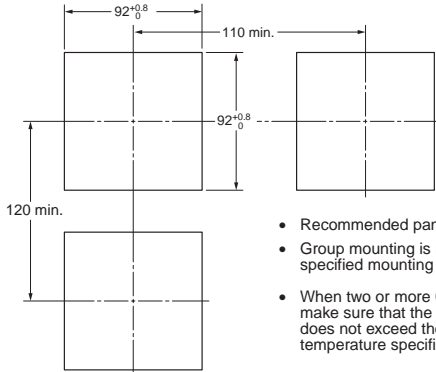

* The value in parentheses is for DeviceNet-compatible Controllers.

DeviceNet-compatible Controllers, Rear Panel

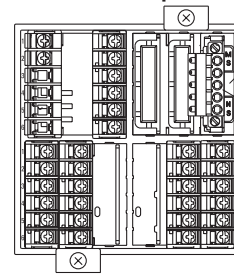

MS/NS indicators
Top: MS
Bottom: NS

DeviceNet communications connector
Used to connect the DeviceNet communications cables. The DeviceNet communications power is also supplied through this connector. The connector included with the DeviceNet-compatible Controllers is the FK2 2.5/5-STF-5.08 AU M (PHOENIX CONTACT).

Rubber Packing (Sold Separately)

Y92S-P4 (for E5AR)

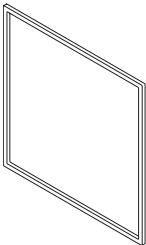

If the rubber packing is lost or damaged, it can be ordered using the following model number: Y92S-P4.

(Depending on the operating environment, deterioration, contraction, or hardening of the rubber packing may occur and so, in order to ensure the level of waterproofing specified in NEMA4, periodic replacement is recommended.)

Note: Rubber packing is provided with the Controller.

Unit Label Sheet (Sold Separately)

Y92S-L1

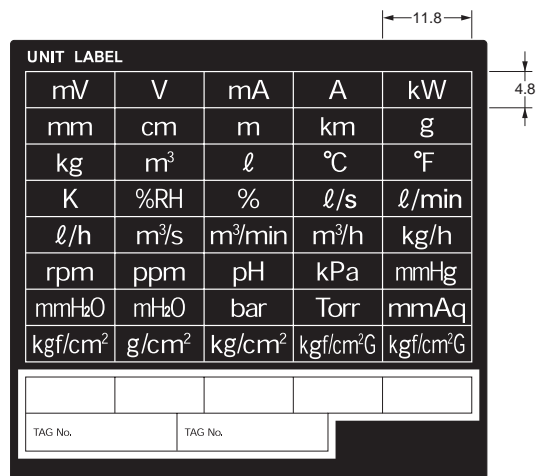

Terminal Cover (Sold Separately)

E53-COV14 (for E5AR)

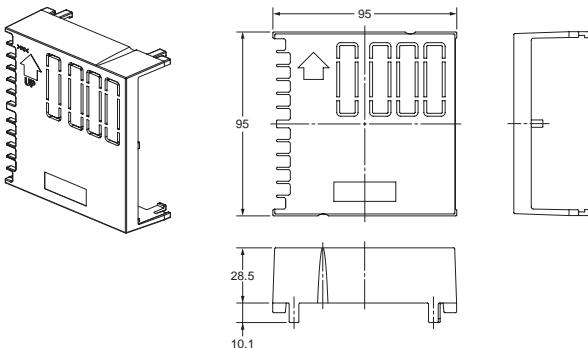

ALL DIMENSIONS SHOWN ARE IN MILLIMETERS.

To convert millimeters into inches, multiply by 0.03937. To convert grams into ounces, multiply by 0.03527.

Digital Controllers E5ER

E5ER Digital Controllers offer high speed, high precision, and multiple I/O and use a 5-digit, 3-row LCD display for high visual clarity.

- A short sampling period of 50 ms enables use in applications requiring high-speed response.
- PV, SP, and MV data is displayed simultaneously in a 3-row, negative LCD display with a backlight.
- Multipoint control, cascade control, and proportional control are possible with a single Controller.
- When using models with communications functions, initial settings can be downloaded and settings can be masked using Support Software (Thermo Tools).
- Equipped with calculation functions as a standard (e.g., square root calculation and broken-line approximation).
- DeviceNet Communications
Data setting and monitoring can be performed without any special programming.



Model Number Structure

■ Model Number Legend

E5ER-□□□□□□□□□□-□□□□
1 2 3 4 5 6 7 8 9 10

1. Constant values/Program

None: Constant values

2. Control method

Blank: Standard, or heating/cooling control

P: Position-proportional control

3. Output 1

R: DPST-NO relay outputs

Q: Pulse voltage and pulse voltage/current outputs

C: Current and current outputs

4. Output 2

Blank:None

R: Relay

Q: Pulse voltage and pulse voltage/current outputs

C: Current and current outputs

5. Auxiliary outputs

Blank:None

4: 4PST-NO relay outputs

T: 2 transistor outputs

6. Optional function 1

Blank:None

3: RS-485 communications

7. Optional function 2

Blank:None

D: 4 event inputs

8. Input 1

B: Multi-input and 2 event inputs

F: Multi-input and FB (Potentiometer input)

W: Multi-input and multi-input

9. Input 2

Blank:None

W: Multi-input and multi-input

10. Communications Method

Blank:None

FLK: RS-485 (CompoWay F/MODBUS)

DRT: DeviceNet

Ordering Information

■ Digital Controllers

Standard Controllers

Size	Control type	Control mode	Outputs (control/transfer)	Optional functions			Model
				Auxiliary outputs (SUB)	Event inputs	Serial communications	
48 × 96 mm	Basic control (1 loop)	Single-loop standard control Single-loop heating and cooling control	2 points: Pulse voltage and Pulse voltage/current	4	2	No	E5ER-Q4B
			2 points: Current and Current				E5ER-C4B
			2 points: Pulse voltage and Pulse voltage/current				RS-485
			2 points: Current and Current	E5ER-C43B-FLK (See note 2.)			
			2 points: Pulse voltage and Pulse voltage/current	2 (See note 3.)	6	E5ER-QT3DB-FLK (See note 2.)	
			2 points: Current and Current			E5EAR-CT3DB-FLK (See note 2.)	
			4 points: Pulse voltage and Pulse voltage/current and Current (2 points)	4	2	E5ER-QC43B-FLK	
2-loop control	2-loop standard control Single-loop heating and cooling control Single-loop cascade control Single-loop control with remote SP Single-loop proportional control	2 points: Pulse voltage and Pulse voltage/current	2 (See note 3.)	4	RS-485	E5ER-QT3DW-FLK	
		2 points: Current and Current				E5ER-CT3DW-FLK	
Position-proportional control (1 loop)	Single-loop position-proportional control	Relay output (1 open, 1 closed)	2 (See note 3.)	4	No	E5ER-PRTDF	
		Relay output (1 open, 1 closed) and Current (transfer) output (1 point)	4	No	RS-485	E5ER-PRQ43F-FLK	

Note 1: Specify the power supply specifications when ordering. Model numbers for 100 to 240 VAC are different from those for 24 VAC/VDC.

2: These models are for 100 to 240 VAC only.

3: The auxiliary outputs are transistor outputs.

DeviceNet-compatible Controllers

Size	Control type	Control mode	Outputs (control/transfer)	Optional functions			Model
				Auxiliary outputs (SUB)	Event inputs	DeviceNet communications	
48 × 96 mm	Basic control (1 loop)	Single-loop standard control Single-loop heating and cooling control	2 points: Pulse voltage Pulse voltage/current	2 (See note 2.)	2	Yes	E5ER-QTB-DRT
			2 points: Current Current				E5ER-CTB-DRT
	2-loop control	2-loop standard control Single-loop heating and cooling control Single-loop cascade control Single-loop standard control with remote SP Single-loop proportional control	2 points: Pulse voltage Pulse voltage/current	2 (See note 2.)	None	Yes	E5ER-QTW-DRT
			2 points: Current Current				E5ER-CTW-DRT
Position-proportional control (1 loop)	Single-loop position-proportional control	Relay output (1 open, 1 closed)	2 (See note 2.)	None	Yes	E5ER-PRTF-DRT	

Note 1: Specify the power supply specifications when ordering. Model numbers for 100 to 240 VAC are different from those for 24 VAC/VDC.

2: The auxiliary outputs are transistor outputs.

Inspection Results

The Inspection Report can be ordered at the same time as the Digital Controller using the following model number.

Inspection Report (Sold Separately)

Descriptions	Model
Inspection Report for E5ER	E5ER-K

Terminal Cover (Sold Separately)

Descriptions	Model
Terminal Cover for E5ER	E53-COV15

Specifications

■ Ratings

Item	Supply voltage (See note 1.)	100 to 240 VAC, 50/60 Hz	24 VAC, 50/60 Hz; 24 VDC
Operating voltage range		85% to 110% of rated supply voltage	
Power consumption		17 VA max. (with maximum load)	11 VA/7 W max. (with maximum load)
Sensor input (See note 2.)		Thermocouple: K, J, T, E, L, U, N, R, S, B, W Platinum resistance thermometer: Pt100 Current input: 4 to 20 mA DC, 0 to 20 mA DC (including remote SP input) Voltage input: 1 to 5 VDC, 0 to 5 VDC, 0 to 10 VDC (including remote SP input) (Input impedance: 150 Ω for current input, approx. 1 MΩ for voltage input)	
Control output	Voltage (pulse) output	12 VDC, 40 mA max. with short-circuit protection circuit (E5AR-QQ□WW-□: 21 mA max.)	
	Current output	0 to 20 mA DC, 4 to 20 mA DC; load: 500 Ω max. (including transfer output) (Resolution: Approx. 54,000 for 0 to 20 mA DC; Approx. 43,000 for 4 to 20 mA DC)	
	Relay output	Position-proportional control type (open, closed) N.O., 250 VAC, 1 A (including inrush current)	
Auxiliary output		<u>Relay Output</u> N.O., 250 VAC, 1 A (resistive load) <u>Transistor Output</u> Maximum load voltage: 30 VDC; Maximum load current: 50 mA; Residual voltage: 1.5 V max.; Leakage current: 0.4 mA max.	
Potentiometer input		100 Ω to 2.5 kΩ	
Event input	Contact	Input ON: 1 kΩ max.; OFF: 100 kΩ min.	
	No-contact	Input ON: Residual voltage of 1.5 V max.; OFF: Leakage current of 0.1 mA max.	
		Short-circuit: Approx. 4 mA	
Remote SP input		Refer to the information on sensor input.	
Transfer output		Refer to the information on control output.	
Control method		2-PID or ON/OFF control	
Setting method		Digital setting using front panel keys or setting using serial communications	
Indication method		7-segment digital display and single-lighting indicator Character Height No. 1 display: 9.5 mm; No. 2 display: 7.2 mm; No. 3 display: 7.2 mm	
Other functions		Depends on model.	
Ambient operating temperature		-10 to 55°C (with no icing or condensation) For 3 years of assured use: -10 to 50°C (with no icing or condensation)	
Ambient operating humidity		25% to 85%	
Storage temperature		-25 to 65°C (with no icing or condensation)	

Note 1: The supply voltage (i.e., 100 to 240 VAC or 24 VAC/VDC) depends on the model. Be sure to specify the required type when ordering.

2: The Controller is equipped with multiple sensor input. Temperature input or analog input can be selected with the input type setting switch. There is basic insulation between power supply and input terminals, power supply and output terminals, and input and output terminals.

Input Ranges

The E5ER has multi-inputs. The default setting is 2 (K-type thermocouple, -200.0 to 1300.0°C or -300.0 to 2300.0°F).

Platinum Resistance Thermometer Input

Input		Pt100	
Range	°C	-200.0 to 850.0	-150.0 to 150.0
	°F	-300.0 to 1500.0	-199.99 to 300.0
Setting		0	1
Minimum setting unit (SP and alarm)		0.1	0.01
Input type setting switch		Set to TC.PT. 	

Thermocouple Input

Input		K		J		T	E	L	U	N	R	S	B	W
Range	°C	-200.0 to 1300.0	-20.0 to 500.0	-100.0 to 850.0	-20.0 to 400.0	-200.0 to 400.0	0.0 to 600.0	-100.0 to 850.0	-200.0 to 400.0	-200.0 to 1300.0	0.0 to 1700.0	0.0 to 1700.0	100.0 to 1800.0	0.0 to 2300.0
	°F	-300.0 to 2300.0	0.0 to 900.0	-100.0 to 1500.0	0.0 to 750.0	-300.0 to 700.0	0.0 to 1100.0	-100.0 to 1500.0	-300.0 to 700.0	-300.0 to 2300.0	0.0 to 3000.0	0.0 to 3000.0	300.0 to 3200.0	0.0 to 4100.0
Setting		2	3	4	5	6	7	8	9	10	11	12	13	14
Minimum setting unit (SP and alarm)		0.1												
Input type setting switch		Set to TC.PT. 												

Current/Voltage Input

Input	Current			Voltage		
Range	4 to 20 mA	0 to 20 mA		1 to 5 V	0 to 5 V	0 to 10 V
Setting	15	16		17	18	19
Input type setting switch	Set to ANALOG. 					

■ Characteristics

Indication accuracy	Thermocouple input with cold junction compensation: ($\pm 0.1\%$ of PV or $\pm 1^\circ\text{C}$, whichever is greater) ± 1 digit max. (See note 1.) Thermocouple input without cold junction compensation: ($\pm 0.1\%$ FS or $\pm 1^\circ\text{C}$, whichever is smaller) ± 1 digit (See note 2.) Analog input: $\pm 0.1\%$ FS ± 1 digit max. Platinum resistance thermometer input: ($\pm 0.1\%$ of PV or $\pm 0.5^\circ\text{C}$, whichever is greater) ± 1 digit max. Position-proportional potentiometer input: $\pm 5\%$ FS ± 1 digit max.
Control mode	Standard control (heating or cooling control), heating/cooling control, standard control with remote SP (2-input models only), heating/cooling control with remote SP (2-input models only), cascade standard control (2-input models only), cascade heating/cooling control (2-input models only), proportional control (2-input models only), position-proportional control (control-valve control models only)
Control period	0.2 to 99.0 s (in units of 0.1 s) for time-proportioning control output
Proportional band (P)	0.00% to 999.99% FS (in units of 0.01% FS)
Integral time (I)	0.0 to 3,999.9 s (in units of 0.1 s)
Derivative time (D)	0.0 to 3,999.9 s (in units of 0.1 s)
Hysteresis	0.01% to 99.99% FS (in units of 0.01% FS)
Manual reset value	0.0% to 100.0% (in units of 0.1% FS)
Alarm setting range	-19,999 to 99,999 EU (See note 3.) (The decimal point position depends on the input type and the decimal point position setting.)
Input sampling period	50 ms
Insulation resistance	20 M Ω min. (at 500 VDC)
Dielectric strength	2,000 VAC, 50/60 Hz for 1 min (between charged terminals of different polarities)
Vibration resistance	10 to 55 Hz, 20 m/s ² for 10 min each in X, Y, and Z directions
Shock resistance	100 m/s ² , 3 times each in X, Y, and Z directions
Inrush current	100 to 240-VAC models: 50 A max. 24 VAC/VDC models: 30 A max.
Weight	E5AR: Controller only: Approx. 450 g; Mounting bracket: Approx. 60 g; Terminal cover: Approx. 30 g E5ER: Controller only: Approx. 330 g; Mounting bracket: Approx. 60 g; Terminal cover: Approx. 16 g
Degree of protection	Front panel: NEMA4X for indoor use (equivalent to IP66); Rear case: IP20; Terminals: IP00
Memory protection	Non-volatile memory (number of writes: 100,000)
Applicable standards	UL3121-1, CSA C22.2 No. 1010-1 EN61010-1 (IEC61010-1): Pollution degree 2/overvoltage category 2
EMC	EMI: EN61326 Radiated Interference Electromagnetic Field Strength: EN55011 Group 1 Class A Noise Terminal Voltage: EN55011 Group 1 Class A EMS: EN61326 ESD Immunity: EN61000-4-2: 4 kV contact discharge (level 2) 8 kV air discharge (level 3) Electromagnetic Immunity: EN61000-4-3: 10 V/m (amplitude-modulated, 80 MHz to 1 GHz, 1.4 GHz to 2 GHz) (level 3) Burst Noise Immunity: EN61000-4-4: 2 kV power line (level 3) 2 kV output line (relay output) (level 4) 1 kV measurement line, I/O signal line (level 4) 1 kV communications line (level 3) Conducted Disturbance Immunity: EN61000-4-6: 3 V (0.15 to 80 MHz) (level 3) Surge Immunity: EN61000-4-5: 1 kV line to line (power line, output line (relay output)) (level 2) 2 kV line to ground (power line, output line (relay output)) (level 3) Power Frequency Magnetic Field Immunity: EN61000-4-8: 30 A/m (50 Hz) continuous field Voltage Dip/Interrupting Immunity: EN61000-4-11: 0.5 cycle, 100% (rated voltage)

- Note 1:** K-, T-, or N-type thermocouple at -100°C max.: $\pm 2^\circ\text{C}$ ± 1 digit max.
U- or L-type thermocouple: $\pm 2^\circ\text{C}$ ± 1 digit max.
B-type thermocouple at 400°C max.: No accuracy specification.
R- or S-type thermocouple at 200°C max.: $\pm 3^\circ\text{C}$ ± 1 digit max.
W-type thermocouple: ($\pm 0.3\%$ of PV or $\pm 3^\circ\text{C}$, whichever is greater) ± 1 digit max.
- 2:** U- or L-type thermocouple: $\pm 1^\circ\text{C}$ ± 1 digit
R- or S-type thermocouple at 200°C max.: $\pm 1.5^\circ\text{C}$ ± 1 digit
- 3:** "EU" (Engineering Unit) represents the unit after scaling. If a temperature sensor is used it is either $^\circ\text{C}$ or $^\circ\text{F}$.

■ Communications Specifications

RS-485 Serial Communications

Transmission path connection	Multiple points
Communications method	RS-485 (two-wire, half duplex)
Synchronization method	Start-stop synchronization
Baud rate	9,600, 19,200, or 384,000 bps
Transmission code	ASCII (CompoWay/F), RTU Remote Terminal Unit (MODBUS)
Data bit length	7 or 8 bits
Stop bit length	1 or 2 bits
Error detection	Vertical parity (none, even, odd) Block check character (BCC) Start-stop synchronization data format
Flow control	None
Interface	RS-485
Retry function	None

DeviceNet

Item		Specifications			
Communications protocol		Conforms to DeviceNet			
Communications functions	Remote I/O communications	<ul style="list-style-type: none"> • Master-slave connections (polling, bit-strobe, COS, or cyclic) • Conform to DeviceNet specifications. 			
	I/O allocations	<ul style="list-style-type: none"> • Can allocate any I/O data from the Configurator. • Can allocate any data, such as parameters specific to the DeviceNet, and the Digital Controller variable area. • Up to 2 blocks for the IN Area, up to a total of 100 words. • One block for the OUT Area, up to 100 words (first word is always allocated to Output Enable Bits). 			
	Message communications	<ul style="list-style-type: none"> • Explicit message communications • CompoWay/F communications commands can be sent (commands are sent in explicit message format). 			
Connection format		Combination of multidrop and T-branch connections (for trunk and drop lines)			
Baud rate		DeviceNet: 500, 250, or 125 kbps, or automatic detection of master baud rate			
Communications media		Special 5-wire cable (2 signal lines, 2 power lines, and 1 shield line)			
Communications distance	Baud rate	Network length	Drop line length	Total drop line length	
	500 kbps	100 m max. (100 m max.)	6 m max.	39 m max.	
	250 kbps	250 m max. (100 m max.)	6 m max.	78 m max.	
	125 kbps	500 m max. (100 m max.)	6 m max.	156 m max.	
The values in parentheses apply when Thin Cables are used.					
Supply voltage		DeviceNet power supply: 24 VDC			
Allowable voltage range		DeviceNet power supply: 11 to 25 VDC			
Current consumption		50 mA max. (24 VDC)			
Maximum number of nodes that can be connected		64 (includes Configurator when used)			
Maximum number of slaves that can be connected		63			
Error control		CRC error detection			
Power supply		Power supplied from DeviceNet communications connector.			

Wiring Terminals

E5ER Standard Controller Connections

E5ER-Q4B

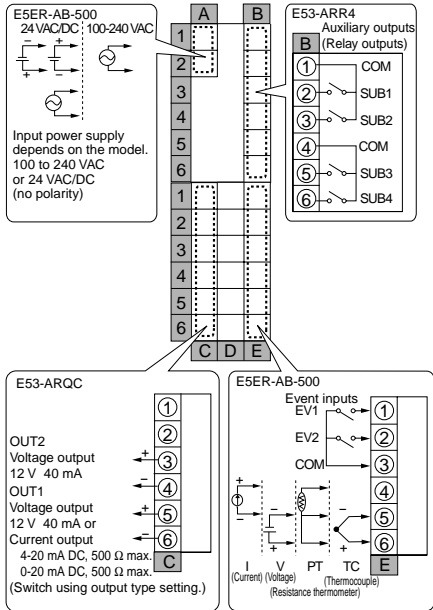

E5ER-C4B

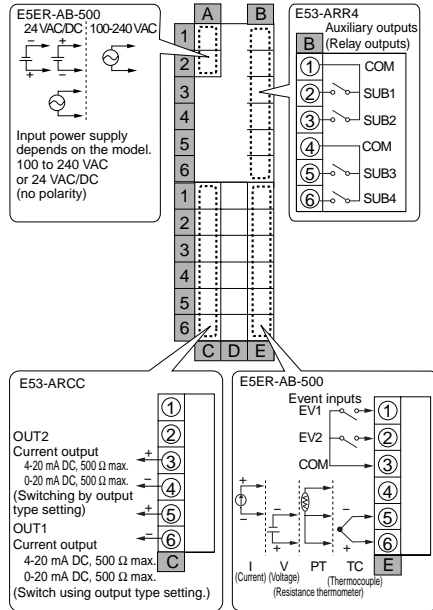

E5ER-Q43B-FLK

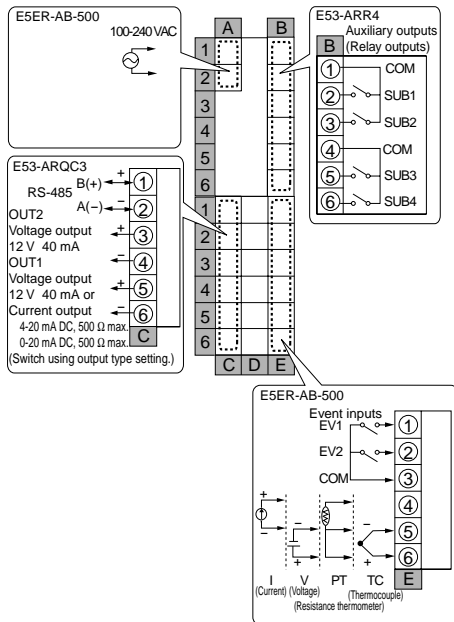

E5ER-C43B-FLK

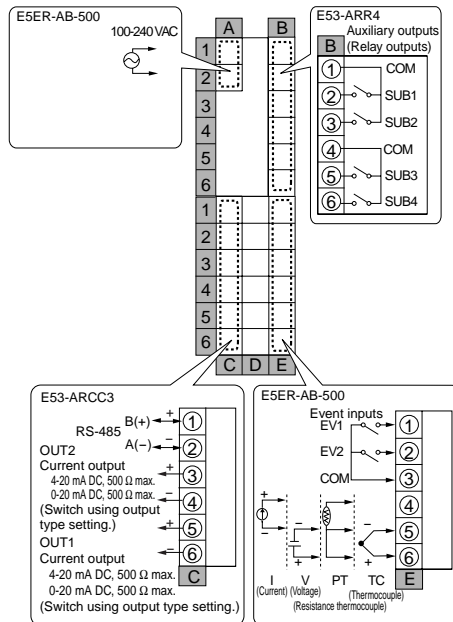

E5ER-QT3DB-FLK

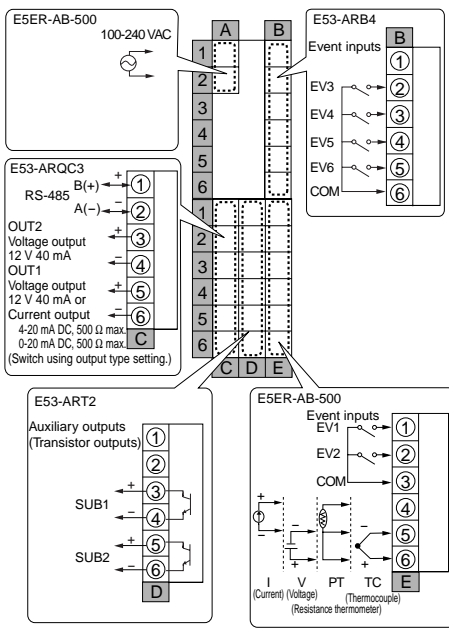

E5ER-CT3DB-FLK

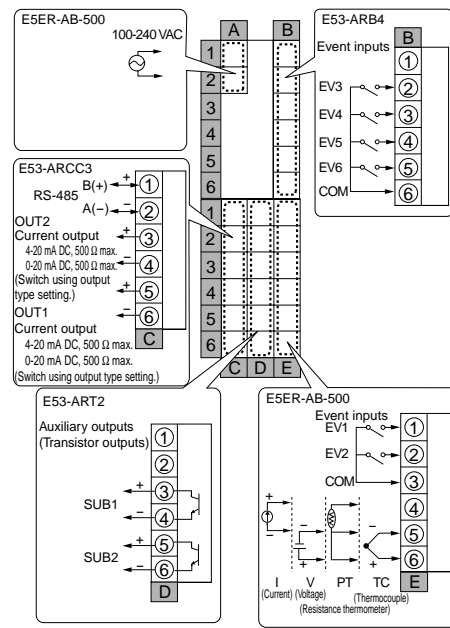

E5ER-QC43B-FLK

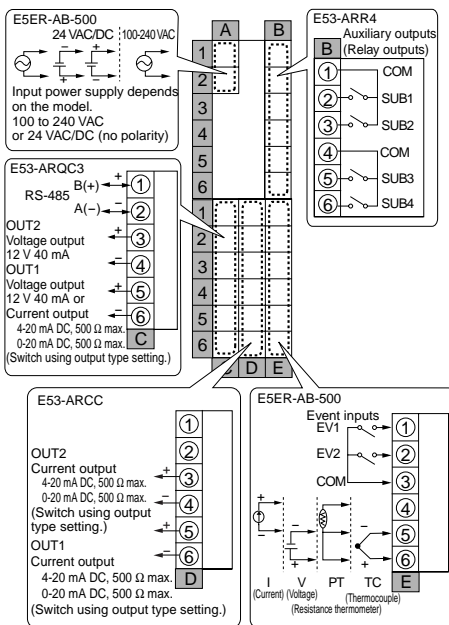

E5ER-QT3DW-FLK (2-loop Control)

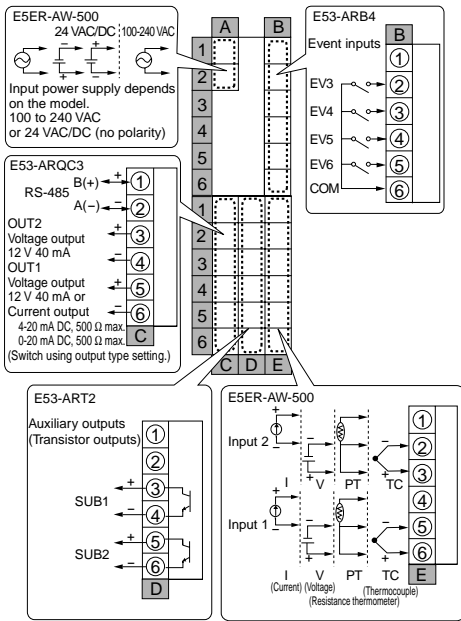

E5ER-CT3DW-FLK (2-loop Control)

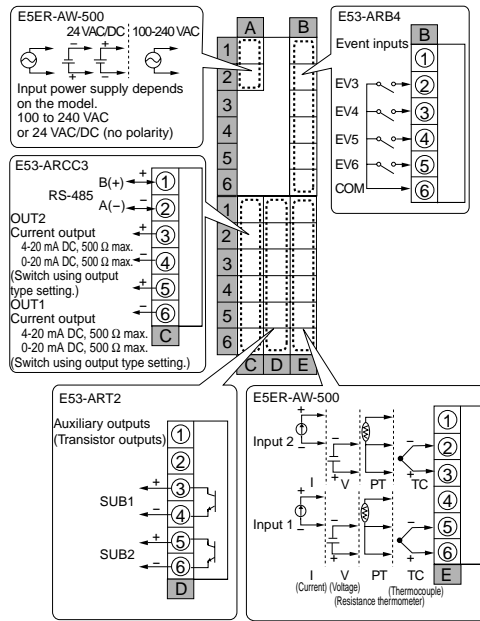

E5ER-PRTDF

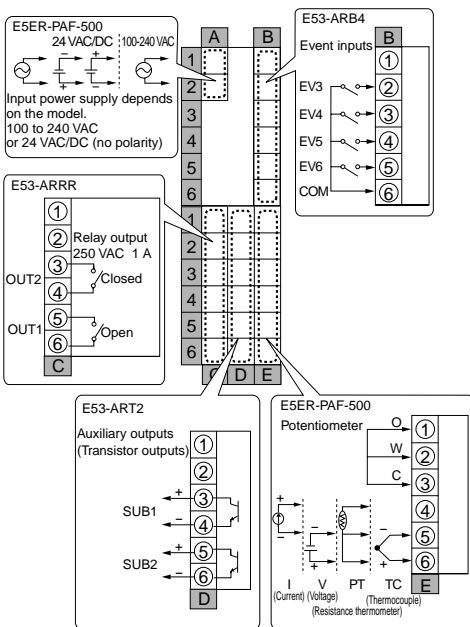

E5ER-PRQ43F-FLK

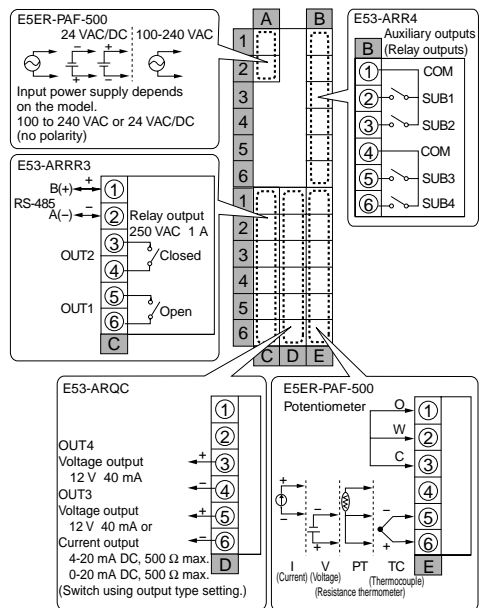

E5ER DeviceNet-compatible Controller Connections

E5ER-QTB-DRT

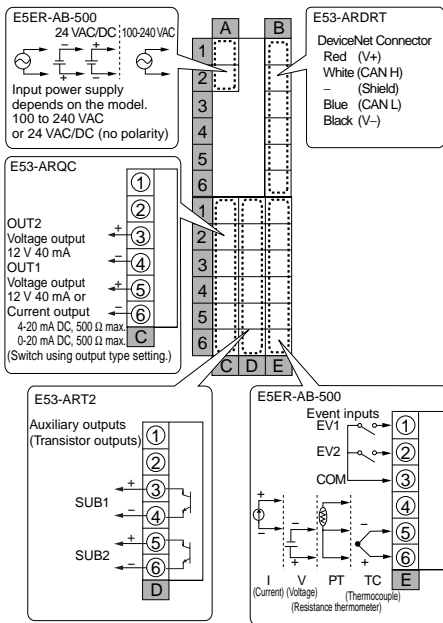

E5ER-CTB-DRT

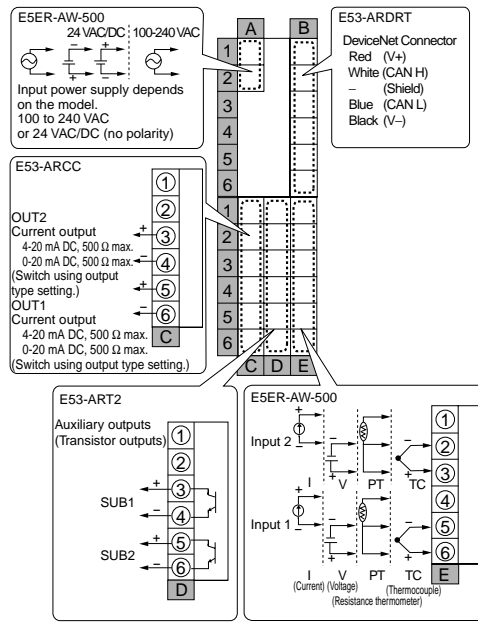

E5ER-QTW-DRT (2-loop Control)

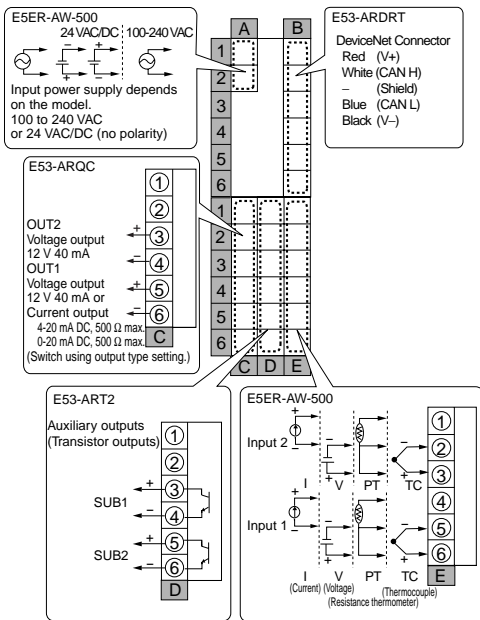

E5ER-CTW-DRT (2-loop Control)

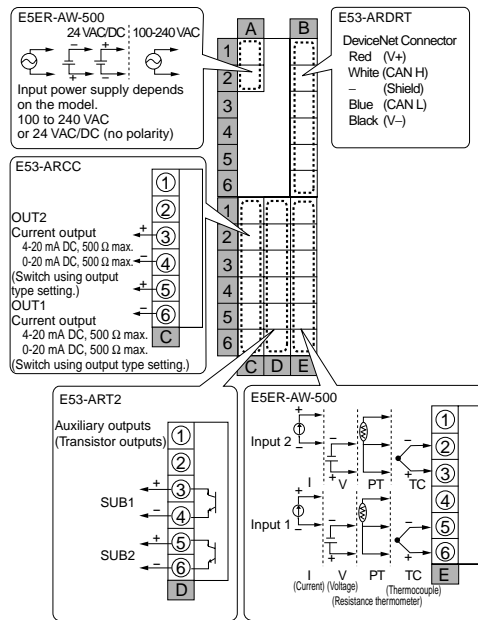

E5ER-PRTF-DRT

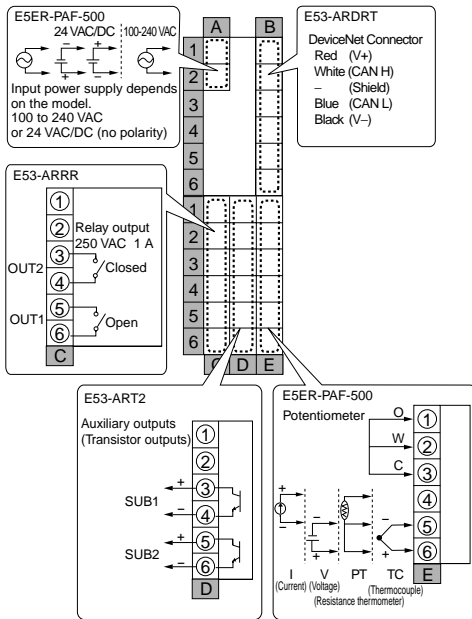

Dimensions

Note: All units are in millimeters unless otherwise indicated.

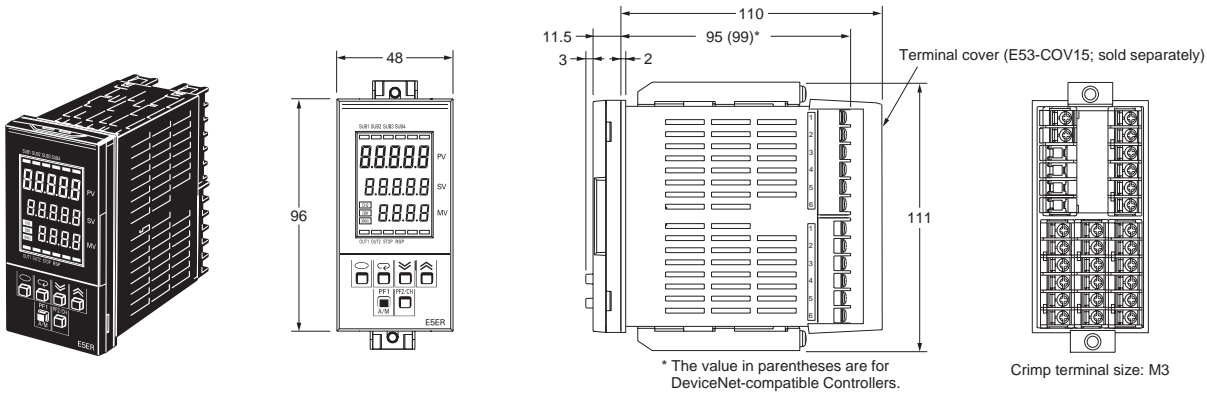

* The value in parentheses are for DeviceNet-compatible Controllers.

Crimp terminal size: M3

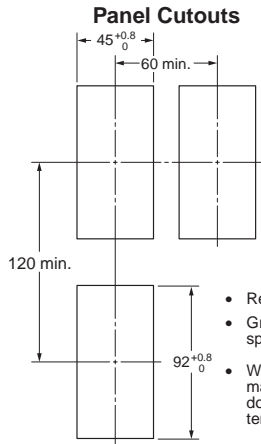

- Recommended panel thickness is 1 to 8 mm.
- Group mounting is not possible. (Maintain the specified mounting space between Controllers.)
- When two or more Controllers are mounted, make sure that the surrounding temperature does not exceed the allowable operating temperature specified in the specifications.

DeviceNet-compatible Controllers, Rear Panel

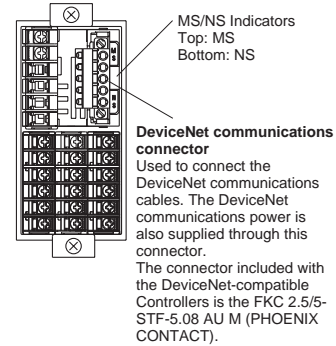

MS/NS Indicators
Top: MS
Bottom: NS

DeviceNet communications connector
Used to connect the DeviceNet communications cables. The DeviceNet communications power is also supplied through this connector.
The connector included with the DeviceNet-compatible Controllers is the FK2 2.5/5-STF-5.08 AU M (PHOENIX CONTACT).

Rubber Packing (Sold Separately)

Y92S-P5 (for E5ER)



If the rubber packing is lost or damaged, it can be ordered using the following model number: Y92S-P5.

(Depending on the operating environment, deterioration, contraction, or hardening of the rubber packing may occur and so, in order to ensure the level of waterproofing specified in NEMA4, periodic replacement is recommended.)

Note: Rubber packing is provided with the Controller.

Terminal Cover (Sold Separately)

E53-COV15 (for E5ER)

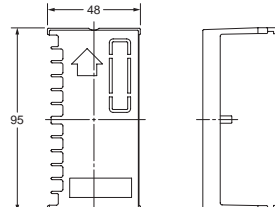
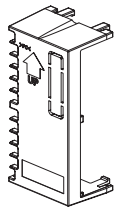

Unit Label Sheet (Sold Separately)

Y92S-L1

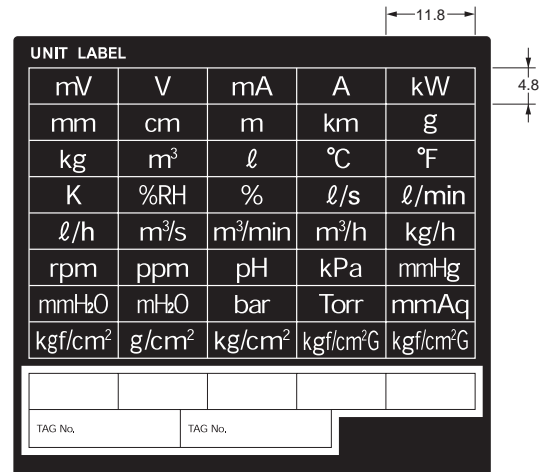

ALL DIMENSIONS SHOWN ARE IN MILLIMETERS.
To convert millimeters into inches, multiply by 0.03937. To convert grams into ounces, multiply by 0.03527.

E5AR/E5ER Common Information

■ Features/Performance

High-speed Sampling at 50 ms for Stable Control of Targets Requiring High-speed Response

The E5□R-DRT offers high-speed sampling at 50 ms for 4 loops (two to fivefold improvement on previous OMRON products). This is optimal for control operations such as high-speed response control by ceramic heaters, flowrate control, and pressure control.

Precision Control through High-resolution Temperature/Analog Inputs. Extraction of Square Root for Flowrate Control.

The high resolution and precision of inputs (Pt100, 0.01°C resolution), and high resolution and external overshooting adjustment function of outputs allow precision control/transfer.

The analog inputs have a high resolution (5-digit display at 0.01% resolution for Pt), and high precision of $\pm 0.1\%$ FS (two to three times better than previous OMRON products). The transfer and control outputs also have a high resolution of 1/43,000 (for 4 to 20 mA, a twentyfold improvement on previous OMRON products). In addition to PID autotuning, external interference gain parameters are provided to improve resistance to external interference. This allows high resolution when measuring, detecting changes, or logging internal temperature and humidity of devices, such as environmental testing equipment.

Simultaneous 5-digit Digital Display of PVs and SPs

Process values (PVs), set points (SPs), and manipulated variables (MVs)/Bank No. data is displayed simultaneously in a 3-row digital display. This simplifies PID tuning and monitoring of device status. The negative LCD display with backlight and simultaneous display of a bar graph (E5AR only) provides high visual clarity.

Multipoint, Cascade, and Proportional Control Using a Single Unit with 2 Temperature/Analog Inputs, and Standard Control of 4 Loops from a Single Unit with 4 Inputs (See Note). And Position-proportional Control.

The series includes models with 1, 2, and 4 temperature/analog inputs (see note). Various control modes can be selected in the software settings, including standard control, heating and cooling control, cascade control, proportional control, and remote SP control. This enables a single Unit to perform multipoint control (up to 4 inputs for the E5AR only), cascade control, and proportional control.

Particularly with multipoint control, a single Unit can be used to simultaneously control up to 4 points, such as temperature, humidity, and pressure, thereby contributing to reduced costs per loop and smaller panels.

Models that perform position-proportional control can be used to control proportional motors.

Note: The size of models with 4 analog inputs is 96 x 96 mm (E5AR only).

Easily Coordinate Control of PLCs Using Multiple I/O

Up to 6 event inputs are provided (depending on the model). These can be used to externally control memory bank switching, RUN/STOP, auto/manual, SP mode, and remote/local operations. A single transfer output (depends on the model) is also provided. This allows external output of PVs, SPs, MVs, and SP ramp values for each loop. Up to 4 auxiliary outputs are also provided. This allows external output of 11 alarm modes and input errors.

Using RS-485 communications (CompoWay/F), data can be easily shared with CS/CJ-series or other OMRON PLCs through a CJ1W-CIF21 Simple Communications Unit. MODBUS protocol is also supported.

Conforms to DeviceNet Multivendor Network

A DeviceNet connection enables high-speed data transfer by allocating settings and parameters to be monitored in PLC I/O areas. This greatly reduces the program development requirements for communications.

Using the DeviceNet Configurator, all parameters can be uploaded or downloaded in a single operation. Set parameters can also be saved, loaded, and printed, dramatically reducing maintenance time.

Various Calculation Functions

Calculation functions are provided as a standard feature, such as SP ramp, extraction of square root, and straight-line and broken-line approximation.

Download Initial Settings, and Mask, Print, Save in CSV Format, or Tune Display Settings Interactively from a Personal Computer. (CompoWay/F-compatible Models with Communications Functions Only)

Thermo Tools (Support Software sold separately) can be used to simply set initial settings from a personal computer. (Downloading initial settings reduces the time required for setting.)

Required setting data alone can also be displayed and set. Setting data can be saved as a document. PID tuning can also be performed while monitoring PV trends (fine tuning is also possible).

E5AR/E5ER Common Information

I/O Block Diagram

Standard Control Mode

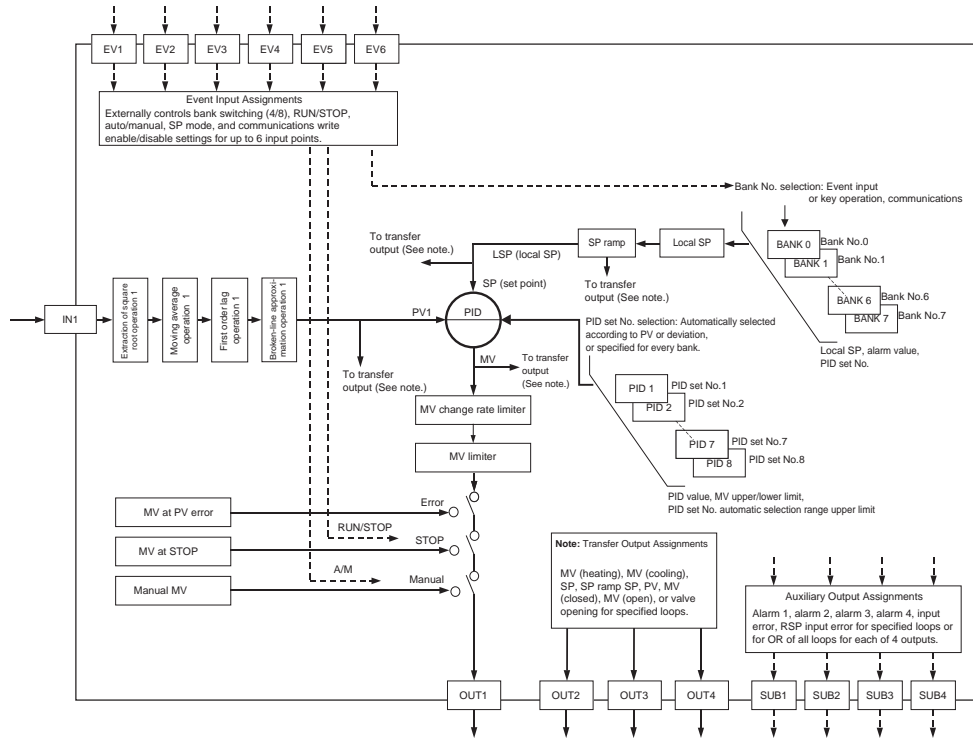

Heating and Cooling Control Mode

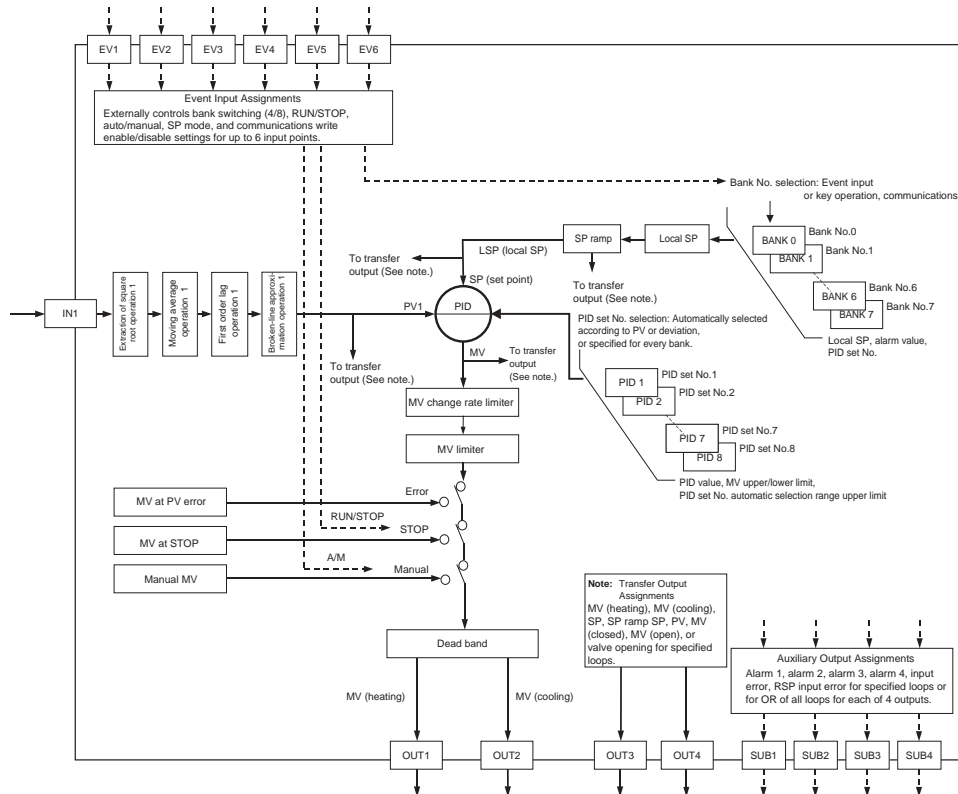

Single-loop Position-Proportional Control Mode

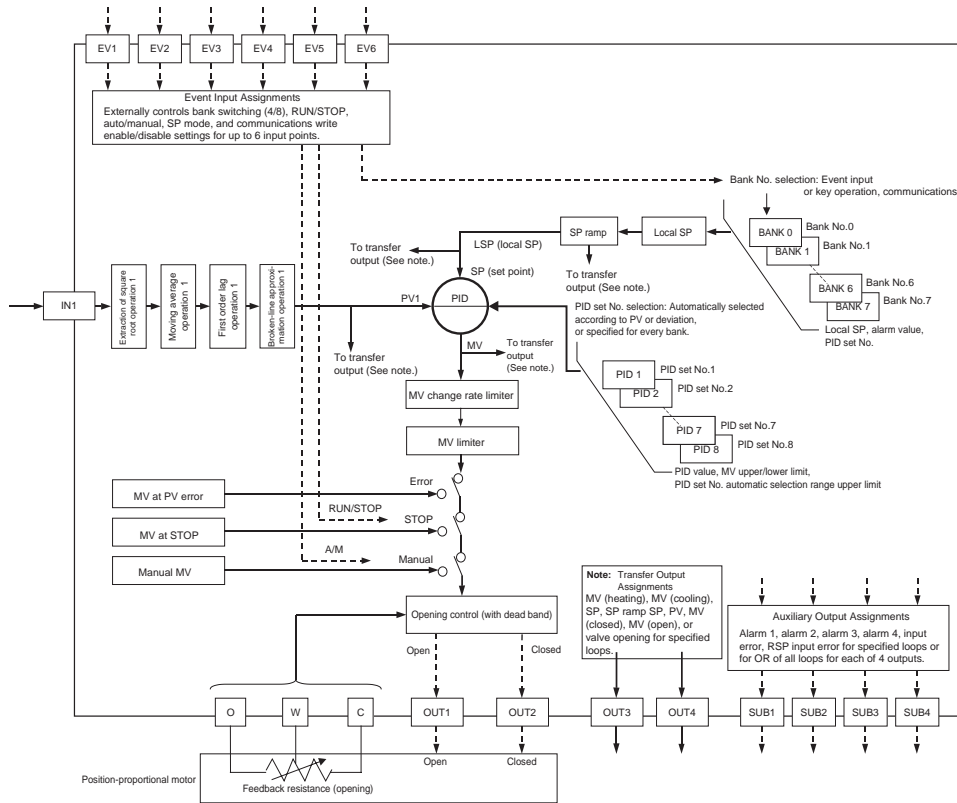

Single-loop Cascade Control Mode (2-Loop Controller)

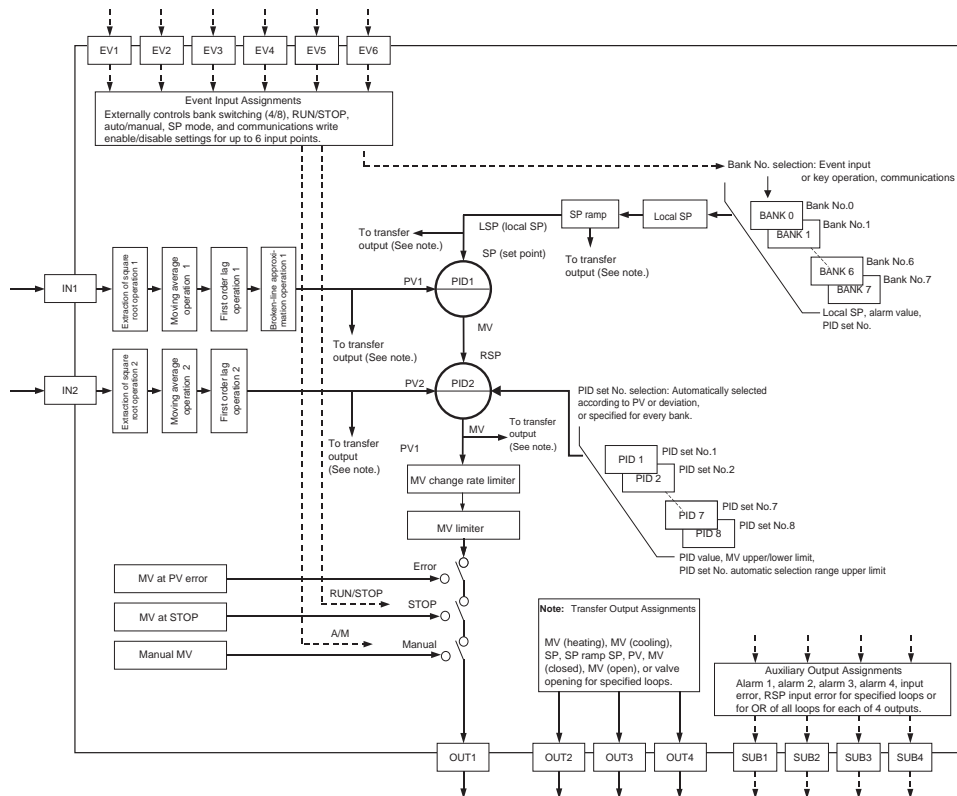

Single-loop Proportional Control Mode (2-Loop Controller)

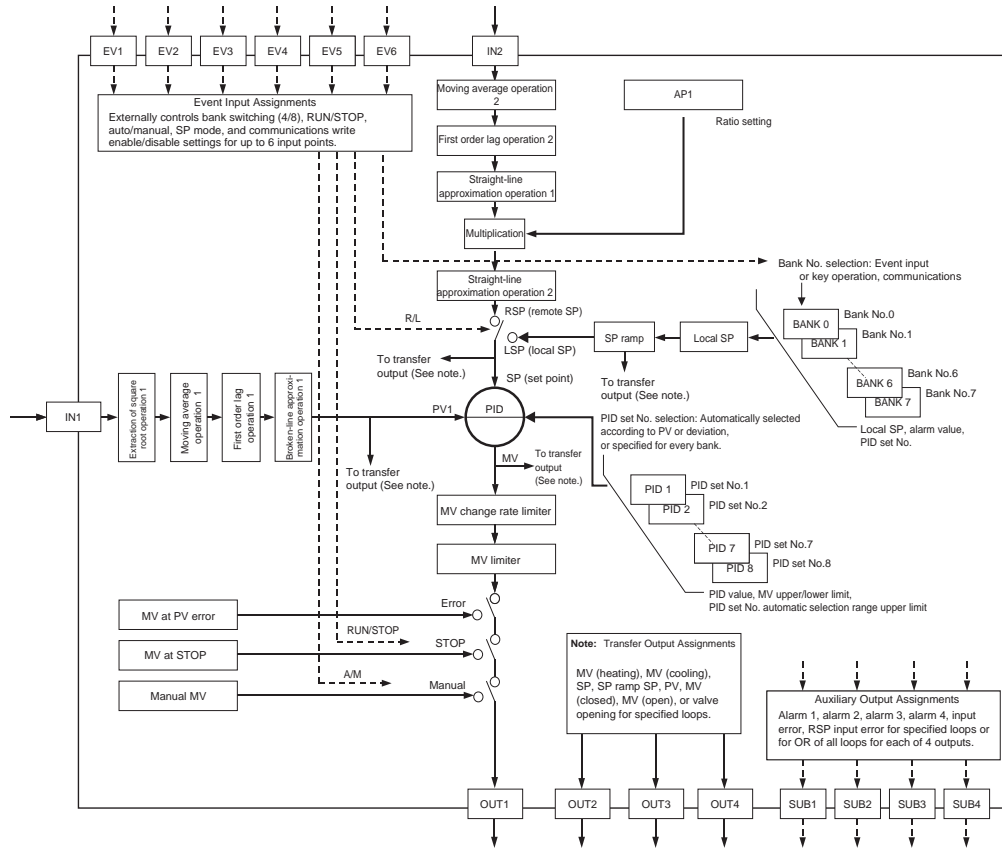

Nomenclature

E5AR

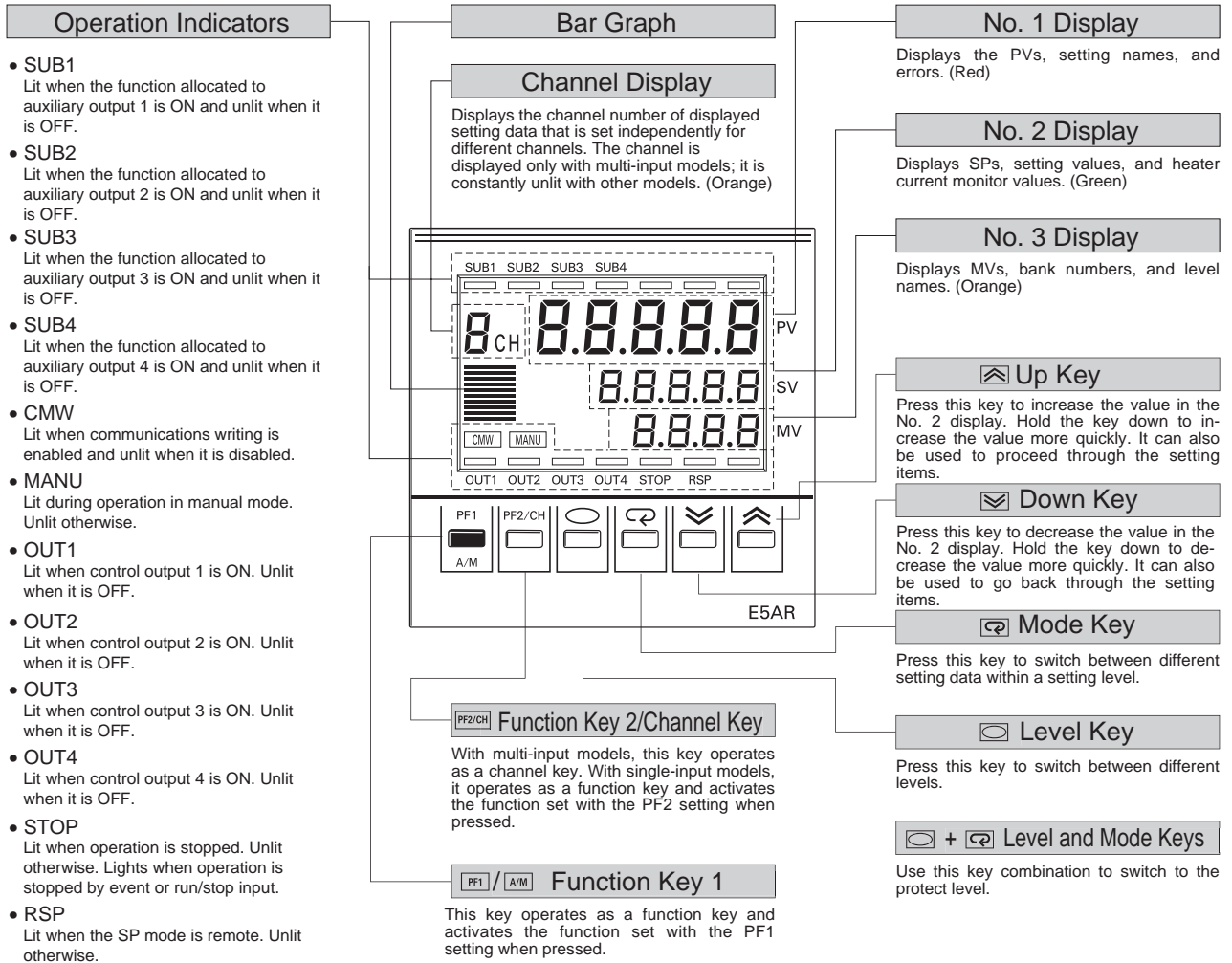

E5ER

Items without explanations are explained in the diagram for the E5AR.

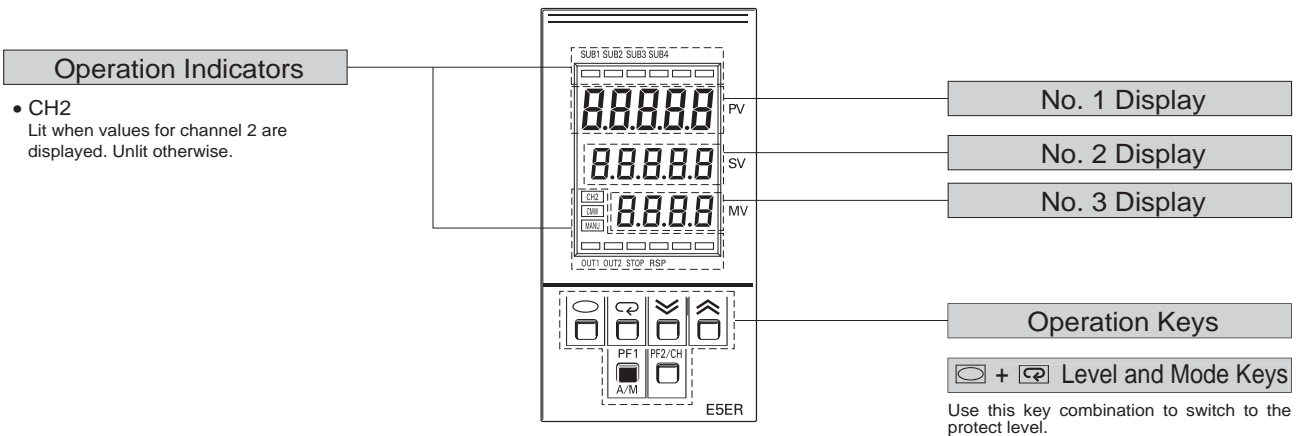

Installation

E5AR

1. Ensure waterproofing by mounting with waterproof packing.
2. Insert the E5AR into the mounting hole panel.

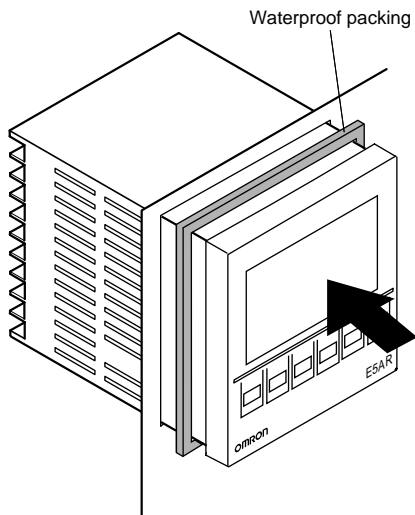

3. Insert the mounting brackets into the grooves on the top and bottom of the rear case.

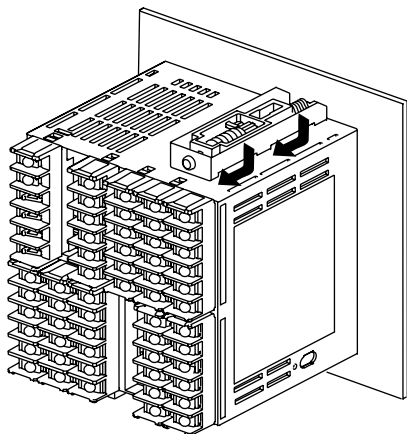

4. Tighten the screws on the mounting brackets alternately, keeping an even balance, until the ratchet stops tightening.

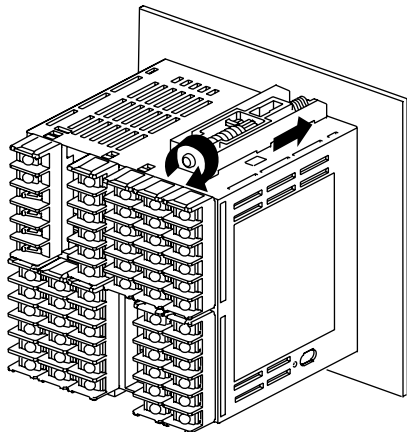

E5ER

1. Ensure waterproofing by mounting with waterproof packing.
2. Insert the E5ER into the mounting hole panel.

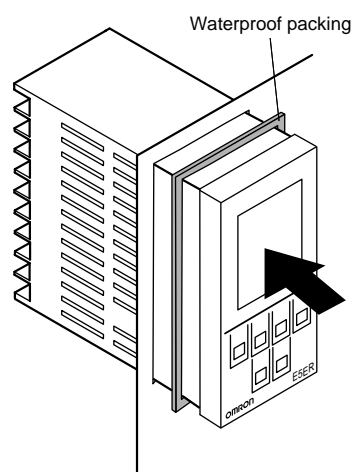

3. Insert the mounting brackets into the grooves on the top and bottom of the rear case.

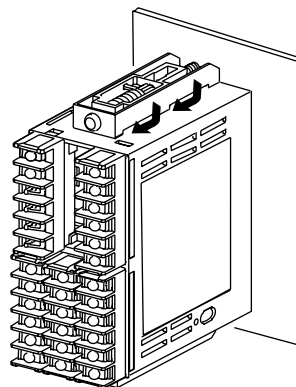

4. Tighten the screws on the mounting brackets alternately, keeping an even balance, until the ratchet stops tightening.

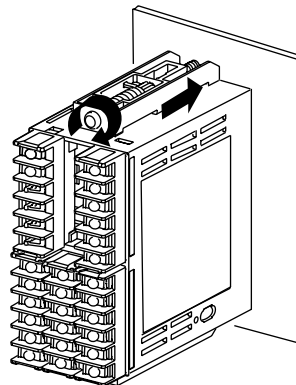

Drawing Out

Although the Unit does not have to be drawn out for standard operation, it can be drawn out for maintenance if necessary.

Removing the Front Panel

A flat-bladed screwdriver (shown below) is required to remove the front panel.

1. Insert the screwdriver in the holes (2) at the top and bottom of the front panel and unfasten the hooks.
2. Insert the screwdriver in the gap between the front panel and the rear case and pull out the front panel a little. Then, hold the top and bottom of the front panel and pull in the direction of the arrow (below) to remove.

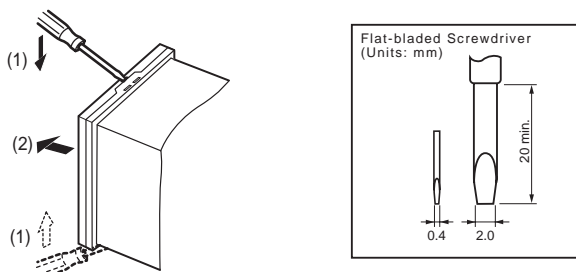

Wiring Precautions

- Prevent the influence of noise by separating input lines and power lines.
- Use crimp terminals.
- Tighten the terminal screws using a torque between 0.40 and 0.56 N·m.
- Use M3 crimp terminals with the following dimensions.

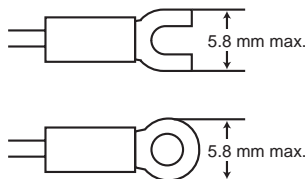

Initial Setup

Typical Example

This example shows how to perform initial setup for the E5AR-Q4B (100 to 240 VAC) and is based on the following conditions.

Input type: Pt100 (-200.0 to 850.0°C)

Control method: PID control

Output: Pulse voltage output

Control period: 0.5 s

Alarm 1: Upper limit alarm at 5.0°C

Alarm 2: Absolute-value upper limit alarm at 200.0°C

PID: Obtained by auto-tuning (AT)

SP: 150.0°C

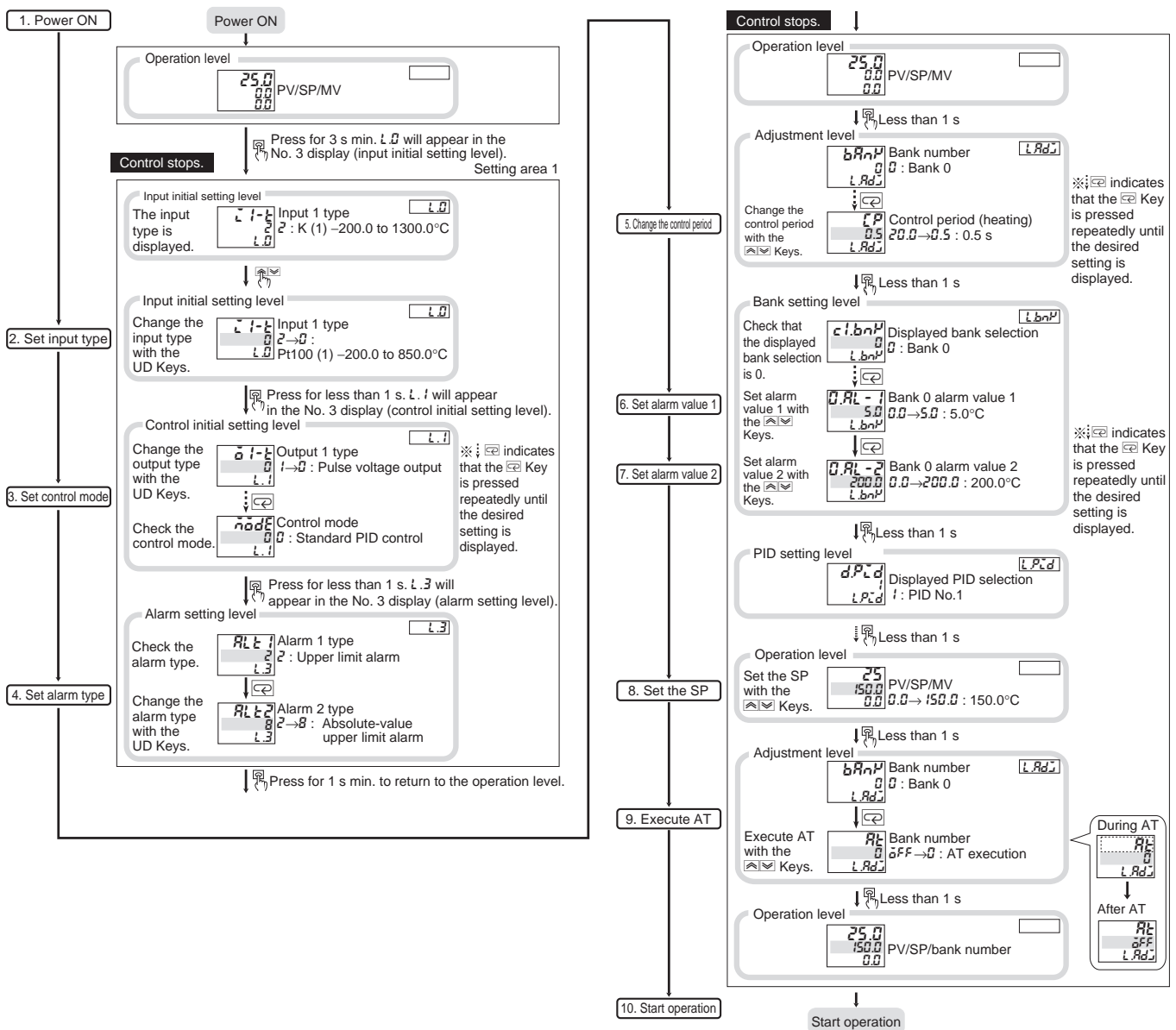
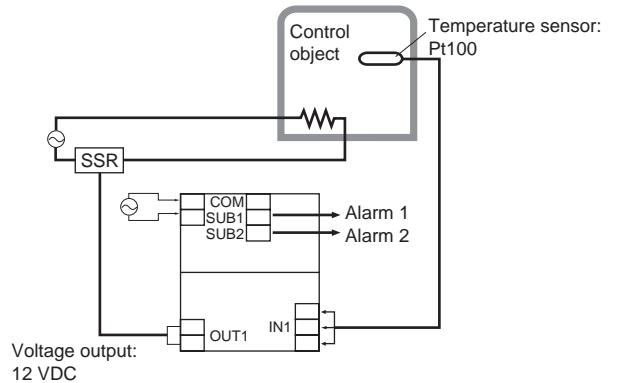

Specification Setting after Turning ON Power





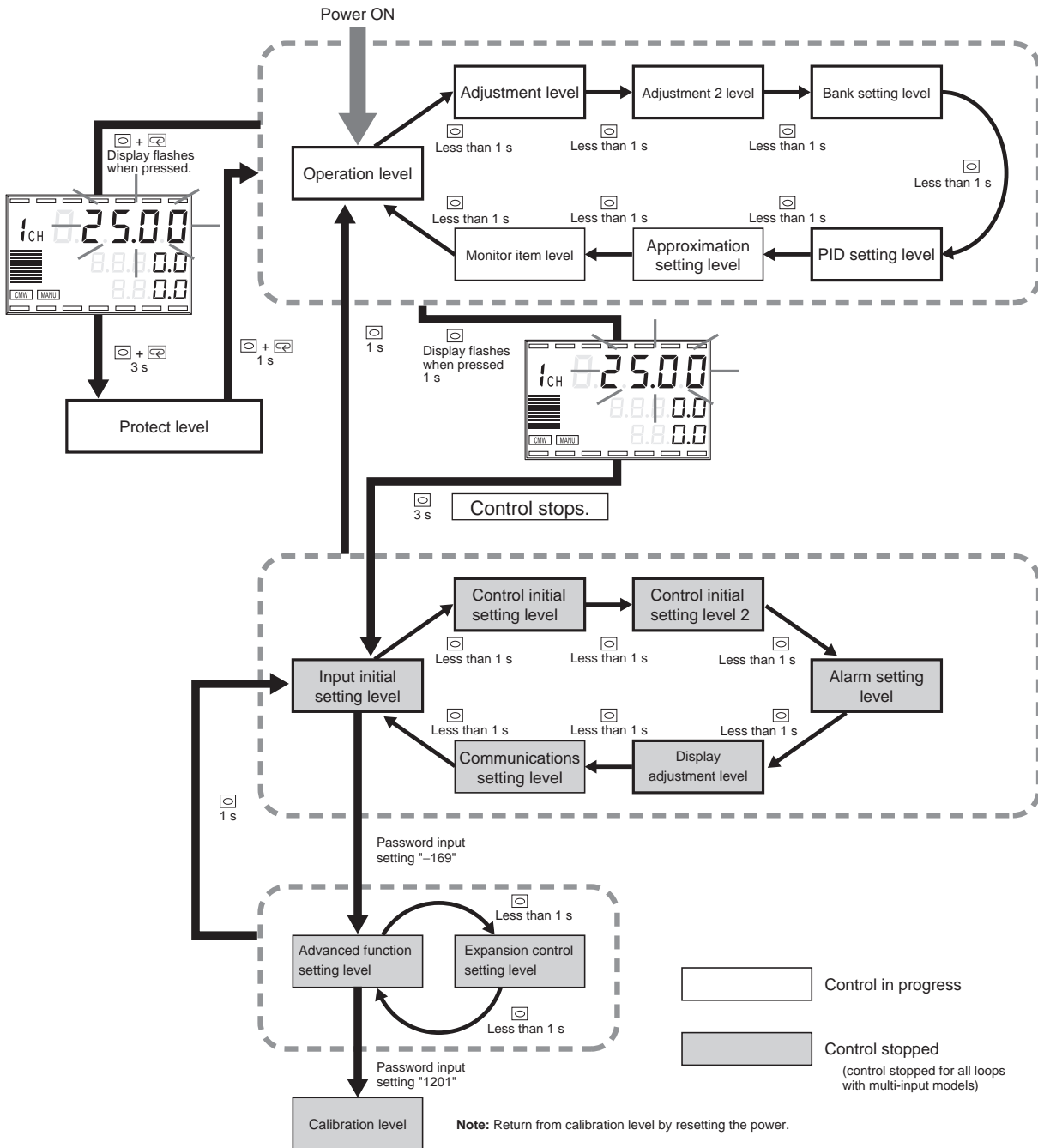



Setting Level Configuration and Key Operations

Setting items are divided into “levels” and the settings are referred to as “parameters.” With the E5AR/E5ER, setting items are classified into the 17 types shown below. When power is turned ON, all the indicators light for approx. 1 min before the Unit enters the operation level.



Note: Depending on the model or settings, some levels may not be displayed.

Input Allocation List

Set value	Input type name	Input range		Input type switch
		(°C)	(°F)	
0	Pt100 (1)	-200.0 to 850.0	-300.0 to 1500.0	Set to TC.PT 
1		-150.00 to 150.00	-199.99 to 300.00	
2	K	-200.0 to 1300.0	-300.0 to 2300.0	Set to TC.PT 
3		-20.0 to 500.0	0.0 to 900.0	
4	J	-100.0 to 850.0	-100.0 to 1500.0	Set to TC.PT 
5		-20.0 to 400.0	0.0 to 750.0	
6	T	-200.0 to 400.0	-300.0 to 700.0	Set to TC.PT 
7	E	0.0 to 600.0	0.0 to 1100.0	
8	L	-100.0 to 850.0	-100.0 to 1500.0	Set to TC.PT 
9	U	-200.0 to 400.0	-300.0 to 700.0	
10	N	-200.0 to 1300.0	-300.0 to 2300.0	Set to TC.PT 
11	R	0.0 to 1700.0	0.0 to 3000.0	
12	S	0.0 to 1700.0	0.0 to 3000.0	Set to TC.PT 
13	B	100.0 to 1800.0	300.0 to 3200.0	
14	W	0.0 to 2300.0	0.0 to 4100.0	Set to TC.PT 
15	4 to 20 mA	One of the following ranges is displayed by scaling.		
16	0 to 20 mA			
17	1 to 5 V			
18	0 to 5 V			
19	0 to 10 V			

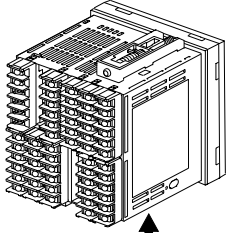

Input type switch (bottom)

The following example shows the settings required for the alarm to turn ON when the temperature exceeds 110°C/°F.

Alarms Other Than Absolute-value Alarms (Alarm Types 1 to 7)

Set the alarm value as a deviation from the SP.

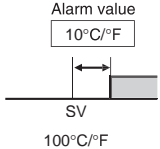

Absolute-value Alarms (Alarm Types 8 to 11)



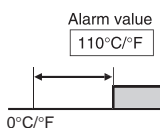







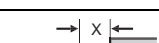
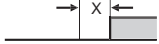
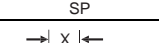
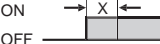
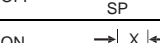
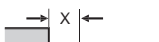
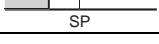

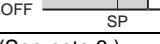

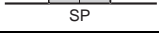

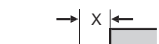
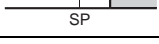
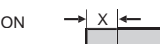
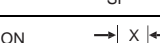
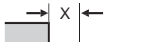
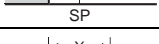

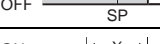
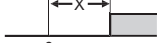
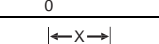

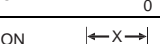

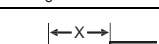
Set the alarm value as an absolute value with respect to 0°C/°F.

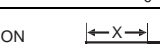

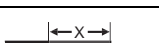
- The initial set value is 2 and the factory setting for the input type switch is TC.PT.

Alarm Type List

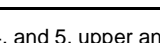
Alarm values are indicated by "X" in the following table. In cases where upper and lower limits are set independently, the upper limit is indicated by "H" and the lower limit is indicated by "L." If upper/lower limit, upper/lower limit range, or upper/lower limit with standby sequence is selected as the alarm type, set both the alarm upper limit and alarm lower limit values. For any other selection, set the (single) alarm value.

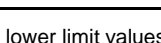
Set value	Alarm type	Alarm output function	
		Positive alarm value (X)	Negative alarm value (X)
0	No alarm function	Output OFF	
1 (See note 1.)	Upper/lower limit	ON  OFF 	(See note 2.)
2	Upper limit	ON  OFF 	ON  OFF 
3	Lower limit	ON  OFF 	ON  OFF 
4 (See note 1.)	Upper/lower limit range	ON  OFF 	(See note 3.)
5 (See notes 1 and 6.)	Upper/lower limit with standby sequence	ON  OFF 	(See note 4.)
6 (See note 6.)	Upper limit with standby sequence	ON  OFF 	ON  OFF 
7	Lower limit with standby sequence	ON  OFF 	ON  OFF 
8	Absolute-value upper-limit	ON  OFF 	ON  OFF 
9	Absolute-value lower-limit	ON  OFF 	ON  OFF 
10 (See note 6.)	Absolute-value upper-limit with standby sequence	ON  OFF 	ON  OFF 
11 (See note 6.)	Absolute-value lower-limit with standby sequence	ON  OFF 	ON  OFF 

Note 1: With set values 1, 4, and 5, upper and lower limit values can be set independently. They are indicated by "H" and "L" respectively.

2: Set value 1: Upper/lower limit alarm

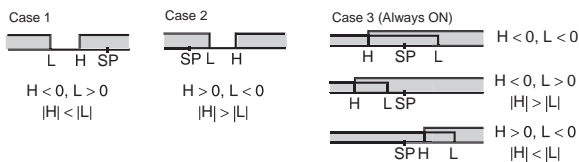

3: Set value 4: Upper/lower limit range

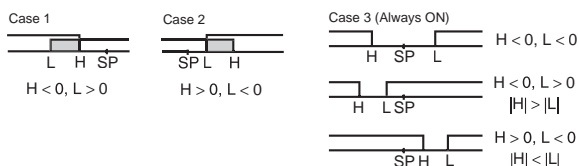

- 4: Set value 5: Upper/lower limit with standby sequence
Based on the above explanation for the upper/lower limit alarm, in cases 1 and 2, if the upper and lower limits effectively overlap because of hysteresis, operation will be always OFF; in case 3, operation will be always OFF.
- 5: Set value 5: Upper/lower limit with standby sequence
If the upper and lower limits effectively overlap because of hysteresis, operation will be always OFF.
- 6: For more details on the standby sequence, refer to the *User's Manual* (Z182).
- 7: If SP ramp is used, the alarm function will operate with respect to the SP after ramp during operation, and will operate with respect to the SP while operation is stopped.

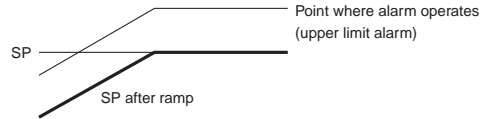

Parameter Lists

Display of Parameter Names and Set Values

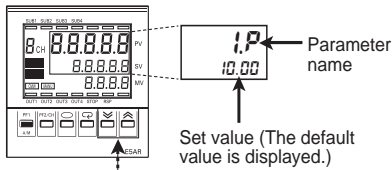

Change with keys

Note: Although all the parameters are listed here, the parameters that are actually displayed may vary with the model and/or functions used.

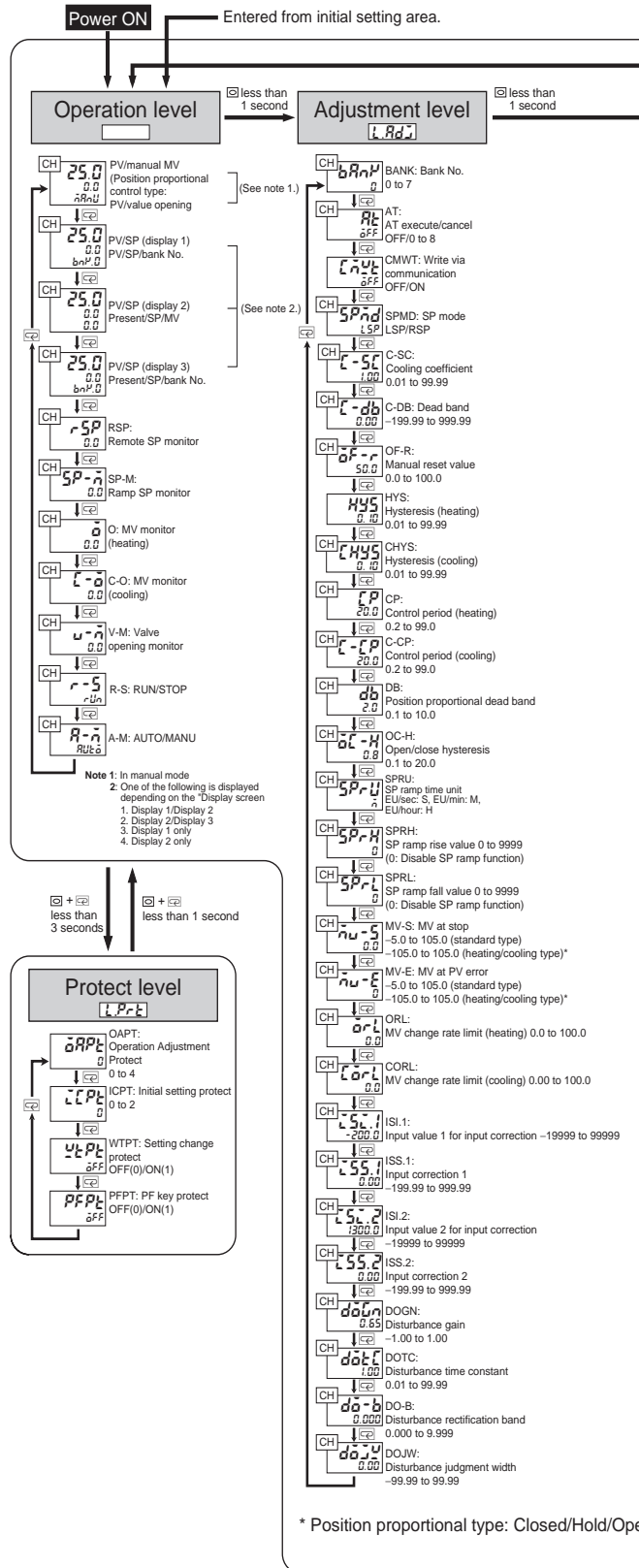

Operation adjustment area

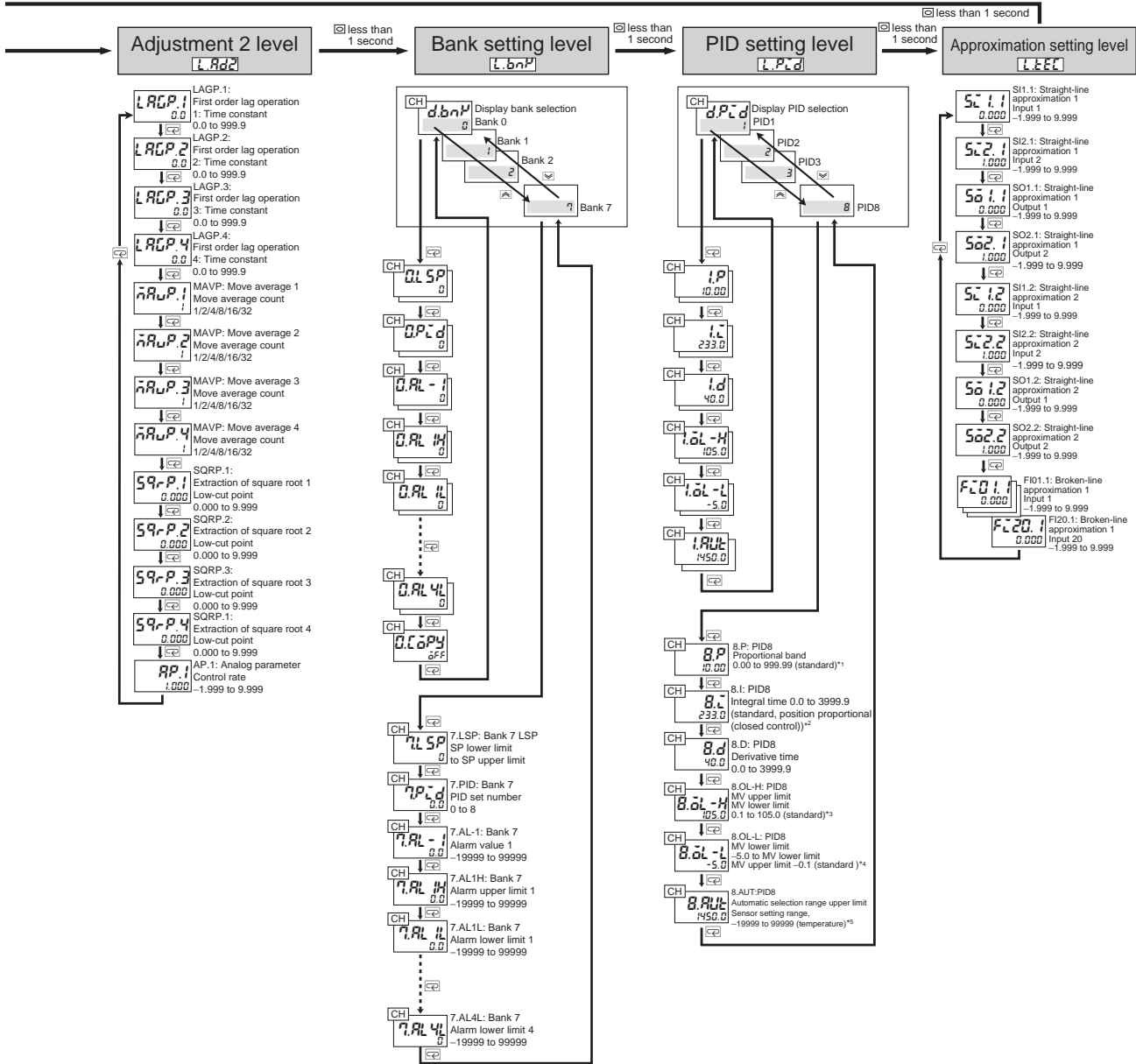

- *1 Position proportional type: 0.01 to 999.99.
- *2 Position proportional (floating control) type: 0.0 to 3999.9.
- *3 Heating and cooling control: 0.0 to 105.0.
- *4 Heating and cooling control: -105.0 to 0.0.
- *5 Analog type: -10% to 110% of scaling display range, with a maximum of -19999 to 99999.

Press the key for 3 seconds to move to the input initial setting level (page 28).
Control stops.

Entered from operation adjustment area.

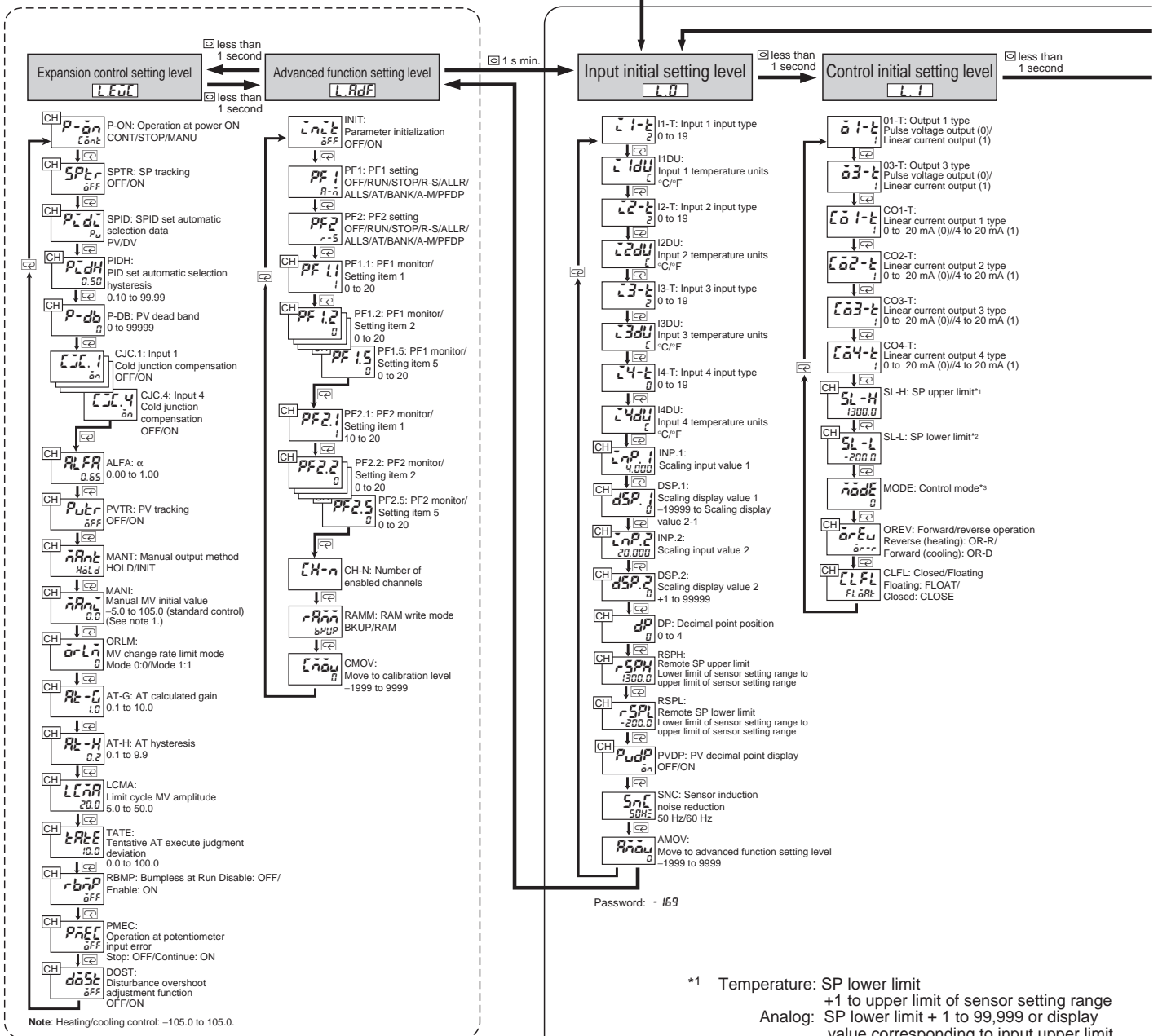

- *1 Temperature: SP lower limit
+1 to upper limit of sensor setting range
Analog: SP lower limit + 1 to 99,999 or display value corresponding to input upper limit, whichever is smaller
display value 2
- *2 Temperature: Lower limit of sensor setting range to SP upper limit -1
Analog: -1,999 or display value corresponding to input lower limit
- *3 1/4 input Standard (0)/heating or cooling (1)
2 input Standard (0)/heating or cooling (1)
Standard with remote SP (2)/
Heating or cooling (3) with remote SP/
Proportion (4)/Cascade standard (5)/
Cascade heating or cooling (6)

Initial setting area

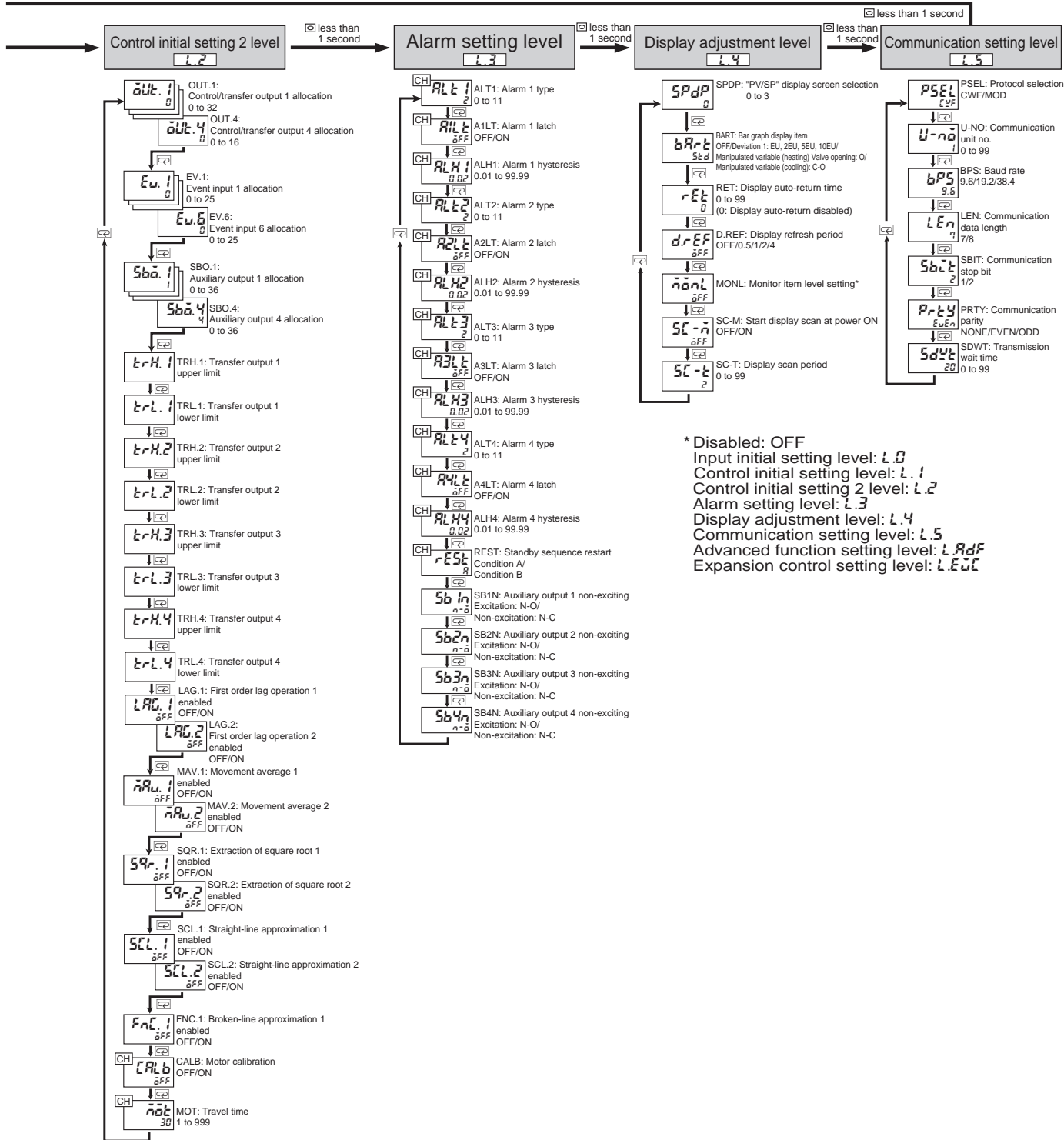

Press the key for 1 s min. to move to the operation level (page 26).

■ Protect Level

The protect function can be used to restrict the setting items that can be changed and thereby prevent unintentional setting changes. The protection functions that can be used include operation adjustment protection, initial setting level protection, setting change protection, and PF key protection.

Operation/Adjustment Protection

Key operations in the operation level, adjustment level 2, bank setting level, PID setting level, approximation setting level, and monitor item level can be restricted using the settings shown below.

Set value	Operation		Adjustment, adjustment 2	Bank setting, PID setting, approximation setting, monitor item
	PV/SP	Other		
0	☆	☆	☆	☆
1	☆	☆	☆	▲
2	☆	☆	▲	▲
3	☆	▲	▲	▲
4	○	▲	▲	▲

☆: Can be displayed and changed

○: Can be displayed

▲: Cannot be displayed and moving levels is not possible.

Default set value: 0

Initial Setting Level Protection

Movement to the input initial setting level, control initial setting level, control initial setting level 2, alarm setting level, display adjustment level, and communications setting level can be restricted using the settings shown below.

Set value	Movement to the input initial setting level	Movement to control initial setting level, control initial setting level 2, alarm setting level, display adjustment level, and communications setting level
0	Permitted: Move to advanced function setting levels" displayed.	Permitted
1	Permitted: Move to advanced function setting levels" not displayed.	Permitted
2	Prohibited	Prohibited

Communications Setting Level

Set the communications specifications in the communications setting level using panel operations. The communications parameters and their settings are listed in the following table.

Parameter	Displayed characters	Set values	Displayed set values
Protocol selection	psel	CompoWay/F, Modbus	cwt / mod
Communications unit number	u-no	0 to 99	0, 1 to 99
Baud rate	bps	9.6/19.2/38.4 (kbps)	9.6 / 19.2 / 38.4
Data length	len	7/8 (bits)	8 (bit)
Stop bits	sbit	1/2 (bits)	1 / 2
Parity	prty	None/even/odd	none / eUen / odd
Response send waiting time	sdwt	0 to 9,999 s	0 to 20 to 9999

Note: The highlighted values indicate default settings.

Before executing communications, set the communications unit number, baud rate, and other communications parameters using key operations in the way described below. Refer to the *User's Manual (Z182)* for details on other operations.

- If the set value for initial setting level protection is set to 2, nothing will happen when an attempt is made to enter the input initial setting level from the operation level, adjustment level, adjustment level 2, bank setting level, PID setting level, approximation setting level, or monitor item level by pressing the Level Key for 1 s min. (Also, the display will not flash as it usually does when changing level.)
- The default set value for initial setting level protection is 0.

Setting Change Protection

Settings can be protected from changes using the Up and Down Keys using the settings shown below.

Set value	Description
OFF	Settings can be changed with key operations.
ON	Settings (except those in the protect level) cannot be changed with key operations.

- Default set value: OFF

PF Key Protection

The PF1 and PF2 Keys can be enabled/disabled using the settings shown below.

Set value	Description
OFF	PF1 and PF2 Keys enabled.
ON	PF1 and PF2 Keys disabled. (Operations as function keys or loop keys are prohibited.)

- The default set value for PF key protection is OFF.

3. Press the Mode Key to move around the parameters in the way shown below.
4. Change the parameter settings as required using the Up and Down Keys.

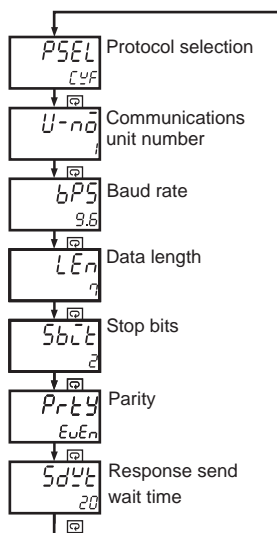

Set the communications parameters to match those of the computer to be communicated with.

Protocol Selection (psel)

Select either CompoWay/F or Modbus as the communications protocol. CompoWay/F is a general-purpose communications-based unified communications protocol developed by OMRON. Modbus is a communications protocol that conforms to the RTU Mode of the Modicon Inc.'s Modbus Protocol (specifications: PI-MBUS-300 Rev. J).

Communications Unit Number (u-no)

When communicating with the host computer, the unit number must be set in each Controller so that the host computer can identify each one. The number can be set to any integral value in the range 0 to 99. The default setting is 1. When using more than one Controller, be careful not to use the same number twice. Duplicate settings will cause malfunction. The set value becomes valid when the power is turned OFF and ON again.

Baud Rate (bps)

Use this parameter to set the speed of communications with the host computer. It can be set to one of the following values; 9.6 (9,600 bps), 19.2 (19,200 bps), or 38.4 (38,400 bps). The setting becomes valid when the power is turned OFF and ON again.

Data Length (len)

The length of communications data can be set to either 7 or 8 bits.

Stop Bits (sbit)

The number of communications stops bits can be set to either 1 or 2.

Parity (prty)

The communications parity can be set to none, even, or odd.

Response Send Wait Time (sdwt)

Changes to the response send wait time are enabled either after software reset or when the power is turned OFF and ON again.

Error Display (Troubleshooting)

When an error occurs, error codes will be displayed in the No.1 and/or No. 2 displays. Check the error contents and take the appropriate countermeasures.

Display 1	Display 2	Error description	Remedies	Output state at error	
				Control output	Alarm output
uni t	err	Unit error	First, reset the power. If the display does not change, repair is necessary. If the error is removed, it is possible that the original error was caused by noise. Check that there are no possible sources of noise.	OFF	OFF
uni t	chg	Unit change			
di sp	err	Display unit error			
sys	err	Main unit error	First, reset the power. If the display does not change, repair is necessary. If the error is removed, it is possible that the original error was caused by noise. Check that there are no possible sources of noise.	OFF	OFF
eep	err	EEPROM error	First, reset the power. If the display does not change, repair is necessary. If the error is removed, it is possible that the original error was caused by noise. Check that there are no possible sources of noise.	OFF	OFF
s.err	Normal display	Sensor input error	Check that the input wiring is correct, that the input type switch is set correctly, that there is no disconnection or short-circuit, and that the input type is correct. If there are no irregularities with the above items, reset the power. If the display does not change, repair is necessary. If the error is removed, it is possible that the original error was caused by noise. Check that there are no possible sources of noise.	MV is output according to the "MV at PV error" setting.	Same operation as when upper limit is exceeded.
<<<< >>>>	Normal display	Outside display range (below) Outside display range (above)	This is not an error, however, the present value is outside of the display range (-19999 to 99999).	Normal operation	Normal operation
Normal display	The RSP run indicator is blinking	RSP input error	Check and see if the wire to the RSP input is broken or shorted.	MV is output according to the "MV at PV error" setting.	OFF
Normal display	-----	Potentiometer input error	Check the potentiometer wire.	Normal operation	Normal operation
cal b	err	Motor calibration error	Check the wiring to the potentiometer and the valve drive motor, and then repeat motor calibration.	OFF	OFF
i 1-t i 2-t i 3-t i 4-t	A set value flashes	Input type switch error	Make sure the input type switch and the displayed "Input type" setting accord with the input type you will use.	OFF	OFF

Note: If the Controller does not operate as expected after making the settings, check the wiring and the settings. If the Controller still does not operate as expected, it is possible that parameters have been set incorrectly. It is recommended that the Controller is initialized and the settings performed again. (Initializing the Controller will return all settings to their default values. Make a note of the settings before performing initialization.)

Troubleshooting

If the temperature does not increase, outputs do not turn ON, or large discrepancies in the temperature occur, perform the checks listed in the following table.

Problem	Items to check and probable cause	Countermeasure
The temperature does not rise. Outputs do not turn ON.	1. Has control stopped? If the STOP indicator is lit, control has stopped.	Set run/stop to run in the operation level. The STOP indicator will turn OFF.
	2. Is control set to forward operation? Control must be set to reverse operation for heating control.	Set oreU to or-r in the initial setting level.
	3. Are the OUT indicators for control output lit or flashing? If the control output is not current output, the OUT indicators turn ON in synchronization with the output.	If the OUT indicators do not light at all, check items 1 and 2. If the OUT indicators are continuously lit, check connections to sensors, heaters, and other peripheral devices.
	4. If PID control is used, it is possible that the PID constants are unsuitable.	If possible, obtain the PID constants using auto-tuning. (Auto-tuning uses 100% output with respect to the load and so overshooting may occur.)
There are large discrepancies in the temperature.	1. Is the correct type of sensor used?	After checking the sensor type, check the setting for input type (i *-t) in the initial setting level. (*: 1 to 4)
	2. Are input correction values set?	Check the settings for input correction (i si *, i ss.*) in the adjustment level. (i si , *: 1 to 4) To display the temperature as measured by the sensor, set to 0.0.
	3. Is a compensating conductor used to extend the thermocouple connection?	Be sure to use a compensating conductor that is suitable for the sensor used.
	4. Is the sensor separated by a long distance? Is the insertion length short?	Check the installation location of the sensor with respect to the measured object. The sensor's insertion length must be at least 20 times the diameter of the protective tubing.
	Checking temperature controller input: <u>Thermocouple</u> Short the input terminals to display the room temperature. <u>Platinum Resistance Thermometer</u> Connect a resistance to the input terminals and check the display. Connect 100 Ω to A-B and short B-B: 0°C Connect 140 Ω to A-B and short B-B: Approx. 100°C	

Peripheral Devices

Temperature Sensor and SSR

Connection Example with SSR

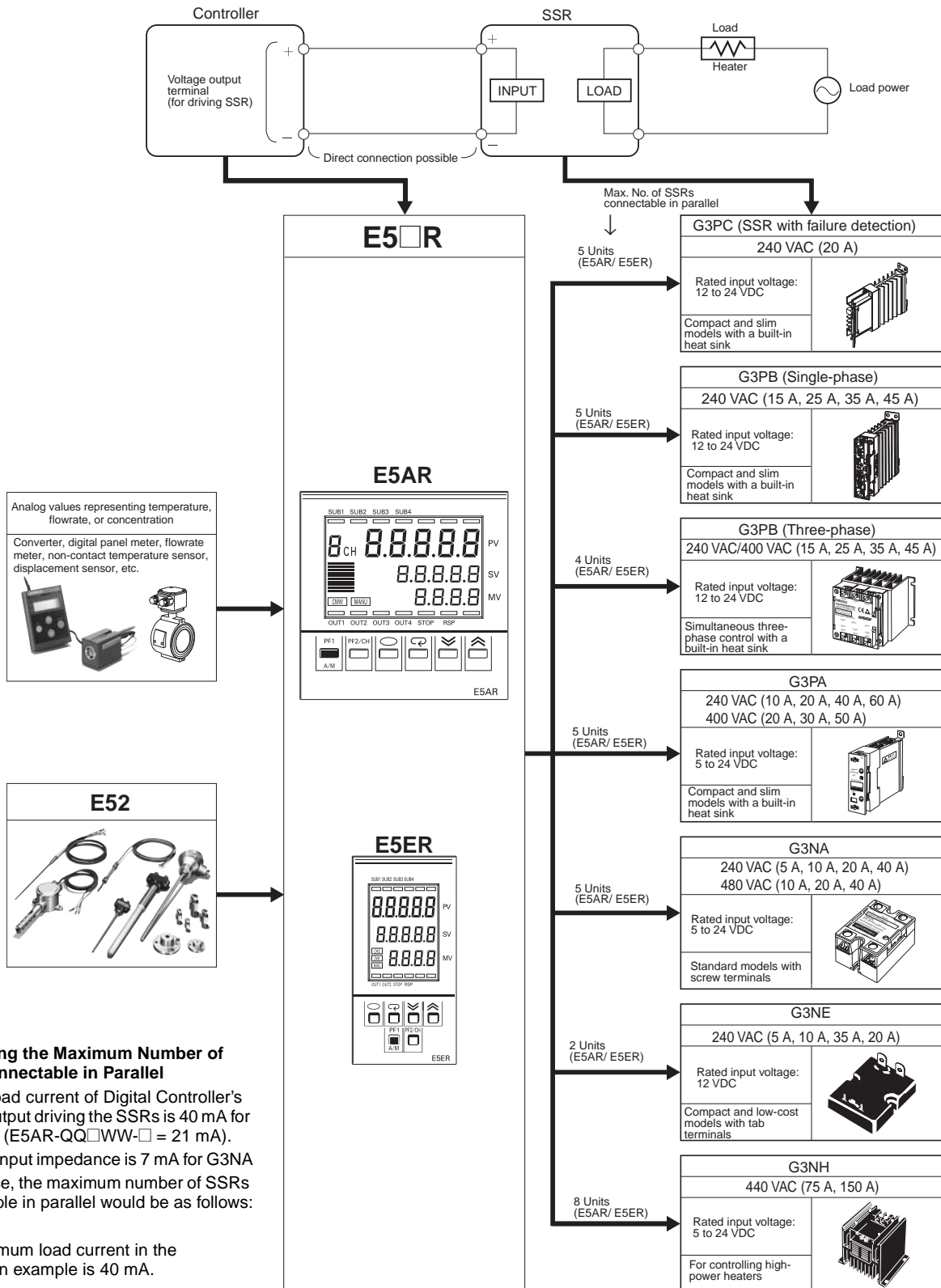

Calculating the Maximum Number of SSRs Connectable in Parallel

A: Max. load current of Digital Controller's voltage output driving the SSRs is 40 mA for the E5AR (E5AR-QQ□WW-□ = 21 mA).

B: SSR's input impedance is 7 mA for G3NA
In this case, the maximum number of SSRs connectable in parallel would be as follows:

$$A/B = 5$$

The maximum load current in the connection example is 40 mA.

Precautions

⚠ WARNING

Always provide protective circuits in the network. Without protective circuits, malfunctions may possibly result in accidents that cause serious injury or significant property damage. Provide double or triple safety measures in external control circuits, such as emergency stop circuits, interlock circuits, or limit circuits, to ensure safety in the system if an abnormality occurs due to malfunction of the product or another external factor affecting the product's operation.



Before transferring programs to other nodes or changing I/O memory of other nodes, check the nodes to confirm safety. Changing the program or I/O memory of other nodes may occasionally cause unexpected operation, resulting in minor or moderate injury, or damage to the equipment.



Do not attempt to disassemble, repair, or modify the product. Doing so may occasionally result in minor or moderate injury due to electric shock.



⚠ CAUTION

Do not attempt to disassemble, repair, or modify the product. Doing so may occasionally result in minor injury due to electric shock.



Do not touch the terminals, or electronic components or patterns on the PCB within 1 minute after turning OFF the power. Doing so may occasionally result in minor injury due to electric shock.



Do not allow pieces of metal, wire clippings, or fine metallic shavings or filings from installation to enter the product. Doing so may occasionally result in electric shock, fire, or malfunction.



Do not use the product in locations where flammable or explosive gases are present. Doing so may occasionally result in minor or moderate explosion, causing minor or moderate injury, or property damage.



Tighten the screws on the terminal block and the connector locking screws securely using a tightening torque within the following ranges. Loose screws may occasionally cause fire, resulting in minor or moderate injury, or damage to the equipment.



Terminal block screws: 0.40 to 0.56 N·m

Connector locking screws: 0.25 to 0.30 N·m

Perform correct setting of the product according to the application. Failure to do so may occasionally cause unexpected operation, resulting in minor or moderate injury, or damage to the equipment.



Ensure safety in the event of product failure by taking safety measures, such as installing a separate overheating prevention alarm system. Product failure may occasionally prevent control, or operation of alarm outputs, resulting in damage to the connected facilities and equipment.



Do not use the equipment for measurements within Measurement Categories II, III, or IV (according to IEC61010-1). Doing so may occasionally cause unexpected operation, resulting in minor or moderate injury, or damage to the equipment. Use the equipment for measurements only within the Measurement Category for which the product is designed.



The service life of the output relays depends on the switching capacity and switching conditions. Consider the actual application conditions and use the product within the rated load and electrical service life. Using the product beyond its service life may occasionally result in contact welding or burning.



Make sure that the product will not be adversely affected if the DeviceNet cycle time is lengthened as a result of changing the program with online editing. Extending the cycle time may cause unexpected operation, occasionally resulting in minor or moderate injury, or damage to the equipment.



■ Precautions for Safe Use

1. Use and store the product within the specified ambient temperature and humidity ranges. If several products are mounted side-by-side or arranged in a vertical line, the heat dissipation will cause the internal temperature of the products to rise, shortening the service life. If necessary, cool the products using a fan or other cooling method.
2. Provide sufficient space around the product for heat dissipation. Do not block the vents on the product.
3. Use the product within the noted supply voltage and rated load.
4. Be sure to confirm the name and polarity for each terminal before wiring the terminal block and connectors.
5. Do not connect anything to unused terminals.
6. Use the specified size of crimp terminals (M3, width: 5.8 mm max.) for wiring the terminal block.
7. To connect bare wires to the terminal block, use AWG22 to AWG14 (cross-sectional area: 0.326 to 2.081 mm²) to wire the power supply terminals and AWG28 to AWG16 (cross-sectional area: 0.081 to 1.309 mm²) for other terminals. (Length of exposed wire: 6 to 8 mm)
8. Ensure that the rated voltage is achieved no longer than 2 s after turning the power ON.
9. Turn OFF the power first before drawing out the product. Never touch the terminals or the electronic components, or subject them to physical shock. When inserting the product, do not allow the electronic components to contact the case.
10. Do not remove the inner circuit board.
11. Output turns OFF when shifting to the initial setting level in certain modes. Take this into consideration when setting up the control system.
12. Allow the product to warm up for at least 30 minutes after the power is turned ON.
13. Install surge absorbers or noise filters in devices near the product that generate noise (in particular, devices with an inductance component, such as motors, transformers, solenoids, and magnetic coils). If a noise filter is used for the power supply, check the voltage and current, and install the noise filter as close as possible to the product. Separate the product as far as possible from devices generating strong high-frequency noise (e.g., high-frequency welders and high-frequency sewing machines) or surges.
Do not tie noise filter input/output wires together.
14. Keep the wiring for the product's terminal block and connector separate from high-voltage, high-current power lines to prevent inductive noise. Do not run the wiring parallel to or in the same cable as power lines. The influence of noise can also be reduced by using separate wiring ducts or shield lines.
15. Install an external switch or circuit breaker and label them clearly so that the operator can quickly turn OFF the power.
16. Do not use the product in the following locations.
 - Locations where dust or corrosive gases (in particular, sulfuric or ammonia gas) are present.
 - Locations where icing or condensation may occur.
 - Locations exposed to direct sunlight.
 - Locations subject to excessive shock or vibration.

- Locations where the product may come into contact with water or oil.
 - Locations subject to direct radiant heat from heating equipment.
 - Locations subject to extreme temperature changes.
17. Cleaning: Do not use thinners. Use commercially available alcohol.
 18. Use the specified cables for the communications lines and stay within the specified DeviceNet communications distances. Refer to the *DeviceNet Manual (W267)* for details on communications distance specifications and cables.
 19. Do not pull the DeviceNet communications cables with excessive force or bend them past their natural bending radius.
 20. Do not connect or remove connectors while the DeviceNet power is being supplied. Doing so will cause product failure or malfunction.

■ Precautions for Correct Use

Service Life

Use the product within the following temperature and humidity ranges:

Temperature: -10 to 55°C (with no icing or condensation)

Humidity: 25% to 85%

When the product is installed inside a control panel, make sure that the temperature around the product, not the temperature around the control panel, does not exceed 55°C.

The service life of this product and similar electronic devices is determined not only by the number of switching operations of relays but also by the service life of internal electronic components. Component service life is affected by the ambient temperature: the higher the temperature becomes, the shorter the service life becomes and, the lower the temperature becomes, the longer the service life becomes. Therefore, the service life can be extended by lowering the temperature of the product.

Be sure to install the product according to the specified conditions. Otherwise, the heat generated by the product will cause the internal temperature to rise, shortening the service life. If necessary, cool the product using fans or other means of air ventilation.

When providing forced cooling, however, be careful not to cool down the terminals sections alone to avoid measurement errors.

Noise Countermeasures

To prevent inductive noise, separate the wiring for the product's terminal block and connector from high-voltage, high-current power lines. Do not run the wiring parallel to or in the same cable as power lines. The influence of noise can also be reduced by using separate wiring ducts or shield lines.

Install surge absorbers or noise filters in devices near the product that generate noise (in particular, devices with an inductance component, such as motors, transformers, solenoids, and magnetic coils).

If a noise filter is used for the power supply, check the voltage and current, and install the noise filter as close as possible to the product.

Separate the product as far as possible from devices generating strong high-frequency noise (e.g., high-frequency welders and high-frequency sewing machines) or surges.

Measurement Accuracy

When extending the thermocouple lead wire, be sure to use a compensating wire that matches the thermocouple type.

When extending the lead wire of the platinum resistance thermometer, be sure to use wires that have low resistance, and make sure that the resistances of the three lead wires are the same.

If the measurement accuracy is low, check whether the input shift is set correctly.

Waterproofing

The degree of protection is as shown below.

Front panel	NEMA 4X indoor use (equivalent to IP66)
Rear case	IP20
Terminals	IP00

Warranty and Limitations of Liability

■ WARRANTY

OMRON's exclusive warranty is that the products are free from defects in materials and workmanship for a period of one year (or other period if specified) from date of sale by OMRON.

OMRON MAKES NO WARRANTY OR REPRESENTATION, EXPRESS OR IMPLIED, REGARDING NON-INFRINGEMENT, MERCHANTABILITY, OR FITNESS FOR PARTICULAR PURPOSE OF THE PRODUCTS. ANY BUYER OR USER ACKNOWLEDGES THAT THE BUYER OR USER ALONE HAS DETERMINED THAT THE PRODUCTS WILL SUITABLY MEET THE REQUIREMENTS OF THEIR INTENDED USE. OMRON DISCLAIMS ALL OTHER WARRANTIES, EXPRESS OR IMPLIED.

■ LIMITATIONS OF LIABILITY

OMRON SHALL NOT BE RESPONSIBLE FOR SPECIAL, INDIRECT, OR CONSEQUENTIAL DAMAGES, LOSS OF PROFITS, OR COMMERCIAL LOSS IN ANY WAY CONNECTED WITH THE PRODUCTS, WHETHER SUCH CLAIM IS BASED ON CONTRACT, WARRANTY, NEGLIGENCE, OR STRICT LIABILITY.

In no event shall the responsibility of OMRON for any act exceed the individual price of the product on which liability is asserted.

IN NO EVENT SHALL OMRON BE RESPONSIBLE FOR WARRANTY, REPAIR, OR OTHER CLAIMS REGARDING THE PRODUCTS UNLESS OMRON'S ANALYSIS CONFIRMS THAT THE PRODUCTS WERE PROPERLY HANDLED, STORED, INSTALLED, AND MAINTAINED AND NOT SUBJECT TO CONTAMINATION, ABUSE, MISUSE, OR INAPPROPRIATE MODIFICATION OR REPAIR.

Application Considerations

■ SUITABILITY FOR USE

OMRON shall not be responsible for conformity with any standards, codes, or regulations that apply to the combination of products in the customer's application or use of the products.

At the customer's request, OMRON will provide applicable third party certification documents identifying ratings and limitations of use that apply to the products. This information by itself is not sufficient for a complete determination of the suitability of the products in combination with the end product, machine, system, or other application or use.

The following are some examples of applications for which particular attention must be given. This is not intended to be an exhaustive list of all possible uses of the products, nor is it intended to imply that the uses listed may be suitable for the products.

- Outdoor use, uses involving potential chemical contamination or electrical interference, or conditions or uses not described in this catalog.
- Nuclear energy control systems, combustion systems, railroad systems, aviation systems, medical equipment, amusement machines, vehicles, safety equipment, and installations subject to separate industry or government regulations.
- Systems, machines, and equipment that could present a risk to life or property.

Please know and observe all prohibitions of use applicable to the products.

NEVER USE THE PRODUCTS FOR AN APPLICATION INVOLVING SERIOUS RISK TO LIFE OR PROPERTY WITHOUT ENSURING THAT THE SYSTEM AS A WHOLE HAS BEEN DESIGNED TO ADDRESS THE RISKS, AND THAT THE OMRON PRODUCTS ARE PROPERLY RATED AND INSTALLED FOR THE INTENDED USE WITHIN THE OVERALL EQUIPMENT OR SYSTEM.

ALL DIMENSIONS SHOWN ARE IN MILLIMETERS.

To convert millimeters into inches, multiply by 0.03937. To convert grams into ounces, multiply by 0.03527.

Cat. No. H122-E1-02 **In the interest of product improvement, specifications are subject to change without notice.**

OMRON Corporation

Industrial Automation Company

Industrial Devices and Components Division H.Q.

Measuring Components Department

Shiokoji Horikawa, Shimogyo-ku,

Kyoto, 600-8530 Japan

Tel: (81)75-344-7080/Fax: (81)75-344-7189

Printed in Japan

1203-1M (0403) (B)

Данный компонент на территории Российской Федерации

Вы можете приобрести в компании MosChip.

Для оперативного оформления запроса Вам необходимо перейти по данной ссылке:

<http://moschip.ru/get-element>

Вы можете разместить у нас заказ для любого Вашего проекта, будь то серийное производство или разработка единичного прибора.

В нашем ассортименте представлены ведущие мировые производители активных и пассивных электронных компонентов.

Нашей специализацией является поставка электронной компонентной базы двойного назначения, продукции таких производителей как XILINX, Intel (ex.ALTERA), Vicor, Microchip, Texas Instruments, Analog Devices, Mini-Circuits, Amphenol, Glenair.

Сотрудничество с глобальными дистрибьюторами электронных компонентов, предоставляет возможность заказывать и получать с международных складов практически любой перечень компонентов в оптимальные для Вас сроки.

На всех этапах разработки и производства наши партнеры могут получить квалифицированную поддержку опытных инженеров.

Система менеджмента качества компании отвечает требованиям в соответствии с ГОСТ Р ИСО 9001, ГОСТ РВ 0015-002 и ЭС РД 009

Офис по работе с юридическими лицами:

105318, г.Москва, ул.Щербаковская д.3, офис 1107, 1118, ДЦ «Щербаковский»

Телефон: +7 495 668-12-70 (многоканальный)

Факс: +7 495 668-12-70 (доб.304)

E-mail: info@moschip.ru

Skype отдела продаж:

moschip.ru

moschip.ru_4

moschip.ru_6

moschip.ru_9