

THL3501 Evaluation Board (THEVAL3501)

16-channel LED Driver with LVDS Interface

Overview

The THL3501 is an LED driver with 16 channel open-drain outputs. The embedded oscillator and PWM controller individually generates 256-step brightness set by the dedicated registers for each channel. The serial interface of 2-pair LVDS lines (clock and data) features high-level noise tolerance, high-speed, and long-distance transmission. The LVDS allowing cascaded and multi-drop connection offers the maximum flexibility for designers to place and connect LED drivers. The simple and one-way communication protocol is easily-controlled and requires less CPU resources.

Applications

- Amusement
- LED Backlight
- LED Display
- Digital Signage
- Illumination

Features

- <Driver part>
 - Open-Drain Output: 16 channels
 - Output Sink Current: up to 100mA/ch
 - Output voltage: up to 40V
 - Individual Brightness Control: 256 steps
 - Group Brightness Control: 64 steps
 - Output disable/enable

- < Serial interface part >
 - 2-pair Serial LVDS Input or 3-wire Serial CMOS Input up to 10Mbps
 - Bridge Function Converting 3-wire Serial CMOS Input to 2-pair Serial LVDS Output
 - Repeater function of 2-pair Serial LVDS Input/ Output with Waveform and Timing Correction
 - Device Address Selection up to 62 addresses
 - General call to all devices

- <Protection Circuits>
 - UVLO, Overcurrent Protection, Thermal Shutdown
 - Supply Voltage: 3.0~5.5V
 - Package: QFN 40-pin Exposed Pad

Description

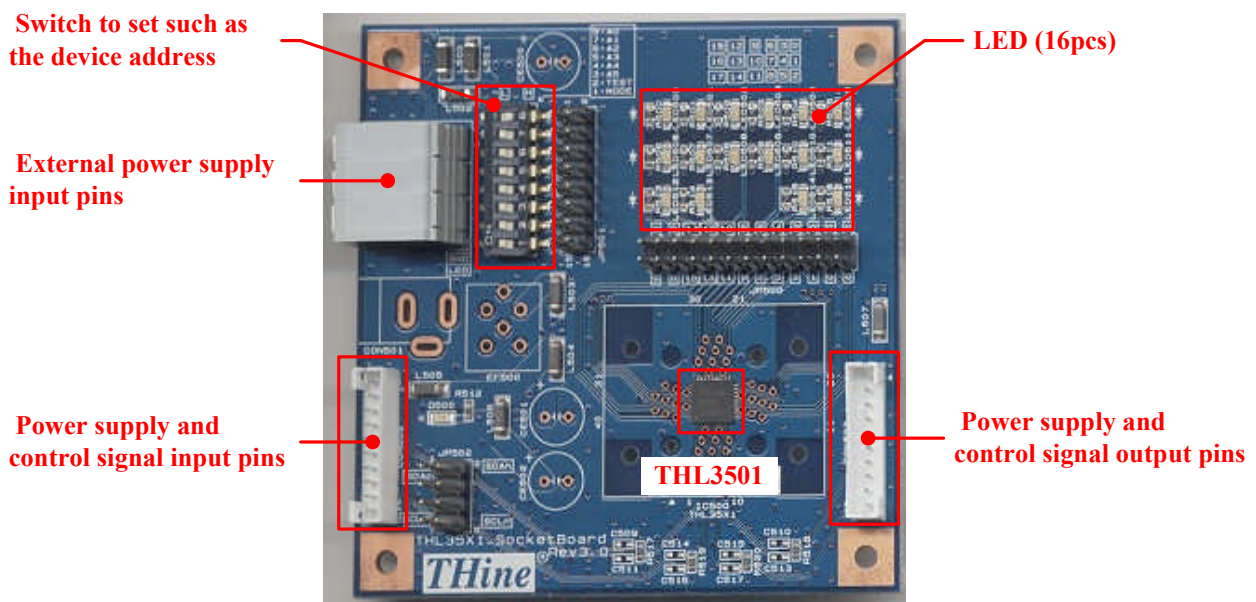

Figure 1 Board Overview

Power Supply Inputs

The method for connecting power supply inputs are shown below.

1) The all power supply inputs from the pre-stage. (Factory default settings)

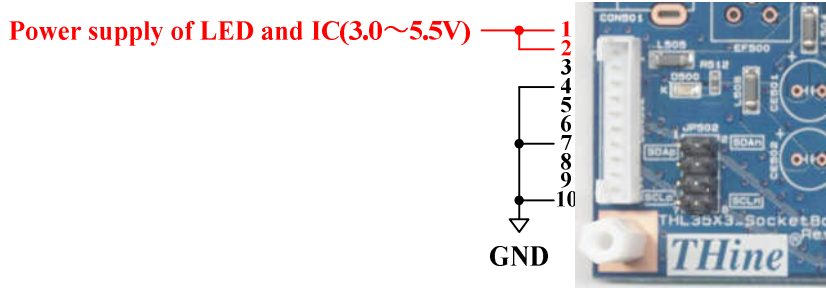

Figure 2 Power supply from pre-stage

2) The all power supply inputs from the external unit.

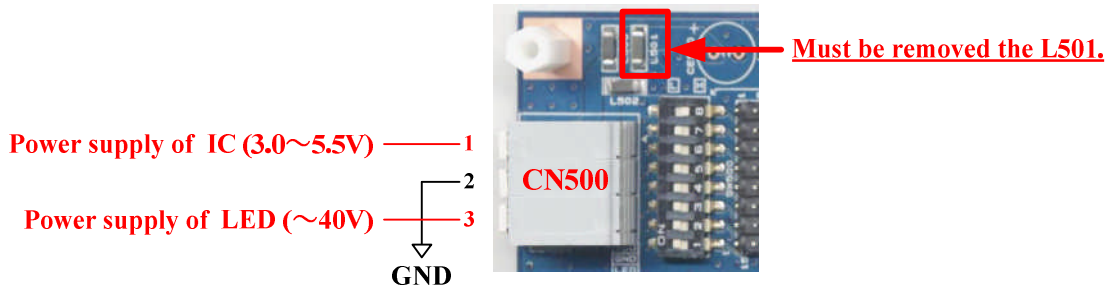

Figure 3 Power supply from external unit

3) The power supply of LED inputs from the external unit and the power supply of IC inputs from the pre-stage.

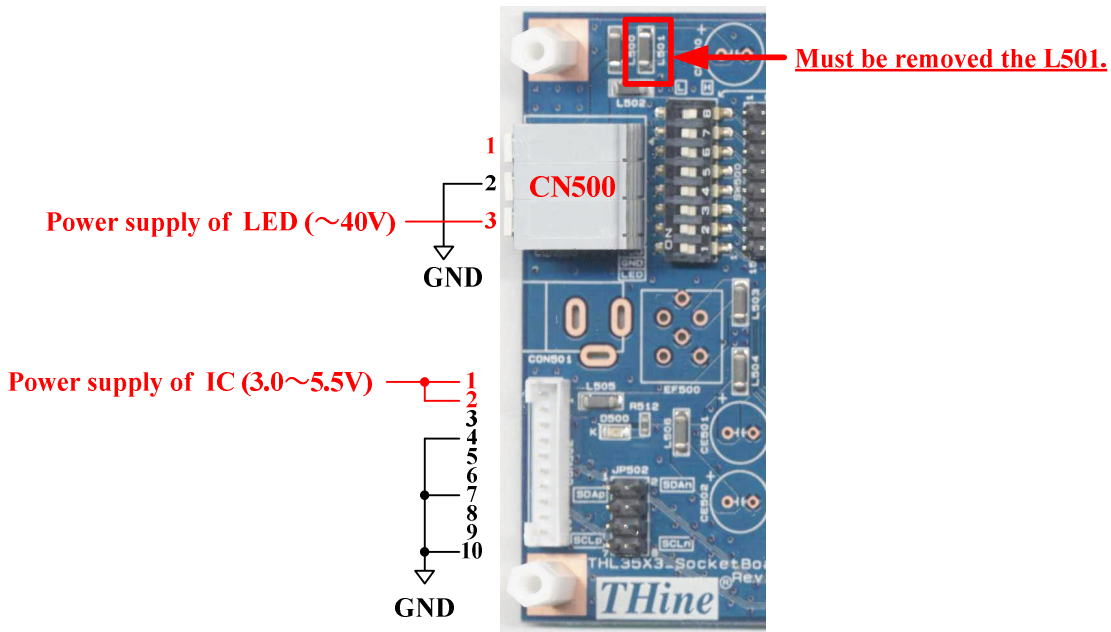

Figure 4 Power supply from external unit and pre-stage

Dip-Switch Setting

Dip-Switch can set the device address and the control signal input mode.

#2 TEST always set to Low.

1) Setting of the device address.

Device address can set the A0 to A5. Switch is the Low level when the ON side.

2) Setting of the control signal input mode.

Please refer to the following control signal input mode settings.

Table 1 Control signal input mode

Input Mode	MODE pin
3 wire serial CMOS	High
2 wire serial LVDS	Low

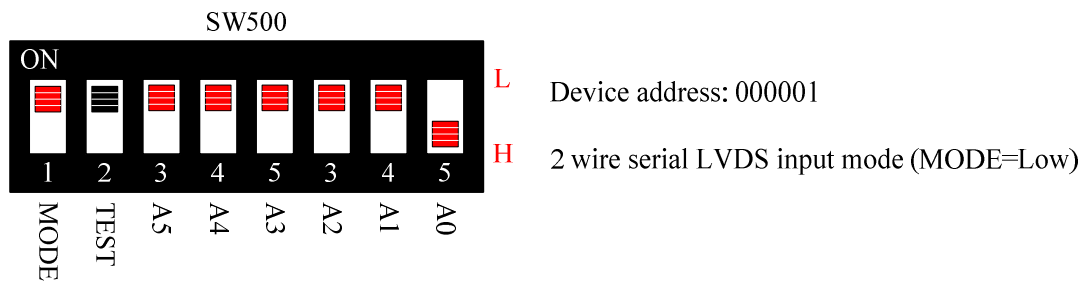

Figure 5 Example for DIP-Switch

Input Mode Setting

In the case of change the control signal input mode, The following processing is required.

1) To 2 wire serial LVDS input: Please implement the 100 ohm resistor to R517 and R519.

(Factory default settings)

2) To 3 wire serial CMOS input: Please remove the 100 ohm resistor from R517 and R519.

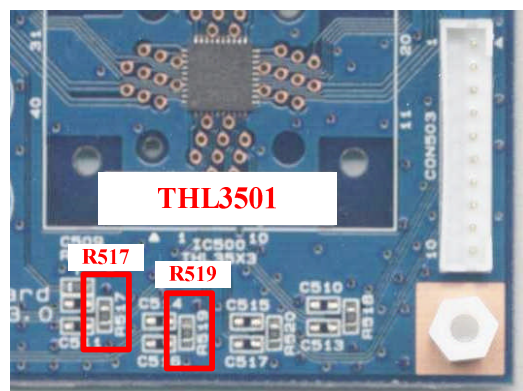

Figure 6 Processed terminal resistor

Board schematic

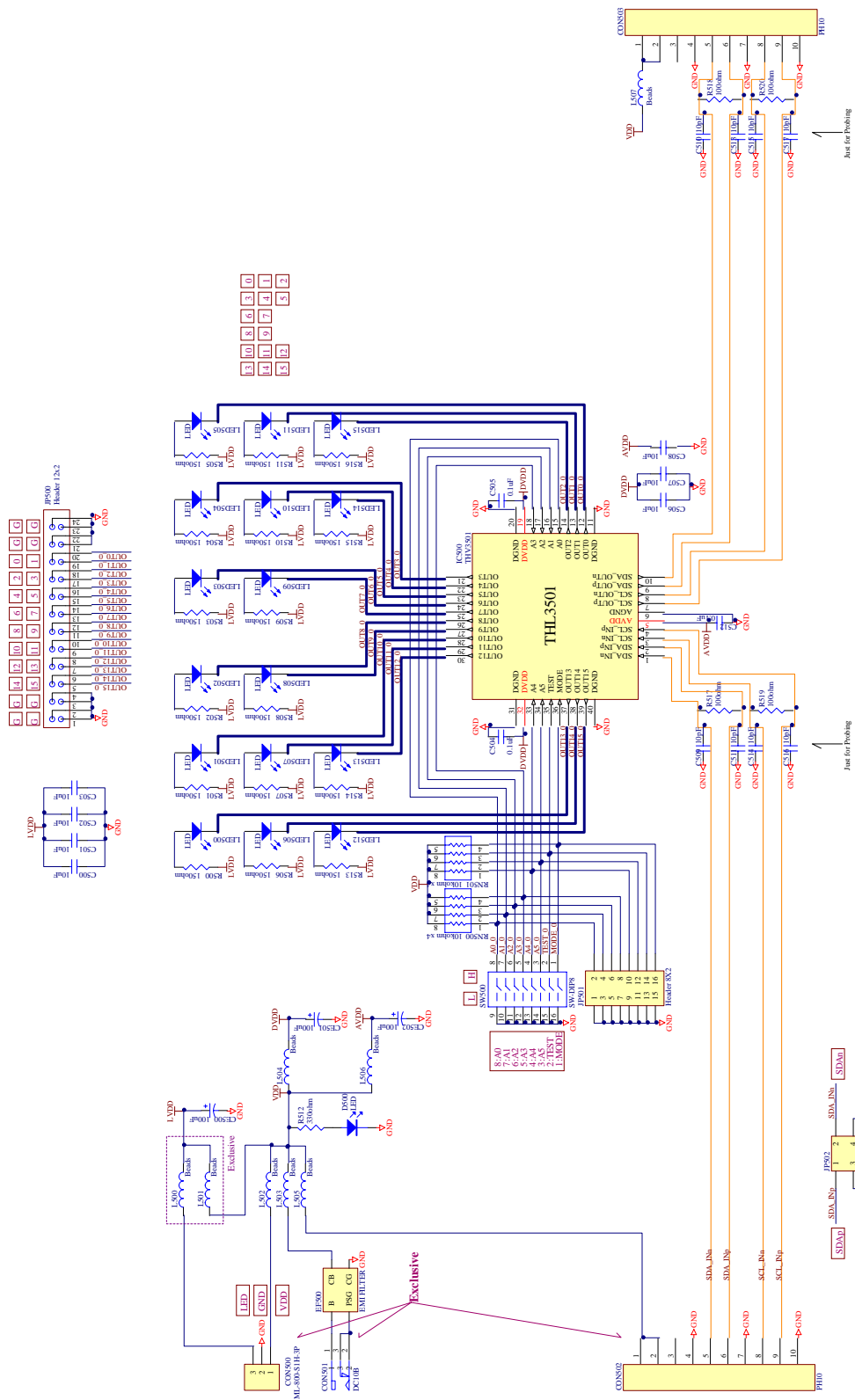

Figure 7 Board schematic

■Bill of materials

Table 2 Bill of materials

#	Designator	Description	Size	Part Number	Manufacturer
1	C500	Capacitor	3225	GRM32EB31H106KA12	Murata
2	C501	Capacitor	3225	GRM32EB31H106KA12	Murata
3	C502	Capacitor	3225	GRM32EB31H106KA12	Murata
4	C503	Capacitor	3225	GRM32EB31H106KA12	Murata
5	C504	Capacitor	1608	GRM188B31H104KA92	Murata
6	C505	Capacitor	1608	GRM188B31H104KA92	Murata
7	C506	Capacitor	3225	GRM32EB31H106KA12	Murata
8	C507	Capacitor	3225	GRM32EB31H106KA12	Murata
9	C508	Capacitor	3225	GRM32EB31H106KA12	Murata
10	C512	Capacitor	1608	GRM188B31H104KA92	Murata
11	CON500	Connector		ML-800-SIH-3P	Sato-parts
12	CON502	Nylon Connector		B10B-PH-K-S(LF)(SN)	JST
13	CON503	Nylon Connector		B10B-PH-K-S(LF)(SN)	JST
14	D500	LED (Red)		SML-210LT	Rohm
15	IC500	LED Driver	QFN40	THL3501	THine
16	JP500	Pin Header	2.54mm pitch	JTW-2500	Hirosugi-Keiki
17	JP501	Pin Header	2.54mm pitch	JTW-2500	Hirosugi-Keiki
18	JP502	Pin Header	2.54mm pitch	JTW-2500	Hirosugi-Keiki
19	L500	Bead	4516	BLM41PG600SN1L	Murata
20	L502	Bead	4516	BLM41PG600SN1L	Murata
21	L503	Bead	4516	BLM41PG600SN1L	Murata
22	L504	Bead	4516	BLM41PG600SN1L	Murata
23	L505	Bead	4516	BLM41PG600SN1L	Murata
24	L506	Bead	4516	BLM41PG600SN1L	Murata
25	L507	Bead	4516	BLM41PG600SN1L	Murata
26	LED500	LED	2012	PY1112H-TR	Stanley
27	LED501	LED	2012	PY1112H-TR	Stanley
28	LED502	LED	2012	PY1112H-TR	Stanley
29	LED503	LED	2012	PY1112H-TR	Stanley
30	LED504	LED	2012	PY1112H-TR	Stanley
31	LED505	LED	2012	PY1112H-TR	Stanley
32	LED506	LED	2012	PY1112H-TR	Stanley
33	LED507	LED	2012	PY1112H-TR	Stanley
34	LED508	LED	2012	PY1112H-TR	Stanley
35	LED509	LED	2012	PY1112H-TR	Stanley
36	LED510	LED	2012	PY1112H-TR	Stanley
37	LED511	LED	2012	PY1112H-TR	Stanley
38	LED512	LED	2012	PY1112H-TR	Stanley
39	LED513	LED	2012	PY1112H-TR	Stanley
40	LED514	LED	2012	PY1112H-TR	Stanley
41	LED515	LED	2012	PY1112H-TR	Stanley
42	R500	Resistor	1608	RK73B1JBK151J	KOA
43	R501	Resistor	1608	RK73B1JBK151J	KOA
44	R502	Resistor	1608	RK73B1JBK151J	KOA
45	R503	Resistor	1608	RK73B1JBK151J	KOA
46	R504	Resistor	1608	RK73B1JBK151J	KOA
47	R505	Resistor	1608	RK73B1JBK151J	KOA
48	R506	Resistor	1608	RK73B1JBK151J	KOA
49	R507	Resistor	1608	RK73B1JBK151J	KOA
50	R508	Resistor	1608	RK73B1JBK151J	KOA
51	R509	Resistor	1608	RK73B1JBK151J	KOA
52	R510	Resistor	1608	RK73B1JBK151J	KOA
53	R511	Resistor	1608	RK73B1JBK151J	KOA
54	R512	Resistor	1608	RK73B1JBK331J	KOA
55	R513	Resistor	1608	RK73B1JBK151J	KOA
56	R514	Resistor	1608	RK73B1JBK151J	KOA
57	R515	Resistor	1608	RK73B1JBK151J	KOA
58	R516	Resistor	1608	RK73B1JBK151J	KOA
59	R517	Resistor	1608	RK73B1JBK101J	KOA
60	R518	Resistor	1608	RK73B1JBK101J	KOA
61	R519	Resistor	1608	RK73B1JBK101J	KOA
62	R520	Resistor	1608	RK73B1JBK101J	KOA
63	RN500	Resistor Array	3216	CN1J4TTD103J	KOA
64	RN501	Resistor Array	3216	CN1J4TTD103J	KOA
65	SW500	DIP Switch		A6S-8101-H	Omron

Notices and Requests

1. The product specifications described in this material are subject to change without prior notice.
2. The circuit diagrams described in this material are examples of the application which may not always apply to the customer's design. We are not responsible for possible errors and omissions in this material. Please note if errors or omissions should be found in this material, we may not be able to correct them immediately.
3. This material contains our copyright, know-how or other proprietary. Copying or disclosing to third parties the contents of this material without our prior permission is prohibited.
4. Note that if infringement of any third party's industrial ownership should occur by using this product, we will be exempted from the responsibility unless it directly relates to the production process or functions of the product.
5. This product is presumed to be used for general electric equipment, not for the applications which require very high reliability (including medical equipment directly concerning people's life, aerospace equipment, or nuclear control equipment). Also, when using this product for the equipment concerned with the control and safety of the transportation means, the traffic signal equipment, or various Types of safety equipment, please do it after applying appropriate measures to the product.
6. Despite our utmost efforts to improve the quality and reliability of the product, faults will occur with a certain small probability, which is inevitable to a semi-conductor product. Therefore, you are encouraged to have sufficiently redundant or error preventive design applied to the use of the product so as not to have our product cause any social or public damage.
7. Please note that this product is not designed to be radiation-proof.
8. Customers are asked, if required, to judge by themselves if this product falls under the category of strategic goods under the Foreign Exchange and Foreign Trade Control Law.
9. The product or peripheral parts may be damaged by a surge in voltage over the absolute maximum ratings or malfunction, if pins of the product are shorted by such as foreign substance. The damages may cause a smoking and ignition. Therefore, you are encouraged to implement safety measures by adding protection devices, such as fuses.

THine Electronics, Inc.
sales@thine.co.jp

Mouser Electronics

Authorized Distributor

Click to View Pricing, Inventory, Delivery & Lifecycle Information:

CEL:

[THEVAL3501](#)

Данный компонент на территории Российской Федерации

Вы можете приобрести в компании MosChip.

Для оперативного оформления запроса Вам необходимо перейти по данной ссылке:

<http://moschip.ru/get-element>

Вы можете разместить у нас заказ для любого Вашего проекта, будь то серийное производство или разработка единичного прибора.

В нашем ассортименте представлены ведущие мировые производители активных и пассивных электронных компонентов.

Нашей специализацией является поставка электронной компонентной базы двойного назначения, продукции таких производителей как XILINX, Intel (ex.ALTERA), Vicor, Microchip, Texas Instruments, Analog Devices, Mini-Circuits, Amphenol, Glenair.

Сотрудничество с глобальными дистрибьюторами электронных компонентов, предоставляет возможность заказывать и получать с международных складов практически любой перечень компонентов в оптимальные для Вас сроки.

На всех этапах разработки и производства наши партнеры могут получить квалифицированную поддержку опытных инженеров.

Система менеджмента качества компании отвечает требованиям в соответствии с ГОСТ Р ИСО 9001, ГОСТ РВ 0015-002 и ЭС РД 009

Офис по работе с юридическими лицами:

105318, г.Москва, ул.Щербаковская д.3, офис 1107, 1118, ДЦ «Щербаковский»

Телефон: +7 495 668-12-70 (многоканальный)

Факс: +7 495 668-12-70 (доб.304)

E-mail: info@moschip.ru

Skype отдела продаж:

moschip.ru

moschip.ru_4

moschip.ru_6

moschip.ru_9