



# 32, 35, L32 Series Pressfit Indicator Light for 1/2" Diameter Mounting Hole



- NEON, LED & INCANDESCENT
- 2 TO 600 DESIGN VOLTS
- 6" WIRE LEADS & 3/16" TAB TERMINALS
- VARIETY OF LENS COLORS
- cULus CERTIFIED (UL FILE E20356)
- QUICK DISCONNECT TERMINAL CE CERTIFIED

## Overview

The 32/35 Series Indicators feature a wide variety of lenses, colors, voltage & bezel variations. Indicators quickly pressfit into a 0.500" to 0.510" mounting hole with recommended panel thickness range of 0.020" min. to 0.090" max.

## Specifications

**Housing:** White nylon. A black housing is available.

**Bezel:** Nickel plated brass. A black anodized bezel is available.

**Lens:** polycarbonate.

**Incandescent AC or DC voltage options:** 6, 14 and 28 volts.

**Neon AC or DC voltage options:** 125 and 250 and 600 volts.

**Note:** high brightness green and blue neon lamps supplied in green and blue neon applications.

**Led DC voltage options:** 2, 6, 12, 24 volts.

**Led AC voltage options:** 125 volts.

**Note:** 125 volts AC units contain a bi-polar LED.  
LED versions are not CE Certified.

**Two 6" wire leads:** #20 AWG, black, bare copper, PVC insulated, UL/CSA rated 105 °C, 600 V, UL style 1015, stripped 1/2". For DC LED units, wire leads are color-coded red and black; the red wire lead denotes the anode (+) while a black wire lead identifies the cathode (-). For AC LED units, wire leads are white. Custom wire lengths, stripping, termination and wire type are available.

### Terminals:

**3/16 tabs:** Brass, (0.187" length x 0.020" thick). For LED units, a tin plated terminal denotes the anode (+). 1/4" or 1/8" brass tab terminals are available.

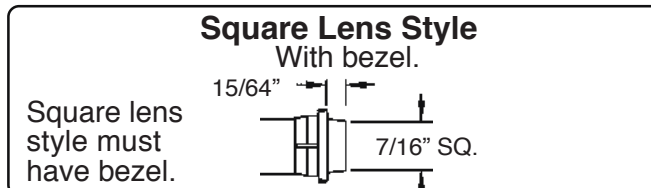
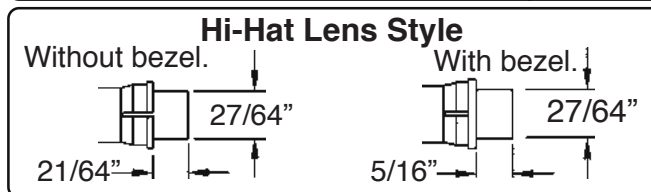
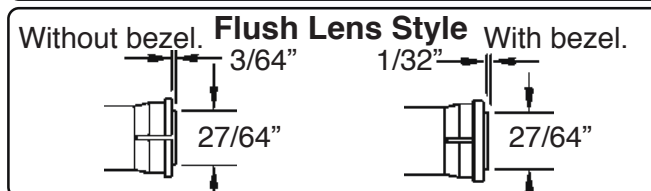
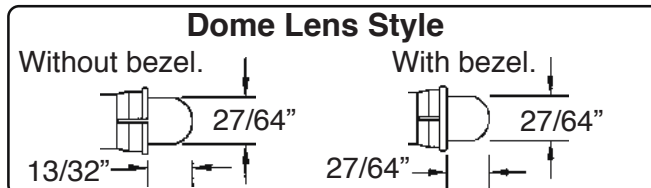
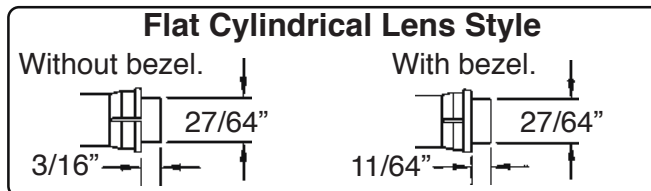
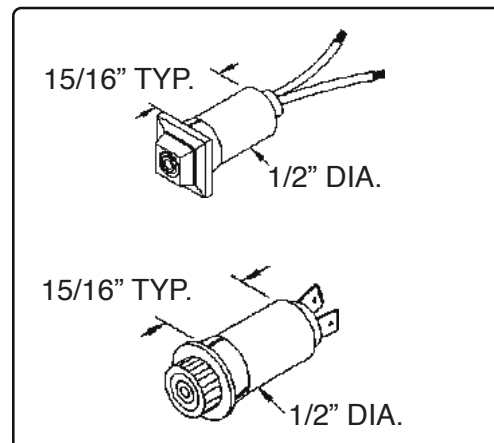

## Flat Cylindrical Lens without Bezel - Neon or Incandescent



Flat Cylindrical Style  
Without bezel.

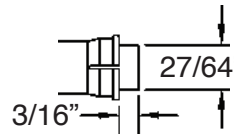

| Part Number<br>6" Wire Leads | Part Number<br>3/16" Tab Terminals | Lens Color | Lamp Type    | Design Volts | Design Watts<br>or Amps | Life (hrs) |
|------------------------------|------------------------------------|------------|--------------|--------------|-------------------------|------------|
| 32-2111                      | 32-2111T                           | Red        | Neon         | 125          | 1/3W                    | 25,000     |
| 35-2111                      | 35-2111T                           | Red        | Neon         | 250          | 1/3W                    | 25,000     |
| 32G1-2111                    | 32G1-2111T                         | Red        | Incandescent | 6            | .20A                    | 5,000      |
| 32G3-2111                    | 32G3-2111T                         | Red        | Incandescent | 14           | .10A                    | 10,000     |
| 32G18-2111                   | 32G18-2111T                        | Red        | Incandescent | 28           | .04A                    | 7,000      |
| 32-2112                      | 32-2112T                           | Green      | Neon         | 125          | 1/3W                    | 25,000     |
| 35-2112                      | 35-2112T                           | Green      | Neon         | 250          | 1/3W                    | 25,000     |
| 32G1-2112                    | 32G1-2112T                         | Green      | Incandescent | 6            | .20A                    | 5,000      |
| 32G3-2112                    | 32G3-2112T                         | Green      | Incandescent | 14           | .10A                    | 10,000     |
| 32G18-2112                   | 32G18-2112T                        | Green      | Incandescent | 28           | .04A                    | 7,000      |
| 32-2113                      | 32-2113T                           | Amber      | Neon         | 125          | 1/3W                    | 25,000     |
| 35-2113                      | 35-2113T                           | Amber      | Neon         | 250          | 1/3W                    | 25,000     |
| 32G1-2113                    | 32G1-2113T                         | Amber      | Incandescent | 6            | .20A                    | 5,000      |
| 32G3-2113                    | 32G3-2113T                         | Amber      | Incandescent | 14           | .10A                    | 10,000     |
| 32G18-2113                   | 32G18-2113T                        | Amber      | Incandescent | 28           | .04A                    | 7,000      |
| 32-2114                      | 32-2114T                           | Blue       | Neon         | 125          | 1/3W                    | 25,000     |
| 35-2114                      | 35-2114T                           | Blue       | Neon         | 250          | 1/3W                    | 25,000     |
| 32G1-2114                    | 32G1-2114T                         | Blue       | Incandescent | 6            | .20A                    | 5,000      |
| 32G3-2114                    | 32G3-2114T                         | Blue       | Incandescent | 14           | .10A                    | 10,000     |
| 32G18-2114                   | 32G18-2114T                        | Blue       | Incandescent | 28           | .04A                    | 7,000      |
| 32-2115                      | 32-2115T                           | White      | Neon         | 125          | 1/3W                    | 25,000     |
| 35-2115                      | 35-2115T                           | White      | Neon         | 250          | 1/3W                    | 25,000     |
| 32G1-2115                    | 32G1-2115T                         | White      | Incandescent | 6            | .20A                    | 5,000      |
| 32G3-2115                    | 32G3-2115T                         | White      | Incandescent | 14           | .10A                    | 10,000     |
| 32G18-2115                   | 32G18-2115T                        | White      | Incandescent | 28           | .04A                    | 7,000      |
| 32-2117                      | 32-2117T                           | Clear      | Neon         | 125          | 1/3W                    | 25,000     |
| 32-2117                      | 32-2117T                           | Clear      | Neon         | 250          | 1/3W                    | 25,000     |
| 32G1-2117                    | 32G1-2117T                         | Clear      | Incandescent | 6            | .20A                    | 5,000      |
| 32G3-2117                    | 32G3-2117T                         | Clear      | Incandescent | 14           | .10A                    | 10,000     |
| 32G18-2117                   | 32G18-2117T                        | Clear      | Incandescent | 28           | .04A                    | 7,000      |

## Flat Cylindrical Lens Nickel Plated Bezel - Neon or Incandescent



**Flat Cylindrical Lens Style**  
With bezel.



| Part Number<br>6" Wire Leads | Part Number<br>3/16" Tab Terminals | Lens Color | Lamp Type    | Design Volts | Design Watts<br>or Amps | Life (hrs) |
|------------------------------|------------------------------------|------------|--------------|--------------|-------------------------|------------|
| 32R-2111                     | 32R-2111T                          | Red        | Neon         | 125          | 1/3W                    | 25,000     |
| 35R-2111                     | 35R-2111T                          | Red        | Neon         | 250          | 1/3W                    | 25,000     |
| 32RG1-2111                   | 32RG1-2111T                        | Red        | Incandescent | 6            | .20A                    | 5,000      |
| 32RG3-2111                   | 32RG3-2111T                        | Red        | Incandescent | 14           | .10A                    | 10,000     |
| 32RG18-2111                  | 32RG18-2111T                       | Red        | Incandescent | 28           | .04A                    | 7,000      |
| 32R-2112                     | 32R-2112T                          | Green      | Neon         | 125          | 1/3W                    | 25,000     |
| 35R-2112                     | 35R-2112T                          | Green      | Neon         | 250          | 1/3W                    | 25,000     |
| 32RG1-2112                   | 32RG1-2112T                        | Green      | Incandescent | 6            | .20A                    | 5,000      |
| 32RG3-2112                   | 32RG3-2112T                        | Green      | Incandescent | 14           | .10A                    | 10,000     |
| 32RG18-2112                  | 32RG18-2112T                       | Green      | Incandescent | 28           | .04A                    | 7,000      |
| 32R-2113                     | 32R-2113T                          | Amber      | Neon         | 125          | 1/3W                    | 25,000     |
| 35R-2113                     | 35R-2113T                          | Amber      | Neon         | 250          | 1/3W                    | 25,000     |
| 32RG1-2113                   | 32RG1-2113T                        | Amber      | Incandescent | 6            | .20A                    | 5,000      |
| 32RG3-2113                   | 32RG3-2113T                        | Amber      | Incandescent | 14           | .10A                    | 10,000     |
| 32RG18-2113                  | 32RG18-2113T                       | Amber      | Incandescent | 28           | .04A                    | 7,000      |
| 32R-2114                     | 32R-2114T                          | Blue       | Neon         | 125          | 1/3W                    | 25,000     |
| 35R-2114                     | 35R-2114T                          | Blue       | Neon         | 250          | 1/3W                    | 25,000     |
| 32RG1-2114                   | 32RG1-2114T                        | Blue       | Incandescent | 6            | .20A                    | 5,000      |
| 32RG3-2114                   | 32RG3-2114T                        | Blue       | Incandescent | 14           | .10A                    | 10,000     |
| 32RG18-2114                  | 32RG18-2114T                       | Blue       | Incandescent | 28           | .04A                    | 7,000      |
| 32R-2115                     | 32R-2115T                          | White      | Neon         | 125          | 1/3W                    | 25,000     |
| 35R-2115                     | 35R-2115T                          | White      | Neon         | 250          | 1/3W                    | 25,000     |
| 32RG1-2115                   | 32RG1-2115T                        | White      | Incandescent | 6            | .20A                    | 5,000      |
| 32RG3-2115                   | 32RG3-2115T                        | White      | Incandescent | 14           | .10A                    | 10,000     |
| 32RG18-2115                  | 32RG18-2115T                       | White      | Incandescent | 28           | .04A                    | 7,000      |
| 32R-2117                     | 32R-2117T                          | Clear      | Neon         | 125          | 1/3W                    | 25,000     |
| 32R-2117                     | 32R-2117T                          | Clear      | Neon         | 250          | 1/3W                    | 25,000     |
| 32RG1-2117                   | 32RG1-2117T                        | Clear      | Incandescent | 6            | .20A                    | 5,000      |
| 32RG3-2117                   | 32RG3-2117T                        | Clear      | Incandescent | 14           | .10A                    | 10,000     |
| 32RG18-2117                  | 32RG18-2117T                       | Clear      | Incandescent | 28           | .04A                    | 7,000      |

## Dome Lens without Bezel - Neon or Incandescent



**Dome Lens Style**  
Without bezel.

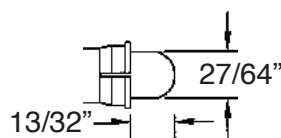

| Part Number<br>6" Wire Leads | Part Number<br>3/16" Tab Terminals | Lens Color | Lamp Type    | Design Volts | Design Watts<br>or Amps | Life (hrs) |
|------------------------------|------------------------------------|------------|--------------|--------------|-------------------------|------------|
| 32-2211                      | 32-2211T                           | Red        | Neon         | 125          | 1/3W                    | 25,000     |
| 35-2211                      | 35-2211T                           | Red        | Neon         | 250          | 1/3W                    | 25,000     |
| 32G1-2211                    | 32G1-2211T                         | Red        | Incandescent | 6            | .20A                    | 5,000      |
| 32G3-2211                    | 32G3-2211T                         | Red        | Incandescent | 14           | .10A                    | 10,000     |
| 32G18-2211                   | 32G18-2211T                        | Red        | Incandescent | 28           | .04A                    | 7,000      |
| 32-2212                      | 32-2212T                           | Green      | Neon         | 125          | 1/3W                    | 25,000     |
| 35-2212                      | 35-2212T                           | Green      | Neon         | 250          | 1/3W                    | 25,000     |
| 32G1-2212                    | 32G1-2212T                         | Green      | Incandescent | 6            | .20A                    | 5,000      |
| 32G3-2212                    | 32G3-2212T                         | Green      | Incandescent | 14           | .10A                    | 10,000     |
| 32G18-2212                   | 32G18-2212T                        | Green      | Incandescent | 28           | .04A                    | 7,000      |
| 32-2213                      | 32-2213T                           | Amber      | Neon         | 125          | 1/3W                    | 25,000     |
| 35-2213                      | 35-2213T                           | Amber      | Neon         | 250          | 1/3W                    | 25,000     |
| 32G1-2213                    | 32G1-2213T                         | Amber      | Incandescent | 6            | .20A                    | 5,000      |
| 32G3-2213                    | 32G3-2213T                         | Amber      | Incandescent | 14           | .10A                    | 10,000     |
| 32G18-2213                   | 32G18-2213T                        | Amber      | Incandescent | 28           | .04A                    | 7,000      |
| 32-2214                      | 32-2214T                           | Blue       | Neon         | 125          | 1/3W                    | 25,000     |
| 35-2214                      | 35-2214T                           | Blue       | Neon         | 250          | 1/3W                    | 25,000     |
| 32G1-2214                    | 32G1-2214T                         | Blue       | Incandescent | 6            | .20A                    | 5,000      |
| 32G3-2214                    | 32G3-2214T                         | Blue       | Incandescent | 14           | .10A                    | 10,000     |
| 32G18-2214                   | 32G18-2214T                        | Blue       | Incandescent | 28           | .04A                    | 7,000      |
| 32-2215                      | 32-2215T                           | White      | Neon         | 125          | 1/3W                    | 25,000     |
| 35-2215                      | 35-2215T                           | White      | Neon         | 250          | 1/3W                    | 25,000     |
| 32G1-2215                    | 32G1-2215T                         | White      | Incandescent | 6            | .20A                    | 5,000      |
| 32G3-2215                    | 32G3-2215T                         | White      | Incandescent | 14           | .10A                    | 10,000     |
| 32G18-2215                   | 32G18-2215T                        | White      | Incandescent | 28           | .04A                    | 7,000      |
| 32-2217                      | 32-2217T                           | Clear      | Neon         | 125          | 1/3W                    | 25,000     |
| 32-2217                      | 32-2217T                           | Clear      | Neon         | 250          | 1/3W                    | 25,000     |
| 32G1-2217                    | 32G1-2217T                         | Clear      | Incandescent | 6            | .20A                    | 5,000      |
| 32G3-2217                    | 32G3-2217T                         | Clear      | Incandescent | 14           | .10A                    | 10,000     |
| 32G18-2217                   | 32G18-2217T                        | Clear      | Incandescent | 28           | .04A                    | 7,000      |

## Dome Lens Nickel Plated Bezel - Neon or Incandescent

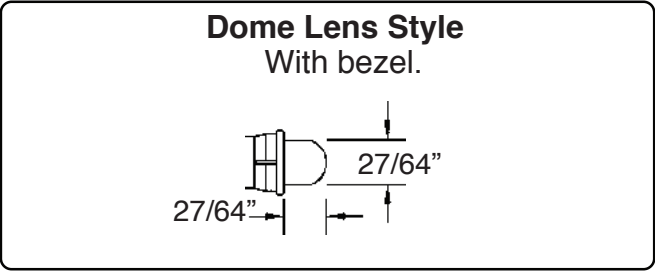

| Part Number<br>6" Wire Leads | Part Number<br>3/16" Tab Terminals | Lens Color | Lamp Type    | Design Volts | Design Watts<br>or Amps | Life (hrs) |
|------------------------------|------------------------------------|------------|--------------|--------------|-------------------------|------------|
| 32R-2211                     | 32R-2211T                          | Red        | Neon         | 125          | 1/3W                    | 25,000     |
| 35R-2211                     | 35R-2211T                          | Red        | Neon         | 250          | 1/3W                    | 25,000     |
| 32RG1-2211                   | 32RG1-2211T                        | Red        | Incandescent | 6            | .20A                    | 5,000      |
| 32RG3-2211                   | 32RG3-2211T                        | Red        | Incandescent | 14           | .10A                    | 10,000     |
| 32RG18-2211                  | 32RG18-2211T                       | Red        | Incandescent | 28           | .04A                    | 7,000      |
| 32R-2212                     | 32R-2212T                          | Green      | Neon         | 125          | 1/3W                    | 25,000     |
| 35R-2212                     | 35R-2212T                          | Green      | Neon         | 250          | 1/3W                    | 25,000     |
| 32RG1-2212                   | 32RG1-2212T                        | Green      | Incandescent | 6            | .20A                    | 5,000      |
| 32RG3-2212                   | 32RG3-2212T                        | Green      | Incandescent | 14           | .10A                    | 10,000     |
| 32RG18-2212                  | 32RG18-2212T                       | Green      | Incandescent | 28           | .04A                    | 7,000      |
| 32R-2213                     | 32R-2213T                          | Amber      | Neon         | 125          | 1/3W                    | 25,000     |
| 35R-2213                     | 35R-2213T                          | Amber      | Neon         | 250          | 1/3W                    | 25,000     |
| 32RG1-2213                   | 32RG1-2213T                        | Amber      | Incandescent | 6            | .20A                    | 5,000      |
| 32RG3-2213                   | 32RG3-2213T                        | Amber      | Incandescent | 14           | .10A                    | 10,000     |
| 32RG18-2213                  | 32RG18-2213T                       | Amber      | Incandescent | 28           | .04A                    | 7,000      |
| 32R-2214                     | 32R-2214T                          | Blue       | Neon         | 125          | 1/3W                    | 25,000     |
| 35R-2214                     | 35R-2214T                          | Blue       | Neon         | 250          | 1/3W                    | 25,000     |
| 32RG1-2214                   | 32RG1-2214T                        | Blue       | Incandescent | 6            | .20A                    | 5,000      |
| 32RG3-2214                   | 32RG3-2214T                        | Blue       | Incandescent | 14           | .10A                    | 10,000     |
| 32RG18-2214                  | 32RG18-2214T                       | Blue       | Incandescent | 28           | .04A                    | 7,000      |
| 32R-2215                     | 32R-2215T                          | White      | Neon         | 125          | 1/3W                    | 25,000     |
| 35R-2215                     | 35R-2215T                          | White      | Neon         | 250          | 1/3W                    | 25,000     |
| 32RG1-2215                   | 32RG1-2215T                        | White      | Incandescent | 6            | .20A                    | 5,000      |
| 32RG3-2215                   | 32RG3-2215T                        | White      | Incandescent | 14           | .10A                    | 10,000     |
| 32RG18-2215                  | 32RG18-2215T                       | White      | Incandescent | 28           | .04A                    | 7,000      |
| 32R-2217                     | 32R-2217T                          | Clear      | Neon         | 125          | 1/3W                    | 25,000     |
| 32R-2217                     | 32R-2217T                          | Clear      | Neon         | 250          | 1/3W                    | 25,000     |
| 32RG1-2217                   | 32RG1-2217T                        | Clear      | Incandescent | 6            | .20A                    | 5,000      |
| 32RG3-2217                   | 32RG3-2217T                        | Clear      | Incandescent | 14           | .10A                    | 10,000     |
| 32RG18-2217                  | 32RG18-2217T                       | Clear      | Incandescent | 28           | .04A                    | 7,000      |

## Flush Lens without Bezel - Neon or Incandescent

### Flush Lens Style Without bezel.



| Part Number<br>6" Wire Leads | Part Number<br>3/16" Tab Terminals | Lens Color | Lamp Type    | Design Volts | Design Watts<br>or Volts | Life (hrs) |
|------------------------------|------------------------------------|------------|--------------|--------------|--------------------------|------------|
| 32-2311                      | 32-2311T                           | Red        | Neon         | 125          | 1/3W                     | 25,000     |
| 35-2311                      | 35-2311T                           | Red        | Neon         | 250          | 1/3W                     | 25,000     |
| 32G1-2311                    | 32G1-2311T                         | Red        | Incandescent | 6            | .20A                     | 5,000      |
| 32G3-2311                    | 32G3-2311T                         | Red        | Incandescent | 14           | .10A                     | 10,000     |
| 32G18-2311                   | 32G18-2311T                        | Red        | Incandescent | 28           | .04A                     | 7,000      |
| 32-2312                      | 32-2312T                           | Green      | Neon         | 125          | 1/3W                     | 25,000     |
| 35-2312                      | 35-2312T                           | Green      | Neon         | 250          | 1/3W                     | 25,000     |
| 32G1-2312                    | 32G1-2312T                         | Green      | Incandescent | 6            | .20A                     | 5,000      |
| 32G3-2312                    | 32G3-2312T                         | Green      | Incandescent | 14           | .10A                     | 10,000     |
| 32G18-2312                   | 32G18-2312T                        | Green      | Incandescent | 28           | .04A                     | 7,000      |
| 32-2313                      | 32-2313T                           | Amber      | Neon         | 125          | 1/3W                     | 25,000     |
| 35-2313                      | 35-2313T                           | Amber      | Neon         | 250          | 1/3W                     | 25,000     |
| 32G1-2313                    | 32G1-2313T                         | Amber      | Incandescent | 6            | .20A                     | 5,000      |
| 32G3-2313                    | 32G3-2313T                         | Amber      | Incandescent | 14           | .10A                     | 10,000     |
| 32G18-2313                   | 32G18-2313T                        | Amber      | Incandescent | 28           | .04A                     | 7,000      |
| 32-2314                      | 32-2314T                           | Blue       | Neon         | 125          | 1/3W                     | 25,000     |
| 35-2314                      | 35-2314T                           | Blue       | Neon         | 250          | 1/3W                     | 25,000     |
| 32G1-2314                    | 32G1-2314T                         | Blue       | Incandescent | 6            | .20A                     | 5,000      |
| 32G3-2314                    | 32G3-2314T                         | Blue       | Incandescent | 14           | .10A                     | 10,000     |
| 32G18-2314                   | 32G18-2314T                        | Blue       | Incandescent | 28           | .04A                     | 7,000      |
| 32-2315                      | 32-2315T                           | White      | Neon         | 125          | 1/3W                     | 25,000     |
| 35-2315                      | 35-2315T                           | White      | Neon         | 250          | 1/3W                     | 25,000     |
| 32G1-2315                    | 32G1-2315T                         | White      | Incandescent | 6            | .20A                     | 5,000      |
| 32G3-2315                    | 32G3-2315T                         | White      | Incandescent | 14           | .10A                     | 10,000     |
| 32G18-2315                   | 32G18-2315T                        | White      | Incandescent | 28           | .04A                     | 7,000      |
| 32-2317                      | 32-2317T                           | Clear      | Neon         | 125          | 1/3W                     | 25,000     |
| 32-2317                      | 32-2317T                           | Clear      | Neon         | 250          | 1/3W                     | 25,000     |
| 32G1-2317                    | 32G1-2317T                         | Clear      | Incandescent | 6            | .20A                     | 5,000      |
| 32G3-2317                    | 32G3-2317T                         | Clear      | Incandescent | 14           | .10A                     | 10,000     |
| 32G18-2317                   | 32G18-2317T                        | Clear      | Incandescent | 28           | .04A                     | 7,000      |



## Flush Lens Nickel Plated Bezel - Neon or Incandescent



**Flush Lens Style**  
Without bezel.

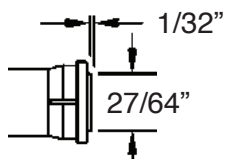

| Part Number<br>6" Wire Leads | Part Number<br>3/16" Tab Terminals | Lens Color | Lamp Type    | Design Volts | Design Watts<br>or Amps | Life (hrs) |
|------------------------------|------------------------------------|------------|--------------|--------------|-------------------------|------------|
| 32R-2311                     | 32R-2311T                          | Red        | Neon         | 125          | 1/3W                    | 25,000     |
| 35R-2311                     | 35R-2311T                          | Red        | Neon         | 250          | 1/3W                    | 25,000     |
| 32RG1-2311                   | 32RG1-2311T                        | Red        | Incandescent | 6            | .20A                    | 5,000      |
| 32RG3-2311                   | 32RG3-2311T                        | Red        | Incandescent | 14           | .10A                    | 10,000     |
| 32RG18-2311                  | 32RG18-2311T                       | Red        | Incandescent | 28           | .04A                    | 7,000      |
| 32R-2312                     | 32R-2312T                          | Green      | Neon         | 125          | 1/3W                    | 25,000     |
| 35R-2312                     | 35R-2312T                          | Green      | Neon         | 250          | 1/3W                    | 25,000     |
| 32RG1-2312                   | 32RG1-2312T                        | Green      | Incandescent | 6            | .20A                    | 5,000      |
| 32RG3-2312                   | 32RG3-2312T                        | Green      | Incandescent | 14           | .10A                    | 10,000     |
| 32RG18-2312                  | 32RG18-2312T                       | Green      | Incandescent | 28           | .04A                    | 7,000      |
| 32R-2313                     | 32R-2313T                          | Amber      | Neon         | 125          | 1/3W                    | 25,000     |
| 35R-2313                     | 35R-2313T                          | Amber      | Neon         | 250          | 1/3W                    | 25,000     |
| 32RG1-2313                   | 32RG1-2313T                        | Amber      | Incandescent | 6            | .20A                    | 5,000      |
| 32RG3-2313                   | 32RG3-2313T                        | Amber      | Incandescent | 14           | .10A                    | 10,000     |
| 32RG18-2313                  | 32RG18-2313T                       | Amber      | Incandescent | 28           | .04A                    | 7,000      |
| 32R-2314                     | 32R-2314T                          | Blue       | Neon         | 125          | 1/3W                    | 25,000     |
| 35R-2314                     | 35R-2314T                          | Blue       | Neon         | 250          | 1/3W                    | 25,000     |
| 32RG1-2314                   | 32RG1-2314T                        | Blue       | Incandescent | 6            | .20A                    | 5,000      |
| 32RG3-2314                   | 32RG3-2314T                        | Blue       | Incandescent | 14           | .10A                    | 10,000     |
| 32RG18-2314                  | 32RG18-2314T                       | Blue       | Incandescent | 28           | .04A                    | 7,000      |
| 32R-2315                     | 32R-2315T                          | White      | Neon         | 125          | 1/3W                    | 25,000     |
| 35R-2315                     | 35R-2315T                          | White      | Neon         | 250          | 1/3W                    | 25,000     |
| 32RG1-2315                   | 32RG1-2315T                        | White      | Incandescent | 6            | .20A                    | 5,000      |
| 32RG3-2315                   | 32RG3-2315T                        | White      | Incandescent | 14           | .10A                    | 10,000     |
| 32RG18-2315                  | 32RG18-2315T                       | White      | Incandescent | 28           | .04A                    | 7,000      |
| 32R-2317                     | 32R-2317T                          | Clear      | Neon         | 125          | 1/3W                    | 25,000     |
| 32R-2317                     | 32R-2317T                          | Clear      | Neon         | 250          | 1/3W                    | 25,000     |
| 32RG1-2317                   | 32RG1-2317T                        | Clear      | Incandescent | 6            | .20A                    | 5,000      |
| 32RG3-2317                   | 32RG3-2317T                        | Clear      | Incandescent | 14           | .10A                    | 10,000     |
| 32RG18-2317                  | 32RG18-2317T                       | Clear      | Incandescent | 28           | .04A                    | 7,000      |

## Hi-Hat Lens without Bezel - Neon or Incandescent

**Hi-Hat Lens Style**  
Without bezel.

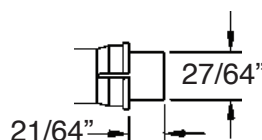

| Part Number<br>6" Wire Leads | Part Number<br>3/16" Tab Terminals | Lens Color | Lamp Type    | Design Volts | Design Watts<br>or Amps | Life (hrs) |
|------------------------------|------------------------------------|------------|--------------|--------------|-------------------------|------------|
| 32-2511                      | 32-2511T                           | Red        | Neon         | 125          | 1/3W                    | 25,000     |
| 35-2511                      | 35-2511T                           | Red        | Neon         | 250          | 1/3W                    | 25,000     |
| 32G1-2511                    | 32G1-2511T                         | Red        | Incandescent | 6            | .20A                    | 5,000      |
| 32G3-2511                    | 32G3-2511T                         | Red        | Incandescent | 14           | .10A                    | 10,000     |
| 32G18-2511                   | 32G18-2511T                        | Red        | Incandescent | 28           | .04A                    | 7,000      |
| 32-2512                      | 32-2512T                           | Green      | Neon         | 125          | 1/3W                    | 25,000     |
| 35-2512                      | 35-2512T                           | Green      | Neon         | 250          | 1/3W                    | 25,000     |
| 32G1-2512                    | 32G1-2512T                         | Green      | Incandescent | 6            | .20A                    | 5,000      |
| 32G3-2512                    | 32G3-2512T                         | Green      | Incandescent | 14           | .10A                    | 10,000     |
| 32G18-2512                   | 32G18-2512T                        | Green      | Incandescent | 28           | .04A                    | 7,000      |
| 32-2513                      | 32-2513T                           | Amber      | Neon         | 125          | 1/3W                    | 25,000     |
| 35-2513                      | 35-2513T                           | Amber      | Neon         | 250          | 1/3W                    | 25,000     |
| 32G1-2513                    | 32G1-2513T                         | Amber      | Incandescent | 6            | .20A                    | 5,000      |
| 32G3-2513                    | 32G3-2513T                         | Amber      | Incandescent | 14           | .10A                    | 10,000     |
| 32G18-2513                   | 32G18-2513T                        | Amber      | Incandescent | 28           | .04A                    | 7,000      |
| 32-2514                      | 32-2514T                           | Blue       | Neon         | 125          | 1/3W                    | 25,000     |
| 35-2514                      | 35-2514T                           | Blue       | Neon         | 250          | 1/3W                    | 25,000     |
| 32G1-2514                    | 32G1-2514T                         | Blue       | Incandescent | 6            | .20A                    | 5,000      |
| 32G3-2514                    | 32G3-2514T                         | Blue       | Incandescent | 14           | .10A                    | 10,000     |
| 32G18-2514                   | 32G18-2514T                        | Blue       | Incandescent | 28           | .04A                    | 7,000      |
| 32-2515                      | 32-2515T                           | White      | Neon         | 125          | 1/3W                    | 25,000     |
| 35-2515                      | 35-2515T                           | White      | Neon         | 250          | 1/3W                    | 25,000     |
| 32G1-2515                    | 32G1-2515T                         | White      | Incandescent | 6            | .20A                    | 5,000      |
| 32G3-2515                    | 32G3-2515T                         | White      | Incandescent | 14           | .10A                    | 10,000     |
| 32G18-2515                   | 32G18-2515T                        | White      | Incandescent | 28           | .04A                    | 7,000      |
| 32-2517                      | 32-2517T                           | Clear      | Neon         | 125          | 1/3W                    | 25,000     |
| 32-2517                      | 32-2517T                           | Clear      | Neon         | 250          | 1/3W                    | 25,000     |
| 32G1-2517                    | 32G1-2517T                         | Clear      | Incandescent | 6            | .20A                    | 5,000      |
| 32G3-2517                    | 32G3-2517T                         | Clear      | Incandescent | 14           | .10A                    | 10,000     |
| 32G18-2517                   | 32G18-2517T                        | Clear      | Incandescent | 28           | .04A                    | 7,000      |



## Hi-Hat Lens Nickel Plated Bezel - Neon or Incandescent

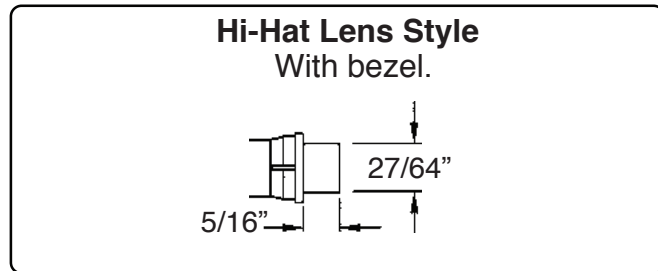

| Part Number<br>6" Wire Leads | Part Number<br>3/16" Tab Terminals | Lens Color | Lamp Type    | Design Volts | Design Watts<br>or Amps | Life (hrs) |
|------------------------------|------------------------------------|------------|--------------|--------------|-------------------------|------------|
| 32R-2511                     | 32R-2511T                          | Red        | Neon         | 125          | 1/3W                    | 25,000     |
| 35R-2511                     | 35R-2511T                          | Red        | Neon         | 250          | 1/3W                    | 25,000     |
| 32RG1-2511                   | 32RG1-2511T                        | Red        | Incandescent | 6            | .20A                    | 5,000      |
| 32RG3-2511                   | 32RG3-2511T                        | Red        | Incandescent | 14           | .10A                    | 10,000     |
| 32RG18-2511                  | 32RG18-2511T                       | Red        | Incandescent | 28           | .04A                    | 7,000      |
| 32R-2512                     | 32R-2512T                          | Green      | Neon         | 125          | 1/3W                    | 25,000     |
| 35R-2512                     | 35R-2512T                          | Green      | Neon         | 250          | 1/3W                    | 25,000     |
| 32RG1-2512                   | 32RG1-2512T                        | Green      | Incandescent | 6            | .20A                    | 5,000      |
| 32RG3-2512                   | 32RG3-2512T                        | Green      | Incandescent | 14           | .10A                    | 10,000     |
| 32RG18-2512                  | 32RG18-2512T                       | Green      | Incandescent | 28           | .04A                    | 7,000      |
| 32R-2513                     | 32R-2513T                          | Amber      | Neon         | 125          | 1/3W                    | 25,000     |
| 35R-2513                     | 35R-2513T                          | Amber      | Neon         | 250          | 1/3W                    | 25,000     |
| 32RG1-2513                   | 32RG1-2513T                        | Amber      | Incandescent | 6            | .20A                    | 5,000      |
| 32RG3-2513                   | 32RG3-2513T                        | Amber      | Incandescent | 14           | .10A                    | 10,000     |
| 32RG18-2513                  | 32RG18-2513T                       | Amber      | Incandescent | 28           | .04A                    | 7,000      |
| 32R-2514                     | 32R-2514T                          | Blue       | Neon         | 125          | 1/3W                    | 25,000     |
| 35R-2514                     | 35R-2514T                          | Blue       | Neon         | 250          | 1/3W                    | 25,000     |
| 32RG1-2514                   | 32RG1-2514T                        | Blue       | Incandescent | 6            | .20A                    | 5,000      |
| 32RG3-2514                   | 32RG3-2514T                        | Blue       | Incandescent | 14           | .10A                    | 10,000     |
| 32RG18-2514                  | 32RG18-2514T                       | Blue       | Incandescent | 28           | .04A                    | 7,000      |
| 32R-2515                     | 32R-2515T                          | White      | Neon         | 125          | 1/3W                    | 25,000     |
| 35R-2515                     | 35R-2515T                          | White      | Neon         | 250          | 1/3W                    | 25,000     |
| 32RG1-2515                   | 32RG1-2515T                        | White      | Incandescent | 6            | .20A                    | 5,000      |
| 32RG3-2515                   | 32RG3-2515T                        | White      | Incandescent | 14           | .10A                    | 10,000     |
| 32RG18-2515                  | 32RG18-2515T                       | White      | Incandescent | 28           | .04A                    | 7,000      |
| 32R-2517                     | 32R-2517T                          | Clear      | Neon         | 125          | 1/3W                    | 25,000     |
| 32R-2517                     | 32R-2517T                          | Clear      | Neon         | 250          | 1/3W                    | 25,000     |
| 32RG1-2517                   | 32RG1-2517T                        | Clear      | Incandescent | 6            | .20A                    | 5,000      |
| 32RG3-2517                   | 32RG3-2517T                        | Clear      | Incandescent | 14           | .10A                    | 10,000     |
| 32RG18-2517                  | 32RG18-2517T                       | Clear      | Incandescent | 28           | .04A                    | 7,000      |

## Square Lens Nickel Plated Bezel - Neon or Incandescent

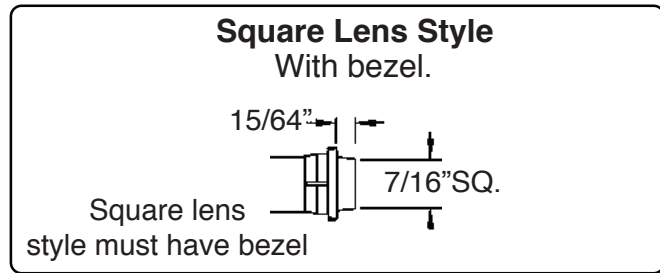
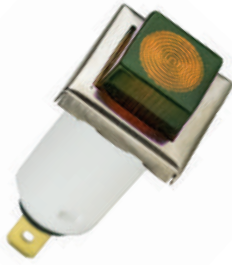

| Part Number<br>6" Wire Leads | Part Number<br>3/16" Tab Terminals | Lens Color | Lamp Type    | Design Volts | Design Watts<br>or Amps | Life (hrs) |
|------------------------------|------------------------------------|------------|--------------|--------------|-------------------------|------------|
| 32R-2911                     | 32R-2911T                          | Red        | Neon         | 125          | 1/3W                    | 25,000     |
| 35R-2911                     | 35R-2911T                          | Red        | Neon         | 250          | 1/3W                    | 25,000     |
| 32RG1-2911                   | 32RG1-2911T                        | Red        | Incandescent | 6            | .20A                    | 5,000      |
| 32RG3-2911                   | 32RG3-2911T                        | Red        | Incandescent | 14           | .10A                    | 10,000     |
| 32RG18-2911                  | 32RG18-2911T                       | Red        | Incandescent | 28           | .04A                    | 7,000      |
| 32R-2912                     | 32R-2912T                          | Green      | Neon         | 125          | 1/3W                    | 25,000     |
| 35R-2912                     | 35R-2912T                          | Green      | Neon         | 250          | 1/3W                    | 25,000     |
| 32RG1-2912                   | 32RG1-2912T                        | Green      | Incandescent | 6            | .20A                    | 5,000      |
| 32RG3-2912                   | 32RG3-2912T                        | Green      | Incandescent | 14           | .10A                    | 10,000     |
| 32RG18-2912                  | 32RG18-2912T                       | Green      | Incandescent | 28           | .04A                    | 7,000      |
| 32R-2913                     | 32R-2913T                          | Amber      | Neon         | 125          | 1/3W                    | 25,000     |
| 35R-2913                     | 35R-2913T                          | Amber      | Neon         | 250          | 1/3W                    | 25,000     |
| 32RG1-2913                   | 32RG1-2913T                        | Amber      | Incandescent | 6            | .20A                    | 5,000      |
| 32RG3-2913                   | 32RG3-2913T                        | Amber      | Incandescent | 14           | .10A                    | 10,000     |
| 32RG18-2913                  | 32RG18-2913T                       | Amber      | Incandescent | 28           | .04A                    | 7,000      |
| 32R-2914                     | 32R-2914T                          | Blue       | Neon         | 125          | 1/3W                    | 25,000     |
| 35R-2914                     | 35R-2914T                          | Blue       | Neon         | 250          | 1/3W                    | 25,000     |
| 32RG1-2914                   | 32RG1-2914T                        | Blue       | Incandescent | 6            | .20A                    | 5,000      |
| 32RG3-2914                   | 32RG3-2914T                        | Blue       | Incandescent | 14           | .10A                    | 10,000     |
| 32RG18-2914                  | 32RG18-2914T                       | Blue       | Incandescent | 28           | .04A                    | 7,000      |
| 32R-2915                     | 32R-2915T                          | White      | Neon         | 125          | 1/3W                    | 25,000     |
| 35R-2915                     | 35R-2915T                          | White      | Neon         | 250          | 1/3W                    | 25,000     |
| 32RG1-2915                   | 32RG1-2915T                        | White      | Incandescent | 6            | .20A                    | 5,000      |
| 32RG3-2915                   | 32RG3-2915T                        | White      | Incandescent | 14           | .10A                    | 10,000     |
| 32RG18-2915                  | 32RG18-2915T                       | White      | Incandescent | 28           | .04A                    | 7,000      |
| 32R-2917                     | 32R-2917T                          | Clear      | Neon         | 125          | 1/3W                    | 25,000     |
| 32R-2917                     | 32R-2917T                          | Clear      | Neon         | 250          | 1/3W                    | 25,000     |
| 32RG1-2917                   | 32RG1-2917T                        | Clear      | Incandescent | 6            | .20A                    | 5,000      |
| 32RG3-2917                   | 32RG3-2917T                        | Clear      | Incandescent | 14           | .10A                    | 10,000     |
| 32RG18-2917                  | 32RG18-2917T                       | Clear      | Incandescent | 28           | .04A                    | 7,000      |

## Flashing Indicators Optional Nickel Plated Bezel

Neon lights are designed with outboard circuitry to provide a flashing action of about 100 times per minute. Flashers are ideal for applications where a warning indicator is desirable. 125 Volt Operation.

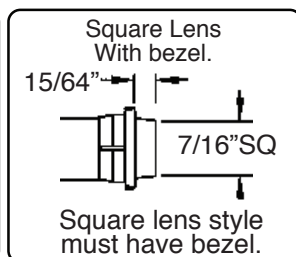
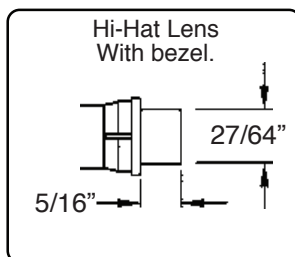
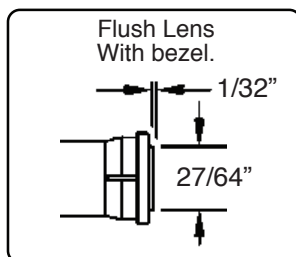
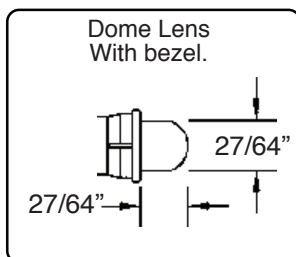
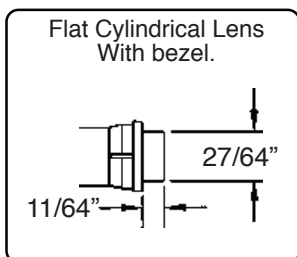

| Part Number Without Bezel | Part Number with Nickel Plated Bezel | Lens Color | Lamp Style       | Design Volts | Design Watts or Amps | Life (hrs) |
|---------------------------|--------------------------------------|------------|------------------|--------------|----------------------|------------|
| 32FL-2111                 | 32FLR-2111                           | Red        | Flat Cylindrical | 125          | 1/3W                 | 25,000     |
| 32FL-2112                 | 32FLR-2112                           | Green      | Flat Cylindrical | 125          | 1/3W                 | 25,000     |
| 32FL-2113                 | 32FLR-2113                           | Amber      | Flat Cylindrical | 125          | 1/3W                 | 25,000     |
| 32FL-2114                 | 32FLR-2114                           | Blue       | Flat Cylindrical | 125          | 1/3W                 | 25,000     |
| 32FL-2115                 | 32FLR-2115                           | White      | Flat Cylindrical | 125          | 1/3W                 | 25,000     |
| 32FL-2117                 | 32FLR-2117                           | Clear      | Flat Cylindrical | 125          | 1/3W                 | 25,000     |
| 32FL-2211                 | 32FLR-2211                           | Red        | Dome             | 125          | 1/3W                 | 25,000     |
| 32FL-2212                 | 32FLR-2212                           | Green      | Dome             | 125          | 1/3W                 | 25,000     |
| 32FL-2213                 | 32FLR-2213                           | Amber      | Dome             | 125          | 1/3W                 | 25,000     |
| 32FL-2214                 | 32FLR-2214                           | Blue       | Dome             | 125          | 1/3W                 | 25,000     |
| 32FL-2215                 | 32FLR-2215                           | White      | Dome             | 125          | 1/3W                 | 25,000     |
| 32FL-2217                 | 32FLR-2217                           | Clear      | Dome             | 125          | 1/3W                 | 25,000     |
| 32FL-2311                 | 32FLR-2311                           | Red        | Flush            | 125          | 1/3W                 | 25,000     |
| 32FL-2312                 | 32FLR-2312                           | Green      | Flush            | 125          | 1/3W                 | 25,000     |
| 32FL-2313                 | 32FLR-2313                           | Amber      | Flush            | 125          | 1/3W                 | 25,000     |
| 32FL-2314                 | 32FLR-2314                           | Blue       | Flush            | 125          | 1/3W                 | 25,000     |
| 32FL-2315                 | 32FLR-2315                           | White      | Flush            | 125          | 1/3W                 | 25,000     |
| 32FL-2317                 | 32FLR-2317                           | Clear      | Flush            | 125          | 1/3W                 | 25,000     |
| 32FL-2511                 | 32FLR-2511                           | Red        | Hi-Hat           | 125          | 1/3W                 | 25,000     |
| 32FL-2512                 | 32FLR-2512                           | Green      | Hi-Hat           | 125          | 1/3W                 | 25,000     |
| 32FL-2513                 | 32FLR-2513                           | Amber      | Hi-Hat           | 125          | 1/3W                 | 25,000     |
| 32FL-2514                 | 32FLR-2514                           | Blue       | Hi-Hat           | 125          | 1/3W                 | 25,000     |
| 32FL-2515                 | 32FLR-2515                           | White      | Hi-Hat           | 125          | 1/3W                 | 25,000     |
| 32FL-2517                 | 32FLR-2517                           | Clear      | Hi-Hat           | 125          | 1/3W                 | 25,000     |
| N/A                       | 32FLR-2911                           | Red        | Square           | 125          | 1/3W                 | 25,000     |
| N/A                       | 32FLR-2912                           | Green      | Square           | 125          | 1/3W                 | 25,000     |
| N/A                       | 32FLR-2913                           | Amber      | Square           | 125          | 1/3W                 | 25,000     |
| N/A                       | 32FLR-2914                           | Blue       | Square           | 125          | 1/3W                 | 25,000     |
| N/A                       | 32FLR-2915                           | White      | Square           | 125          | 1/3W                 | 25,000     |
| N/A                       | 32FLR-2917                           | Clear      | Square           | 125          | 1/3W                 | 25,000     |

## 35XK Series - 600 Design Volts Neon Indicators - White Housing



Square lens style must have bezel.

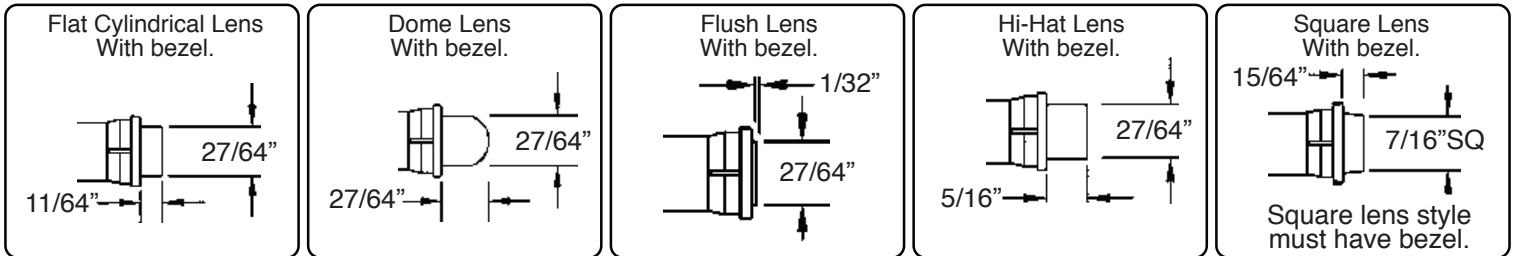

| Part Number Without Bezel | Part Number with Nickel Plated Bezel | Lens Color | Lamp Style       | Design Volts | Design Watts | Life (hrs) |
|---------------------------|--------------------------------------|------------|------------------|--------------|--------------|------------|
| 35XK-2111                 | 35RXK-2111                           | Red        | Flat Cylindrical | 600          | 1/3W         | 25,000     |
| 35XK-2112                 | 35RXK-2112                           | Green      | Flat Cylindrical | 600          | 1/3W         | 25,000     |
| 35XK-2113                 | 35RXK-2113                           | Amber      | Flat Cylindrical | 600          | 1/3W         | 25,000     |
| 35XK-2114                 | 35RXK-2114                           | Blue       | Flat Cylindrical | 600          | 1/3W         | 25,000     |
| 35XK-2115                 | 35RXK-2115                           | White      | Flat Cylindrical | 600          | 1/3W         | 25,000     |
| 35XK-2117                 | 35RXK-2117                           | Clear      | Flat Cylindrical | 600          | 1/3W         | 25,000     |
| 35XK-2211                 | 35RXK-2211                           | Red        | Dome             | 600          | 1/3W         | 25,000     |
| 35XK-2212                 | 35RXK-2212                           | Green      | Dome             | 600          | 1/3W         | 25,000     |
| 35XK-2213                 | 35RXK-2213                           | Amber      | Dome             | 600          | 1/3W         | 25,000     |
| 35XK-2214                 | 35RXK-2214                           | Blue       | Dome             | 600          | 1/3W         | 25,000     |
| 35XK-2215                 | 35RXK-2215                           | White      | Dome             | 600          | 1/3W         | 25,000     |
| 35XK-2217                 | 35RXK-2217                           | Clear      | Dome             | 600          | 1/3W         | 25,000     |
| 35XK-2311                 | 35RXK-2311                           | Red        | Flush            | 600          | 1/3W         | 25,000     |
| 35XK-2312                 | 35RXK-2312                           | Green      | Flush            | 600          | 1/3W         | 25,000     |
| 35XK-2313                 | 35RXK-2313                           | Amber      | Flush            | 600          | 1/3W         | 25,000     |
| 35XK-2314                 | 35RXK-2314                           | Blue       | Flush            | 600          | 1/3W         | 25,000     |
| 35XK-2315                 | 35RXK-2315                           | White      | Flush            | 600          | 1/3W         | 25,000     |
| 35XK-2317                 | 35RXK-2317                           | Clear      | Flush            | 600          | 1/3W         | 25,000     |
| 35XK-2511                 | 35RXK-2511                           | Red        | Hi-Hat           | 600          | 1/3W         | 25,000     |
| 35XK-2512                 | 35RXK-2512                           | Green      | Hi-Hat           | 600          | 1/3W         | 25,000     |
| 35XK-2513                 | 35RXK-2513                           | Amber      | Hi-Hat           | 600          | 1/3W         | 25,000     |
| 35XK-2514                 | 35RXK-2514                           | Blue       | Hi-Hat           | 600          | 1/3W         | 25,000     |
| 35XK-2515                 | 35RXK-2515                           | White      | Hi-Hat           | 600          | 1/3W         | 25,000     |
| 35XK-2517                 | 35RXK-2517                           | Clear      | Hi-Hat           | 600          | 1/3W         | 25,000     |
| N/A                       | 35RXK-2911                           | Red        | Square           | 600          | 1/3W         | 25,000     |
| N/A                       | 35RXK-2912                           | Green      | Square           | 600          | 1/3W         | 25,000     |
| N/A                       | 35RXK-2913                           | Amber      | Square           | 600          | 1/3W         | 25,000     |
| N/A                       | 35RXK-2914                           | Blue       | Square           | 600          | 1/3W         | 25,000     |
| N/A                       | 35RXK-2915                           | White      | Square           | 600          | 1/3W         | 25,000     |
| N/A                       | 35RXK-2917                           | Clear      | Square           | 600          | 1/3W         | 25,000     |

## L32/35 Series - LED Indicator Light White Housing 2 to 125 Design Volts



| Part Number With Flat Cylindrical Lens | Part Number With Dome Lens | Part Number With Flush Lens | Part Number With Hi-Hat Lens | Part Number With Square Lens | Lens Color | DC Design Volts<br>*AC Design Volts |
|--|----------------------------|-----------------------------|------------------------------|------------------------------|------------|-------------------------------------|
| L32R-A2-2113                           | L32R-A2-2213               | L32R-A2-2313                | L32R-A2-2513                 | L32R-A2-2913                 | Amber      | 2                                   |
| L32R-A6-2113                           | L32R-A6-2213               | L32R-A6-2313                | L32R-A6-2513                 | L32R-A6-2913                 | Amber      | 6                                   |
| L32R-A12-2113                          | L32R-A12-2213              | L32R-A12-2313               | L32R-A12-2513                | L32R-A12-2913                | Amber      | 12                                  |
| L32R-A24-2113                          | L32R-A24-2213              | L32R-A24-2313               | L32R-A24-2513                | L32R-A24-2913                | Amber      | 24                                  |
| L32R-A125-2113                         | L32R-A125-2213             | L32R-A125-2313              | L32R-A125-2513               | L32R-A125-2913               | Amber      | 125*                                |
| L32R-G2-2112                           | L32R-G2-2212               | L32R-G2-2312                | L32R-G2-2512                 | L32R-G2-2912                 | Green      | 2                                   |
| L32R-G6-2112                           | L32R-G6-2212               | L32R-G6-2312                | L32R-G6-2512                 | L32R-G6-2912                 | Green      | 6                                   |
| L32R-G12-2112                          | L32R-G12-2212              | L32R-G12-2312               | L32R-G12-2512                | L32R-G12-2912                | Green      | 12                                  |
| L32R-G24-2112                          | L32R-G24-2212              | L32R-G24-2312               | L32R-G24-2512                | L32R-G24-2912                | Green      | 24                                  |
| L32R-G125-2112                         | L32R-G125-2212             | L32R-G125-2312              | L32R-G125-2512               | L32R-G125-2912               | Green      | 125*                                |
| L32R-R2-2111                           | L32R-R2-2211               | L32R-R2-2311                | L32R-R2-2511                 | L32R-R2-2911                 | Red        | 2                                   |
| L32R-R6-2111                           | L32R-R6-2211               | L32R-R6-2311                | L32R-R6-2511                 | L32R-R6-2911                 | Red        | 6                                   |
| L32R-R12-2111                          | L32R-R12-2211              | L32R-R12-2311               | L32R-R12-2511                | L32R-R12-2911                | Red        | 12                                  |
| L32R-R24-2111                          | L32R-R24-2211              | L32R-R24-2311               | L32R-R24-2511                | L32R-R24-2911                | Red        | 24                                  |
| L32R-R125-2111                         | L32R-R125-2211             | L32R-R125-2311              | L32R-R125-2511               | L32R-R125-2911               | Red        | 125*                                |
| L32R-Y2-2116                           | L32R-Y2-2216               | L32R-Y2-2316                | L32R-Y2-2516                 | L32R-Y2-2916                 | Yellow     | 2                                   |
| L32R-Y6-2116                           | L32R-Y6-2216               | L32R-Y6-2316                | L32R-Y6-2516                 | L32R-Y6-2916                 | Yellow     | 6                                   |
| L32R-Y12-2116                          | L32R-Y12-2216              | L32R-Y12-2316               | L32R-Y12-2516                | L32R-Y12-2916                | Yellow     | 12                                  |
| L32R-Y24-2116                          | L32R-Y24-2216              | L32R-Y24-2316               | L32R-Y24-2516                | L32R-Y24-2916                | Yellow     | 24                                  |
| L32R-Y125-2116                         | L32R-Y125-2216             | L32R-Y125-2316              | L32R-Y125-2516               | L32R-Y125-2916               | Yellow     | 125*                                |

**Polarity Determination - Wire Leads:** Red wire lead denotes anode(+); black wire lead denote cathode (-).

**Terminals:** One terminal is tin-plated to denote anode(+); unplated terminal refer to cathode(-)

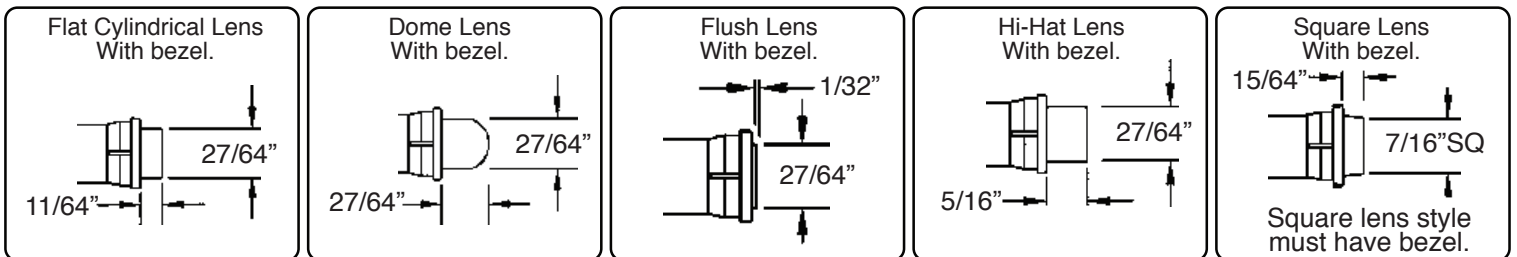

## L32 Series - LED Indicator Light White Housing 2 to 24 Design Volts

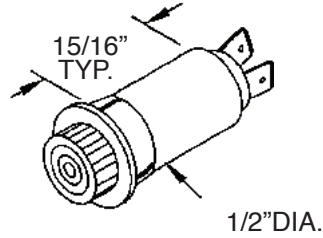

| Part Number With Flat Cylindrical Lens | Part Number With Dome Lens | Part Number With Flush Lens | Part Number With Hi-Hat Lens | Part Number With Square Lens | Lens Color | DC Design Volts |
|--|----------------------------|-----------------------------|------------------------------|------------------------------|------------|-----------------|
| L32R-A2-2113T                          | L32R-A2-2213T              | L32R-A2-2313T               | L32R-A2-2513T                | L32R-A2-2913T                | Amber      | 2               |
| L32R-A6-2113T                          | L32R-A6-2213T              | L32R-A6-2313T               | L32R-A6-2513T                | L32R-A6-2913T                | Amber      | 6               |
| L32R-A12-2113T                         | L32R-A12-2213T             | L32R-A12-2313T              | L32R-A12-2513T               | L32R-A12-2913T               | Amber      | 12              |
| L32R-A24-2113T                         | L32R-A24-2213T             | L32R-A24-2313T              | L32R-A24-2513T               | L32R-A24-2913T               | Amber      | 24              |
| L32R-A125-2112T                        | L32R-A125-2212T            | L32R-A125-2312T             | L32R-A125-2512T              | L32R-A125-2912T              | Green      | 2               |
| L32R-G2-2112T                          | L32R-G2-2212T              | L32R-G2-2312T               | L32R-G2-2512T                | L32R-G2-2912T                | Green      | 6               |
| L32R-G6-2112T                          | L32R-G6-2212T              | L32R-G6-2312T               | L32R-G6-2512T                | L32R-G6-2912T                | Green      | 12              |
| L32R-G12-2112T                         | L32R-G12-2212T             | L32R-G12-2312T              | L32R-G12-2512T               | L32R-G12-2912T               | Green      | 24              |
| L32R-G24-2111T                         | L32R-G24-2211T             | L32R-G24-2311T              | L32R-G24-2511T               | L32R-G24-2911T               | Red        | 2               |
| L32R-G125-2111T                        | L32R-G125-2211T            | L32R-G125-2311T             | L32R-G125-2511T              | L32R-G125-2911T              | Red        | 6               |
| L32R-R2-2111T                          | L32R-R2-2211T              | L32R-R2-2311T               | L32R-R2-2511T                | L32R-R2-2911T                | Red        | 12              |
| L32R-R6-2111T                          | L32R-R6-2211T              | L32R-R6-2311T               | L32R-R6-2511T                | L32R-R6-2911T                | Red        | 24              |
| L32R-R12-2116T                         | L32R-R12-2216T             | L32R-R12-2316T              | L32R-R12-2516T               | L32R-R12-2916T               | Yellow     | 2               |
| L32R-R24-2116T                         | L32R-R24-2216T             | L32R-R24-2316T              | L32R-R24-2516T               | L32R-R24-2916T               | Yellow     | 6               |
| L32R-R125-2116T                        | L32R-R125-2216T            | L32R-R125-2316T             | L32R-R125-2516T              | L32R-R125-2916T              | Yellow     | 12              |
| L32R-Y2-2116T                          | L32R-Y2-2216T              | L32R-Y2-2316T               | L32R-Y2-2516T                | L32R-Y2-2916T                | Yellow     | 24              |

**Polarity Determination - Wire Leads:** Red wire lead denotes anode(+); black wire lead denote cathode (-).  
**Terminals:** One terminal is tin-plated to denote anode(+); unplated terminal refer to cathode(-)

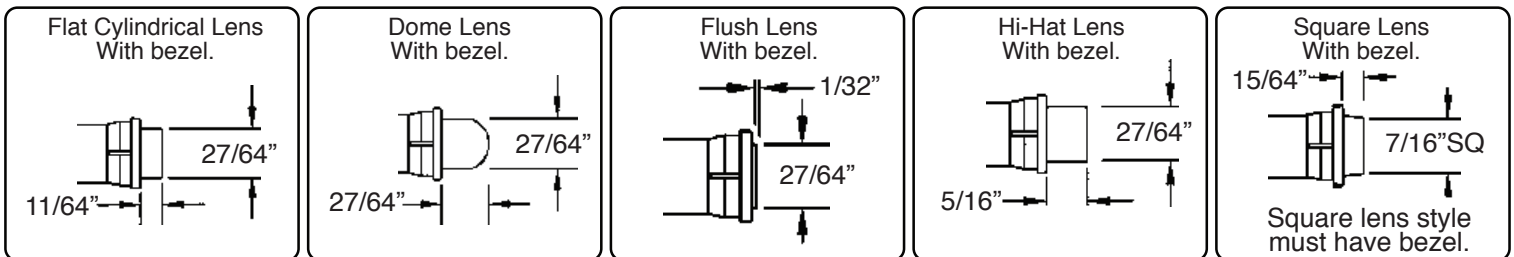



## Данный компонент на территории Российской Федерации

### Вы можете приобрести в компании MosChip.

Для оперативного оформления запроса Вам необходимо перейти по данной ссылке:

<http://moschip.ru/get-element>

Вы можете разместить у нас заказ для любого Вашего проекта, будь то серийное производство или разработка единичного прибора.

В нашем ассортименте представлены ведущие мировые производители активных и пассивных электронных компонентов.

Нашей специализацией является поставка электронной компонентной базы двойного назначения, продукции таких производителей как XILINX, Intel (ex.ALTERA), Vicor, Microchip, Texas Instruments, Analog Devices, Mini-Circuits, Amphenol, Glenair.

Сотрудничество с глобальными дистрибьюторами электронных компонентов, предоставляет возможность заказывать и получать с международных складов практически любой перечень компонентов в оптимальные для Вас сроки.

На всех этапах разработки и производства наши партнеры могут получить квалифицированную поддержку опытных инженеров.

Система менеджмента качества компании отвечает требованиям в соответствии с ГОСТ Р ИСО 9001, ГОСТ РВ 0015-002 и ЭС РД 009

### Офис по работе с юридическими лицами:

105318, г.Москва, ул.Щербаковская д.3, офис 1107, 1118, ДЦ «Щербаковский»

Телефон: +7 495 668-12-70 (многоканальный)

Факс: +7 495 668-12-70 (доб.304)

E-mail: [info@moschip.ru](mailto:info@moschip.ru)

Skype отдела продаж:

moschip.ru

moschip.ru\_4

moschip.ru\_6

moschip.ru\_9