

# Advantages of the 70S2 Series

Since acquiring this line of miniature SSRs from Grayhill, this product has continuously evolved both functionally and visually. The 70S2 Series relays are designed for medium-power loads. The design incorporates a triac output for AC loads and MOSFETs for DC loads. The 70S2 Series relays use optical isolation to protect the control from transients. The 70S2 compact package is available in a combination of screw, fast-on or PCB terminals. Its compact size makes it ideal for designs where space is limited. The 70S2 Series relays have excellent thermal performance.

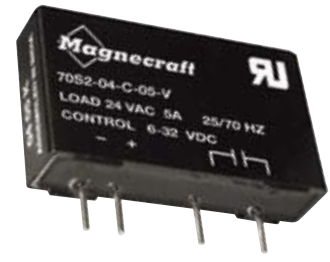

- Switch up to 5 Amps
- Integrated Thermal Management
- PCB Mount

70S2 V (5 Amp)



70S2 V (3 Amp)



- Switch up to 25 Amps
- Screw Terminals
- Panel Mount

70S2 S



- Switch up to 12 Amps
- Blade Terminals
- Panel Mount

70S2 N

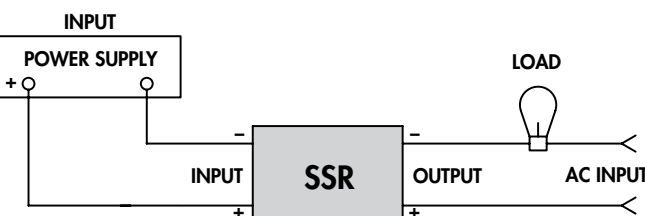

WIRING DIAGRAM

- **Small Packages**  
Ideal for Tight Designs..
- **Eight Different Packages**  
Wide Choice of Design Options.
- **Optically Isolated**  
Input Isolated from Output.
- **Zero Cross Switching**  
Reduced Current Surges for Most Loads.
- **Internal Snubber**  
Excellent Transient Protection.

We're very pleased at the breadth of products and solutions we are able to offer engineers and designers. And this is just the beginning.

We will continue to develop high value products - with innovative features not offered anywhere else in the industry.



**70S2 F**

- Switch up to 4 Amps
- Solder Terminals
- PCB Mount



**70S2 M**

- Switch up to 10 Amps
- Solder Terminals
- PCB/Panel Mount



**70S2 H**

- Switch up to 2.5 Amps
- Solder Terminals
- PCB Mount



**70S2 L**

- Switch up to 6 Amps
- Solder Terminals
- PCB/Panel Mount



**70S2 K**

- Switch up to 4 Amps
- Socket Compatible

## 70S2 Series Solid State Relays/3, 5 Amp, V Style



**UL**  
UL Recognized  
File No. E258297

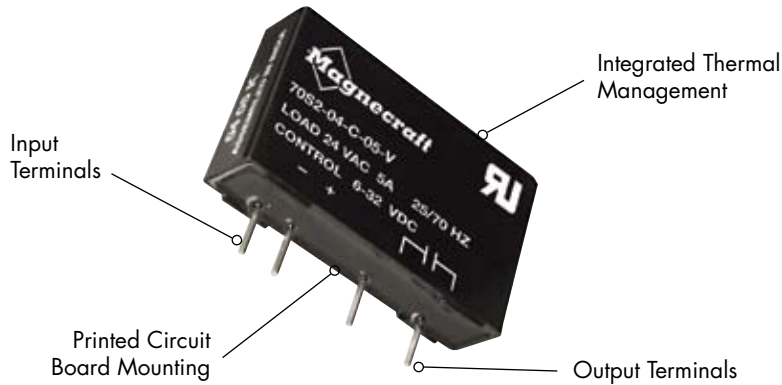

### General Specifications (@ 25° C) (UL 508)

| Output Characteristics                         |                      | Units            | 70S2-04-D  | 70S2-05-D  | 70S2-04-B   |
|--|----------------------|------------------|------------|------------|-------------|
| Number and type of Contacts                    |                      |                  | SPST-NO    | SPST-NO    | SPST-NO     |
| Switching Device                               |                      |                  | Triac      | Triac      | Triac       |
| Current Rating                                 |                      | A                | 3 / 5      | 3          | 3 / 5       |
| Switching voltage                              |                      | V                | 8...50 AC  | 8...50 AC  | 24...140 AC |
| Switching Type                                 |                      |                  | Zero Cross | Zero Cross | Zero Cross  |
| Maximum Rate of Rise Off State Voltage (dv/dt) |                      | V/us             | 300        | 300        | 300         |
| Min. Load current to maintain on               |                      | mA               | 75 / 50    | 75         | 75 / 50     |
| Non-Repetitive Surge Current (1 cycle)         |                      | A                | 60 / 300   | 60         | 60 / 300    |
| Max. Off state leakage current (rms)           |                      | mA               | 3 / 10     | 3          | 6 / 10      |
| Typical On State Voltage Drop (rms)            |                      | V                | 1.6 AC     | 1.6 AC     | 1.6 AC      |
| Minimum Peak Blocking Voltage                  |                      | V                | 200 AC     | 200 AC     | 400 AC      |
| Input Characteristics                          |                      |                  |            |            |             |
| Voltage Range                                  |                      | V                | 3...32 DC  | 6...32 DC  | 3...32 DC   |
| Must Release Voltage                           |                      | V                | 1 DC       | 1 DC       | 1 DC        |
| Typical Input Current @ 5VDC or 240VAC         |                      | mA               | 1...19     | 1...6      | 1...19      |
| Max. Reverse Control Voltage                   |                      | V                | 3 DC       | 3 DC       | 3 DC        |
| Performance Characteristics                    |                      |                  |            |            |             |
| Operating time (response time)                 | On                   | ms               | 8.3        | 8.3        | 8.3         |
|  | Off                  | ms               | 8.3        | 8.3        | 8.3         |
| Dielectric strength                            | Terminals to Chassis | V                | 4000 AC    | 4000 AC    | 4000 AC     |
|  | Input to Output      | V                | 4000 AC    | 4000 AC    | 4000 AC     |
| Environment                                    |                      |                  |            |            |             |
| Product certifications                         |                      | Standard version | UR, CSA    | UR, CSA    | UR, CSA     |
| Ambient air temperature around the device      | Storage              | °C               | -40...+125 | -40...+125 | -40...+125  |
|  | Operation            | °C               | -40...+100 | -40...+100 | -40...+100  |
| Miscellaneous Characteristics                  |                      |                  |            |            |             |
| Thermal Resistance (Junction to Case)          |                      | °C/W             | 0.5        | 0.5        | 0.5         |
| Weight   |                      | g (oz)           | 25 (0.9)   | 25 (0.9)   | 25 (0.9)    |



70S2 V (3 Amp)



70S2 V (5 Amp)

**NEW**  
**NEW**  
**NEW**  
**NEW**

| 70S2-05-B    | 70S2-04-C    | 70S2-05-C    | 70S2-01-A    | 70S2-02-A    |
|--------------|--------------|--------------|--------------|--------------|
| SPST-NO      | SPST-NO      | SPST-NO      | SPST-NO      | SPST-NO      |
| Triac        | Triac        | Triac        | MOSFET       | MOSFET       |
| 3            | 3 / 5        | 3            | 3            | 3            |
| 24....140 AC | 24....280 AC | 24....280 AC | 3....60 DC   | 3....60 DC   |
| Zero Cross   | Zero Cross   | Zero Cross   | DC Switching | DC Switching |
| 300          | 300          | 300          | N/A          | N/A          |
| 75           | 75 / 50      | 75           | 100          | 100          |
| 60           | 60 / 300     | 60           | 5 (1 SEC)    | 6 (1 SEC)    |
| 6            | 6 / 10       | 6            | 10 μ A       | 10 μ A       |
| 1.6 AC       | 1.6 AC       | 1.6 AC       | 1.2 DC       | 1.2 DC       |
| 400 AC       | 600 AC       | 600 AC       | 105 DC       | 105 DC       |
| 6....32 DC   | 3....32 DC   | 6....32 DC   | 3....15 DC   | 9....30 DC   |
| 1 DC         | 1 DC         | 1 DC         | 1 DC         | 1 DC         |
| 1....6       | 1....19      | 1....6       | 5....40      | 5....17      |
| 3 DC         | 3 DC         | 3 DC         | 3 DC         | 3 DC         |
| 8.3          | 8.3          | 8.3          | 75 μs        | 75 μs        |
| 8.3          | 8.3          | 8.3          | 500 μs       | 500 μs       |
| 4000 AC      | 4000 AC      | 4000 AC      | 4000 AC      | 4000 AC      |
| 4000 AC      | 4000 AC      | 4000 AC      | 4000 AC      | 4000 AC      |
| UR, CSA      | UR, CSA      | UR, CSA      | UR, CSA      | UR, CSA      |
| -40...+125   | -40...+125   | -40...+125   | -40...+125   | -40...+125   |
| -40...+100   | -40...+100   | -40...+100   | -40...+100   | -40...+100   |
| 0.5          | 0.5          | 0.5          | 0.5          | 0.5          |
| 25 (0.9)     | 25 (0.9)     | 25 (0.9)     | 25 (0.9)     | 25 (0.9)     |

# 70S2 Series Solid State Relays/3, 5 Amp, V Style *continued*



**UL** **us**  
UL Recognized  
File No. E258297

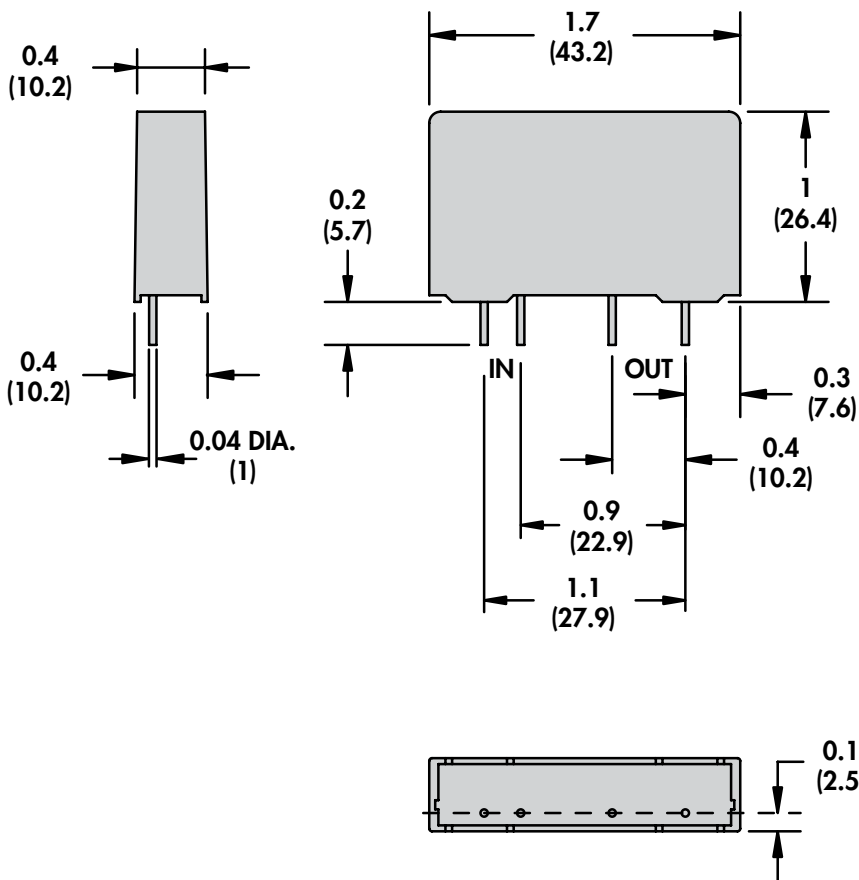
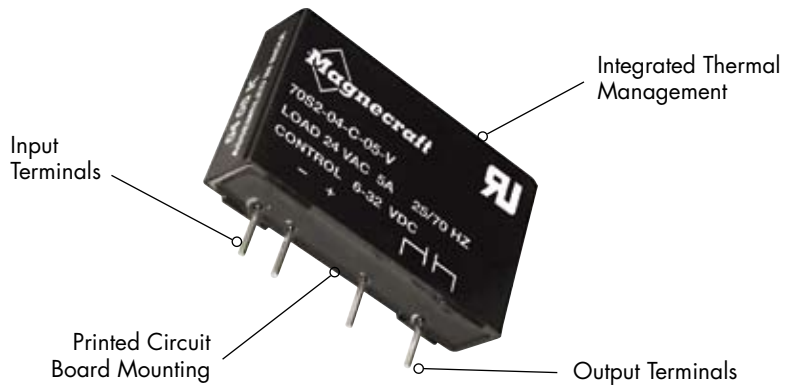

SECTION 4



70S2 V (3 Amp)



70S2 V (5 Amp)

**NEW**  
**NEW**  
**NEW**  
**NEW**

**Standard Part Numbers**

**BOLD-FACED PART NUMBERS ARE NORMALLY STOCKED**

| DC Operated           | Input Voltage Range | Output Voltage Range | Contact Configuration | Switching Type | Rated Current Load (Amps) |
|-----------------------|---------------------|----------------------|-----------------------|----------------|---------------------------|
| <b>70S2-04-D-03-V</b> | 3...32 VDC          | 8...50 VAC           | SPST-NO               | Zero Cross     | 3                         |
| 70S2-05-D-03-V        | 6...32 VDC          | 8...50 VAC           | SPST-NO               | Zero Cross     | 3                         |
| 70S2-04-D-05-V        | 3...32 VDC          | 8...50 VAC           | SPST-NO               | Zero Cross     | 5                         |
| <b>70S2-04-B-03-V</b> | 3...32 VDC          | 24...140 VAC         | SPST-NO               | Zero Cross     | 3                         |
| <b>70S2-05-B-03-V</b> | 6...32 VDC          | 24...140 VAC         | SPST-NO               | Zero Cross     | 3                         |
| 70S2-04-B-05-V        | 3...32 VDC          | 24...140 VAC         | SPST-NO               | Zero Cross     | 5                         |
| <b>70S2-04-C-03-V</b> | 3...32 VDC          | 24...280 VAC         | SPST-NO               | Zero Cross     | 3                         |
| 70S2-05-C-03-V        | 6...32 VDC          | 24...280 VAC         | SPST-NO               | Zero Cross     | 3                         |
| 70S2-04-C-05-V        | 3...32 VDC          | 24...280 VAC         | SPST-NO               | Zero Cross     | 5                         |
| <b>70S2-01-A-03-V</b> | 3...15 VDC          | 3...60 VDC           | SPST-NO               | Zero Cross     | 3                         |
| 70S2-02-A-03-V        | 9...30 VDC          | 3...60 VDC           | SPST-NO               | Zero Cross     | 3                         |

**Part Number Builder**

| Series | Input Voltage                              | Output Voltage    | Output Current | Package Style |
|--------|--|-------------------|----------------|---------------|
| 70S2   | 01 = 3 to 15 VDC, DC/DC RELAYS             | A = 3 to 60 VDC   | 02 = 2.5 AMPS  | V = V STYLE   |
|        | 02 = 9 to 30 VDC, DC/DC RELAYS             | B = 24 to 140 VAC | 03 = 3 AMPS    | N = N STYLE   |
|        | 03 = 3 to 30 VDC, 25 A S PACK              | C = 24 to 280 VAC | 04 = 4 AMPS    | S = S STYLE   |
|        | 04 = 3 to 30 VDC (OR 32 VDC), DC/AC RELAYS | D = 8 to 50 VAC   | 05 = 5 AMPS    | F = F STYLE   |
|        | 05 = 6 to 30 VDC (OR 32 VDC), DC/AC RELAYS |                   | 06 = 6 AMPS    | M = M STYLE   |
|        |  |                   | 10 = 10 AMPS   | H = H STYLE   |
|        |  |                   | 12 = 12 AMPS   | L = L STYLE   |
|        |  |                   | 25 = 25 AMPS   | K = K STYLE   |

**Maximum Continuous Current vs. Ambient Temperature**

**Style V, 3 Amp**

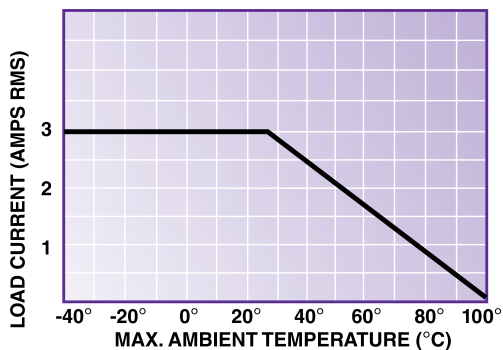

**Style V, 5 Amp**

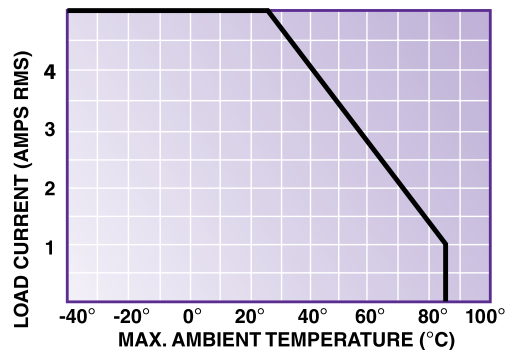

# 70S2 Series Solid State Relays/N and S Style



## General Specifications (@ 25° C) (UL 508)

| Output Characteristics                         |                      | Units  | 70S2-04-B    | 70S2-05-B    | 70S2-04-C    |
|--|----------------------|--------|--------------|--------------|--------------|
| Number and type of Contacts                    |                      |        | SPST-NO      | SPST-NO      | SPST-NO      |
| Switching Device                               |                      |        | Triac        | Triac        | Triac        |
| Current Rating                                 |                      | A      | 6 / 12       | 6 / 12       | 6 / 12       |
| Switching voltage                              |                      | V      | 24....140 AC | 24....140 AC | 24....280 AC |
| Switching Type                                 |                      |        | Zero Cross   | Zero Cross   | Zero Cross   |
| Maximum Rate of Rise Off State Voltage (dv/dt) |                      | V/us   | 300          | 300          | 300          |
| Min. Load current to maintain on               |                      | mA     | 75 / 100     | 75 / 100     | 75 / 100     |
| Non-Repetitive Surge Current (1 cycle)         |                      | A      | 60 / 150     | 60 / 150     | 60 / 150     |
| Max. Off state leakage current (rms)           |                      | mA     | 6            | 6            | 6            |
| Typical On State Voltage Drop (rms)            |                      | V      | 1.6 AC       | 1.6 AC       | 1.6 AC       |
| Minimum Peak Blocking Voltage                  |                      | V      | 400 AC       | 400 AC       | 600 AC       |
| Input Characteristics                          |                      |        |              |              |              |
| Voltage Range                                  |                      | V      | 3....30 DC   | 6....30 DC   | 3....30 DC   |
| Must Release Voltage                           |                      | V      | 1 DC         | 1 DC         | 1 DC         |
| Typical Input Current @ 5VDC or 240VAC         |                      | mA     | 7....16      | 6....10      | 7....16      |
| Max. Reverse Control Voltage                   |                      | V      | 3 DC         | 3 DC         | 3 DC         |
| Performance Characteristics                    |                      |        |              |              |              |
| Operating time (response time)                 | On                   | ms     | 8.3          | 8.3          | 8.3          |
|  | Off                  | ms     | 8.3          | 8.3          | 8.3          |
| Dielectric strength                            | Terminals to Chassis | V      | 3000 AC      | 3000 AC      | 3000 AC      |
|  | Input to Output      | V      | 3000 AC      | 3000 AC      | 3000 AC      |
| Environment                                    |                      |        |              |              |              |
| Product certifications                         | Standard version     |        | UR, CSA      | UR, CSA      | UR, CSA      |
| Ambient air temperature around the device      | Storage              | °C     | -40...+125   | -40...+125   | -40...+125   |
|  | Operation            | °C     | -40...+100   | -40...+100   | -40...+100   |
| Miscellaneous Characteristics                  |                      |        |              |              |              |
| Thermal Resistance (Junction to Case)          |                      | °C/W   | 4            | 4            | 4            |
| Weight   |                      | g (oz) | 47 (1.7)     | 47 (1.7)     | 47 (1.7)     |
| Mounting Screw Torque                          |                      | Nm     | 1.0          | 1.0          | 1.0          |

Maximum Continuous Current vs. Ambient Temperature

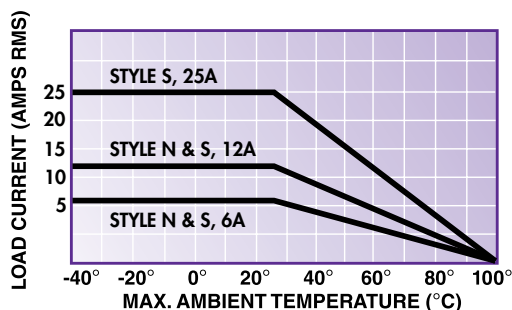



70S2 N



70S2 S

| 70S2-05-C    | 70S2-03-B    | 70S2-03-C    | 70S2-01-A    | 70S2-02-A    |
|--------------|--------------|--------------|--------------|--------------|
| SPST-NO      | SPST-NO      | SPST-NO      | SPST-NO      | SPST-NO      |
| Triac        | Triac        | Triac        | MOSFET       | MOSFET       |
| 6 / 12       | 25           | 25           | 5            | 5            |
| 24....280 AC | 24....140 AC | 24....280 AC | 3....60 DC   | 3....60 DC   |
| Zero Cross   | Zero Cross   | Zero Cross   | DC Switching | DC Switching |
| 300          | 300          | 300          | N/A          | N/A          |
| 75 / 100     | 100          | 100          | 100          | 100          |
| 60 / 150     | 300          | 300          | 7 (1 SEC)    | 7 (1 SEC)    |
| 6            | 6            | 6            | 10 μ A       | 10 μ A       |
| 1.6 AC       | 1.7 AC       | 1.7 AC       | 1.85 DC      | 1.85 DC      |
| 600 AC       | 400 AC       | 600 AC       | 105 DC       | 105 DC       |
| 6....30 DC   | 3....30 DC   | 3....30 DC   | 3....15 DC   | 9....30 DC   |
| 1 DC         | 1 DC         | 1 DC         | 1 DC         | 1 DC         |
| 6....10      | 7....16      | 6....10      | 5....40      | 5....17      |
| 3 DC         | 3 DC         | 3 DC         | 3 DC         | 3 DC         |
| 8.3          | 8.3          | 8.3          | 75 μs        | 75 μs        |
| 8.3          | 8.3          | 8.3          | 750 μs       | 750 μs       |
| 3000 AC      | 3000 AC      | 3000 AC      | 2500 AC      | 2500 AC      |
| 3000 AC      | 3000 AC      | 3000 AC      | 2500 AC      | 2500 AC      |
| UR, CSA      | UR, CSA      | UR, CSA      | UR, CSA      | UR, CSA      |
| -40...+125   | -40...+125   | -40...+125   | -40...+125   | -40...+125   |
| -40...+100   | -40...+100   | -40...+100   | -40...+100   | -40...+100   |
| 4            | 4            | 4            | 4            | 4            |
| 47 (1.7)     | 47 (1.7)     | 47 (1.7)     | 47 (1.7)     | 35 (1.2)     |
| 1.0          | 1.0          | 1.0          | 1.0          | 1.0          |



# 70S2 Series Solid State Relays/N and S Style *continued*

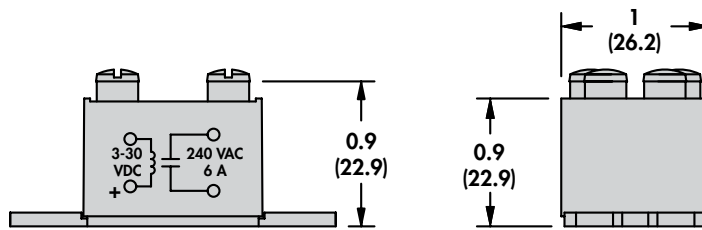
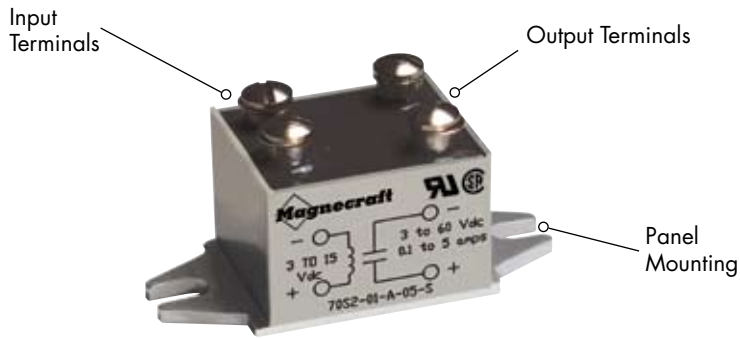

**70S2 S**

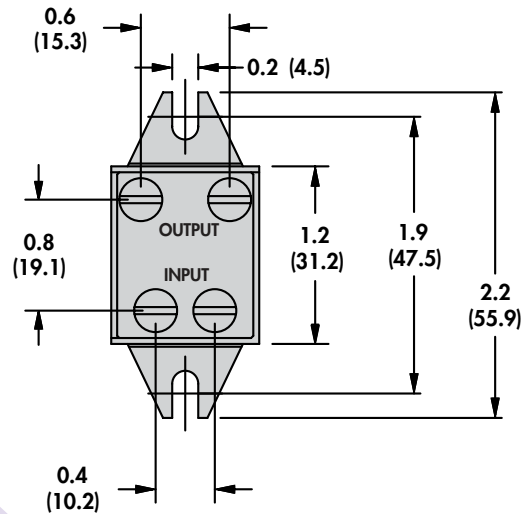

**70S2 N**

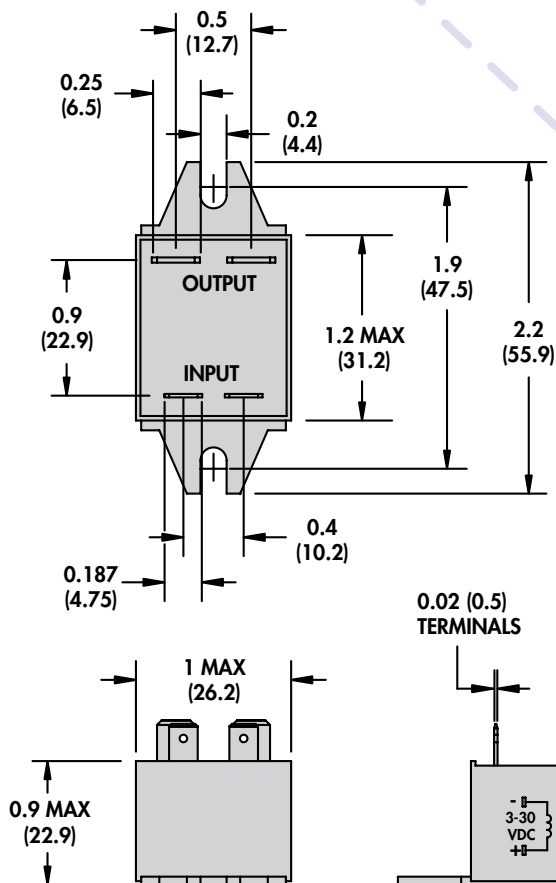

0.02 (0.5) TERMINALS      0.032 (0.8) TERMINALS



70S2 N



70S2 S

Standard Part Numbers

**BOLD-FACED PART NUMBERS ARE NORMALLY STOCKED**

| DC Operated           | Input Voltage Range | Output Voltage Range | Contact Configuration | Switching Type | Rated Current Load (Amps) |
|-----------------------|---------------------|----------------------|-----------------------|----------------|---------------------------|
| <b>70S2-04-B-06-N</b> | 3...30 VDC          | 24...140 VAC         | SPST-NO               | Zero Cross     | 6                         |
| 70S2-05-B-06-N        | 6...30 VDC          | 24...140 VAC         | SPST-NO               | Zero Cross     | 6                         |
| <b>70S2-04-B-12-N</b> | 3...30 VDC          | 24...140 VAC         | SPST-NO               | Zero Cross     | 12                        |
| 70S2-05-B-12-N        | 6...30 VDC          | 24...140 VAC         | SPST-NO               | Zero Cross     | 12                        |
| <b>70S2-04-C-06-N</b> | 3...30 VDC          | 24...280 VAC         | SPST-NO               | Zero Cross     | 6                         |
| 70S2-05-C-06-N        | 6...30 VDC          | 24...280 VAC         | SPST-NO               | Zero Cross     | 6                         |
| <b>70S2-04-C-12-N</b> | 3...30 VDC          | 24...280 VAC         | SPST-NO               | Zero Cross     | 12                        |
| 70S2-05-C-12-N        | 6...30 VDC          | 24...280 VAC         | SPST-NO               | Zero Cross     | 12                        |
| <b>70S2-01-A-05-N</b> | 3...15 VDC          | 3...60 VDC           | SPST-NO               | DC Switching   | 5                         |
| <b>70S2-04-B-06-S</b> | 3...30 VDC          | 24...140 VAC         | SPST-NO               | Zero Cross     | 6                         |
| <b>70S2-05-B-06-S</b> | 6...30 VDC          | 24...140 VAC         | SPST-NO               | Zero Cross     | 6                         |
| <b>70S2-04-B-12-S</b> | 3...30 VDC          | 24...140 VAC         | SPST-NO               | Zero Cross     | 12                        |
| 70S2-05-B-12-S        | 6...30 VDC          | 24...140 VAC         | SPST-NO               | Zero Cross     | 12                        |
| <b>70S2-03-B-25-S</b> | 3...30 VDC          | 24...140 VAC         | SPST-NO               | Zero Cross     | 25                        |
| <b>70S2-04-C-06-S</b> | 3...30 VDC          | 24...280 VAC         | SPST-NO               | Zero Cross     | 6                         |
| 70S2-05-C-06-S        | 6...30 VDC          | 24...280 VAC         | SPST-NO               | Zero Cross     | 6                         |
| <b>70S2-04-C-12-S</b> | 3...30 VDC          | 24...280 VAC         | SPST-NO               | Zero Cross     | 12                        |
| <b>70S2-05-C-12-S</b> | 6...30 VDC          | 24...280 VAC         | SPST-NO               | Zero Cross     | 12                        |
| <b>70S2-03-C-25-S</b> | 3...30 VDC          | 24...280 VAC         | SPST-NO               | Zero Cross     | 25                        |
| <b>70S2-01-A-05-S</b> | 3...15 VDC          | 3...60 VDC           | SPST-NO               | DC Switching   | 5                         |
| <b>70S2-02-A-05-S</b> | 9...30 VDC          | 3...60 VDC           | SPST-NO               | DC Switching   | 5                         |

SECTION 4

Part Number Builder

| Series | Input Voltage                              | Output Voltage    | Output Current | Package Style |
|--------|--|-------------------|----------------|---------------|
| 70S2   | 01 = 3 to 15 VDC, DC/DC RELAYS             | A = 3 to 60 VDC   | 02 = 2.5 AMPS  | V = V STYLE   |
|        | 02 = 9 to 30 VDC, DC/DC RELAYS             | B = 24 to 140 VAC | 03 = 3 AMPS    | N = N STYLE   |
|        | 03 = 3 to 30 VDC, 25 A S PACK              | C = 24 to 280 VAC | 04 = 4 AMPS    | S = S STYLE   |
|        | 04 = 3 to 30 VDC (OR 32 VDC), DC/AC RELAYS | D = 8 to 50 VAC   | 05 = 5 AMPS    | F = F STYLE   |
|        | 05 = 6 to 30 VDC (OR 32 VDC), DC/AC RELAYS |                   | 06 = 6 AMPS    | M = M STYLE   |
|        |  |                   | 10 = 10 AMPS   | H = H STYLE   |
|        |  |                   | 12 = 12 AMPS   | L = L STYLE   |
|        |  |                   | 25 = 25 AMPS   | K = K STYLE   |

# 70S2 Series Solid State Relays/F and M Style

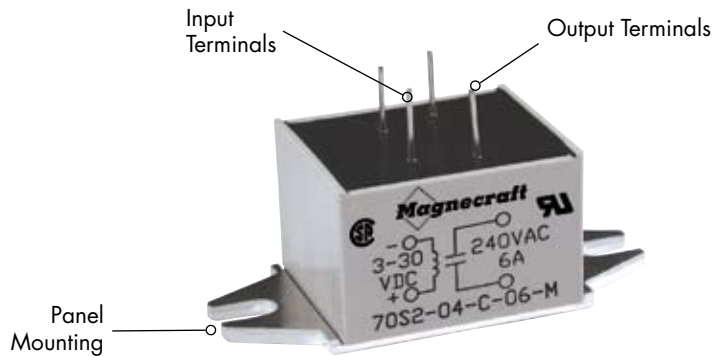

## General Specifications (@ 25° C) (UL 508)

| Output Characteristics                         |                      | Units  | 70S2-04-B    | 70S2-05-B    |
|--|----------------------|--------|--------------|--------------|
| Number and type of Contacts                    |                      |        | SPST-NO      | SPST-NO      |
| Switching Device                               |                      |        | Triac        | Triac        |
| Current Rating                                 |                      | A      | 4   6   10   | 4   6   10   |
| Switching voltage                              |                      | V      | 24....140 AC | 24....140 AC |
| Switching Type                                 |                      |        | Zero Cross   | Zero Cross   |
| Maximum Rate of Rise Off State Voltage (dv/dt) |                      | V/us   | 300          | 300          |
| Min. Load current to maintain on               |                      | mA     | 75   100     | 75   100     |
| Non-Repetitive Surge Current (1 cycle)         |                      | A      | 60   110     | 60   110     |
| Max. Off state leakage current (rms)           |                      | mA     | 6            | 6            |
| Typical On State Voltage Drop (rms)            |                      | V      | 1.6 AC       | 1.6 AC       |
| Minimum Peak Blocking Voltage                  |                      | V      | 400 AC       | 400 AC       |
| Input Characteristics                          |                      |        |              |              |
| Voltage Range                                  |                      | V      | 3....30 DC   | 6....30 DC   |
| Must Release Voltage                           |                      | V      | 1 DC         | 1 DC         |
| Typical Input Current @ 5VDC or 240VAC         |                      | mA     | 7....16      | 6....10      |
| Max. Reverse Control Voltage                   |                      | V      | 3 DC         | 3 DC         |
| Performance Characteristics                    |                      |        |              |              |
| Operating time (response time)                 | On                   | ms     | 8.3          | 8.3          |
|  | Off                  | ms     | 8.3          | 8.3          |
| Dielectric strength                            | Terminals to Chassis | V      | 3000 AC      | 3000 AC      |
|  | Input to Output      | V      | 3000 AC      | 3000 AC      |
| Environment                                    |                      |        |              |              |
| Product certifications                         | Standard version     |        | UR, CSA      | UR, CSA      |
| Ambient air temperature around the device      | Storage              | °C     | -40...+125   | -40...+125   |
|  | Operation            | °C     | -40...+100   | -40...+100   |
| Miscellaneous Characteristics                  |                      |        |              |              |
| Thermal Resistance (Junction to Case)          |                      | °C/W   | 4            | 4            |
| Weight   |                      | g (oz) | 35 (1.2)     | 35 (1.2)     |
| Mounting Screw Torque                          |                      | Nm     | 1.0          | 1.0          |

### Maximum Continuous Current vs. Ambient Temperature

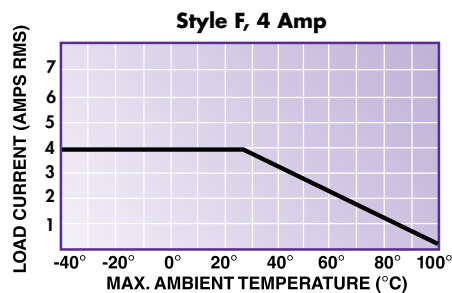
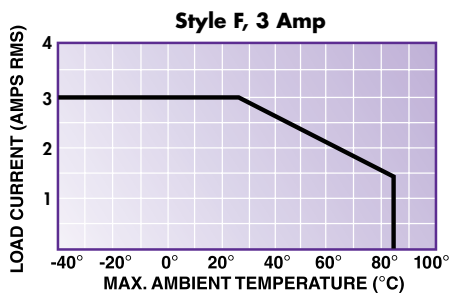



70S2 F



70S2 M

| 70S2-04-C    | 70S2-05-C    | 70S2-01-A    | 70S2-02-A    |
|--------------|--------------|--------------|--------------|
| SPST-NO      | SPST-NO      | SPST-NO      | SPST-NO      |
| Triac        | Triac        | MOSFET       | MOSFET       |
| 4   6   10   | 4   6   10   | 3            | 3            |
| 24....280 AC | 24....280 AC | 3....60 DC   | 3....60 DC   |
| Zero Cross   | Zero Cross   | DC Switching | DC Switching |
| 300          | 300          | N/A          | N/A          |
| 75   100     | 75   100     | 100          | 100          |
| 60   110     | 60   110     | N/A          | N/A          |
| 6            | 6            | 10 $\mu$ A   | 10 $\mu$ A   |
| 1.6 AC       | 1.6 AC       | 1.2 DC       | 1.2 DC       |
| 600 AC       | 600 AC       | 105 DC       | 105 DC       |
| 3....30 DC   | 6....30 DC   | 3....15 DC   | 9....30 DC   |
| 1 DC         | 1 DC         | 1 DC         | 1 DC         |
| 7....16      | 6....10      | 5....40      | 5....17      |
| 3 DC         | 3 DC         | 3 DC         | 3 DC         |
| 8.3          | 8.3          | 75 $\mu$ s   | 75 $\mu$ s   |
| 8.3          | 8.3          | 500 $\mu$ s  | 500 $\mu$ s  |
| 3000 AC      | 3000 AC      | 2500 AC      | 2500 AC      |
| 3000 AC      | 3000 AC      | 2500 AC      | 2500 AC      |
| UR, CSA      | UR, CSA      | UR, CSA      | UR, CSA      |
| -40...+125   | -40...+125   | -40...+125   | -40...+125   |
| -40...+100   | -40...+100   | -40...+100   | -40...+100   |
| 4            | 4            | 4            | 4            |
| 35 (1.2)     | 35 (1.2)     | 35 (1.2)     | 35 (1.2)     |
| 1.0          | 1.0          | 1.0          | 1.0          |

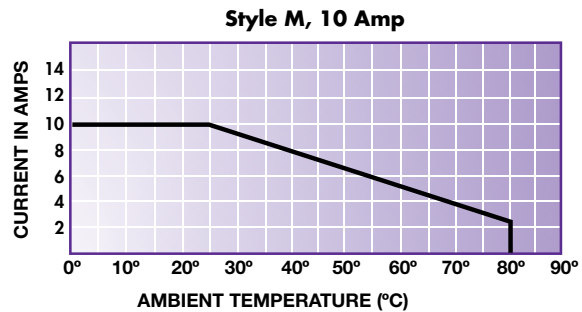
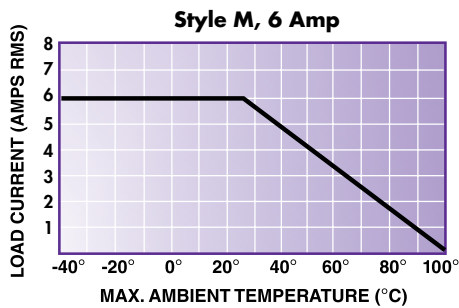

# 70S2 Series Solid State Relays/F and M Style *continued*

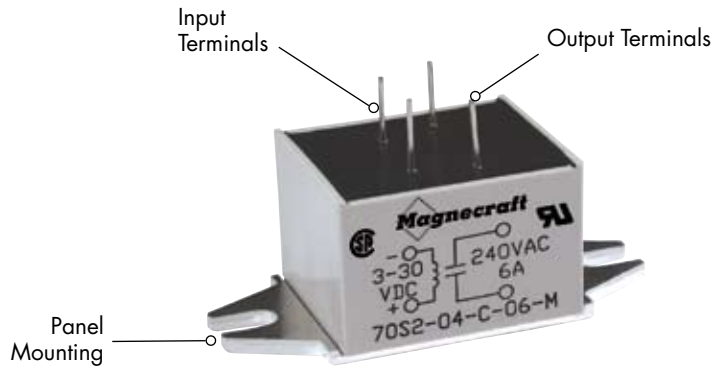

SECTION 4

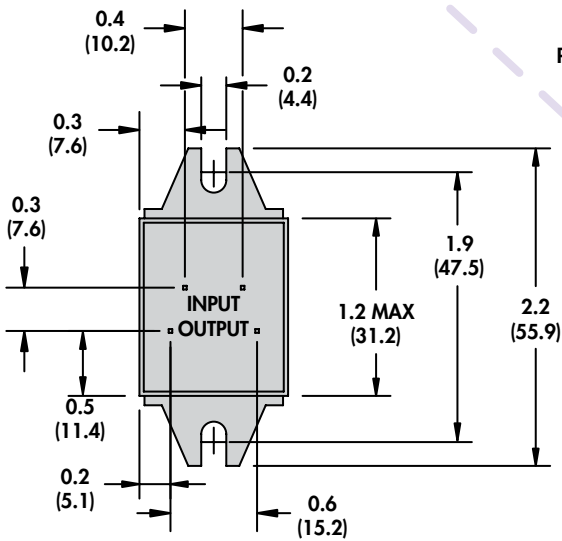
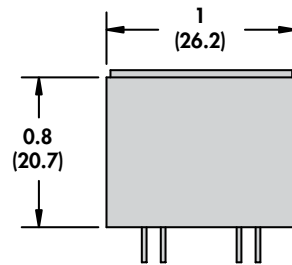
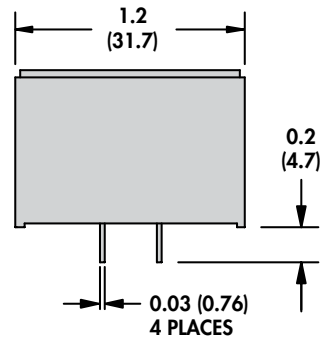

POTTING MIGRATION ON LEADS

**70S2 F**

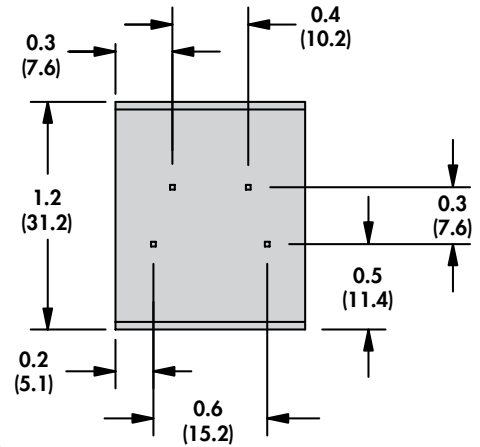

**70S2 M**

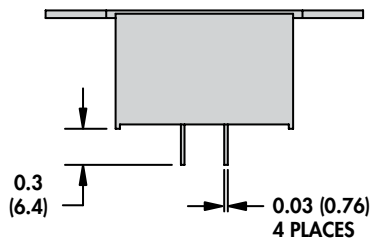
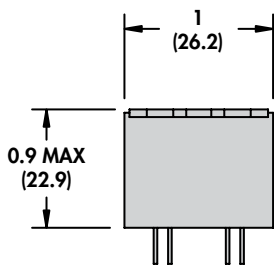



70S2 F



70S2 M

Standard Part Numbers

**BOLD-FACED PART NUMBERS ARE NORMALLY STOCKED**

| DC Operated           | Input Voltage Range | Output Voltage Range | Contact Configuration | Switching Type | Rated Current Load (Amps) |
|-----------------------|---------------------|----------------------|-----------------------|----------------|---------------------------|
| <b>70S2-04-B-04-F</b> | 3...30 VDC          | 24...140 VAC         | SPST-NO               | Zero Cross     | 4                         |
| 70S2-05-B-04-F        | 6...30 VDC          | 24...140 VAC         | SPST-NO               | Zero Cross     | 4                         |
| <b>70S2-04-C-04-F</b> | 3...30 VDC          | 24...280 VAC         | SPST-NO               | Zero Cross     | 4                         |
| 70S2-05-C-04-F        | 6...30 VDC          | 24...280 VAC         | SPST-NO               | Zero Cross     | 4                         |
| <b>70S2-01-A-03-F</b> | 3...15 VDC          | 3...60 VDC           | SPST-NO               | DC Switching   | 3                         |
| 70S2-02-A-03-F        | 9...30 VDC          | 3...60 VDC           | SPST-NO               | DC Switching   | 3                         |
| 70S2-04-B-06-M        | 3...30 VDC          | 24...140 VAC         | SPST-NO               | Zero Cross     | 6                         |
| 70S2-05-B-06-M        | 6...30 VDC          | 24...140 VAC         | SPST-NO               | Zero Cross     | 6                         |
| <b>70S2-04-B-10-M</b> | 3...30 VDC          | 24...140 VAC         | SPST-NO               | Zero Cross     | 10                        |
| 70S2-05-B-10-M        | 6...30 VDC          | 24...140 VAC         | SPST-NO               | Zero Cross     | 10                        |
| <b>70S2-04-C-06-M</b> | 3...30 VDC          | 24...280 VAC         | SPST-NO               | Zero Cross     | 6                         |
| 70S2-05-C-06-M        | 6...30 VDC          | 24...280 VAC         | SPST-NO               | Zero Cross     | 6                         |
| <b>70S2-04-C-10-M</b> | 3...30 VDC          | 24...280 VAC         | SPST-NO               | Zero Cross     | 10                        |
| 70S2-05-C-10-M        | 6...30 VDC          | 24...280 VAC         | SPST-NO               | Zero Cross     | 10                        |

Part Number Builder

| Series | Input Voltage                              | Output Voltage    | Output Current | Package Style |
|--------|--|-------------------|----------------|---------------|
| 70S2   | 01 = 3 to 15 VDC, DC/DC RELAYS             | A = 3 to 60 VDC   | 02 = 2.5 AMPS  | V = V STYLE   |
|        | 02 = 9 to 30 VDC, DC/DC RELAYS             | B = 24 to 140 VAC | 03 = 3 AMPS    | N = N STYLE   |
|        | 03 = 3 to 30 VDC, 25 A S PACK              | C = 24 to 280 VAC | 04 = 4 AMPS    | S = S STYLE   |
|        | 04 = 3 to 30 VDC (OR 32 VDC), DC/AC RELAYS | D = 8 to 50 VAC   | 05 = 5 AMPS    | F = F STYLE   |
|        | 05 = 6 to 30 VDC (OR 32 VDC), DC/AC RELAYS |                   | 06 = 6 AMPS    | M = M STYLE   |
|        |  |                   | 10 = 10 AMPS   | H = H STYLE   |
|        |  |                   | 12 = 12 AMPS   | L = L STYLE   |
|        |  |                   | 25 = 25 AMPS   | K = K STYLE   |

# 70S2 Series Solid State Relays/H and L Style

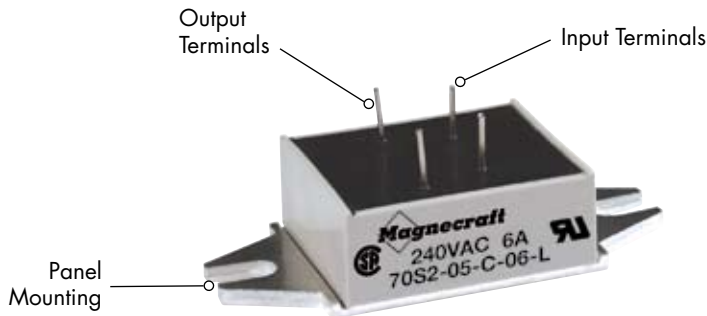

## General Specifications (@ 25° C) (UL 508)

| Output Characteristics                         |                      | Units            | 70S2-04-D  | 70S2-05-D  |
|--|----------------------|------------------|------------|------------|
| Number and type of Contacts                    |                      |                  | SPST-NO    | SPST-NO    |
| Switching Device                               |                      |                  | Triac      | Triac      |
| Current Rating                                 |                      | A                | 2.5        | 2.5        |
| Switching voltage                              |                      | V                | 8...50 AC  | 8...50 AC  |
| Switching Type                                 |                      |                  | Zero Cross | Zero Cross |
| Maximum Rate of Rise Off State Voltage (dv/dt) |                      | V/us             | 300        | 300        |
| Min. Load current to maintain on               |                      | mA               | 75         | 75         |
| Non-Repetitive Surge Current (1 cycle)         |                      | A                | 60         | 60         |
| Max. Off state leakage current (rms)           |                      | mA               | 3          | 3          |
| Typical On State Voltage Drop (rms)            |                      | V                | 1.6 AC     | 1.6 AC     |
| Minimum Peak Blocking Voltage                  |                      | V                | 200 AC     | 200 AC     |
| Input Characteristics                          |                      |                  |            |            |
| Voltage Range                                  |                      | V                | 3...30 DC  | 6...30 DC  |
| Must Release Voltage                           |                      | V                | 1 DC       | 1 DC       |
| Typical Input Current @ 5VDC or 240VAC         |                      | mA               | 1...17     | 1...6      |
| Max. Reverse Control Voltage                   |                      | V                | 3 DC       | 3 DC       |
| Performance Characteristics                    |                      |                  |            |            |
| Operating time (response time)                 | On                   | ms               | 8.3        | 8.3        |
|  | Off                  | ms               | 8.3        | 8.3        |
| Dielectric strength                            | Terminals to Chassis | V                | 2500 AC    | 2500 AC    |
|  | Input to Output      | V                | 2500 AC    | 2500 AC    |
| Environment                                    |                      |                  |            |            |
| Product certifications                         |                      | Standard version | UR, CSA    | UR, CSA    |
| Ambient air temperature around the device      | Storage              | °C               | -40...+125 | -40...+125 |
|  | Operation            | °C               | -40...+100 | -40...+100 |
| Miscellaneous Characteristics                  |                      |                  |            |            |
| Thermal Resistance (Junction to Case)          |                      | °C/W             | 3.5        | 3.5        |
| Weight   |                      | g (oz)           | 22 (0.8)   | 22 (0.8)   |
| Mounting Screw Torque                          |                      | Nm               | 1.0        | 1.0        |

## Maximum Continuous Current vs. Ambient Temperature

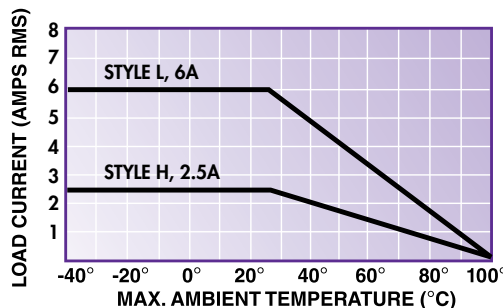



70S2 H



70S2 L

| 70S2-04-B    | 70S2-05-B    | 70S2-04-C    | 70S2-05-C    |
|--------------|--------------|--------------|--------------|
| SPST-NO      | SPST-NO      | SPST-NO      | SPST-NO      |
| Triac        | Triac        | Triac        | Triac        |
| 2.5   6      | 2.5   6      | 2.5   6      | 2.5   6      |
| 24....140 AC | 24....140 AC | 24....280 AC | 24....280 AC |
| Zero Cross   | Zero Cross   | Zero Cross   | Zero Cross   |
| 300          | 300          | 300          | 300          |
| 75           | 75           | 75           | 75           |
| 60           | 60           | 60           | 60           |
| 6            | 6            | 6            | 6            |
| 1.6 AC       | 1.6 AC       | 1.6 AC       | 1.6 AC       |
| 400 AC       | 400 AC       | 600 AC       | 400 AC       |
| <hr/>        |              |              |              |
| 3....30 DC   | 6....30 DC   | 3....30 DC   | 6....30 DC   |
| 1 DC         | 1 DC         | 1 DC         | 1 DC         |
| 1....17      | 1....6       | 1....17      | 1....6       |
| 3 DC         | 3 DC         | 3 DC         | 3 DC         |
| <hr/>        |              |              |              |
| 8.3          | 8.3          | 8.3          | 8.3          |
| 8.3          | 8.3          | 8.3          | 8.3          |
| 2500 AC      | 2500 AC      | 2500 AC      | 2500 AC      |
| 2500 AC      | 2500 AC      | 2500 AC      | 2500 AC      |
| <hr/>        |              |              |              |
| UR, CSA      | UR, CSA      | UR, CSA      | UR, CSA      |
| -40...+125   | -40...+125   | -40...+125   | -40...+125   |
| -40...+100   | -40...+100   | -40...+100   | -40...+100   |
| <hr/>        |              |              |              |
| 3.5          | 3.5          | 3.5          | 3.5          |
| 22 (0.8)     | 22 (0.8)     | 22 (0.8)     | 22 (0.8)     |
| 1.0          | 1.0          | 1.0          | 1.0          |



# 70S2 Series Solid State Relays/H and L Style *continued*

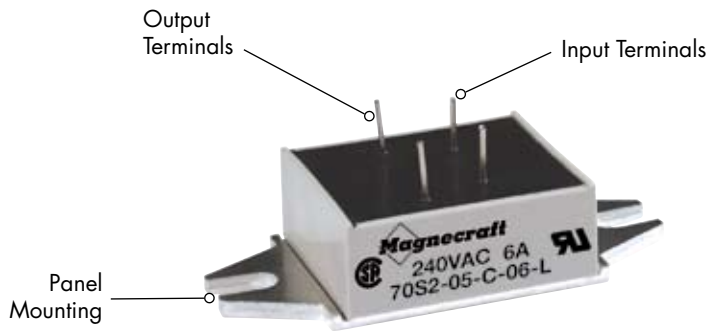

SECTION 4

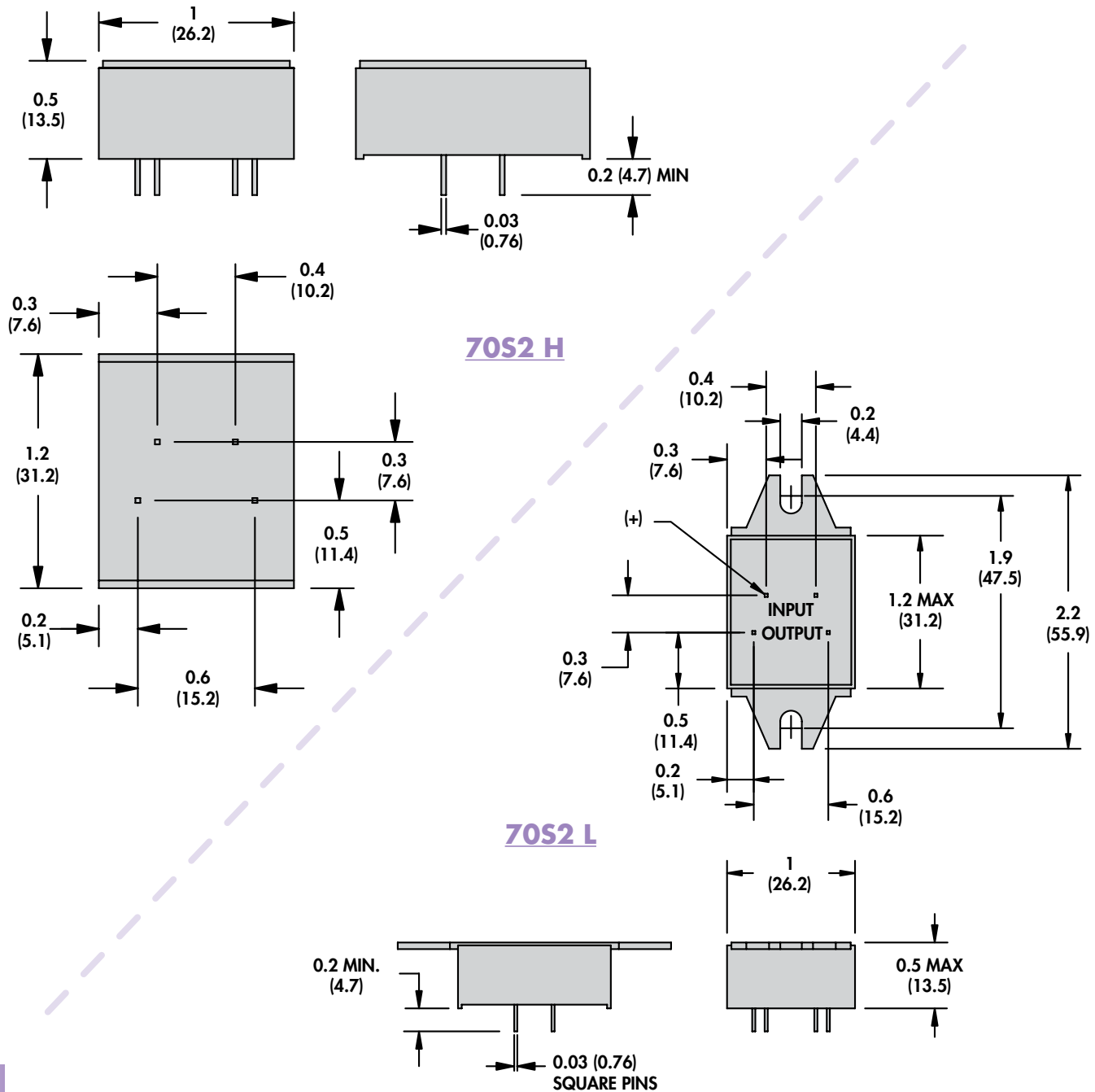



70S2 H



70S2 L

Standard Part Numbers

**BOLD-FACED PART NUMBERS ARE NORMALLY STOCKED**

| DC Operated           | Input Voltage Range | Output Voltage Range | Contact Configuration | Switching Type | Rated Current Load (Amps) |
|-----------------------|---------------------|----------------------|-----------------------|----------------|---------------------------|
| 70S2-04-D-02-H        | 3....30 VDC         | 8....50 VAC          | SPST-NO               | Zero Cross     | 2.5                       |
| 70S2-05-D-02-H        | 6....30 VDC         | 8....50 VAC          | SPST-NO               | Zero Cross     | 2.5                       |
| <b>70S2-04-B-02-H</b> | 3....30 VDC         | 24....140 VAC        | SPST-NO               | Zero Cross     | 2.5                       |
| 70S2-05-B-02-H        | 6....30 VDC         | 24....140 VAC        | SPST-NO               | Zero Cross     | 2.5                       |
| <b>70S2-04-C-02-H</b> | 3....30 VDC         | 24....280 VAC        | SPST-NO               | Zero Cross     | 2.5                       |
| 70S2-05-C-02-H        | 6....30 VDC         | 24....280 VAC        | SPST-NO               | Zero Cross     | 2.5                       |
| 70S2-04-B-06-L        | 3....30 VDC         | 24....140 VAC        | SPST-NO               | Zero Cross     | 6                         |
| 70S2-05-B-06-L        | 6....30 VDC         | 24....140 VAC        | SPST-NO               | Zero Cross     | 6                         |
| <b>70S2-04-C-06-L</b> | 3....30 VDC         | 24....280 VAC        | SPST-NO               | Zero Cross     | 6                         |
| 70S2-05-C-06-L        | 6....30 VDC         | 24....280 VAC        | SPST-NO               | Zero Cross     | 6                         |

SECTION 4

Part Number Builder

| Series | Input Voltage                              | Output Voltage    | Output Current | Package Style |
|--------|--|-------------------|----------------|---------------|
| 70S2   | 01 = 3 to 15 VDC, DC/DC RELAYS             | A = 3 to 60 VDC   | 02 = 2.5 AMPS  | V = V STYLE   |
|        | 02 = 9 to 30 VDC, DC/DC RELAYS             | B = 24 to 140 VAC | 03 = 3 AMPS    | N = N STYLE   |
|        | 03 = 3 to 30 VDC, 25 A S PACK              | C = 24 to 280 VAC | 04 = 4 AMPS    | S = S STYLE   |
|        | 04 = 3 to 30 VDC (OR 32 VDC), DC/AC RELAYS | D = 8 to 50 VAC   | 05 = 5 AMPS    | F = F STYLE   |
|        | 05 = 6 to 30 VDC (OR 32 VDC), DC/AC RELAYS |                   | 06 = 6 AMPS    | M = M STYLE   |
|        |  |                   | 10 = 10 AMPS   | H = H STYLE   |
|        |  |                   | 12 = 12 AMPS   | L = L STYLE   |
|        |  |                   | 25 = 25 AMPS   | K = K STYLE   |

# 70S2 Series Solid State Relays/K Style



**UL** US  
UL Recognized  
File No. E258297

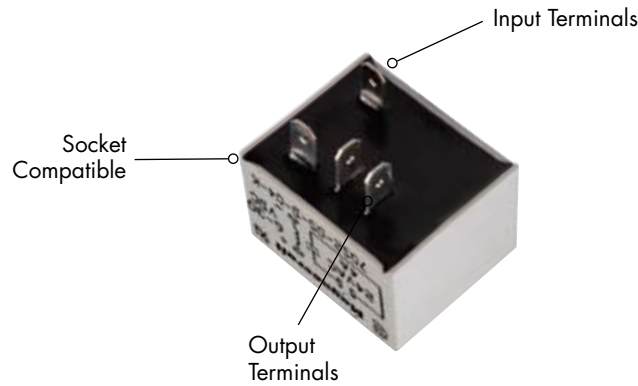

## General Specifications (@ 25° C) (UL 508)

| Output Characteristics                         |                      | Units  | 70S2-04-B    | 70S2-04-C    |
|--|----------------------|--------|--------------|--------------|
| Number and type of Contacts                    |                      |        | SPST-NO      | SPST-NO      |
| Switching Device                               |                      |        | Triac        | Triac        |
| Current Rating                                 |                      | A      | 4            | 4            |
| Switching voltage                              |                      | V      | 24....140 AC | 24....280 AC |
| Switching Type                                 |                      |        | Zero Cross   | Zero Cross   |
| Maximum Rate of Rise Off State Voltage (dv/dt) |                      | V/us   | 300          | 300          |
| Min. Load current to maintain on               |                      | mA     | 75           | 75           |
| Non-Repetitive Surge Current (1 cycle)         |                      | A      | 60           | 60           |
| Max. Off state leakage current (rms)           |                      | mA     | 6            | 6            |
| Typical On State Voltage Drop (rms)            |                      | V      | 1.6          | 1.6          |
| Minimum Peak Blocking Voltage                  |                      | V      | 400 AC       | 600 AC       |
| Input Characteristics                          |                      |        |              |              |
| Voltage Range                                  |                      | V      | 3....30 DC   | 3....30 DC   |
| Must Release Voltage                           |                      | V      | 1 DC         | 1 DC         |
| Typical Input Current @ 5VDC or 240VAC         |                      | mA     | 1....17      | 1....6       |
| Max. Reverse Control Voltage                   |                      | V      | 5 DC         | 5 DC         |
| Performance Characteristics                    |                      |        |              |              |
| Operating time (response time)                 | On                   | ms     | 8.3          | 8.3          |
|  | Off                  | ms     | 8.3          | 8.3          |
| Dielectric strength                            | Terminals to Chassis | V      | 3000 AC      | 3000 AC      |
|  | Input to Output      | V      | 3000 AC      | 3000 AC      |
| Environment                                    |                      |        |              |              |
| Product certifications                         |                      |        | UR, CSA      | UR, CSA      |
| Ambient air temperature around the device      | Storage              | °C     | -40...+125   | -40...+125   |
|  | Operation            | °C     | -40...+100   | -40...+100   |
| Miscellaneous Characteristics                  |                      |        |              |              |
| Thermal Resistance (Junction to Case)          |                      | °C/W   | 1.5          | 1.5          |
| Weight   |                      | g (oz) | 40 (1.4)     | 40 (1.4)     |

## Maximum Continuous Current vs. Ambient Temperature

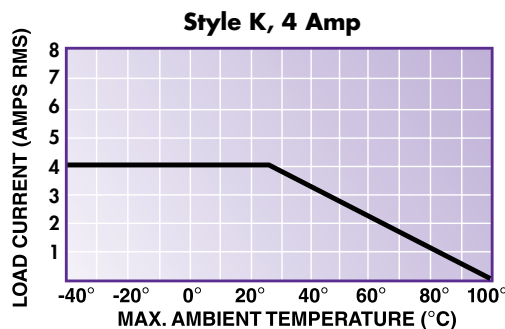

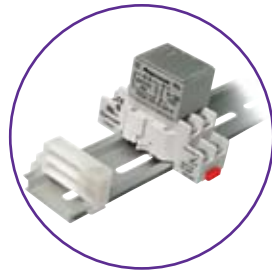

70S2 K Relay with the 70-459-1 Socket



70S2 K

| 70S2-04-D  | 70S2-05-B    | 70S2-05-C    | 70S2-05-D  | 70S2-01-A    | 70S2-02-A    |
|------------|--------------|--------------|------------|--------------|--------------|
| SPST-NO    | SPST-NO      | SPST-NO      | SPST-NO    | SPST-NO      | SPST-NO      |
| Triac      | Triac        | Triac        | Triac      | MOSFET       | MOSFET       |
| 4          | 4            | 4            | 4          | 3            | 3            |
| 8....50 AC | 24....140 AC | 24....280 AC | 8....50 AC | 3....60 DC   | 3....60 DC   |
| Zero Cross | Zero Cross   | Zero Cross   | Zero Cross | DC Switching | DC Switching |
| 300        | 300          | 300          | 300        | N/A          | N/A          |
| 75         | 75           | 75           | 75         | 100          | 100          |
| 60         | 60           | 60           | 60         | 7 (1 SEC)    | 7 (1 SEC)    |
| 3          | 6            | 6            | 6          | 10 $\mu$ A   | 10 $\mu$ A   |
| 1.6        | 1.6          | 1.6          | 1.6        | 1.2          | 1.2          |
| 200 AC     | 400 AC       | 600 AC       | 200 AC     | 105 DC       | 105 DC       |
| 3....30 DC | 6....30 DC   | 6....30 DC   | 6....30 DC | 3....15      | 9....30      |
| 1 DC       | 1 DC         | 1 DC         | 1 DC       | 1 DC         | 1 DC         |
| 1....17    | 1....6       | 1....17      | 1....6     | 5....40      | 5....17      |
| 5 DC       | 5 DC         | 5 DC         | 5 DC       | 5 DC         | 5 DC         |
| 8.3        | 8.3          | 8.3          | 8.3        | 75 $\mu$ s   | 75 $\mu$ s   |
| 8.3        | 8.3          | 8.3          | 8.3        | 500 $\mu$ s  | 500 $\mu$ s  |
| 3000 AC    | 3000 AC      | 3000 AC      | 3000 AC    | 3000 AC      | 3000 AC      |
| 3000 AC    | 3000 AC      | 3000 AC      | 3000 AC    | 3000 AC      | 3000 AC      |
| UR, CSA    | UR, CSA      | UR, CSA      | UR, CSA    | UR, CSA      | UR, CSA      |
| -40...+125 | -40...+125   | -40...+125   | -40...+125 | -40...+125   | -40...+125   |
| -40...+100 | -40...+100   | -40...+100   | -40...+100 | -40...+100   | -40...+100   |
| 1.5        | 1.5          | 1.5          | 1.5        | 1.5          | 1.5          |
| 40 (1.4)   | 40 (1.4)     | 40 (1.4)     | 40 (1.4)   | 40 (1.4)     | 40 (1.4)     |

# 70S2 Series Solid State Relays/K Style *continued*

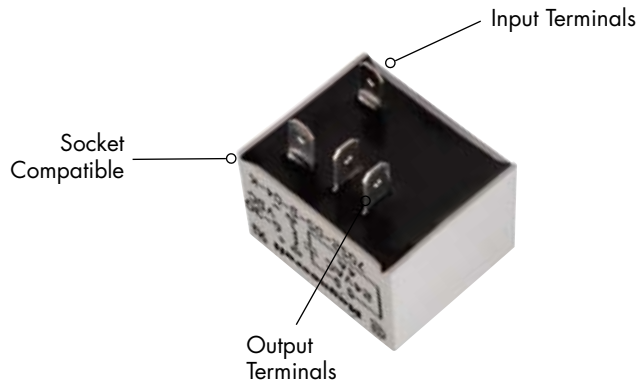

SECTION 4

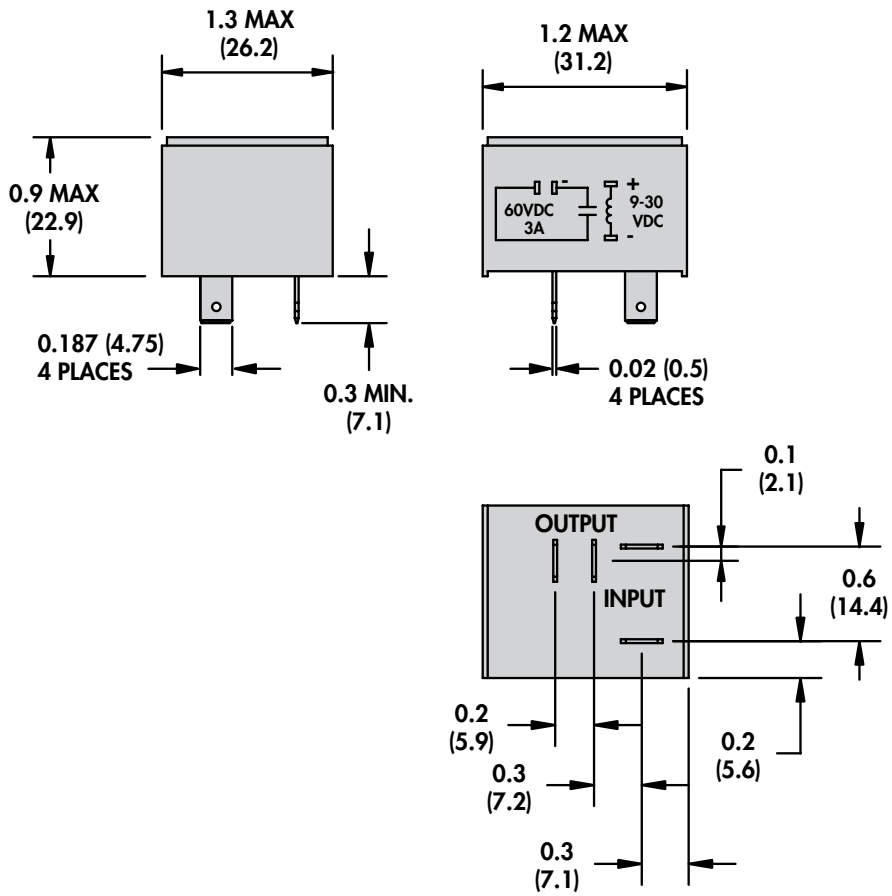

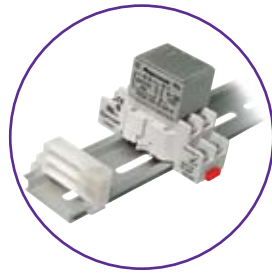

70S2 K Relay with the 70-459-1 Socket



70S2 K

**Standard Part Numbers**

**BOLD-FACED PART NUMBERS ARE NORMALLY STOCKED**

| DC Operated           | Input Voltage Range | Output Voltage Range | Contact Configuration | Switching Type | Rated Current Load (Amps) |
|-----------------------|---------------------|----------------------|-----------------------|----------------|---------------------------|
| <b>70S2-04-B-04-K</b> | 3....30 VDC         | 24....140 VAC        | SPST-NO               | Zero Cross     | 4                         |
| 70S2-04-C-04-K        | 3....30 VDC         | 24....280 VAC        | SPST-NO               | Zero Cross     | 4                         |
| 70S2-04-D-04-K        | 3....30 VDC         | 8....50 VAC          | SPST-NO               | Zero Cross     | 4                         |
| <b>70S2-05-B-04-K</b> | 6....30 VDC         | 24....140 VAC        | SPST-NO               | Zero Cross     | 4                         |
| 70S2-05-C-04-K        | 6....30 VDC         | 24....280 VAC        | SPST-NO               | Zero Cross     | 4                         |
| 70S2-05-D-04-K        | 6....30 VDC         | 8....50 VAC          | SPST-NO               | Zero Cross     | 4                         |
| 70S2-01-A-03-K        | 3....15 VDC         | 3....60 VDC          | SPST-NO               | DC Switching   | 3                         |
| <b>70S2-02-A-03-K</b> | 9....30 VDC         | 3....60 VDC          | SPST-NO               | DC Switching   | 3                         |

**Part Number Builder**

| Series | Input Voltage                              | Output Voltage    | Output Current | Package Style |
|--------|--|-------------------|----------------|---------------|
| 70S2   | 01 = 3 to 15 VDC, DC/DC RELAYS             | A = 3 to 60 VDC   | 02 = 2.5 AMPS  | V = V STYLE   |
|        | 02 = 9 to 30 VDC, DC/DC RELAYS             | B = 24 to 140 VAC | 03 = 3 AMPS    | N = N STYLE   |
|        | 03 = 3 to 30 VDC, 25 A S PACK              | C = 24 to 280 VAC | 04 = 4 AMPS    | S = S STYLE   |
|        | 04 = 3 to 30 VDC (OR 32 VDC), DC/AC RELAYS | D = 8 to 50 VAC   | 05 = 5 AMPS    | F = F STYLE   |
|        | 05 = 6 to 30 VDC (OR 32 VDC), DC/AC RELAYS |                   | 06 = 6 AMPS    | M = M STYLE   |
|        |  |                   | 10 = 10 AMPS   | H = H STYLE   |
|        |  |                   | 12 = 12 AMPS   | L = L STYLE   |
|        |  |                   | 25 = 25 AMPS   | K = K STYLE   |

## Данный компонент на территории Российской Федерации

### Вы можете приобрести в компании MosChip.

Для оперативного оформления запроса Вам необходимо перейти по данной ссылке:

<http://moschip.ru/get-element>

Вы можете разместить у нас заказ для любого Вашего проекта, будь то серийное производство или разработка единичного прибора.

В нашем ассортименте представлены ведущие мировые производители активных и пассивных электронных компонентов.

Нашей специализацией является поставка электронной компонентной базы двойного назначения, продукции таких производителей как XILINX, Intel (ex.ALTERA), Vicor, Microchip, Texas Instruments, Analog Devices, Mini-Circuits, Amphenol, Glenair.

Сотрудничество с глобальными дистрибьюторами электронных компонентов, предоставляет возможность заказывать и получать с международных складов практически любой перечень компонентов в оптимальные для Вас сроки.

На всех этапах разработки и производства наши партнеры могут получить квалифицированную поддержку опытных инженеров.

Система менеджмента качества компании отвечает требованиям в соответствии с ГОСТ Р ИСО 9001, ГОСТ РВ 0015-002 и ЭС РД 009

### Офис по работе с юридическими лицами:

105318, г.Москва, ул.Щербаковская д.3, офис 1107, 1118, ДЦ «Щербаковский»

Телефон: +7 495 668-12-70 (многоканальный)

Факс: +7 495 668-12-70 (доб.304)

E-mail: [info@moschip.ru](mailto:info@moschip.ru)

Skype отдела продаж:

moschip.ru

moschip.ru\_4

moschip.ru\_6

moschip.ru\_9