

Table of Contents



OVERVIEW – Inductive Proximity Sensors

Introduction	4
Operation	5



CYLINDRICAL Inductive Proximity Sensors

Introduction/Operation	8
Selection Guide, DC styles	12
Selection Guide, AC styles	14
Product Specifications.....	16

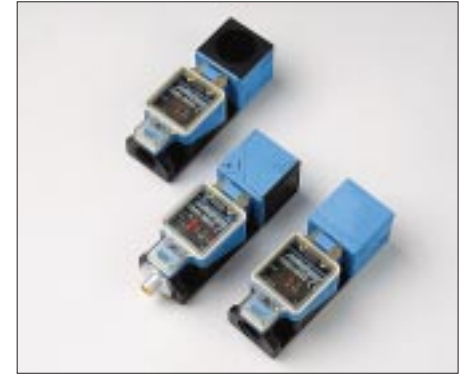

LIMIT STYLE Inductive Proximity Sensors

Introduction/Operation	68
Selection Guide.....	71
Product Specifications.....	72



BLOCK STYLE Inductive Proximity Sensors

Introduction/Operation	80
Selection Guide.....	82
Product Specifications.....	84



RING STYLE Inductive Proximity Sensors

Introduction/Operation	98
Selection Guide.....	100
Product Specifications.....	102

OTHER INFORMATION

APPENDIX:	
IP Codes	132
NEMA requirements	133
Cross Reference	134
Glossary.....	135
Conversion Charts	137
INDEX	138
TERMS & CONDITIONS	141
WARRANTY	143



ACCESSORIES for Inductive Proximity Sensors

Introduction.....	113
Mounting Brackets	114
Cable Assemblies.....	116
Switching Units.....	122
Motion Detectors	128

All specifications subject to change without notice or obligation



Cylindrical Sensors

CYLINDRICAL INDUCTIVE PROXIMITY SENSORS

Altech Cylindrical sensors are available in diameters ranging from 4mm (.16 in.) to 30mm (1.18 in.) with sensing distances up to 40mm (1.57 in.). Most models feature nickel plated brass (BN) housing, but stainless steel (SS) and non-metallic versions are available. Both flush mount and non-flush mount sensors are available. Flush mount versions are often called shielded or embeddable. Non-flush mount sensors are also called non-shielded or non-embeddable. Non-flush sensors have larger sensing distances than their flush mount counterparts. All Inductive sensors meet IP67 (NEMA1, 3, 4, 6, 12, 13) protection levels. Please refer to pages 132-133 of this catalog for more information.

FLUSH MOUNT CYLINDRICAL SENSORS

Flush Mounted, sometimes called embedded or shielded sensors, have electromagnetic fields concentrated directly in front of the sensing heads and may be mounted directly into metal mounting brackets or embedded directly into metal without causing a false output. **Figure 8** also illustrates that on Cylindrical Flush Mount sensors there should be at least 1 diameter of distance between adjacent sensors, and no non-target metal surfaces should be less than 3 times the sensing distance S_n directly across from the sensing head. Also, two directly opposite sensors mounted in metal should be greater than 6 times the sensing distance apart.

Sensing Distances – AC, DC, Cylindrical Style Sensors

Type	Voltage	Flush*	Non-Flush*
L Series - Short Body	DC	1.5 - 10	2 - 15
GL Series - 2 LED	DC	2 - 10	4 - 15
Standard Series	AC, DC	1.5 - 10	2 - 15
Extended Sensing Range	DC	2 - 15	3
High Speed	DC	2	
Plastic & Metal Housing	AC, DC	2 - 10	4 - 15
Mini Housing	DC	0.8 - 1.5	
Complementary Output	DC	2 - 10	4 - 15
Extended Temperature Range	DC	2 - 10	4 - 15
Weld Immune	AC, DC	2 - 10	4 - 15
Analog Output	DC	0.5 - 4	7 - 14
Extended Range Plus	DC	3 - 22	6 - 40
2-Wire	DC	2 - 10	4 - 15
Namur	DC	2 - 10	4 - 15

*All Sensing Distances in mm.

Operating Voltages – AC, DC Cylindrical Style

AC	90 - 250VAC	20 - 250VAC	
DC	18 - 30VDC	10 - 30VDC	10 - 60VDC

Operating Current– AC, DC Cylindrical Style

AC	180 mA	500 mA		
DC	5 mA	120 mA	200mA	400 mA

Sensor Wiring Systems – AC, DC Cylindrical Style

AC	2-Wire		
DC	2-Wire	3-Wire	4-Wire

NON-FLUSH CYLINDRICAL SENSORS

Sometimes called non-embedded or non-shielded, non-flush sensors have electromagnetic fields with a wide sensing angle and are unshielded (no metal surrounding the sensing head). Care must be taken to insure that no non-target metal comes in near proximity to the sensing head. Distances are demonstrated in **Figure 8**. Adjacent sensors should be separated by at least 2 times the diameter. Non-target metal should be at least 3 times the sensing distance directly across from the sensing head. Two directly opposite sensors should be at least 6 times the sensing distance apart.

OUTPUT CONNECTIONS

AC,DC – Normally Open (NO),
and Normally Closed (NC).
DC Namur – Special interface
Circuits required.
DC Analog – Analog Output 1 to 9V.

OUTPUT CABLES

Cylindrical Sensors are provided with 2 meter PVC fixed cables. 5 meter PVC, 2 and 5 meter PUR cables are optional and specified by selection of the last two digits of the part number. See chart below.

Cable Length & Material	Part No. Last Digits
2m PVC	00
5m PVC	02
2m PUR	10
5m PUR	12

QUICK DISCONNECT CONNECTORS

Pulsostronic sensors are available in a wide selection of Quick Disconnect styles for DC and AC circuits. While virtually any sensor can be custom manufactured with a Quick Disconnect connector, Altech offers one of the largest selection of standard Quick Disconnect models.

Fig. 8

CYLINDRICAL SENSOR INSTALLATION

Flush Mount Installation

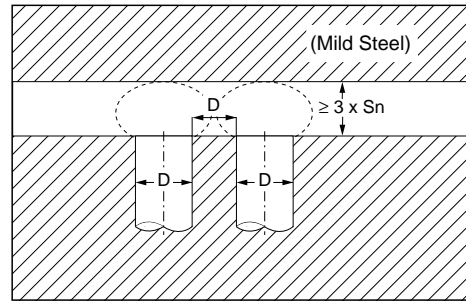

Non-Flush Mount Installation

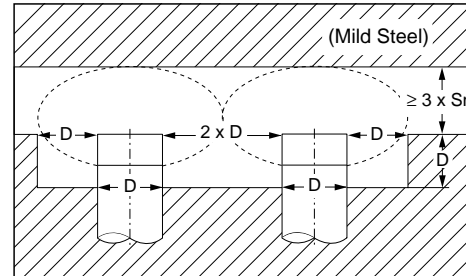

Opposing Installation

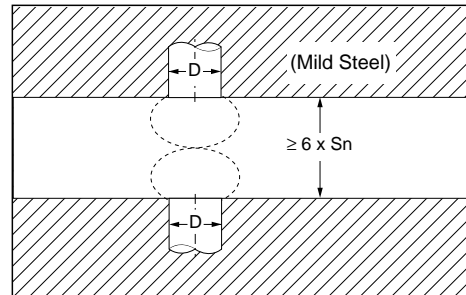

Quick Disconnect models are designed to be user-friendly and to simplify installations.

Please see the product specification for sensors with quick disconnect connectors and matching cable assemblies on pages 116 to 121 in the accessory section.

HOUSING MATERIALS

AC – Nickel Plated Brass
Trogamid T
Teflon Plated Brass
DC – Nickel Plated Brass
Trogamid T
Teflon Plated Brass
Stainless Steel



DC CYLINDRICAL SENSORS – SELECTION GUIDE

Series	Size (mm)	Sensing Distance mm (in.)													
		0.8mm (.03 in.)	1.0mm (.04 in.)	1.5mm (.06 in.)	2.0mm (.08 in.)	2.5mm (.10 in.)	3.0mm (.12 in.)	4.0mm (.16 in.)	5.0mm (.20 in.)	6.0mm (.23 in.)	7.0mm (.28 in.)	8.0mm (.32 in.)	10.0mm (.40 in.)	12.0mm (.47 in.)	
L Series 18-30V DC, 120mA • Short Body • Economically priced	M8			•	•										
	M12				•			•							
	M18								•			•			
	M30												•		
GL Series 10-60V DC, 400mA • 2 LED's • NO & NC models	M12				•			•							
	M18								•			•			
	M30												•		
Standard Series 10-30V DC, 200mA • Most quick disconnects • Industry standard • NO & NC models	M8			•	•										
	M12				•			•							
	M18								•			•			
	M30												•		
Extended Sensing 10-30V DC, 200mA • Up to 2x improvement over Standard	M8				•		•								
	M12							•							
	M18											•			
	M30														
Metal & Plastic 10-30V DC, 400mA • Extended Length • Higher Current Output	M12				•			•							
	M18								•			•			
	M30												•		
Mini Housing 10-30V DC, 200mA • 4, 5, 6.5mm diameter • Includes LED	4mm Dia.	•													
	M5	•													
	6.5mm Dia.			•			•								
Complementary Switching Output 10-30V DC, 200mA • NO & NC Outputs	M12				•			•							
	M18								•			•			
	M30												•		
High Speed 10-30V DC, 200mA • 4,000 Hz Switching Frequency	M12				•										
Extended Temperature 10-30V DC, 200mA • -40°C to 100°C	M12				•			•							
	M18										•	•			

						Mounting		Output Configuration				Connection				No. of Wires	Housing Material		No. of LED'S	Page	
14.0mm (.55 in.)	15.0mm (.59 in.)	20.0mm (.78 in.)	22.0mm (.86 in.)	40.0mm (1.5 in.)	Flush	Non-Flush	NPN	PNP	NO	NC	Cable 2m (6ft.6in.)	Quick Disconnect					Metal (BN) Brass Nickel Plated	Non-Metallic			
												62	63	64	65						
						•	•	•	•	•		•			•	•	3	•		1	16
						•	•	•	•	•		•			•	•	3	•		1	17
						•	•	•	•	•		•			•	•	3	•		1	18
		•				•	•	•	•	•		•			•	•	3	•		1	19
						•	•	•	•	•	•	•			•	•	3	•		2	20
						•	•	•	•	•	•	•			•	•	3	•		2	21
		•				•	•	•	•	•	•	•			•	•	3	•		2	22
						•	•	•	•	•	•	•		•	•	•	3	•		1	24
						•	•	•	•	•	•	•		•	•	•	3	•		1	25
						•	•	•	•	•	•	•		•	•	•	3	•		1	26
		•				•	•	•	•	•	•	•		•	•	•	3	•		1	27
						•	•	•	•	•	•	•		•	•	•	3	•		1	28
						•		•	•	•	•	•			•	•	3	•		1	29
						•		•	•	•	•	•			•	•	3	•		1	29
		•				•		•	•	•	•	•			•	•	3	•		1	30
						•	•	•	•	•	•	•			•	•	3	•	•	1	32
						•	•	•	•	•	•	•			•	•	3	•	•	1	32/33
		•				•	•	•	•	•	•	•			•	•	3	•	•	1	33
						•		•	•	•	•	•		•	•	•	3	•		1	34
						•		•	•	•	•	•		•	•	•	3	•		1	34
						•	•	•	•	•	•	•		•	•	•	3	• (ss)		1	35
								•	•	•	•	•			•	•	4	•		1	36
								•	•	•	•	•			•	•	4	•		1	37
		•						•	•	•	•	•			•	•	4	•		1	
						•		•	•	•	•	•			•	•	3	•		1	31
						•	•	•	•	•	•	•			•	•	3	•		1	38
						•	•	•	•	•	•	•			•	•	3	•		1	39

Continued on Page 14/15

DC CYLINDRICAL SENSORS – SELECTION GUIDE (Cont.)

Series	Size (mm)	Sensing Distance mm (in.)														
		0.8mm (.03 in.)	1.0mm (.04 in.)	1.5mm (.06 in.)	2.0mm (.08 in.)	2.5mm (.10 in.)	3.0mm (.12 in.)	4.0mm (.16 in.)	5.0mm (.20 in.)	6.0mm (.23 in.)	7.0mm (.28 in.)	8.0mm (.32 in.)	10.0mm (.40 in.)	12.0mm (.47 in.)		
Weld-Immune 10-30V DC, 200mA • Resistant to Electro-magnetic Interference • Teflon Plated	M12				•			•								
	M18								•			•				
	M30												•			
2-Wire 5-30V DC, 100mA 10-55V DC, 200mA • Reduce Wiring • Lower Cost	M12				•			•								
	M18								•			•				
	M30												•			
Extended Range Plus 10-30V DC, 200mA • Up to 3 times improvement over Standard	M8							•			•					
	M12										•		•			
	M18														•	
	M30															
Namur Requires External Amplifier • Low Energy Device • Operates in Hazardous Areas	M8		•		•											
	M12				•				•							
	M18									•			•			
	M30													•		
Analog 18-30V DC, 5mA • 1-9V Linear Output • Detects Target Distance	M12					•										
	M18								•							
	M30															

AC CYLINDRICAL SENSORS – SELECTION GUIDE

Series	Size	Sensing Distance (mm/in.)											Mounting		Output Configuration	
		0.8mm (.03 in.)	1.5mm (.06 in.)	2.0mm (.08 in.)	2.5mm (.10 in.)	4.0mm (.16 in.)	5.0mm (.20 in.)	7.0mm (.28 in.)	8.0mm (.32 in.)	10mm (.40 in.)	14.0mm (.55 in.)	15.0mm (.59 in.)	Flush	Non-Flush	NO	NC
Standard Series 90-250V AC, 180 mA • Large Selection of Quick Disconnects • NO or NC Outputs	M12			•		•							•	•	•	•
	M18							•		•			•	•	•	•
	M30									•		•	•	•	•	•
Extended Voltage, Metal 20-250V AC, 500 mA • High Current Output • NO or NC Outputs	M12			•		•							•	•	•	•
	M18							•		•			•	•	•	•
	M30									•		•	•	•	•	•
Extended Voltage, Plastic 20-250V AC, 500 mA • High Current Output • NO or NC Outputs	M12			•		•							•	•	•	•
	M18							•		•			•	•	•	•
	M30									•		•	•	•	•	•
Weld Immune 20-250V AC, 300/ 500 mA • Resistance to Electro - magnetic interference • Teflon Plated	M12			•		•							•	•	•	•
	M18							•		•			•	•	•	•
	M30									•		•	•	•	•	•

						Mounting		Output Configuration				Connection					No. of Wires	Housing Material		No. of LED'S	Page
14.0mm (.55 in.)	15.0mm (.59 in.)	20.0mm (.78 in.)	22.0mm (.86 in.)	40.0mm (1.5 in.)	Flush	Non-Flush	NPN	PNP	NO	NC	Cable 2m (6ft.6in.)	Quick Disconnect				Metal (BN) Brass Nickel Plated		Non-Metallic			
												62	63	64	65						
					•	•		•	•		•				•	3	•		1	40	
					•	•		•	•		•				•	3	•		1	41	
		•			•	•		•	•		•				•	3	•		1	42	
					•	•			•		•				•	2	•		1	54	
					•	•			•		•				•	2	•		1	54	
		•			•	•			•		•				•	2	•		1	55	
					•	•		•	•		•			•	•	3	•		1	46	
					•	•		•	•		•				•	3	•		1	47	
			•		•	•		•	•		•				•	3	•		1	48	
				•	•	•		•	•		•				•	3	•		1	49	
					•	•					•				•	2	•		0	50	
					•	•					•				•	2	•		0	51	
					•	•					•				•	2	•		0	52	
		•			•	•					•				•	2	•		0	53	
					•						•				•	3	•		0	44	
					•						•				•	3	•		0	44	
	•					•					•				•	3	•		0	45	





Connection						No. of Wires ⁽¹⁾	Housing Material		No. of LED'S	Page
Cable	62	66	67	68	Metal (BN)		Plastic			
•	•	•	•	•	2	•		1	56	
•	•	•	•	•	2	•		1	57	
•	•	•	•	•	2	•		1	58/59	
•				•	2	•		1	60	
•				•	2	•		1	61	
•				•	2	•		1	62/63	
•					2		•	1	60	
•					2		•	1	61	
•					2		•	1	62/63	
•				•	2	•		1	64	
•				•	2	•		1	65	
•				•	2	•		1	66	

(1) All metal sensors have a 3rd wire for optional system ground.

DC - 3 WIRE – L SERIES
Brass, Nickel Plated (BN),
Cylindrical, Threaded,
M8 – 10-30V DC, 200mA
M12-M30 – 18-30V DC, 120mA
1 LED for Output Energized

- **Short Body Sensors**
- **Economically priced**
- **Connector options**
- **Carries CE mark**

- IEC (529)IP67 (NEMA 1, 3, 4, 6, 12, 13) Protection
- Short Circuit Protection
- Overload Protection
- Reverse Polarity Protection
- Wire Break Resistance
- Temperature Range: -25 to 70°C (-13 to 158°F)

Sensing Distance	M8 Flush Mount 1.5mm (.06 in.)			M8 Non-Flush Mount 2mm (.08 in.)			
	Cable or Connector Style Cat. No.	Cable	64	65	Cable	64	65
PNP	Normally Open 	9981-2000	9981-2064	9981-2065	9981-2200	9981-2264	9981-2265
	Normally Closed 						
NPN	Normally Open 	9981-2100	9981-2164	9981-2165	9981-2300	9981-2364	9981-2365
	Normally Closed 						
Ripple Voltage		≤10%	≤10%	≤10%	≤10%	≤10%	≤10%
Voltage Range		10V - 30V	10V - 30V	10V - 30V	10V - 30V	10V - 30V	10V - 30V
Supply Current		≤10 mA	≤10 mA	≤10 mA	≤10 mA	≤10 mA	≤10 mA
Max. Load Current		200 mA	200 mA	200 mA	200 mA	200 mA	200 mA
Voltage Drop Across Sensor		≤2.4V	≤2.4V	≤2.4V	≤2.4V	≤2.4V	≤2.4V
Max. Leakage Current		≤10 μA	≤10 μA	≤10 μA	≤10 μA	≤10 μA	≤10 μA
Switching Frequency		2000Hz	2000Hz	2000Hz	2000Hz	2000Hz	2000Hz
Hysteresis		≤15%	≤15%	≤15%	≤15%	≤15%	≤15%
Temperature Drift		≤10%	≤10%	≤10%	≤10%	≤10%	≤10%
Repeatability		.15mm (.006 in.)	.15mm (.006 in.)	.15mm (.006 in.)	.20mm (.008 in.)	.20mm (.008 in.)	.20mm (.008 in.)
Front Cap Material		PBTP	PBTP	PBTP	PBTP	PBTP	PBTP

Fixed Cable

PVC 2m (6ft. 6in.). For 5m (16 ft. 5 in.) cable length, change the last two digits of the part number to 02. For other cable lengths and/or PUR cable, please consult Altech. Non-metallic locknuts for M8 and Brass, Nickel Plated (BN) locknuts for M12 through M30.

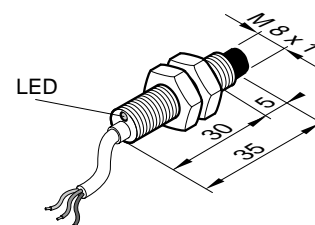
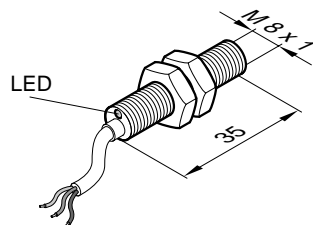

64 Style Connector

3-pin, Pico style, 8mm (.31 in.) supplied with non-metallic locknuts for M8 and Brass, Nickel Plated (BN) locknuts for M12 through M30.

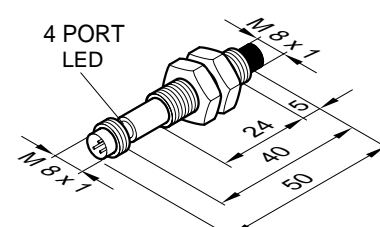
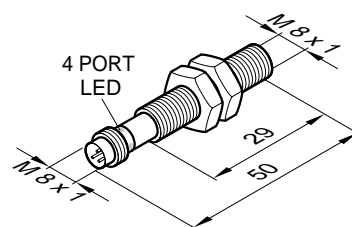

65 Style Connector

4-pin, Micro style, 12mm (.47 in.) supplied with non-metallic locknuts for M8 and Brass, Nickel Plated (BN) locknuts for M12 through M30.

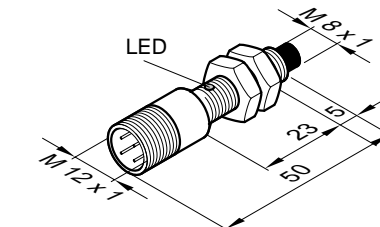
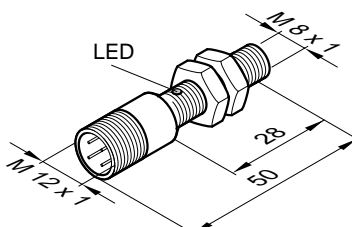

Metric/in. Conversion Table

1.0 mm = .04 in.	30.0 mm = 1.18 in.
5.0 mm = .20 in.	34.0 mm = 1.34 in.
6.0 mm = .23 in.	35.0 mm = 1.37 in.
8.0 mm = .31 in.	39.0 mm = 1.53 in.
12.0 mm = .47 in.	40.0 mm = 1.57 in.
23.0 mm = .91 in.	50.0 mm = 1.96 in.
24.0 mm = .94 in.	
28.0 mm = 1.10 in.	
29.0 mm = 1.14 in.	

This table converts millimeters to inches in reference to the illustrations included on these pages

Accessories

2 meter (6 ft. 6 in.) DC Cable Assemblies for Quick Disconnect Sensors

64 Connector	8000-5220	PVC, Straight
64 Connector	8000-5230	PVC, Right Angle, 2LED, PNP
64 Connector	8000-5240	PVC, Right Angle, 2LED, NPN
65 Connector	8000-5110	PVC, Straight
65 Connector	8000-5120	PVC, Right Angle
65 Connector	8000-5150	PVC, Right Angle, 2LED, NPN
65 Connector	8000-5160	PVC, Right Angle, 2LED, PNP

Change last digit of connector number to 5 for 5 meter cable

Refer to pages 116-121 for more cable information

Mounting Brackets – see Page 114-115

M12 Flush Mount

2mm (.08 in.)

M12 Non-Flush Mount

4mm (.16 in.)

Cable	64	65	Cable	64	65
9982-2000	9982-2064	9982-2065	9982-2200	9982-2264	9982-2265
9982-2100	9982-2164	9982-2165	9982-2300	9982-2364	9982-2365
≤10%	≤10%	≤10%	≤10%	≤10%	≤10%
18V - 30V	18V - 30V	18V - 30V	18V - 30V	18V - 30V	18V - 30V
≤10 mA	≤10 mA	≤10 mA	≤10 mA	≤10 mA	≤10 mA
120 mA	120 mA	120 mA	120 mA	120 mA	120 mA
≤1.5V	≤1.5V	≤1.5V	≤1.5V	≤1.5V	≤1.5V
≤10 μA	≤10 μA	≤10 μA	≤10 μA	≤10 μA	≤10 μA
2000Hz	2000Hz	2000Hz	1000Hz	1000Hz	1000Hz
≤15%	≤15%	≤15%	≤15%	≤15%	≤15%
≤10%	≤10%	≤10%	≤10%	≤10%	≤10%
.20mm (.008 in.)	.20mm (.008 in.)	.20mm (.008 in.)	.40mm (.016 in.)	.40mm (.016 in.)	.40mm (.016 in.)
PBTP	PBTP	PBTP	PBTP	PBTP	PBTP

Note: Sensor dimensions in mm.

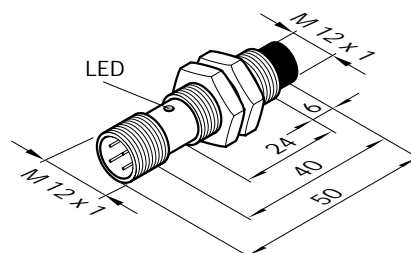
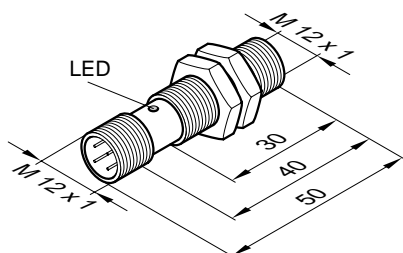
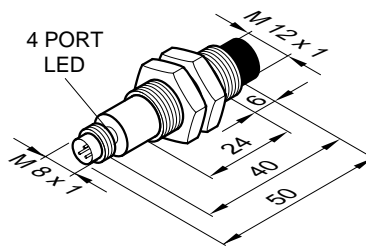
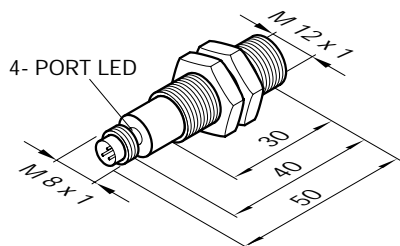
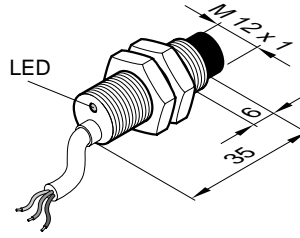
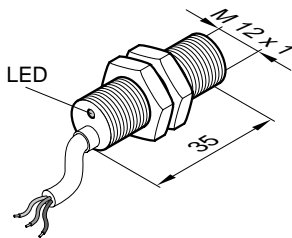

Wiring Diagrams

Note: Wire colors are applicable on cables purchased from Altech.

PNP

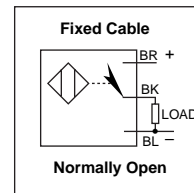

NPN

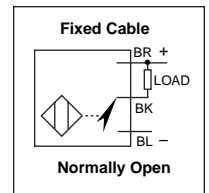

64 Connector

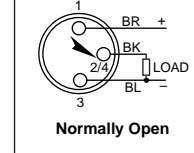

64 Connector

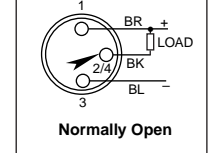

65 Connector

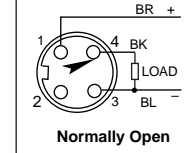



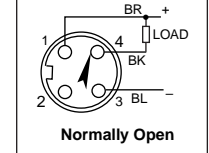

65 Connector



DC - 3 WIRE – L SERIES
Brass, Nickel Plated (BN),
Cylindrical, Threaded,
18-30V DC, 120mA
1 LED for Output Energized

- **Short Body Sensors**
- **Economically priced**
- **Connector options**
- **Carries C mark**

- IEC (529) IP67 (NEMA 1, 3, 4, 6, 12, 13) Protection
- Short Circuit Protection
- Overload Protection
- Reverse Polarity Protection
- Wire Break Resistance
- Temperature Range: -25 to 70°C (-13 to 158°F)

Sensing Distance	M18 Flush Mount 5mm (.20 in.)		M18 Non-Flush Mount 8mm (.31in.)	
	Cable	65	Cable	65
Cable or Connector Style Cat. No.				
PNP Normally Open 	9984-2000	9984-2065	9984-2200	9984-2265
	Normally Closed 			
NPN Normally Open 	9984-2100	9984-2165	9984-2300	9984-2365
	Normally Closed 			
Ripple Voltage	≤10%	≤10%	≤10%	≤10%
Voltage Range	18V - 30V	18V - 30V	18V - 30V	18V - 30V
Supply Current	≤10 mA	≤10 mA	≤10 mA	≤10 mA
Max. Load Current	120 mA	120 mA	120 mA	120 mA
Voltage Drop Across Sensor	≤1.5V	≤1.5V	≤1.5V	≤1.5V
Max. Leakage Current	≤10 µA	≤10 µA	≤10 µA	≤10 µA
Switching Frequency	1000Hz	1000Hz	500Hz	500Hz
Hysteresis	≤15%	≤15%	≤15%	≤15%
Temperature Drift	≤10%	≤10%	≤10%	≤10%
Repeatability	.50mm (.02 in.)	.50mm (.02 in.)	.80mm (.031 in.)	.80mm (.031 in.)
Front Cap Material	PBTP	PBTP	PBTP	PBTP

Fixed Cable

PVC 2m (6ft. 6in.). For 5m (16 ft. 5 in.) cable length, change the last two digits of the part number to 02. For other cable lengths and/or PUR cable, please consult Altech. Supplied with Brass, Nickel Plated (BN) locknuts.

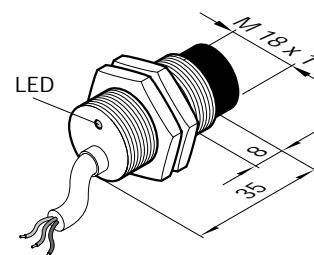
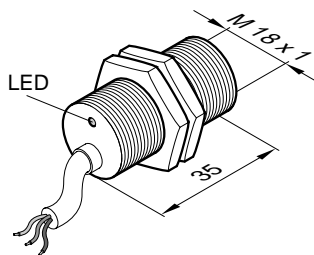

65 Style Connector

4-pin, Micro style, 12mm (.47 in.) supplied with Brass, Nickel Plated (BN) locknuts.

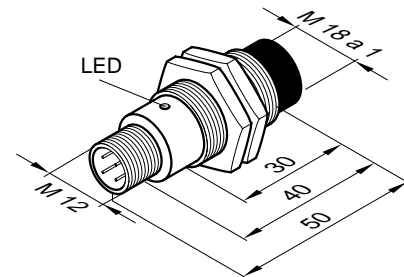
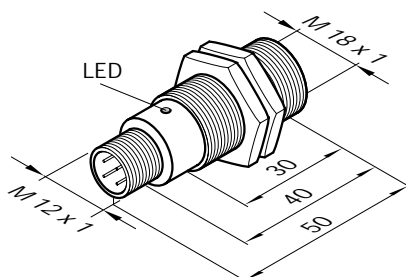

Metric/in. Conversion Table

1.5 mm = .06 in.	23.0 mm = .91 in.
2.0 mm = .08 in.	28.0 mm = 1.10 in.
4.0 mm = .16 in.	30.0 mm = 1.18 in.
5.0 mm = .20 in.	32.0 mm = 1.26 in.
6.0 mm = .23 in.	34.0 mm = 1.38 in.
8.0 mm = .31 in.	40.0 mm = 1.57 in.
10.0 mm = .39 in.	50.0 mm = 1.97 in.
12.0 mm = .47 in.	51.0 mm = 2.01 in.
15.0 mm = .59 in.	60.0 mm = 2.36 in.
18.0 mm = .70 in.	80.0 mm = 3.12 in.

This table converts millimeters to inches in reference to the illustrations included on these pages

M30 Flush Mount 10mm (.39 in.)

Cable	65
9986-2000	9986-2065
9986-2100	9986-2165
≤10%	≤10%
18V - 30V	18V - 30V
≤10 mA	≤10 mA
120 mA	120 mA
≤1.5V	≤1.5V
≤10 μA	≤10 μA
500Hz	500Hz
≤15%	≤15%
≤10%	≤10%
1.0mm (.039 in.)	1.0mm (.039 in.)
PBTP	PBTP

M30 Non-Flush Mount 15mm (.59 in.)

Cable	65
9986-2200	9986-2265
9986-2300	9986-2365
≤10%	≤10%
18V - 30V	18V - 30V
≤10 mA	≤10 mA
120 mA	120 mA
≤1.5V	≤1.5V
≤10 μA	≤10 μA
300Hz	300Hz
≤15%	≤15%
≤10%	≤10%
1.5mm (.059 in.)	1.5mm (.059 in.)
PBTP	PBTP

Note: Sensor dimensions in mm.

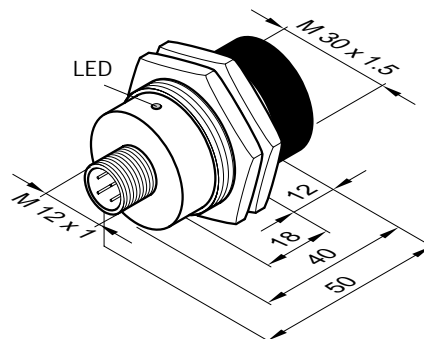
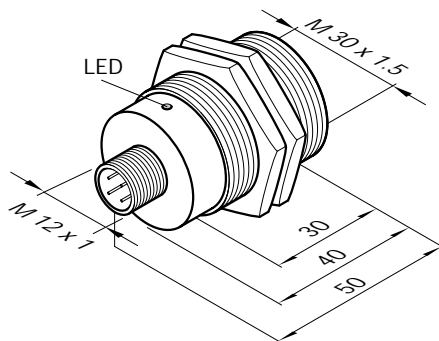
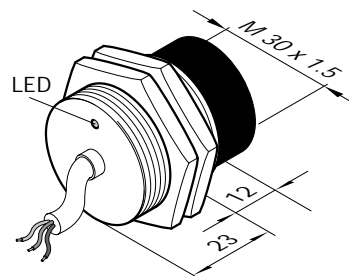
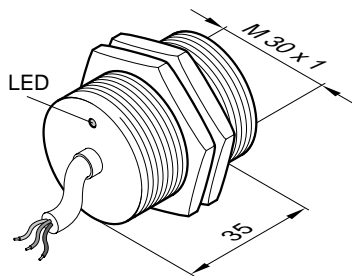

Accessories

2 meter (6 ft. 6 in.) DC Cable Assemblies for Quick Disconnect Sensors

65 Connector	8000-5110	PVC, Straight
65 Connector	8000-5120	PVC, Right Angle
65 Connector	8000-5150	PVC, Right Angle, 2LED, NPN
65 Connector	8000-5160	PVC, Right Angle, 2LED, PNP

Change last digit of connector number to 5 for 5 meter cable

Refer to pages 116-121 for more cable information

Mounting Brackets – see Pages 114-115

Wiring Diagrams

Note: Wire colors are applicable on cables purchased from Altech

PNP

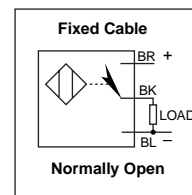

NPN

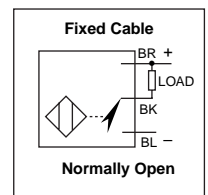

65 Connector

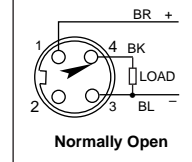



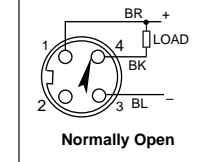

65 Connector



DC - 3 WIRE – GL SERIES
Brass, Nickel Plated (BN),
Cylindrical, Threaded,
10-60V DC, 400mA,
2 LED's for Operating Voltage
and Output Energized

- **Higher Current Output**
- **Higher Voltage Range**
- **Carries $\text{C}\epsilon$ mark**

- IEC (529) IP67 (NEMA 1, 3, 4, 6, 12, 13) Protection
- Short Circuit Protection
- Overload Protection
- Reverse Polarity Protection
- Wire Break Resistance
- Temperature Range: -25 to 70°C (-13 to 158°F)

Sensing Distance		M12 Flush Mount 2mm (.08 in.)			M12 Non-Flush Mount 4mm (.16 in.)		
		Cable	64	65	Cable	64	65
PNP	Normally Open 	9982-4000	9982-4064	9982-4065	9982-4200	9984-4264	9982-4265
	Normally Closed 	9982-4400	9982-4464	9982-4465	9982-4600	9982-4664	9982-4665
NPN	Normally Open 	9982-4100	9982-4164	9982-4165	9982-4300	9982-4364	9982-4365
	Normally Closed 	9982-4500	9982-4564	9982-4565	9982-4700	9982-4764	9982-4765
Ripple Voltage		≤10%	≤10%	≤10%	≤10%	≤10%	≤10%
Voltage Range		10V - 60V	10V - 60V	10V - 60V	10V - 60V	10V - 60V	10V - 60V
Supply Current		≤10 mA	≤10 mA	≤10 mA	≤10 mA	≤10 mA	≤10 mA
Max. Load Current		400 mA	400 mA	400 mA	400 mA	400 mA	400 mA
Voltage Drop Across Sensor		≤2.4V	≤2.4V	≤2.4V	≤2.4V	≤2.4V	≤2.4V
Max. Leakage Current		≤10 μA	≤10 μA	≤10 μA	≤10 μA	≤10 μA	≤10 μA
Switching Frequency		2000Hz	2000Hz	2000Hz	1000Hz	1000Hz	1000Hz
Hysteresis		≤15%	≤15%	≤15%	≤15%	≤15%	≤15%
Temperature Drift		≤10%	≤10%	≤10%	≤10%	≤10%	≤10%
Repeatability		.20mm (.008 in.)	.20mm (.008 in.)	.20mm (.008 in.)	.40mm (.016 in.)	.40mm (.016 in.)	.40mm (.016 in.)
Front Cap Material		PBTP	PBTP	PBTP	PBTP	PBTP	PBTP

Fixed Cable

PVC 2m (6ft. 6in.). For 5m (16 ft. 5 in.) cable length, change the last two digits of the part number to 02. For other cable lengths and/or PUR cable, please consult Altech. Supplied with Brass, Nickel Plated (BN) locknuts.

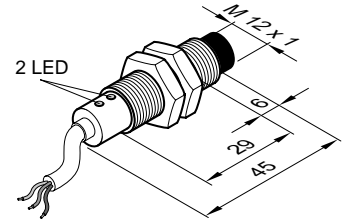
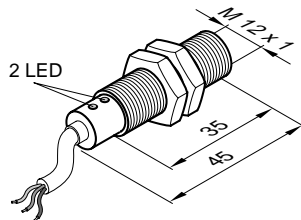

64 Style Connector

3-pin, Pico style, 8mm (.31 in.) supplied with Brass, Nickel Plated (BN) locknuts.

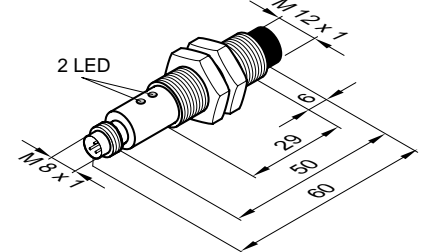
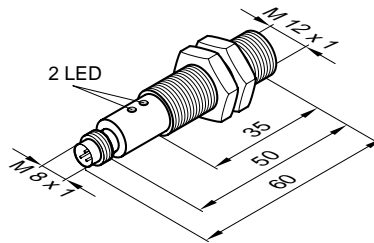

65 Style Connectors

4-pin, Micro style, 12mm (.47 in.) supplied with Brass, Nickel Plated (BN) locknuts.

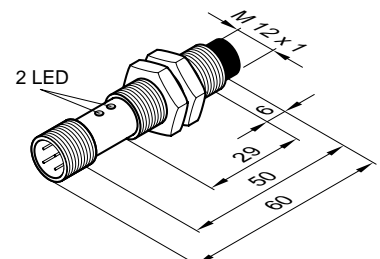
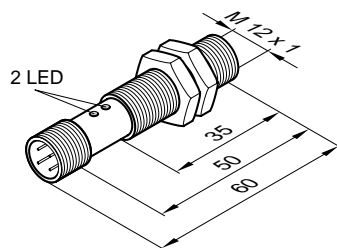

Metric/in. Conversion Table

1.0 mm = .04 in.	29.0 mm = 1.14 in.	This table converts millimeters to inches in reference to the illustrations included on these pages
6.0 mm = .23 in.	35.0 mm = 1.37 in.	
8.0 mm = .31 in.	45.0 mm = 1.77 in.	
12.0 mm = .47 in.	50.0 mm = 1.97 in.	
18.0 mm = .70 in.	60.0 mm = 2.36 in.	
.27.0 mm = 1.06 in.	80.0 mm = 3.15 in.	

M18 Flush Mount 5mm (.20 in.)

Cable	65
9984-4000	9984-4065
9984-4400	9984-4465
9984-4100	9984-4165
9984-4500	9984-4565
≤10%	≤10%
10V - 60V	10V - 60V
≤10 mA	≤10 mA
400 mA	400 mA
≤2.4V	≤2.4V
≤10 μA	≤10 μA
1000Hz	1000Hz
≤15%	≤15%
≤10%	≤10%
.25mm (.01 in.)	.25mm (.01 in.)
PBTP	PBTP

M18 Non-Flush Mount 8mm (.31 in.)

Cable	65
9984-4200	9984-4265
9984-4600	9984-4665
9984-4300	9984-4365
9984-4700	9984-4765
≤10%	≤10%
10V - 60V	10V - 60V
≤10 mA	≤10 mA
400 mA	400 mA
≤2.4V	≤2.4V
≤10 μA	≤10 μA
500Hz	500Hz
≤15%	≤15%
≤10%	≤10%
.40mm (.016 in.)	.40mm (.016 in.)
PBTP	PBTP

Note: Sensor dimensions in mm.

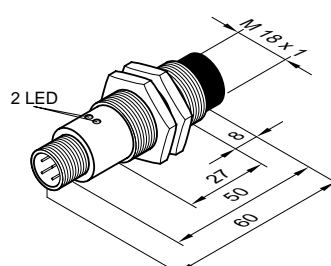
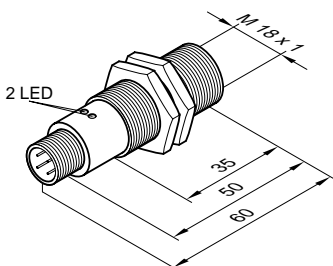
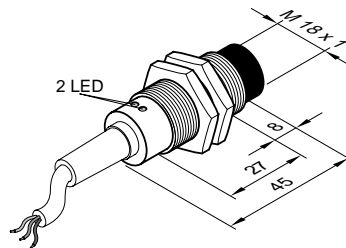
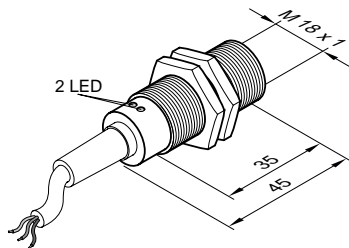

Accessories

2 meter (6 ft. 6 in.) DC Cable Assemblies for Quick Disconnect Sensors

- 64 Connector 8000-5220 PVC, Straight
- 64 Connector 8000-5230 PVC, Right Angle, 2LED, NPN
- 64 Connector 8000-5240 PVC, Right Angle, 2LED, NPN

65 Connectors, 4 PIN - 3 Wire cable (PIN 1, 3, 4) :

- 65 Connector 8000-5110 PVC, Straight
- 65 Connector 8000-5120 PVC, Right Angle
- 65 Connector 8000-5150 PVC, Right Angle, 2LED, NPN
- 65 Connector 8000-5160 PVC, Right Angle, 2LED, NPN

65 Connectors, 4 PIN - 4 Wire cable (PIN 1, 2, 3, 4) :

- 65 Connector 8000-5280 PVC Right Angle

Change last digit of connector number to 5 for 5 meter cable

Refer to pages 116-121 for more cable information

Mounting Brackets - see Pages 114-115

Wiring Diagrams

Note: Wire colors are applicable on cables purchased from Altech

NPN

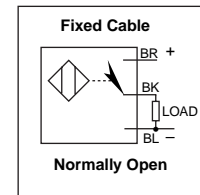



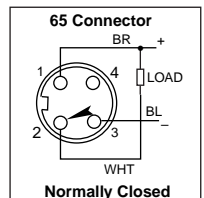
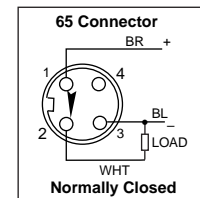
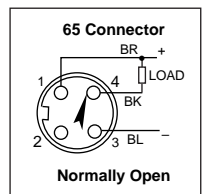
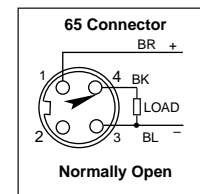
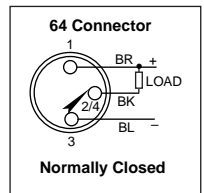
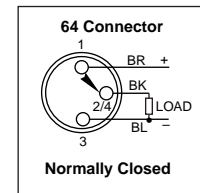
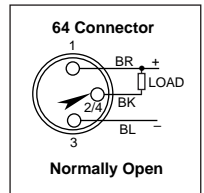
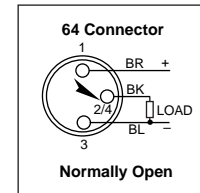
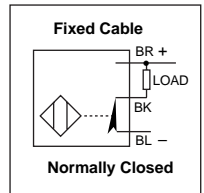
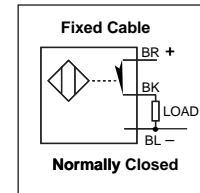
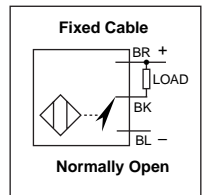

NPN



DC - 3 WIRE – GL SERIES
Brass, Nickel Plated (BN),
Cylindrical, Threaded,
10-60V DC, 400mA
2 LED's for Operating Voltage
and Output Energized

- **Higher Current Output**
- **Higher Voltage Range**
- **Carries CE mark**

- IEC (529) IP67 (NEMA 1, 3, 4, 6, 12, 13) Protection
- Short Circuit Protection
- Overload Protection
- Reverse Polarity Protection
- Wire Break Resistance
- Temperature Range: -25 to 70°C (-13 to 158°F)

M30 Flush Mount			M30 Non-Flush Mount		
Sensing Distance			15mm (.59 in.)		
10mm (.39 in.)					
Cable or Connector Style Cat. No.		Cable	65	Cable	65
PNP	Normally Open 	9986-4000	9986-4065	9986-4200	9986-4265
	Normally Closed 	9986-4400	9986-4465	9986-4600	9986-4665
NPN	Normally Open 	9986-4100	9986-4165	9986-4300	9986-4365
	Normally Closed 	9986-4500	9986-4565	9986-4700	9986-4765
Ripple Voltage		≤10%	≤10%	≤10%	≤10%
Voltage Range		10V-60V	10V - 60V	10V - 60V	10V - 60V
Supply Current		≤10 mA	≤10 mA	≤10 mA	≤10 mA
Max. Load Current		400 mA	400 mA	400 mA	400 mA
Voltage Drop Across Sensor		≤2.4V	≤2.4V	≤2.4V	≤2.4V
Max. Leakage Current		≤10 µA	≤10 µA	≤10 µA	≤10 µA
Switching Frequency		500 Hz	500 Hz	300 Hz	300 Hz
Hysteresis		≤15%	≤15%	≤15%	≤15%
Temperature Drift		≤10%	≤10%	≤10%	≤10%
Repeatability		.50mm (.020 in.)	.50mm (.020 in.)	.75mm (.030 in.)	.75mm (.030 in.)
Front Cap Material		PBTP	PBTP	PBTB	PBTB

Note: Sensor dimensions in mm.

Fixed Cable

PVC 2m (6ft. 6in.). For 5m (16 ft. 5 in.) cable length, change the last two digits of the part number to 02. For other cable lengths and/or PUR cable, please consult Altech. Supplied with Brass, Nickel Plated (BN) locknuts.

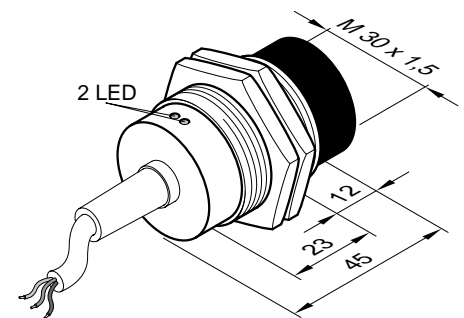
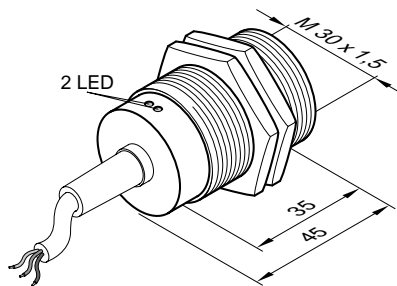

65 Style Connector

4-pin, Micro style, 12mm (.47 in.) supplied with Brass, Nickel Plated (BN) locknuts.

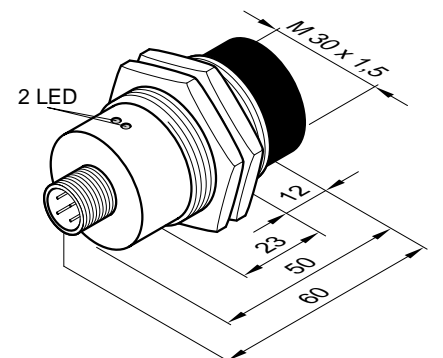
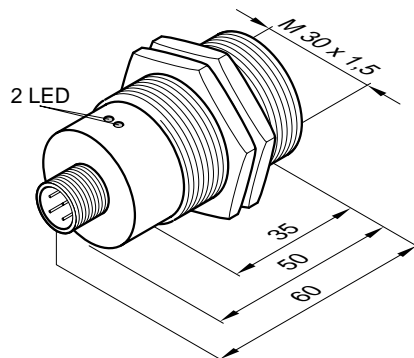

Accessories

2 meter (6 ft. 6 in.) DC Cable Assemblies for Quick Disconnect Sensors

65 Connectors, 4 PIN – 3 Wire cable (PIN 1, 3, 4) :

- 65 Connector 8000-5110 PVC, Straight
- 65 Connector 8000-5120 PVC, Right Angle
- 65 Connector 8000-5150 PVC, Right Angle, 2LED, NPN
- 65 Connector 8000-5160 PVC, Right Angle, 2LED, PNP

65 Connectors, 4PIN – 4 Wire cable (PIN 1, 2, 3, 4) :

- 65 Connectors 8000-5280 PVC, Right Angle

Change last digit of connector number to 5 for 5 meter cable

Refer to pages 116-121 for more cable information

Metric/in. Conversion Table

1.5 mm = .06 in.	45.0 mm = 1.77 in.
12.0 mm = .47 in.	50.0 mm = 1.96 in.
23.0 mm = .90 in.	60.0 mm = 2.36 in.
35.0 mm = 1.37 in.	

This table converts millimeters to inches in reference to the illustrations included on these pages

Mounting Brackets – see Pages 114-115

Wiring Diagrams

Note: Wire colors are applicable on cable purchased from Altech

PNP



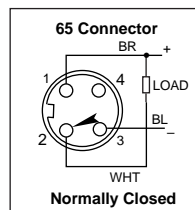
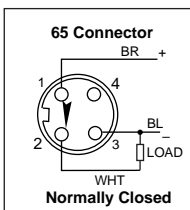
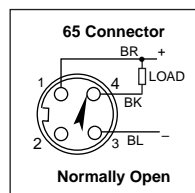
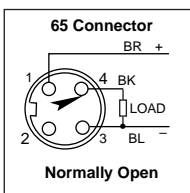
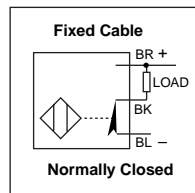
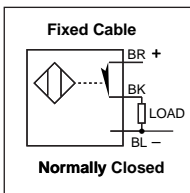
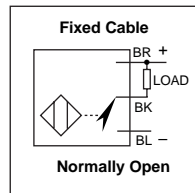
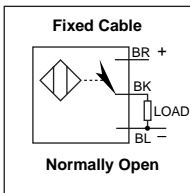

NPN



**DC - 3 WIRE STANDARD
Brass, Nickel Plated (BN),
Cylindrical, Threaded,
10-30V DC, 200 mA,
1 LED for Output Energized**

- **Most complete range of Fixed Cable and Quick Disconnect Styles**
- **Available in normally open (N.O.) and normally closed (N.C.) output configuration**
- **Industry standard 10-30V DC operating voltage and 200mA output current**
- **Carries $\text{C}\epsilon$ mark**

- IEC (529) IP67 (NEMA 1, 3, 4, 6, 12, 13) Protection
- Short Circuit Protection
- Overload Protection
- Reverse Polarity Protection
- Wire Break Resistance
- Temperature Range:
-25 to 70°C (-13 to 158°F)

M8 Flush Mount					M8 Non-Flush Mount				
Sensing Distance					Sensing Distance				
1.5mm (.06 in.)					2mm (.08 in.)				
Cable or Connector Style Cat. No.	Cable	63	64	65	Cable	63	64	65	
PNP	Normally Open 	9961-0200	9961-0263	9961-0264	9961-0265	9961-0400	9961-0463	9961-0464	9961-0465
	Normally Closed 	9961-4400		9961-4464	9961-4465	9961-4600		9961-4664	9961-4665
NPN	Normally Open 	9961-0300	9961-0363	9961-0364	9961-0365	9961-0500	9961-0563	9961-0564	9961-0565
	Normally Closed 	9961-4500		9961-4564	9961-4565	9961-4700		9961-4764	9961-4765
Ripple Voltage	≤10%	≤10%	≤10%	≤10%	≤10%	≤10%	≤10%	≤10%	
Voltage Range	10V-30V	10V - 30V	10V - 30V	10V - 30V	10V - 30V	10V - 30V	10V - 30V	10V - 30V	
Supply Current	≤10 mA	≤10 mA	≤10 mA	≤10 mA	≤10 mA	≤10 mA	≤10 mA	≤10 mA	
Max. Load Current	200 mA	200 mA	200 mA	200 mA	200 mA	200 mA	200 mA	200 mA	
Voltage Drop Across Sensor	≤2.4V	≤2.4V	≤2.4V	≤2.4V	≤2.4V	≤2.4V	≤2.4V	≤2.4V	
Max. Leakage Current	≤10 μA	≤10 μA	≤10 μA	≤10 μA	≤10 μA	≤10 μA	≤10 μA	≤10 μA	
Switching Frequency	2000 Hz	2000 Hz	2000 Hz	2000 Hz	2000 Hz	2000 Hz	2000 Hz	2000 Hz	
Hysteresis	≤15%	≤15%	≤15%	≤15%	≤15%	≤15%	≤15%	≤15%	
Temperature Drift	≤10%	≤10%	≤10%	≤10%	≤10%	≤10%	≤10%	≤10%	
Repeatability	.15mm (.006 in.)	.15mm (.006 in.)	.15mm (.006 in.)	.15mm (.006 in.)	.20mm (.008 in.)	.20mm (.008 in.)	.20mm (.008 in.)	.20mm (.008 in.)	
Front Cap Material	PBTP	PBTP	PBTP	PBTP	PBTP	PBTP	PBTP	PBTP	

Fixed Cable

PVC 2m (6ft. 6in.). For 5m (16 ft. 5 in.) cable length, change the last two digits of the part number to 02. For other cable lengths and/or PUR cable, please consult Altech. Non-metallic locknuts for M8 and Brass, Nickel Plated (BN) locknuts for M12 through M30.

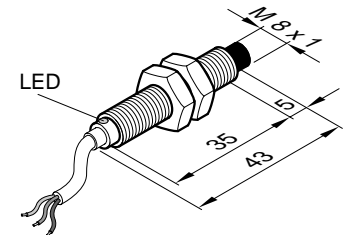
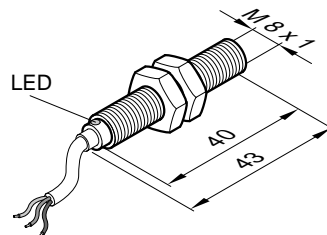

64 Style Connector

3-pin, Pico style, 8mm (.31 in.) supplied with non-metallic locknuts for M8 and Brass, Nickel Plated (BN) locknuts for M12 through M30.

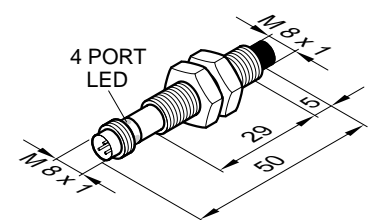
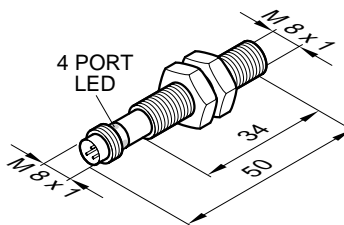

63 and 65 Style Connectors

4-pin, Micro style, 12mm (.47 in.) supplied with Non-metallic locknuts for M8 and Brass, Nickel Plated (BN) locknuts for M12 through M30. The 63 Connector is clear, offering 360° LED viewing.

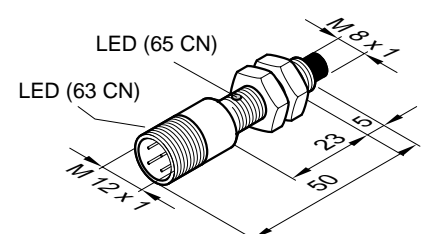
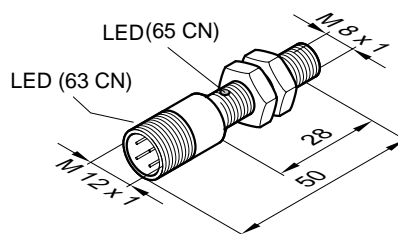

Metric/in. Conversion Table

1.0 mm = .04 in.	29.0 mm = 1.14 in.
5.0 mm = .20 in.	34.0 mm = 1.34 in.
6.0 mm = .23 in.	35.0 mm = 1.37 in.
8.0 mm = .31 in.	40.0 mm = 1.57 in.
12.0 mm = .47 in.	43.0 mm = 1.69 in.
23.0 mm = .90 in.	50.0 mm = 1.47 in.
28.0 mm = 1.10 in.	60.0 mm = 2.36 in.

This table converts millimeters to inches in reference to the illustrations included on these pages

M12 Flush Mount

2mm (.08 in.)

Cable	63	64	65
9962-4000	9962-4063	9962-4064	9962-4065
9962-4400		9962-4464	9962-4465
9962-4100	9962-4163	9962-4164	9962-4165
9962-4500		9962-4564	9962-4565
≤10%	≤10%	≤10%	≤10%
10V - 30V	10V - 30V	10V - 30V	10V - 30V
≤10 mA	≤10 mA	≤10 mA	≤10 mA
200 mA	200 mA	200 mA	200 mA
≤2.4V	≤2.4V	≤2.4V	≤2.4V
≤10 μA	≤10 μA	≤10 μA	≤10 μA
2000 Hz	2000 Hz	2000 Hz	2000 Hz
≤15%	≤15%	≤15%	≤15%
≤10%	≤10%	≤10%	≤10%
.20mm (.008in.)	.20mm (.008in.)	.20mm (.008in.)	.20mm (.008in.)
PBTB	PBTB	PBTB	PBTB

M12 Non-Flush Mount

4mm (.16 in.)

Cable	63	64	65
9962-4200	9962-4263	9962-4264	9962-4265
9962-4600		9962-4664	9962-4665
9962-4300	9961-4363	9962-4364	9962-4365
9962-4700		9962-4764	9962-4765
≤10%	≤10%	≤10%	≤10%
10V - 30V	10V - 30V	10V - 30V	10V - 30V
≤10 mA	≤10 mA	≤10 mA	≤10 mA
200 mA	200 mA	200 mA	200 mA
≤2.4V	≤2.4V	≤2.4V	≤2.4V
≤10 μA	≤10 μA	≤10 μA	≤10 μA
1000 Hz	1000 Hz	1000 Hz	1000 Hz
≤15%	≤15%	≤15%	≤15%
≤10%	≤10%	≤10%	≤10%
.40mm (.016in.)	.40mm (.016in.)	.40mm (.016in.)	.40mm (.016in.)
PBTB	PBTB	PBTB	PBTB

Note: Sensor dimensions in mm.

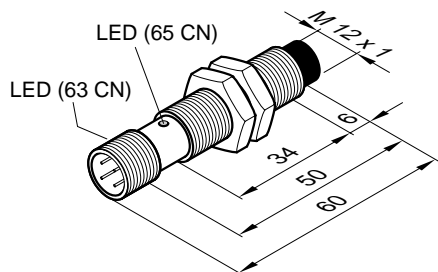
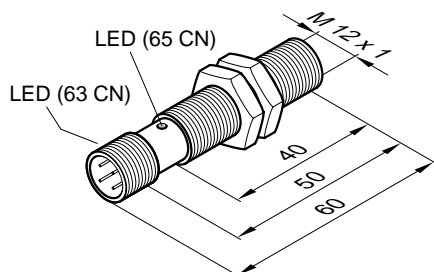
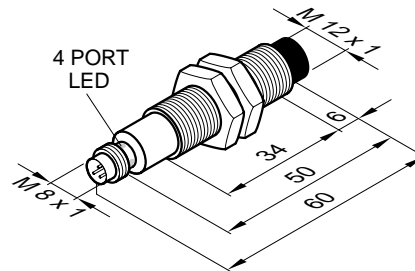
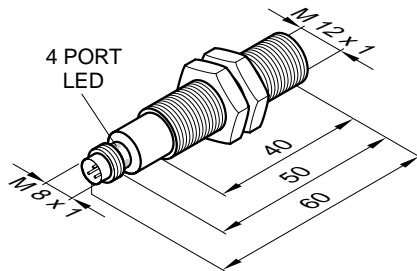
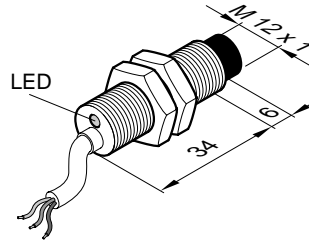
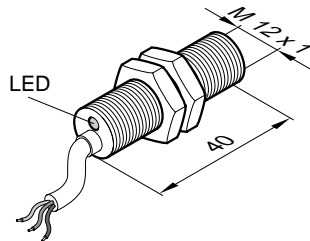

Accessories

2 meter (6 ft. 6 in.) DC Cable Assemblies for Quick Disconnect Sensors

- 64 Connector 8000-5220 PVC, Straight
- 64 Connector 8000-5230 PVC, Right Angle, 2LED, PNP
- 64 Connector 8000-5240 PVC, Right Angle, 2LED, NPN

63/65 Connectors, 4 PIN - 3 Wire cable (PIN 1, 3, 4) :

- 63/65 Connector 8000-5110 PVC, Straight
- 63/65 Connector 8000-5120 PVC, Right Angle
- 63/65 Connector 8000-5150 PVC, Right Angle, 2LED, NPN
- 63/65 Connector 8000-5160 PVC, Right Angle, 2LED, PNP

63/65 Connectors, 4PIN - 4 Wire cable (PIN 1, 2, 3, 4) :

- 63/65 Connectors 8000-5280 PVC, Right Angle

Change last digit of connector number to 5 for 5 meter cable

Refer to pages 116-121 for more cable information

Mounting Brackets - see Pages 114-115

Wiring Diagrams

Note: Wire colors are applicable to cable purchased from Altech

PNP

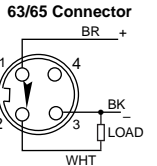
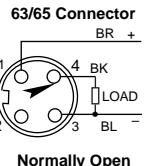
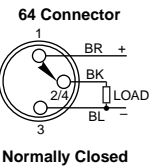
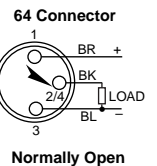
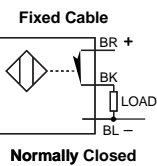
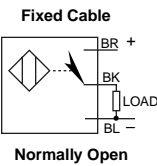



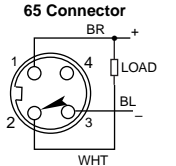
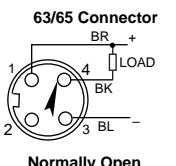
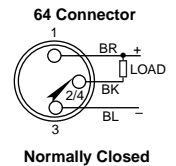
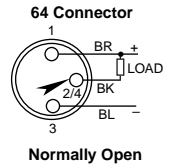
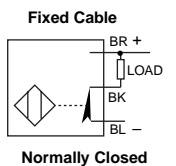
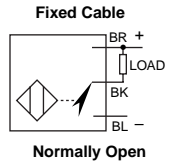

NPN



**DC - 3 WIRE – STANDARD
Brass, Nickel Plated (BN),
Cylindrical, Threaded,
10-30V DC, 200mA,
1 LED for Output Energized**

- **Most complete range of Fixed Cable and Quick Disconnect Styles**
- **Available in normally open (N.O.) and normally closed (N.C.) output configuration**
- **Industry standard 10-30V DC operating voltage and 200mA output current**
- **Carries C€ mark**

- IEC(529) IP67 (NEMA 1, 3, 4, 6, 12, 13) Protection
- Short Circuit Protection
- Overload Protection
- Reverse Polarity Protection
- Wire Break Resistance
- Temperature Range: -25 to 70°C (-13 to 158°F)

M18 Flush Mount				M18 Non-Flush Mount			
Sensing Distance		5mm (.20 in.)			8mm (.31 in.)		
Cable or Connector Style	Cat. No.	Cable	63	65	Cable	63	65
PNP	Normally Open 	9964-4000	9964-4063	9964-4065	9964-4200	9964-4263	9964-4265
	Normally Closed 	9964-4400		9964-4465	9964-4600		9964-4665
NPN	Normally Open 	9964-4100	9964-4163	9964-4165	9964-4300	9964-4363	9964-4365
	Normally Closed 	9964-4500		9964-4565	9964-4700		9964-4765
Ripple Voltage		≤10%	≤10%	≤10%	≤10%	≤10%	≤10%
Voltage Range		10V - 30V	10V - 30V	10V - 30V	10V - 30V	10V - 30V	10V - 30V
Supply Current		≤10 mA	≤10 mA	≤10 mA	≤10 mA	≤10 mA	≤10 mA
Max. Load Current		200 mA	200 mA	200 mA	200 mA	200 mA	200 mA
Voltage Drop Across Sensor		≤2.4V	≤2.4V	≤2.4V	≤2.4V	≤2.4V	≤2.4V
Max. Leakage Current		≤10 μA	≤10 μA	≤10 μA	≤10 μA	≤10 μA	≤10 μA
Switching Frequency		1000 Hz	1000 Hz	1000 Hz	500 Hz	500 Hz	500 Hz
Hysteresis		≤15%	≤15%	≤15%	≤15%	≤15%	≤15%
Temperature Drift		≤10%	≤10%	≤10%	≤10%	≤10%	≤10%
Repeatability		.25mm (.01 in.)	.25mm (.01 in.)	.25mm (.01 in.)	.40mm (.016 in.)	.40mm (.016 in.)	.40mm (.016 in.)
Front Cap Material		PBTP	PBTP	PBTP	PBTB	PBTB	PBTB

Fixed Cable

PVC 2m (6ft. 6in.). For 5m (16 ft. 5 in.) cable length, change the last two digits of the part number to 02. For other cable lengths and/or PUR cable, please consult Altech. Supplied with Brass, Nickel Plated (BN) locknuts.

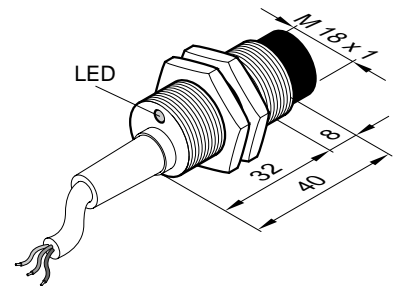
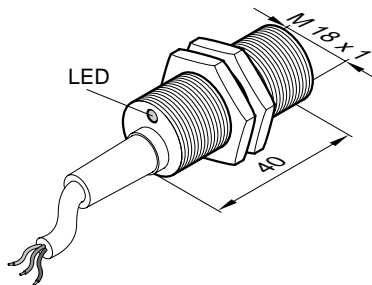

63 and 65 Style Connectors

4-pin, Micro style, 12mm (.47 in.) supplied with Brass, Nickel Plated (BN) locknuts. The 63 Connector is clear, offering 360° LED viewing.

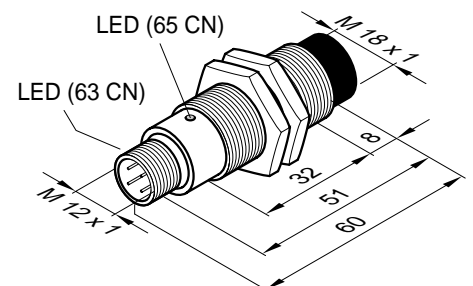
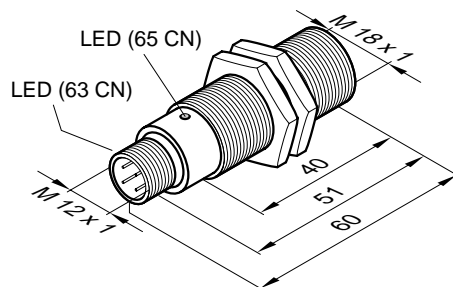

Metric/in. Conversion Table

1.5 mm = .06 in.	23.0 mm = .91 in.
2.0 mm = .08 in.	28.0 mm = 1.10 in.
4.0 mm = .16 in.	30.0 mm = 1.18 in.
5.0 mm = .20 in.	32.0 mm = 1.26 in.
6.0 mm = .23 in.	34.0 mm = 1.34 in.
8.0 mm = .31 in.	40.0 mm = 1.57 in.
10.0 mm = .39 in.	50.0 mm = 1.97 in.
12.0 mm = .47 in.	51.0 mm = 2.01 in.
15.0 mm = .59 in.	60.0 mm = 2.36 in.
18.0 mm = .70 in.	80.0 mm = 3.12 in.

This table converts millimeters to inches in reference to the illustrations included on these pages

M30 Flush Mount

10mm (.39 in.)

Cable	63	65
9966-4000	9966-4063	9966-4065
9966-4400		9966-4465
9966-4100	9966-4163	9966-4165
9966-4500		9966-4565
≤10%	≤10%	≤10%
10V - 30V	10V - 30V	10V - 30V
≤10 mA	≤10 mA	≤10 mA
200 mA	200 mA	200 mA
≤2.4V	≤2.4V	≤2.4V
≥10 μA	≥10 μA	≥10 μA
500 Hz	500 Hz	500 Hz
≤15%	≤15%	≤15%
≤10%	≤10%	≤10%
.50mm (.02 in.)	.50mm (.02 in.)	.50mm (.02 in.)
PBTB	PBTB	PBTB

M30 Non-Flush Mount

15mm (.59 in.)

Cable	63	65
9966-4200	9966-4263	9966-4265
9966-4600		9966-4665
9966-4300		9966-4365
9966-4700		9966-4765
≤10%	≤10%	≤10%
10V - 30V	10V - 30V	10V - 30V
≤10 mA	≤10 mA	≤10 mA
200 mA	200 mA	200 mA
≤2.4V	≤2.4V	≤2.4V
≥10 μA	≥10 μA	≥10 μA
300 Hz	300 Hz	300 Hz
≤15%	≤15%	≤15%
≤10%	≤10%	≤10%
.75mm (.03 in.)	.75mm (.03 in.)	.75mm (.03 in.)
PBTB	PBTB	PBTB

Note: Sensor dimensions in mm.

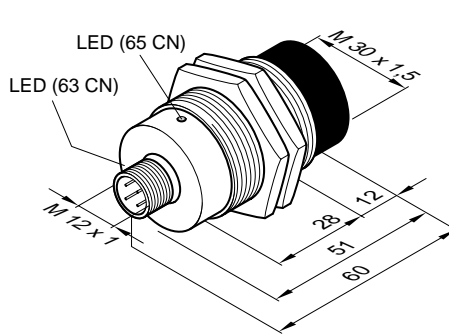
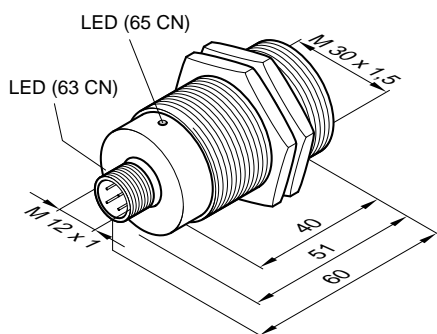
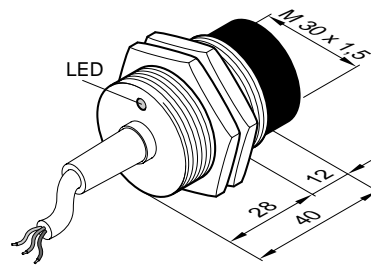
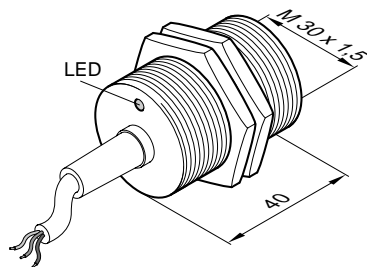

Accessories

2 meter (6 ft. 6 in.) DC Cable Assemblies for Quick Disconnect Sensors

63/65 Connectors, 4 PIN – 3 Wire cable (PIN 1, 3, 4) :

63/65 Connector 8000-5110 PVC, Straight

63/65 Connector 8000-5120 PVC, Right Angle

63/65 Connector 8000-5150 PVC, Right Angle, 2LED, NPN

63/65 Connector 8000-5160 PVC, Right Angle, 2LED, PNP

63/65 Connectors, 4PIN – 4 Wire cable (PIN 1, 2, 3, 4) :

63/65 Connectors 8000-5280 PVC, Right Angle

Change last digit of connector number to 5 for 5 meter cable

Refer to pages 116-121 for more cable information

Mounting Brackets – see Pages 114-115

Wiring Diagrams

Note: Wire colors are applicable to cable purchased from Altech

PNP

NPN

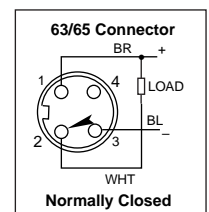
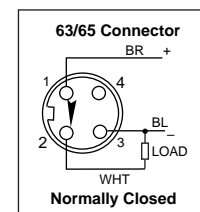
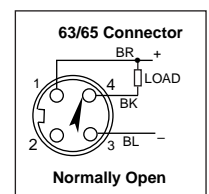
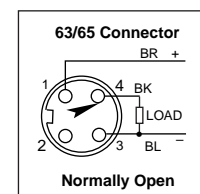
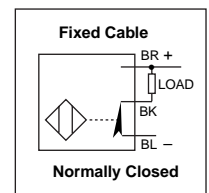
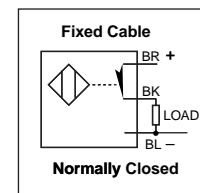
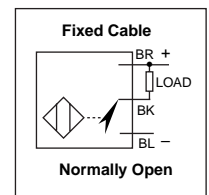
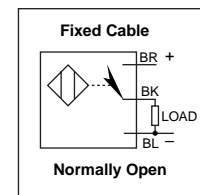

DC - 3 WIRE – EXTENDED SENSING DISTANCE
Brass, Nickel Plated (BN), Cylindrical, Threaded, 10-30V DC, 200mA
1 LED for Output Energized

- **Up to 2 times sensing distance over standard sensors**
- **Reduces accidental collisions**
- **Ideal for applications where larger sensing distance is required but mounting space is tight**
- **Carries C mark**

- IEC(529) IP67 (NEMA 1, 3, 4, 6, 12, 13) Protection
- Short Circuit Protection
- Overload Protection
- Reverse Polarity Protection
- Wire Break Resistance
- Temperature Range: -25 to 70°C (-13 to 158°F)

M8 Flush Mount				M8 Non-Flush Mount			
Sensing Distance 2mm (.08 in.)				Sensing Distance 3mm (.12 in.)			
Cable or Connector Style	Cat. No.	Cable	64	65	Cable	64	65
PNP	Normally Open	9981-4000	9981-4064	9981-4065	9981-4200	9981-4264	9981-4265
	Normally Closed						
NPN	Normally Open	9981-4100	9981-4164	9981-4165	9981-4300	9981-4364	9981-4365
	Normally Closed						
Ripple Voltage		≤10%	≤10%	≤10%	≤10%	≤10%	≤10%
Voltage Range		10V-30V	10V - 30V	10V - 30V	10V - 30V	10V - 30V	10V - 30V
Supply Current		≤12 mA	≤12 mA	≤12 mA	≤12 mA	≤12 mA	≤12 mA
Max. Load Current		200 mA	200 mA	200 mA	200 mA	200 mA	200 mA
Voltage Drop Across Sensor		≤2.4V	≤2.4V	≤2.4V	≤2.4V	≤2.4V	≤2.4V
Max. Leakage Current		≤10 μA	≤10 μA	≤10 μA	≤10 μA	≤10 μA	≤10 μA
Switching Frequency		2000 Hz	2000 Hz	2000 Hz	2000 Hz	2000 Hz	2000 Hz
Hysteresis		≤15%	≤15%	≤15%	≤15%	≤15%	≤15%
Temperature Drift		≤10%	≤10%	≤10%	≤10%	≤10%	≤10%
Repeatability		.2mm (.008 in.)	.2mm (.008 in.)	.2mm (.008 in.)	.3mm (.012 in.)	.3mm (.012 in.)	.3mm (.012 in.)
Front Cap Material		PBTP	PBTP	PBTP	PBTP	PBTP	PBTP

Fixed Cable

PVC 2m (6ft. 6in.). For 5m (16 ft. 5 in.) cable length, change the last two digits of the part number to 02. For other cable lengths and/or PUR cable, please consult Altech. Non-metallic locknuts for M8 and Brass, Nickel Plated (BN) locknuts for M12 through M30.

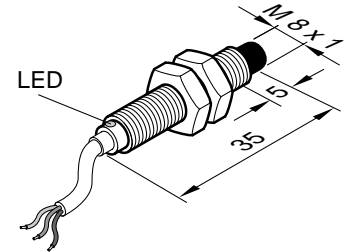
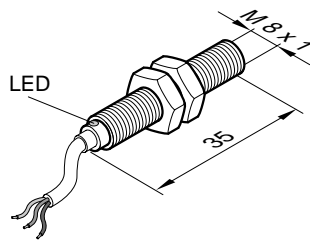

64 Style Connector

3-pin, Pico style, 8mm (.31 in.) supplied with non-metallic locknuts for M8 and Brass, Nickel Plated (BN) locknuts for M12 through M30.

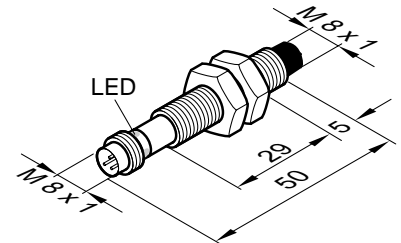
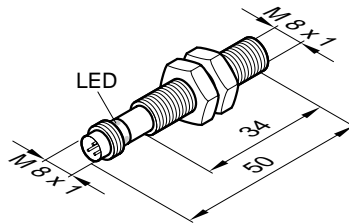

50/65 Style Connector

4-pin, Micro style, 12mm (.47 in.) supplied with Non-Metallic locknuts for M8 and Brass, Nickel Plated (BN) locknuts for M12 through M30.

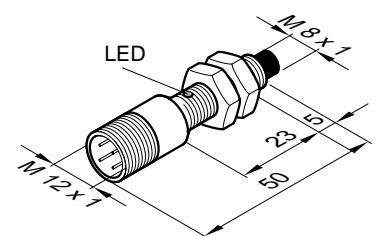
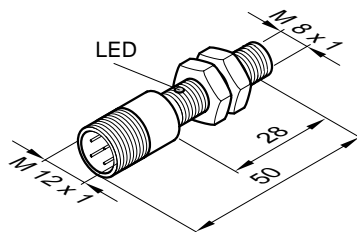

Metric/in. Conversion Table

1.0 mm = .04 in.	29.0 mm = 1.14 in.
5.0 mm = .20 in.	30.0 mm = 1.18 in.
8.0 mm = .31 in.	34.0 mm = 1.33 in.
12.0 mm = .47 in.	35.0 mm = 1.37 in.
23.0 mm = .90 in.	40.0 mm = 1.57 in.
27.0 mm = 1.06 in.	50.0 mm = 1.96 in.
28.0 mm = 1.10 in.	

This table converts millimeters to inches in reference to the illustrations included on these pages

M12 Flush Mount

4mm (.16 in.)

Cable	65
9982-4900	9982-4950
≤10%	≤10%
10V - 30V	10V - 30V
≤12mA	≤12 mA
200 mA	200 mA
≤2.4V	≤2.4V
10 μA	10 μA
1500 Hz	1500 Hz
≤15%	≤15%
≤10%	≤10%
.40mm (.016 in.)	.40mm (.016 in.)
PBTB	PBTB

M18 Flush Mount

8mm (.31 in.)

Cable	65
9984-4900	9984-4950
≤10%	≤10%
10V - 30V	10V - 30V
≤12mA	≤12 mA
200 mA	200 mA
≤2.4V	≤2.4V
10 μA	10 μA
500 Hz	500 Hz
≤15%	≤15%
≤10%	≤10%
.80mm (.03 in.)	.80mm (.03 in.)
PBTB	PBTB

Note: Sensor dimensions in mm.

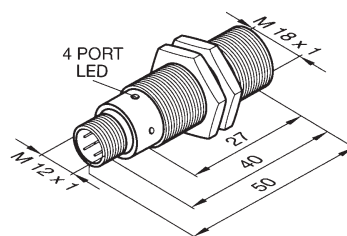
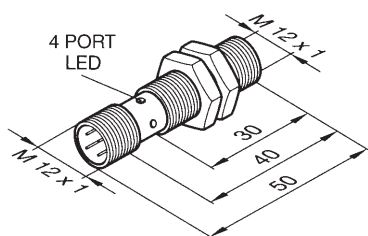
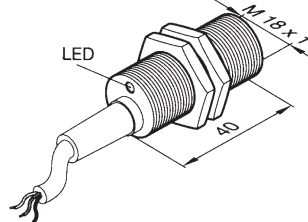
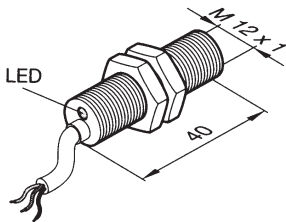

Accessories

2 meter (6 ft. 6 in.) DC Cable Assemblies for Quick Disconnect Sensors

64 Connector	8000-5220	PVC, Straight
64 Connector	8000-5230	PVC, Right Angle, 2LED, PNP
64 Connector	8000-5240	PVC, Right Angle, 2LED, NPN
50/65 Connector	8000-5110	PVC, Straight
50/65 Connector	8000-5120	PVC, Right Angle
50/65 Connector	8000-5150	PVC, Right Angle, 2LED, NPN
50/65 Connector	8000-5160	PVC, Right Angle, 2LED, PNP

Change last digit of connector number to 5 for 5 meter cable

Refer to pages 116-121 for more cable information

Mounting Brackets – see Pages 114-115

Wiring Diagrams

Note: Wire colors are applicable to cable purchased from Altech

PNP

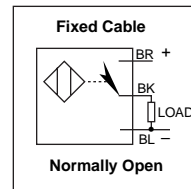

NPN

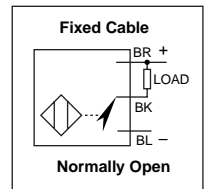

64 Connector

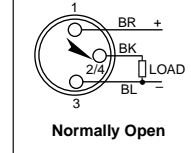

64 Connector

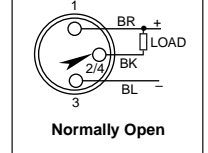

50/65 Connector

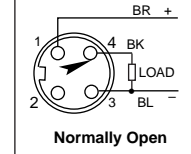

50/65 Connector

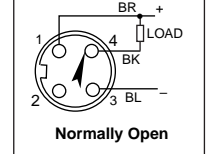





DC - 3 WIRE – EXTENDED SENSING DISTANCE

Brass, Nickel Plated (BN),
Cylindrical, Threaded,
10-30V DC, 200mA
1 LED for Output Energized

- Up to 2 times sensing distance over standard sensors
- Reduces accidental collisions
- Ideal for applications where larger sensing distance is required but mounting space is tight
- Carries CE mark

- IEC (529) IP67 (NEMA 1, 3, 4, 6, 12, 13) Protection
- Short Circuit Protection
- Overload Protection
- Reverse Polarity Protection
- Wire Break Resistance
- Temperature Range: -25 to 70°C (-13 to 158°F)

M30 Flush Mount

Sensing Distance		15mm (.59 in.)	
Cable or Connector Style Cat. No.		Cable	65
PNP	Normally Open 	9966-3900	9966-3965
	Normally Closed 		
NPN	Normally Open 		
	Normally Closed 		
Ripple Voltage		≤10%	≤10%
Voltage Range		10V-30V	10V - 30V
Supply Current		≤12 mA	≤12 mA
Max. Load Current		200 mA	200 mA
Voltage Drop Across Sensor		≤2.4V	≤2.4V
Max. Leakage Current		≤10 µA	≤10 µA
Switching Frequency		200 Hz	200 Hz
Hysteresis		≤15%	≤15%
Temperature Drift		≤10%	≤10%
Repeatability		1.5mm (.06 in.)	1.5mm (.06 in.)
Front Cap Material		PBTP	PBTP

Note: Sensor dimensions in mm.

Fixed Cable

PVC 2m (6ft. 6in.). For 5m (16 ft. 5 in.) cable length, change the last two digits of the part number to 02. For other cable lengths and/or PUR cable, please consult Altech. Supplied with Brass, Nickel Plated (BN) locknuts.

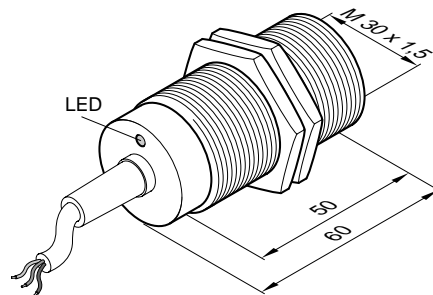

65 Style Connector

4-pin, Micro style, 12mm (.47 in.) supplied with Brass, Nickel Plated (BN) locknuts.

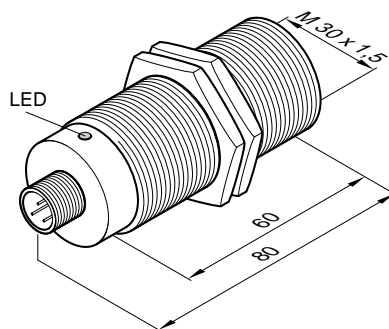

Metric/in. Conversion Table

1.5 mm	=	.06 in.
30.0 mm	=	1.20 in.
50.0 mm	=	1.47 in.
60.0 mm	=	2.36 in.
80.0 mm	=	3.12 in.

This table converts millimeters to inches in reference to the illustrations included on these pages

Accessories

2 meter (6 ft. 6 in.) DC Cable Assemblies for Quick Disconnect Sensors

65 Connector	8000-5110	PVC, Straight
65 Connector	8000-5120	PVC, Right Angle
65 Connector	8000-5150	PVC, Right Angle, 2LED, NPN
65 Connector	8000-5160	PVC, Right Angle, 2LED, PNP

Change last digit of connector number to 5 for 5 meter cable

Refer to pages 116-121 for more cable information

Mounting Brackets – see Pages 114-115

Wiring Diagrams

Note: Wire colors are applicable to cable purchased from Altech

PNP

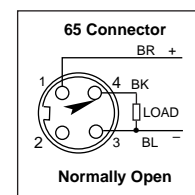
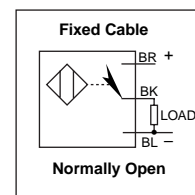



**DC - 3 WIRE
HIGH SPEED
Brass, Nickel Plated (BN),
Cylindrical, Threaded,
10-30V DC, 200mA
1 LED for Output Energized**

- **Switching frequency of 4000 Hz**
- **Standard body length**
- **Carries ζ mark**

- IEC (529) IP67 (NEMA 1, 3, 4, 6, 12, 13) Protection
- Short Circuit Protection
- Overload Protection
- Reverse Polarity Protection
- Wire Break Resistance
- Temperature Range: -25 to 70°C (-13 to 158°F)

M12 Flush Mount

Sensing Distance		2mm (.08 in.)	
Cable or Connector Style	Cat.No.	Cable	65
PNP	Normally Open 	9962-2300	9962-2365
			
			
Ripple Voltage		≤10%	≤10%
Voltage Range		10V-30V	10V - 30V
Supply Current		≤10 mA	≤10 mA
Max. Load Current		200 mA	200 mA
Voltage Drop Across Sensor		≤2.4V	≤2.4V
Max. Leakage Current		≤10 μA	≤10 μA
Switching Frequency		4000 Hz to DIN 500 10	4000 Hz to DIN 500 10
Hysteresis		≤15%	≤15%
Temperature Drift		≤10%	≤10%
Repeatability		.20mm (.008 in.)	.20mm (.008 in.)
Front Cap Material		PBTP	PBTP

Metric/in. Conversion Table

1.0 mm	=	.04 in.
12 mm	=	.47 in.
40.0 mm	=	1.57 in.
45.0 mm	=	1.77 in.
50.0 mm	=	1.96 in.
65.0 mm	=	2.55 in.

This table converts millimeters to inches in reference to the illustrations included on these pages

Accessories

2 meter (6 ft. 6 in.) DC Cable Assemblies for Quick Disconnect Sensors

65 Connector	8000-5110	PVC, Straight
65 Connector	8000-5120	PVC, Right Angle
65 Connector	8000-5150	PVC, Right Angle, 2LED, NPN
65 Connector	8000-5160	PVC, Right Angle, 2LED, PNP

Change last digit of connector number to 5 for 5 meter cable

Refer to pages 116-121 for more cable information

Mounting Brackets – see Pages 114-115

Note: Sensor dimensions in mm.

Fixed Cable

PVC 2m (6ft. 6in.). For 5m (16 ft. 5 in.) cable length, change the last two digits of the part number to 02. For other cable lengths and/or PUR cable, please consult Altech. Supplied with Brass, Nickel Plated (BN) locknuts.

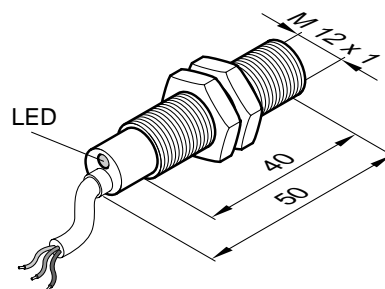

65 Style Connector

4-pin, Micro style, 12mm (.47 in.) supplied with Brass, Nickel Plated (BN) locknuts.

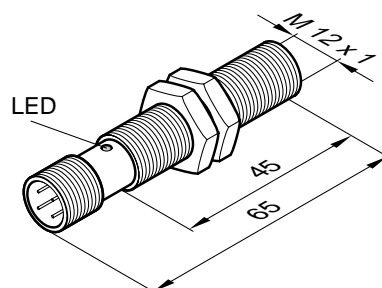

Wiring Diagrams

Note: Wire colors are applicable to cable purchased from Altech



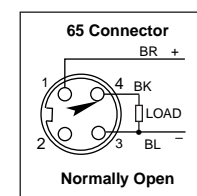
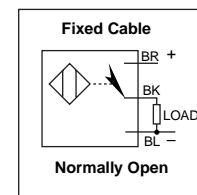

PNP



DC - 3 WIRE – PLASTIC & METAL HOUSING – Brass, Nickel Plated (BN), and Plastic (TROGAMID T) Cylindrical, Threaded, 10-30V DC, 400mA 1 LED for Output Energized

- **Metal and plastic housings**
- **Higher output currents, 400mA**
- **Long body length**
- **Carries (€ mark)**

- IEC(529) IP67 (NEMA 1, 3, 4, 6, 12, 13) Protection
- Short Circuit Protection
- Overload Protection
- Reverse Polarity Protection
- Wire Break Resistance
- Temperature Range: -25 to 70°C (-13 to 158°F)

	M12 Flush Mount		M12 Non-Flush Mount		M18 Flush Mount		
Sensing Distance	2mm (.08 in.)		4mm (.16 in.)		5mm (.20 in.)		
Cable or Connector Cat. No.	Cable		Cable		Cable		
PNP	Normally Open 	9962-3100	9962-1400	9962-3300	9962-1600	9964-3100	9964-1500
	Normally Closed 						
NPN	Normally Open 	9962-3200	9962-1500	9962-3400	9962-1700	9964-3200	9964-1600
	Normally Closed 						
Ripple Voltage	≥10%	≥10%	≥10%	≥10%	≥10%	≥10%	
Voltage Range	10-30V	10-30V	10-30V	10-30V	10-30V	10-30V	
Supply Current	≥10 mA	≥10 mA	≥10 mA	≥10 mA	≥10 mA	≥10 mA	
Max. Load Current	400 mA	400 mA	400 mA	400 mA	400 mA	400 mA	
Voltage Drop Across Sensor	≥2.4V	≥2.4V	≥2.4V	≥2.4V	≥2.4V	≥2.4V	
Max. Leakage Current	≥10 µA	≥10 µA	≥10 µA	≥10 µA	≥10 µA	≥10 µA	
Switching Frequency	2000Hz	2000Hz	1000Hz	1000Hz	1000Hz	1000Hz	
Hysteresis	≥15%	≥15%	≥15%	≥15%	≥15%	≥15%	
Temperature Drift	≥10%	≥10%	≥10%	≥10%	≥10%	≥10%	
Repeatability	.20mm (.008 in.)	.20mm (.008 in.)	.40mm (.016 in.)	.40mm (.016 in.)	.5mm (.02 in.)	.5mm (.02 in.)	
Front Cap Material	PBTB	PBTB	PBTB	PBTB	PBTB	PBTB	
Housing Material	Trogamid T	Nickel Plated Brass	Trogamid T	Nickel Plated Brass	Trogamid T	Nickel Plated Brass	

Fixed Cable

PVC 2m (6ft. 6in.). For 5m (16 ft. 5 in.) cable length, change the last two digits of the part number to 02. For other cable lengths and/or PUR cable, please consult Altech. Supplied with non-metallic locknuts for Trogamid T housings, and Brass, Nickel Plated (BN) locknuts for Nickel Plated Brass housings.

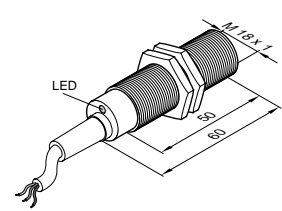
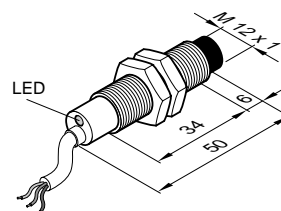
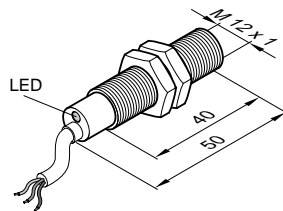

Metric/in. Conversion Table

1 mm = .04 in.	34.0 mm = 1.31 in.
1.5 mm = .06 in.	38.0 mm = 1.50 in.
6.0 mm = .23 in.	40.0 mm = 1.57 in.
8.0 mm = .31 in.	42.0 mm = 1.65 in.
12.0 mm = .47 in.	50.0 mm = 1.97 in.
18.0 mm = .70 in.	60.0 mm = 2.36 in.
30.0 mm = 1.20 in.	

This table converts millimeters to inches in reference to the illustrations included on these pages

Accessories

Mounting Brackets – see Pages 114-115

M18 Non-Flush Mount 8mm (.31 in.)		M30 Flush Mount 10mm (.39 in.)		M30 Non-Flush Mount 15mm (.59 in.)	
Cable		Cable		Cable	
9964-3300	9964-1700	9966-3100	9966-1100	9966-3300	9966-1300
9964-3400	9964-1800	9966-3200	9966-1200	9966-3400	9966-1400
≥10%	≥10%	≥10%	≥10%	≥10%	≥10%
10-30V	10-30V	10-30V	10-30V	10-30V	10-30V
≥10 mA	≥10 mA	≥10 mA	≥10 mA	≥10 mA	≥10 mA
400 mA	400 mA	400 mA	400 mA	400 mA	400 mA
≥2.4V	≥2.4V	≥2.4V	≥2.4V	≥2.4V	≥2.4V
≥10mA	≥10mA	≥10mA	≥10mA	≥10mA	≥10mA
500Hz	500Hz	500Hz	500Hz	300Hz	300Hz
≥15%	≥15%	≥15%	≥15%	≥15%	≥15%
≥10%	≥10%	≥10%	≥10%	≥10%	≥10%
.8mm (.03 in.)	.8mm (.03 in.)	1.0mm (.04 in)	1.0mm (.04 in)	1.5mm (.06 in)	1.5mm (.06 in)
PBTB	PBTB	PBTB	PBTB	PBTB	PBTB
Trogamid T	Nickel Plated Brass	Trogamid T	Nickel Plated Brass	Trogamid T	Nickel Plated Brass

Note: Sensor dimensions in mm.

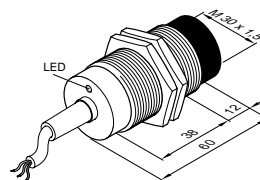
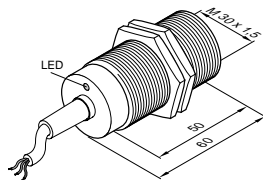
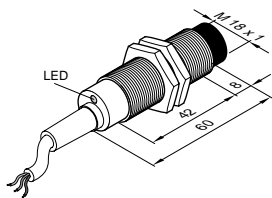

Wiring Diagrams

Note: Wire colors are applicable to cable purchased from Altech

PNP

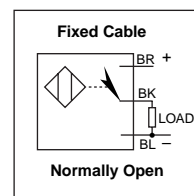



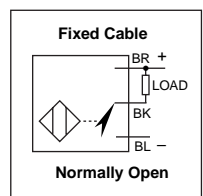

NPN



**DC - 3 WIRE
MINI METAL HOUSING
Cylindrical, 10-30V DC, 200mA
LED for Output Energized**

- 4mm, 5mm, and 6.5mm diameter
- Economically Priced
- Non-connector models feature polyurethane (PUR) cables
- Carries CE mark

- IEC(529) IP67 (NEMA 1, 3, 4, 6, 12, 13) Protection
- Short Circuit Protection
- Overload Protection
- Reverse Polarity Protection
- Wire Break Resistance
- Temperature Range: -25 to 70°C (-13 to 158°F)

Sensing Distance	Ø 4 Flush Mount		M5 Flush Mount	
	0.8mm (0.03 in.)		0.8mm (0.03 in.)	
Cable or Connector Style Cat. No.	Cable	64	Cable	64
PNP Normally Open 	9980-1010	9980-1064	9980-2010	9980-2064
	Normally Closed 			
NPN Normally Open 	9980-1110	9980-1164	9980-2110	9980-2164
	Normally Closed 			
Ripple Voltage	≤10%	≤10%	≤10%	≤10%
Voltage Range	10V-30V	10V - 30V	10V - 30V	10V - 30V
Supply Current	≤10 mA	≤10 mA	≤10 mA	≤10 mA
Max. Load Current	200 mA	200 mA	200 mA	200 mA
Voltage Drop Across Sensor	≤2V	≤2V	≤2V	≤2V
Max. Leakage Current	≤100 µA	≤100 µA	≤100 µA	≤100 µA
Switching Frequency	5000 Hz	5000 Hz	5000 Hz	5000 Hz
Hysteresis	Typ. 5%	Typ. 5%	Typ. 5%	Typ. 5%
Temperature Drift	≤10%	≤10%	≤10%	≤10%
Repeatability	.04mm (.003 in.)	.04mm (.003 in.)	.04mm (.003 in.)	.04mm (.003 in.)
Front Cap Material	PBTP	PBTP	PBTP	PBTP
Housing Material	Nickel Plated Brass	Nickel Plated Brass	Nickel Plated Brass	Nickel Plated Brass

Fixed Cable

PUR 2m (6 ft. 6 in.). Supplied with Brass, Nickel Plated (BN) locknuts for M5 model.

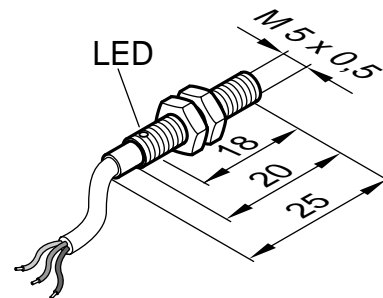
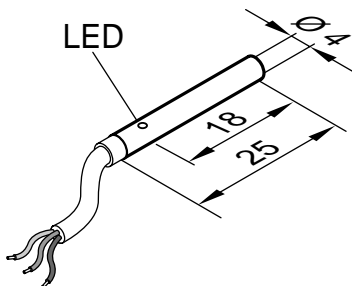

64 Style Connector

4-pin, Micro style, 12mm (.47 in.) supplied with Brass, Nickel Plated (BN) locknuts for M5 model.

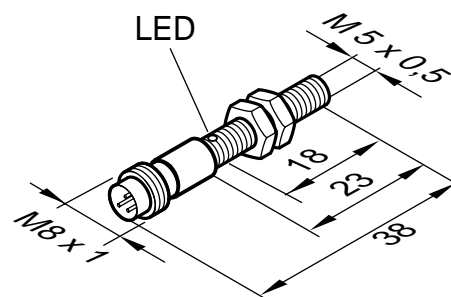
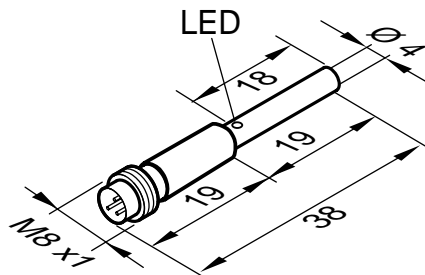

Metric/In. Conversion Table

.5 mm = .019 in.	19.0 mm = .74 in.
1.0 mm = .04 in.	20.0 mm = .78 in.
3.5 mm = .13 in.	23.0 mm = .90 in.
4.0 mm = .15 in.	25.0 mm = .94 in.
5.0 mm = .19 in.	35.0 mm = 1.37 in.
6.5 mm = .25 in.	40.0 mm = 1.57 in.
8.0 mm = .31 in.	43.0 mm = 1.69 in.

This table converts millimeters to inches in reference to the illustrations included in this catalog

Accessories

2 meter (6 ft. 6 in.) DC Cable Assemblies for Quick Disconnect Sensors

64 Connector	8000-5220	PVC, Straight
64 Connector	8000-5230	PVC, Right Angle, 2LED, PNP
64 Connector	8000-5240	PVC, Right Angle, 2LED, NPN

Change last digit of connector number to 5 for 5 meter cable

Refer to pages 116-121 for more cable information

Mounting Brackets – see Pages 114-115

Ø 6.5 Flush Mount 1.5mm (0.06 in.)

Cable	65
9961-1200	9961-1264
≤10%	≤10%
10V - 30V	10V - 30V
≤8 mA	≤8 mA
200 mA	200 mA
≤2.4V	≤2.4V
≤10 µA	≤10 µA
2000 Hz	2000 Hz
≤15%	≤15%
≤10%	≤10%
.15mm (.006in.)	.15mm (.006in.)
PBTB	PBTB
Stainless Steel	Stainless Steel

Ø 6.5 Non-Flush Mount 3.0mm (0.11 in.)

Cable	65
9961-1300	9961-1364
≤10%	≤10%
10V - 30V	10V - 30V
≤8 mA	≤8 mA
200 mA	200 mA
≤2.4V	≤2.4V
≤10 µA	≤10 µA
2000 Hz	2000 Hz
≤15%	≤15%
≤10%	≤10%
.15mm (.006in.)	.15mm (.006in.)
PBTB	PBTB
Stainless Steel	Stainless Steel

Note: Sensor dimensions in mm.

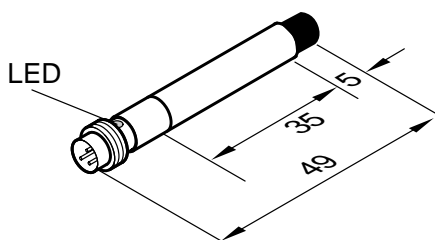
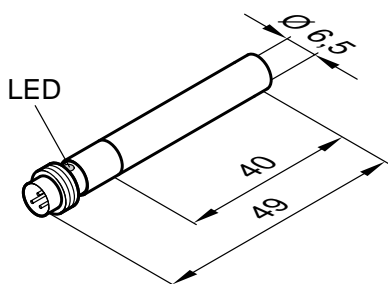
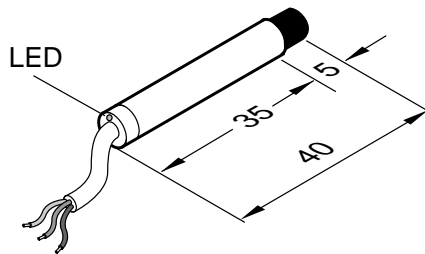
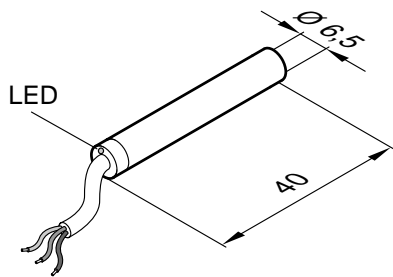

Wiring Diagrams

Note: Wire colors are applicable to cable purchased from Altech

PNP

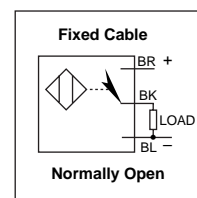

NPN

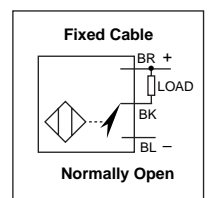

64 Connector

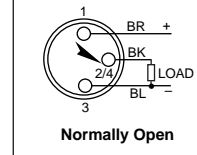

64 Connector

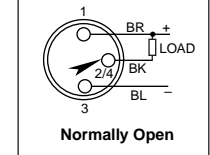

**DC - 4 WIRE – COMPLEMENTARY
OUTPUTS (N.O. & N.C.)
Brass, Nickel Plated (BN),
Cylindrical, Threaded,
10-30V DC, 200mA
1 LED for Output Energized**

• Carries ϵ mark

- IEC(529) IP67 (NEMA 1, 3, 4, 6, 12, 13) Protection
- Short Circuit Protection
- Overload Protection
- Reverse Polarity Protection
- Wire Break Resistance
- Temperature Range: -25 to 70°C (-13 to 158°F)

	M12 Flush Mount		M12 Non-Flush Mount	
Sensing Distance	2mm (.08 in.)		4mm (.16 in.)	
Cable or Connector Style Cat. No.	Cable	65	Cable	65
PNP (Complementary NO/NC)	9962-6200	9962-6265	9962-6300	9962-6365
NPN (Complementary NO/NC)				
Ripple Voltage	≤10%	≤10%	≤10%	≤10%
Voltage Range	10V-30V	10V - 30V	10V - 30V	10V - 30V
Supply Current	≤15 mA	≤15 mA	≤15 mA	≤15 mA
Max. Load Current	200 mA	200 mA	200 mA	200 mA
Voltage Drop Across Sensor	≤2.4V	≤2.4V	≤2.4V	≤2.4V
Max. Leakage Current	≤10 μA	≤10 μA	≤10 μA	≤10 μA
Switching Frequency	2000 Hz	2000 Hz	1000 Hz	1000 Hz
Hysteresis	≤15%	≤15%	≤15%	≤15%
Temperature Drift	≤10%	≤10%	≤10%	≤10%
Repeatability	.20mm (.008 in.)	.20mm (.008 in.)	.40mm (.016 in.)	.40mm (.016 in.)
Front Cap Material	PBTP	PBTP	PBTB	PBTB

Fixed Cable

PVC 2m (6ft. 6in.). For 5m (16 ft. 5 in.) cable length, change the last two digits of the part number to 02. For other cable lengths and/or PUR cable, please consult Altech. Supplied with Brass, Nickel Plated (BN) locknuts.

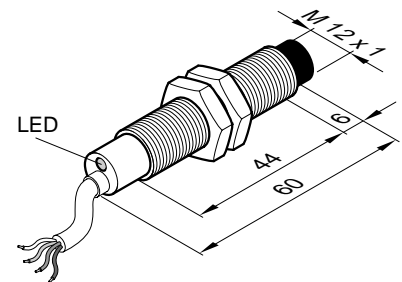
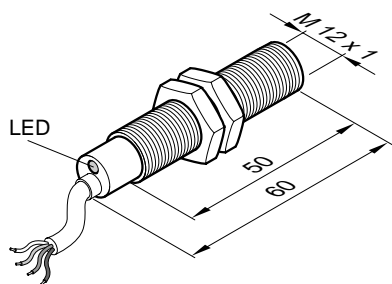

65 Style Connector

4-pin, Micro style, 12mm (.47 in.) supplied with Brass, Nickel Plated (BN) locknuts.

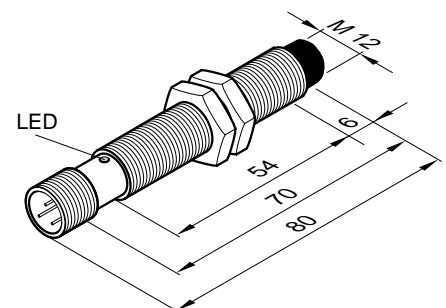
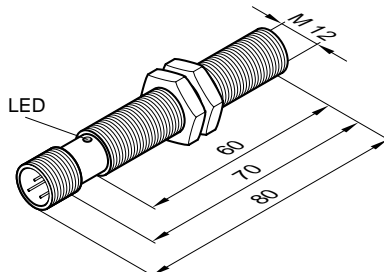

Metric/in. Conversion Table

1.0 mm = .04 in.	44.0 mm = 1.73 in.
6.0 mm = .23 in.	50.0 mm = 1.96 in.
8.0 mm = .31 in.	51.0 mm = 2.0 in.
10.0 mm = .39 in.	54.0 mm = 2.12 in.
12.0 mm = .47 in.	60.0 mm = 2.36 in.
18.0 mm = .70 in.	70.0 mm = 2.75 in.
32.0 mm = 1.26 in.	80.0 mm = 3.12 in.
42.0 mm = 1.65 in.	

This table converts millimeters to inches in reference to the illustrations included on these pages

Accessories

2 meter (6 ft. 6 in.) DC Cable Assemblies for Quick Disconnect Sensors

65 Connectors, 4PIN – 4 Wire cable (PIN 1, 2, 3, 4) :
65 Connectors 8000-5280 PVC, Right Angle

Change last digit of connector number for 5 meter cable

Refer to pages 116-121 for more cable information

Mounting Brackets – see Pages 114-115

M18 Flush Mount

5mm (.2 in.)

Cable	65
9964-6200	9964-6265
≤10%	≤10%
10V - 30V	10V - 30V
≤15 mA	≤15 mA
200 mA	200 mA
≤2.4V	≤2.4V
10 μA	10 μA
1000 Hz	1000 Hz
≤15%	≤15%
≤10%	≤10%
.5mm (.02 in.)	.5mm (.02 in.)
PBTB	PBTB

M18 Non-Flush Mount

8mm (.31 in.)

Cable	65
9964-6300	9964-6365
≤10%	≤10%
10V - 30V	10V - 30V
≤15 mA	≤15 mA
200 mA	200 mA
≤2.4V	≤2.4 V
10μA	10μA
500 Hz	500 Hz
≤15%	≤15%
≤10%	≤10%
.8mm (.031 in.)	.8mm (.031 in.)
PBTB	PBTB

Note: Sensor dimensions in mm.

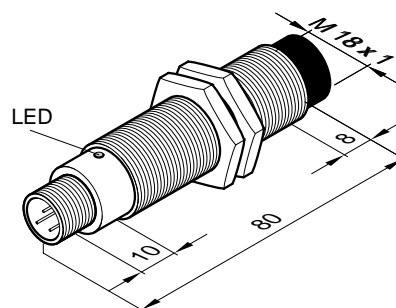
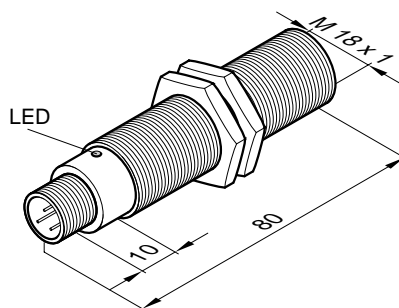
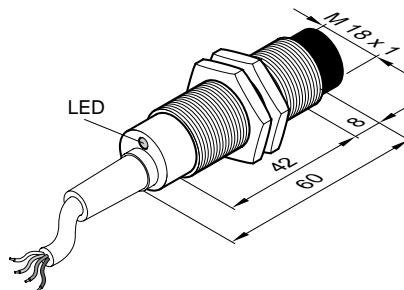
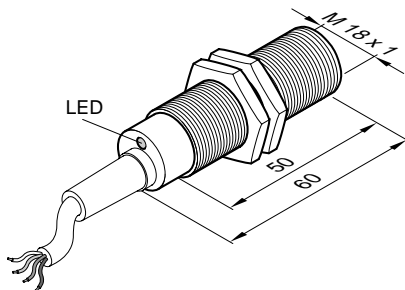

Wiring Diagrams

Note: Wire colors are applicable to cable purchased from Altech

PNP

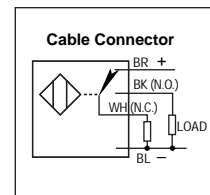



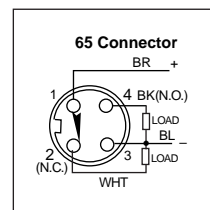

PNP



DC - 3 WIRE – EXTENDED TEMPERATURE RANGE
Brass, Nickel Plated (BN), Cylindrical, Threaded,
10-30V DC, 200mA
1 LED for Output Energized

- **Temperature Range:**
-40 to 100°C
(104 to 212°F)
- **Carries (€ mark)**

- IEC(529) IP67 (NEMA 1, 3, 4, 6, 12, 13) Protection
- Short Circuit Protection
- Overload Protection
- Reverse Polarity Protection
- Wire Break Resistance

			M12 Flush Mount		M12 Non-Flush Mount	
Sensing Distance			2mm (.08 in.)		4mm (.16 in.)	
Cable or Connector Style	Cat. No.		Cable	65	Cable	65
PNP	Normally Open		9962-6010	9962-6065	9962-6110	9962-6165
	Normally Closed					
NPN	Normally Open					
	Normally Closed					
Ripple Voltage			≤10%	≤10%	≤10%	≤10%
Voltage Range			10V-30V	10V - 30V	10V - 30V	10V - 30V
Supply Current			≤10 mA	≤10 mA	≤10 mA	≤10 mA
Max. Load Current			200 mA	200 mA	200 mA	200 mA
Voltage Drop Across Sensor			≤2.4V	≤2.4V	≤2.4V	≤2.4V
Max. Leakage Current			≤10 µA	≤10 µA	≤10 µA	≤10 µA
Switching Frequency			2000 Hz	2000 Hz	1000 Hz	1000 Hz
Hysteresis			≤15%	≤15%	≤15%	≤15%
Temperature Drift			≤10%	≤10%	≤10%	≤10%
Repeatability			.20mm (.008 in.)	.20mm (.008 in.)	.40mm (.016 in.)	.40mm (.016 in.)
Front Cap Material			PBTP	PBTP	PBTB	PBTB

Fixed Cable

PVC 2m (6ft. 6in.). For 5m (16 ft. 5 in.) cable length, change the last two digits of the part number to 02. For other cable lengths and/or PUR cable, please consult Altech. Supplied with Brass, Nickel Plated (BN) locknuts.

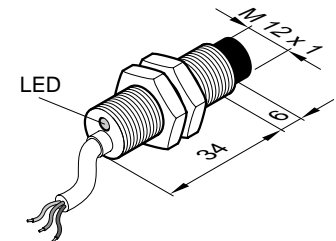
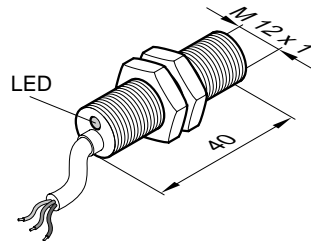

65 Style Connector

4-pin, Micro style, 12mm (.47 in.) supplied with Brass, Nickel Plated (BN) locknuts.

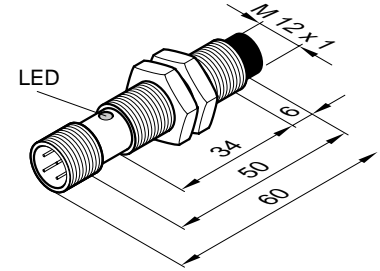
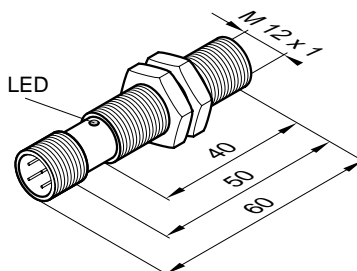

Metric/in. Conversion Table

1.0 mm = .04 in.	32.0 mm = 1.23 in.
6.0 mm = .23 in.	34.0 mm = 1.31 in.
8.0 mm = .31 in.	40.0 mm = 1.39 in.
12.0 mm = .47 in.	50.0 mm = 1.47 in.
18.0 mm = .70 in.	51.0 mm = 1.59 in.
	60.0 mm = 2.36 in.

This table converts millimeters to inches in reference to the illustrations included on these pages

Accessories

2 meter (6 ft. 6 in.) DC Cable Assemblies for Quick Disconnect Sensors

65 Connector	8000-5110	PVC, Straight
65 Connector	8000-5120	PVC, Right Angle
65 Connector	8000-5150	PVC, Right Angle, 2LED, NPN
65 Connector	8000-5160	PVC, Right Angle, 2LED, PNP

Change last digit of connector number to 5 for 5 meter cable

Refer to pages 116-121 for more cable information

M18 Flush Mount

5mm (.20 in.)

Cable	65
9964-6010	9964-6065
≤10%	≤10%
10V - 30V	10V - 30V
≤10 mA	≤10 mA
200 mA	200 mA
≤2.4V	≤2.4V
10 μA	10 μA
1000 Hz	1000 Hz
≤15%	≤15%
≤10%	≤10%
.50mm (.02 in.)	.50mm (.02 in.)
PBTB	PBTB

M18 Non-Flush Mount

8mm (.31 in.)

Cable	65
9964-6110	9964-6165
≤10%	≤10%
10V - 30V	10V - 30V
≤25 mA	≤25 mA
200 mA	200 mA
≤2.4V	≤2.4V
10 μA	10 μA
500 Hz	500 Hz
≤15%	≤15%
≤10%	≤10%
.80mm (.03 in.)	.80mm (.03 in.)
PBTB	PBTB

Note: Sensor dimensions in mm.

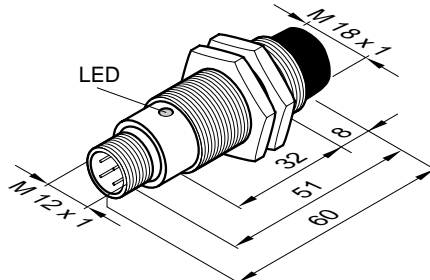
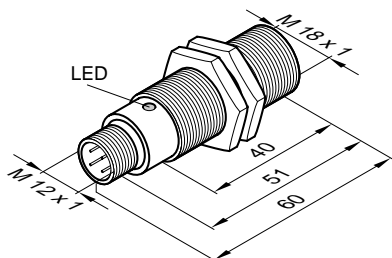
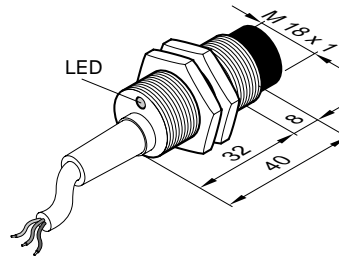
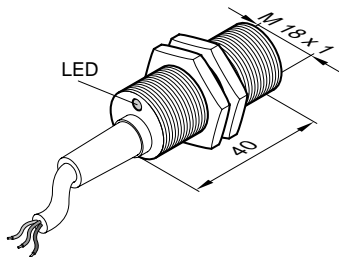

Mounting Brackets – see Pages 114-115

Wiring Diagrams

Note: Wire colors are applicable to cable purchased from Altech



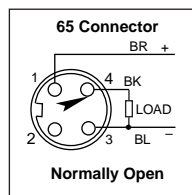
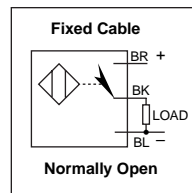

PNP



DC - 3 WIRE – WELD IMMUNE
Brass, Nickel Plated (BN),
Cylindrical, Threaded,
10-30V DC, 200mA
1 LED for Output Energized

- *Circuitry that protects for electro-magnetic interference*
- *Flush models have teflon ceramic coatings to protect for weld slag*
- *Carries C ϵ mark*

- IEC(529) IP67 (NEMA 1, 3, 4, 6, 12, 13) Protection
- Short Circuit Protection
- Overload Protection
- Reverse Polarity Protection
- Wire Break Resistance
- Temperature Range: -25 to 70°C (-13 to 158°F)

			M12 Flush Mount		M12 Non-Flush Mount	
Sensing Distance			2mm (.08 in.)		4mm (.16 in.)	
Cable or Connector Style Cat. No.			Cable	45	Cable	65
PNP	Normally Open		9962-5840	9962-5845	9962-5900	9962-5965
	Normally Closed					
NPN	Normally Open					
	Normally Closed					
Ripple Voltage			≤10%	≤10%	≤10%	≤10%
Voltage Range			10V-30V	10V - 30V	10V - 30V	10V - 30V
Supply Current			≤10 mA	≤10 mA	≤10 mA	≤10 mA
Max. Load Current			200 mA	200 mA	200 mA	200 mA
Voltage Drop Across Sensor			≤2.4V	≤2.4V	≤2.4V	≤2.4V
Max. Leakage Current			≤10 μA	≤10 μA	≤10 μA	≤10 μA
Switching Frequency			15 Hz	15 Hz	15Hz	15 Hz
Hysteresis			≤15%	≤15%	≤15%	≤15%
Temperature Drift			≤10%	≤10%	≤10%	≤10%
Repeatability			.20mm (.008 in.)	.20mm (.008 in.)	.40mm (.016 in.)	.40mm (.016 in.)
Front Cap Material			Teflon	Teflon	PBTB	PBTB
Housing Material			Teflon Plated Brass	Teflon Plated Brass	Nickel Plated Brass	Nickel Plated Brass

Fixed Cable

PVC 2m (6ft. 6in.). For 5m (16 ft. 5 in.) cable length, change the last two digits of the part number to 02. For other cable lengths and/or PUR cable, please consult Altech. Supplied with Brass, Nickel Plated (BN) locknuts.

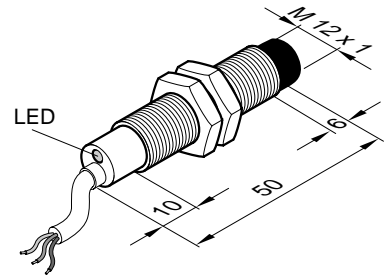
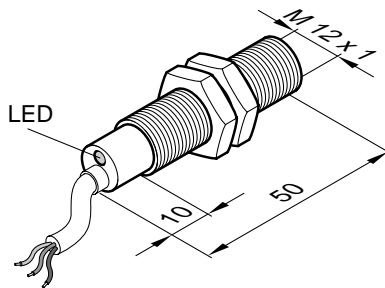

45/65 Style Connector

4-pin, Micro style, 12mm (.47 in.) supplied with Brass, Nickel Plated (BN) locknuts.

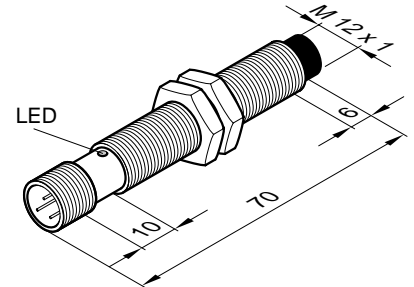
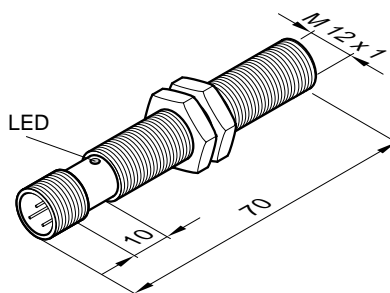

Metric/in. Conversion Table

1.0 mm = .04 in.	50.0 mm = 1.47 in.
6.0 mm = .23 in.	52.0 mm = 2.04 in.
8.0 mm = .31 in.	60.0 mm = 2.36 in.
10.0 mm = .39 in.	70.0 mm = 2.75 in.
12.0 mm = .47 in.	80.0 mm = 3.12 in.

This table converts millimeters to inches in reference to the illustrations included on these pages

Accessories

2 meter (6 ft. 6 in.) DC Cable Assemblies for Quick Disconnect Sensors

- 45/65 Connector 8000-5110 PVC, Straight
- 45/65 Connector 8000-5120 PVC, Right Angle
- 45/65 Connector 8000-5150 PVC, Right Angle, 2LED, NPN
- 45/65 Connector 8000-5160 PVC, Right Angle, 2LED, PNP

Change last digit of connector number to 5 for 5 meter cable

Refer to pages 116-121 for more cable information

Mounting Brackets – see Pages 114-115

M18 Flush Mount 5mm (.20 in.)

Cable	45
9964-5840	9964-5845
≤10%	≤10%
10V - 30V	10V - 30V
≤10 mA	≤10 mA
200 mA	200 mA
≤2.4V	≤2.4V
10 μA	10 μA
15 Hz	15 Hz
≤15%	≤15%
≤10%	≤10%
.50mm (.02 in.)	.50mm (.02 in.)
Teflon	Teflon
Teflon Plated Brass	Teflon Plated Brass

M18 Non-Flush Mount 8mm (.31 in.)

Cable	65
9964-5900	9964-5965
≤10%	≤10%
10V - 30V	10V - 30V
≤10 mA	≤10 mA
200 mA	200 mA
≤2.4V	≤2.4V
10 μA	10 μA
15 Hz	15 Hz
≤15%	≤15%
≤10%	≤10%
.80mm (.03 in.)	.80mm (.03 in.)
PBTB	PBTB
Nickel Plated Brass	Nickel Plated Brass

Note: Sensor dimensions in mm.

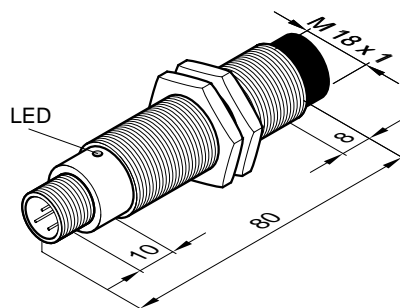
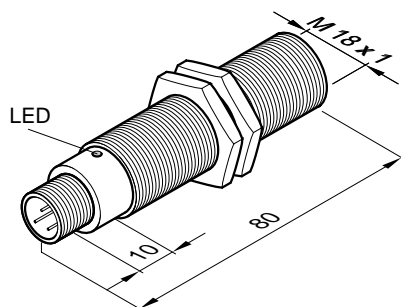
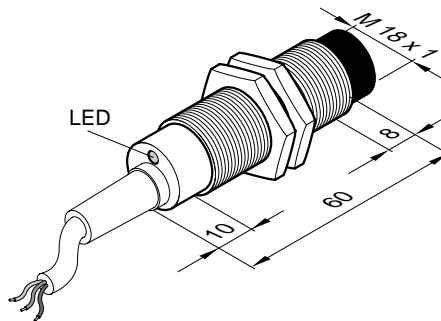
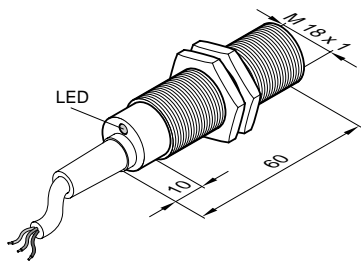

Wiring Diagrams

Note: Wire colors are applicable to cable purchased from Altech



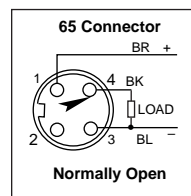
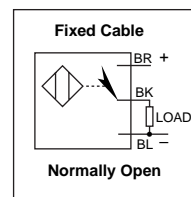

PNP



DC - 3 WIRE – WELD IMMUNE
Brass, Nickel Plated (BN),
Cylindrical, Threaded,
10-30V DC, 200mA
1 LED for Output Energized

- **Circuitry that protects for electro-magnetic interference**
- **Flush models have teflon ceramic coatings to protect for weld slag**
- **Carries CE mark**

- IEC(529) IP67 (NEMA 1, 3, 4, 6, 12, 13) Protection
- Short Circuit Protection
- Overload Protection
- Reverse Polarity Protection
- Wire Break Resistance
- Temperature Range: -25 to 70°C (-13 to 158°F)

M30 Flush Mount			M30 Non-Flush Mount	
10mm (.39 in.)			15mm (.59 in.)	
Sensing Distance	Cable or Connector Style Cat. No.		Cable	65
PNP	Normally Open		9966-5840	9966-5845
	Normally Closed			
NPN	Normally Open			
	Normally Closed			
Ripple Voltage	≤10%	≤10%	≤10%	≤10%
Voltage Range	10V-30V	10V - 30V	10V - 30V	10V - 30V
Supply Current	≤10 mA	≤10 mA	≤10 mA	≤10 mA
Max. Load Current	200 mA	200 mA	200 mA	200 mA
Voltage Drop Across Sensor	≤2.4V	≤2.4V	≤2.4V	≤2.4V
Max. Leakage Current	≤10 μA	≤10 μA	≤10 μA	≤10 μA
Switching Frequency	15 Hz	15 Hz	15 Hz	15Hz
Hysteresis	≤15%	≤15%	≤15%	≤15%
Temperature Drift	≤10%	≤10%	≤10%	≤10%
Repeatability	1.0mm (.039 in.)	1.0mm (.039 in.)	1.5mm (.059 in.)	1.5mm (.059 in.)
Front Cap Material	Teflon	Teflon	PBTB	PBTB
Housing Material	Teflon Plated Brass	Teflon Plated Brass	Nickel Plated Brass	Nickel Plated Brass

Note: Sensor dimensions in mm.

Fixed Cable

PVC 2m (6ft. 6in.). For 5m (16 ft. 5 in.) cable length, change the last two digits of the part number to 02. For other cable lengths and/or PUR cable, please consult Altech. Supplied with Brass, Nickel Plated (BN) locknuts.

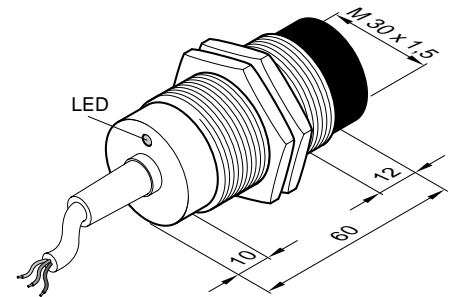
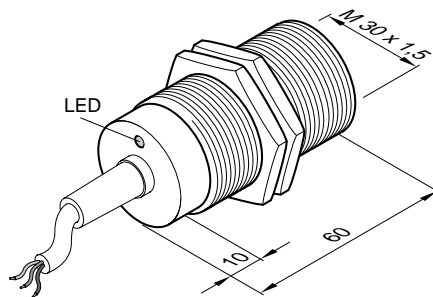

45/65 Style Connector

4-pin, Micro style, 12mm (.47 in.) supplied with Brass, Nickel Plated (BN) locknuts.

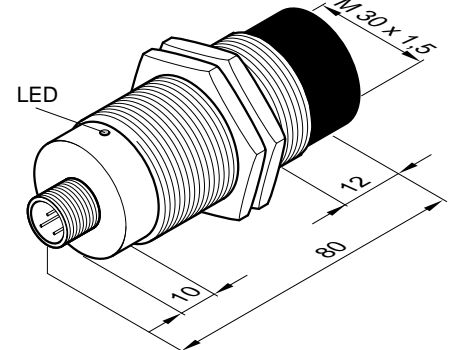
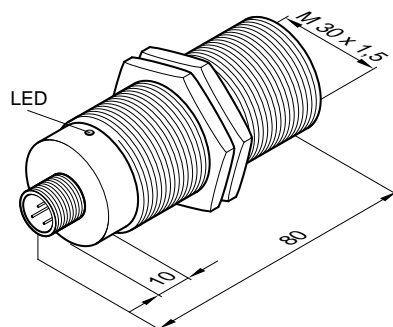

Metric/in. Conversion Table

1.5 mm = .06 in.
10.0 mm = .39 in.
12.0 mm = .47 in.
30.0 mm = 1.20 in.
60.0 mm = 2.36 in.
80.0 mm = 3.15 in.

This table converts millimeters to inches in reference to the illustrations included on these pages

Accessories

2 meter (6 ft. 6 in.) DC Cable Assemblies for Quick Disconnect Sensors

- 45/65 Connector 8000-5110 PVC, Straight
- 45/65 Connector 8000-5120 PVC, Right Angle
- 45/65 Connector 8000-5150 PVC, Right Angle, 2LED, NPN
- 45/65 Connector 8000-5160 PVC, Right Angle, 2LED, PNP

Change last digit of connector number to 5 for 5 meter cable

Refer to pages 116-121 for more cable information

Mounting Brackets – see Pages 114-115

Wiring Diagrams

Note: Wire colors are applicable to cable purchased from Altech

PNP

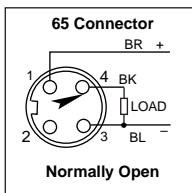
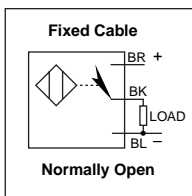

DC ANALOG SENSORS

Cylindrical, Threaded

Brass, Nickel Plated (BN),

18-30V DC

Analog Output 1V - 9V M12, M18, M30

M30 4 Bit Digital & Analog Output

- Output voltage proportional to target distance
- Ideal for determining position information
- Excellent linearity $\pm 3\%$
- Shielded cable outputs on cable models
- Carries $\text{C}\epsilon$ mark

- IEC(529) IP67 (NEMA 1, 3, 4, 6, 12, 13) Protection
- Short Circuit Protection
- Overload Protection
- Temperature Range: -25 to 70°C (-13 to 158°F)

	M12 Flush Mount		M18 Flush Mount	
Sensing Distance	0.5mm (.02 in.) to 2.5mm (0.1 in.)		1mm (.04 in.) to 4mm (.16 in.)	
Cable or Connector Style Cat. No.	Cable	65	Cable	65
	9914-0800	9914-0865	9914-0900	9914-0965
Voltage Range	18V-30V	18V - 30V	18V - 30V	18V - 30V
Supply Current	≤ 10 mA	≤ 10 mA	≤ 10 mA	≤ 10 mA
Max. Load Current	5 mA	5 mA	5 mA	5 mA
Max. Switching Frequency	100 Hz	100 Hz	100 Hz	100 Hz
Temperature Drift	± 0.3 V	± 0.3 V	± 0.3 V	± 0.3 V
Repeatability	1%	1%	1%	1%
Front Cap Material	PBTP	PBTP	PBTP	PBTP
Output Voltage Range	1-9V DC	1-9V DC	1-9V DC	1-9V DC

Fixed Cable

PVC 2m (6ft. 6in.). For 5m (16 ft. 5 in.) cable length, change the last two digits of the part number to 02. For other cable lengths and/or PUR cable, please consult Altech. Supplied with Brass, Nickel Plated (BN) locknuts.

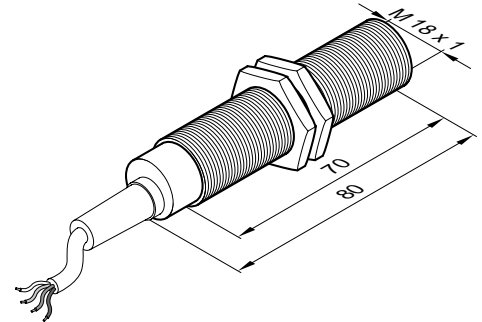
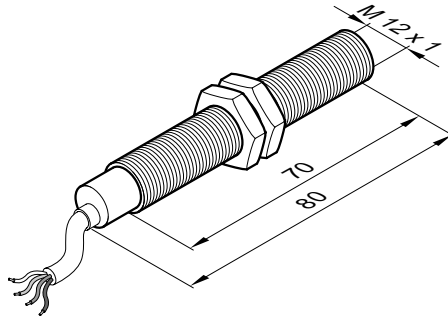

65 Style Connector

4-pin, Micro style, 12mm (.47 in.) supplied with Brass, Nickel Plated (BN) locknuts.

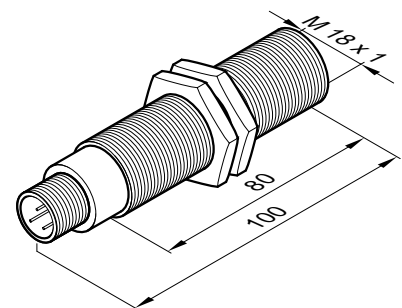
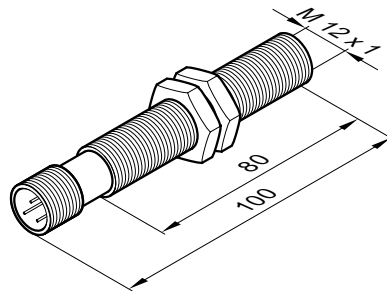

Metric/in. Conversion Table

1.0 mm = .04 in.	58.0 mm = 2.28 in.
1.5 mm = .06 in.	70.0 mm = 2.75 in.
10.0 mm = .40 in.	80.0 mm = 3.12 in.
12.0 mm = .47 in.	100.0mm = 3.94 in.
18.0 mm = .70 in.	
30.0 mm = 1.20 in.	

This table converts millimeters to inches in reference to the illustrations included on these pages

M30 Non-Flush Mount

7mm (.28 in.) to 14mm (.55 in.)

Cable	Cable	65
9914-1000	9914-0500	9914-0565
18V - 30V	18V - 30V	18V - 30V
≤10 mA	≤10 mA	≤10 mA
5 mA	5 mA	5 mA
30 Hz	30 Hz	30 Hz
±0.3V	±0.3V	±0.3V
1%	1%	1%
PBTB	PBTB	PBTB
1-9V DC & 4 Bit Digital	1-9V DC	1-9V DC

Note: Sensor dimensions in mm.

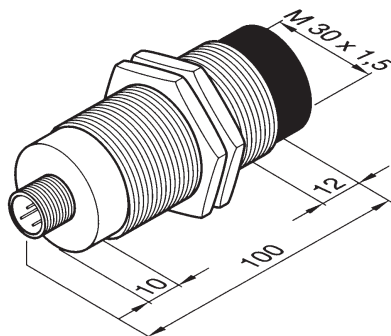
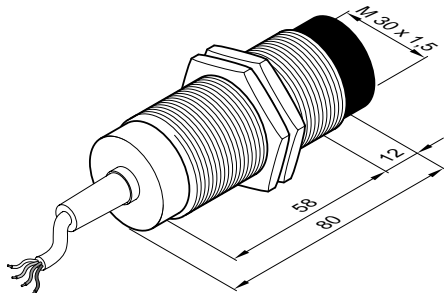

Accessories

2 meter (6 ft. 6 in.) DC Cable Assemblies for Quick Disconnect Sensors

65 Connectors, 4PIN - 4 Wire cable (PIN 1, 2, 3, 4) :
65 Connectors 8000-5280 PVC, Right Angle

Change last digit of connector number to 5 for 5 meter cable

Refer to pages 116-121 for more cable information

The analog output voltage can be digitized by the 8100-2100 switching unit and 8100-2400/2500 modules.

(Separate Accessory items - refer to pages 125 & 126 for more information.)

Mounting Brackets - see Pages 114-115

Wiring Diagrams

Note: Wire colors are applicable to cable purchased from Altech

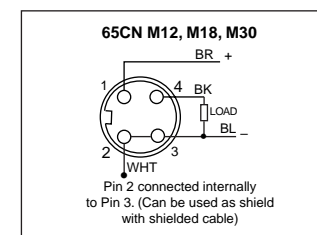
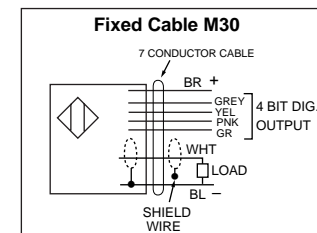
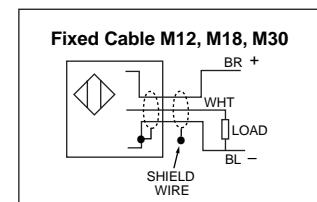

DC - 3WIRE
EXTENDED RANGE PLUS
Brass, Nickel Plated (BN),
Cylindrical, Threaded,
10-30V DC, 200mA
1 LED for Output Energized

- Up to 3 times the sensing distance
- Ideal for applications where large sensors will not fit
- Carries $\text{C}\epsilon$ mark
- IEC(529) IP67 (NEMA 1, 3, 4, 6, 12, 13) Protection
- Sensing ranges from 3mm (.12 in.) to 40mm (1.57 in.)
- Short Circuit Protection
- Overload Protection
- Reverse Polarity Protection
- Wire Break Resistance
- Temperature Range: -25 to 70°C (-13 to 158°F)

M8 Flush Mount				M8 Non-Flush Mount			
Sensing distance 3mm (0.1 in.)				6mm (0.2 in.)			
Cable or Connector Style	Cat. No.	Cable	64	65	Cable	64	65
PNP	Normally Open	9981-5000	9981-5064	9981-5065	9981-5200	9981-5264	9981-5265
	Normally Closed						
NPN	Normally Open						
	Normally Closed						
Ripple Voltage		≤20%	≤20%	≤20	≤20%	≤20%	≤20%
Voltage Range		10-30V	10-30V	10-30V	10-30V	10-30V	10-30V
Supply Current		≤20mA	≤20mA	≤20mA	≤20mA	≤20mA	≤20mA
Max. Load Current		200mA	200mA	200mA	200mA	200mA	200mA
Voltage Drop Across Sensor		≤2.4V	≤2.4V	≤2.4V	≤2.4V	≤2.4V	≤2.4V
Max. Leakage Current		≤100μA	≤100μA	≤100μA	≤100μA	≤100μA	≤100μA
Switching Frequency		1000Hz	1000Hz	1000Hz	500Hz	500Hz	500Hz
Hysteresis		10%	10%	10%	10%	10%	10%
Temperature Drift		≤10%	≤10%	≤10%	≤10%	≤10%	≤10%
Housing Material		Nickel Plated Brass	Nickel Plated Brass	Nickel Plated Brass	Nickel Plated Brass	Nickel Plated Brass	Nickel Plated Brass
Repeatability		.15mm (.005 in.)	.15mm (.005 in.)	.15mm (.005 in.)	.3mm (.01 in.)	.3mm (.01 in.)	.3mm (.01 in.)

Fixed Cable

PVC 2m (6 ft. 6 in.). Supplied with Brass, Nickel Plated (BN) locknuts.

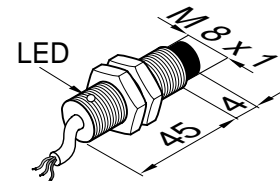
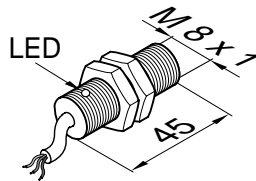

64 Connector

3-pin, Pico style, 8mm (.31 in.) supplied with Brass, Nickel Plated (BN) locknuts.

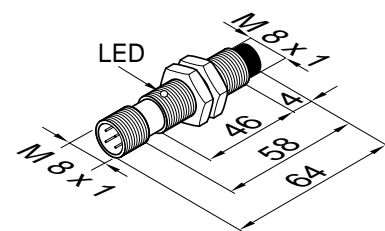
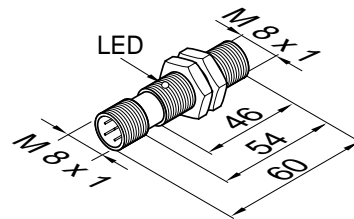

65 Style Connectors

4-pin, Micro style, 12mm (.47 in.) supplied with Brass, Nickel Plated (BN) locknuts.

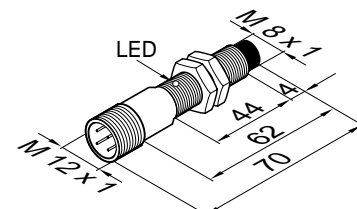
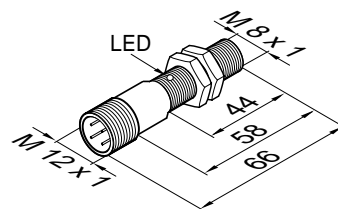

Metric/in. Conversion Table

1.0 mm = .04 in.	52.0 mm = 2.04 in.
4.0 mm = .16 in.	54.0 mm = 2.12 in.
6.0 mm = .23 in.	56.0 mm = 2.20 in.
8.0 mm = .31 in.	58.0 mm = 2.28 in.
12.0 mm = .47 in.	60.0 mm = 2.36 in.
40.0 mm = 1.39 in.	62.0 mm = 2.44 in.
44.0 mm = 1.73 in.	66.0 mm = 2.60 in.
45.0 mm = 1.77 in.	70.0 mm = 2.75 in.
50.0 mm = 1.97 in.	

This table converts millimeters to inches in reference to the illustrations included on these pages

Accessories

2 meter (6 ft. 6 in.) DC Cable Assemblies for Quick Disconnect Sensors

64 Connector	8000-5220	PVC, Straight
64 Connector	8000-5230	PVC, Right Angle, 2LED, PNP
64 Connector	8000-5240	PVC, Right Angle, 2 LED, NPN
65 Connector	8000-5110	PVC, Straight
65 Connector	8000-5120	PVC, Right Angle
65 Connector	8000-5150	PVC, Right Angle, 2LED NPN
65 Connector	8000-5160	PVC, Right Angle, 2LED PNP

Change last digit of connector number to 5 for 5 meter cable

Refer to pages 116-121 for more cable information

Mounting Brackets – see Pages 114-115

M12 Flush Mount 6mm (0.2 in.)		M12 Non-Flush Mount 10mm (0.4 in.)	
Cable	65	Cable	65
9982-5000	9982-5065	9982-5200	9982-5265
≤20%	≤20%	≤20%	≤20%
10-30V	10-30V	10-30V	10-30V
≤20mA	≤20mA	≤20mA	≤20mA
200mA	200mA	200mA	200mA
≤2.4V	≤2.4V	≤2.4V	≤2.4V
≤100µA	≤100µA	≤100µA	≤100µA
800Hz	800Hz	400Hz	400Hz
10%	10%	10%	10%
≤10%	≤10%	≤10%	≤10%
Nickel Plated Brass	Nickel Plated Brass	Nickel Plated Brass	Nickel Plated Brass
.3mm (.01 in.)	.3mm (.01 in.)	.5mm (.02 in.)	.5mm (.02 in.)

Note: Sensor dimensions in mm.

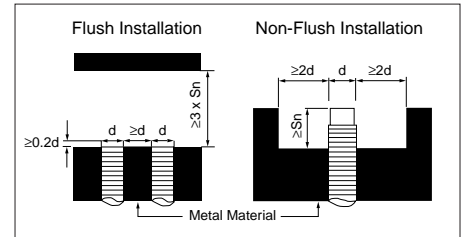
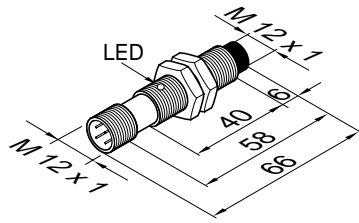
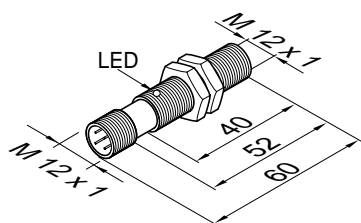
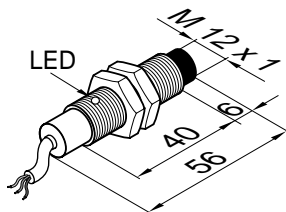
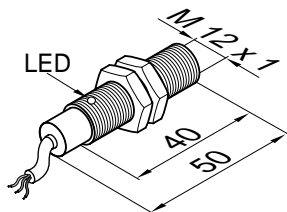

General Mounting – You must maintain minimum distance between adjacent and opposite sensors in addition to non-target metals as specified in the drawings above. Flush mount sensors must extend at least 0.2 times the sensor diameter above the adjacent metal housing. Non-flush mount sensors must extend a distance greater than the sensing distance (Sn). Please contact Altech for any installation assistance

Wiring Diagrams



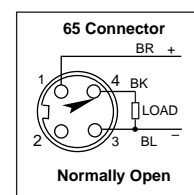
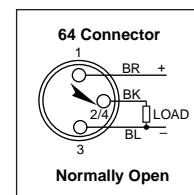
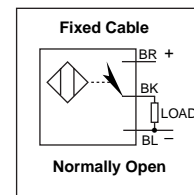

Note: Wire colors are applicable to cable purchased from Altech

PNP



**DC - 3WIRE
EXTENDED RANGE PLUS
Brass, Nickel Plated (BN),
Cylindrical, Threaded,
10-30V DC, 200mA
1 LED for Output Energized**

- Up to 3 times the sensing distance
- Ideal for applications where large sensors will not fit
- Carries C mark
- IEC(529) IP67 (NEMA 1, 3, 4, 6, 12, 13) Protection
- Sensing ranges from 3mm (.12 in.) to 40mm (1.57 in.)
- Short Circuit Protection
- Overload Protection
- Reverse Polarity Protection
- Wire Break Resistance
- Temperature Range: -25 to 70°C (-13 to 158°F)

			M18 Flush Mount		M18 Non-Flush Mount	
Sensing Distance			12mm (0.4 in.)		20mm (0.8 in.)	
Cable or Connector Style Cat. No.			Cable	65	Cable	65
PNP	Normally Open		9984-5000	9984-5065	9984-5200	9984-5265
	Normally Closed					
NPN	Normally Open					
	Normally Closed					
Ripple Voltage			≤20%	≤20%	≤20%	≤20%
Voltage Range			10V-30V	10V - 30V	10V - 30V	10V - 30V
Supply Current			≤20 mA	≤20 mA	≤20 mA	≤20 mA
Max. Load Current			200 mA	200 mA	200 mA	200 mA
Voltage Drop Across Sensor			≤2.4V	≤2.4V	≤2.4V	≤2.4V
Max. Leakage Current			≤100 μA	≤100 μA	≤100 μA	≤100 μA
Switching Frequency			500 Hz	500 Hz	200 Hz	200 Hz
Hysteresis			≤10%	≤10%	≤10%	≤10%
Temperature Drift			≤10%	≤10%	≤10%	≤10%
Housing Material			Nickel Plated Brass	Nickel Plated Brass	Nickel Plated Brass	Nickel Plated Brass
Repeatability			0.6mm (.02 in.)	0.6mm (.02 in.)	1mm (.04 in.)	1mm (.04 in.)

Fixed Cable

PVC 2m (6 ft. 6 in.). Supplied with Brass, Nickel Plated (BN) locknuts.

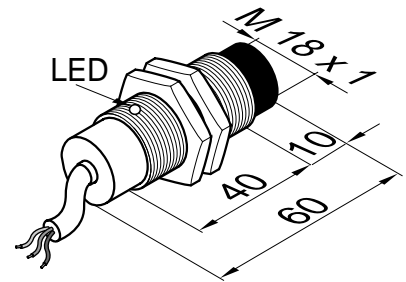
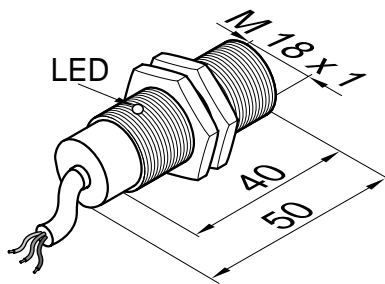

65 Style Connectors

4-pin, Micro style, 12mm (.47 in.) supplied with Brass, Nickel Plated (BN) locknuts.

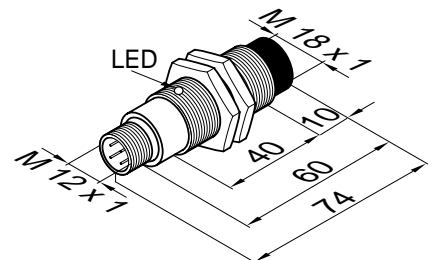
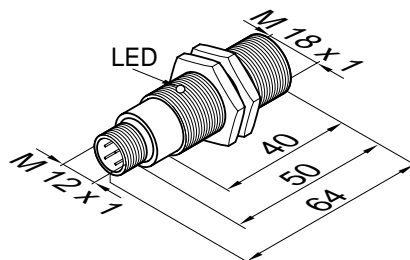

Metric/in. Conversion Table

1.0 mm = .04 in.	52.0 mm = 2.04 in.
4.0 mm = .16 in.	54.0 mm = 2.12 in.
6.0 mm = .23 in.	56.0 mm = 2.20 in.
8.0 mm = .31 in.	58.0 mm = 2.28 in.
12.0 mm = .47 in.	60.0 mm = 2.36 in.
40.0 mm = 1.57 in.	62.0 mm = 2.44 in.
44.0 mm = 1.73 in.	66.0 mm = 2.60 in.
45.0 mm = 1.77 in.	70.0 mm = 2.75 in.
50.0 mm = 1.97 in.	

This table converts millimeters to inches in reference to the illustrations included on these pages

M30 Flush Mount

22mm (0.9 in.)

M30 Non-Flush Mount

40mm (1.57 in.)

Cable	65	Cable	65
9986-5000	9986-5065	9986-5200	9986-5265
≤20%	≤20%	≤20%	≤20%
10V - 30V	10V - 30V	10V - 30V	10V - 30V
≤20 mA	≤20 mA	≤20 mA	≤20 mA
200 mA	200 mA	200 mA	200 mA
≤2.4V	≤2.4V	≤2.4V	≤2.04V
100 μA	100 μA	100 μA	100 μA
300 Hz	300 Hz	100 Hz	100 Hz
≤10%	≤10%	≤10%	≤15%
≤10%	≤10%	≤10%	≤10%
Nickel Plated Brass	Nickel Plated Brass	Nickel Plated Brass	Nickel Plated Brass
1.1mm (.045 in.)	1.1mm (.045 in.)	2mm (.078 in.)	2mm (.078 in.)

Note: Sensor dimensions in mm.

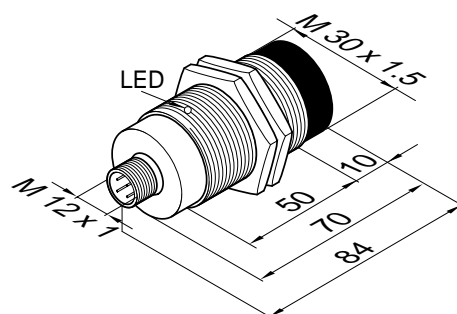
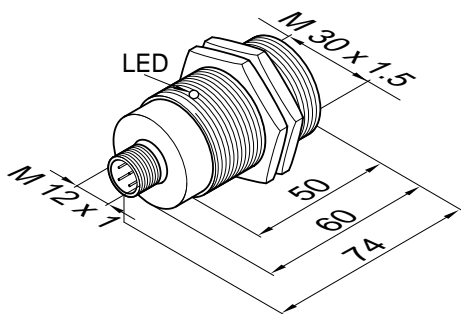
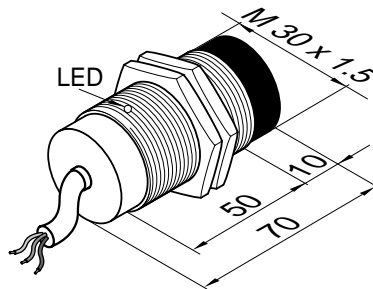
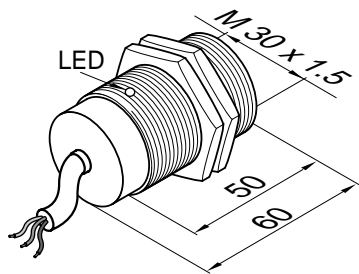

Accessories

2 meter (6 ft. 6 in.) DC Cable Assemblies for Quick Disconnect Sensors

65 Connector	8000-5110	PVC, Straight
65 Connector	8000-5120	PVC, Right Angle
65 Connector	8000-5150	PVC, Right Angle, 2LED NPN
65 Connector	8000-5160	PVC, Right Angle, 2LED PNP

Change last digit of connector number to 5 for 5 meter cable

Refer to pages 116-121 for more cable information

Mounting Brackets – see Pages 114-115

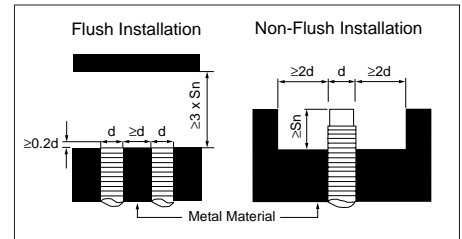

General Mounting – You must maintain minimum distance between adjacent and opposite sensors in addition to non-target metals as specified in the drawings above. Flush mount sensors must extend at least 0.2 times the sensor diameter above the adjacent metal housing. Non-flush mount sensors must extend a distance greater than the sensing distance (Sn). Please contact Altech for any installation assistance

Wiring Diagrams

Note: Wire colors are applicable to cable purchased from Altech

PNP

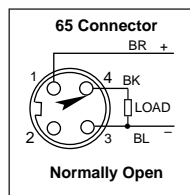
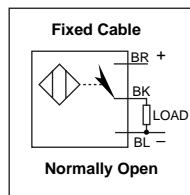

DC - 2 WIRE NAMUR
Brass, Nickel Plated (BN),
and Plastic (TROGAMID-T)
Cylindrical, Threaded

- **Low energy device**
- **Operates in hazardous areas with external amplifier**
- **Meets NAMUR regulations and DIN 19234 specifications**
- **Carries C mark**

- IEC(529) IP67 (NEMA 1, 3, 4, 6, 12, 13) Protection
- Reverse Polarity Protection
- Plastic and Metal Housing according to NAMUR Regulations and DIN 19234
- Temperature Range: -25 to 70°C (-13 to 158°F)
 (For extended temperature models of -40°C to +125°C, consult Altech.)

Sensing Distance	M8 Flush Mount 1mm (.04 in.)		M8 Non-Flush Mount 2mm (.08 in.)	
	Cable	65	Cable	65
Cable or Connector Style Cat. No.				
Nickel Plated Brass (BN)	9932-0100	9932-0165	9932-0200	9932-0265
Plastic (TROGAMID T)			9932-1600	
Ripple Voltage	≤5%	≤5%	≤15%	≤5%
Voltage Range (supplied by Pulsotronic 8100-2200 Unit)	8.2V DC at 1KΩ	8.2V DC at 1KΩ	8.2V DC at 1KΩ	8.2V DC at 1KΩ
Output Current (with target detection)	0.5 mA	0.5 mA	0.5 mA	0.5 mA
Output Current (no target detection)	3.5 mA	3.5 mA	3.5 mA	3.5 mA
Switching Frequency	2000 0Hz	2000 Hz	1000 Hz	1000 Hz
Hysteresis	≤15%	≤15%	≤15%	≤15%
Temperature Drift	≤10%	≤10%	≤10%	≤10%
Repeatability	.1mm (.004 in.)	.1mm (.004 in.)	.2mm (.008 in.)	.2mm (.008 in.)
Front Cap Material	PBTP (Metal Housing)	PBTP (Metal Housing)	PBTP (Metal Housing)	PBTP (Metal Housing)

Fixed Cable

PVC 2m (6ft. 6in.). For 5m (16 ft. 5 in.) cable length, change the last two digits of the part number to 02. For other cable lengths and/or PUR cable, please consult Altech. Non-metallic locknuts for M8 and Brass, Nickel Plated (BN) locknuts for M12 through M30.

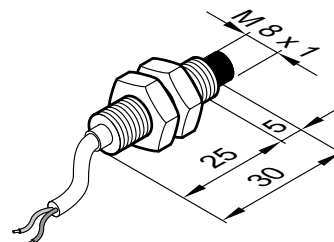
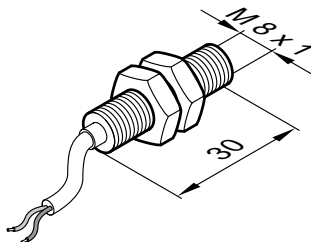

65 Style Connector

4-pin, Micro style, 12mm (.47 in.) supplied with non-metallic locknuts for M8 and Brass, Nickel Plated (BN) locknuts for M12 through M30.

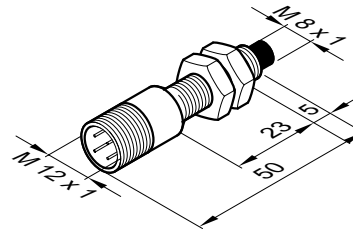
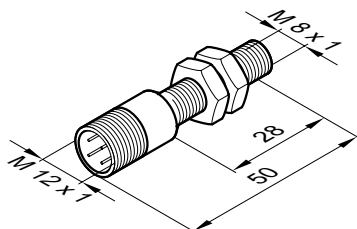

Metric/in. Conversion Table

1.0 mm = .04 in.	24.0 mm = .94 in.
5.0 mm = .20 in.	25.0 mm = 1.0 in.
6.0 mm = .23 in.	28.0 mm = 1.16 in.
8.0 mm = .31 in.	30.0 mm = 1.20 in.
12.0 mm = .47 in.	40.0 mm = 1.57 in.
23.0 mm = .91 in.	50.0 mm = 1.97 in.

This table converts millimeters to inches in reference to the illustrations included on these pages

M12 Flush Mount 2mm (.08 in.)

M12 Non-Flush Mount 4mm (.16 in.)

Cable	65	Cable	65
9932-0300	9932-0365	9932-0400	9932-0465
9932-1100		9932-1000	
≤15%	≤5%	≤5%	≤5%
8.2V DC at 1KΩ	8.2V DC at 1KΩ	8.2V DC at 1KΩ	8.2V DC at 1KΩ
0.5 mA	0.5 mA	0.5 mA	0.5 mA
3.5 mA	3.5 mA	3.5 mA	3.5 mA
2000 Hz	2000 Hz	1000 Hz	1000 Hz
≤15%	≤15%	≤15%	≤15%
≤10%	≤10%	≤10%	≤10%
.2mm (.008 in.)	.2mm (.008 in.)	.4mm (.016 in.)	.4mm (.016 in.)
PBTP (Metal Housing)	PBTP (Metal Housing)	PBTP (Metal Housing)	PBTP (Metal Housing)

Note: Sensor dimensions in mm.

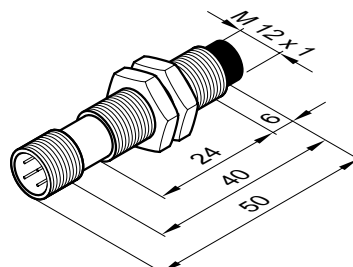
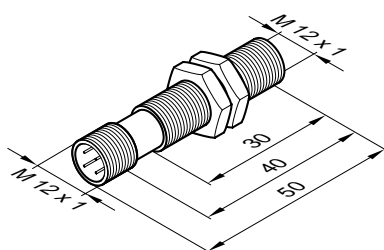
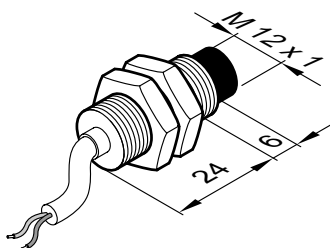
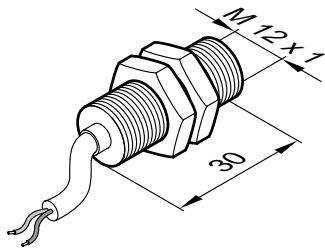

Accessories

2 meter (6 ft. 6 in.) DC Cable Assemblies for Quick Disconnect Sensors

65 Connectors, 4 PIN – 4 Wire cable (PIN 1, 2, 3, 4) :
65 Connector 8000-5280 PVC Right Angle

Change last digit of connector number to 5 for 5 meter cable

Refer to pages 116-121 for more cable information

Remote Amplifier –
Use 8100-2200, see page 123

Mounting Brackets – see Pages 114-115

Wiring Diagrams

Note: Wire colors are applicable to cable purchased from Altech

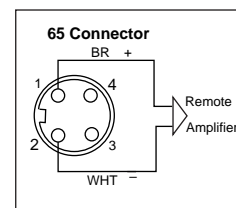
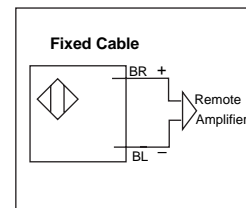

DC - 2 WIRE NAMUR
Brass, Nickel Plated (BN),
and Plastic (TROGAMID-T)
Cylindrical, Threaded

- **Low energy device**
- **Operates in hazardous areas with external amplifier**
- **Meets NAMUR regulations and DIN 19234 specifications**
- **Carries C€ mark**

- IEC(529) IP67 (NEMA 1, 3, 4, 6, 12, 13) Protection
- Reverse Polarity Protection
- Plastic and Metal Housing according to NAMUR Regulations and DIN 19234
- Temperature Range: -25 to 70°C (-13 to 158°F)

Sensing Distance	M18 Flush Mount		M18 Non-Flush Mount	
	5mm (.20 in.)		8mm (.31 in.)	
Cable or Connector Style Cat. No.	Cable	65	Cable	65
Nickel Plated Brass (BN)	9932-0500	9932-0565	9932-0600	9932-0665
Plastic (TROGAMID T)	9932-1300		9932-1200	
Ripple Voltage	≤5%	≤5%	≤5%	≤5%
Voltage Range (supplied by Pulsotronic 8100-2200 Unit)	8.2V DC at 1KΩ	8.2V DC at 1KΩ	8.2V DC at 1KΩ	8.2V DC at 1KΩ
Output Current (with target detection)	0.5 mA	0.5 mA	0.5 mA	0.5 mA
Output Current (no target detection)	3.5 mA	3.5 mA	3.5 mA	3.5 mA
Switching Frequency	1000 0Hz	1000 Hz	500 Hz	500 Hz
Hysteresis	≤15%	≤15%	≤15%	≤15%
Temperature Drift	≤10%	≤10%	≤10%	≤10%
Repeatability	.5mm (.02 in.)	.5mm (.02 in.)	.8mm (.03 in.)	.8mm (.03 in.)
Front Cap Material	PBTP (Metal Housing)	PBTP (Metal Housing)	PBTP (Metal Housing)	PBTP (Metal Housing)

Fixed Cable

PVC 2m (6ft. 6in.). For 5m (16 ft. 5 in.) cable length, change the last two digits of the part number to 02. For other cable lengths and/or PUR cable, please consult Altech. Supplied with Brass, Nickel Plated (BN) locknuts.

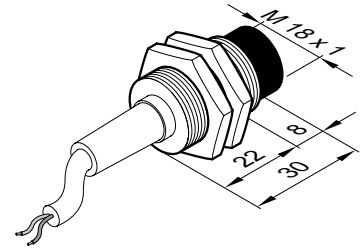
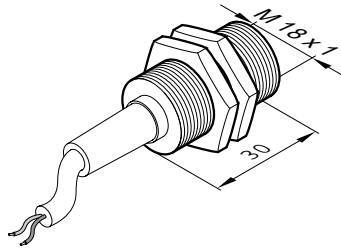

65 Style Connector

4-pin, Micro style, 12mm (.47 in.) supplied with Brass, Nickel Plated (BN) locknuts.

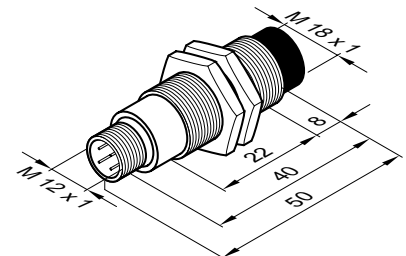
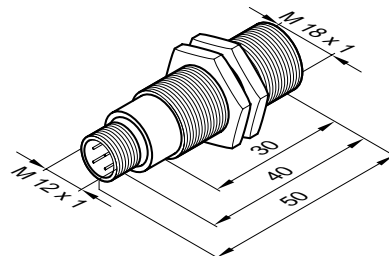

Metric/in. Conversion Table

1.0 mm = .04 in.	28.0 mm = 1.16 in.
1.5 mm = .06 in.	30.0 mm = 1.20 in.
8.0 mm = .31 in.	40.0 mm = 1.57 in.
12.0 mm = .47 in.	50.0 mm = 1.96 in.
18.0 mm = .70 in.	51.0 mm = 2.00 in.
22.0 mm = .86 in.	60.0 mm = 2.36 in.

This table converts millimeters to inches in reference to the illustrations included on these pages

Accessories

2 meter (6 ft. 6 in.) DC Cable Assemblies for Quick Disconnect Sensors

65 Connectors, 4 PIN – 4 Wire cable (PIN 1, 2, 3, 4) :
65 Connector 8000-5280 PVC Right Angle

Change last digit of connector number to 5 for 5 meter cable

Refer to pages 116-121 for more cable information

Remote Amplifier – Use 8100-2200, see page 123

Mounting Brackets – see Pages 114-115

M30 Flush Mount 10mm (.39 in.)		M30 Non-Flush Mount 15mm (.59 in.)	
Cable	65	Cable	65
9932-0700	9932-0765	9932-0800	9932-0865
9932-1500		9932-1400	
≤5%	≤5%	≤5%	≤5%
8.2V DC at 1KΩ	8.2V DC at 1KΩ	8.2V DC at 1KΩ	8.2V DC at 1KΩ
0.5 mA	0.5 mA	0.5 mA	0.5 mA
3.5 mA	3.5 mA	3.5 mA	3.5 mA
500 Hz	500 Hz	300 Hz	300 Hz
≤15%	≤15%	≤15%	≤15%
≤10%	≤10%	≤10%	≤10%
.1mm (.039 in.)	.1mm (.039 in.)	1.5mm (.059 in.)	1.5mm (.059 in.)
PBTP (Metal Housing)	PBTP (Metal Housing)	PBTP (Metal Housing)	PBTP (Metal Housing)

Note: Sensor dimensions in mm.

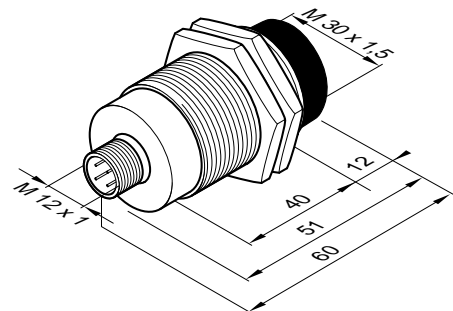
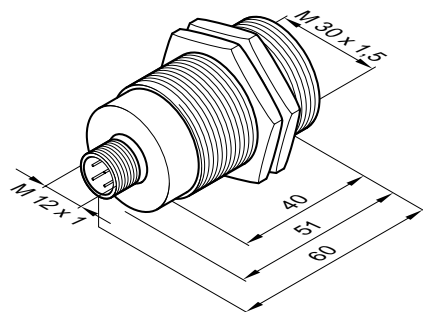
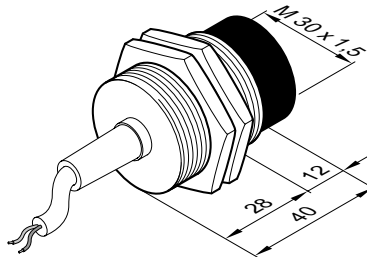
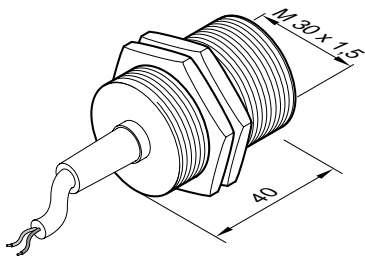

Wiring Diagrams

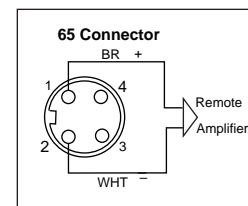
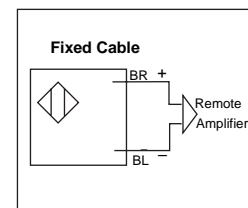

Note: Wire colors are applicable to cable purchased from Altech



DC - 2 WIRE SENSORS
Brass, Nickel Plated (BN),
Cylindrical, Threaded,
M12 – 5-30V DC, 100mA
M18, M30 – 10-55V DC, 200 mA
1 LED for Output Energized

- **2 Wire devices reduce wiring requirements**
- **Economically Priced**
- **Carries C mark**

- IEC(529) IP67 (NEMA 1, 3, 4, 6, 12, 13) Protection
- Reverse Polarity Protection
- Temperature Range: -25 to 70°C (-13 to 158°F)

Sensing distance	M12 Flush Mount 2mm (.08 in.)		M12 Non-Flush Mount 4mm (.16 in.)		M18 Flush Mount 5mm (0.2 in.)
	Cable	65	Cable	65	Cable
Cable or Connector Style Cat. No.					
Normally Open 	9962-5600	9962-5665	9962-5700	9962-5765	9964-5400
Normally Closed 					
Ripple Voltage	≤10%	≤10%	≤10%	≤10%	≤10%
Voltage Range	5V-30V	5V-30V	5V-30V	5V-30V	10V-55V
Supply Current	≤3mA	≤3mA	≤3mA	≤3mA	≤5mA
Max. Load Current	100mA	100mA	100mA	100mA	200mA
Voltage Drop Across Sensor	≤5V	≤5V	≤5V	≤5V	≤6.5V
Max. Leakage Current	≤0.5mA	≤0.5mA	≤0.5mA	≤0.5mA	≤1.5mA
Switching Frequency	500Hz	500Hz	500Hz	500Hz	1000Hz
Hysteresis	≤15%	≤15%	≤15%	≤15%	≤15%
Temperature Drift	≤10%	≤10%	≤10%	≤10%	≤10%
Repeatability	.20mm (.008 in.)	.20mm (.008 in.)	.40mm (.016 in.)	.40mm (.016 in.)	.40mm (.016 in.)
Front Cap Material	PBTP	PBTP	PBTP	PBTP	PBTP

Fixed Cable

PVC 2m (6ft. 6in.). For 5m (16 ft. 5 in.) cable length, change the last two digits of the part number to 02. For other cable lengths and/or PUR cable, please consult Altech. Supplied with Brass, Nickel Plated (BN) locknuts.

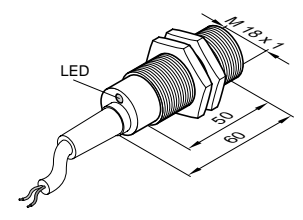
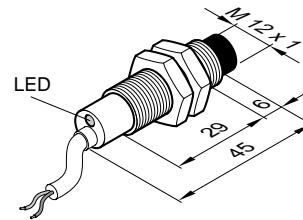
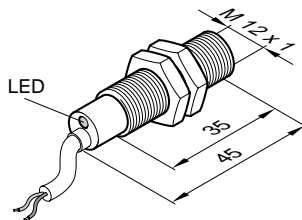

65 Style Connector

4-pin, Micro style, 12mm (.47 in.) supplied with Brass, Nickel Plated (BN) locknuts.

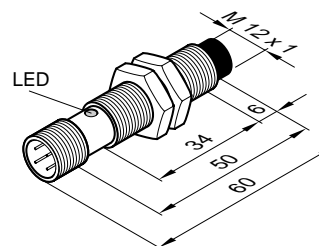
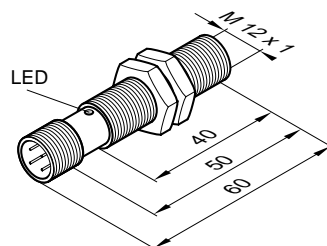

Metric/in. Conversion Table

1.5 mm = .06 in.	23.0 mm = .08 in.
2.0 mm = .08 in.	28.0 mm = 1.10 in.
4.0 mm = .16 in.	30.0 mm = 1.18 in.
5.0 mm = .20 in.	32.0 mm = 1.26 in.
6.0 mm = .23 in.	34.0 mm = 1.34 in.
8.0 mm = .31 in.	40.0 mm = 1.57 in.
10.0 mm = .39 in.	50.0 mm = 1.97 in.
12.0 mm = .47 in.	51.0 mm = 2.01 in.
15.0 mm = .59 in.	60.0 mm = 2.36 in.
18.0 mm = .70 in.	80.0 mm = 3.12 in.

This table converts millimeters to inches in reference to the illustrations included on these pages

M18 Non-Flush Mount 8mm (.31 in.)	M30 Flush Mount 10mm (.39 in.)	M30 Non-Flush Mount 15mm (.59 in.)
Cable	Cable	Cable
9964-5500	9966-5400	9966-5500
≤10%	≤10%	≤10%
10V-55V	10V-55V	10V-55V
≤5mA	≤5mA	≤5mA
200mA	200mA	200mA
≤6.5V	≤6.5V	≤6.5V
≤1.5mA	≤1.5mA	≤1.5mA
500Hz	500Hz	300Hz
≤15%	≤15%	≤15%
≤10%	≤10%	≤10%
.80mm (.03 in.)	1mm (.039 in.)	1.5mm (.059 in.)
PBTP	PBTP	PBTP

Note: Sensor dimensions in mm.

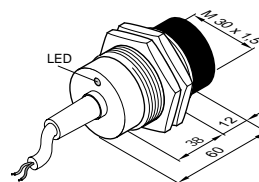
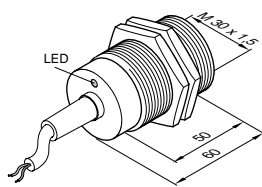
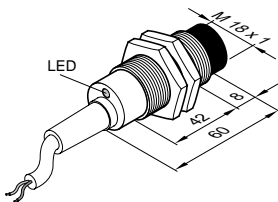

Accessories

2 meter (6 ft. 6 in.) DC Cable Assemblies for Quick Disconnect Sensors

65 Connector 8000-5110 PVC, Straight
65 Connector 8000-5120 PVC, Right Angle

Change last digit of connector number to 5 for 5 meter cable

Refer to pages 116-121 for more cable information

Mounting Brackets – see Pages 114-115

Wiring Diagrams

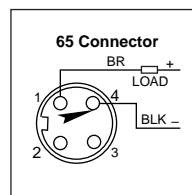
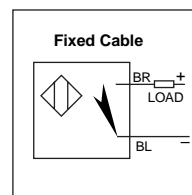

Note: Wire colors are applicable to cable purchased from Altech



**AC - 2 WIRE
STANDARD SERIES
Brass, Nickel Plated (BN),
Cylindrical, Threaded,
90-250V AC, 180 mA,
1 LED for Output Energized**

- **Most complete range of Fixed Cable and Quick Disconnect Styles**
- **Available in normally open (N.O.) and normally closed (N.C.) output configuration**
- **This series features the 360° LED viewing connector type "67"**
- **Carries CЄ mark**

- IEC (529) IP67 (NEMA 1, 3, 4, 6, 12, 13) Protection
- Temperature Range: -25 to 70°C (-13 to 158°F)

Sensing Distance	M12 Flush Mount 2mm (.08 in.)				M12 Non-Flush Mount 4mm (.16 in.)				
	Cable or Connector Style Cat. No.	Cable	62	66/67	68	Cable	62	66/67	68
Normally Open 		9952-0500	9952-0562	9952-0566 9952-0567	9952-0568	9952-0400	9952-0462	9952-0466 9952-0467	9952-0468
Normally Closed 		9952-0900		9952-0966 9952-0967	9952-0968	9952-0800		9952-0866 9952-0867	9952-0868
Voltage Range		90V-250V	90V - 250V	90V - 250V	90V - 250V	90V - 250V	90V - 250V	90V - 250V	90V - 250V
Operating Frequency		50/60Hz	50/60Hz	50/60Hz	50/60Hz	50/60Hz	50/60Hz	50/60Hz	50/60Hz
Supply Current		5 mA	5 mA	5 mA	5 mA	5 mA	5 mA	5 mA	5 mA
Max. Load Current		180 mA	100 mA	180 mA	180 mA	180 mA	180 mA	180 mA	180 mA
Voltage Drop Across Sensor		≤8V	≤8V	≤8V	≤8V	≤8V	≤8V	≤8V	≤8V
Max. Leakage Current		≤3mA/220V ≤1.5mA/110V	≤3mA/220V ≤1.5mA/110V	≤3mA/220V ≤1.5mA/110V	≤3mA/220V ≤1.5mA/110V	≤3mA/220V ≤1.5mA/110V	≤3mA/220V ≤1.5mA/110V	≤3mA/220V ≤1.5mA/110V	≤3mA/220V ≤1.5mA/110V
Short Term Current (20ms 1Hz)		1A	1A	1A	1A	1A	1A	1A	1A
Switching Frequency		15Hz/220V	15Hz/220V	15Hz/220V	15Hz/220V	15Hz/220V	15Hz/220V	15Hz/220V	15Hz/220V
Hysteresis		≤15%	≤15%	≤15%	≤15%	≤15%	≤15%	≤15%	≤15%
Temperature Drift		≤10%	≤10%	≤10%	≤10%	≤10%	≤10%	≤10%	≤10%
Repeatability		2mm (.008in.)	.2mm (.008in.)	.2mm (.008in.)	.2mm (.008in.)	.4mm (.016in.)	.4mm (.016in.)	.4mm (.016in.)	.4mm (.016in.)
Front Cap Material		PBTP	PBTP	PBTP	PBTP	PBTB	PBTB	PBTB	PBTB

Fixed Cable

PVC 2m (6ft. 6in.). For 5m (16 ft. 5 in.) cable length, change the last two digits of the part number to 02. For other cable lengths and/or PUR cable, please consult Altech. Supplied with Brass, Nickel Plated (BN) locknuts.

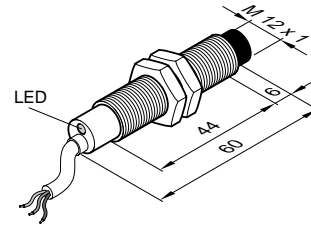
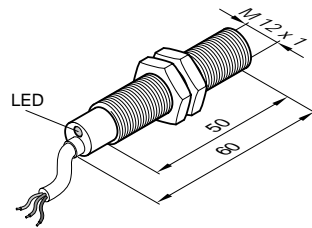

62 Style Connector

3-pin, Mini style, 25mm (1.0 in.) supplied with Brass, Nickel Plated (BN) locknuts.

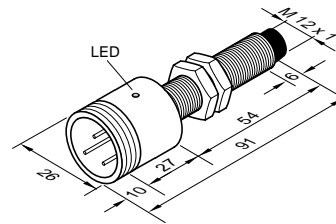
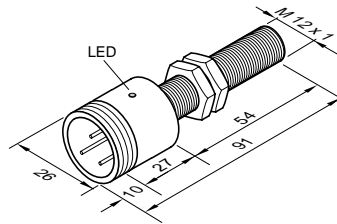

66/67/68 Style Connectors

The 66/67 connectors are 4-pin, (68 connector, 3-pin), Micro style, 12mm (.47 in.) supplied with Brass, Nickel Plated (BN) locknuts. The 67 Connector is clear, offering 360° LED viewing.

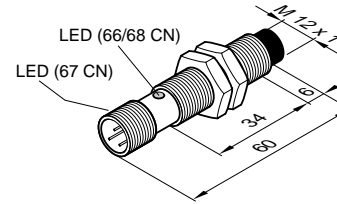
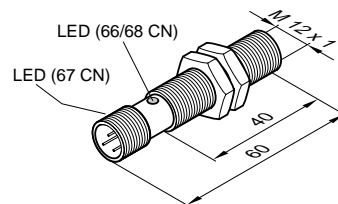

Metric/in. Conversion Table

1.0 mm = .04 in.	29.0 mm = 1.14 in.
5.0 mm = .20 in.	34.0 mm = 1.34 in.
6.0 mm = .23 in.	35.0 mm = 1.37 in.
8.0 mm = .31 in.	40.0 mm = 1.57 in.
12.0 mm = .47 in.	43.0 mm = 1.69 in.
23.0 mm = .90 in.	50.0 mm = 1.47 in.
28.0 mm = 1.10 in.	60.0 mm = 2.36 in.

This table converts millimeters to inches in reference to the illustrations included on these pages

Accessories

2 meter (6 ft. 6 in.) AC Cable Assemblies for Quick Disconnect Sensors

62 Connector	8000-5030	PVC, Straight
66/67 Connector	8000-5060	PVC, Right Angle
66/67 Connector	8000-5070	PVC, Straight
68 Connector	8000-5130	PVC Straight
68 Connector	8000-5140	Right Angle

Change last digit of connector number to 5 for 5 meter cable

Refer to pages 116-121 for more cable information

Mounting Brackets – see Pages 114-115

M18 Flush Mount 5mm (.02 in.)

M18 Non-Flush Mount 8mm (.031 in.)

Cable	62	66/67	68	Cable	62	66/67	68
9954-2200	9954-2262	9954-2266 9954-2267	9954-2268	9954-1900	9954-1962	9954-1966 9954-1967	9954-1968
9954-2600		9954-2666 9954-2667	9954-2668	9954-2500			9954-2568
90V - 250V	90V - 250V	90V - 250V	90V - 250V	90V - 250V	90V - 250V	90V - 250V	90V - 250V
50/60Hz	50/60Hz	50/60Hz	50/60Hz	50/60Hz	50/60Hz	50/60Hz	50/60Hz
5 mA	5 mA	5 mA	5 mA	5 mA	5 mA	5 mA	5 mA
180 mA	180 mA	180 mA	180 mA	180 mA	180 mA	180 mA	180 mA
≤8V	≤8V	≤8V	≤8V	≤8V	≤8V	≤8V	≤8V
≤3mA/220V	≤3mA/220V	≤3mA/220V	≤3mA/220V	≤3mA/220V	≤3mA/220V	≤3mA/220V	≤3mA/220V
≤1.5mA/110V	≤1.5mA/110V	≤1.5mA/110V	≤1.5mA/110V	≤1.5mA/110V	≤1.5mA/110V	≤1.5mA/110V	≤1.5mA/110V
1A	1A	1A	1A	1A	1A	1A	1A
15Hz/220V	15Hz/220V	15Hz/220V	15Hz/220V	15Hz/220V	15Hz/220V	15Hz/220V	15Hz/220V
≤15%	≤15%	≤15%	≤15%	≤15%	≤15%	≤15%	≤15%
≤10%	≤10%	≤10%	≤10%	≤10%	≤10%	≤10%	≤10%
.5mm (.02in.)	.5mm (.02in.)	.5mm (.02in.)	.5mm (.02in.)	.8mm (.031in.)	.8mm (.031in.)	.8mm (.031in.)	.8mm (.031in.)
PBTB	PBTB	PBTB	PBTB	PBTB	PBTB	PBTB	PBTB

Note: Sensor dimensions in mm.

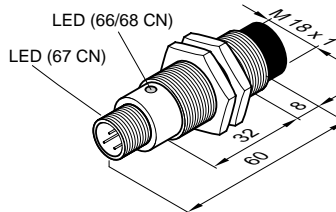
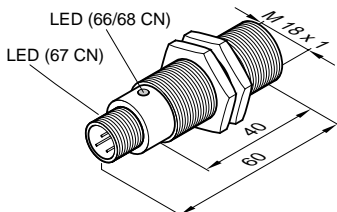
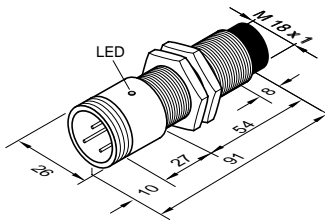
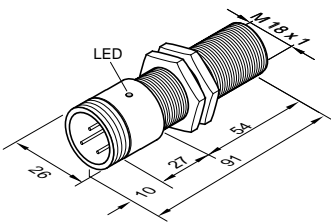
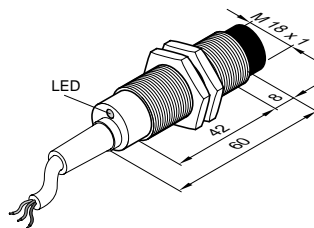
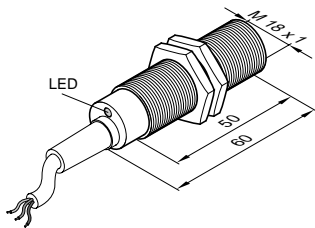

Wiring Diagrams

Note: Wire colors are applicable to cable purchased from Altech

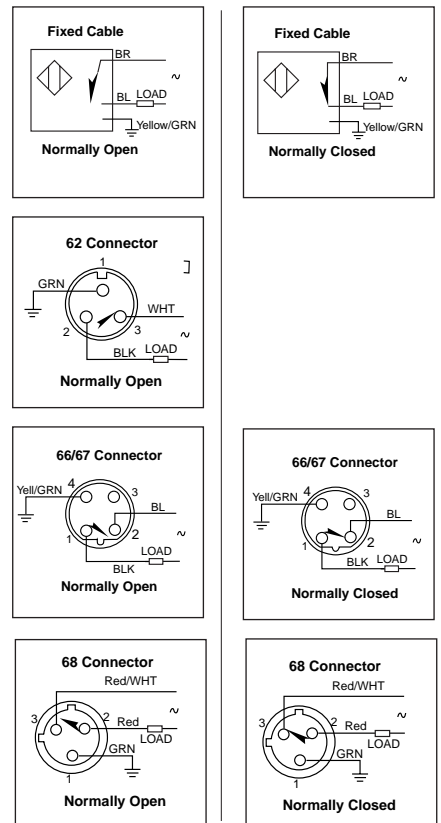

**AC - 2 WIRE
STANDARD SERIES
Brass, Nickel Plated (BN),
Cylindrical, Threaded,
90-250V AC, 180 mA,
1 LED for Output Energized**

- **Most complete range of Fixed Cable and Quick Disconnect Styles**
- **Available in normally open (N.O.) and normally closed (N.C.) output configuration**
- **This series features the 360° LED viewing connector type "67"**
- **Carries C mark**

- IEC (529) IP67 (NEMA 1, 3, 4, 6, 12, 13) Protection
- Temperature Range: -25 to 70°C (-13 to 158°F)

**M30 Flush Mount
10mm (.39 in.)**

Sensing Distance		10mm (.39 in.)				
Cable or Connector Style Cat. No.	Cable	62	66	67	68	
Normally Open 	9956-1500	9956-1562	9956-1566	9956-1567	9956-1568	
Normally Closed 	9956-1900				9956-1968	
Voltage Range	90V - 250V	90V - 250V	90V - 250V	90V - 250V	90V - 250V	
Operating Frequency	50/60Hz	50/60Hz	50/60Hz	50/60Hz	50/60Hz	
Supply Current	5 mA	5 mA	5 mA	5 mA	5 mA	
Max. Load Current	180 mA	100 mA	180 mA	180 mA	180 mA	
Voltage Drop Across Sensor	≤8V	≤8V	≤8V	≤8V	≤8V	
Max. Leakage Current	≤3A/220V ≤1.5mA/110V	≤3A/220V ≤1.5mA/110V	≤3A/220V ≤1.5mA/110V	≤3A/220V ≤1.5mA/110V	≤3A/220V ≤1.5mA/110V	
Short Term Current (20ms 1Hz)	1A	1A	1A	1A	1A	
Switching Frequency	15Hz/220V	15Hz/220V	15Hz/220V	15Hz/220V	15Hz/220V	
Hysteresis	≤15%	≤15%	≤15%	≤15%	≤15%	
Temperature Drift	≤10%	≤10%	≤10%	≤10%	≤10%	
Repeatability	1mm (.039 in.)	1mm (.039 in.)	1mm (.039 in.)	1mm (.039 in.)	1mm (.039 in.)	
Front Cap Material	PBTP	PBTP	PBTP	PBTP	PBTP	

Fixed Cable

PVC 2m (6ft. 6in.). For 5m (16 ft. 5 in.) cable length, change the last two digits of the part number to 02. For other cable lengths and/or PUR cable, please consult Altech. Supplied with Brass, Nickel Plated (BN) locknuts.

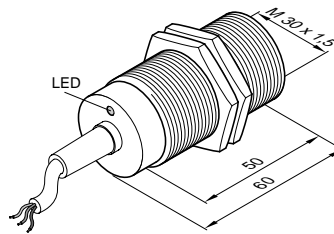

62 Style Connector

3-pin, Mini style, 25mm (1.0 in.) supplied with Brass, Nickel Plated (BN) locknuts.

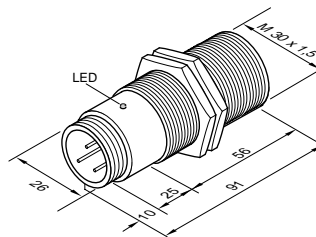

66/67/68 Style Connectors

The 66/67 connectors are 4-pin, (68 connector, 3-pin), Micro style, 12mm (.47 in.) supplied with Brass, Nickel Plated (BN) locknuts. The 67 Connector is clear, offering 360° LED viewing.

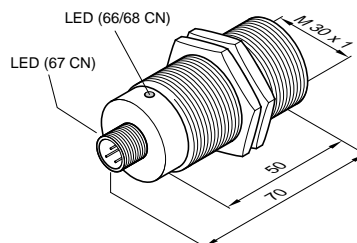

Metric/in. Conversion Table

1.0 mm = .04 in.	29.0 mm = 1.14 in.
5.0 mm = .20 in.	34.0 mm = 1.34 in.
6.0 mm = .23 in.	35.0 mm = 1.37 in.
8.0 mm = .31 in.	40.0 mm = 1.57 in.
12.0 mm = .47 in.	43.0 mm = 1.69 in.
23.0 mm = .90 in.	50.0 mm = 1.97 in.
28.0 mm = 1.10 in.	60.0 mm = 2.36 in.

This table converts millimeters to inches in reference to the illustrations included on these pages

M30 Non-Flush Mount 15mm (0.59 in.)

Cable	62	66	67	68
9956-1400	9956-1462	9956-1466	9956-1467	9956-1468
9956-1800				9956-1868
90V - 250V	90V - 250V	90V - 250V	90V - 250	90V - 250V
50/60Hz	50/60Hz	50/60Hz	50/60Hz	50/60Hz
5 mA	5 mA	5 mA	5 mA	5 mA
180 mA	180 mA	180 mA	180 mA	180 mA
≤8V	≤8V	≤8V	≤8V	≤8V
≤3A/220V	≤3A/220V	≤3A/220V	≤3A/220V	≤3A/220V
≤1.5mA/110V	≤1.5mA/110V	≤1.5mA/110V	≤1.5mA/110V	≤1.5mA/110V
1A	1A	1A	1A	1A
15Hz/220V	15Hz/220V	15Hz/220V	15Hz/220V	15Hz/220V
≤15%	≤15%	≤15%	≤15%	≤15%
≤10%	≤10%	≤10%	≤10%	≤10%
1.5mm (.059in.)	1.5mm (.059 in.)	.4mm (.016in.)	.4mm (.016in.)	.5mm (.02in.)
PBTB	PBTB	PBTB	PBTB	PBTB

Note: Sensor dimensions in mm.

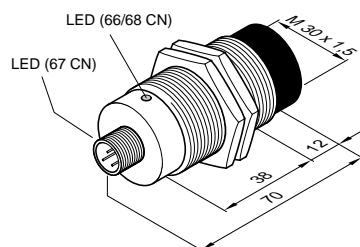
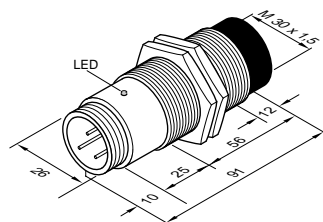
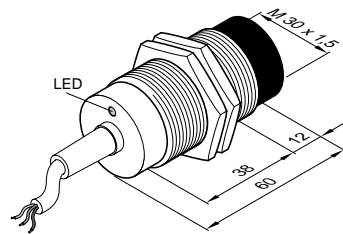

Accessories

2 meter (6 ft. 6 in.) AC Cable Assemblies for Quick Disconnect Sensors

62 Connector	8000-5030	PVC, Straight
66/67 Connector	8000-5060	PVC, Right Angle
66/67 Connector	8000-5070	PVC, Straight
68 Connector	8000-5130	PVC Straight
68 Connector	8000-5140	Right Angle

Change last digit of connector number to 5 for 5 meter cable

Refer to pages 116-121 for more cable information

Mounting Brackets – see Pages 114-115

Wiring Diagrams

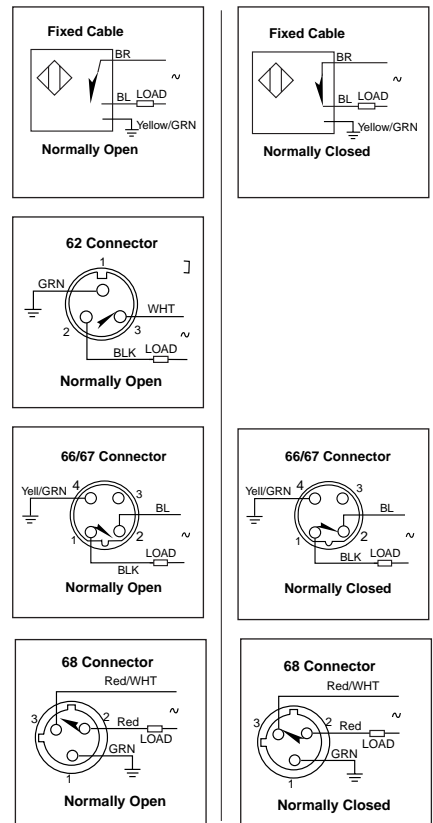

Note: Wire colors are applicable to cable purchased from Altech



**AC - 2 WIRE - EXTENDED
VOLTAGE RANGE – Brass, Nickel
Plated (BN), and TROGAMID T
Cylindrical, Threaded,
20-250V AC, 500 mA,
1 LED for Output Energized**

- **Higher Current Rating**
- **Wider Voltage Range**
- **Carries $\text{C}\epsilon$ mark**

- IEC (529) IP67 (NEMA 1, 3, 4, 6, 12, 13) Protection
- Temperature Range:
-25 to 70°C (-13 to 158°F)

Sensing Distance	M12 Flush Mount 2mm (.08 in.)			M12 Non-Flush Mount 4mm (.16 in.)		
	Cable or Connector Style Cat. No.	Cable	Cable	68	Cable	Cable
Normally Open 	9924-0500	9924-1100	9924-0568	9924-0700	9924-1000	9924-0768
Normally Closed 	9924-0400	9924-1300	9924-0468	9924-0900	9924-1200	9924-0968
Voltage Range	20V-250V	20V - 250V	20V - 250V	20V - 250V	20V - 250V	20V - 250V
Operating Frequency	50/60Hz	50/60Hz	50/60Hz	50/60Hz	50/60Hz	50/60Hz
Supply Current	2 mA	2 mA	2 mA	2 mA	2 mA	2 mA
Max. Load Current	300 mA	300 mA	300 mA	300 mA	300 mA	300 mA
Voltage Drop Across Sensor	≤5V	≤5V	≤5V	≤5V	≤5V	≤5V
Max. Leakage Current	≤2mA	≤2mA	≤2mA	≤2mA	≤2mA	≤2mA
Short Term Current (20 ms, 1Hz)	2A	2A	2A	2A	2A	2A
Switching Frequency	15Hz	15Hz	15Hz	15Hz	15Hz	15Hz
Hysteresis	≤15%	≤15%	≤15%	≤15%	≤15%	≤15%
Temperature Drift	≤10%	≤10%	≤10%	≤10%	≤10%	≤10%
Repeatability	.20mm (.008 in.)	.20mm (.008 in.)	.20mm (.008 in.)	.40mm (.016 in.)	.40mm (.016 in.)	.40mm (.016 in.)
Front Cap Material	PBTP	PBTP	PBTP	PBTB	PBTB	PBTB
Housing Material	Nickel Plated Brass	Trogamid T	Nickel Plated Brass	Nickel Plated Brass	Trogamid T	Nickel Plated Brass

Nickel Plated Brass Housings

Fixed Cable

PVC 2m (6ft. 6in.). For 5m (16 ft. 5 in.) cable length, change the last two digits of the part number to 02. For other cable lengths and/or PUR cable, please consult Altech. Supplied with non-metallic locknuts for Trogamid T housings and Nickel Plated (BN) locknuts for Nickel Plated Brass housings.

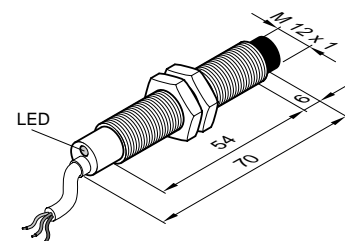
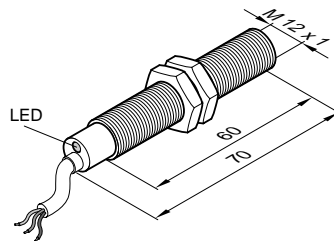

Trogamid T Housings

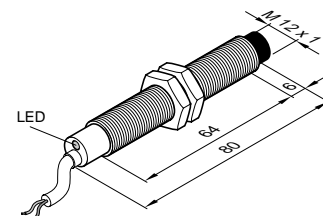
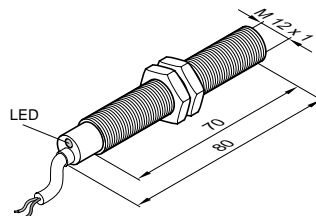

68 Style Connectors

3-pin, Micro style, 12mm (.47 in.) supplied with Brass, Nickel Plated (BN) locknuts.

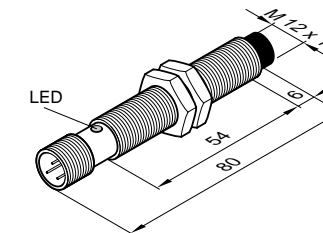
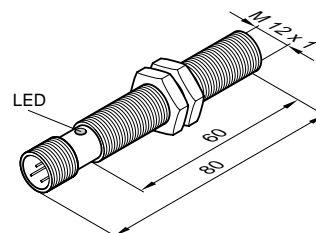

Metric/in. Conversion Table

1.0 mm = .04 in.	60.0 mm = 2.36 in.
6.0 mm = .23 in.	64.0 mm = 2.52 in.
8.0 mm = .31 in.	70.0 mm = 2.75 in.
12.0 mm = .47 in.	80.0 mm = 3.15 in.
54.0 mm = 2.12 in.	

This table converts millimeters to inches in reference to the illustrations included on these pages

Accessories

2 meter (6 ft. 6 in.) AC Cable Assemblies for Quick Disconnect Sensors

- 68 Connector 8000-5130 PVC Straight
- 68 Connector 8000-5140 Right Angle

Change last digit of connector number to 5 for 5 meter cable

Refer to pages 116-121 for more cable information

Mounting Brackets – see Pages 114-115

M18 Flush Mount

5mm (0.2 in.)

Cable	Cable	68
9921-1200	9921-2000	9921-1268
9921-1300	9921-2100	9921-1368
20V - 250V	20V - 250V	20V - 250V
50/60Hz	50/60Hz	50/60Hz
2 mA	2 mA	2 mA
500 mA	500 mA	500 mA
≤5V	≤5V	≤5V
≤2mA	≤2mA	≤2mA
8A	8A	8A
15Hz	15Hz	15Hz
≤15%	≤15%	≤15%
≤10%	≤10%	≤10%
.50mm (.02 in.)	.50mm (.02 in.)	.50mm (.02 in.)
PBTB	PBTB	PBTB
Nickel Plated Brass	Trogamid T	Nickel Plated Brass

M18 Non-Flush Mount

8mm (0.3 in.)

Cable	Cable	68
9921-1500	9921-2200	9921-1568
9921-1700	9921-2300	9921-1768
20V - 250V	20V - 250V	20V - 250V
50/60Hz	50/60Hz	50/60Hz
2 mA	2 mA	2 mA
500 mA	500 mA	500 mA
≤5V	≤5V	≤5V
≤2mA	≤2mA	≤2mA
8A	8A	8A
15Hz	15Hz	15Hz
≤15%	≤15%	≤15%
≤10%	≤10%	≤10%
.8mm (.039 in.)	.8mm (.039 in.)	.8mm (.039 in.)
PBTB	PBTB	PBTB
Nickel Plated Brass	Trogamid T	Nickel Plated Brass

Note: Sensor dimensions in mm.

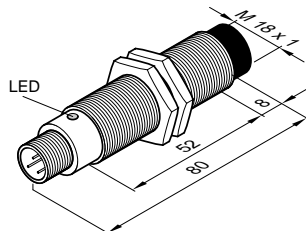
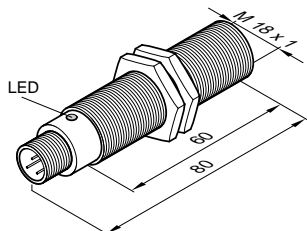
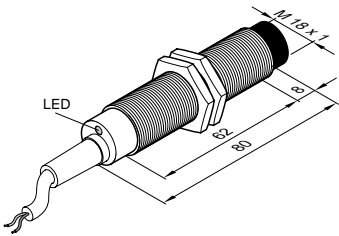
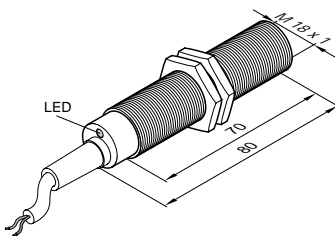
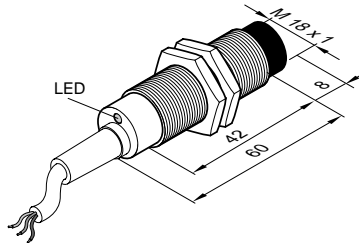
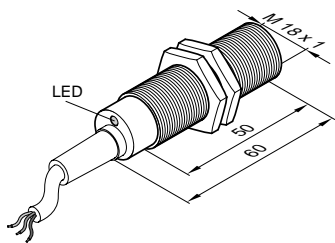

Wiring Diagrams

Note: Wire colors are applicable to cable purchased from Altech

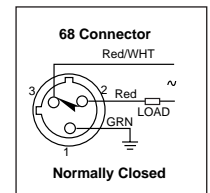
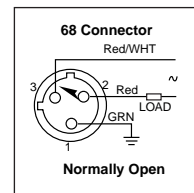
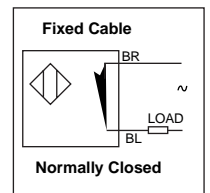
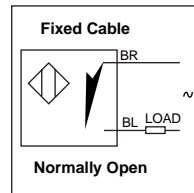
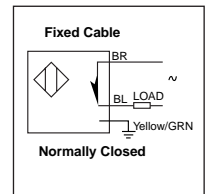
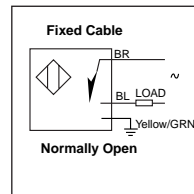



**AC - 2 WIRE - EXTENDED
VOLTAGE RANGE – Brass, Nickel
Plated (BN), and TROGAMID T
Cylindrical, Threaded,
20-250V AC, 500 mA,
1 LED for Output Energized**

- **Higher Current Rating**
- **Wider Voltage Range**
- **Carries ζ mark**

- IEC (529) IP67 (NEMA 1, 3, 4, 6, 12, 13) Protection
- Temperature Range: -25 to 70°C (-13 to 158°F)

**M30 Flush Mount
10mm (0.39 in.)**

Sensing Distance		10mm (0.39 in.)		
Cable or Connector Style Cat. No.	Cable	Cable	Cable	68
Normally Open 	9916-2600	9916-2900	9916-2668	9916-2668
Normally Closed 	9916-2100	9916-2400	9916-2168	9916-2168
Voltage Range	20V-250V	20V - 250V	20V - 250V	20V - 250V
Operating Frequency	50/60Hz	50/60Hz	50/60Hz	50/60Hz
Supply Current	2 mA	2 mA	2 mA	2 mA
Max. Load Current	500 mA	500 mA	500 mA	500 mA
Voltage Drop Across Sensor	≤5V	≤5V	≤5V	≤5V
Max. Leakage Current	≤2mA	≤2mA	≤2mA	≤2mA
Short Term Current (20 ms, 1Hz)	8A	8A	8A	8A
Switching Frequency	15Hz	15Hz	15Hz	15Hz
Hysteresis	≤15%	≤15%	≤15%	≤15%
Temperature Drift	≤10%	≤10%	≤10%	≤10%
Repeatability	1mm (.039 in.)	1mm (.039 in.)	1mm (.039 in.)	1mm (.039 in.)
Front Cap Material	PBTP	PBTP	PBTP	PBTP
Housing Material	Nickel Plated Brass	Trogamid T	Nickel Plated Brass	Nickel Plated Brass

Nickel Plated Brass Housings

Fixed Cable

PVC 2m (6ft. 6in.). For 5m (16 ft. 5 in.) cable length, change the last two digits of the part number to 02. For other cable lengths and/or PUR cable, please consult Altech. Supplied with non-metallic locknuts for Trogamid T housings and Brass, Nickel Plated (BN) locknuts for Nickel Plated Brass housings.

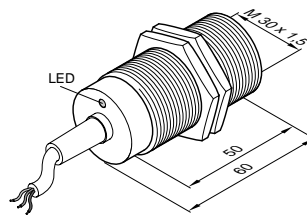

Trogamid T Housings

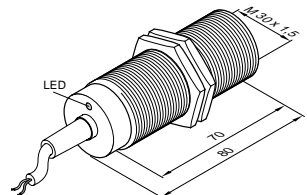

68 Style Connectors

3-pin, Micro style, 12mm (.47 in.) supplied with Brass, Nickel Plated (BN) locknuts.

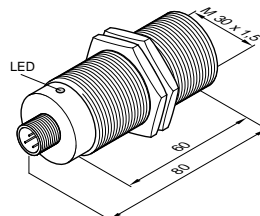

Metric/in. Conversion Table

1.5 mm = .06 in.	50.0 mm = 1.96 in.
12.0 mm = .47 in.	58.0 mm = 2.28 in.
30.0 mm = 1.18 in.	60.0 mm = 2.36 in.
38.0 mm = 1.50 in.	80.0 mm = 3.15 in.
48.0 mm = 1.89 in.	

This table converts millimeters to inches in reference to the illustrations included on these pages

Accessories

2 meter (6 ft. 6 in.) AC Cable Assemblies for Quick Disconnect Sensors

- 68 Connector 8000-5130 PVC Straight
- 68 Connector 8000-5140 Right Angle

Change last digit of connector number to 5 for 5 meter cable

Refer to pages 116-121 for more cable information

M30 Non-Flush Mount 15mm (0.59 in.)

Cable	Cable	68
9916-2700	9916-3000	9916-2768
9916-2300	9916-2500	9916-2368
20V - 250V	20V - 250V	20V - 250V
50/60Hz	50/60Hz	50/60Hz
2 mA	2 mA	2 mA
500 mA	500 mA	500 mA
≤5V	≤5V	≤5V
≤2mA	≤2mA	≤2mA
8A	8A	8A
15Hz	15Hz	15Hz
≤15%	≤15%	≤15%
≤10%	≤10%	≤10%
1.5mm (.059 in.)	1.5mm (.059 in.)	1.5mm (.059 in.)
PBTB	PBTB	PBTB
Nickel Plated Brass	Trogamid T	Nickel Plated Brass

Note: Sensor dimensions in mm.

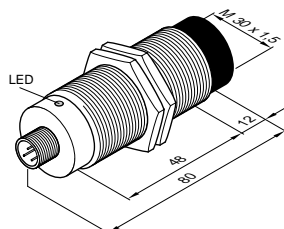
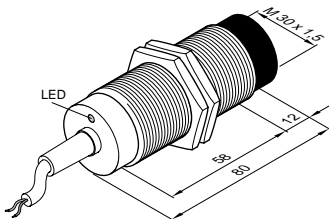
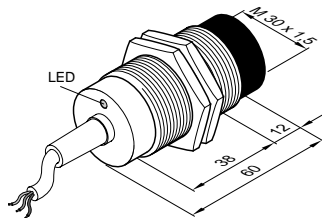

Wiring Diagrams

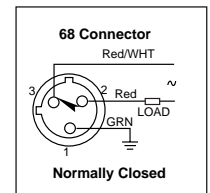
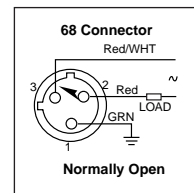
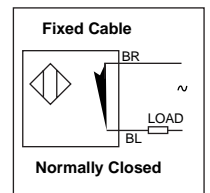
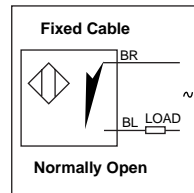
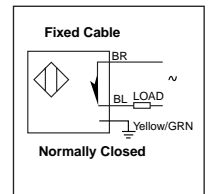
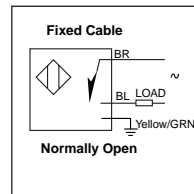

Note: Wire colors are applicable to cable purchased from Altech



AC - 2 WIRE – WELD IMMUNE
Brass, Nickel Plated (BN),
Cylindrical, Threaded,
20-250V AC, 300mA/500mA
1 LED for Output Energized

- **Circuitry that protects for electro-magnetic interference**
- **Flush models have teflon ceramic coatings to protect for weld slag**
- **Carries (C) mark**

- IEC(529) IP67 (NEMA 1, 3, 4, 6, 12, 13) Protection
- Temperature Range: -25 to 70°C (-13 to 158°F)

Sensing Distance	M12 Flush Mount 2mm (.08 in.)		M12 Non-Flush Mount 4mm (.16 in.)		
	Cable or Connector Style Cat. No.	Cable	48	Cable	68
Normally Open 		9952-5840	9952-5848	9952-5900	9952-5968
Normally Closed 		9952-5640	9952-5648	9952-5700	9952-5768
Voltage Range		20V-250V	20V - 250V	20V - 250V	20V - 250V
Operating Frequency		50/60Hz	50/60Hz	50/60Hz	50/60Hz
Supply Current		2 mA	2 mA	2 mA	2 mA
Max. Load Current		300 mA	300 mA	300 mA	300 mA
Voltage Drop Across Sensor		≤5V	≤5V	≤5V	≤5V
Max. Leakage Current		≤2 mA	≤2 mA	≤2 mA	≤2 mA
Short Term Current (20 ms, 1Hz)		2A	2A	2A	2A
Switching Frequency (at Resistance Load of 150 mA)		15 Hz	15 Hz	15Hz	15 Hz
Hysteresis		≤15%	≤15%	≤15%	≤15%
Temperature Drift		≤10%	≤10%	≤10%	≤10%
Repeatability		.10mm (.004 in.)	.10mm (.004 in.)	.2mm (.008 in.)	.2mm (.008 in.)
Front Cap Material		Teflon	Teflon	PBTB	PBTB
Housing Material		Teflon Plated Brass	Teflon Plated Brass	Nickel Plated Brass	Nickel Plated Brass

Fixed Cable

PVC 2m (6ft. 6in.). For 5m (16 ft. 5 in.) cable length, change the last two digits of the part number to 02. For other cable lengths and/or PUR cable, please consult Altech. Supplied with Brass, Nickel Plated (BN) locknuts.

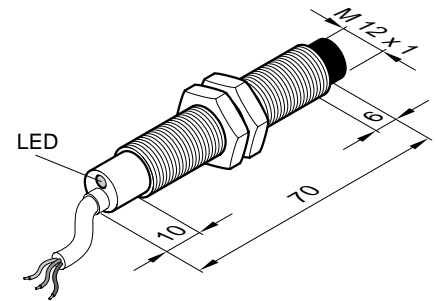
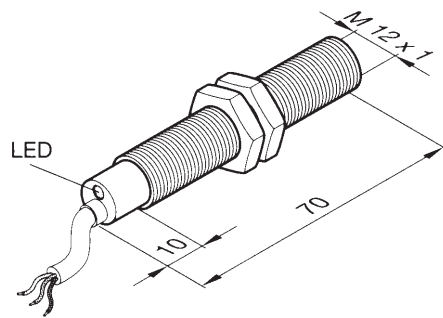

48/68 Style Connector

3-pin, Micro style, 12mm (.47 in.) supplied with Brass, Nickel Plated (BN) locknuts.

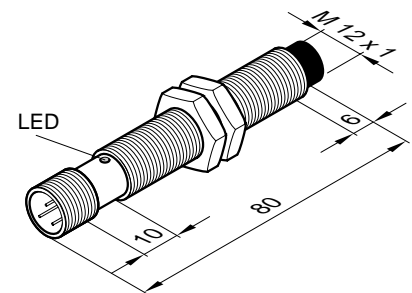
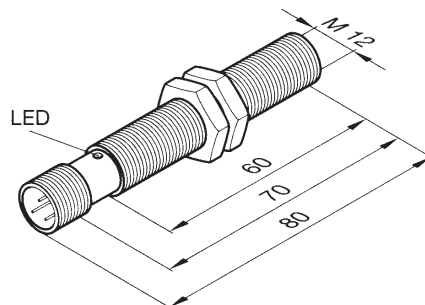

Metric/in. Conversion Table

1.0 mm	=	.04 in.
6.0 mm	=	.23 in.
8.0 mm	=	.31 in.
10.0 mm	=	.39 in.
12.0 mm	=	.47 in.
18.0 mm	=	.70 in.
60.0 mm	=	2.36 in.
70.0 mm	=	2.75 in.
80.0 mm	=	3.15 in.

This table converts millimeters to inches in reference to the illustrations included on these pages

Accessories

2 meter (6 ft. 6 in.) AC Cable Assemblies for Quick Disconnect Sensors

48/68 Connector 8000-5130 PVC, Straight
48/68 Connector 8000-5140 Right Angle

Change last digit of connector number to 5 for 5 meter cable

Refer to pages 116-121 for more cable information

Mounting Brackets – see Pages 114-115

M18 Flush Mount

5mm (.20 in.)

M18 Non-Flush Mount

8mm (.31 in.)

M18 Flush Mount 5mm (.20 in.)		M18 Non-Flush Mount 8mm (.31 in.)	
Cable	48	Cable	68
9954-5840	9954-5848	9954-5900	9954-5968
9954-5640	9954-5648	9954-5700	9954-5768
20V - 250V	20V - 250V	20V - 250V	20V - 250V
50/60Hz	50/60Hz	50/60Hz	50/60Hz
2 mA	2 mA	2 mA	2 mA
500 mA	500 mA	500 mA	500 mA
≤5V	≤5V	≤5V	≤5V
≤2 mA	≤2 mA	≤2 mA	≤2 mA
8A	8A	8A	8A
15 Hz	15 Hz	15 Hz	15 Hz
≤15%	≤15%	≤15%	≤15%
≤10%	≤10%	≤10%	≤10%
.25mm (.01 in.)	.25mm (.01 in.)	.4mm (.016 in.)	.4mm (.016 in.)
Teflon	Teflon	PBTB	PBTB
Teflon Plated Brass	Teflon Plated Brass	Nickel Plated Brass	Nickel Plated Brass

Note: Sensor dimensions in mm.

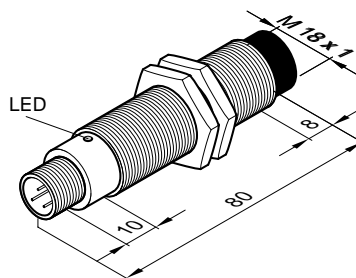
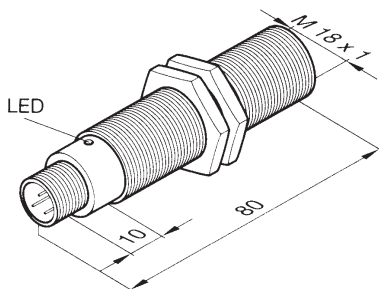
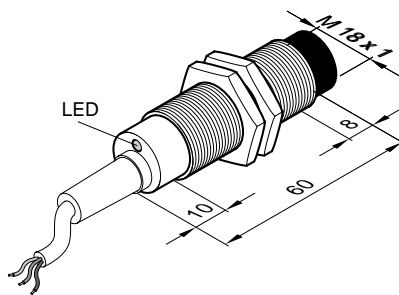
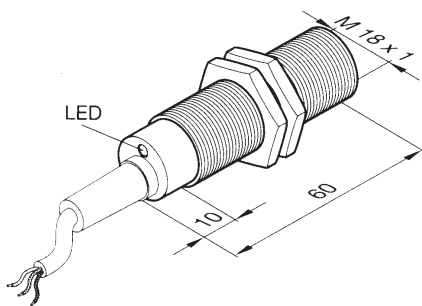

Wiring Diagrams

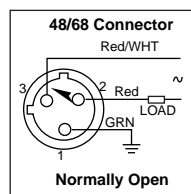
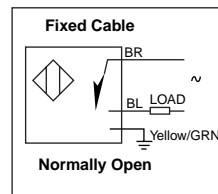

Note: Wire colors are applicable to cable purchased from Altech



AC - 2 WIRE – WELD IMMUNE
Brass, Nickel Plated (BN),
Cylindrical, Threaded,
20-250V AC, 300/500mA
1 LED for Output Energized

- **Circuitry that protects for electro-magnetic interference**
- **Flush models have teflon ceramic coatings to protect for weld slag**
- **Carries CE mark**

- IEC(529) IP67 (NEMA 1, 3, 4, 6, 12, 13) Protection
- Temperature Range: -25 to 70°C (-13 to 158°F)

Sensing Distance	M30 Flush Mount		M30 Non-Flush Mount	
	10mm (.39 in.)		15mm (.59 in.)	
Cable or Connector Style Cat. No.	Cable	48	Cable	68
Normally Open 	9956-5840	9956-5848	9956-5900	9956-5968
Normally Closed 	9956-5640	9956-5648	9956-5700	9956-5768
Voltage Range	20V-250V	20V - 250V	20V - 250V	20V - 250V
Operating Frequency	50/60Hz	50/60Hz	50/60Hz	50/60Hz
Supply Current	2 mA	2 mA	2 mA	2 mA
Max. Load Current	500 mA	500 mA	500 mA	500 mA
Voltage Drop Across Sensor	≤5V	≤5V	≤5V	≤5V
Max. Leakage Current	≤2 mA	≤2 mA	≤2 mA	≤2 mA
Short Term Current (20 ms, 1Hz)	8A	8A	8A	8A
Switching Frequency (at Resistance Load of 150 mA)	15 Hz	15 Hz	15 Hz	15Hz
Hysteresis	≤15%	≤15%	≤15%	≤15%
Temperature Drift	≤10%	≤10%	≤10%	≤10%
Repeatability	.5mm (.02 in.)	.5mm (.02 in.)	.75mm (.03 in.)	.75mm (.03 in.)
Front Cap Material	Teflon	Teflon	PBTB	PBTB
Housing Material	Teflon Plated Brass	Teflon Plated Brass	Nickel Plated Brass	Nickel Plated Brass

Note: Sensor dimensions in mm.

Fixed Cable

PVC 2m (6ft. 6in.). For 5m (16 ft. 5 in.) cable length, change the last two digits of the part number to 02. For other cable lengths and/or PUR cable, please consult Altech. Supplied with Brass, Nickel Plated (BN) locknuts.

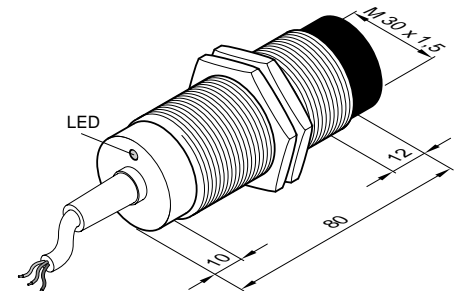
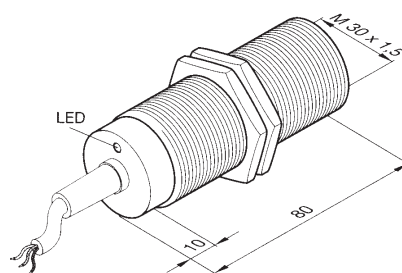

48/68 Style Connector

4-pin, Micro style, 12mm (.47 in.) supplied with Brass, Nickel Plated (BN) locknuts.

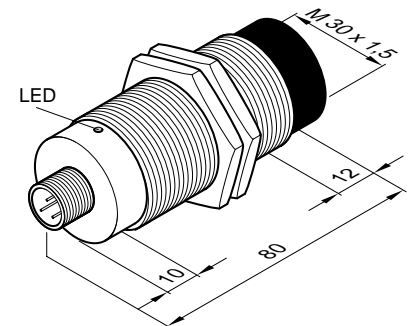
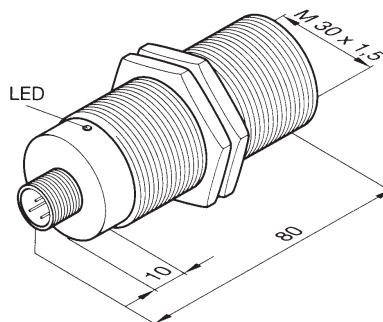

Metric/in. Conversion Table

1.5 mm	= .06 in.
10.0 mm	= .39 in.
12.0 mm	= .47 in.
30.0 mm	= 1.18 in.
80.0 mm	= 3.15 in.

This table converts millimeters to inches in reference to the illustrations included on these pages

Accessories

2 meter (6 ft. 6 in.) DC Cable Assemblies for Quick Disconnect Sensors

48/68 Connector 8000-5130 PVC, Straight

48/68 Connector 8000-5140 Right Angle

Change last digit of connector number to 5 for 5 meter cable

Refer to pages 116-121 for more cable information

Mounting Brackets – see Pages 114-115

Wiring Diagrams

Note: Wire colors are applicable to cable purchased from Altech

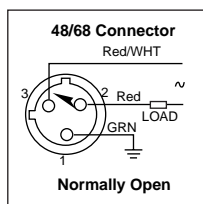
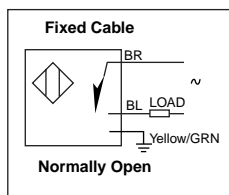

Данный компонент на территории Российской Федерации

Вы можете приобрести в компании MosChip.

Для оперативного оформления запроса Вам необходимо перейти по данной ссылке:

<http://moschip.ru/get-element>

Вы можете разместить у нас заказ для любого Вашего проекта, будь то серийное производство или разработка единичного прибора.

В нашем ассортименте представлены ведущие мировые производители активных и пассивных электронных компонентов.

Нашей специализацией является поставка электронной компонентной базы двойного назначения, продукции таких производителей как XILINX, Intel (ex.ALTERA), Vicor, Microchip, Texas Instruments, Analog Devices, Mini-Circuits, Amphenol, Glenair.

Сотрудничество с глобальными дистрибьюторами электронных компонентов, предоставляет возможность заказывать и получать с международных складов практически любой перечень компонентов в оптимальные для Вас сроки.

На всех этапах разработки и производства наши партнеры могут получить квалифицированную поддержку опытных инженеров.

Система менеджмента качества компании отвечает требованиям в соответствии с ГОСТ Р ИСО 9001, ГОСТ РВ 0015-002 и ЭС РД 009

Офис по работе с юридическими лицами:

105318, г.Москва, ул.Щербаковская д.3, офис 1107, 1118, ДЦ «Щербаковский»

Телефон: +7 495 668-12-70 (многоканальный)

Факс: +7 495 668-12-70 (доб.304)

E-mail: info@moschip.ru

Skype отдела продаж:

moschip.ru

moschip.ru_4

moschip.ru_6

moschip.ru_9