

Features

- Ultra-Small Surface Mount Package (1.0 x 0.8mm)
- Ultra-Low Profile Package (0.45mm)
- Ultra Low Leakage Current (5nA @ $V_R = 75V$)
- Low Capacitance
- Ideal for Battery Powered Portable Applications
- **Lead Free By Design/RoHS Compliant (Note 1)**
- **Halogen and Antimony Free "Green" Device (Notes 2 & 3)**

Mechanical Data

- Case: SOT963
- Case Material: Molded Plastic, "Green" Molding Compound. UL Flammability Classification Rating 94V-0
- Moisture Sensitivity: Level 1 per J-STD-020
- Terminal Connections: See Diagram
- Terminals: Finish – Matte Tin Annealed over Copper leadframe. Solderable per MIL-STD-202, Method 208
- Weight: 0.003 grams (Approximate)

SOT963



Top View

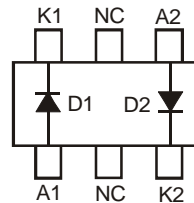

Internal Schematic

Ordering Information (Note 4)

Part Number	Case	Packaging
BAS116UDJ-7	SOT963	10,000/Tape & Reel

- Notes:
1. Fully EU Directive 2002/95/EC (RoHS) & 2011/65/EU (RoHS 2) compliant. No purposely added lead.
 2. Halogen and Antimony free "Green" products are defined as those which contain <900ppm bromine, <900ppm chlorine (<1500ppm total Br + Cl) and <1000ppm antimony compounds.
 3. Diodes Inc.'s "Green" policy can be found on our website at <http://www.diodes.com>.
 4. For packaging details, go to our website at <http://www.diodes.com>.

Marking Information

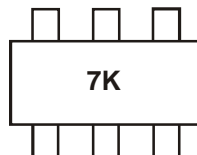

7K = Product Type Marking Code

Maximum Ratings @T_A = 25°C unless otherwise specified

Characteristic	Symbol	Value	Unit
Peak Repetitive Reverse Voltage	V _{RRM}	85	V
Working Peak Reverse Voltage	V _{RWM}		
DC Blocking Voltage	V _R		
RMS Reverse Voltage	V _{R(RMS)}	60	V
Forward Continuous Current (Note 5)	I _{FM}	215	mA
Repetitive Peak Forward Current	I _{FRM}	500	mA
Non-Repetitive Peak Forward Surge Current	I _{FSM}	@ t = 1.0μs	4.0
		@ t = 1.0ms	1.0
		@ t = 1.0s	0.5

Thermal Characteristics

Characteristic	Symbol	Value	Unit
Power Dissipation (Note 5)	P _D	250	mW
Thermal Resistance Junction to Ambient Air (Note 5)	R _{θJA}	500	°C/W
Operating and Storage Temperature Range	T _J , T _{STG}	-55 to +150	°C

Electrical Characteristics @T_A = 25°C unless otherwise specified

Characteristic	Symbol	Min	Typ	Max	Unit	Test Condition
Reverse Breakdown Voltage (Note 6)	V _{(BR)R}	85	—	—	V	I _R = 100μA
Forward Voltage	V _F	—	—	0.95 1.05 1.15 1.35	V	I _F = 1.0mA I _F = 10mA I _F = 50mA I _F = 150mA
Leakage Current (Note 6)	I _R	—	0.9 16	5.0 500	nA	V _R = 75V V _R = 75V, T _J = 150°C
Total Capacitance	C _T	—	2	—	pF	V _R = 0, f = 1.0MHz
Reverse Recovery Time	t _{rr}	—	0.12	3.0	μs	I _F = I _R = 10mA, I _{rr} = 0.1 x I _R , R _L = 100Ω

Notes: 5. Part mounted on FR-4 PC board with recommended pad layout, which can be found on our website at <http://www.diodes.com>.
6. Short duration pulse test used to minimize self-heating effect.

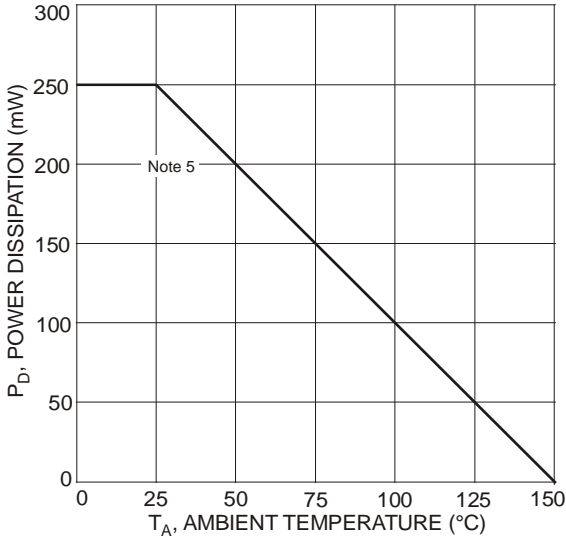

Fig. 1 Power Dissipation vs. Ambient Temperature

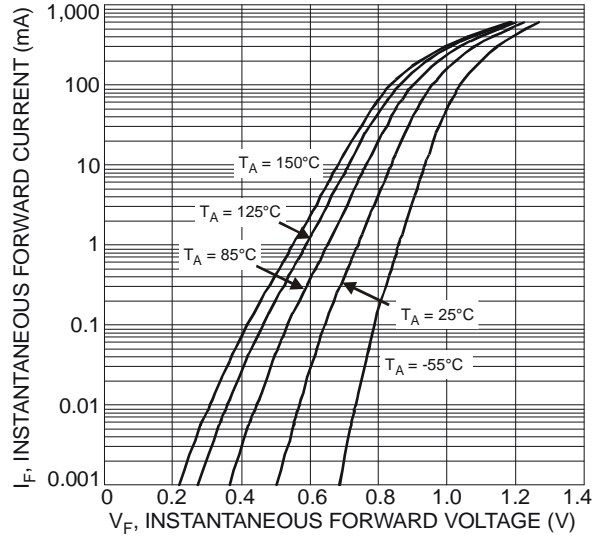

Fig. 2 Typical Forward Characteristics - Per Element

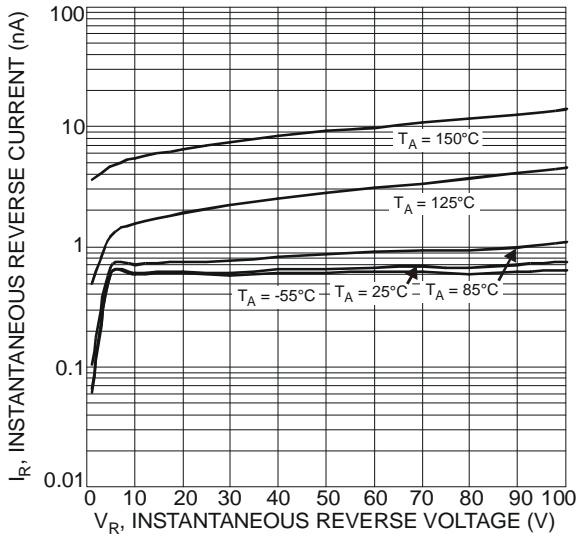

Fig. 3 Typical Reverse Characteristics - Per Element

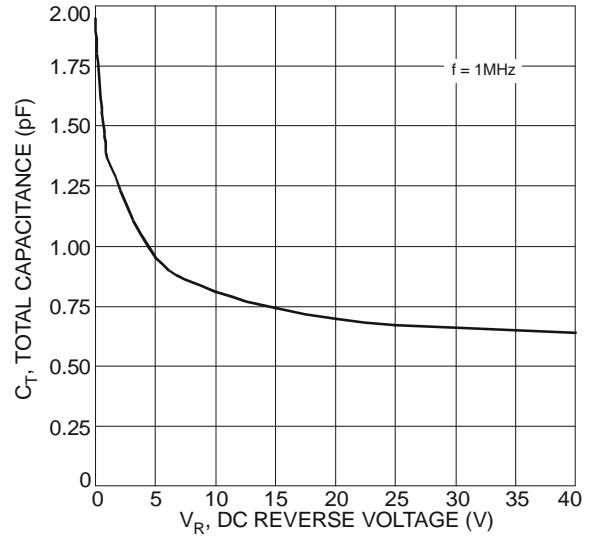
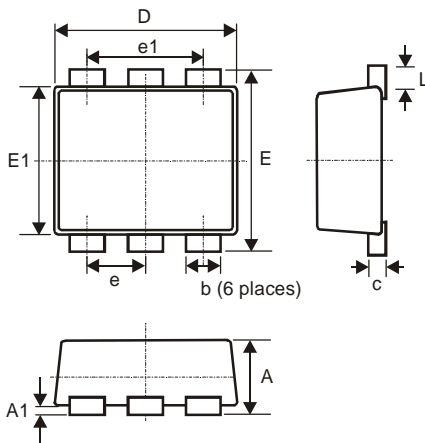

Fig. 4 Typical Total Capacitance vs. Reverse Voltage - Per Element

Package Outline Dimensions



SOT963			
Dim	Min	Max	Typ
A	0.40	0.50	0.45
A1	0	0.05	-
c	0.120	0.180	0.150
D	0.95	1.05	1.00
E	0.95	1.05	1.00
E1	0.75	0.85	0.80
L	0.05	0.15	0.10
b	0.10	0.20	0.15
e	0.35 Typ		
e1	0.70 Typ		
All Dimensions in mm			

Suggested Pad Layout

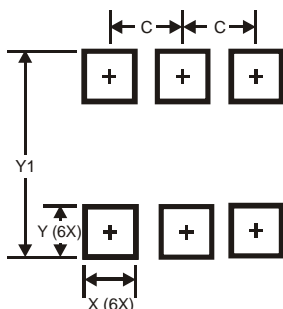

Dimensions	Value (in mm)
C	0.350
X	0.200
Y	0.200
Y1	1.100

IMPORTANT NOTICE

DIODES INCORPORATED MAKES NO WARRANTY OF ANY KIND, EXPRESS OR IMPLIED, WITH REGARDS TO THIS DOCUMENT, INCLUDING, BUT NOT LIMITED TO, THE IMPLIED WARRANTIES OF MERCHANTABILITY AND FITNESS FOR A PARTICULAR PURPOSE (AND THEIR EQUIVALENTS UNDER THE LAWS OF ANY JURISDICTION).

Diodes Incorporated and its subsidiaries reserve the right to make modifications, enhancements, improvements, corrections or other changes without further notice to this document and any product described herein. Diodes Incorporated does not assume any liability arising out of the application or use of this document or any product described herein; neither does Diodes Incorporated convey any license under its patent or trademark rights, nor the rights of others. Any Customer or user of this document or products described herein in such applications shall assume all risks of such use and will agree to hold Diodes Incorporated and all the companies whose products are represented on Diodes Incorporated website, harmless against all damages.

Diodes Incorporated does not warrant or accept any liability whatsoever in respect of any products purchased through unauthorized sales channel. Should Customers purchase or use Diodes Incorporated products for any unintended or unauthorized application, Customers shall indemnify and hold Diodes Incorporated and its representatives harmless against all claims, damages, expenses, and attorney fees arising out of, directly or indirectly, any claim of personal injury or death associated with such unintended or unauthorized application.

Products described herein may be covered by one or more United States, international or foreign patents pending. Product names and markings noted herein may also be covered by one or more United States, international or foreign trademarks.

LIFE SUPPORT

Diodes Incorporated products are specifically not authorized for use as critical components in life support devices or systems without the express written approval of the Chief Executive Officer of Diodes Incorporated. As used herein:

- A. Life support devices or systems are devices or systems which:
 - 1. are intended to implant into the body, or
 - 2. support or sustain life and whose failure to perform when properly used in accordance with instructions for use provided in the labeling can be reasonably expected to result in significant injury to the user.
- B. A critical component is any component in a life support device or system whose failure to perform can be reasonably expected to cause the failure of the life support device or to affect its safety or effectiveness.

Customers represent that they have all necessary expertise in the safety and regulatory ramifications of their life support devices or systems, and acknowledge and agree that they are solely responsible for all legal, regulatory and safety-related requirements concerning their products and any use of Diodes Incorporated products in such safety-critical, life support devices or systems, notwithstanding any devices- or systems-related information or support that may be provided by Diodes Incorporated. Further, Customers must fully indemnify Diodes Incorporated and its representatives against any damages arising out of the use of Diodes Incorporated products in such safety-critical, life support devices or systems.

Copyright © 2012, Diodes Incorporated

www.diodes.com

Данный компонент на территории Российской Федерации

Вы можете приобрести в компании MosChip.

Для оперативного оформления запроса Вам необходимо перейти по данной ссылке:

<http://moschip.ru/get-element>

Вы можете разместить у нас заказ для любого Вашего проекта, будь то серийное производство или разработка единичного прибора.

В нашем ассортименте представлены ведущие мировые производители активных и пассивных электронных компонентов.

Нашей специализацией является поставка электронной компонентной базы двойного назначения, продукции таких производителей как XILINX, Intel (ex.ALTERA), Vicor, Microchip, Texas Instruments, Analog Devices, Mini-Circuits, Amphenol, Glenair.

Сотрудничество с глобальными дистрибьюторами электронных компонентов, предоставляет возможность заказывать и получать с международных складов практически любой перечень компонентов в оптимальные для Вас сроки.

На всех этапах разработки и производства наши партнеры могут получить квалифицированную поддержку опытных инженеров.

Система менеджмента качества компании отвечает требованиям в соответствии с ГОСТ Р ИСО 9001, ГОСТ РВ 0015-002 и ЭС РД 009

Офис по работе с юридическими лицами:

105318, г.Москва, ул.Щербаковская д.3, офис 1107, 1118, ДЦ «Щербаковский»

Телефон: +7 495 668-12-70 (многоканальный)

Факс: +7 495 668-12-70 (доб.304)

E-mail: info@moschip.ru

Skype отдела продаж:

moschip.ru

moschip.ru_4

moschip.ru_6

moschip.ru_9