



MELCHER™
The Power Partners.

PSA/PSR Series Positive Switching Regulator



The PSA/PSR Series of positive switching regulators are designed as power supplies for electronic systems when no input-to-output isolation is required. Their major advantages include a high level of efficiency, high reliability, low output ripple, and excellent dynamic response. Models with input voltages up to 144 V are especially designed for secondary-switched and battery-driven mobile applications. The regulators are suitable for railway applications according to EN 50155 and EN 50121.

The case design allows for operation up to 71 °C. The PSA/PSR Series are designed for wall or chassis mounting with faston connections or with solder pins for insertion into a PCB.

Various options are available to adapt the regulators to different applications.

Features

- RoHS lead-free-solder and lead-solder-exempted products are available
- 5 year warranty for RoHS compliant products with an extended temperature range
- Input voltage up to 144 VDC
- Single output of 5 to 48 VDC
- No input-to-output isolation
- High efficiency up to 95%
- Extremely wide input voltage range
- Low input-to-output differential voltage
- Very good dynamic properties
- Input undervoltage lockout
- Output voltage adjustment and inhibit function
- Continuously no-load and short-circuit proof
- All boards are coated with a protective lacquer
- Boards or chassis mountable

Safety-approved to the latest edition of IEC/EN 60950-1 and UL/CSA 60950-1



Table of Contents

Description.....	1
Model Selection.....	2
Functional Description.....	3
Electrical Input Data.....	4
Electrical Output Data.....	6
Auxiliary Functions.....	10

Electromagnetic Compatibility (EMC).....	11
Immunity to Environmental Conditions.....	12
Mechanical Data.....	13
Safety and Installation Instructions.....	14
Description of Options.....	15
Accessories.....	16

Customer-Specific Models

Positive switching regulator in case A01	PSA
Nominal output voltage in Volt (without decimals).....	12
Decimal places:	
0.0 V.....	Z
0.1 V.....	A
0.15 V.....	B
0.2 V.....	C
0.25 V.....	D
0.3 V.....	E
0.4 V.....	F
0.5 V.....	G
0.6 V.....	H
0.7 V.....	J
0.8 V.....	K
0.9 V.....	L
other.....	Y
Output current in Amperes	3
Identification character	A, B, ...
Temperature range and options	-9iRG



Product Marking

Type designation, applicable safety approval marks, warnings, pin allocation, patent nos., and company logo.

Input voltage range, nominal output voltage and current, pin allocation of auxiliary functions and options, and protection degree. Identification of LED and the optional potentiometer.

Label with input voltage range, nominal output voltage and current, protection degree, batch no., serial no., and data code including production site, version (modification status), date of production.

Functional Description

The switching regulators use the buck converter topology. The input is not electrically isolated from the output. During the on period of the switching transistor, current is transferred to the output, and energy is stored in the output choke. During the off period, this energy forces the current to continue flowing through the output, to the load, and back through the freewheeling diode. Regulation is accomplished by varying the duty cycle (on/off ratio) of the main switch. The regulator starts operating only when the input voltage exceeds the trigger level of the UVL (undervoltage lockout).

These regulators are ideal for a wide range of applications, where input to output isolation is not necessary or is already provided by an external front end (e.g., a transformer with rectifier). To optimize customers' needs, additional options and accessories are available.



Fig. 1
Block diagram. The resistance of the input circuit

Electrical Input Data

General Conditions: $T_A = 25\text{ }^\circ\text{C}$, unless T_C is specified

Table 2a: Input data (-2 models)

Model		Conditions	PSA55			PSA5A5			PSR54			PSA5A2			Unit
Characteristics			min	typ	max	min	typ	max	min	typ	max	min	typ	max	
V_i	Operating input voltage	$I_o = 0 - I_{o,nom}$ $T_{C,min} - T_{C,max}$	7		35	7		35	7		40	7		40	V
$\Delta V_{io,min}$	Min. diff. voltage $V_i - V_o$				2			1.9			2			2.9	
$V_{i,UVL}$	Undervoltage lockout		6.3		6.6	6.3		6.4	6.3		6.5	7.3		7.6	
I_o	No-load input current	$I_o = 0, V_{i,min} - V_{i,max}$			45			50			45			50	mA
$I_{in,p}$	Inrush peak current	$V_{i,nom}$			75			75			75			75	A
R_i	Input resistance				10			10			10			10	mΩ
C_i	Input capacitance				6.8			6.8			6.8			6.8	μF
$V_{i,RFI}$	EN 55011, 0.15 - 30 MHz	$V_{i,nom}, I_{o,nom}$			A ¹			---			A ¹			---	Class

Table 2b: Input data

Model		Conditions	PSA123			PSA153			PSA242.5			Unit
Characteristics			min	typ	max	min	typ	max	min	typ	max	
V_i	Operating input voltage	$I_o = 0 - I_{o,nom}$ $T_{C,min} - T_{C,max}$	15		40	19		40	29		60	V
$\Delta V_{io,min}$	Min. diff. voltage $V_i - V_o$				3			4			5	
$V_{i,UVL}$	Undervoltage lockout		7.3		8.0	7.3		9.0	12		13.7	
I_o	No-load input current	$I_o = 0, V_{i,min} - V_{i,max}$			50			50			50	mA
$I_{in,p}$	Inrush peak current	$V_{i,nom}$			75			150			150	A
R_i	Input resistance				10			10			10	mΩ
C_i	Input capacitance				6.8			6.8			6.8	μF
$V_{i,RFI}$	EN 55011, 0.15 - 30 MHz	$V_{i,nom}, I_{o,nom}$			---			---			---	Class

Table 2c: Input data

Model		Conditions	PSR52			PSR53			PSR122.5			Unit
Characteristics			min	typ	max	min	typ	max	min	typ	max	
V_i	Operating input voltage	$I_o = 0 - I_{o,nom}$ $T_{C,min} - T_{C,max}$	8		80	8		80	15		80	V
$\Delta V_{io,min}$	Min. diff. voltage $V_i - V_o$				3			3			3	
$V_{i,UVL}$	Undervoltage lockout		7.3		7.6	7.3		7.6	7.3		8	
I_o	No-load input current	$I_o = 0, V_{i,min} - V_{i,max}$			40			40			35	mA
$I_{in,p}$	Inrush peak current	$V_{i,nom}$			150			150			150	A
R_i	Input resistance				10			10			10	mΩ
C_i	Input capacitance				6.8			6.8			6.8	μF
$V_{i,RFI}$	EN 55011, 0.15 - 30 MHz	$V_{i,nom}, I_{o,nom}$			A ²			A ²			A ²	Class

¹ With $C_o = 470\text{ }\mu\text{F} / 40\text{ V}$ and input filter FP38; see *Accessories*.

² With $C_o = 470\text{ }\mu\text{F} / 100\text{ V}$ and input filter FP80; see *Accessories*.

Table 2d: Input data. General Conditions as per Table 2a

Model			PSR152.5			PSR242			PSR362			PSA121.5			Unit	
Characteristics		Conditions	min	typ	max	min	typ	max	min	typ	max	min	typ	max		
V_i	Operating input voltage	$I_o = 0 - I_{o,nom}^1$ $T_{C,min} - T_{C,max}$	19		80	29		80	42		80	18		144 ¹	V	
$\Delta V_{io,min}$	Min. diff. voltage $V_i - V_o$				3			4				5				6
$V_{i,UVL}$	Undervoltage lockout			7.3	9.0		12	13.7		19	20.5		12	12.5		
I_{i0}	No-load input current	$I_o = 0, V_{i,min} - V_{i,max}$			35			35			40			20	mA	
I_{inrp}	Inrush peak current	$V_{i,nom}$		150			150			150			150		A	
R_i	Input resistance			10			10			10			10		mΩ	
C_i	Input capacitance			6.8			6.8			6.8			2.2		μF	
$V_{i,RFI}$	EN 55011, 0.15 - 30 MHz	$V_{i,nom}, I_{o,nom}$		A ²			A ²			A ²			A ³		Class	

Table 2e: Input data. General Conditions as per table 2a

Model			PSA151.5			PSA241.5			PSA361			PSA481			Unit
Characteristics		Conditions	min	typ	max	min	typ	max	min	typ	max	min	typ	max	
V_i	Operating input voltage	$I_o = 0 - I_{o,nom}^1$ $T_{C,min} - T_{C,max}$	22		144 ¹	31		144 ¹	44		144 ¹	58		144 ¹	V
$\Delta V_{io,min}$	Min. diff. voltage $V_i - V_o$				7			7			8			10	
$V_{i,UVL}$	Undervoltage lockout			18	18.5		22	23		31	32		44	45	
I_{i0}	No-load input current	$I_o = 0, V_{i,min} - V_{i,max}$			20			20			25			25	mA
I_{inrp}	Inrush peak current	$V_{i,nom}$		150			150			150			150		A
R_i	Input resistance			10			10			10			10		mΩ
C_i	Input capacitance			2.2			2.2			2.2			2.2		μF
$V_{i,RFI}$	EN 55011, 0.15 - 30 MHz	$V_{i,nom}, I_{o,nom}$		A ³			A ³			A ³			A ³		Class

¹ Surges up to 156 V for 2 s

² With $C_e = 470 \mu F / 100 V$ and input filter FP80; see *Accessories*

³ With $C_e = 2 \times 3.3 \mu F / 250 V$ MKT and input filter FP144; see *Accessories*

External Input Circuitry

The sum of the lengths of the supply lines to the source or to the nearest capacitor $\geq 100 \mu F$ (a + b) should not exceed 5 m. External input filter is recommended in order to prevent power line oscillations and reduce superimposed interference voltages.

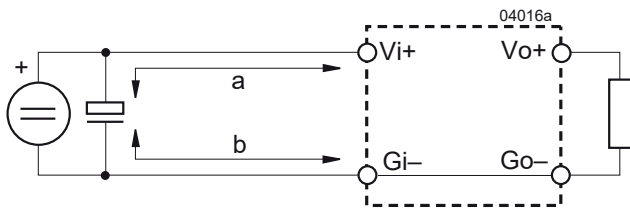

Fig. 2
Switching regulator with long supply lines.

Electrical Output Data

General conditions:

– $T_A = 25\text{ °C}$, unless T_C is specified

– R-input open (or V_o set to $V_{o\text{ nom}}$ with option P)

Table 3a: Output data

Output			PSA55			PSA5A5			PSR54			PSA5A2			Unit			
Characteristics			Conditions			min	typ	max	min	typ	max	min	typ	max				
V_o	Output voltage ¹		$V_{i\text{ nom}}, I_{o\text{ nom}}$			4.97		5.03	5.05		5.15	4.97		5.03	5.05		5.15	V
I_o	Output current		$V_{i\text{ min}} - V_{i\text{ max}}$			0		5.0	0		5.0	0		4.0	0		2.0	A
I_{oL}	Output current limitation		$T_{C\text{ min}} - T_{C\text{ max}}$			5.0		6.5	5.0		6.5	4.0		5.2	2.0		2.6	
V_o	Output voltage noise	Switching frequency	$V_{i\text{ nom}}, I_{o\text{ nom}}$ IEC/EN 61204				20	50		70		15	40			40	mV _{pp}	
		Total	BW = 20 MHz				24	70		100		19	60			60		
ΔV_{oV}	Static line regulation		$V_{i\text{ min}} - V_{i\text{ max}}, I_{o\text{ nom}}$			30		40		40		30	40			40	mV	
ΔV_{oI}	Static load regulation		$V_{i\text{ nom}}, I_o = 0 - I_{o\text{ nom}}$			20		25		25		10	45			20		
V_{oD}	Dynamic load regulation	Voltage deviation	$V_{i\text{ nom}}$ $I_{o\text{ nom}} \leftrightarrow 1/3 I_{o\text{ nom}}$				250			300		200				300	μs	
t_d		Recovery time	IEC/EN 61204				40			100		40				100		
α_{V_o}	Temperature coefficient $\Delta V_o / \Delta T_C (T_{C\text{ min}} - T_{C\text{ max}})$		$V_{i\text{ min}} - V_{i\text{ max}}$ $I_o = 0 - I_{o\text{ nom}}$					±0.02			±0.02			±0.02			±0.02	%/K

Table 3b: Output data

Output			PSA123			PSA153			PSA242.5			Unit			
Characteristics			Conditions			min	typ	max	min	typ	max		min	typ	max
V_o	Output voltage ¹		$V_{i\text{ nom}}, I_{o\text{ nom}}$			11.9		12.1	14.9		15.1	23.8		24.2	V
I_o	Output current		$V_{i\text{ min}} - V_{i\text{ max}}$			0		3.0	0		3.0	0		2.5	A
I_{oL}	Output current limitation		$T_{C\text{ min}} - T_{C\text{ max}}$			3.0		3.9	3.0		3.9	2.5		3.25	
V_o	Output voltage noise	Switching frequency	$V_{i\text{ nom}}, I_{o\text{ nom}}$ IEC/EN 61204					90			110			150	mV _{pp}
		Total	BW = 20 MHz					110			150			170	
ΔV_{oV}	Static line regulation		$V_{i\text{ min}} - V_{i\text{ max}}, I_{o\text{ nom}}$					70			85			180	mV
ΔV_{oI}	Static load regulation		$V_{i\text{ nom}}, I_o = 0 - I_{o\text{ nom}}$					40			60			140	
V_{oD}	Dynamic load regulation	Voltage deviation	$V_{i\text{ nom}}$ $I_{o\text{ nom}} \leftrightarrow 1/3 I_{o\text{ nom}}$				360			450				720	μs
t_d		Recovery time	IEC/EN 61204				120			120				160	
α_{V_o}	Temperature coefficient $\Delta V_o / \Delta T_C (T_{C\text{ min}} - T_{C\text{ max}})$		$V_{i\text{ min}} - V_{i\text{ max}}$ $I_o = 0 - I_{o\text{ nom}}$					±0.02			±0.02			±0.02	%/K

¹ Models with option R, but without option Y, are adjusted to 108% of $V_{o\text{ nom}}$. Models with option P are preadjusted to 108% of $V_{o\text{ nom}}$.

Table 3c: Output data. General conditions as per table 3a

Output			PSR52			PSR53			PSR122.5			Unit			
Characteristics		Conditions	min	typ	max	min	typ	max	min	typ	max				
V_o	Output voltage ¹		$V_{i\text{nom}}, I_{o\text{nom}}$			4.97		5.03	4.97		5.03	11.9		12.1	V
I_o	Output current		$V_{i\text{min}} - V_{i\text{max}}$			0		2.0	0		3.0	0		2.5	A
I_{oL}	Output current limitation		$T_{C\text{min}} - T_{C\text{max}}$			2.0		2.6	3.0		3.9	2.5		3.25	
V_o	Output voltage noise	Switching frequency	$V_{i\text{nom}}, I_{o\text{nom}}$ IEC/EN 61204			20		40	20		60	30		70	mV _{pp}
		Total	BW = 20 MHz			24		60	24		80	35		90	
ΔV_{oV}	Static line regulation		$V_{i\text{min}} - V_{i\text{max}}, I_{o\text{nom}}$			30		40	30		45	30		45	mV
ΔV_{oI}	Static load regulation		$V_{i\text{nom}}, I_o = 0 - I_{o\text{nom}}$			20		25	20		25			40	
V_{od}	Dynamic load regulation	Voltage deviation	$V_{i\text{nom}}$ $I_{o\text{nom}} \leftrightarrow 1/3 I_{o\text{nom}}$			100			100			180			
t_d		Recovery time	IEC/EN 61204			50			50			60		μs	
α_{Vo}	Temperature coefficient $\Delta V_o / \Delta T_C (T_{C\text{min}} - T_{C\text{max}})$		$V_{i\text{min}} - V_{i\text{max}}$ $I_o = 0 - I_{o\text{nom}}$			± 0.02			± 0.02			± 0.02		%/K	

Table 3d: Output data. General conditions as per table 3a

Output			PSR152.5			PSR242			PSR362			PSA121.5			Unit			
Characteristics		Conditions	min	typ	max	min	typ	max	min	typ	max	min	typ	max				
V_o	Output voltage ¹		$V_{i\text{nom}}, I_{o\text{nom}}$			14.91		15.09	23.86		24.14	35.78		36.22	11.93		12.07	V
I_o	Output current		$V_{i\text{min}} - V_{i\text{max}}$			0		2.5	0		2.0	0		2.0	0		1.5	A
I_{oL}	Output current limitation		$T_{C\text{min}} - T_{C\text{max}}$			2.5		3.25	2.0		2.6	2.0		2.6	1.5		1.9	
V_o	Output voltage noise	Switching frequency	$V_{i\text{nom}}, I_{o\text{nom}}$ IEC/EN 61204			40		110	30		150	80		200	20		40	mV _{pp}
		Total	BW = 20 MHz			50		150	40		170	85		220	24		50	
ΔV_{oV}	Static line regulation		$V_{i\text{min}} - V_{i\text{max}}, I_{o\text{nom}}$			70		85	60		220	200		250	20		80	mV
ΔV_{oI}	Static load regulation		$V_{i\text{nom}}, I_o = 0 - I_{o\text{nom}}$			40		50	90		160	125		160	20		30	
V_{od}	Dynamic load regulation	Voltage deviation	$V_{i\text{nom}}$ $I_{o\text{nom}} \leftrightarrow 1/3 I_{o\text{nom}}$			180			210			250		50				
t_d		Recovery time	IEC/EN 61204			60			80			100		50		μs		
α_{Vo}	Temperature coefficient $\Delta V_o / \Delta T_C (T_{C\text{min}} - T_{C\text{max}})$		$V_{i\text{min}} - V_{i\text{max}}$ $I_o = 0 - I_{o\text{nom}}$			± 0.02			± 0.02			± 0.02			± 0.02		%/K	

Table 3e: Output data. General conditions as per table 3a

Output			PSA151.5			PSA241.5			PSA361			PSA481			Unit	
Characteristics		Conditions	min	typ	max	min	typ	max	min	typ	max	min	typ	max		
V_o	Output voltage ¹	$V_{i\text{nom}}, I_{o\text{nom}}$	14.91	15.09		23.86	24.14		35.78	36.22		47.71	48.29	V		
I_o	Output current	$V_{i\text{min}} - V_{i\text{max}}$	0	1.5		0	1.5		0	1.2		0	1.0	A		
I_{oL}	Output current limitation	$T_{C\text{min}} - T_{C\text{max}}$	1.5	1.9		1.5	1.9		1.2	1.5		1.0	1.3			
V_o	Output voltage noise	Switching frequency	$V_{i\text{nom}}, I_{o\text{nom}}$			25	50		45	75		45	80	50	75	mV _{pp}
		Total	IEC/EN 61204			29	60		50	120		50	120	55	120	
ΔV_{oV}	Static line regulation	$V_{i\text{min}} - V_{i\text{max}}, I_{o\text{nom}}$	40	40		40	80		80	120		90	120	mV		
ΔV_{oI}	Static load regulation	$V_{i\text{nom}}, I_o = 0 - I_{o\text{nom}}$	20	50		30	40		40	80		60	100			
V_{od}	Dynamic load regulation	Voltage deviation	$V_{i\text{nom}}$			50			50			200		300		
t_d		Recovery time	$I_{o\text{nom}} \leftrightarrow \frac{1}{3} I_{o\text{nom}}$			50			60			40		100		μs
α_{Vo}	Temperature coefficient	$V_{i\text{min}} - V_{i\text{max}}$			± 0.02			± 0.02			± 0.02			± 0.02	%/K	
	$\Delta V_o / \Delta T_C (T_{C\text{min}} - T_{C\text{max}})$	$I_o = 0 - I_{o\text{nom}}$														

¹ Models with option R, but without option Y, are adjusted to 108% of $V_{o\text{nom}}$. Models with option P are preadjusted to 108% of $V_{o\text{nom}}$.

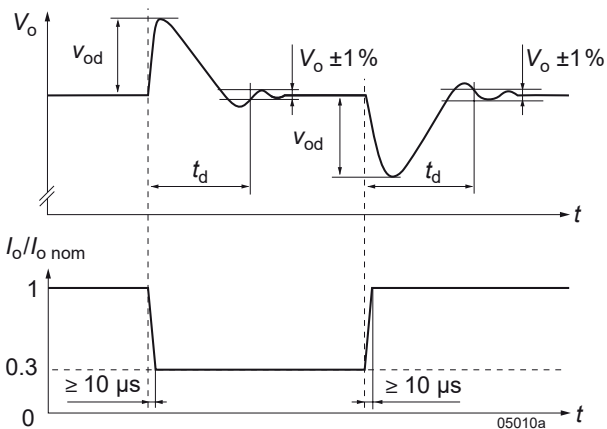

Fig. 3
Switching regulator with long supply lines.

Thermal Considerations

When a switching regulator is located in free, quasi-stationary air (convection cooling) at a temperature $T_A = 71\text{ }^\circ\text{C}$ and is operated at $I_{o,nom}$, the case temperature T_C will be about $95\text{ }^\circ\text{C}$ after the warm-up phase, measured at the measuring point of case temperature T_C ; see *Mechanical Data*.

Under practical operating conditions, T_A may exceed $71\text{ }^\circ\text{C}$, provided that additional measures (heat sink, fan etc.) are taken to ensure that T_C does not exceed $T_{C,max}$.

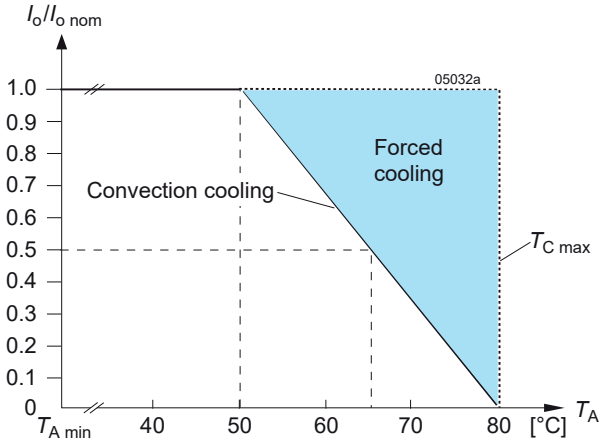

Fig. 4a
Output current versus temperature (models -2)



Fig. 4b
Output current versus temperature (models -7 and -9)

Output Protection and Short Circuit Behavior

A voltage suppressor diode, which in worst case conditions fails into a short circuit, protects the output against an internally generated overvoltage. Such an overvoltage could occur due to a failure of either the control circuit or the switching transistor. The output protection is not designed to withstand externally applied overvoltages.

A constant current limitation circuit holds the output current almost constant, when an overload or a short circuit is applied to the output. It acts self-protecting and recovers automatically after removal of the overload or short-circuit condition.

Parallel and Series Connection

Outputs of equal nominal voltages can be parallel-connected. However, the use of a single regulator with higher output power, is always the better solution.

In parallel-connected operation, one or several outputs may operate continuously at their current limit knee-point which will cause an increase of the heat generation. Consequently, the max. ambient temperature should be reduced by 10 K.

Outputs can be series-connected with any other regulator. In series-connection the maximum output current is limited by the lowest current limitation, but electrically separated source voltages are needed for each regulator.

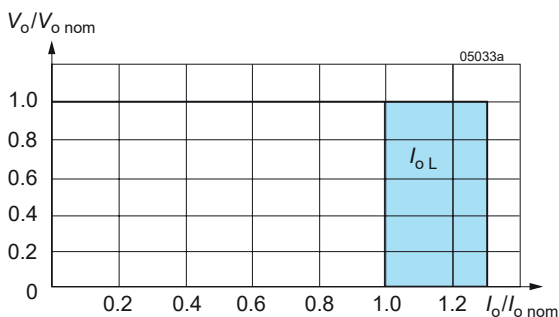

Fig. 5
Overload and short-circuit behavior V_o versus I_o

Auxiliary Functions

i Inhibit (Remote On / Off)

The inhibit input allows the switching regulator output to be disabled via a control signal. In systems with several converters, this feature can be used, for example, to control the activation sequence of the converters by a logic signal (TTL, C-MOS, etc.). No output voltage overshoot will occur at switch-on.

Note: With open i-pin, the output is enabled.

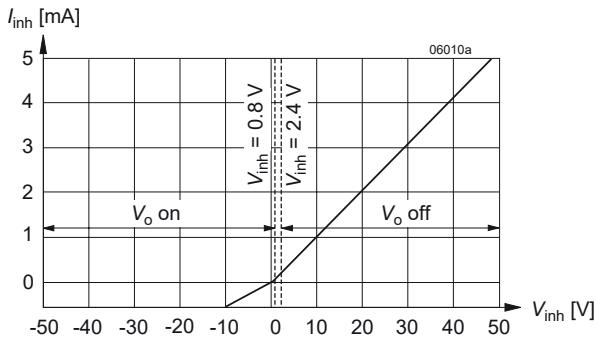

Fig. 6
Typical inhibit current I_{inh} versus inhibit voltage V_{inh}



Fig. 7
Definition of I_{inh} and V_{inh}

Table 4: Inhibit characteristics

Characteristics		Conditions	min	typ	max	Unit
V_{inh}	Inhibit input voltage	$V_o = \text{on}$	-10		+0.8	V
		$V_o = \text{off}$	+2.4		+50	
t_r	Switch-on time	$V_i = V_{i \text{ nom}}$		2		ms
t_f	Switch-off time	$R_L = V_{o \text{ nom}} / I_{o \text{ nom}}$		4		
I_{inh}	Input current when inhibited	$V_i = V_{i \text{ nom}}$		10		mA



Fig. 8
Output response as a function of inhibit signal

LED Output Voltage Indicator

A yellow LED indicator is illuminated, when the output voltage is present (not for -2 models).

Electromagnetic Compatibility (EMC)

Electromagnetic Immunity

Table 8: Electromagnetic immunity type tests

Phenomenon	Standard	Level	Coupling mode	Value applied	Waveform	Source imped.	Test procedure	In oper.	Perf. crit. ²
Voltage surge ³	IEC 60571-1	3	i/c, +i/-i	800 V _p	100 μs	100 Ω	1 positive and 1 negative surge per coupling mode	yes	B
				1500 V _p	50 μs				
				3000 V _p	5 μs				
				4000 V _p	1 μs				
				7000 V _p	100 ns				
Electrostatic discharge ⁵	IEC/EN 61000-4-2	3 ³	contact discharge to case	6000 V _p ³	1/50 ns	330 Ω	10 pos. & 10 neg. discharges	yes	B ⁵
		2 ⁴		4000 V _p ⁴					
Electromagnetic field	IEC/EN 61000-4-3	x	antenna	20 V/m	AM 80% / 1 kHz	N/A	80 – 1000 MHz	yes	A
				20 V/m					
				10 V/m					
				5 V/m					
				3 V/m					
Electrical fast transients / burst ⁵	IEC/EN 61000-4-4	3 ³	i/c, +i/-i	2000 V _p	bursts of 5/50 ns; 5 kHz repet. rate; transients with 15 ms burst duration; 300 ms period	50 Ω	60 s positive 60 s negative transients per coupling mode	yes	A ⁵
		2 ⁴		1000 V _p					
Surges ⁵	IEC/EN 61000-4-5	2 ³	+i/-i	1000 V _p	1.2 / 50 μs	2 Ω	5 pos. & 5 neg. surges per coupling mode	yes	A ⁵
		2	+i/-i	1000 V _p					
Conducted disturbances	IEC/EN 61000-4-6	3 ³	i, o, signal wires	10 VAC ³	AM 80% / 1 kHz	150 Ω	0.15 – 80 MHz	yes	A
		2 ⁴		3 VAC ⁴					

¹ j = input, o = output, c = case.

² A = Normal operation, no deviation from specifications, B = Normal operation, temporary loss of function or deviation from specs possible

³ Not applicable for -2 models

⁴ Valid for -2 models

⁵ With the filters and input caps as specified in the foot notes of table 2

Electromagnetic Emission

For emission levels refer to *Electrical Input Data*.

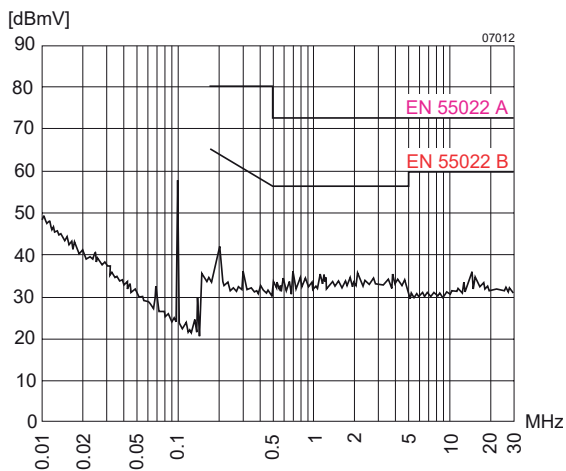

Fig. 9

Typical disturbance voltage (quasi-peak) at the input as per EN 55011, measured at $V_{i,nom}$, $I_{o,nom}$.

Immunity to Environmental Conditions

Table 6: Mechanical and climatic stress

Test method		Standard	Test Conditions		Status
Cab	Damp heat steady state	IEC/EN 60068-2-78 MIL-STD-810D section 507.2	Temperature:	40 ^{±2} °C	Regulator not operating
			Relative humidity:	93 ^{+2/-3} %	
			Duration:	56 days	
Ea	Shock (half-sinusoidal)	IEC/EN 60068-2-27 MIL-STD-810D section 516.3	Acceleration amplitude:	50 g _n = 490 m/s ²	Regulator operating
			Bump duration:	11 ms	
			Number of bumps:	18 (3 in each direction)	
Fc	Vibration (sinusoidal)	IEC/EN 60068-2-6 MIL-STD-810D section 514.3	Acceleration amplitude:	0.35 mm (10 – 60 Hz)	Regulator operating
				5 g _n = 49 m/s ² (60 - 2000 Hz)	
			Frequency (1 Oct/min):	10 – 2000 Hz	
			Test duration:	7.5 h (2.5 h in each axis)	
Fda	Random vibration wide band Reproducibility high	IEC/EN 60068-2-35 DIN 40046 part 23	Acceleration spectral density:	0.05 g _n ² /Hz	Regulator operating
			Frequency band:	20 to 500 Hz	
			Acceleration magnitude:	4.9 g _{n rms}	
			Test duration:	3 h (1 h in each axis)	
Kb	Salt mist cyclic (sodium chloride NaCl solution)	IEC/EN 60068-2-52	Concentration:	5 % (30 °C)	Regulator not operating
			Duration:	2 h per cycle	
			Storage:	40 °C, 93% rel. humidity	
			Storage duration:	22 h per cycle	
			Number of cycles:	3	

Temperatures

Table 7: Temperature specifications, valid for air pressure of 800 to 1200 hPa (800 to 1200 mbar)

Temperature			-2			-7 (Option)			-9 (Option)			Unit
Characteristics	Conditions		min	typ	max	min	typ	max	min	typ	max	
T _A	Ambient temperature ¹	Regulator operating	- 10		50	- 25		71	- 40		71	° C
T _C	Case temperature		- 10		80	- 25		95	- 40		95	
T _S	Storage temperature ¹	Not operational	- 25		100	- 40		100	- 55		85	

¹ See *Thermal Considerations*.

Reliability

Table 8: Typical MTBF and device hours

MTBF Case temperature	Ground benign	Ground fixed		Ground mobile	Device hours ¹
	T _c = 40 °C	T _c = 40 °C	T _c = 70 °C	T _c = 50 °C	
MTBF accord. to MIL-HDBK-217F	789 000 h	200 000 h	104 000 h	104 000 h	5 100 000 h

¹ Statistical values, based on an average of 4300 working hours per year and in general field use

Safety and Installation Instructions

Installation Instruction

Installation must strictly follow the national safety regulations in compliance with the enclosure, mounting, creepage, clearance, casualty, markings and segregation requirements of the end-use application.

Check for hazardous voltages before connecting.

The input and the output circuit are not separated, i.e. the negative path is internally interconnected.

Do not open the regulator !

Ensure that a regulator failure (e.g. by an internal short-circuit) does not result in a hazardous condition.

Cleaning Liquids

In order to avoid possible damage, any penetration of cleaning fluids must be prevented, since the power supplies are not hermetically sealed.

Protection Degree

The protection degree is IP 30 (IP 20, if equipped with option P). It applies only if the regulator is soldered to the mother board.

Standards and Approvals

All switching regulators have been approved according to the latest edition of IEC/EN 60950-1 and UL/CSA60950-1

The regulators have been evaluated for:

- Building in
- The use in a pollution degree 2 environment
- Connecting the input to a secondary circuit, which is subject to a maximum transient rating of 1500 V.

The switching regulators are subject to manufacturing surveillance in accordance with the above mentioned standards and with ISO 9001:2015.

Isolation

Electric strength test voltage between input connected with output against case: 1500 VDC, ≥ 1 s (for some PSA/PSR models only with version V103 or higher).

These tests are performed in the factory as routine test in accordance with EN 50514 and EN 60950.

Railway Application

The regulators have been developed observing the railway standards EN 50155 and EN 50121. All boards are coated with a protective lacquer.

Description of Options

-9 Extended Temperature Range

This option defines an extended temperature range as specified in table 7.

R Control (Output Voltage Adjust)

Note: With open R input, $V_o \approx V_{o\text{ nom}}$.



Fig. 11

Voltage adjustment via R-input

The output voltage V_o can either be adjusted with an external voltage source (V_{ext}) or with an external resistor (R_1 or R_2). The adjustment range is 0 – 108% of $V_{o\text{ nom}}$. The minimum differential voltage $\Delta V_{\text{io min}}$ between input and output (see *Electrical Input Data*) should be maintained.

a) $V_o = 0 - V_{o\text{ max}}$, using V_{ext} between pins R and Go-:

$$V_{\text{ext}} \approx 2.5 \text{ V} \cdot \frac{V_o}{V_{o\text{ nom}}} \quad V_o \approx V_{o\text{ nom}} \cdot \frac{V_{\text{ext}}}{2.5 \text{ V}}$$

Caution: To prevent damage, V_{ext} should not exceed 20 V, nor be negative.

b) $V_o = 0$ to $V_{o\text{ nom}}$, using R_{ext1} between pins R and Go-:

$$R_{\text{ext1}} \approx \frac{4000 \Omega \cdot V_o}{V_{o\text{ nom}} - V_o} \quad V_o \approx \frac{V_{o\text{ nom}} \cdot R_{\text{ext1}}}{R_{\text{ext1}} + 4000 \Omega}$$

c) $V_o = V_{o\text{ nom}}$ to $V_{o\text{ max}}$, using R_{ext2} between pins R and Go-:

$$R_{\text{ext2}} \approx \frac{4000 \Omega \cdot V_o \cdot (V_{o\text{ nom}} - 2.5 \text{ V})}{2.5 \text{ V} \cdot (V_o - V_{o\text{ nom}})}$$

$$V_o \approx \frac{V_{o\text{ nom}} \cdot 2.5 \text{ V} \cdot R_{\text{ext2}}}{2.5 \text{ V} \cdot (R_{\text{ext2}} + 4000 \Omega) - V_{o\text{ nom}} \cdot 4000 \Omega}$$

Caution: To prevent damage, R_{ext2} should never be less than 47 kΩ.

Note: With option R, the output voltage V_o is adjusted to 108% of $V_{o\text{ nom}}$, if the regulator doesn't have option Y in addition.

P Potentiometer

Option P excludes R function; the R-input (pin 16) should be left open-circuit. The output voltage V_o can be adjusted in the range 90 – 108% of $V_{o\text{ nom}}$.

However, the minimum differential voltage $\Delta V_{\text{io min}}$ between input and output specified in *Electrical Input Data* must be observed.

Note: Option P is not recommended, if several regulators are operated in parallel connection.

Y Solder Pins

Models with rectangular pins 1.0 × 0.5 mm (length 6.5 mm). Such regulators can be fitted to PCB boards (through-plated holes with \varnothing 1.3 to 1.5 mm).

G RoHS Compliance

Models with G are RoHS-compliant for all six substances.

Accessories

A variety of electrical and mechanical accessories are available including:

- Filters and ring core chokes for ripple and interference reduction; see table 9.
- Tags and isolation pads for easy and safe PCB-mounting
- Adapters for chassis and DIN-rail mounting

Isolation Pads for PCB Mounting

In applications, where PCB mounting converters are placed on top of double sided boards, the use of an isolation pad is recommended. This fibre foil avoids short circuits and provide excellent protection against possible damage to tracks.

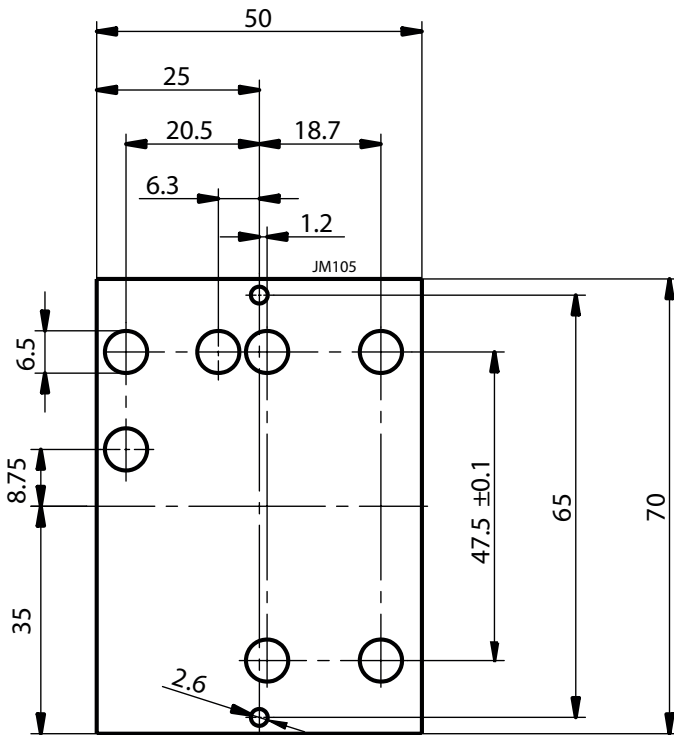

Fig. 12
Isolation pad HZZ01203-G (ISOLATIONA,A01); 0.3 mm thick

Input filters

Different input filters are available; see table 9.

Table 9: Input filters FP. $T_A = 25^\circ\text{C}$ unless otherwise specified

Characteristics		Conditions	FP 38 ²			FP 80			FP 144			Unit
			min	typ	max	min	typ	max	min	typ	max	
I_{Fn}	Rated current ¹	$L = 0.75 L_o$	4			4			2			A
V_{Fn}	Rated voltage	$T_{C\min} - T_{C\max}$	5		40	5		80	15		144	VDC
R_F	Ohmic resistance		18	20	22	18	20	22	90	95	100	mΩ
L_o	No load inductance	$I_L = 0, T_{C\min} - T_{C\max}$	30	34	38	30	34	38	88	100	112	μH
T_A	Ambient temperature	$I_F = I_{Fn}$	- 40		80	- 40		80	- 40		95	°C
T_C	Case temperature		- 40		92	- 40		92	- 40		98	
T_s	Storage temperature	Not operational	- 40		100	- 40		100	- 55		100	

¹ For currents $I_F > 4$ A the following derating takes place: $T_{A\max} = 100 - 1.3 \cdot I_F^2$ [°C], $T_{C\max} = 100 - 0.49 \cdot I_F^2$ [°C].

² FP 38 is obsolete.



Fig. 13
Different filters

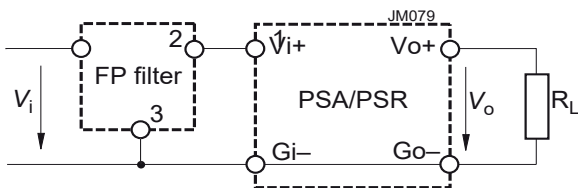

Fig. 14
Connection of the FP filter

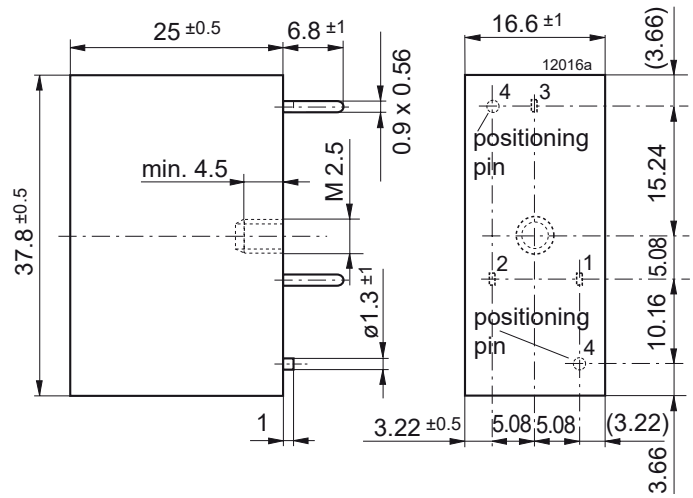

Fig. 15
Mechanical data of the FP filter. Weight approx. 30 g

Mounting Supports

Different mounting supports for DIN-rail and chassis mounting are described in the [Mounting Supports](#) data sheet on our web site. They also allow for fitting additional components.

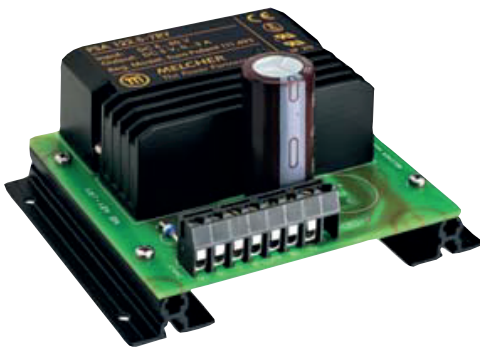

Fig. 16
Adapter for chassis mounting

For additional accessory product information, see the accessory data sheets listed with each product series at our web site.

NUCLEAR AND MEDICAL APPLICATIONS - These products are not designed or intended for use as critical components in life support systems, equipment used in hazardous environments, or nuclear control systems.

TECHNICAL REVISIONS - The appearance of products, including safety agency certifications pictured on labels, may change depending on the date manufactured. Specifications are subject to change without notice.

Данный компонент на территории Российской Федерации

Вы можете приобрести в компании MosChip.

Для оперативного оформления запроса Вам необходимо перейти по данной ссылке:

<http://moschip.ru/get-element>

Вы можете разместить у нас заказ для любого Вашего проекта, будь то серийное производство или разработка единичного прибора.

В нашем ассортименте представлены ведущие мировые производители активных и пассивных электронных компонентов.

Нашей специализацией является поставка электронной компонентной базы двойного назначения, продукции таких производителей как XILINX, Intel (ex.ALTERA), Vicor, Microchip, Texas Instruments, Analog Devices, Mini-Circuits, Amphenol, Glenair.

Сотрудничество с глобальными дистрибьюторами электронных компонентов, предоставляет возможность заказывать и получать с международных складов практически любой перечень компонентов в оптимальные для Вас сроки.

На всех этапах разработки и производства наши партнеры могут получить квалифицированную поддержку опытных инженеров.

Система менеджмента качества компании отвечает требованиям в соответствии с ГОСТ Р ИСО 9001, ГОСТ РВ 0015-002 и ЭС РД 009

Офис по работе с юридическими лицами:

105318, г.Москва, ул.Щербаковская д.3, офис 1107, 1118, ДЦ «Щербаковский»

Телефон: +7 495 668-12-70 (многоканальный)

Факс: +7 495 668-12-70 (доб.304)

E-mail: info@moschip.ru

Skype отдела продаж:

moschip.ru

moschip.ru_4

moschip.ru_6

moschip.ru_9