

857145

1960 MHz SAW Filter

Applications

- For filtering in DPD path
- For ultra wideband applications
- Wireless infrastructure

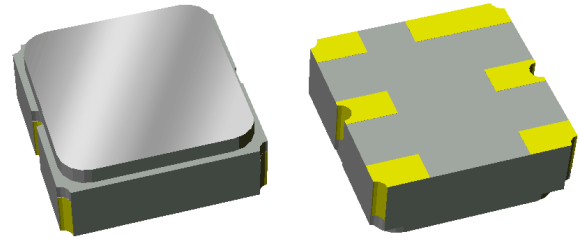

Product Features

- Usable bandwidth 160 MHz
- Low Loss
- High attenuation,
- Excellent power handling
- Single-ended operation
- Matching required for operation at 50Ω
- Small Size: 3.00 x 3.00 x 1.22 mm
- Ceramic Surface Mount Package (SMP)
- Hermetically sealed
- RoHS compliant, Pb-free 

Functional Block Diagram

Top view

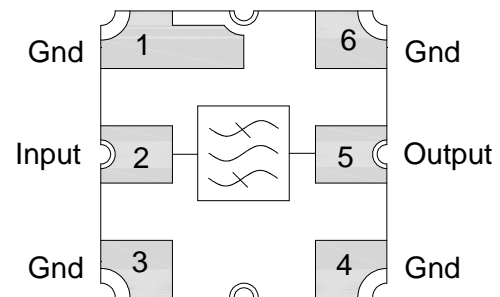

General Description

857145 is a RF filter for wireless infrastructure applications. This filter was specifically designed for filtering in the digital pre-distortion path in Base Station applications. This filter is designed in a 3x3mm hermetic package and is part of our wide portfolio of RF filters in the same package.

Low insertion loss, coupled with high attenuation and excellent power handling, makes this filter a natural choice for our customers Downlink RF filtering needs.

Pin Configuration

| Pin # | SE | Description |
|---------|----|-------------|
| 2 | | Input |
| 5 | | Output |
| 1,3,4,6 | | Case Ground |

Ordering Information

| Part No. | Description |
|------------|------------------|
| 857145 | packaged part |
| 857145-EVB | evaluation board |

Standard T/R size = 5000 units/reel.

Specifications

Electrical Specifications ⁽¹⁾

Specified Temperature Range: ⁽²⁾ -40 to +85 °C

| Parameter ⁽³⁾ | Conditions | Min | Typical ⁽⁴⁾ | Max | Units |
|--------------------------------------|--|-----|------------------------|-------|---------|
| Center Frequency | | - | 1960 | - | MHz |
| Maximum Insertion Loss | 1930 – 1990 MHz | - | 3.0 | 4.0 | dB |
| Amplitude Variation ⁽⁵⁾ | 1930 – 1990 MHz | - | 0.7 | 1.1 | dB p-p |
| | 1930 – 1990 MHz (Over any 5 MHz span) | - | 0.3 | 0.6 | dB p-p |
| | 1880 – 2040 MHz | - | 1.5 | 2.5 | dB p-p |
| Phase Ripple ⁽⁵⁾ | 1930 – 1990 MHz | - | 2.6 | 6 | deg p-p |
| | 1930 – 1990 MHz (Over any 5 MHz span) | - | 1.7 | 3 | deg p-p |
| | 1880 – 2040 MHz | - | 21 | 36 | deg p-p |
| Group Delay Variation ⁽⁵⁾ | 1930 – 1990 MHz | - | 2.8 | 6 | ns p-p |
| | 1880 – 2040 MHz | - | 6.2 | 12 | ns p-p |
| Absolute Delay | Average over 1930 – 1990 MHz | - | 4 | 10 | ns |
| EVM | 1930 – 1990 MHz (Over any 3.84 MHz span) | - | 0.8 | 1.5 | % |
| IIP3 ⁽⁶⁾ | Tones 5 MHz separated, power > 5dBm per tone | 44 | 52 | - | dBm |
| Temperature Drift ⁽⁷⁾ | 1930 – 1990 MHz | - | 0.22 | 0.3 | dB |
| Input/Output VSWR | 1930 – 1990 MHz | - | 1.5 | 2.0:1 | - |
| Relative Attenuation ⁽⁸⁾ | 10 – 704 MHz | 45 | 53 | - | dB |
| | 704 – 1561 MHz | 25 | 29 | - | dB |
| | 1561 – 1622 MHz | 25 | 29 | - | dB |
| | 1622 – 1790 MHz | 25 | 29 | - | dB |
| | 2170 – 4000 MHz | 25 | 28 | - | dB |
| | 4000 – 6000 MHz | 20 | 25 | - | dB |
| Source/Load Impedance ⁽⁹⁾ | Single-ended | - | 50 | - | Ω |

Notes:

- All specifications are based on the TriQuint schematic shown on page 3.
- In production, devices will be tested at room temperature to a guardbanded specification to ensure electrical compliance over temperature.
- Electrical margin has been built into the design to account for the variations due to temperature drift and manufacturing tolerances.
- Typical values are based on average measurements at room temperature.
- Variation is defined as the total peak to peak variation over the defined frequency range.
- To be measured only during engineering development.
- Temperature Drift specification is defined on Page 3 and is guaranteed by design and won't be measured in production
- Relative to maximum insertion loss at center frequency.
- This is the optimum impedance in order to achieve the performance shown.

Absolute Maximum Ratings

| Parameter | Rating |
|----------------------|---|
| Operable Temperature | -40 to +85 °C |
| Storage Temperature | -40 to +85 °C |
| Input Power | +22 dBm (max) CW for 24 hours at +55 °C |

Operation of this device outside the parameter ranges given above may cause permanent damage.

Temperature Drift Specification

Temperature Drift Equations:

$$\text{Temp Drift}_{\text{high}} = \left| \frac{\max(T_{\text{ambient}} - T_{\text{hot}}) - \min(T_{\text{ambient}} - T_{\text{hot}})}{2} \right|$$

$$\text{Temp Drift}_{\text{low}} = \left| \frac{\max(T_{\text{ambient}} - T_{\text{cold}}) - \min(T_{\text{ambient}} - T_{\text{cold}})}{2} \right|$$

Temperature Drift Terms Defined:

T_{ambient} - Transmission power in dB measured at +25 degrees C.
 T_{hot} - Transmission power in dB measured at +85 degrees C.
 T_{cold} - Transmission power in dB measured at -40 degrees C.
 Temperature Drift - Greater of $\text{Temp Drift}_{\text{high}}$ vs $\text{Temp Drift}_{\text{low}}$

Reference Design

Schematic

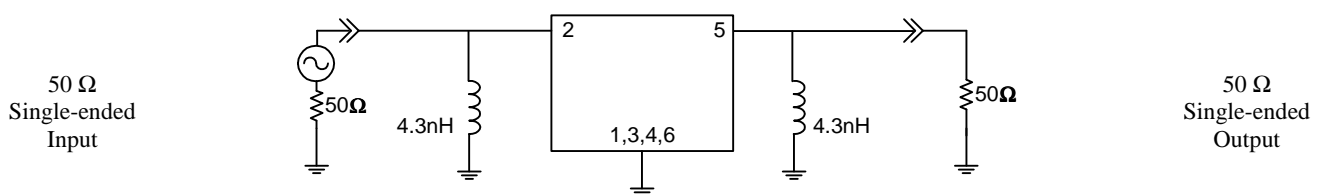

PC Board

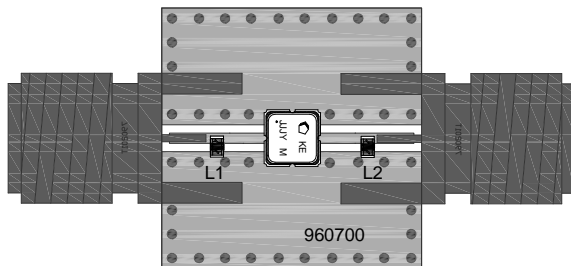

Notes:

- Top, middle & bottom layers: 1 oz copper
- Substrates: FR4 dielectric, .031" thick
- Finish plating: Nickel: 3-8 μ m thick, Gold: .03-.2 μ m thick
- Hole plating: Copper min .0008 μ m thick

Mounting Configuration

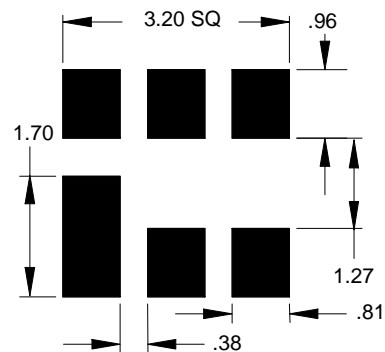

Notes:

1. All dimensions are in millimeters.
2. This footprint represents a recommendation only.

Bill of Material

| Reference Desg. | Value | Description | Manufacturer | Part Number |
|-----------------|-------|---------------------------|------------------|---------------|
| L1 | 4.3nH | Coil Wire-wound, 0402, 5% | MuRata | LQW15AN4N3D00 |
| L2 | 4.3nH | Coil Wire-wound, 0402, 5% | MuRata | LQW15AN4N3D00 |
| SMA | N/A | SMA connector | Radiall USA Inc. | 9602-1111-018 |
| PCB | N/A | 3-layer | multiple | 960700 |

Typical Performance (at room temperature)

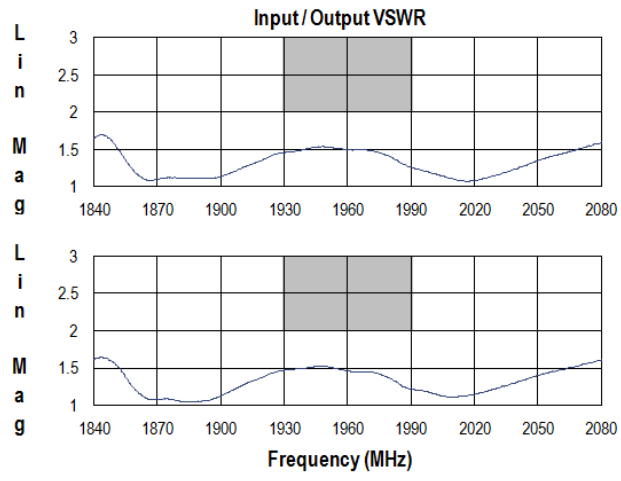
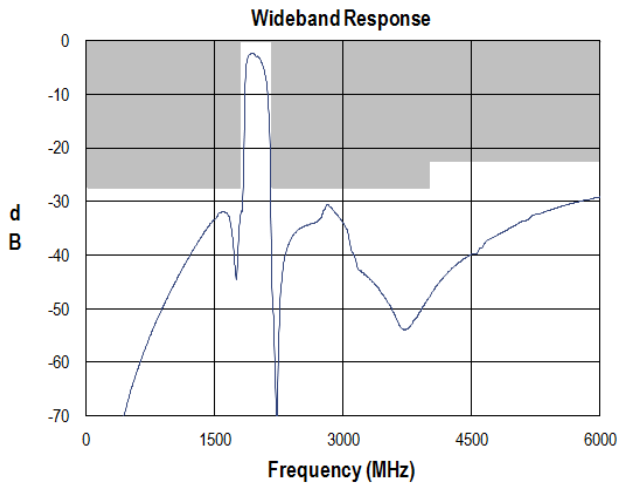
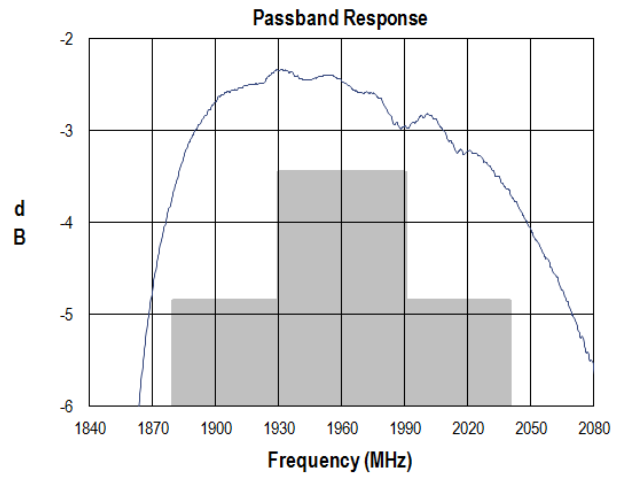
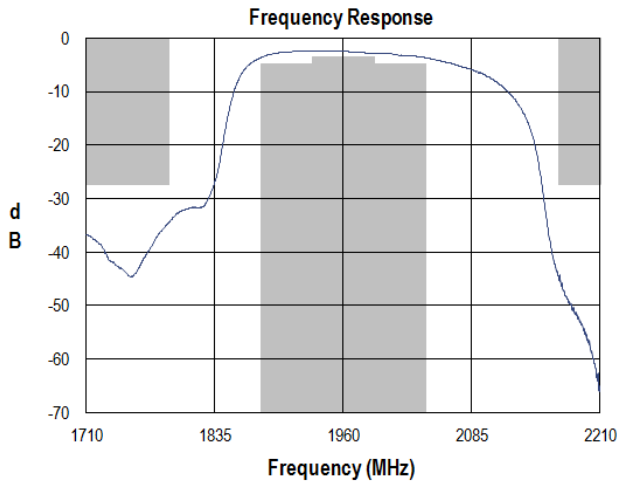

Input Smith Chart

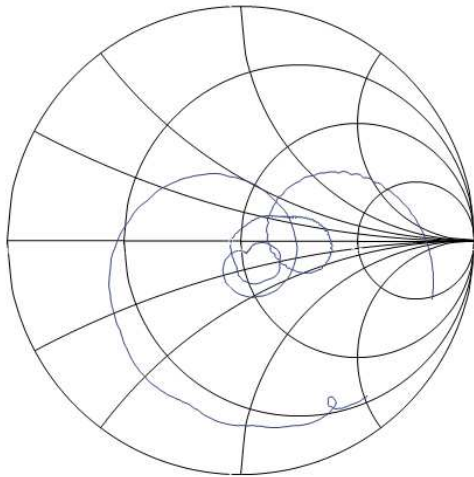

Output Smith Chart

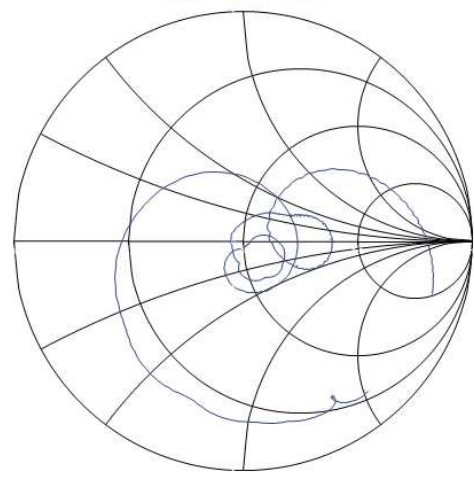

Mechanical Information

Package Information, Dimensions and Marking

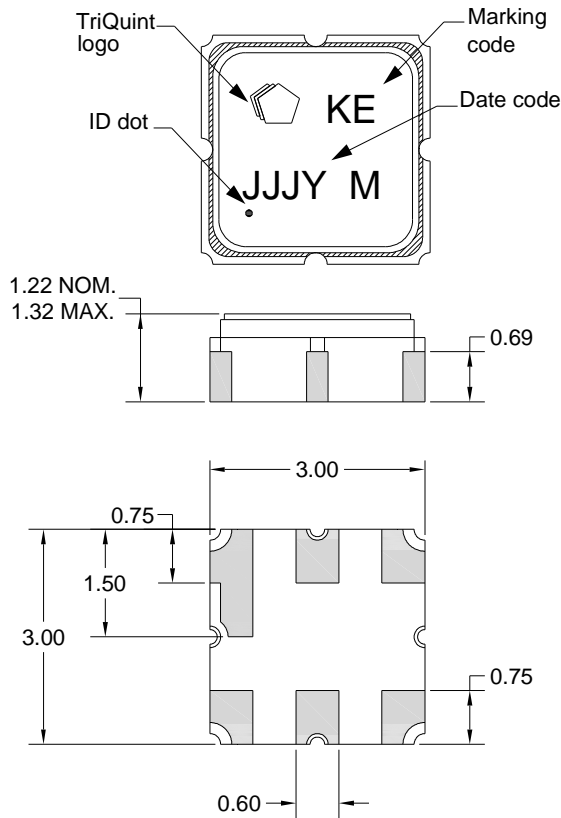

Package Style: SMP-12A
 Dimensions: 3.00 x 3.00 x 1.22 mm

Body: Al_2O_3 ceramic
 Lid: Kovar, Ni plated
 Terminations: Au plating 0.5 - 1.0 μ m, over a 2-6 μ m Ni plating

All dimensions shown are nominal in millimeters
 All tolerances are ± 0.15 mm except overall length and width ± 0.10 mm

The date code consists of day of the current year (Julian, 3 digits), Y = last digit of the year, and M = manufacturing site code

Tape and Reel Information

Standard T/R size = 5000 units/reel. All dimensions are in millimeters

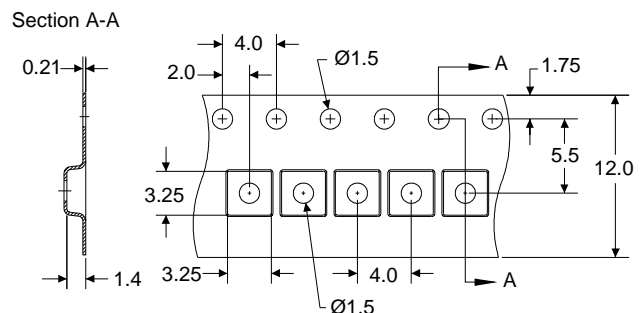
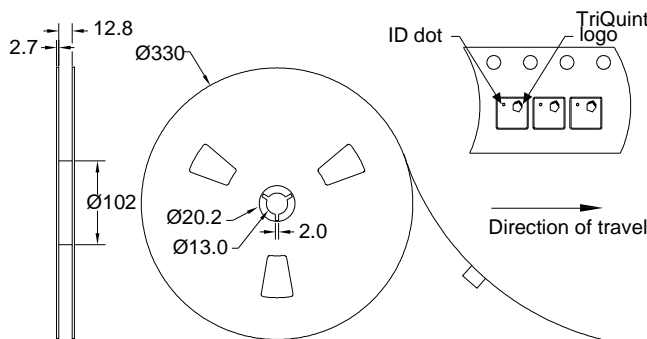

Product Compliance Information

ESD Information



Caution! ESD-Sensitive Device

ESD Rating: 1B

Value: Passes ≥ 550 V min.
Test: Human Body Model (HBM)
Standard: JEDEC Standard JESD22-A114

ESD Rating: B

Value: Passes ≥ 200 V min.
Test: Machine Model (MM)
Standard: JEDEC Standard JESD22-A115

MSL Rating

Devices are Hermetic, therefore MSL is not applicable

Solderability

Compatible with the latest version of J-STD-020, lead free solder, 260°C

Refer to [Soldering Profile](#) for recommended guidelines.

This part is compliant with EU 2002/95/EC RoHS directive (Restrictions on the Use of Certain Hazardous Substances in Electrical and Electronic Equipment).

This product also has the following attributes:

- Halogen Free (Chlorine, Bromine)
- Antimony Free
- TBBP-A (C₁₅H₁₂Br₄O₂) Free
- PFOS Free
- SVHC Free

Contact Information

For the latest specifications, additional product information, worldwide sales and distribution locations, and information about TriQuint:

Web: www.triquint.com **Tel:** +1.407.886.8860
Email: info-sales@tqs.com **Fax:** +1.407.886.7061

For technical questions and application information:

Email: flapplication.engineering@tqs.com

Important Notice

The information contained herein is believed to be reliable. TriQuint makes no warranties regarding the information contained herein. TriQuint assumes no responsibility or liability whatsoever for any of the information contained herein. TriQuint assumes no responsibility or liability whatsoever for the use of the information contained herein. The information contained herein is provided "AS IS, WHERE IS" and with all faults, and the entire risk associated with such information is entirely with the user. All information contained herein is subject to change without notice. Customers should obtain and verify the latest relevant information before placing orders for TriQuint products. The information contained herein or any use of such information does not grant, explicitly or implicitly, to any party any patent rights, licenses, or any other intellectual property rights, whether with regard to such information itself or anything described by such information.

TriQuint products are not warranted or authorized for use as critical components in medical, life-saving, or life-sustaining applications, or other applications where a failure would reasonably be expected to cause severe personal injury or death.

Данный компонент на территории Российской Федерации

Вы можете приобрести в компании MosChip.

Для оперативного оформления запроса Вам необходимо перейти по данной ссылке:

<http://moschip.ru/get-element>

Вы можете разместить у нас заказ для любого Вашего проекта, будь то серийное производство или разработка единичного прибора.

В нашем ассортименте представлены ведущие мировые производители активных и пассивных электронных компонентов.

Нашей специализацией является поставка электронной компонентной базы двойного назначения, продукции таких производителей как XILINX, Intel (ex.ALTERA), Vicor, Microchip, Texas Instruments, Analog Devices, Mini-Circuits, Amphenol, Glenair.

Сотрудничество с глобальными дистрибьюторами электронных компонентов, предоставляет возможность заказывать и получать с международных складов практически любой перечень компонентов в оптимальные для Вас сроки.

На всех этапах разработки и производства наши партнеры могут получить квалифицированную поддержку опытных инженеров.

Система менеджмента качества компании отвечает требованиям в соответствии с ГОСТ Р ИСО 9001, ГОСТ РВ 0015-002 и ЭС РД 009

Офис по работе с юридическими лицами:

105318, г.Москва, ул.Щербаковская д.3, офис 1107, 1118, ДЦ «Щербаковский»

Телефон: +7 495 668-12-70 (многоканальный)

Факс: +7 495 668-12-70 (доб.304)

E-mail: info@moschip.ru

Skype отдела продаж:

moschip.ru

moschip.ru_4

moschip.ru_6

moschip.ru_9