

Q2L Series - 3.3x3.3 QFN

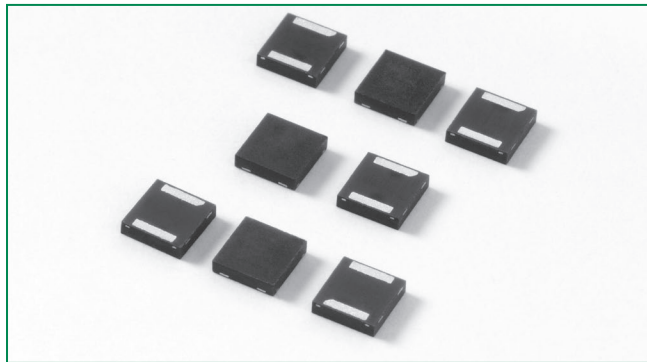

Agency Approvals

| Agency | Agency File Number |
|--------|--------------------|
| | E133083 |

Pinout Designation

Not Applicable

Schematic Symbol



Description

Q2L Series 3.3x3.3 QFN are low capacitance SIDACtor® devices designed to protect high density broadband equipment from damaging overvoltage transients.

The series provides a low profile, chip scale surface mount solution that enables broadband equipment to comply with global regulatory standards while limiting the impact to broadband signals and board space.

Features and Benefits

- Low profile
- Small footprint
- Low capacitance
- Low voltage overshoot
- Low on-state voltage
- Does not degrade surge capability after multiple surge events within limit.
- Fails short circuit when surged in excess of ratings
- 2nd level interconnect is Pb-free per IPC/JEDEC J-STD-609A.01

Applicable Global Standards

- TIA-968-A
- TIA-968-B
- ITU K.20/21 Enhanced Level
- ITU K.20/21 Basic Level
- GR 1089 Intra-building
- IEC 61000-4-5
- YD/T 1082
- YD/T 993
- YD/T 950
- GR 1089 Inter-building

Electrical Characteristics

| Part Number | Marking | V_{DRM} | V_s | I_H | I_s | I_T | $V_T @ I_T = 2.2 \text{ Amps}$ | Capacitance @ 1MHz, 2V bias | |
|--------------|---------|----------------------------|-----------------------|--------|--------|-------|--------------------------------|-----------------------------|--------|
| | | @ $I_{DRM} = 5\mu\text{A}$ | @ 100V/ μs | mA min | mA max | A max | V max | pF min | pF max |
| P0080Q22CLRP | P-8C | 6 | 25 | 50 | 800 | 2.2 | 5 | 35 | 75 |
| P0300Q22CLRP | P03C | 25 | 40 | 50 | 800 | 2.2 | 5 | 25 | 45 |
| P0640Q22CLRP | P06C | 58 | 77 | 150 | 800 | 2.2 | 5 | 55 | 85 |
| P0720Q22CLRP | P07C | 65 | 88 | 150 | 800 | 2.2 | 5 | 50 | 75 |
| P0900Q22CLRP | P09C | 75 | 98 | 150 | 800 | 2.2 | 5 | 45 | 70 |
| P1100Q22CLRP | P11C | 90 | 130 | 150 | 800 | 2.2 | 5 | 45 | 70 |
| P1300Q22CLRP | P13C | 120 | 160 | 150 | 800 | 2.2 | 5 | 40 | 60 |
| P1500Q22CLRP | P15C | 140 | 180 | 150 | 800 | 2.2 | 5 | 35 | 55 |
| P1800Q22CLRP | P18C | 170 | 220 | 150 | 800 | 2.2 | 5 | 35 | 50 |
| P2300Q22CLRP | P23C | 190 | 260 | 150 | 800 | 2.2 | 5 | 30 | 50 |
| P2600Q22CLRP | P26C | 220 | 300 | 150 | 800 | 2.2 | 5 | 30 | 45 |
| P3100Q22CLRP | P31C | 275 | 350 | 150 | 800 | 2.2 | 5 | 30 | 45 |
| P3500Q22CLRP | P35C | 320 | 400 | 150 | 800 | 2.2 | 5 | 25 | 40 |
| P4500Q22CLRP | P45C | 400 | 530 | 150 | 800 | 2.2 | 5 | 25 | 45 |

Notes:
 - Absolute maximum ratings measured at $T_a = 25^\circ\text{C}$ (unless otherwise noted).
 - Devices are bi-directional (unless otherwise noted).

Surge Ratings

| Series | 2x10 ¹ | 8x20 ¹ | 10x160 ¹ | 10x560 ¹ | 10x1000 ¹ | 5x310 ¹ | I _{TSM} 50/60 Hz | di/dt |
|--------|-------------------|---------------------|---------------------|---------------------|----------------------|---------------------|------------------------------|----------|
| | 2x10 ² | 1.2x50 ² | 10x160 ² | 10x560 ² | 10x1000 ² | 10x700 ² | | |
| | A min | A min | A min | A min | A min | A min | A min | A/μs max |
| C | 500 | 400 | 200 | 150 | 100 | 200 ³ | 30 | 500 |

Notes:
 1 Current waveform in μs
 2 Voltage waveform in μs
 3 for surge rating of P4500Q22CLRP 10x700μs min=150A & typical=180A

- Peak pulse current rating (I_{pp}) is repetitive and guaranteed for the life of the product.
- I_{pp} ratings applicable over temperature range of -40°C to +85°C
- The device must initially be in thermal equilibrium with -40°C ≤ T_j ≤ +150°C

Thermal Considerations

| Package | Symbol | Parameter | Value | Unit |
|--|------------------|---|-------------|------|
| 3.3x3.3 QFN  | T _J | Operating Junction Temperature Range | -40 to +150 | °C |
| | T _S | Storage Temperature Range | -65 to +150 | °C |
| | R _{θJA} | Thermal Resistance: Junction to Ambient | 120 | °C/W |

V-I Characteristics

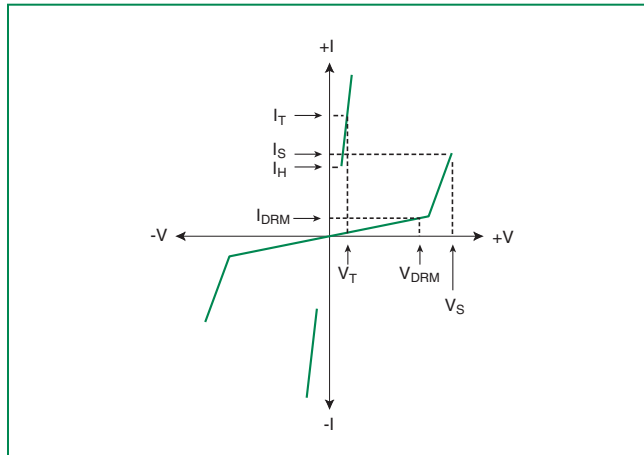

t_r x t_d Pulse Waveform

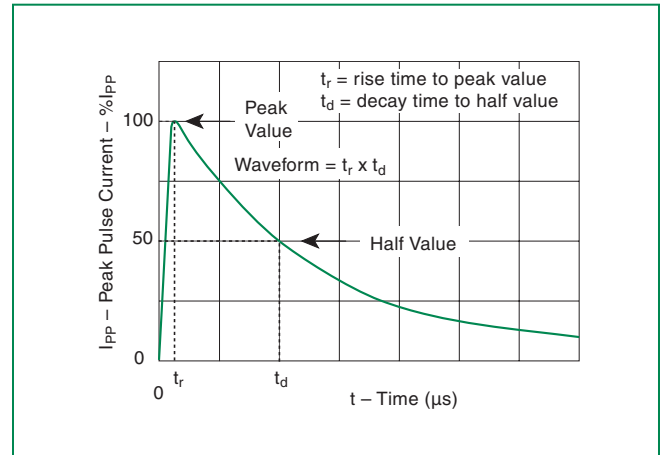

Normalized V_S Change vs. Junction Temperature

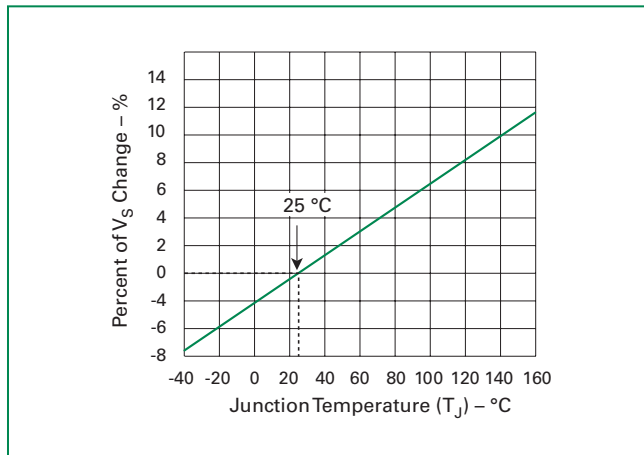

Normalized DC Holding Current vs. Case Temperature

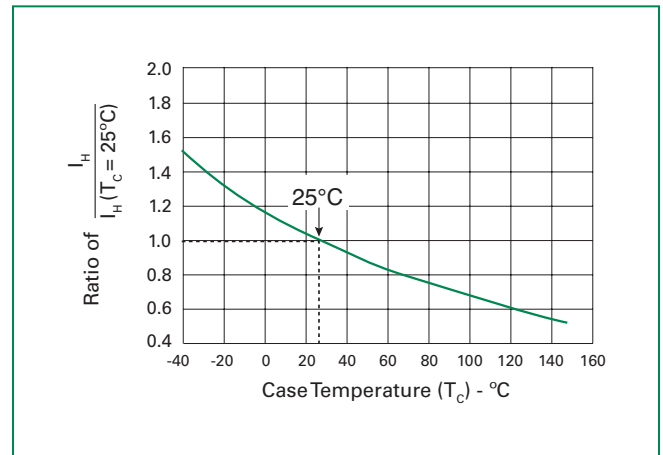

Soldering Parameters

| | | |
|--|-----------------------------------|--------------|
| Reflow Condition | Pb-Free assembly (see Fig. 1) | |
| Pre Heat | -Temperature Min ($T_{s(min)}$) | +150°C |
| | -Temperature Max ($T_{s(max)}$) | +200°C |
| | -Time (Min to Max) (t_s) | 60-180 secs. |
| Average ramp up rate (Liquidus Temp (T_L) to peak) | 3°C/sec. Max. | |
| $T_{s(max)}$ to T_L - Ramp-up Rate | 3°C/sec. Max. | |
| Reflow | -Temperature (T_L) (Liquidus) | +217°C |
| | -Temperature (t_L) | 60-150 secs. |
| Peak Temp (T_p) | +260(+0/-5)°C | |
| Time within 5°C of actual Peak Temp (t_p) | 30 secs. Max. | |
| Ramp-down Rate | 6°C/sec. Max. | |
| Time 25°C to Peak Temp (T_p) | 8 min. Max. | |
| Do not exceed | +260°C | |

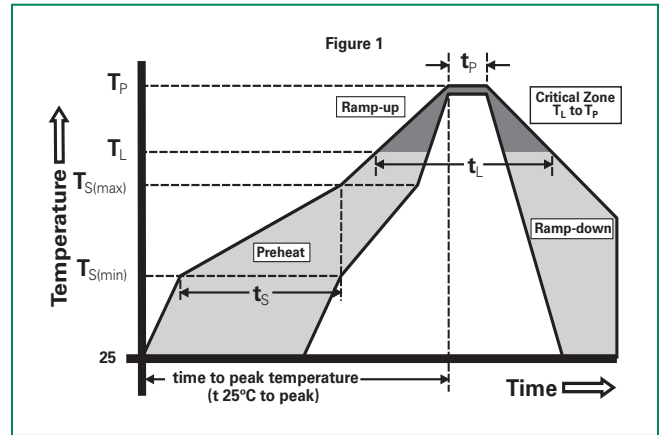

Physical Specifications

| | |
|------------------------|---|
| Lead Material | Copper Alloy |
| Terminal Finish | 100% Matte-Tin Plated |
| Body Material | UL recognized epoxy meeting flammability classification 94V-0 |

Environmental Specifications

| | |
|-----------------------------------|--|
| High Temp Voltage Blocking | 80% Rated V_{DRM} ($V_{AC Peak}$) +125°C or +150°C, 504 or 1008 hrs. MIL-STD-750 (Method 1040) JEDEC, JESD22-A-101 |
| Temp Cycling | -65°C to +150°C, 15 min. dwell, 10 up to 100 cycles. MIL-STD-750 (Method 1051) EIA/JEDEC, JESD22-A104 |
| Biased Temp & Humidity | 52 V_{DC} (+85°C) 85%RH, 504 up to 1008 hrs. EIA/JEDEC, JESD22-A-101 |
| High Temp Storage | +150°C 1008 hrs. MIL-STD-750 (Method 1031) JEDEC, JESD22-A-101 |
| Low Temp Storage | -65°C, 1008 hrs. |
| Thermal Shock | 0°C to +100°C, 5 min. dwell, 10 sec. transfer, 10 cycles. MIL-STD-750 (Method 1056) JEDEC, JESD22-A-106 |
| Resistance to Solder Heat | +260°C, 30 secs. MIL-STD-750 (Method 2031) |
| Moisture Sensitivity Level | 85%RH, +85°C, 168 hrs., 3 reflow cycles (+260°C Peak). JEDEC-J-STD-020, Level 1 |

Dimensions — 3.3x3.3 QFN

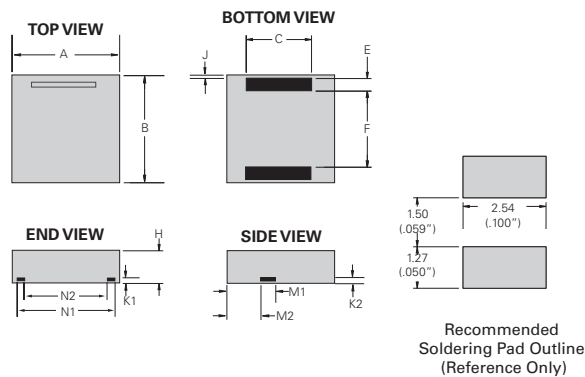

| Dimensions | Inches | | Millimeters | |
|------------|--------|-------|-------------|-------|
| | Min | Max | Min | Max |
| A | 0.126 | 0.134 | 3.200 | 3.400 |
| B | 0.126 | 0.134 | 3.200 | 3.400 |
| C | 0.075 | 0.083 | 1.900 | 2.100 |
| E | 0.011 | 0.019 | 0.285 | 0.485 |
| F | 0.088 | 0.096 | 2.230 | 2.430 |
| H | 0.035 | 0.043 | 0.900 | 1.100 |
| J | 0.000 | 0.008 | 0.000 | 0.200 |
| K1 | 0.004 | 0.012 | 0.100 | 0.300 |
| K2 | 0.004 | 0.012 | 0.100 | 0.300 |
| M1 | 0.063 | 0.071 | 1.610 | 1.810 |
| M2 | 0.045 | 0.053 | 1.153 | 1.353 |
| N1 | 0.095 | 0.103 | 2.420 | 2.620 |
| N2 | 0.082 | 0.090 | 2.080 | 2.280 |

Part Numbering

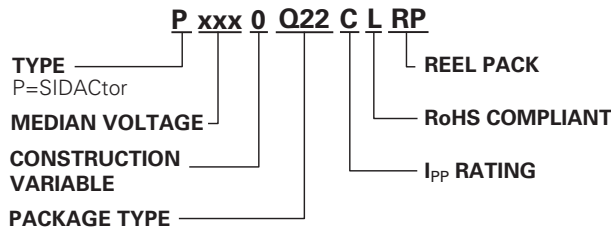

Part Marking

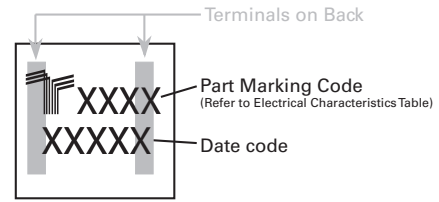

Packing Options

| Package Type | Description | Quantity | Added Suffix | Industry Standard |
|--------------|--------------------------------|----------|--------------|-------------------|
| Q22 | 3.3x3.3 QFN Tape and Reel Pack | 5000 | RP | EIA-481-D |

Tape and Reel Specifications — 3.3x3.3 QFN

Reel Dimension

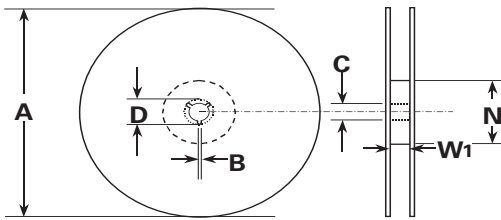

Tape Leader and Trailer Dimensions

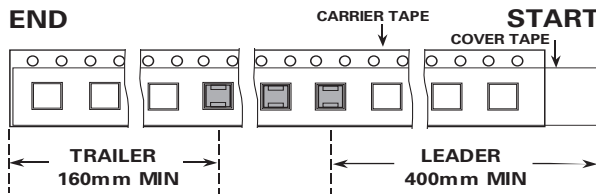

Tape Dimension Items

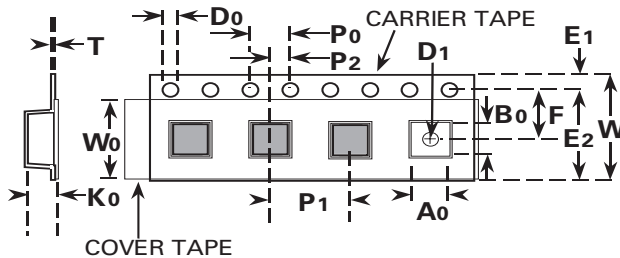

| Symbols | Description | Inches | | Millimeters | |
|----------------|---|--------|--------|-------------|-------|
| | | Min | Max | Min | Max |
| A | Reel Diameter | N/A | 12.992 | N/A | 330.0 |
| B | Drive Spoke Width | 0.059 | N/A | 1.50 | N/A |
| C | Arbor Hole Diameter | 0.504 | 0.531 | 12.80 | 13.50 |
| D | Drive Spoke Diameter | 0.795 | N/A | 20.20 | N/A |
| N | Hub Diameter | 1.969 | N/A | 50.00 | N/A |
| W ₁ | Reel Inner Width at Hub | 0.488 | 0.567 | 12.40 | 14.40 |
| A ₀ | Pocket Width at Bottom | 0.138 | 0.146 | 3.50 | 3.70 |
| B ₀ | Pocket Length at Bottom | 0.138 | 0.146 | 3.50 | 3.70 |
| D ₀ | Feed Hole Diameter | 0.059 | 0.063 | 1.50 | 1.60 |
| D ₁ | Pocket Hole Diameter | 0.059 | N/A | 1.50 | N/A |
| E ₁ | Feed Hole Position 1 | 0.065 | 0.073 | 1.65 | 1.85 |
| E ₂ | Feed Hole Position 2 | 0.400 | 0.408 | 10.15 | 10.35 |
| F | Feed Hole Center - Pocket Hole Center 2 | 0.215 | 0.219 | 5.45 | 5.55 |
| K ₀ | Pocket Depth | 0.039 | 0.051 | 1.00 | 1.30 |
| P ₀ | Feed Hole Pitch | 0.153 | 0.161 | 3.90 | 4.10 |
| P ₁ | Component Spacing | 0.311 | 0.319 | 7.90 | 8.10 |
| P ₂ | Feed Hole Center - Pocket Hole Center 1 | 0.077 | 0.081 | 1.90 | 2.05 |
| T | Carrier Tape Thickness | 0.010 | 0.014 | 0.25 | 0.35 |
| W | Embossed Carrier Tape Width | 0.453 | 0.484 | 11.50 | 12.30 |
| W ₀ | Cover Tape Width | 0.358 | 0.366 | 9.10 | 9.30 |

Данный компонент на территории Российской Федерации

Вы можете приобрести в компании MosChip.

Для оперативного оформления запроса Вам необходимо перейти по данной ссылке:

<http://moschip.ru/get-element>

Вы можете разместить у нас заказ для любого Вашего проекта, будь то серийное производство или разработка единичного прибора.

В нашем ассортименте представлены ведущие мировые производители активных и пассивных электронных компонентов.

Нашей специализацией является поставка электронной компонентной базы двойного назначения, продукции таких производителей как XILINX, Intel (ex.ALTERA), Vicor, Microchip, Texas Instruments, Analog Devices, Mini-Circuits, Amphenol, Glenair.

Сотрудничество с глобальными дистрибьюторами электронных компонентов, предоставляет возможность заказывать и получать с международных складов практически любой перечень компонентов в оптимальные для Вас сроки.

На всех этапах разработки и производства наши партнеры могут получить квалифицированную поддержку опытных инженеров.

Система менеджмента качества компании отвечает требованиям в соответствии с ГОСТ Р ИСО 9001, ГОСТ РВ 0015-002 и ЭС РД 009

Офис по работе с юридическими лицами:

105318, г.Москва, ул.Щербаковская д.3, офис 1107, 1118, ДЦ «Щербаковский»

Телефон: +7 495 668-12-70 (многоканальный)

Факс: +7 495 668-12-70 (доб.304)

E-mail: info@moschip.ru

Skype отдела продаж:

moschip.ru

moschip.ru_4

moschip.ru_6

moschip.ru_9