

## FLORENTINA-1-MRK-M

~40° medium beam. Compatible with ultra high power LEDs.

### TECHNICAL SPECIFICATIONS:

Dimensions	39.7 mm
Height	13 mm
Fastening	pin
ROHS compliant	yes ⓘ

### MATERIAL SPECIFICATIONS:

Component	Type	Material	Colour	Finish
ROSE-MRK-M	Single lens	PC	clear	
FLORENTINA-1-HLD	Holder	PC	black	
ROSE-TAPE	Tape	PU tape	black	

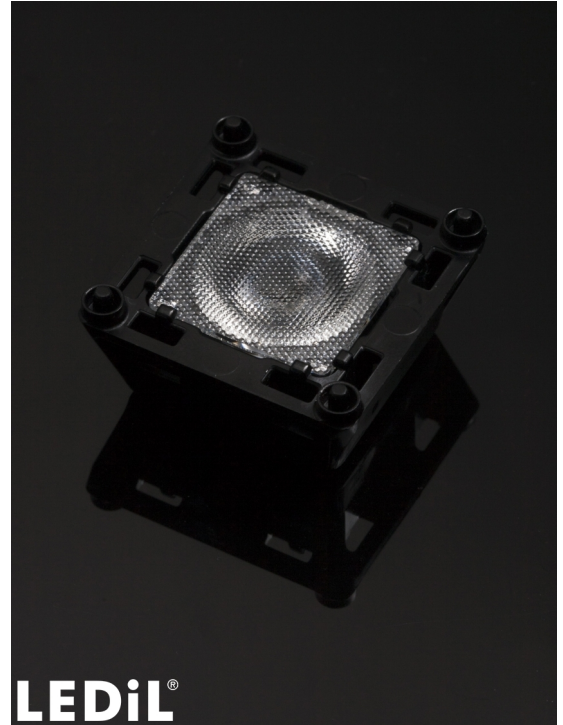

### ORDERING INFORMATION:

Component		Qty in box	MOQ	MPQ	Box weight (kg)
FCA15512_FLORENTINA-1-MRK-M	Single lens	840		60	7.7
» Box size: 480 x 280 x 300 mm					

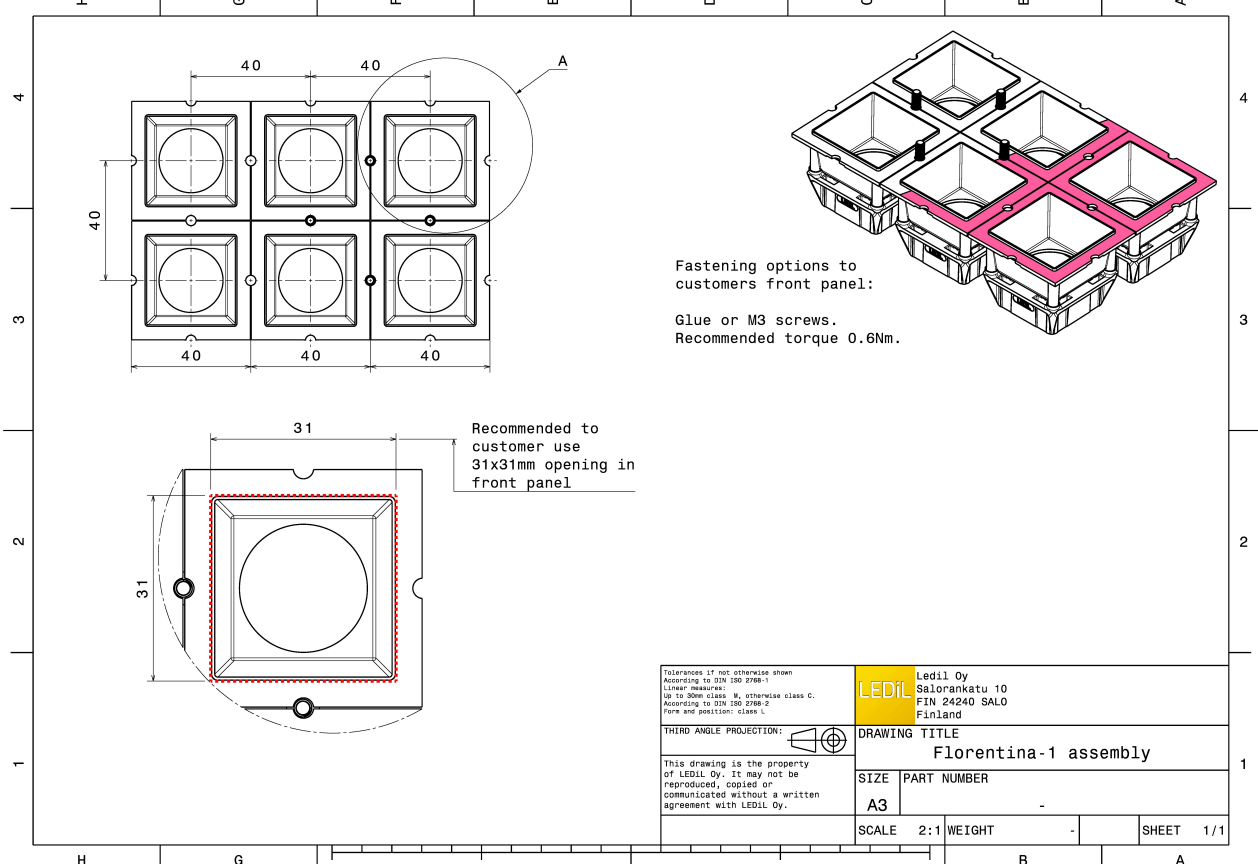
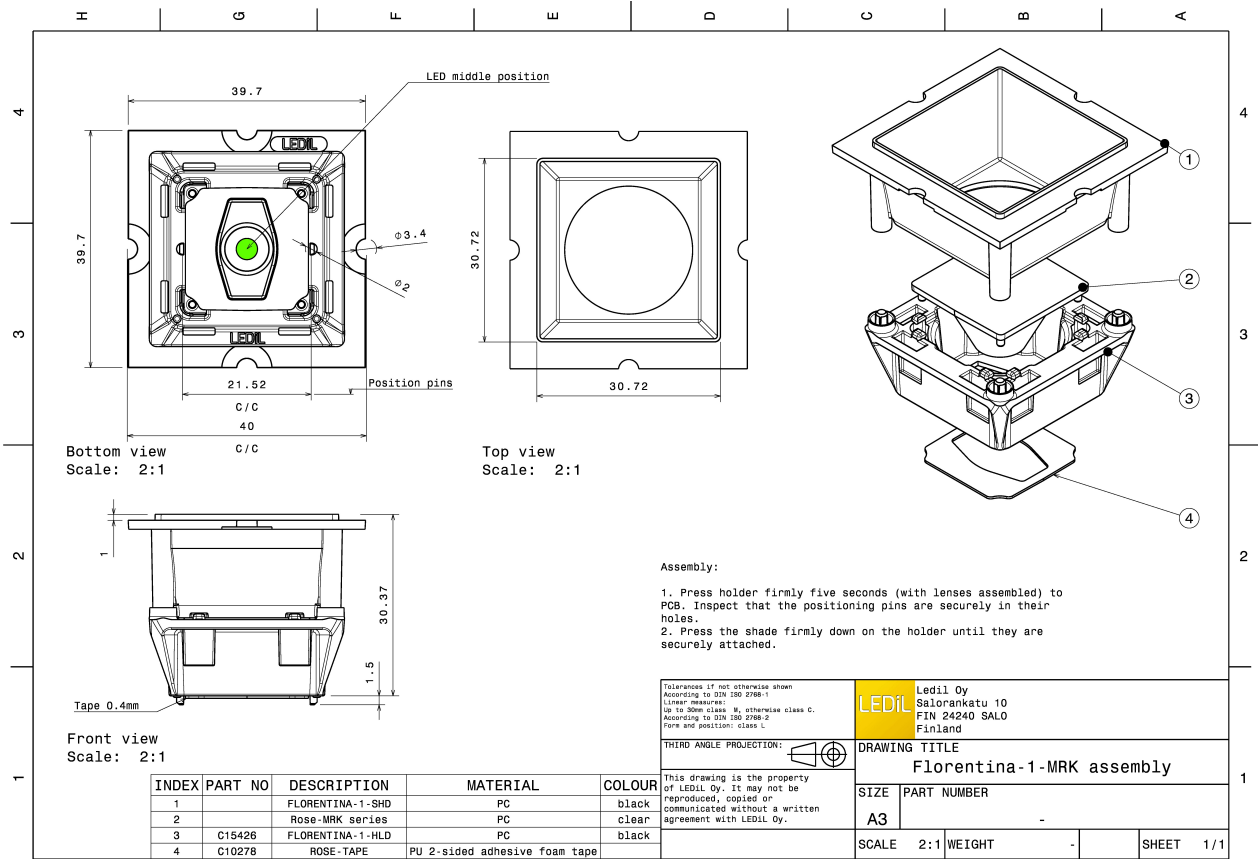

#### PHOTOMETRIC DATA (MEASURED):



**LED** XHP35 HI  
**FWHM** 33.0°  
**Efficiency** 77 %  
**Peak intensity** 2.3 cd/lm  
**LEDs/each optic** 1  
**Light colour** White  
**Required components:**  
 C15427\_FLORENTINA-1-SHD-60

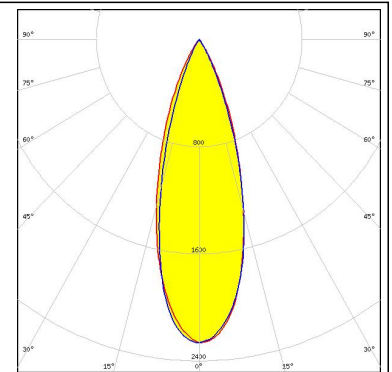
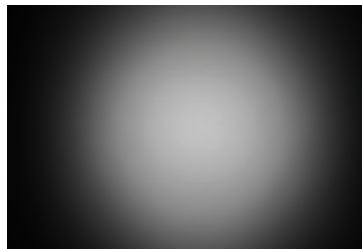

**LED** LG 5630  
**FWHM** 32.0°  
**Efficiency** 81 %  
**Peak intensity** 2.5 cd/lm  
**LEDs/each optic** 1  
**Light colour** White  
**Required components:**  
 C15427\_FLORENTINA-1-SHD-60

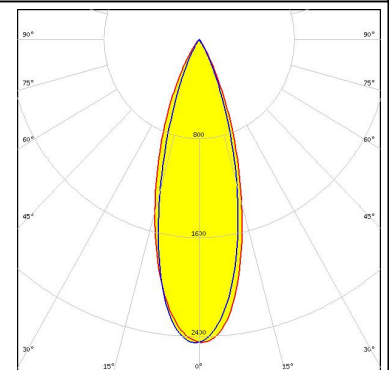
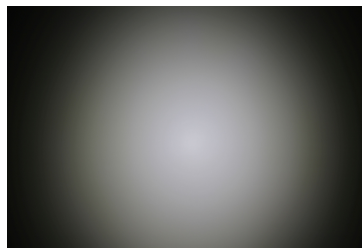

**LED** LUXEON 3030 2D (Round LES)  
**FWHM** 29.0°  
**Efficiency** 79 %  
**Peak intensity** 2.8 cd/lm  
**LEDs/each optic** 1  
**Light colour** White  
**Required components:**

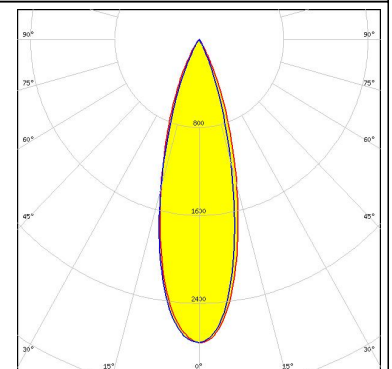
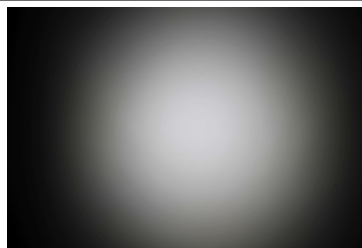

**LED** LUXEON 5050 Round LES  
**FWHM** 37.0°  
**Efficiency** 78 %  
**Peak intensity** 1.9 cd/lm  
**LEDs/each optic** 1  
**Light colour** White  
**Required components:**  
 C15427\_FLORENTINA-1-SHD-60

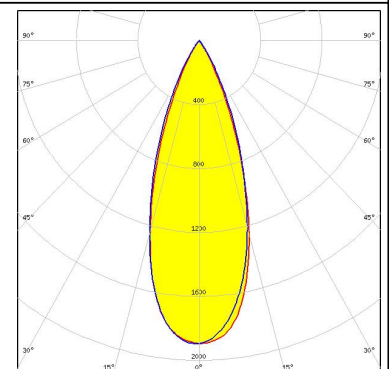
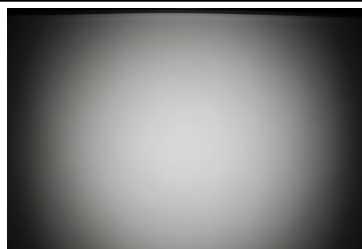

#### PHOTOMETRIC DATA (MEASURED):



LED LUXEON M/MX  
 FWHM 42.0°  
 Efficiency 75 %  
 Peak intensity 1.4 cd/lm  
 LEDs/each optic 1  
 Light colour White  
 Required components:  
 C15427\_FLORENTINA-1-SHD-60

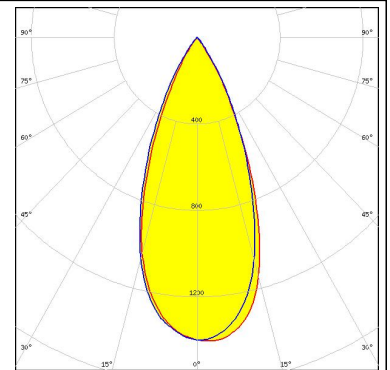
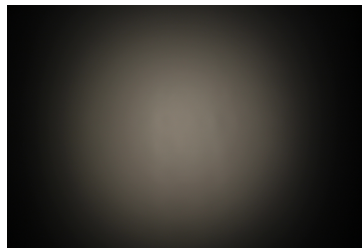

LED NF2x757G  
 FWHM 31.0°  
 Efficiency 80 %  
 Peak intensity 2.6 cd/lm  
 LEDs/each optic 1  
 Light colour White  
 Required components:  
 C16701\_FLORENTINA-1-SHD-60-WHT

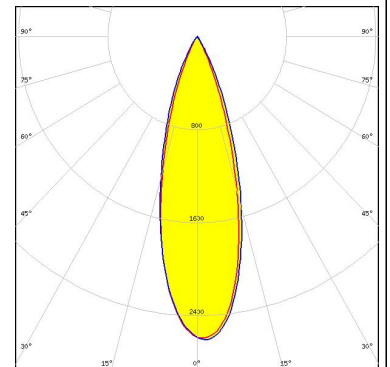

LED NF2x757G  
 FWHM 30.0°  
 Efficiency 81 %  
 Peak intensity 2.7 cd/lm  
 LEDs/each optic 1  
 Light colour White  
 Required components:  
 C15427\_FLORENTINA-1-SHD-60

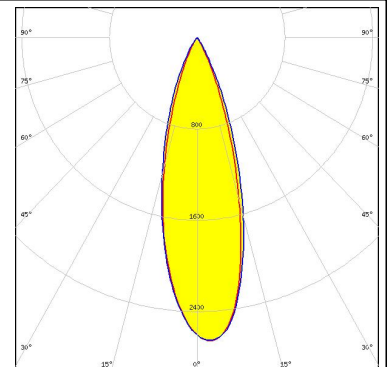
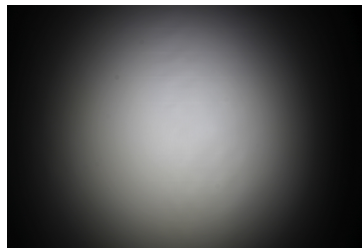

LED NFMW48xA  
 FWHM 37.0°  
 Efficiency 75 %  
 Peak intensity 1.8 cd/lm  
 LEDs/each optic 1  
 Light colour White  
 Required components:  
 C15427\_FLORENTINA-1-SHD-60

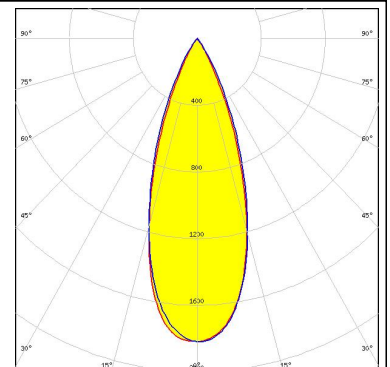
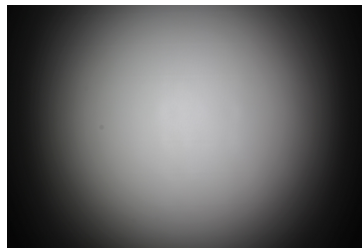

#### PHOTOMETRIC DATA (MEASURED):



**LED** NVSW319B  
**FWHM** 21.0°  
**Efficiency** 75 %  
**Peak intensity** 4.5 cd/lm  
**LEDs/each optic** 1  
**Light colour** White  
**Required components:**  
 C15427\_FLORENTINA-1-SHD-60

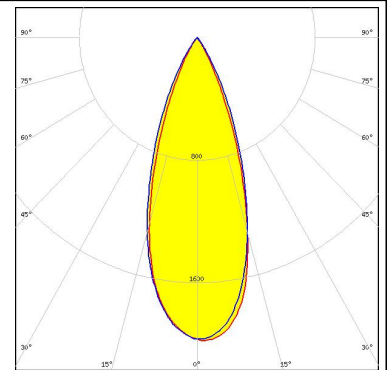

**LED** Duris S10  
**FWHM** 38.0°  
**Efficiency** 70 %  
**Peak intensity** 1.6 cd/lm  
**LEDs/each optic** 1  
**Light colour** White  
**Required components:**  
 C15427\_FLORENTINA-1-SHD-60

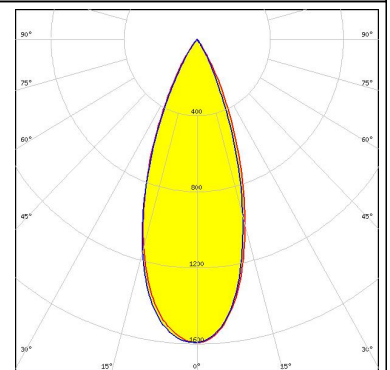
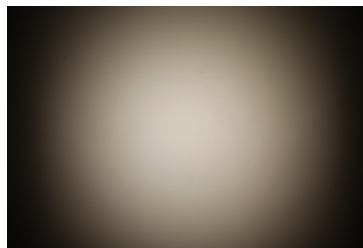

**LED** Duris S8  
**FWHM** 38.0°  
**Efficiency** 75 %  
**Peak intensity** 1.8 cd/lm  
**LEDs/each optic** 1  
**Light colour** White  
**Required components:**  
 C15427\_FLORENTINA-1-SHD-60

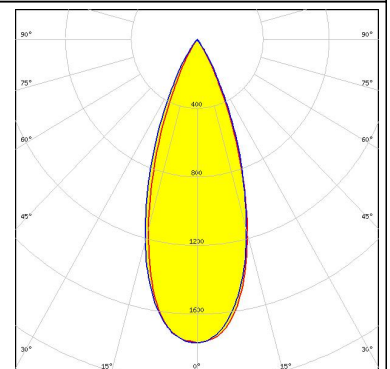
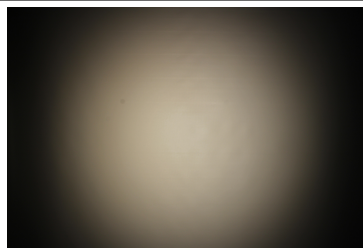

**LED** OSCONIQ P 7070  
**FWHM** 40.0°  
**Efficiency** 74 %  
**Peak intensity** 1.6 cd/lm  
**LEDs/each optic** 1  
**Light colour** White  
**Required components:**  
 C15427\_FLORENTINA-1-SHD-60

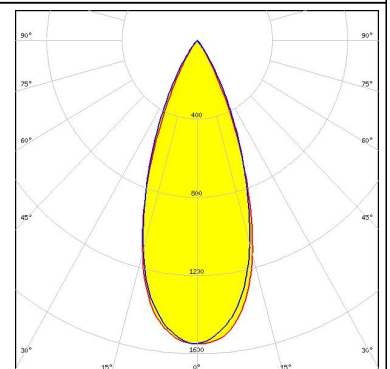
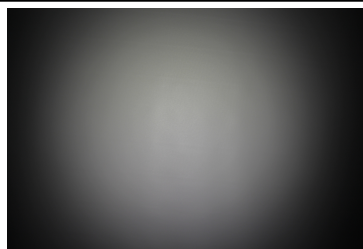

#### PHOTOMETRIC DATA (MEASURED):

**OSRAM**  
Opto Semiconductors

LED OSLON SSL 150  
FWHM 27.0°  
Efficiency 76 %  
Peak intensity 2.7 cd/lm  
LEDs/each optic 1  
Light colour White  
Required components:  
C15427\_FLORENTINA-1-SHD-60

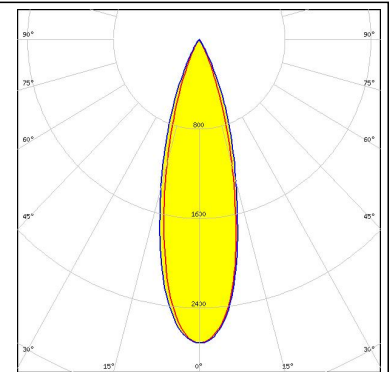
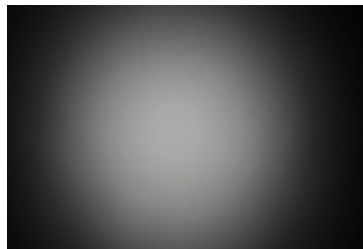

**SAMSUNG**

LED LM561B  
FWHM 31.0°  
Efficiency 80 %  
Peak intensity 2.6 cd/lm  
LEDs/each optic 1  
Light colour White  
Required components:  
C15427\_FLORENTINA-1-SHD-60

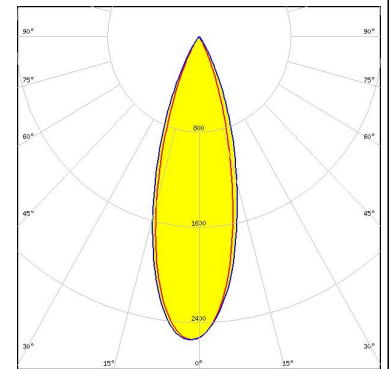
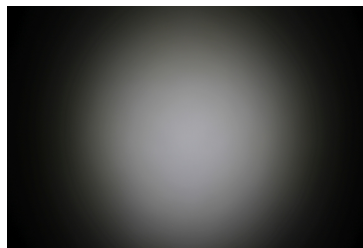

**SEOUL**

SEOUL SEMICONDUCTOR

LED SEOUL 5630  
FWHM 30.0°  
Efficiency 83 %  
Peak intensity 2.8 cd/lm  
LEDs/each optic 1  
Light colour White  
Required components:  
C15427\_FLORENTINA-1-SHD-60

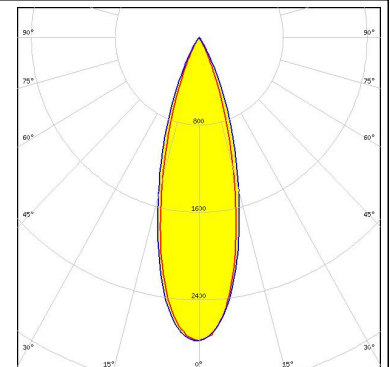
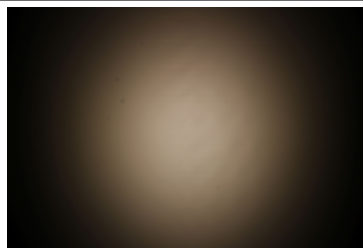

#### GENERAL INFORMATION:

NOTE: The typical beam angle will be changed by different color, chip size and chip position tolerance. The typical total beam angle is the full angle measured where the luminous intensity is half of the peak value.

#### MATERIALS:

As part of our continuous research and improvement processes, and to ensure the best possible quality and availability of our products, LEDiL reserves the right to change material grades without notice.

#### PRODUCT DATA USER AGREEMENT AND DISCLAIMER:

The measured data in the provided downloadable LEDiL Product Datasheets and Mechanical 2D-Drawings is rounded and provided as reference for planning. LEDiL Oy's optical specifications have been verified by conducting performance testing of the products in accordance with the company's quality system. The reported data are averaged results of multiple measurements with typical variation. LEDiL Oy reserves the right to without prior notification make changes and improvements to its products.

LEDiL Oy assumes neither warranty, nor guarantee nor any other liability of any kind for the contents and correctness of the provided data. The provided data has been generated with highest diligence but the provided data may in reality not represent the complete possible variation range of all intrinsic parameters. Therefore, in certain cases a deviation from the provided data could occur.

LEDiL Oy reserves the right to undertake technical changes of its products without further notification which could lead to changes in the provided data. LEDiL Oy assumes no liability of any kind for the possible deviation from any provided data or any other damage resulting from the usage of the provided data.

The user agrees to this disclaimer and user agreement with the download or usage of the provided files.

#### LEDiL Oy

Joensuunkatu 13  
FI-24240 SALO  
Finland

#### LEDiL Inc.

228 West Page Street  
Suite D  
Sycamore IL 60178  
USA

#### Local sales and technical support

[www.ledil.com/  
where\\_to\\_buy](http://www.ledil.com/where_to_buy)

#### Shipping locations

Salo, Finland  
Hong Kong, China

#### Distribution Partners

[www.ledil.com/  
where\\_to\\_buy](http://www.ledil.com/where_to_buy)

## Данный компонент на территории Российской Федерации

### Вы можете приобрести в компании MosChip.

Для оперативного оформления запроса Вам необходимо перейти по данной ссылке:

<http://moschip.ru/get-element>

Вы можете разместить у нас заказ для любого Вашего проекта, будь то серийное производство или разработка единичного прибора.

В нашем ассортименте представлены ведущие мировые производители активных и пассивных электронных компонентов.

Нашей специализацией является поставка электронной компонентной базы двойного назначения, продукции таких производителей как XILINX, Intel (ex.ALTERA), Vicor, Microchip, Texas Instruments, Analog Devices, Mini-Circuits, Amphenol, Glenair.

Сотрудничество с глобальными дистрибьюторами электронных компонентов, предоставляет возможность заказывать и получать с международных складов практически любой перечень компонентов в оптимальные для Вас сроки.

На всех этапах разработки и производства наши партнеры могут получить квалифицированную поддержку опытных инженеров.

Система менеджмента качества компании отвечает требованиям в соответствии с ГОСТ Р ИСО 9001, ГОСТ РВ 0015-002 и ЭС РД 009

### Офис по работе с юридическими лицами:

105318, г.Москва, ул.Щербаковская д.3, офис 1107, 1118, ДЦ «Щербаковский»

Телефон: +7 495 668-12-70 (многоканальный)

Факс: +7 495 668-12-70 (доб.304)

E-mail: [info@moschip.ru](mailto:info@moschip.ru)

Skype отдела продаж:

moschip.ru

moschip.ru\_4

moschip.ru\_6

moschip.ru\_9